

MQL/MQH 4 ÷ 17



English

Français



4.5
↓
16.5 kW



4.6
↓
18.4 kW



Air cooled water chillers and air-to-water reverse cycle heat pumps
Refroidisseurs de liquide à condensation par air et pompes à chaleur réversibles air-eau

IOM MQLH-N.1GBF

Date : **November / Novembre 2005**

Supersedes / Annule et remplace : **None**



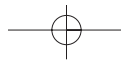
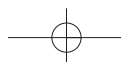
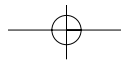

Table of contents

Table of contents

1 FOREWORD		6 MINICHILLER CONTROL	
1.1 Introduction	2	6.1 Operating instructions	18
1.2 Warranty	2	6.2 Failure Diagnostics	19
1.3 Emergency stop/Normal stop	2	7 GENERAL DESCRIPTION	
1.4 An introduction to this manual	2	7.1 Introduction	20
2 SAFETY		7.2 General specifications	20
2.1 Foreword	3	7.3 Compressors	21
2.2 Definitions	3	7.4 Coolant Circuit	21
2.3 Access to the unit	4	7.5 Water-exchanger	21
2.4 General precautions	4	7.6 Air exchanger	21
2.5 Precautions against residual risks	4	7.7 Fans	21
2.6 Precautions during maintenance operations	5	8 TECHNICAL DATA	
2.7 Safety labels	6	8.1 Technical Data	24
2.8 Safety regulations	7	8.2 Unit Electrical Data	28
3 TRANSPORT, LIFTING AND POSITIONING		8.3 Overall dimensions	30
3.1 Inspection	10	8.4 Clearances	31
3.2 Unit Handling	10	9 MAINTENANCE	
3.3 Anchoring	10	9.1 General requirements	32
3.4 Storage	10	9.2 Planned maintenance	32
4 INSTALLATION		9.3 Refrigerant charge	33
4.1 Installation advices	11	9.4 Compressor	33
4.2 Water connections	13	9.5 Condenser	33
4.3 Pressure Drop in Tubes and Accessories	14	9.6 Fans	33
4.4 Hydraulic connection	14	9.7 Dehydrating filter	33
4.5 Principle diagram of water circuit		9.8 Thermostatic expansion valve (only MQL-MQH 4-8)	34
4.6 Draining the defrosting waste water (for heat pump unit only)	14	9.9 Evaporator	34
4.7 Power supply	15	10 TROUBLESHOOTING	35
4.8 Electrical connections	15	11 SPARE PARTS	
5 START-UP		11.1 Spare parts list	37
5.1 Preliminary check	16	11.2 Oil for compressors	37
5.2 Start-up	16	11.3 Wiring diagram	37
5.3 Checking the operation	17	12 DISMANTLING, DEMOLITION AND SCRAPPING	
5.4 Delivery to the customer	17	12.1 Generalities	38





Foreword

1 FOREWORD

1.1 Introduction

Itelco-Clima units, manufactured to state-of-the-art design and implementation standards, ensure top performance, reliability and fitness to any type of air-conditioning system.

These units are designed for cooling water or glycoled water* (and for water heating in heat pump models) and are unfit for any purposes other than those specified in this manual.

This manual includes all the information required for a proper installation of the units, as well as the relevant operating and maintenance instructions.

It is therefore recommended to read this manual carefully before installation or any operation on the machine. The chiller installation and maintenance must be carried out by skilled personnel only (where possible, by one of Itelco-Clima's Authorised Service Centers).

The manufacturer may not be held liable for any damage to people or property caused by improper installation, start-up and/or improper use of the unit and/or failure to implement the procedures and instructions included in this manual.

1.2 Warranty

These units are delivered complete, tested and ready for being operated. Any form of warranty will become null and void in the event that the appliance is modified without Itelco-Clima's preliminary written authorisation.

This warranty shall apply providing that the installation instructions have been complied with (either issued by Itelco-Clima, or deriving from the current practice).

In order for this warranty to be valid, the following conditions shall be met:

- Maintenance must be performed only by skilled personnel - from one of Itelco-Clima's Authorised After-Sales Centers.
- Use only original Itelco-Clima spare parts.
- Carry out all the planned maintenance provided for by this manual in a timely and proper way.

Failure to comply with any of these conditions will automatically void the warranty.

***Note:** minimum leaving water temperature from evaporator: + 5°C.

1.3 Emergency stop / Normal stop

The emergency stop of the unit can be enabled using the master switch on the control panel (move down the lever).

For a normal stop, press the relevant push-buttons.

To restart the appliance, follow the procedure detailed in this manual.

1.4 An introduction to the manual

For safety reasons, it is imperative to follow the instructions given in this manual. In case of any damage caused by non-compliance with these instructions, the warranty will immediately become null and void.

Conventions used throughout the manual:



The Danger sign recalls your attention to a certain procedure or practice which, if not followed, may result in serious damage to people and property.



The Warning sign precedes those procedures that, if not followed, may result in serious damage to the appliance.



The Notes contain important observations.



The Useful Tips provide valuable information that optimises the efficiency of the appliance.

This manual and its contents, as well as the documentation which accompanies the unit, are and remain the property of Itelco-Clima, which reserves any and all rights thereon. This manual may not be copied, in whole or in part, without Itelco-Clima's written authorization.

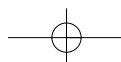

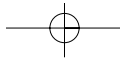

Safety

2 SAFETY

2.1 Foreword

These units must be installed in conformity with the provisions of Machinery Directive 98/37/EC, Low Voltage Directive 73/23/EC, Pressure Vessels Directive 97/23/EC, Electromagnetic Interference Directive 89/336/EC, as well as with other regulations applicable in the country of installation. If these provisions are not complied with, the unit must not be operated.



The unit must be grounded, and no installation and/or maintenance operations may be carried out before deenergising the electrical panel of the unit.

Failure to respect the safety measures mentioned above may result in electrocution hazard and fire in the presence of any short-circuits.



Inside the heat exchangers, the compressors and the refrigeration lines, this unit contains liquid and gaseous refrigerant under pressure. The release of this refrigerant may be dangerous and cause injuries.



The units are not designed to be operated with natural refrigerants, such as hydrocarbons. Itelco-Clima may not be held liable for any problems deriving from the replacement of original refrigerant or the introduction of hydrocarbons.

Itelco-Clima units are designed and manufactured according to the requirements of European Standard PED 97/23/EC (pressure vessels).

- The used refrigerants are included in group II (non-hazardous fluids).
- The maximum working pressure values are mentioned on the unit's data plate.
- Suitable safety devices (pressure switches and safety valves) have been provided, to prevent any anomalous overpressure inside the plant.
- The vents of the safety valves are positioned and oriented in such a way as to reduce the risk of contact with the operator, in the event that the valve is operated. Anyway, the installer will convey the discharge of the valves far from the unit.
- Dedicated guards (removable panels with tools) avoid contacts with potential dangerous zones.



The guards of the fans must be always mounted and must never be removed before de-energising the appliance.



It is the User's responsibility to ensure that the unit is fit for the conditions of intended use and that both installation and maintenance are carried out by experienced personnel, capable of respecting all the recommendations provided by this manual. It is important that the unit is adequately supported, as detailed in this manual. Non-compliance with these recommendations may create hazardous situations for the personnel.



The unit must rest on a base which meets the characteristics specified in this manual; a base with inadequate characteristics is likely to become a source of serious injury to the personnel.



The unit has not been design to withstand loads and/or stress that may be transmitted by adjacent units, piping and/or structures. Each external load or stress transmitted to the unit may break or cause breakdowns in the unit's structure, as well as serious dangers to people. In these cases, any form of warranty will automatically become null and void.



The packaging material must not be disposed of in the surrounding environment or burnt.

2.2 Definitions

OWNER: means the legal representative of the company, body or individual who owns the plant where Itelco-Clima unit has been installed; he/she has the responsibility of making sure that all the safety regulations specified in this manual are complied with, along with the national laws in force.

INSTALLER: means the legal representative of the company who has been given by the owner the job of positioning and performing the hydraulic, electric and other connections of Itelco-Clima unit to the plant: he/she is responsible for handling and properly installing the appliance, as specified in this manual and according to the national regulations in force.

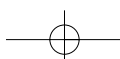

Safety

OPERATOR: means a person authorised by the owner to do on Itelco-Clima unit all the regulation and control operations expressly described in this manual, that must be strictly complied with, without exceeding the scope of the tasks entrusted to him.

ENGINEER: means a person authorised directly by Itelco-Clima or, in all EC countries, excluding Italy, under his full responsibility, by the distributor of Itelco-Clima product, to perform any routine and extraordinary maintenance operations, as well as any regulation, control, servicing operations and the replacement of pieces, as may be necessary during the life of the unit.

2.3 Access to the unit

The unit must be placed in an area which can be accessed also by OPERATORS and ENGINEERS; otherwise the unit must be surrounded by a fence at not less than 2 meters from the external surface of the machine.

OPERATORS and ENGINEERS must enter the fenced area only after wearing suitable clothing (safety shoes, gloves, helmet etc.). The INSTALLER personnel or any other visitor must always be accompanied by an OPERATOR.

For no reason shall any unauthorised personnel be left alone in contact with the unit.

2.4 General precautions

The OPERATOR must simply use the controls of the unit; he must not open any panel, other than the one providing access to the control module.

The INSTALLER must simply work on the connections between plant and machine; he must not open any panels of the machine and he must not enable any control.

When you approach or work on the unit, follow the precautions listed below:

- do not wear loose clothing or jewellery or any other accessory that may be caught in moving parts
- wear suitable personal protective equipment (gloves, goggles etc.) when you have to work in the presence of free flames (welding operations) or with compressed air
- if the unit is placed in a closed room, wear ear protection devices
- cut off connecting pipes, drain them in order to balance the pressure to the atmospheric value before disconnecting them, disassemble connections, filters, joints or other line items
- do not use your hands to check for any pressure drops

- use tools in a good state of repair; be sure to have understood the instructions before using them
- be sure to have removed all tools, electrical cables and any other objects before closing and starting the unit again

2.5 Precautions against residual risks

Prevention of residual risks caused by the control system

- be sure to have perfectly understood the operating instructions before carrying out any operation on the control panel
- when you have to work on the control panel, keep always the operating instructions within reach
- start the unit only after you have checked its perfect connection to the plant
- promptly inform the ENGINEER about any alarm involving the unit
- do not reset manual restoration alarms unless you have identified and removed their cause

Prevention of residual mechanical risks

- install the unit according to the instructions provided in this manual
- carry out all the periodical maintenance operations prescribed by this manual
- before opening any panelling of the machine, make sure that it is secured to it by hinges
- do not touch air condensation coils without wearing protective gloves
- do not remove the guards from moving elements while the unit is running
- check the correct position of the moving elements' guards before restarting the unit

Prevention of residual electrical risks

- connect the unit to the mains according to the instructions provided in this manual
- periodically carry out all the maintenance operations specified by this manual
- disconnect the unit from the mains by the external disconnecting switch before opening the electrical board
- check the proper grounding of the unit before start-up
- check all the electrical connections, the connecting cables, and in particular the insulation; replace worn or damaged cables

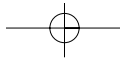

Safety

- periodically check the board's internal wiring
- do not use cables having an inadequate section or flying connections, even for limited periods of time or in an emergency

Prevention of other residual risks

- make sure that the connections to the unit conform to the instructions provided in this manual and on the unit's panelling
- if you have to disassemble a piece, make sure that it has been properly mounted again before restarting the unit
- do not touch the delivery pipes from the compressor, the compressor and any other piping or component inside the machine before wearing protective gloves
- keep a fire extinguisher for electrical appliances near the machine
- on the units installed indoor, connect the safety valve of the refrigeration circuit to a piping network that can channel any overflowing refrigerant outside
- remove and leak of fluid inside and outside the unit
- collect the waste liquids and dry any oil spillage
- periodically clean the compressor compartment, to remove any fouling
- do not store flammable liquids near the unit
- do not disperse the refrigerant and the lubricating oil into the environment
- weld only empty pipes; do not approach flames or other sources of heat to refrigerant pipes
- do not bend/hit pipes containing fluids under pressure

2.6 Precautions during maintenance operations

Maintenance operations can be carried out by authorised technicians only.
Before performing any maintenance operations:

- disconnect the unit from the mains with the external disconnecting switch
- place a warning sign "do not turn on - maintenance in progress" on the external disconnecting switch
- make sure that on-off remote controls are inhibited
- wear suitable personal protective equipment (helmet, safety gloves, goggles and shoes etc.)

To carry out any measurements or checks which require the activation of the machine:

- work with the electrical board open only for the necessary time
- close the electrical board as soon as the measurement or check has been completed
- for outdoor units, do not carry out any operations in the presence of dangerous climatic conditions (rain, snow, mist etc.)

The following precautions must be always adopted:

- do not scatter the fluids of the refrigeration circuit in the surrounding environment
- when replacing an eprom or electronic cards, use always suitable devices (extractor, antistatic bracelet, etc.)
- to replace a compressor, the evaporator, the condensing coils or any other weighty element, make sure that the lifting equipment is consistent with the weight to be lifted
- in air units with independent compressor compartment, do not access the fan compartment unless you have disconnected the machine by the disconnecting switch on the board and you have placed a warning sign "do not turn on - maintenance in progress"
- contact Itelco-Clima for any modifications to the refrigeration, hydraulic or wiring diagram of the unit, as well as to its control logics
- contact Itelco-Clima if it is necessary to perform very difficult disassembly and assembly operations
- use only original spare parts purchased directly from Itelco-Clima or the official retailers of the companies on the recommended spare parts list
- contact Itelco-Clima if it is necessary to handle the unit one year after its positioning on site or if you wish to dismantle it.

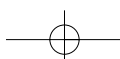
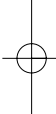
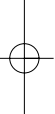

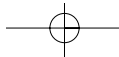

Safety

2.7 Safety labels

The labels below will be affixed to each unit in the indicated point:

COD.PRODOTTO NEUTRO
 PRODUCT CODE

MODELLO
 MODEL

OdL

MATRICOLA
 SERIAL NUMBER

ANNO DI COSTRUZIONE

CARICA REFR. CIRCUITO 1 2 3 4
 REFRIGERANT CHARGE Kg

ALTA PRESSIONE (max) bar
 HIGH PRESSURE

BASSA PRESSIONE (max) bar
 LOW PRESSURE

ALIM. POTENZA V/PH/Hz
 MAIN SUPPLY

CORRENTE DI SPUNTO (max) A
 LRA

CORRENTE A PIENO CARICO (max) A

POTENZA ASSORBITA (max) Kw
 POWER INPUT

PRESS. ESERC.ACQUA (max) bar
 WATER OPERATION PRESSURE

MASSA (max) Kg
 MASS

ITELCO CLIMA S.r.l Via XXV Aprile 29 20030 BARLASSINA MI(ITALIA)
 MADE IN ITALY

**Identification of the unit -
 Outside, on the right-hand front column**

EIN - INLET
ENTRÉE - ENTRATA
AUS - OUTLET
SORTIE - USCITA
**Fitting identification -
 Adjacent to fittings**



**Grounding connection - On the electrical
 board, adjacent to the connection**

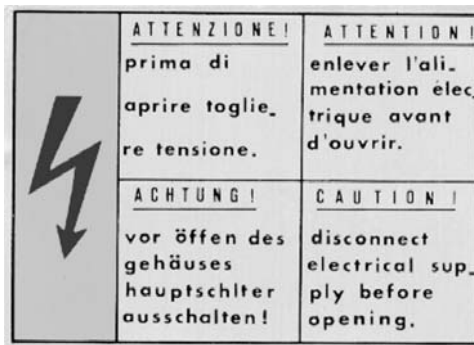

**Electrical warning
 Adjacent to the master switch**

CERTIFICATO DI COLLAUDO PRODUZIONE ITELCO-CLIMA
 ITELCO-CLIMA PRODUCTION TEST CERTIFICATE
 UNITA' ARIA-ARIA/ARIA-ACQUA - SEMICENTRALI- CHILLER AIR/AIR AIR/WATER

PROGR. COLL. NUMBER CHECK	DESCRIZIONE DEI TEST DESCRIPTION OF QUALITY CHECK	TIMERO OPERAT. INSP. CODE
01	VERIFICA ASSEMBLAGGIO VERIFY ASSEMBLY COMPLETE	
02	VERIFICA VISIVA CABLAGGIO COLLEG. ELETTRICI E CONNESSIONE VERIFY WIRING CONNECTIONS	
03	VUOTO E CARICA REF. VACUUM AND CHARGE TEST	
04	VERIFICA CON CERCAFUGHE TENUTA CIRCUITO FRIGORIFERO REFRIGERANT LEAK TEST	
05	PROVE FUNZIONALI CON RILIEVI TEMPERATURE/PRESSIONI-RUMORE FUNCTION AND RUN TEST NOISE TEST	
06	VERIFICA INTERVENTI SICUREZZE PRESSIONE E TEMPERATURA CHECK OPERATION AND SAFETY DEVICES	
07	VERIFICA TENUTA CIRCUITO IDR. E FUNZIONAMENTO POMPA (SU PACK) HYDRAULIC CIRCUIT TEST (PUMP CHECK ONLY FOR PACK UNIT)	
08	VERIFICA MONTAGGIO ACCESSORI (SE PREVISTI) E DOCUMENTAZIONE CHECK ACCESSORIES/DOCUMENTATION	
09	CONTROLLO ESTETICO FINALE E PULIZIA INTERNA VISUAL CHECK FOR DIRT AND DAMAGE	

**Final Test Certificate -
 Inside the external door**

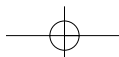

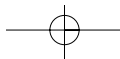

Safety

2.8 Safety regulations

Refrigerant data	Safety data: R407C
Toxicity	Low
Contact with skin	If sprayed, the refrigerant is likely to cause frost burns. If absorbed by the skin, the danger is very limited; it may cause a slight irritation, and the liquid is degreasing. Unfreeze the affected skin with water. Remove the contaminated clothes with great care - in the presence of frost burns, the clothes may stick to the skin. Wash with plenty of warm water the affected skin. In the presence of symptoms such as irritation or blisters, obtain medical attention.
Contact with eyes	Vapours do not cause harmful effects. The spraying of refrigerant may cause frost burns. Wash immediately with a proper solution or with tap water for at least 10 minutes, and then obtain medical attention.
Ingestion	Very unlikely - should something happen, it will cause frost burns. Do not induce vomiting. Only if the patient is conscious, wash out mouth with water and give some 250 ml of water to drink. Then, obtain medical attention.
Inhalation	R407C: remarkable concentrations in the air may have an anaesthetic effect, up to fainting. The exposure to considerable amounts may cause irregular heartbeat, up to the sudden death of the patient. Very high concentrations may result in the risk of asphyxia, due to the reduction in the oxygen percentage in the atmosphere. Remove the patient to fresh air and keep warm and at rest. If necessary, give oxygen. In case of breathing difficulties or arrest, proceed with artificial respiration. In case of cardiac arrest, proceed with cardiac massage. Then, obtain medical attention.
Recommendations	Semiotics or support therapy is recommended. Cardiac sensitisation has been observed that, in the presence of circulating catecholamines such as adrenalin, may cause cardiac arrhythmia and accordingly, in case of exposure to high concentrations, cardiac arrest.
Prolonged exposure	R407C: a study on the effects of exposure to 50,000 ppm during the whole life of rats has identified the development of benign testicle tumour. This situation should therefore be negligible for personnel exposed to concentrations equal to or lower than professional levels.
Professional levels	R407C: Recommended threshold: 1000 ppm v/v - 8 hours TWA.
Stability	R407C: Not specified
Conditions to avoid	Do not use in the presence of flames, burning surfaces and excess humidity.
Hazardous reactions	May react with sodium, potassium, barium and other alkaline metals. Incompatible substances: magnesium and alloys with magnesium concentrations > 2%.
Hazardous decomposition products	R407C: Halogen acids produced by thermal decomposition and hydrolysis.

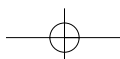

Safety

General precautions	Do not inhale concentrated vapours. Their concentration in the atmosphere should not exceed the minimum preset values and should be maintained below the professional threshold. Being more weighty than the air, the vapour concentrates on the bottom, in narrow areas. Therefore, the exhaust system must work at low level.
Respiratory system protection	If you are in doubt about the concentration in the atmosphere, it is recommended to wear a respirator approved by an accident-prevention Authority, of the independent or oxygen type.
Storage	Cylinders must be stored in a dry and fresh place, free from any fire hazard, far from direct sunlight or other sources of heat, radiators etc. Keep a temperature below 45°C.
Protective clothing	Wear overalls, protective gloves and goggles or a mask.
Accidental release measures	It is important to wear protective clothing and a respirator. Stop the source of the leak, if you can do this without danger. Negligible leaks can be left evaporating under the sun, providing that the room is well ventilated. Considerable leaks: ventilate the room. Reduce the leak with sand, earth or other absorbing substances. Make sure that the liquid does is not channelled into gutters, sewers or pits where the vapours are likely to create a stuffy atmosphere.
Disposal	The best method is recovery and recycling. If this method is not practicable, dispose according to an approved procedure, that shall ensure the absorption and neutralization of acids and toxic agents.
Fire fighting information	R407C: Not flammable in the atmosphere.
Cylinders	The cylinders, if exposed to fire, shall be cooled by water jets; otherwise, if heated, they may explode.
Protective fire fighting equipment	In case of fire, wear an independent respirator and protective clothing.

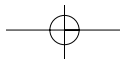

Safety

Refrigerant oil data	Safety data: Polyolester oil (POE)
Classification	Not harmful
Contact with skin	May cause slight irritation. Does not require first aid measures. It is recommended to follow usual personal hygiene measures, including washing the exposed skin with soap and water several times a day. It is also recommended to wash your overalls at least once a week.
Contact with eyes	Wash thoroughly with a suitable solution or tap water.
Ingestion	Seek medical advice immediately.
Inhalation	Seek medical advice immediately.
Conditions to avoid	Strong oxidising substances, caustic or acid solutions, excess heat. May corrode some types of paint or rubber.
Protection of the respiratory system	Use in well ventilated rooms.
Protective clothing	Always wear protective goggles or a mask. Wearing protective gloves is not mandatory, but is recommended in case of prolonged exposure to refrigerant oil.
Accidental release measures	It is important to wear protective clothing and, especially, goggles. Stop the source of the leak. Reduce the leak with absorbing substances (sand, sawdust or any other absorbing material available on the market).
Disposal	The refrigerant oil and its waste will be disposed of in an approved incinerator, in conformity with the provisions and the local regulations applicable to oil waste.
Fire fighting information	In the presence of hot liquid or flames, use dry powder, carbon dioxide or foam. If the leak is not burning, use a water jet to remove any vapours and to protect the personnel responsible for stopping the leak.
Cylinders	The cylinders exposed to a fire will be cooled with water jets in case of fire.
Fire fighting protective equipment	In case of fire, wear an independent respirator.

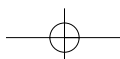

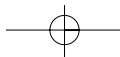

Transport, Lifting and Positioning

3 TRANSPORT, LIFTING AND POSITIONING

Refrigerators are supplied assembled. The equipment are full of refrigerant and oil (except to the condensing unit), in the quantity required for a proper operation.

3.1 Inspection

When the unit is delivered, it is recommended to check it carefully and to identify any damage occurred during transportation. The goods are shipped ex-factory, at the buyer's risk. Check that the delivery includes all the components listed in the order.

In case of damage, note it down on the carrier's delivery note and issue a claim according to the instructions provided in the delivery note.

In the presence of any serious damage, that does not affect the surface only, it is recommended to inform Itelco-Clima immediately.

Please note that Itelco-Clima may not be held liable for any damage to the equipment during transportation, even though the carrier has been appointed by the factory.

3.2 Unit Handling



Sharp edges and coil surfaces are a potential hazard. Avoid contact with them.

Be careful to avoid rough handling of the unit. Do not push or pull the unit anything other than the base. Block the pushing vehicle away from the unit to prevent damage to the sheet metal cabinet and end frame (see picture 1).

Blocking required across
(full width)

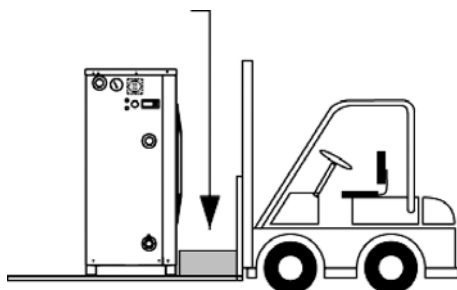

Picture 1

3.3 Anchoring

It is not essential to secure the unit to the foundations, unless in areas where there is a serious risk of earthquake, or if the appliance is installed on the top of a steel frame.

3.4 Storage

When the unit is to be stored before installation, adopt a few precautions to prevent any damage or risk of corrosion or wear:

- plug or seal every single opening, such as water fittings
- do not store the appliance in a room where the temperature exceeds 50°C for the units using R407C and, if possible, do not expose to direct sunlight
- it is recommended to store the unit in a roof where traffic is minimized, to prevent the risk of accidental damage
- the unit must not be washed with a steam jet
- take away and leave to the site manager all the keys providing access to the control board

Finally, it is recommended to carry out visual inspections at regular intervals.

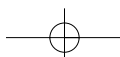

Installation

4 INSTALLATION

4.1 Installation advices

Unit placement

The MQL/MQH water chillers are cooled by air. Thereby, they must be installed in the open air, in an area where the flow of air to and from the condenser coil must not be limited. A space restriction, which reduces the air flow, will decrease the cooling capacity, increase the power input and, in some cases, prevent the unit from operating because of an excess of condensation pressure.

The MQL/MQH water chillers are equipped with propeller type condenser fan. Therefore, they will not operate with ductwork on the fan outlet.

In case of installation in an area subject to be hit by strong wind, direct effect of the wind on the discharge surface of the fan should be avoided.

Care should be taken, at the time of installation, to leave enough clearances around the unit for maintenance works.

The minimum clearances are shown on picture 2 and must be considered, both to ensure that the unit operates correctly and to allow easy access.

The units should be installed on a flat and hard, preferably concrete base.

When fixing the unit, a slope of 1 cm/m is recommended to allow draining of rain water.



Units MQL/MQH 4 and 6 cannot be installed with advanced inclination to 10°.

For reverse cycle models, if the outdoor temperature is likely to fall below +1 °C, provide a system to prevent the condensates from freezing (e.g. heating cord).

For installation in difficult climates, temperatures below 0 °C, snow or humidity, it is recommended to elevate the unit about 20 cm above the floor.



The plastic grille is used to protect the operators from injury risks on heat exchanger at the time of handling and installation.

However, risks of clogging by freeze or hoar frost can be occurred on reverse cycle units installed in cold or mountainous regions and exposed to the elements.

To prevent all risks, a shelter is to be provided or simply remove the protective grille.

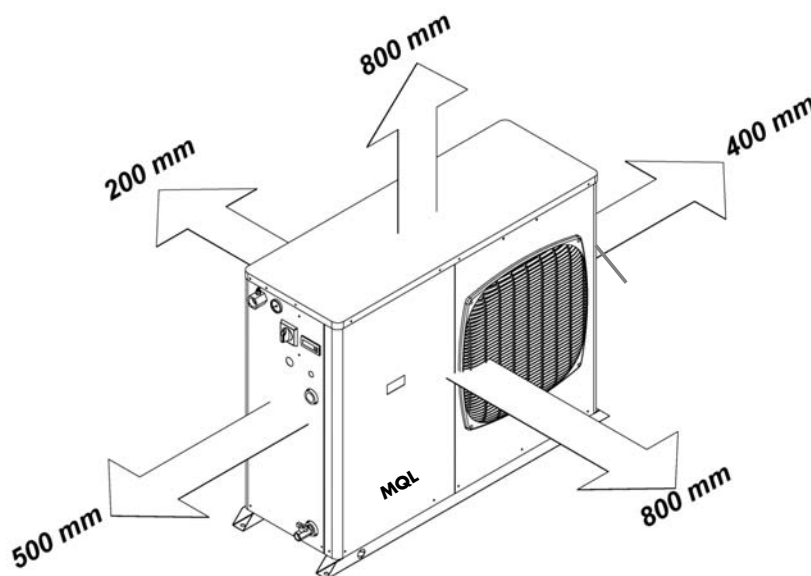

Picture 2

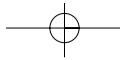

Installation

Fixing dimensions

The fixing dimensions of the unit are shown on the figure opposite. Vibration isolators are recommended for all roof mounted installation or wherever vibration transmission is a consideration. Picture 3 shows the location of each isolator.

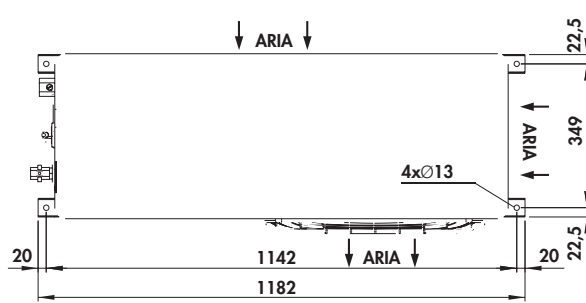

Picture 3



Photo 2

Maintenance access

After installation, each side of the unit must allow easy access for periodic maintenance works. The removal of panel 1 allows access to compressor, refrigerant circuit as well as hydronic module. The fan-motor assembly is accessible after removing the panel 2.

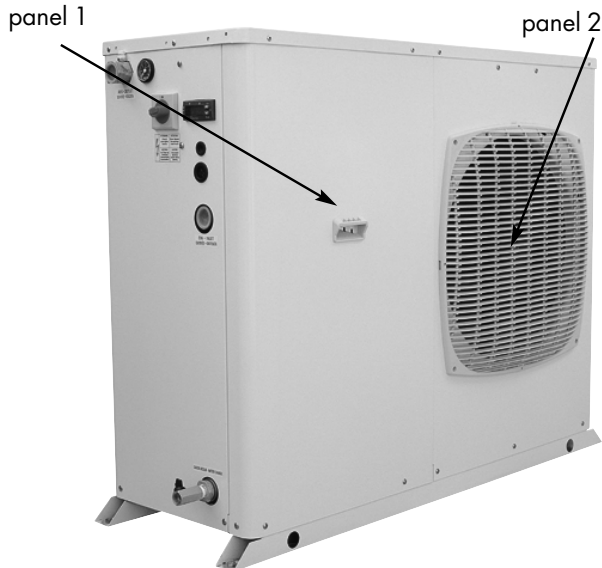
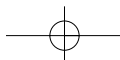

Photo 1



Photo 3

Remark: The panel 1 is removable independently of other panels and allows a start-up by maintaining the operating characteristics of the unit.



Installation

4.2 Water connections

Water Piping

Local authorities can supply the installer with the proper building and safety codes required for safe and proper installation.



Install piping with minimum bends and changes in elevation to minimize pressure drop.

Consider the following when installing water piping:

1. Vibration eliminators to reduce vibration and noise transmission to the building. Check the free volume expansion of the connection piping.
2. Shut-off valves to isolate the unit from the piping system during unit servicing.
3. Manual or automatic air vent valves at the highest points of the chilled water piping.
4. A means of maintaining adequate system water pressure (expansion tank or regulating valve).
5. Temperature and pressure indicators located at the unit to aid in unit servicing.

6. To avoid all risks of penetration of foreign matters and to keep system performance up, it is mandatory to install a strainer at the inlet of the unit.

Protection from freezing

It is recommended to protect the water system from freezing whatever the model used (cooling only or reverse cycle). The table below shows the anti-freeze concentration to be used depending on the minimum outdoor temperature.

Minimum outdoor temp. °C	0	-5	-10	-15	-25	-30
Concentration in %	10	20	30	40	50	60

Safety Differential Pressure Switch

A safety differential pressure switch (ref. 6) is factory mounted on water inlet piping of evaporator, in order to ensure adequate water flow to evaporator before starting up the unit.

It comes into operation in case of drop in water flow owing to the fact that the pump failed to operate.

The safety differential pressure switch is the main protective device of the machine.



It is not our policy to make recommendations on water treatment. The general contractor or owner should contact a local water treatment company regarding water treatment. However, this topic is critical and care should be taken to make sure it is done properly to prevent problems related to flow. A fouled water system will lead to premature component failure.



Water connections could be damaged by an important stress when screwing them. Use a second spanner to compensate the stress of tightening.

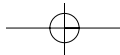

Installation

4.3 Pressure Drop in Tubes and Accessories

To determine the appropriated pipe section, see table n° 1 which shows the values of pressure drop for various water flows and the diameter of standard copper pipes for hydraulic installations.

Table n° 1

Flow (l/h)	Pressure drop (mm WG / m)				
	Velocity (m/s)				
	Nominal diameter				
	13 x 15	16 x 18	20 x 22	26 x 28	33 x 35
400	86 0,84	32 0,55			
600	172 1,25	65 0,83	22 0,53		
800	286 1,67	108 1,11	37 0,71	10 0,42	
1000		158 1,38	55 0,88	16 0,52	5 0,32
1200		216 1,65	75 1,06	22 0,63	7 0,39
1400		284 1,93	99 1,24	28 0,73	9 0,45
1600			124 1,41	36 0,84	12 0,52
1800			133 1,59	44 0,94	14 0,58
2000			184 1,77	52 1,04	17 0,65
2200			217 1,94	62 1,15	20 0,71
2400			254 2,12	72 1,25	23 0,78

The grey area shows pressure drop in mm of water gauge/m and the velocity in m/s recommended for various flows and diameters.

Intermediate values are determined through interpolation.

Values outside the grey area correspond to excessive pressure drops and should be avoided.

Table n° 2 shows the equivalent length pipe with the same diameter, of a few common accessories for this type of installation.

Tabella n° 2

Accessories	Equivalent length (m)				
	Nominal diameter				
	13 x 15	16 x 18	20 x 22	26 x 28	33 x 35
Ball check valve	0,2	0,2	0,3	0,4	0,5
45° Bend	0,2	0,2	0,26	0,35	0,5
90° Bend	0,4	0,4	0,5	0,7	1,0
90° Curve	0,3	0,3	0,4	0,6	0,86
T-piece	0,8	0,8	1,0	0,5	2,0

1 mm WG = 9,81 Pa.

4.4 Hydraulic connection

The water inlet/outlet fittings shall conform to the instructions provided by the plates affixed neat the connection points.

4.5 Principle Diagram of Water Circuit

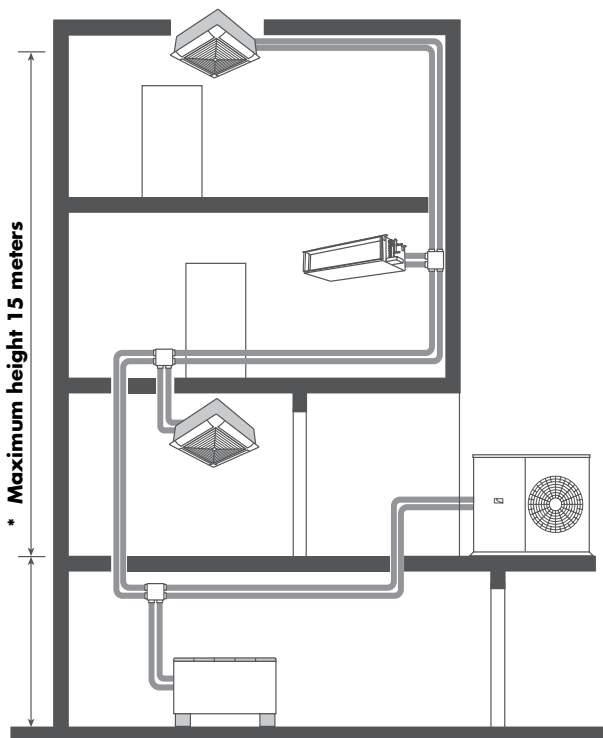

The MQL/MQH are to be connected with the terminal units such as fan coil units, cassettes or wall mounted units. Each terminal unit connected with the MQL/MQH water chiller and provided with its own control is therefore completely independent of the chiller (see diagram of principle on the left).

* If the terminal unit is on a lower level than the MQL/MQH water chiller, make sure the water pressure in the chiller is at least 0.5 bar.

4.6 Draining the defrosting waste water (for heat pump unit only)

When heat pump units work in heating mode, during defrosting cycles, they may discharge water from the base.

The heat pump units must be installed in positions where the defrosting water cannot create any damage.

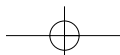

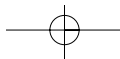

Installation

4.7 Power supply



Before carrying out any operations on the electrical system, make sure that the unit is deenergised.



It is important that the appliance is grounded.



The company in charge of the installation shall conform to the standards applicable to outdoor electrical connections.

Itelco-Clima may not be held liable for any damage and/or injury caused by failure to comply with these precautions.

The unit conforms to EN 60204-1.

The following connections shall be provided:

- A link for the power supply and the earth connection
- The electrical distribution system shall meet the power absorbed by the appliance.
- The disconnecting and magnetothermal switches must be sized to control the starting current of the unit.
- The power supply lines and the insulation devices must be designed in such a way that every line independent.
- It is recommended to install differential switches, to prevent any damage caused by phase drops.
- The fans and compressors are supplied through contactors controlled from the control panel.
- Each motor is provided with an internal safety thermal device and external fuses.
- The power supply cables must be inserted into dedicated openings on the front of the unit, and they will enter the electrical board through holes drilled on the bottom of the board.

4.8 Electrical connections

The unit must be installed on site according to the Machinery Directive (98/37/EC), the Low Voltage Directive (73/23/EC), the Electromagnetic Interference Directive (89/336/EC) and the usual procedures and standards applicable in the place of installation. The unit must not be operated if its installation has not been carried out according to the instructions provided in this manual.

The power supply lines must consist of insulated copper conductors, dimensioned for the maximum absorbed current.

Connection to terminals must be performed according to the diagram of connections provided in this manual and according to the wiring diagram which accompanies the unit.



Before connecting the power supply lines, check that the available voltage value does not exceed the range specified in the Electric Data (Chapter 8).

For 3-phase systems, check also that the unbalance between the phases does not exceed 2%. To perform this check, measure the differences between the voltage of each phase couple and their mean value during operation. The maximum % value of these differences (unbalance) must not exceed 2% of the mean voltage. If the unbalance is unacceptable, contact the Energy Distributor to solve this problem.



Supplying the unit through a line whose unbalance exceeds the permissible value will automatically void the warranty.



It's recommended to check the correct sequence of the three supply phases R-S-T- before the unit start up.

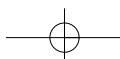

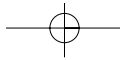

Start-up

5 START-UP



On MQL-MQH Chiller the first start up must be done by an authorized technician. Following suggestions should be applied in order to do the operation properly.

5.1 Preliminary check

The checks listed below shall be performed before starting the unit .

- Check the section of power supply and grounding cables; make sure that terminals are tightened and check the correct operation of contactors, with the master switch open.
- Check that any voltage and phase variation in the power supply does not exceed the prefixed thresholds.
- Check that the components of the external water circuit (user equipment, filters, power supply tank and reservoir, if any) have been installed properly, and according to the manufacturer's instructions.
- Check the filling of the hydraulic circuits, and make sure that the fluid circulation is correct, without any trace of leaks and air bubbles.
- Check that the direction of rotation of the pumps is correct, and that fluids have been circulating for at least 4 hours. Then, clean the filters on the suction side of the pumps.
- Adjust the liquid distribution network in such a way that the flow rate is within the specified range.
- Check that the water quality is up to the specifications.
- Check that oil heaters, if any, have been turned on at least 4 hours before (It is mandatory if the temperature is under 15°C).

5.2 Start-up

Start-up sequence:

- Turn on the main switch disconnecter (at least 4 hours before).
- Check that the oil in the compressor has reached the requested temperature (the minimum temperature outside the pan must be approx. 40°C) and that the auxiliary control circuit is energised.
- Check the operation of all the external equipment, and make sure that the control devices of the plant are properly calibrated.
- Start the pump and check that the water flow is correct.
- Set the desired fluid temperature on the control board.
- Start the appliance (see Chapter 6).
- Check the correct direction of rotation of compressors. Scroll compressors cannot compress the refrigerant when they rotate in the opposite direction. To make sure that they are rotating in the correct direction, simply check that, just after the start-up of the compressor, the pressure drops on the LP side and rises on the HP side. Furthermore, if a scroll compressor rotate in the opposite direction, there is a considerable rise in the sound level of the unit, as well as in a dramatic reduction of current absorption compared to normal values. In case of wrong rotation, the scroll compressor can be definitely damaged.

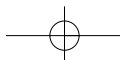

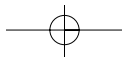

Start-up

5.3 Checking the operation

Check the following:

- The temperature of the water entering the evaporator.
- The temperature of the water leaving the evaporator.
- The level of the water flow rate in the evaporator, if possible.
- The current absorption upon the start of the compressor and in case of stabilised operation.
- The fan's current absorption.

Check that the condensing and evaporation temperatures, during operation at high and low pressure detected by the pressure gauges of the refrigerant, are within the following range:
(On the units not provided with HP/LP pressure gauges for the refrigerant, connect a pressure gauge to the Schrader valves on the refrigeration circuit).

HP side	Approx. 15 to 21 °C above the temperature of the air entering the condenser, for R407C units.
LP side	Approx. 2 to 4 °C below the temperature of the leaving chilled water, for R407C units.

5.4 Delivery to the customer

- Train the user according to the instructions provided in Section 6.

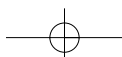

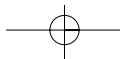

Control System

6 MINICHILLER CONTROL

6.1 Operating instructions

6.1.1 Before start-up

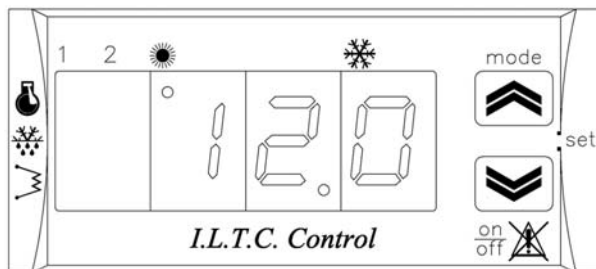





Before starting the equipment:

- 1) Turn on the master switch of the power line.
- 2) For an ideal heating of the oil in the compressor's cup and for a proper removal of the refrigerant from the oil, the operation described in sub-paragraph 1) above should be performed several hours before the actual start-up of the equipment.

6.1.2 Starting and using the Unit

To properly use the unit in full safety, please read and understand the instructions provided below.

- 1) **To start the unit**, press the  key for two seconds ; the unit will stop if you carry out the same operation while it is running. When the equipment does not work, the control system's display shows a red hyphen or the message "E00", if a remote Run/Stop contact has been provided.
- 2) If the unit is of the heat pump type, the  key makes it possible to select either the cooling or the heating mode.
When you press this key, the mode cyclically switches from standby to cooling, heating, standby etc. The cooling mode is highlighted by the lighting-up of the LED positioned under the  ideogram, while the heating mode is highlighted by the lighting-up of the LED positioned under the  ideogram.
- 3) **To modify the set-points**, press both keys at the same time.
When the "Set" message appears on the display, this operation must be repeated to go to the next level. Scroll the text on the display up or down, in order to display the "Coo" and "HEA" messages alternatively. The heating set point can be modified by pressing both keys at the same time, so as to switch to the next level.

Doing this, you can display the shop setting, which is 12 °C. This setting can be increased or decreased by scrolling its value up or down, through the relevant keys.

Once the desired value has been displayed, simply press both keys for 2 seconds to accept it and to go back to the previous level. If you scroll the text, the "HEA" message is displayed and the heating set point can be modified through the same procedure adopted to modify the cooling set point.

At the end of the setting process, you can go back to the first level, by holding both keys down for 2 seconds, as described in the paragraph "User Interface".

- 4) **To display other useful temperatures**, go to level 1 as described above and then scroll the display up until the "tp" message is displayed; then, repeat the procedure in order to go to the lower level. At this point, scroll the display until the t01, t02, t03 messages appear.
Going to the next level, while the t02 message is being displayed, allows you to display the leaving water temperature, while repeating this operation when the tp03 message appears allows you to display the surface temperature of the coil.
- 5) The unit is shop-preset for summer/winter switching with the keyboard. If a **remote summer/winter switching contact** has been provided, it is necessary to switch the H27 software parameter to re-configure the unit accordingly.
To do this, press the two keys at the same time, so as to go to the upper level, and then scroll the display up until the "Par" message appears. Press the two keys again at the same time, so as to go to the upper level, and then scroll the display up until the "Cnf" message appears; then repeat this operation to go to the upper level.
Once you have reached this level, scroll the display up until the "H27" message appears, and then press the two keys again to reach the lower level.
At this point, modify the setting of the parameter from 0 to 1. Confirm the change and repeat the procedure (holding the keys down for two seconds), in order to go back to the first level.

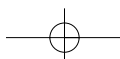

Control System

6) In case of summer/winter switching through remote contact, **the unit will operate in cooling mode when this contact is closed and in heating mode when it is open.**



If the unit is powered by 3-phase current, it is essential that the compressor turns in the correct direction. The direction of rotation of scroll compressors is fixed. The direction of rotation is wrong when, while the unit is working, you can feel:

- an anomalous noise in the compressor
- the lack of the correct differential between discharge pressure and suction pressure (i.e. if the discharge pressure is just above the suction pressure).

If you exchange the connections of two out of three phases, the compressor inverts the direction of rotation and these phenomena disappear suddenly.

6.2 Failure Diagnostics

Alarms Table			
Code	Meaning	Possible cause	Corrective action
E00	Remote On-Off	Turning off of the remote On-Off contact	Turn on the remote contact
E01	Excessive discharge pressure (automatic energizing, just an intervention in an hour)	<ol style="list-style-type: none"> 1. The air circuit is clogged 2. Altered calibration of the discharge pressure control 3. HP set point setting error 4. Excessive refrigerant charge 5. Fan malfunctioning 6. Dirty refrigerant/air exchanger 7. Off-range operation 8. Low water flow rate (in heating mode) 9. Dirty water filter (in heating mode) 	<ol style="list-style-type: none"> 1. Remove any obstacle 2. Set-up the regulator 3. Increase the set point 4. Check the charge 5. Check the functioning and connection of the fan's motor 6. Clean the exchanger 7. Ensure compliance with the working range 8. Adjust the flow rate 9. Clean the air filter
E02	Insufficient discharge pressure (automatic energizing until the first two interventions in an hour)	<ol style="list-style-type: none"> 1. Low water flow rate 2. Dirty refrigerant/air exchanger 3. Clogged refrigerant filter 4. Low discharge pressure 5. Refrigerant leaks 	<ol style="list-style-type: none"> 1. Adjust the flow rate 2. Clean the exchanger 3. Replace the refrigerant filter 4. Check the set point of the discharge pressure 5. Identify and remove any leaks
E05	Antifreezing protection (automatic energizing until the first two interventions in an hour)	<ol style="list-style-type: none"> 1. Low water flow rate 	<ol style="list-style-type: none"> 1. Adjust the flow rate
E06	Failure of sensor ST2 (water outlet)	Occurs when ST2 is interrupted, in short-circuit or off-range	Check ST2 and replace it if necessary
E07	Failure of sensor ST3 (refrigerant/water exchanger)	Occurs when ST3 is interrupted, in short-circuit or off-range	Check ST3 and replace it if necessary
E41	Alarm is automatically resetted up to first three events occurring in one hour.	No water flow rate	Check the differential pressure switch, the pump and the hydraulic system

General Description

7 GENERAL DESCRIPTION

7.1 Introduction

MQL/MQH units are water chillers / air - cooled heat pumps with a refrigerant circuit equipped with rotary compressors for sizes 4 and 7 and with scroll compressors for size 8 to 17.

MQL/MQH units are designed for outdoor installation and to ensure highly reliable and efficient performance. These appliances are fit for medium and small air - conditioning applications in the residential and tertiary sectors.

We can supply our ranges in 7 different sizes. Please note that sizes 8 and 10 are available with single and three - phase power supply.

All the units have no surge tank in the hydraulic circuit, since the control allows the system to work with a water content of 3.5 l/kW. However, it is possible to buy separately the external water tank for installations with a water content lower than 3.5 l/kW (see picture).

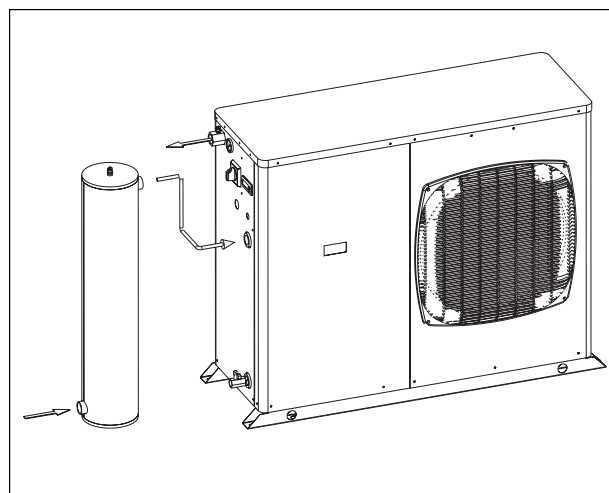

External Tank Dimensions:	
Volume	15 l
Diameter	170 mm
Height	820mm
Connections Inlet / Outlet	Fitting gas thread
Operating weight	25 kg

All the units are equipped with a pump; in this case too, it is possible to buy a kit which makes it possible to remove the pump from the unit and to install a pump outside the unit (see picture).

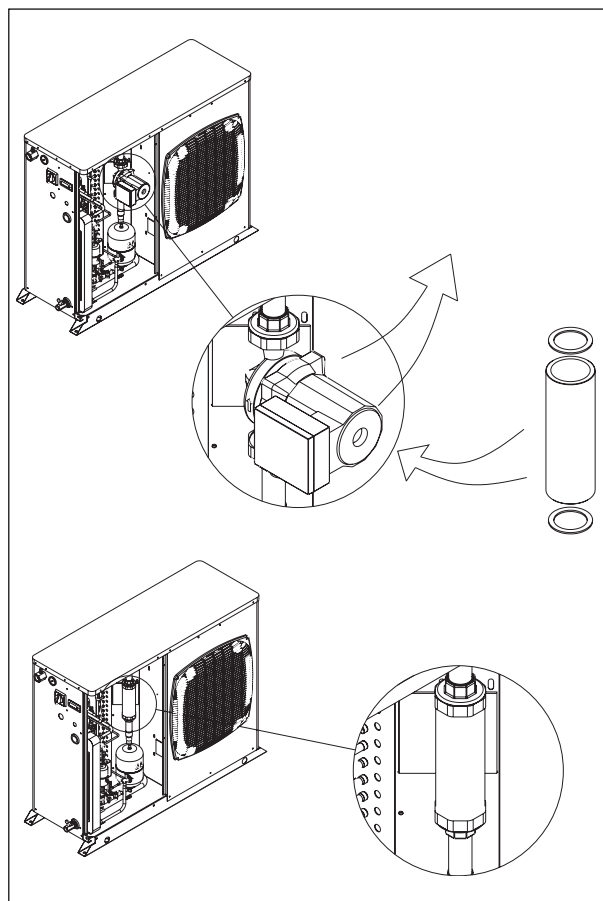

7.2 General Specifications

MQL/MQH units are supplied complete and equipped with all coolant connecting pipings and internal electrical wirings. When the assembly is finished, each unit is subjected to a complete final test to check the proper working of all refrigeration circuits.

The structure is made of galvanized - steel elements assembled through tropicalized - steel screws. All the galvanized - steel parts are protected by RAL 9001 - white baked polyester enamel, which makes the unit corrosion - proof and weather - proof.

General Description

7.3 Compressors

Compressors are of rotary type for sizes 4 and 6 and of scroll type for sizes 8 to 17, with built - in motor protection.

Compressors are mounted on shock absorbers, in order to reduce any possible vibrations. Motors are of direct - start type, cooled by the sucked coolant gas; furthermore, they are equipped with guards in order to protect windings from overtemperature, while the electronic control maintains the discharge temperature within the permissible limit.

7.4 Coolant Circuit

Each unit is equipped with a coolant circuit including: a service valve for the coolant load, a thermostatic expansion valve (4 - 8), a dewaterer filter (4 - 8), a HP and LP pressure switch.

7.5 Water exchanger

Evaporators are of stainless steel plate - type.

Their thermal insulation is ensured by a flexible closed - cell insulating coating.

Furthermore, protection against frost is ensured by electric heaters. These exchangers can work up to a pressure of 3 - bar on the hydraulic side and up to a pressure of 30 - bar on the coolant side.

Hydraulic connections to the evaporator are of 1" female gas threaded type, while the hydraulic circuit's filling / discharge connection is 1/2".

7.6 Air exchanger

Coils are made of copper pipes in staggered rows and mechanically expanded in an aluminium finned pack.

7.7 Fans

Fans are of direct - coupling propeller type, equipped with plastic blades with wing - profile. Each fan is provided with a plastic safety guard.

Finally, motors are completely closed, protection class IP44, adjustable RPM, and protection thermostat immersed in the windings.

The speed pressure regulator is provided as shop - mounted accessory and makes it possible to reach outside air temperatures of - 5°C in cooling mode.

Outline refrigerator MQL 4-8

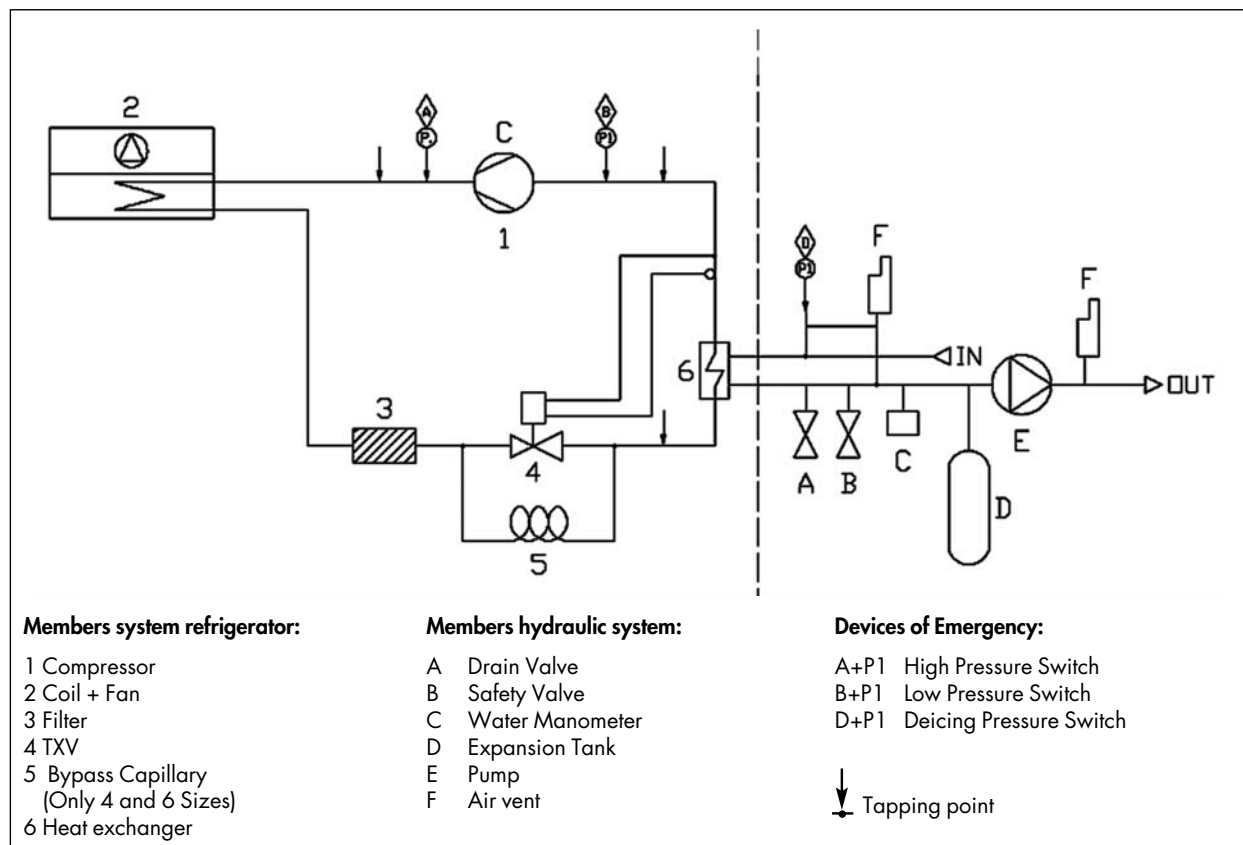

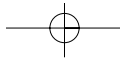

General Description

Outline refrigerator MQL 10-17

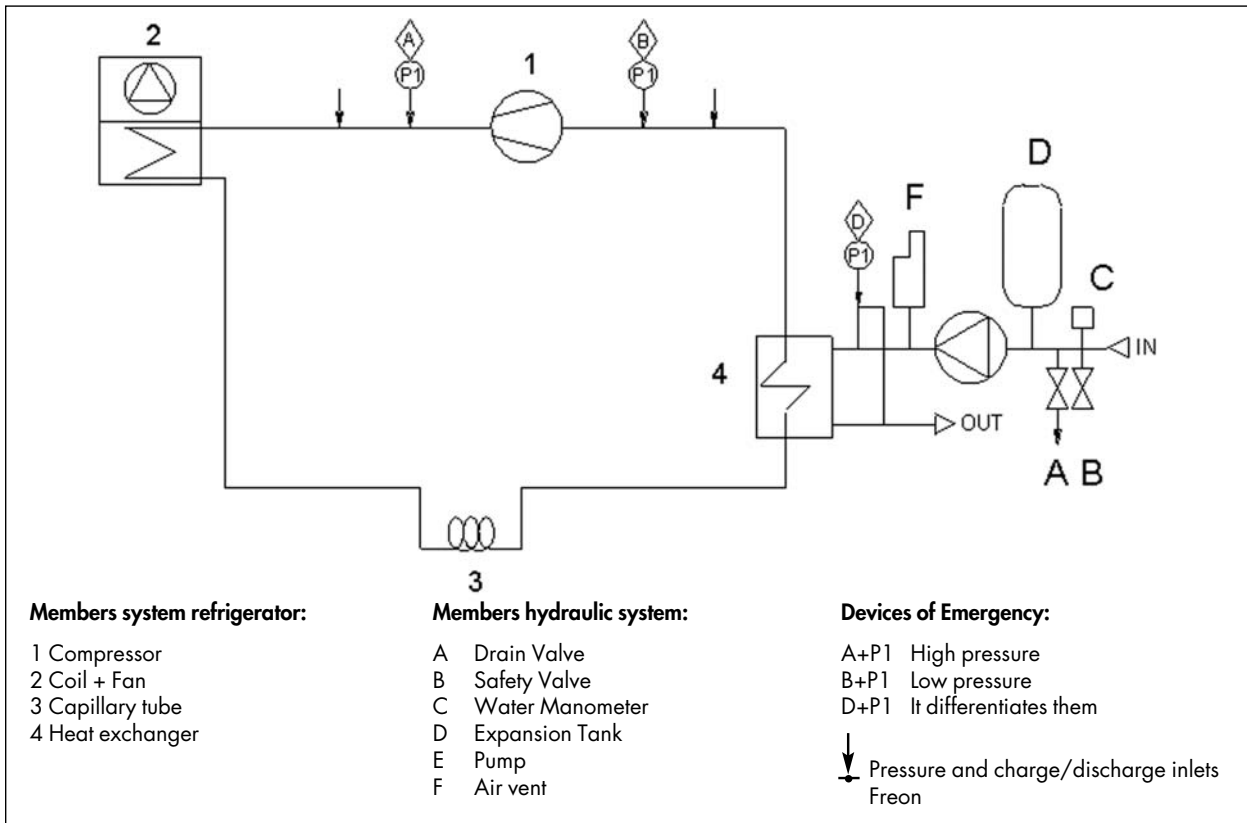

Outline refrigerator MQH HP 4-8

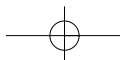
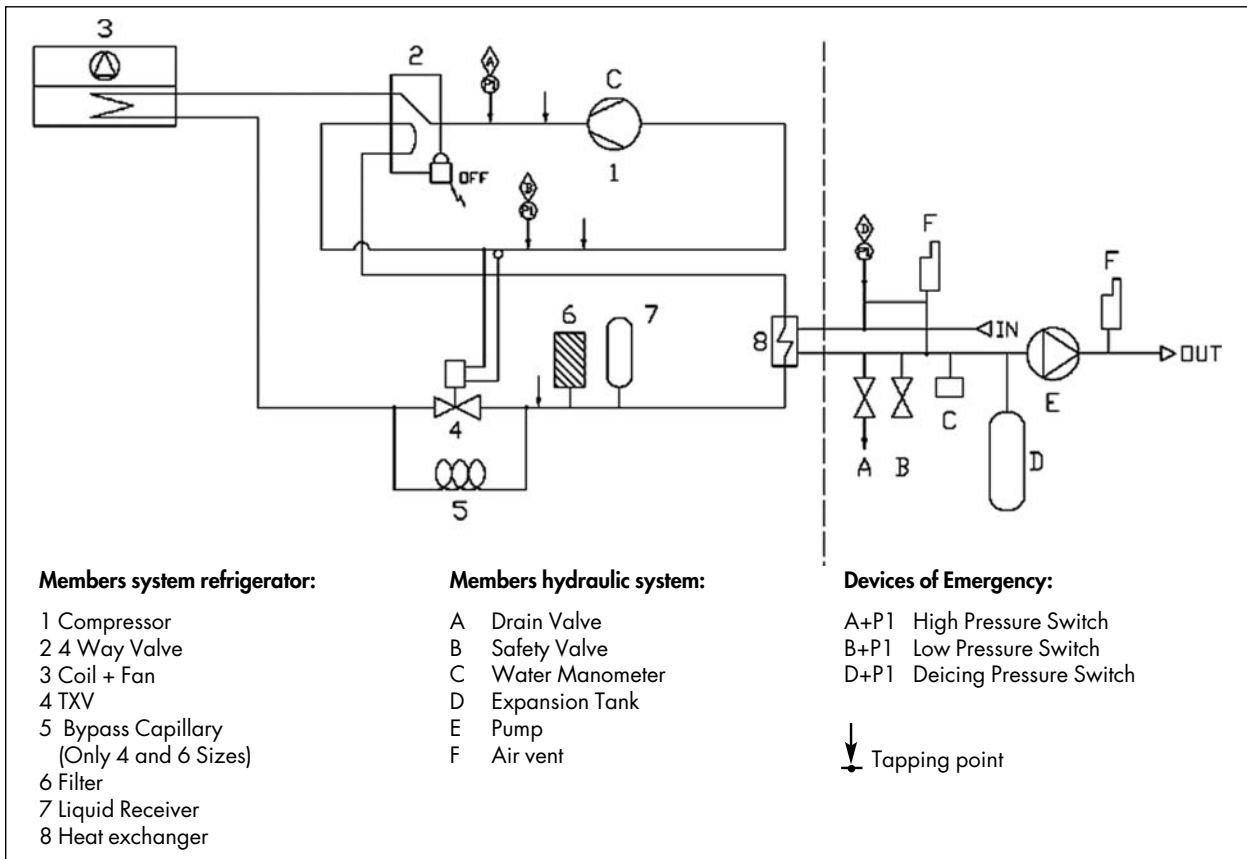

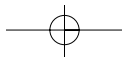

General Description

Outline refrigerator MQH 10-17

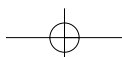
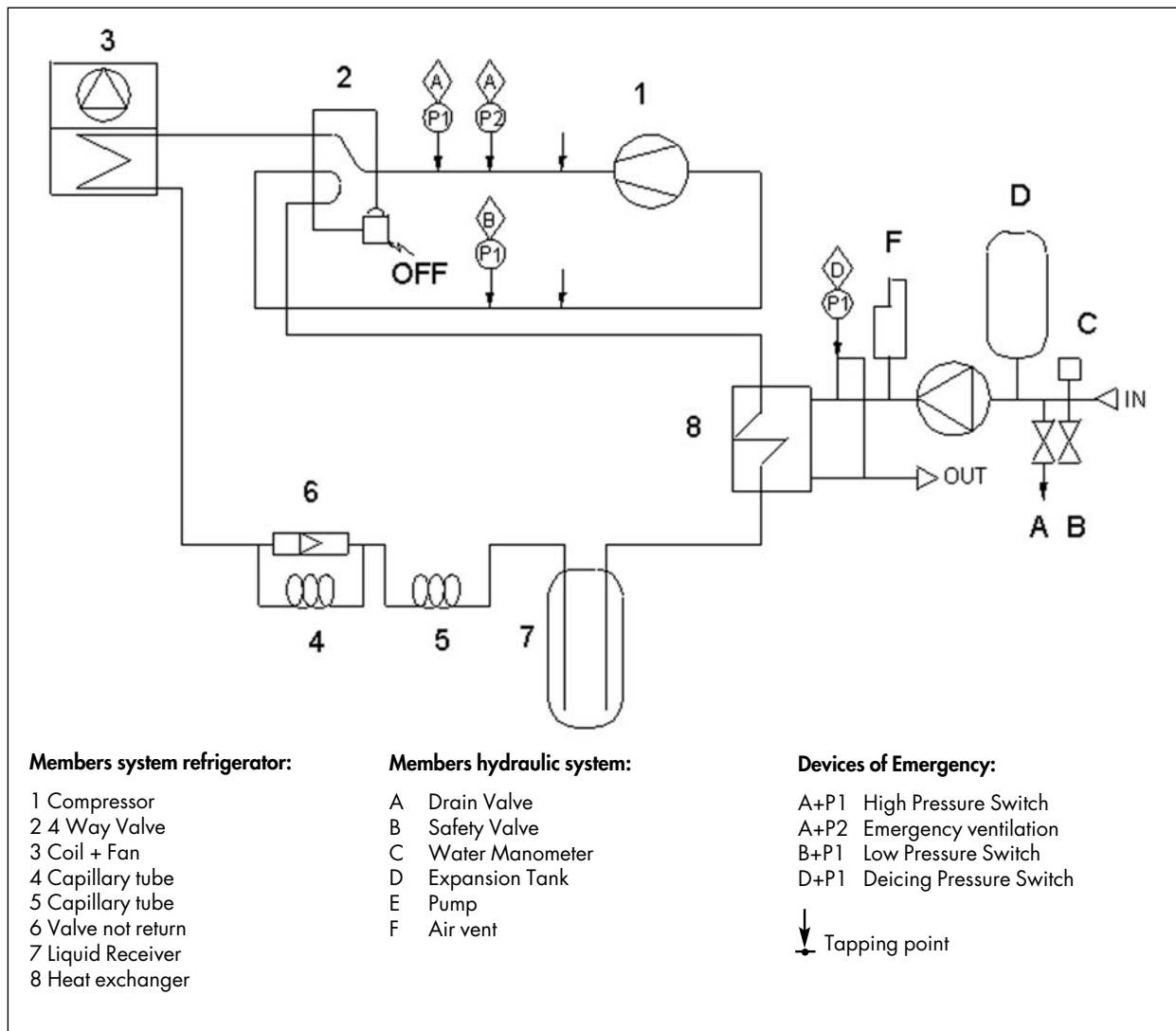

Technical data

8 TECHNICAL DATA

8.1 Technical data

MQL		4	6	8M	8T
Power supply	V/ph/Hz	220V-1-50Hz	220V-1-50Hz	220V-1-50Hz	400/3+N/50
Number of circuits		1	1	1	1
Number of steps		0-100	0-100	0-100	0-100
Refrigerant					
Type		R407C			
Charge (1)	kg	1.2	2.1	2	2
Compressors					
Type		Rotating	Rotating	Scroll	Scroll
Number		1	1	1	1
Start-up type		Direct			
Evaporator					
Type		Slabs			
Number		1	1	1	1
Condenser					
Type		Battery (Al/Cu)			
Hydraulic connections					
Type		Female			
Inlet diameter	inch	1"	1"	1"	1"
Outlet diameter	inch	1"	1"	1"	1"
Weights					
Weight of shipment	kg	97	104	110	110
Dimensions					
Length	mm	1182	1182	1182	1182
Width	mm	400	400	400	400
Height	mm	905	905	905	905

(1) Indicative value. Always refer to the value specified on the unit's label.

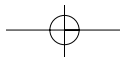

Technical data

MQL		10M	10T	12	15	17
Power supply	V/ph/Hz	220V-1-50Hz	400/3+N/50	400/3+N/50	400/3+N/50	400/3+N/50
Number of circuits		1	1	1	1	1
Number of steps		0-100	0-100	0-100	0-100	0-100
Refrigerant						
Type		R407C				
Charge (1)	kg	2.42	2.42	2.43	3.6.	3
Compressors						
Type		Scroll	Scroll	Scroll	Scroll	Scroll
Number		1	1	1	1	1
Start-up type		Direct				
Evaporator						
Type		Slabs				
Number		1	1	1	1	1
Condenser						
Type		Battery (Al/Cu)				
Hydraulic connections						
Type		Female				
Inlet diameter	inch	1"	1"	1"	1"	1"
Outlet diameter	inch	1"	1"	1"	1"	1"
Weights						
Weight of shipment	kg	153	153	158	160	166
Dimensions						
Length	mm	1182	1182	1182	1182	1182
Width	mm	400	400	400	400	400
Height	mm	1309	1309	1309	1309	1309

(1) Indicative value. Always refer to the value specified on the unit's label.

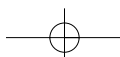

Technical data

MQH		4	6	8M	8T
Power supply	V/ph/Hz	220V-1-50Hz	220V-1-50Hz	220V-1-50Hz	400/3+N/50
Number of circuits		1	1	1	1
Number of steps		0-100	0-100	0-100	0-100
Refrigerant					
Type		R407C			
Charge (1)	kg	1.2	2.1	2	2
Compressors					
Type		Rotating	Rotating	Scroll	Scroll
Number		1	1	1	1
Start-up type		Direct			
Evaporator					
Type		Slabs			
Number		1	1	1	1
Condenser					
Type		Battery (Al/Cu)			
Hydraulic connections					
Type		Female			
Inlet diameter	inch	1"	1"	1"	1"
Outlet diameter	inch	1"	1"	1"	1"
Weights					
Weight of shipment	kg	97	104	110	110
Dimensions					
Length	mm	1182	1182	1182	1182
Width	mm	400	400	400	400
Height	mm	905	905	905	905

(1) Indicative value. Always refer to the value specified on the unit's label.

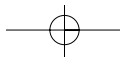

Technical data

MQH		10M	10T	12	15	17
Power supply	V/ph/Hz	220V-1-50Hz	400/3+N/50	400/3+N/50	400/3+N/50	400/3+N/50
Number of circuits		1	1	1	1	1
Number of steps		0-100	0-100	0-100	0-100	0-100
Refrigerant						
Type		R407C				
Charge (1)	kg	2.66	2.66	2.74	3.8.	3.2
Compressors						
Type		Scroll	Scroll	Scroll	Scroll	Scroll
Number		1	1	1	1	1
Start-up type		Direct				
Evaporator						
Type		Slabs				
Number		1	1	1	1	1
Condenser						
Type		Battery (Al/Cu)				
Hydraulic connections						
Type		Female				
Inlet diameter	inch	1"	1"	1"	1"	1"
Outlet diameter	inch	1"	1"	1"	1"	1"
Weights						
Weight of shipment	kg	153	153	158	160	166
Dimensions						
Length	mm	1182	1182	1182	1182	1182
Width	mm	400	400	400	400	400
Height	mm	1309	1309	1309	1309	1309

(1) Indicative value. Always refer to the value specified on the unit's label.

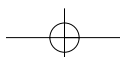

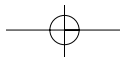

Technical data

8.2 Unit Electrical Data

MQL/MQH		4	6	8M	8T
Rated voltage	V/ph/Hz	230V-1-50Hz			400/3+N/50
Max. absorbed power	kW	2.2	2.7	4.6	4.6
Rated current	A	8.3	10.1	16.4	7.5
Max. current (FLA)	A	9.7	11.7	20.7	8.6
Max. start-up current (LRA)	A	38	53	77	37
External fuses	(A)	16	16	25	16
Max. cable section (1)	mm ²	2.5	2.5	4.0	2.5

MQL/MQH		10M	10T	12	15	17
Rated voltage	V/ph/Hz	230V-1-50Hz	400/3+N/50			
Max. absorbed power	kW	5.6	5.4	6.3	7.3	8.3
Rated current	A	19.7	9.6	11.2	11.7	13.5
Max. current (FLA)	A	26.4	11.4	13	14.7	16.9
Max. start-up current (LRA)	A	115	51	67	75	102
External fuses	(A)	n.d.	n.d.	n.d.	n.d.	n.d.
Max. cable section (1)	mm ²	n.d.	n.d.	n.d.	n.d.	n.d.

(1) The dimensioning of the unit's power cables is the responsibility of the installer, who shall consider: the rating, the maximum working temperature in the room, the type of insulation and the cable laying, the maximum length of the power supply line.
n.d. Not available.

Electrical Data Compressors

Compressors MQL/MQH		4	6	8M	8T
Number	n°	1	1	1	1
Max. absorbed power	kW	1,8	2,3	4,2	4,2
Nominal current	A	6,6	8,4	14,7	5,8
Max. current (FLA)	A	8	10	19	6,9
Max. start-up current (LRA)	A	37	52	76	36
Oil pan resistor	W	-	-	70	70

Compressors MQL/MQH		10M	10T	12	15	17
Number	n°	1	1	1	1	1
Max. absorbed power	kW	4,9	4,7	5,6	6,6	7,6
Nominal current	A	16,3	6,2	7,8	8,3	10,1
Max. current (FLA)	A	23	8	9,6	11,3	14
Max. start-up current (LRA)	A	114	50	66	74	101
Oil pan resistor	W	70	70	70	70	70

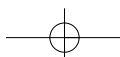

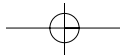

Technical data

Fans Electrical data

Fans MQL/MQH		4	6	8M	8T
Number	n°	1	1	1	1
Rated power per fan	kW	0.15	0.15	0.15	0.15
Max. absorbed current per fan	A	0.7	0.7	0.7	0.7

Fans MQL/MQH		10M	10T	12	15	17
Number	n°	2	2	2	2	2
Rated power per fan	kW	0.15	0.15	0.15	0.15	0.15
Max. absorbed current per fan	A	0.7	0.7	0.7	0.7	0.7

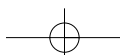
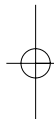
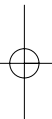

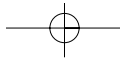

Technical data

8.3 Overall dimensions

MQL/MQH 4-8

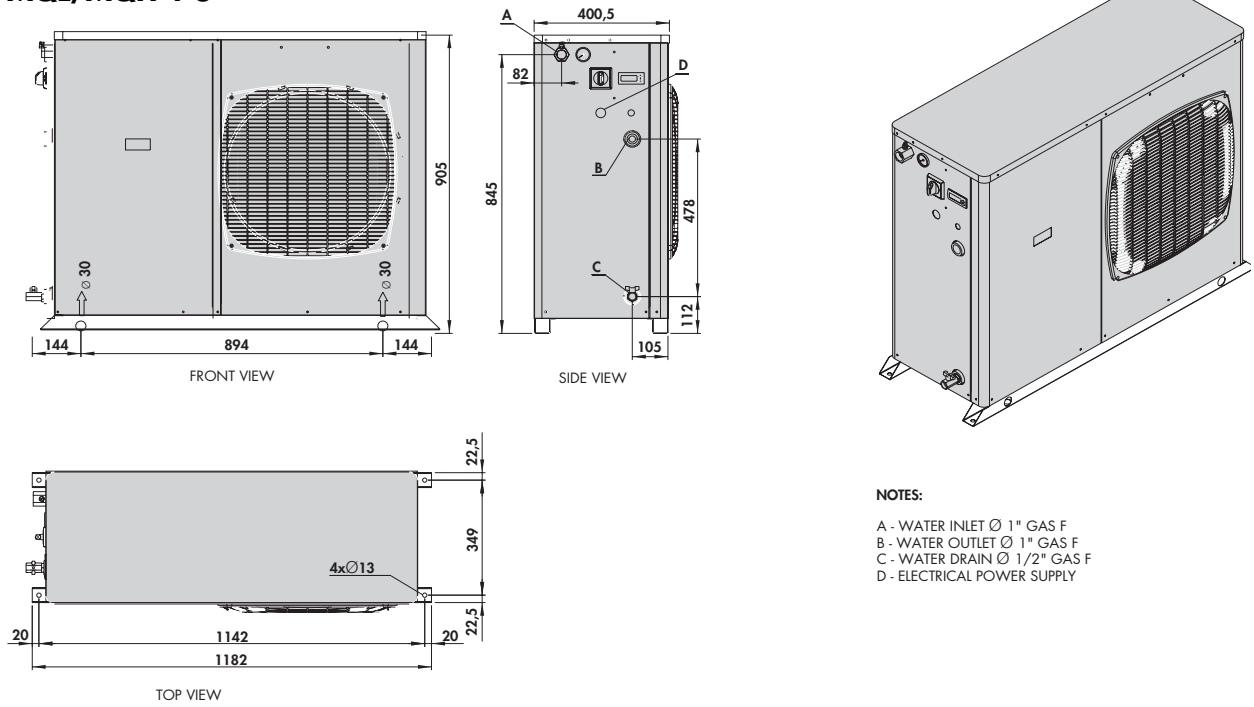

MQL/MQH 10-17

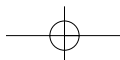
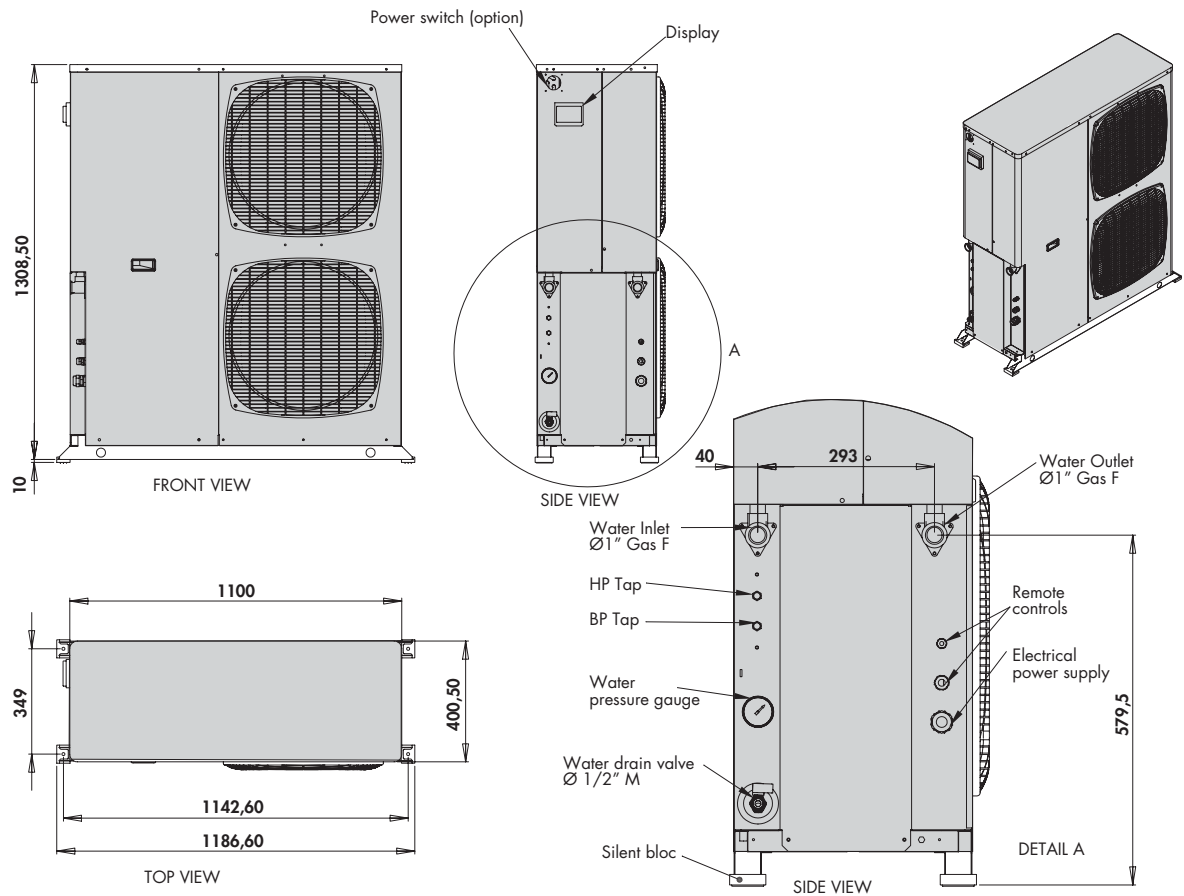

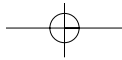

Technical data

8.4 Clearances

MQL/MQH 4-8

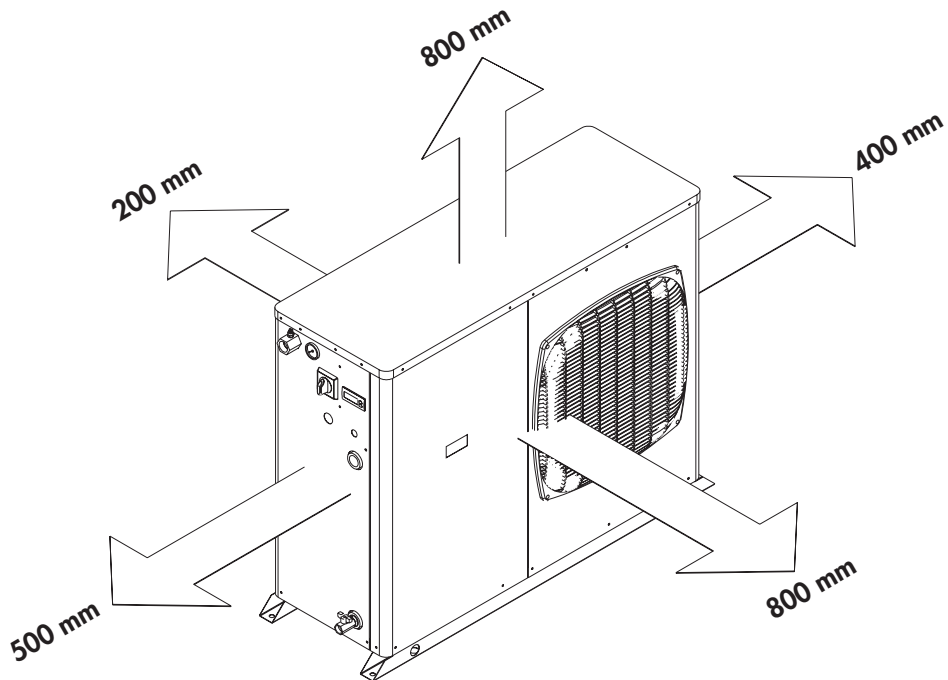

MQL/MQH 10-17

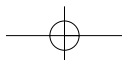
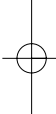
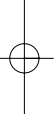
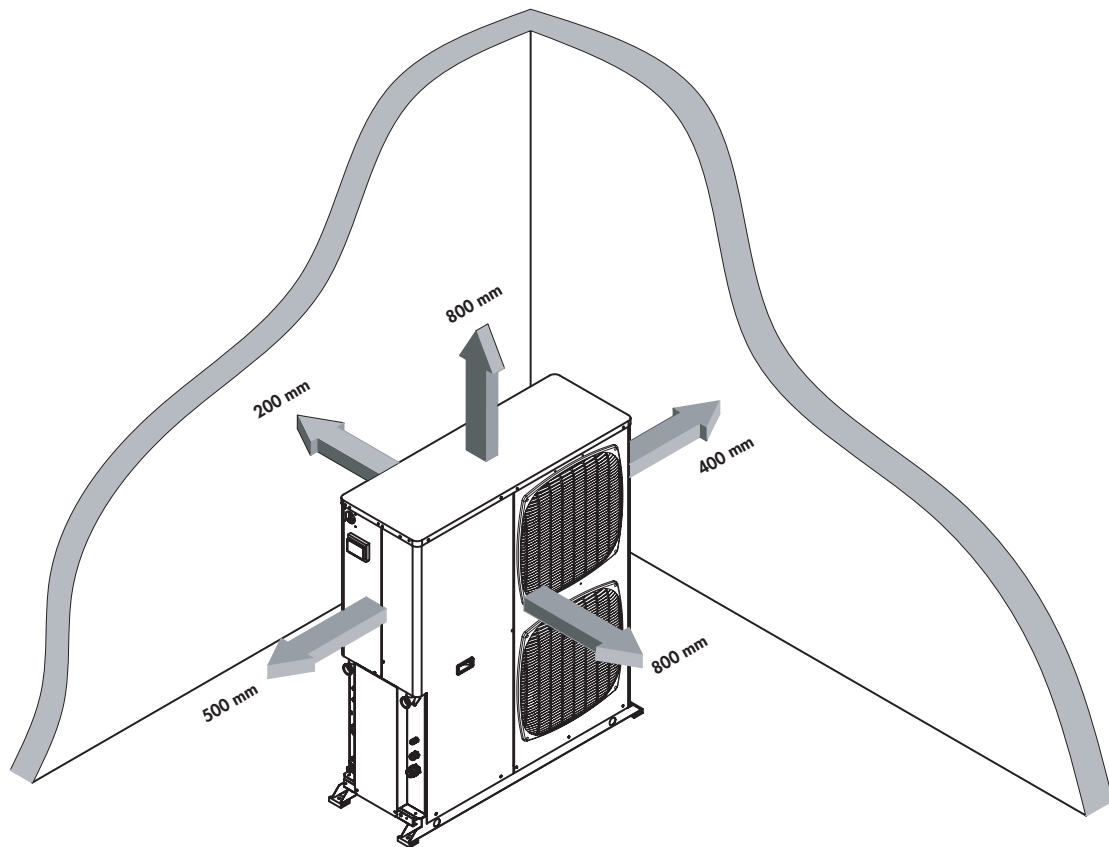

Maintenance

9 MAINTENANCE

Carefully read the "Safety" section of this manual before carrying out any maintenance operations.



Do not discharge the refrigerant into the atmosphere while the refrigeration circuits are being drained. Use appropriate recovery equipment. When the recovered refrigerant cannot be re-used, return it to the manufacturer.



Do not throw away the waste oil of the compressor, because it contains refrigerant in solution. The waste oil must be returned to the manufacturer.

Unless otherwise specified, the operations described below may be carried out only by a trained maintenance operator.

9.1 General requirements

Itelco-Clima units have been designed for continuous operation, providing that they are subjected to regular maintenance, within the limits specified in this manual. Each unit must be serviced according to the programme by the User/Customer, and must be inspected at regular intervals by the personnel of one of Itelco-Clima's authorised Service Centers.

It is the responsibility of the User to meet these maintenance requirements and/or to enter into an agreement with one of Itelco-Clima's Service Centers, so as to properly safeguard the operation of the appliance.

During the warranty period, in case of damage or failures caused by improper maintenance, Itelco-Clima will not refund the costs incurred to repair the appliance in its original state.

The provisions of this section apply only to standard units; according to the order requirements, other documentation may be added, concerning any modifications or supplementary accessories.

9.2 Planned maintenance

Maintenance inspections must be carried out according to the program below, by a qualified person. As a general rule, units cannot be repaired directly by the user, who shall not try to service or repair any failures or anomalies identified during daily inspections. If you are in doubt, please contact Itelco-Clima Service Centre.

Planned maintenance

Operations	Daily	Weekly	Monthly	Beginning of season	End of season
Check the temperature of the leaving fluid	●				
Check the pressure drops in the heat exchanger		●			
Check for electric absorption		●			
Check suction pressure and temperature		●			
Check delivery pressure and temperature		●			
Check that the fins of the external coil are clean (if any)			●		
Check the operation of the oil heaters (if any)			●		
Check the remote control switches			●		
Check the operation of the LP pressure switch				●	
Check the operation of the HP pressure switch				●	
Check the insulation of the heat exchanger				●	
Check that terminals are tightened				●	
Check that the terminals' screws are tightened				●	
Clean the exterior of the unit with water and soap				●	
Check the density of the antifreeze (if any)				●	●

Maintenance

9.3 Refrigerant charge



Do not inject refrigerant liquid into the LP side of the circuit. Be very careful, and charge the circuit properly. If the charge is insufficient, the efficiency of the unit will be lower than expected. In the worst of cases the LP pressure switch may be activated, resulting in the halting of the unit.

In the presence of an excess charge, the condensing pressure will rise (in the worst of cases, the HP pressure switch may be activated, resulting in the stop of the equipment), and the consumption will increase as well.



It is strictly forbidden to use the compressor as a vacuum pump to drain the plant.

Fill the refrigeration circuit after it has been drained for maintenance purposes (leaks, replacement of the compressor etc.). The amount of the charge is indicated on the plate affixed to the unit.

Before refilling, it is important to drain and dehydrate the circuit, thus obtaining a minimum abs. pressure value of 50 Pa.

Inject the refrigerant fluid before removing the vacuum, then fill the circuit up to 90% of the total gas requirement (in liquid form). The appliance must be filled.

It is recommended to connect the refrigerant cylinder to the filling valve, and to arrange it in such a way as to inject only liquid refrigerant.

Then start the compressor and let the gas flow from the cylinder, until charging operation is done.

9.4 Compressor

Compressors are delivered with the necessary charge of lubricating oil. During normal operation, this charge is sufficient for the whole life of the unit, providing that the efficiency of the refrigeration circuit is satisfactory and if it has not been overhauled.

If the compressor needs to be replaced (following a mechanical failure or if burnt), contact one of Itelco-Clima's Service Centers.



Compressors use polyester oil. During maintenance operations on the compressor, or if you have to open the refrigerant circuit in any point, remember that this type of oil is highly hygroscopic, and accordingly it is important that it is not left exposed to the weather for prolonged periods, as this would require the replacement of the oil. In a few cases, the polyester oil may be present also in R22 units (a refrigerant that can be used also in extra UE countries).

9.5 Condenser

The condenser's coils consist of copper pipes and aluminium fins. To ensure the effective and correct operation of the condenser coils, it is important to keep the condenser's surface perfectly clean, and to check that there is no foreign matter, such as leaves, wires, insects, waste etc. If the coil becomes dirty, there is an increase in the absorption of electric energy. Furthermore, the maximum pressure alarm may be activated and may halt the unit.



Be careful not to damage the aluminium fins during cleaning.

The condenser must be cleaned with a LP compressed air jet, parallel to the aluminium fins, in the direction opposite to the air circulation.

To clean the coil you can use also a vacuum cleaner, or a jet of water and soap.

9.6 Fans

The fans of the condenser, of axial type, are complete with impeller with aerodynamic profile blades and a cylindrical nozzle. The motor's bearings are lubricated forever.

9.7 Dehydrating filter

The refrigeration circuits are provided with dehydrating filters (MQL-MQH 4-8).

The filter clogging is marked by the presence of air bubbles in the sight glass, or by the difference between the temperatures measured downstream from and upstream of the drying filter. If, once the cartridge has been cleaned, the problems persist, it means that the appliances has lost part of the refrigerant charge in one or more points, that must be identified and serviced.

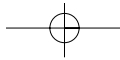

Maintenance

9.8 Thermostatic expansion valve (Only MQL-MQH 4-8)

The circuit of the unit is equipped with a thermostatic expansion valve, with external equalizer.
The valve is shop-calibrated for an overheating of 5°C.

Procedure to check for overheating:

- Measure the suction pressure with the pressure gauges on the board of the unit or using a pressure gauge connected to the service valve on the suction side.
- From the pressure gauge's temperature scale, measure the saturated suction temperature (T_{sa}) which corresponds to the pressure value.
- Using a contact pressure gauge affixed to the outlet fitting of the gas of the evaporator, measure the actual temperature (T_{se}).

Overheating calculation (S):

$$S = T_{se} - T_{sa}$$

Overheating is regulated through the thermostatic expansion valve.

Make the adjusting screw follow a complete turn, and operate the appliance for five minutes.
Check again and, if necessary, repeat the regulation.

If the expansion valve cannot be regulated, it is probably broken, and shall be replaced. The replacement must be carried out by a Service Centre.

9.9 Evaporator

Check at regular intervals that the water side of the heat exchanger is perfectly clean. To do this, measure the pressure drop, water side (see Section 8) or measure the temperature of the liquid leaving and entering the heat exchanger, and compare it to the evaporation temperature.

To obtain an effective heat exchange, the difference between the temperature of the leaving water and the saturated evaporating temperature must be in the 2 - 4°C range. A greater difference would indicate a low efficiency of the heat exchanger (i.e. the heat exchanger is dirty).

In this case, the heat exchanger must be subjected to chemical cleaning, an operation that shall be carried out by authorised engineers.

For other maintenance operations (extraordinary overhauling, replacement of the heat exchanger etc.), contact an authorised Service Centre.

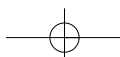

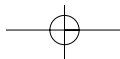

Troubleshooting

10 TROUBLESHOOTING

The table below lists the anomalies of operation of the unit, the relevant causes and the corrective measures. For anomalies of any other type or not listed, contact one of Itelco-Clima's Service Centre for technical assistance.

Anomaly	Cause	Operation
The unit continues to work, but without cooling.	Insufficient charge of refrigerant.	Refill.
	The dehydrating filter is clogged.	Replace.
Ice on the suction line.	Wrong calibration of overheating.	Increase overheating.
		Check the charge.
Excessive noise.	Vibration of lines.	Check the clamping brackets, if any.
	Whistler emitted by the thermostatic expansion valve.	Refill. Check the dehydrating filter.
	Noisy compressor.	Seized bearings; replace the compressor. Check that the compressor's locknuts are tightened.
Low oil level in the compressor.	One or more gas or oil leaks in the circuit	Identify and remove leaks.
	Mechanical failure of the compressor.	Request the intervention of a Service Centre.
	Anomaly of the oil heater of the compressor's base.	Check the electric circuit and the resistor of the heater of the motor base, and replace defective components.

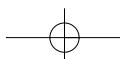

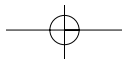

Troubleshooting

Anomaly	Cause	Operation
Compressors is not working.	Breaking of the electric circuit.	Check the electric circuit and detect any ground dispersions and short circuits. Check fuses.
	Intervention of the HP pressure switch.	Reset the pressure switch and the control panel and restart the appliance. Identify and remove the cause that enabled the pressure switch.
	The fuse of the control circuit is broken.	Check for ground dispersions and short circuits. Replace fuses.
	Loosened terminals.	Check and tighten.
	Halt caused by thermal overload of the electric circuit.	Check the operation of check and safety devices. Identify and remove the cause.
	Wrong wiring.	Check wiring of check and safety devices.
	The line voltage is too low.	Check voltage. If problems regard the system, solve them. If they are caused by the distribution network, inform the Energy Distributor.
	Short-circuit of the compressor's motor.	Check the continuity of the winding.
	Seized compressor.	Replace the compressor.
Activation of the LP alarm, stop of the unit.	Gas leak.	Identify and remove the leak.
	Insufficient charge.	Refill.
	Failure of the pressure switch.	Replace the pressure switch.
Activation of the HP alarm, stop of the unit.	Failure of the pressure switch.	Check the operation of the pressure switch, replace it if defective.
	The delivery valve is partially closed.	Open the valve and replace it, if faulty.
	Substances with condensable gases in the circuit.	Drain the circuit.
	The fan (i) of the condenser is stopped.	Check cables and motor. If defective, repair or replace.
The liquid line is too hot.	Insufficient charge.	Identify and remove the cause of the loss of charge and refill.
Frosting of the liquid line.	The valve of the liquid line is partially closed.	Check that valves are open.
	The liquid filter is clogged.	Replace the cartridge or the filter.

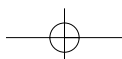

Spare parts

11 SPARE PARTS

11.1 Spare part list

The table below shows the list of spare parts recommended during the first two years of operation.

Component	Number
HP pressure switch	1
LP pressure switch	1
Gas filter	1
Thermostatic valve (only 4-8)	1
Fan's fuses (only 4-8)	1
Compressor's fuses	3
Auxiliary fuses	2
Set of compressor contactors	1
Water sensor	1
Electronic control	1
Compressor oil resistor	1

11.2 Oil for compressors

The compressors are lubricated with:

4-6 FVC 68D
 8 FVC 68D (PVE)
 10-17 POLYESTER

11.3 Wiring diagrams

The wiring diagrams are installed inside the doors of the electrical panels of the unit. Any request for wiring diagrams shall be forwarded to Itelco-Clima's Service Centre.

Dismantling, Demolition and Scrapping

12 DISMANTLING, DEMOLITION AND SCRAPPING



During the draining of the refrigeration circuits, do not let the refrigerant overflow in the surrounding atmosphere. The circuit must be drained using suitable recovery equipment.



Do not disperse the waste oil of the compressors in the environment, since it contains some dissolved refrigerant.

For the disposal, contact the competent authority for information.

Unless otherwise specified, the maintenance operations listed below may be carried out by any trained maintenance operator.

12.1 Generalities

Open each line that supplies the unit, including the ones of control circuits. Make sure that all disconnecting switches are secured in the off position. The power cables can be disconnected and disassembled. Refer to Chapter 4 for the position of connection points.

Remove all the refrigerant from the refrigeration circuits of the unit and store it in suitable containers, using a recovery unit. If its characteristics have remained the same, the refrigerant can be used again. Contact the competent authority to obtain information about disposal. In **NO** event shall the refrigerant be discharged into the atmosphere. The oil in each refrigeration circuit must be drained and collected into a suitable container; then it shall be disposed of in conformity with local regulations that apply to the disposal of waste lubricants. Any oil spillage must be recovered and disposed of in like manner.

Isolate the unit's heat exchangers from the external hydraulic circuits and drain the heat exchange sections of the plant.



If no shutoff valves have been provided, it may be necessary to drain the whole plant. If a glycoled solution or a similar fluid has been used in the hydraulic circuits, or if chemical additives have been added to the circulating water, the circulating fluid MUST be drained in a proper way. For NO reason shall a circuit containing glycoled water or a similar solution be discharged directly into the drains or surface waters.

After draining operations, the piping of the hydraulic networks can be disconnected and disassembled.

Once they have been disconnected as specified, the packaged units can be disassembled in a single piece. First of all, disassemble the anchoring screws and then lift the unit from the position of installation, and hook it to the lifting points provided, using suitable lifting equipment.

To this end, refer to Chapter 4 for the installation of these appliances, to Chapter 8 for their weights and Chapter 3 for handling.

The units that, once disconnected, cannot be removed in a single piece, must be dismantled on site; in this case, be very careful with the weight and handling of every single component.

It is always advisable to dismantle the units following the installation steps, but in reverse.



Some residues of oil, glycoled water or similar solutions may remain in certain parts of the unit. These residues must be recovered and disposed of according to the procedures specified above.

It is very important to ensure that, while a component of the unit is being removed, all the others are properly supported.



Use only lifting means of adequate capacity.

Once disassembled, the components of the unit can be disposed of in conformity with current regulations.

Wesper S.A.S.

42, cours Jean-Jaurès
17800 PONS - FRANCE

☎ : +33-5 46 92 33 33

☎ : +33-5 46 91 38 33

www.wesper.com

As part of our ongoing product improvement programme, our products are subject to change without prior notice. Non contractual photos.

Dans un souci d'amélioration constante, nos produits peuvent être modifiés sans préavis. Photos non contractuelles.

Your distributor / Votre agent commercial :

CE
