

TOSHIBA

FILE NO. A06-016

SERVICE MANUAL

FRESH AIR INTAKE INDOOR UNIT for S-MMS

INDOOR UNIT

MMD-AP0481HFE

MMD-AP0721HFE

MMD-AP0961HFE

OUTDOOR UNIT

- For Service Manual of S-MMS and outdoor unit, refer to the Service Manual (File No. A03-009, A03-010).

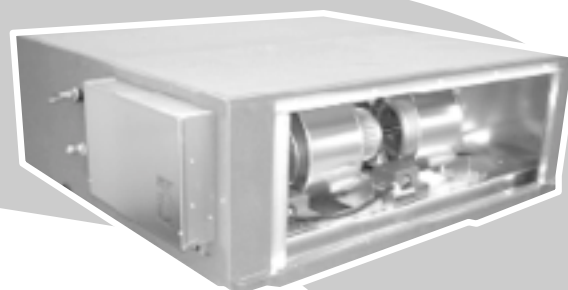

ADOPTION OF NEW REFRIGERANT

This Fresh Air Intake Indoor Unit for S-MMS is a new type which adopts a new refrigerant HFC (R410A) instead of the conventional refrigerant R22 in order to prevent destruction of the ozone layer.

WARNING

Cleaning of the air filter and other parts of the air filter involves dangerous work in high places, so be sure to have a service person do it. Do not attempt it yourself.
The cleaning diagram for the air filter is there for the service person, and not for the customer.

CONTENTS



- SAFETY CAUTION 4**
- 1. OUTLINE OF FRESH AIR INTAKE INDOOR UNIT 9**
 - 1-1. S-MMS System Specifications to Connect Fresh Air Intake Indoor Unit 10
- 2. SPECIFICATIONS 12**
 - 2-1. Fresh Air Intake Indoor Unit for S-MMS 12
- 3. SPECIFICATIONS OF ELECTRICAL PARTS 13**
 - 3-1. Fresh Air Intake Indoor Unit for S-MMS 13
- 4. OWNER’S MANUAL 14**
 - PARTS NAME 14
 - PARTS NAME OF REMOTE CONTROLLER 15
 - CORRECT USAGE 17
 - TIMER OPERATION 19
- 5. INSTALLATION MANUAL 20**
 - Accessory parts and Parts to be procured locally 20
 - 1 PRECAUTIONS FOR SAFETY 20
 - 2 SYSTEM CONTROL OF FRESH AIR INTAKE INDOOR UNIT 22
 - 3 SELECTION OF INSTALLATION PLACE 23
 - 4 INSTALLATION OF INDOOR UNIT 25
 - 5 DUCTWORK 28
 - 6 DRAIN PIPING WORK 31
 - 7 REFRIGERANT PIPING 32
 - 8 ELECTRIC WORK 34
 - 9 APPLICABLE CONTROLS 37
 - 10 FAN CHARACTERISTICS 39
 - 11 TEST RUN 46
 - 12 TROUBLESHOOTING 47
 - 13 MAINTENANCE 48

6. CONSTRUCTION VIEWS (EXTERNAL VIEWS)	49
6-1. Fresh Air Intake Indoor Unit for S-MMS	49
7. WIRING DIAGRAM	50
7-1. Fresh Air Intake Indoor Unit for S-MMS	50
8. REFRIGERATING CYCLE DIAGRAM	52
8-1. Fresh Air Intake Indoor Unit for S-MMS	52
9. CONTROL OUTLINE	53
9-1. Control Specifications	53
10. APPLIED CONTROL / FUNCTION (INCLUDING CONTROL CIRCUIT CONFIGUTATION)	58
10-1. Indoor Print Circuit Board	58
10-2. Indoor P.C. Board Optional Connector Specifications	59
10-3. Function during Test Operation	60
10-4. Function Selection Setting for Indoor Air Conditioner (For setup, be sure to use a wired remote controller)	62
10-5. Applicable Control of Indoor Air Conditioner	64
11. TROUBLE DIAGNOSES	69
11-1. Summary of trouble diagnoses	69
11-2. Checking Method	70
11-3. Trouble Diagnoses by Check Display of the Remote Controller	73
11-4. Check Code and Check Position Displayed on the Remote Controller and Outdoor Unit (7-Segment Display of Interface)	75
11-5. Sensor Characteristics	86
12. REPLACEMENT OF FAN ASSEMBLY	87
13. P.C. BOARD REPLACING PROCEDURES	92
14. EXPLODED VIEWS AND PARTS LIST	96
14-1. Fresh Air Intake Indoor Unit for S-MMS	96

SAFETY CAUTION



The important contents concerned to the safety are described on the product itself and on this Service Manual. Please read this Service Manual after understanding the described items thoroughly in the following contents (Indications/Illustrated marks), and keep them.

[Explanation of indications]

Indication	Explanation
 DANGER	Indicates contents assumed that an imminent danger causing a death or serious injury of the repair engineers and the third parties when an incorrect work has been executed.
 WARNING	Indicates possibilities assumed that a danger causing a death or serious injury of the repair engineers, the third parties, and the users due to troubles of the product after work when an incorrect work has been executed.
 CAUTION	Indicates contents assumed that an injury or property damage (*) may be caused on the repair engineers, the third parties, and the users due to troubles of the product after work when an incorrect work has been executed.

* Property damage : Enlarged damage concerned to property, furniture, and domestic animal/pet





[Explanation of illustrated marks]

Mark	Explanation
	Indicates prohibited items (Forbidden items to do) The sentences near an illustrated mark describe the concrete prohibited contents.
	Indicates mandatory items (Compulsory items to do) The sentences near an illustrated mark describe the concrete mandatory contents.
	Indicates cautions (Including danger/warning) The sentences or illustration near or in an illustrated mark describe the concrete cautious contents.









[Confirmation of warning label on the main unit]

Confirm that labels are indicated on the specified positions
(Refer to the Parts disassembly diagram (Outdoor unit).)







If removing the label during parts replace, stick it as the original.

 DANGER	
 Turn off breaker.	Turn "OFF" the breaker before removing the cabinet, otherwise an electric shock is caused by high voltage resulted in a death or injury. During operation, a high voltage with 380V or higher of circuit (*) at secondary circuit of the high-voltage transformer is applied. If touching a high voltage with the naked hands or body, an electric shock is caused even if using an electric insulator. * : For details, refer to the electric wiring diagram.
 Execute discharge between terminals.	When removing the cabinet, execute short-circuit and discharge between high-voltage capacitor terminals. If discharge is not executed, an electric shock is caused by high voltage resulted in a death or injury. After turning off the breaker, high voltage also keeps to apply to the high-voltage capacitor.
 Prohibition	Do not turn on the breaker under condition that the cabinet are removed. An electric shock is caused by high voltage resulted in a death or injury.





 **WARNING**

 Check earth wires.	<p>Before troubleshooting or repair work, check the earth wire is connected to the earth terminals of the main unit, otherwise an electric shock is caused when a leak occurs. If the earth wire is not correctly connected, contact an electric engineer for rework.</p>
 Prohibition of modification.	<p>Do not modify the products. Do not also disassemble or modify the parts. It may cause a fire, electric shock or injury.</p>
 Use specified parts.	<p>For spare parts, use those specified (*). If unspecified parts are used, a fire or electric shock may be caused. * : For details, refer to the parts list.</p>
 Do not bring a child close to the equipment.	<p>Before troubleshooting or repair work, do not bring a third party (a child, etc.) except the repair engineers close to the equipment. It causes an injury with tools or disassembled parts. Please inform the users so that the third party (a child, etc.) does not approach the equipment.</p>
 Insulating measures	<p>Connect the cut-off lead cables with crimp contact, etc, put the closed end side upward and then apply a water-cut method, otherwise a leak or production of fire is caused at the users' side.</p>
 No fire	<p>When repairing the refrigerating cycle, take the following measures.</p> <ol style="list-style-type: none"> 1) Be attentive to fire around the cycle. When using a gas stove, etc, be sure to put out fire before work; otherwise the oil mixed with refrigerant gas may catch fire. 2) Do not use a welder in the closed room. When using it without ventilation, carbon monoxide poisoning may be caused. 3) Do not bring inflammables close to the refrigerant cycle, otherwise fire of the welder may catch the inflammables.
 Refrigerant	<p>Check the used refrigerant name and use tools and materials of the parts which match with it. For the products which use R410A refrigerant, the refrigerant name is indicated at a position on the outdoor unit where is easy to see. To prevent miss-charging, the route of the service port is changed from one of the former R22.</p> <p>For a fresh air intake indoor unit which uses R410A, never use other refrigerant than R410A. For a fresh air intake indoor unit which uses other refrigerant (R22, etc.), never use R410A. If different types of refrigerant are mixed, abnormal high pressure generates in the refrigerating cycle and an injury due to breakage may be caused.</p> <p>Do not charge refrigerant additionally. If charging refrigerant additionally when refrigerant gas leaks, the refrigerant composition in the refrigerating cycle changes resulted in change of air conditioner characteristics or refrigerant over the specified standard amount is charged and an abnormal high pressure is applied to the inside of the refrigerating cycle resulted in cause of breakage or injury. Therefore if the refrigerant gas leaks, recover the refrigerant in the air conditioner, execute vacuuming, and then newly recharge the specified amount of liquid refrigerant. In this time, never charge the refrigerant over the specified amount.</p> <p>When recharging the refrigerant in the refrigerating cycle, do not mix the refrigerant or air other than R410A into the specified refrigerant. If air or others is mixed with the refrigerant, abnormal high pressure generates in the refrigerating cycle resulted in cause of injury due to breakage.</p> <p>After installation work, check the refrigerant gas does not leak. If the refrigerant gas leaks in the room, poisonous gas generates when gas touches to fire such as fan heater, stove or cooking stove though the refrigerant gas itself is innocuous.</p> <p>Never recover the refrigerant into the outdoor unit. When the equipment is moved or repaired, be sure to recover the refrigerant with recovering device. The refrigerant cannot be recovered in the outdoor unit; otherwise a serious accident such as breakage or injury is caused.</p>
 Assembly/Cabling	<p>After repair work, surely assemble the disassembled parts, and connect and lead the removed cables as before. Perform the work so that the cabinet or panel does not catch the inner cables. If incorrect assembly or incorrect cable connection was done, a disaster such as a leak or fire is caused at user's side.</p>

 **WARNING**

 Insulator check	<p>After the work has finished, be sure to use an insulation tester set (500V mugger) to check the resistance is 2MΩ or more between the charge section and the non-charge metal section (Earth position).</p> <p>If the resistance value is low, a disaster such as a leak or electric shock is caused at user's side.</p>
 Ventilation	<p>When the refrigerant gas leaks during work, execute ventilation.</p> <p>If the refrigerant gas touches to a fire, poisonous gas generates. A case of leakage of the refrigerant and the closed room full with gas is dangerous because a shortage of oxygen occurs. Be sure to execute ventilation.</p>
 Be attentive to electric shock	<p>When checking the circuit inevitably under condition of the power-ON, use rubber gloves and others not to touch to the charging section.</p> <p>If touching to the charging section, an electric shock may be caused.</p>
 Compulsion	<p>When the refrigerant gas leaks, find up the leaked position and repair it surely.</p> <p>If the leaked position cannot be found up and the repair work is interrupted, pump-down and tighten the service valve, otherwise the refrigerant gas may leak into the room. The poisonous gas generates when gas touches to fire such as fan heater, stove or cooking stove though the refrigerant gas itself is innocuous.</p> <p>When installing equipment which includes a large amount of charged refrigerant such as a multi air conditioner in a sub-room, it is necessary that the density does not the limit even if the refrigerant leaks.</p> <p>If the refrigerant leaks and exceeds the limit density, an accident of shortage of oxygen is caused.</p> <p>For the installation/moving/reinstallation work, follow to the Installation Manual.</p> <p>If an incorrect installation is done, a trouble of the refrigerating cycle, water leak, electric shock or fire is caused.</p>
 Check after repair	<p>After repair work has finished, check there is no trouble.</p> <p>If check is not executed, a fire, electric shock or injury may be caused. For a check, turn off the power breaker.</p> <p>After repair work (installation of front panel and cabinet) has finished, execute a test run to check there is no generation of smoke or abnormal sound.</p> <p>If check is not executed, a fire or an electric shock is caused. Before test run, install the front panel and cabinet.</p>
 Check after reinstallation	<p>Check the following items after reinstallation.</p> <ol style="list-style-type: none"> 1) The earth wire is correctly connected. 2) The power cord is not clamped between metal parts. 3) There is no inclination or unsteadiness and the installation is stable. <p>If check is not executed, a fire, an electric shock or an injury is caused.</p>

 **CAUTION**

 Put on gloves	<p>Be sure to put on gloves (*) during repair work.</p> <p>If not putting on gloves, an injury may be caused with the parts, etc.</p> <p>(*) Heavy gloves such as work gloves</p>
 Cooling check	<p>When the power was turned on, start to work after the equipment has been sufficiently cooled.</p> <p>As temperature of the compressor pipes and others became high due to cooling/heating operation, a burn may be caused.</p>
 Put on gloves	<p>Be sure to put on gloves during repair work.</p> <p>If not putting on the gloves, an injury may be caused with the parts, etc.</p>
 Cooling check	<p>Start the work when the equipment has been sufficiently cooled after operation.</p> <p>As temperature of the compressor and other pipes became high due to cooling/heating operation, a burn may be caused.</p>

- **New Refrigerant (R410A)**

This air conditioner adopts a new HFC type refrigerant (R410A) which does not deplete the ozone layer.

1. Safety Caution Concerned to New Refrigerant

The pressure of R410A is high 1.6 times of that of the former refrigerant (R22).

Accompanied with change of refrigerant, the refrigerating oil has been also changed.

Therefore, be sure that water, dust, the former refrigerant or the former refrigerating oil is not mixed into the refrigerating cycle of the air conditioner with new refrigerant during installation work or service work.

If an incorrect work or incorrect service is performed, there is a possibility to cause a serious accident.

Use the tools and materials exclusive to R410A to purpose a safe work.

2. Cautions on Installation/Service

1) Do not mix the other refrigerant or refrigerating oil.

For the tools exclusive to R410A, shapes of all the joints including the service port differ from those of the former refrigerant in order to prevent mixture of them.

2) As the use pressure of the new refrigerant is high, use material thickness of the pipe and tools which are specified for R410A.

3) In the installation time, use clean pipe materials and work with great attention so that water and others do not mix in because pipes are affected by impurities such as water, oxide scales, oil, etc.

Use the clean pipes.

Be sure to brazing with flowing nitrogen gas. (Never use gas other than nitrogen gas.)

4) For the earth protection, use a vacuum pump for air purge.

5) R410A refrigerant is azeotropic mixture type refrigerant.

Therefore use liquid type to charge the refrigerant. (If using gas for charging, composition of the refrigerant changes and then characteristics of the air conditioner change.)

3. Pipe Materials

For the refrigerant pipes, copper pipe and joints are mainly used. It is necessary to select the most appropriate pipes to conform to the standard.

Use clean material in which impurities adhere inside of pipe or joint to a minimum.

1) Copper pipe

<Piping>

The pipe thickness, flare finishing size, flare nut and others differ according to a refrigerant type.

When using a long copper pipe for R410A, it is recommended to select "Copper or copper-base pipe without seam" and one with bonded oil amount 40mg/10m or less. Also do not use crushed, deformed, discolored (especially inside) pipes. (Impurities cause clogging of expansion valves and capillary tubes.)

<Flare nut>

Use the flare nuts which are attached to the air conditioner unit.

2) Joint

The flare joint and socket joint are used for joints of the copper pipe.

The joints are rarely used for installation of the air conditioner.

However clear impurities when using them.

NOTE:

The expression "Air conditioner" described in the REFRIGERANT R410A means "Air Conditioner Fresh Air Intake Indoor Unit".

4. Tools

1. Required Tools for R410A

Mixing of different types of oil may cause a trouble such as generation of sludge, clogging of capillary, etc. Accordingly, the tools to be used are classified into the following three types.

- 1) Tools exclusive for R410A (Those which cannot be used for conventional refrigerant (R22))
- 2) Tools exclusive for R410A, but can be also used for conventional refrigerant (R22)
- 3) Tools commonly used for R410A and for conventional refrigerant (R22)

The table below shows the tools exclusive for R410A and their interchangeability.

Tools exclusive for R410A (The following tools for R410A are required.)

Tools whose specifications are changed for R410A and their interchangeability

No.	Used tool	Usage	R410A air conditioner installation		Conventional air conditioner installation
			Existence of new equipment for R410A	Whether conven- tional equipment can be used	Whether conventional equipment can be used
①	Flare tool	Pipe flaring	Yes	*(Note 1)	Yes
②	Copper pipe gauge for adjusting projection margin	Flaring by conventional flare tool	Yes	*(Note 1)	*(Note 1)
③	Torque wrench	Connection of flare nut	Yes	No	No
④	Gauge manifold	Evacuating, refrigerant charge, run check, etc.	Yes	No	No
⑤	Charge hose				
⑥	Vacuum pump adapter	Vacuum evacuating	Yes	No	Yes
⑦	Electronic balance for refrigerant charging	Refrigerant charge	Yes	Yes	Yes
⑧	Refrigerant cylinder	Refrigerant charge	Yes	No	No
⑨	Leakage detector	Gas leakage check	Yes	No	Yes
⑩	Charging cylinder	Refrigerant charge	(Note 2)	No	No

(Note 1) When flaring is carried out for R410A using the conventional flare tools, adjustment of projection margin is necessary. For this adjustment, a copper pipe gauge, etc. are necessary.

(Note 2) Charging cylinder for R410A is being currently developed.

General tools (Conventional tools can be used.)

In addition to the above exclusive tools, the following equipments which serve also for R22 are necessary as the general tools.

- | | |
|--|---|
| <ol style="list-style-type: none"> 1) Vacuum pump
Use vacuum pump by
attaching vacuum pump adapter. 2) Torque wrench 3) Pipe cutter 4) Reamer 5) Pipe bender 6) Level vial | <ol style="list-style-type: none"> 7) Screwdriver (+, -) 8) Spanner or Monkey wrench 9) Hole core drill 10) Hexagon wrench (Opposite side 4mm) 11) Tape measure 12) Metal saw |
|--|---|

Also prepare the following equipments for other installation method and run check.

- | | |
|--|---|
| <ol style="list-style-type: none"> 1) Clamp meter 2) Thermometer | <ol style="list-style-type: none"> 3) Insulation resistance tester 4) Electro-scope |
|--|---|

1. OUTLINE OF FRESH AIR INTAKE INDOOR UNIT

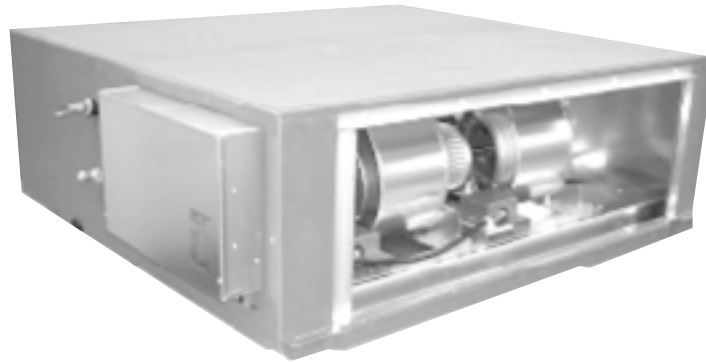

- **Type: Concealed Duct High Static Pressure type**

Three models (5HP, 8HP, 10HP) are prepared.

- **Connectable outdoor unit**

Three series (MMY-APXXXXT8, APXXXXHT8, APXXXXHT7) of Cooling only and Heat pump super modular multi type outdoor unit

- **Corresponding system**

Corresponds to a system in which there are the fresh air intake indoor units and the indoor air conditioners. (For the fresh air intake indoor units, up to 2 units for one system and also within 30% to capacity of the connectable indoor air conditioners are allowed.)

- **Definition**

The fresh air intake indoor unit means an air controller for taken-in fresh air.

Intake of the fresh air often influences on the system so that the normal control of the air conditioner becomes difficult or gives a large load upon air controller and cooling performance.

Therefore it is frequently adopted to handle the fresh air to a certain condition before the fresh air will enter in the main air conditioner.

This handling device is called a fresh air intake indoor unit.

NOTE:

The fresh air intake indoor unit is an air conditioner provided to handle the fresh air load and is not to control the room temperature.

For correspondence to the load of the indoor air controller, set an air conditioner separately.

1-1. S-MMS System Specifications to Connect Fresh Air Intake Indoor Unit

1-1-1. Combination Conditions

The fresh air intake indoor unit is connectable to S-MMS (Super Modular Multi system). However this is not connectable to S-HRM (Super Heat Recovery Multi system).

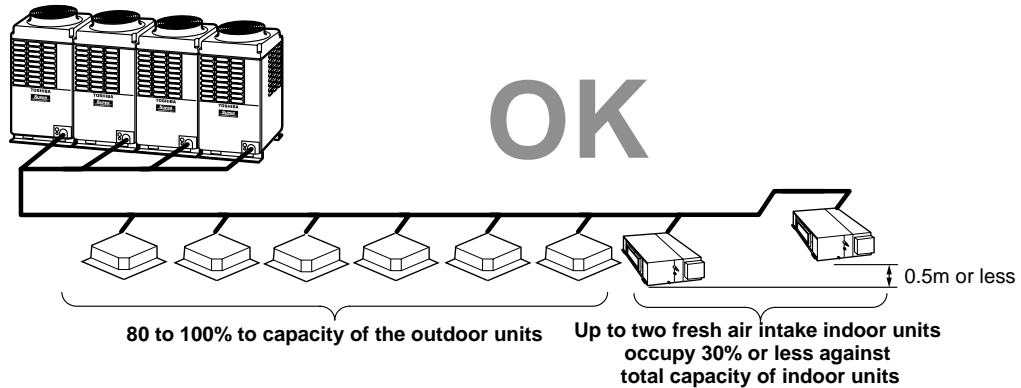

Keep the height difference between the fresh air intake indoor units to 0.5m or less.

- The fresh air intake indoor unit is usually used together with the indoor units on one line of the multi system. The fresh air intake indoor unit only cannot be connected.

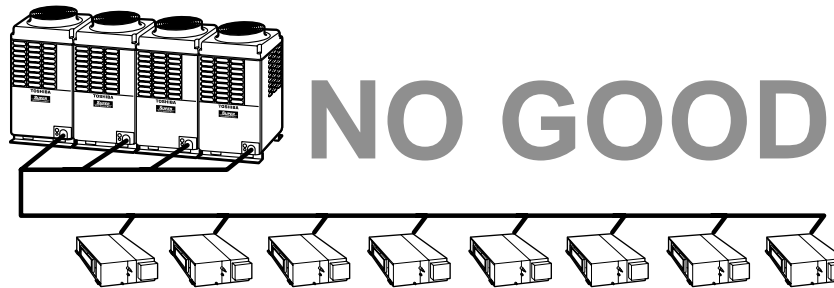

[Installation example of all fresh air intake indoor unit system]

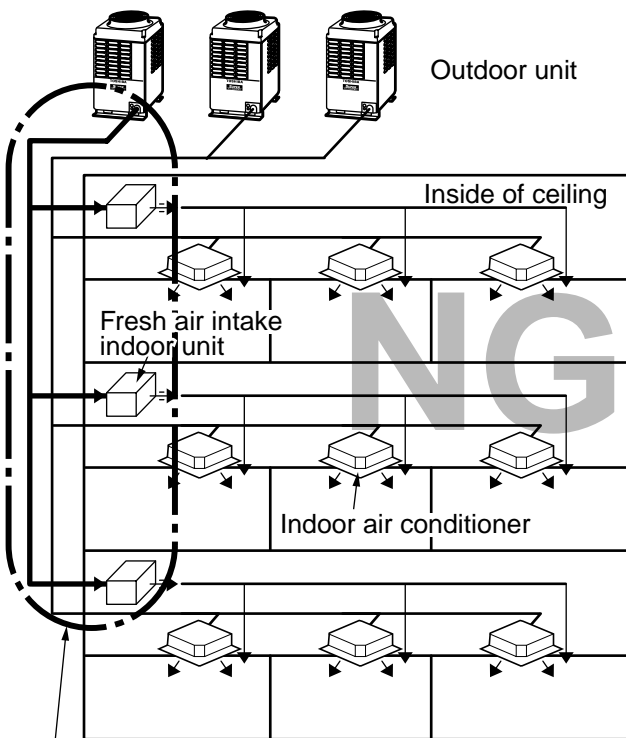

All fresh air intake indoor unit system

[Installation example of intermingled system]

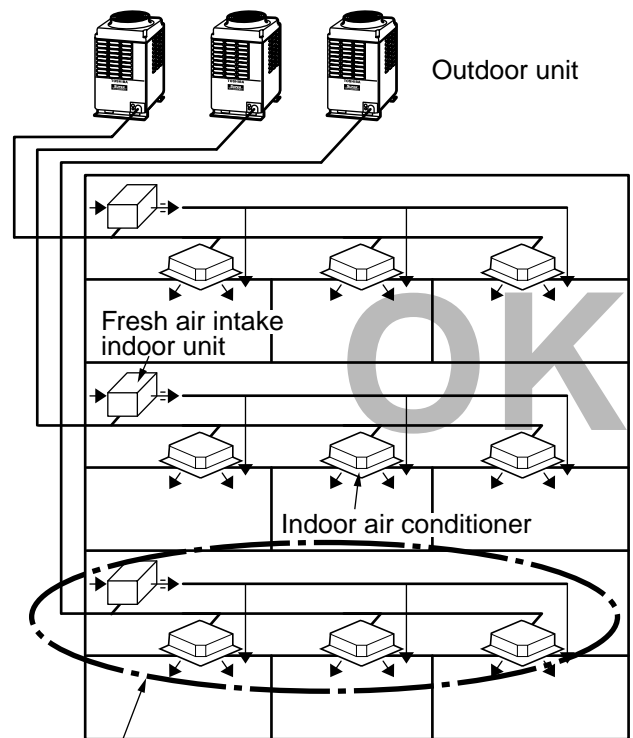

Intermingled system with indoor air conditioner

■ **System able to be combined**

Super Module Multi System (S-MMS)

Cooling only and Heat pump series

Super heat recovery multi and Mini-SMMS cannot be connected.

■ **Range of combination**

- The total capacity of the indoor air conditioners and the fresh air intake indoor units is restricted 80% to 100% against the capacity of the outdoor units.
- Up to two fresh air intake indoor units can be connected on one refrigerant cycle.
- The allowable total capacity of the fresh air intake indoor units shall be 30% or less against the capacity of the indoor air conditioners (including the fresh air intake indoor units).
- The height difference between the fresh air intake indoor units shall be 0.5m or less.

(Example)

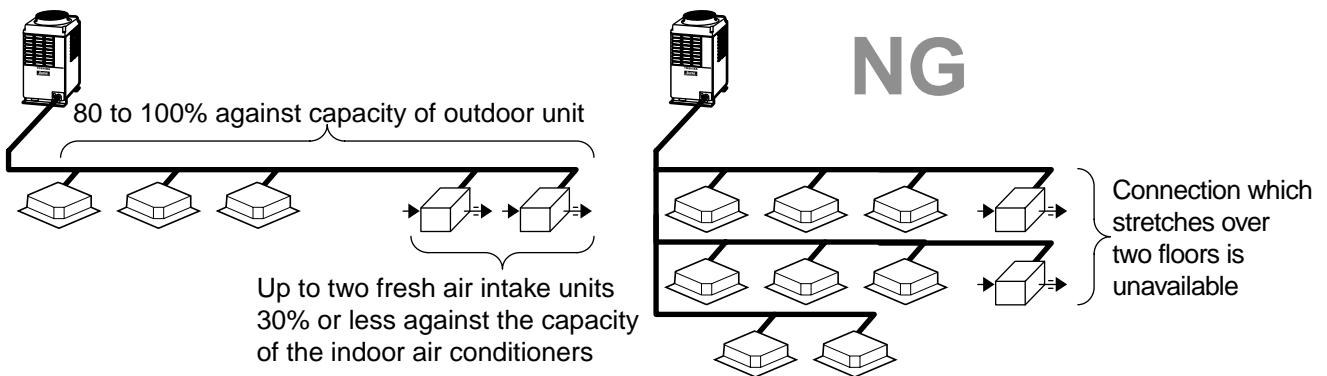

1-1-2. Use Conditions

■ **Use temperature (Suction temperature)**

(*Ts: Setting temp.)

Operation cycle	Outside temp (°C)						
	-10	0	10	20	30	40	50
Cooling cycle			FAN		COOL		
Heating cycle		HEAT		FAN			

COOL: 5 to 43°C; However when suction temp is below 19°C, the mode becomes FAN mode.

When the suction temp is below $T_s + 3^\circ\text{C}$, the mode is also FAN mode.

HEAT: -5 to 43°C; However when suction temp is over 15°C, the mode becomes FAN mode.

When the suction temp is over $T_s - 3^\circ\text{C}$, the mode is also FAN mode.

■ **Operable mode and discharge temp setup range**

Operation mode	At shipment from factory	Setup range
COOL	18°C	16 to 27°C
HEAT	25°C	16 to 27°C

■ **Special mentions**

1. The fan operation of the fresh air intake indoor unit stops during defrosting.
2. When a central controller is used, divide zone setup of indoor air conditioner and fresh air intake unit.
3. The standard is to control the discharge temperature. However the priority is given to the capacity control for the indoor air conditioner in a system in which the normal indoor air conditioner concurrently operated.
4. The fresh air intake indoor unit cannot be connected with remote controller group of the indoor air conditioner.
5. In heating operation, if the outside temperature is below -5°C , the operation stops automatically. (FAN stop) (To protect the refrigerant cycle)
6. In cooling operation, if the outside temperature is below 5°C , the operation stops automatically. (FAN stop)

2. SPECIFICATIONS

2-1. Fresh Air Intake Indoor Unit for S-MMS

Model	Indoor unit	MMD-	AP0481HFE	AP0721HFE	AP0961HFE	
Cooling capacity		(kW)	14	22.4	28.0	
Heating capacity		(kW)	8.9	13.9	17.4	
Power supply	Single phase 230V (220 – 240V) 50Hz / 220V 60Hz					
Electrical characteristics	Cooling	Running current	(A)	1.43 / 1.66	2.52 / 2.75	2.73 / 3.12
		Power consumption	(kW)	0.28 / 0.34	0.45 / 0.55	0.52 / 0.65
		Power factor	(%)	85 / 93	78 / 91	83 / 95
	Heating	Running current	(A)	1.43 / 1.66	2.52 / 2.75	2.73 / 3.12
		Power consumption	(kW)	0.28 / 0.34	0.45 / 0.55	0.52 / 0.65
		Power factor	(%)	85 / 93	78 / 91	83 / 95
Appearance	Main unit	Zinc hot dipping steel plate				
Outer dimension	Main unit	Height	(mm)	492	492	492
		Width	(mm)	892	1392	1392
		Depth	(mm)	1262	1262	1262
Total weight	Main unit	(kg)	93	144	144	
Heat exchanger	Finned tube					
Fan unit	Fan		Centrifugal	Centrifugal	Centrifugal	
	Standard air flow	H/M/L	(m ³ /min)	18	28	35
	Motor			(W)	160	160 + 160
Air filter	TCB-		UFM4D-1E UFH8D-1E	UFM3DE UFH7DE	UFM3DE UFH7DE	
Controller (Sold separately)	RBC-AMT31E, AS21E2, TCB-SC642TLE2, TCB-CC163TLE2					
Connecting pipe	Gas side	(mm)	15.9	22.0	22.0	
	Liquid side	(mm)	9.5	12.7	12.7	
	Drain port	(mm)	VP25			
Sound pressure level	H/M/L	(dB•A)	45 / 43 / 41	46 / 45 / 44	46 / 45 / 44	

3. SPECIFICATIONS OF ELECTRICAL PARTS

3-1. Fresh Air Intake Indoor Unit for S-MMS

MMD-AP0481HFE, MMD-AP0721HFE, MMD-AP0961HFE

Model	MMD-AP0481HFE	MMD-AP0721HFE, MMD-AP0961HFE
Fan motor	STF200-160-4AR	
Running capacitor for fan motor	400V 6 μ F	400V 4 μ F
Transformer	TT13	
TA sensor	Lead wire length: 1200mm	Lead wire length: 818mm
TF sensor	Lead wire length: 2500mm	
TC1 sensor	Ø4 size, Lead wire length: 1200mm, Vinyl tube (Blue)	Ø4 size, Lead wire length: 2000mm, Vinyl tube (Blue)
TC2 sensor	Ø6 size, Lead wire length: 1200mm, Vinyl tube (Black)	Ø6 size, Lead wire length: 2000mm, Vinyl tube (Black)
TCJ sensor	Ø6 size, Lead wire length: 1200mm, Vinyl tube (Red)	Ø6 size, Lead wire length: 2000mm, Vinyl tube (Red)
Pulse motor	EDM-MD12TF-3	
Electronic control valve	EDM-B60YGTF-1	EDM-BAOYGTF-1

4. OWNER'S MANUAL

PARTS NAME

Fresh air Intake indoor unit

MMD-AP0481HFE, MMD-AP0721HFE, MMD-AP0961HFE

Air supply port

Cools/heats the fresh air and sends it into the room with the air supply flange.

Air intake port

Intakes the fresh air with the inlet flange.

Air supply sensor

Drain pan

Earth screw

It is included in the electric parts box.

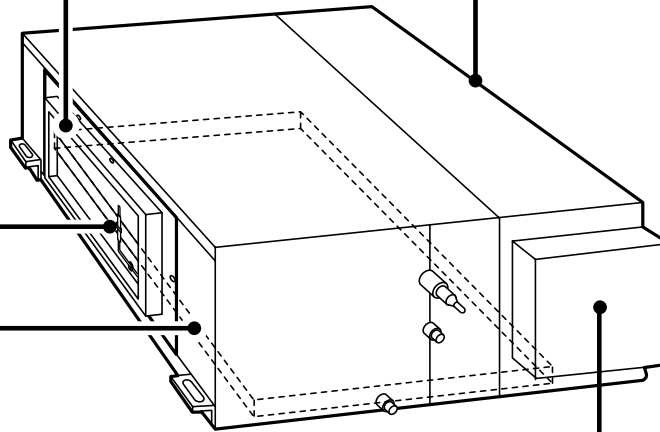

PARTS NAME OF REMOTE CONTROLLER

This remote controller can singly operate maximum 8 indoor units. However one remote controller cannot operate the fresh air intake indoor unit air conditioner together with the indoor units for air conditioner. If the operation contents have been set up once, the air conditioner can be operated according to the setup contents by pushing only ON/OFF button.

The two fresh air intake indoor units at the maximum can be connected to one refrigerating cycle.

Display section

All display items are shown in right figure for the explanation.

Only selected contents are displayed in actual operation.

- When turning on the leakage breaker at the first time, [SET DATA] flashes on the display part of the remote controller.

While this display is flashing, the model is being automatically confirmed. Accordingly, wait for a while after [SET DATA] display has disappeared, and then use the remote controller.

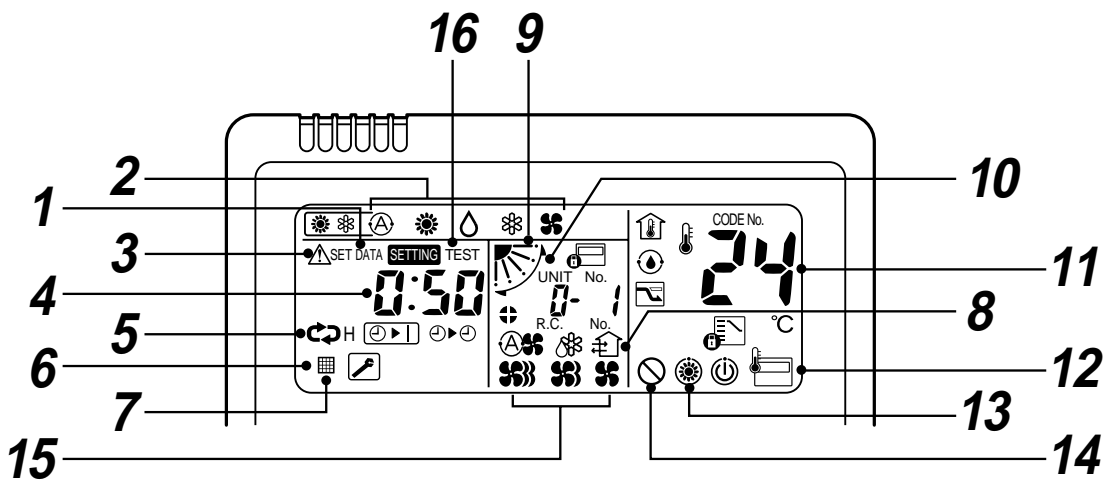
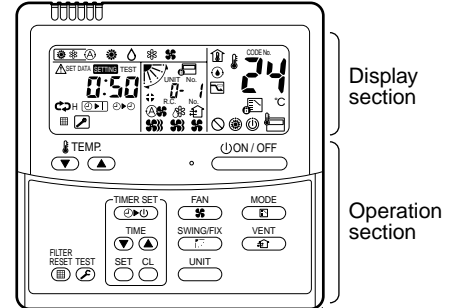

- | | |
|---|--|
| <p>1 SET DATA display
Displayed during setup a timer.</p> <p>2 Operation mode display (HEAT, COOL, FAN)
The selected operation mode is displayed.</p> <p>3 CHECK display
Displayed while the protective device works or a trouble occurs.</p> <p>4 Timer time display
Set time by the timer is displayed.
(When a trouble occurs, the check code is displayed.)</p> <p>5 Timer SETIN setup display
When pushing the Timer SET button, the display of the timer is selected in order of [OFF] [ON] → [OFF] repeat OFF timer → [ON] → No display.</p> <p>6 Filter display
If "FILTER" is displayed, clean the air filter.</p> <p>7 UP/DOWN grille display (*)</p> <p>8 Ventilator operation display</p> <p>9 Louver position display (*)</p> | <p>10 SWING display (*)</p> <p>11 Set up temperature display
The selected setup supply air temp. is displayed.</p> <p>12 Remote controller sensor display (*)</p> <p>13 PRE-HEAT display
Displayed when the heating operation starts or defrosts operation is carried out.
While this indication is displayed, the indoor fan stops.</p> <p>14 No function display
Displayed if there is no function even if the button is pushed.</p> <p>15 Fan mode display
The air conditioner with the fresh air intake indoor unit displays (HIGH) only.</p> <p>16 TEST run display
Displayed during a test run.</p> |
|---|--|

* This function is not provided to an air conditioner with fresh air intake indoor unit.

Operation section

Push each button to select a desired operation.

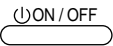
- The details of the operation needs to be set up once, the same states are used by pushing  button.

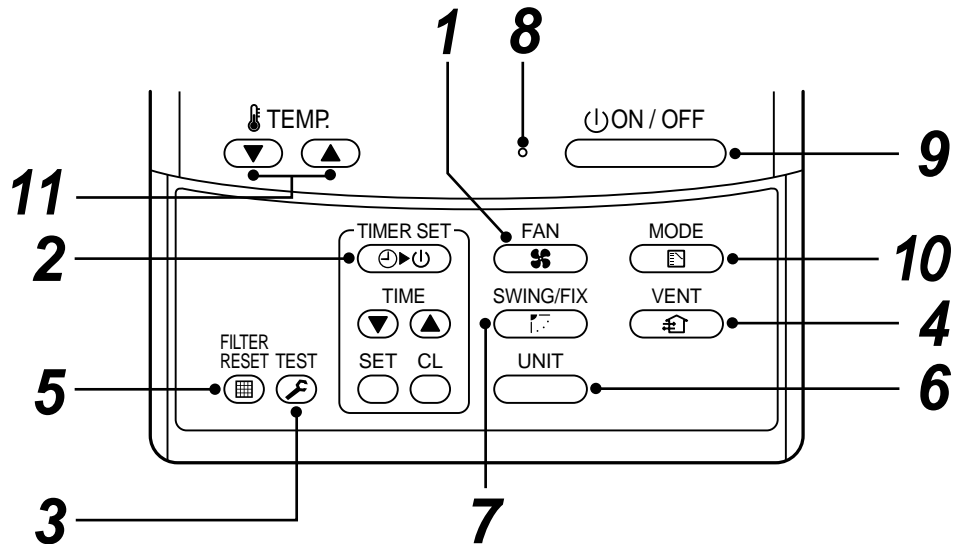

1 Fan mode button

The fresh air intake indoor unit operates in (HIGH)  mode only.

2 Timer set button

TIMER SET button is used when the timer is set up.

3 Check button

CHECK button is used for check operation. During normal operation, do not use this button.

4 Fan button

FAN button is used when a fan that is sold on the market or etc. is connected.

- When "No function  " is displayed on the remote controller even if pushing the FAN button it means that a fan is not connected.

5 Filter reset button

Resets (Erases) "FILTER  " display.

6 Unit button

7 SWING/FIX button

No function

8 Operation lamp

Lamp is lit during the operation.

Lamp is off when stopped.

It flashes when operating a protection device or abnormal occurred.

9 button

When the button is pushed, operation starts, and it stops by pushing the button again.

When the operation stops, the operation lamp and all displays disappear.



10 Operation select button (HEAT, COOL, FAN)

Selects operation mode.

11 Set up temperature button

Adjusts temperature of the supply air.

Set required set temperature by pushing

 or .

CORRECT USAGE

When you use the air conditioner for the first time or when you change SET DATA value, follow the procedure below.

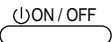
From the next time, the operation will start as set state by pushing the  button.

Preparation

Turn on the main power switch and/or the leakage breaker.

- When the power supply is turned on, display section is displayed on the remote controller.
- * After the power supply is turned on, the remote controller does not accept an operation for approx. 1 minute, but it is not a failure.

REQUIREMENT

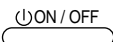
- While using the air conditioner, operate it only with  button without turning off the main power switch and the leakage breaker.
- When starting the operation after stop for a long time, turn on the main power switch for 12 hours or more before start. (This is required to turn on the compressor case heater for warming in order to prevent overload on the compressor when activating the outdoor unit.)

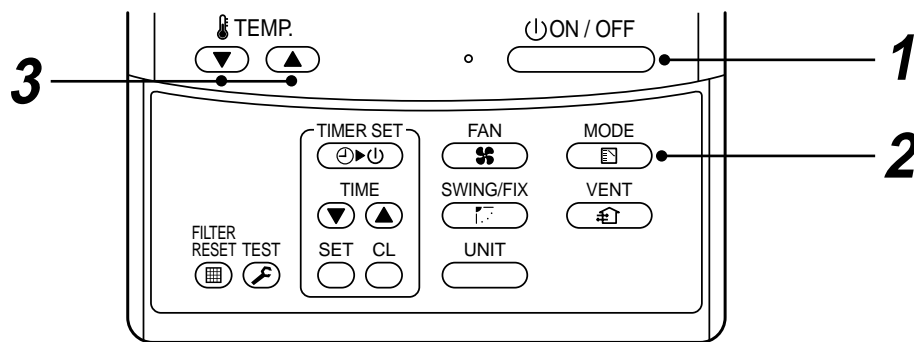

1 Push button.

The operation lamp goes on, and the operation starts.

- After HEAT operation stopped, FAN operation may continue for approx. 30 seconds.

2 Select an operation mode with the “MODE ” button.

One push of the button, in each time the display changes in the order shown on the right.

- In the defrost mode, the fan stops so that cool air is not discharged and PRE-DEF  is displayed.

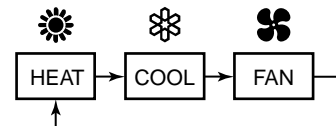

3 Determine the set up temperature by pushing the “TEMP. ” or “TEMP. ” button.

4 Stop Push button.

The operation lamp goes off, and the operation stops.

Operation mode	Setting range	At shipment from factory
COOL	16 to 27°C	18°C
HEAT		25°C

Operation mode and Function

COOL : Cools the fresh air and sends it into the room

HEAT : Heats the fresh air and sends it into the room

FAN : Sends the fresh air as it is

- The air conditioner with the fresh air intake indoor unit controls temperature of the supply air so that it is close to the setup temperature of the remote controller.

However temperature of the supply air may not be close to the setup temperature according to temperature of the fresh air or the operation condition of the indoor units for air conditioning in one refrigerant cycle.

REQUIREMENT

- The fresh air intake indoor unit cannot control the room temperature.
- For control of the room temperature, an indoor unit for air conditioning is required separately.

Use Conditions

- In COOL mode, if temperature of the fresh air is under the setup temp. +3°C, FAN status is automatically made. When temperature of the fresh air is under 19°C, FAN status is also made regardless of the setup temperature.
- In HEAT mode, if temperature of the fresh air is over the setup temp. -3°C, FAN status is automatically made. When temperature of the fresh air is over 15°C, FAN status is also made regardless of the setup temperature.

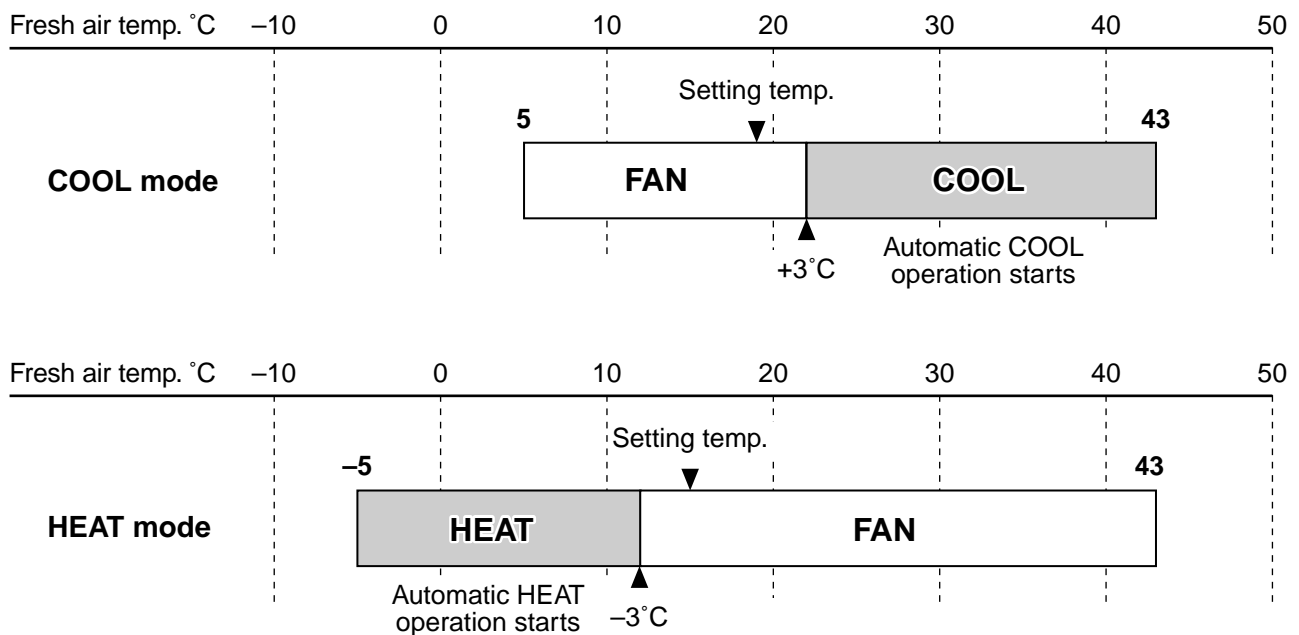

REQUIREMENT

- In "COOL" or "FAN" mode, if temperature of the fresh air is under 5°C, the operation stops automatically in order to protect the equipment.
In this case, continue the operation by selecting "HEAT" mode.
- In "HEAT" mode, if temperature of the fresh air is under -5°C, the operation stops automatically in order to protect the equipment.

TIMER OPERATION

A type of timer operation can be selected from the following three types.

OFF timer : The operation stops after the set time has passed.

Repeat OFF timer : Every time, the operation stops after the set time has passed.

ON timer : The operation starts after the set time has passed.

Timer operation

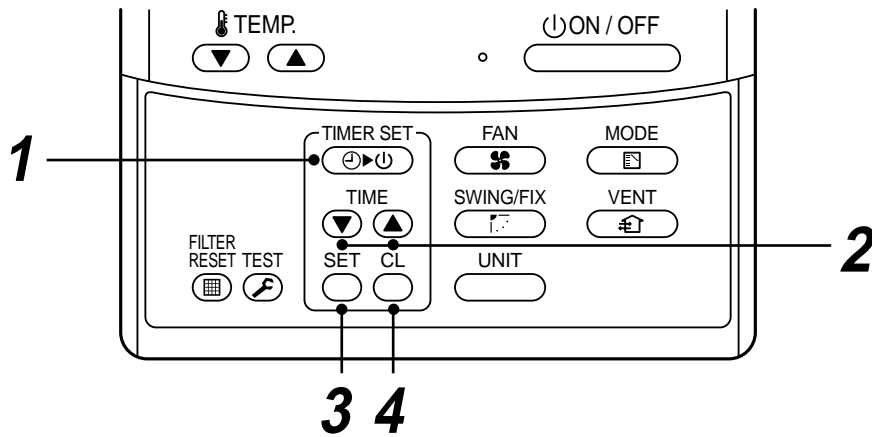

1 Push TIMER SET button.

- The timer display (type) changes every push of the button.
- SET DATA and timer time displays flash.

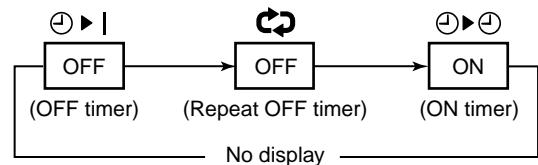

2 Push TIME to select "SET TIME".

For every push of \blacktriangle button, the set time increases in the unit of 0.5 hr (30 minutes).

The maximum set time is 168 hr.

For every push of \blacktriangledown button, the set time decreases in the unit of 0.5 hr (30 minutes).

The minimum set time is 0.5 hr.

3 Push SET button.

- **SETTING** display disappears and timer time display goes on.
(When ON timer is activated, timer time, ON timer ON are displayed and other displays disappear.)

Clear of timer operation

4 Push CL button.

- TIMER display disappears.



NOTICE

- "Repeat OFF timer" set once resumes. So start again, stop by same timer.
For cancel timer, push CL button.

5. INSTALLATION MANUAL

Accessory parts and Parts to be procured locally

Accessory parts

Part name	Q'ty	Shape	Usage
Installation Manual	1	This manual	(Be sure to hand over to customers)
Heat insulator	1		For heat insulation of Gas pipe connecting section
	1		For heat insulation of Liquid pipe connecting section
	4		For heat insulation of hanging bracket (AP048)
	4		For heat insulation of hanging bracket (AP072, AP096)

<Separate sold parts>

Part name	Q'ty	Shape	Remarks
Standard wired remote controller	1		Model: RBC-AMT31E

NOTE : Never use a wireless type remote controller even if you have one; otherwise the air conditioner may malfunction.

1 PRECAUTIONS FOR SAFETY

- Ensure that all Local, National and International regulations are satisfied.
- Read this "PRECAUTIONS FOR SAFETY" carefully before Installation.
- The precautions described below include the important items regarding safety. Observe them without fail.
- After the installation work, perform a trial operation to check for any problem.
Follow the Owner's Manual to explain how to use and maintain the unit to the customer.
- Turn off the main power supply switch (or breaker) before the unit maintenance.
- Ask the customer to keep the Installation Manual together with the Owner's Manual.

CAUTION

New Refrigerant Air Conditioner Installation

- **THIS AIR CONDITIONER ADOPTS THE NEW HFC REFRIGERANT (R410A) WHICH DOES NOT DESTROY OZONE LAYER.**

The characteristics of R410A refrigerant are ; easy to absorb water, oxidizing membrane or oil, and its pressure is approx. 1.6 times higher than that of refrigerant R22. Accompanied with the new refrigerant, refrigerating oil has also been changed. Therefore, during installation work, be sure that water, dust, former refrigerant, or refrigerating oil does not enter the refrigerating cycle.

To prevent charging an incorrect refrigerant and refrigerating oil, the sizes of connecting sections of charging port of the main unit and installation tools are changed from those for the conventional refrigerant.

Accordingly the exclusive tools are required for the new refrigerant (R410A).

For connecting pipes, use new and clean piping designed for R410A, and please care so that water or dust does not enter. Moreover, do not use the existing piping because there are problems with pressure-resistance force and impurity in it.

CAUTION

To Disconnect the Appliance from Main Power Supply.

This appliance must be connected to the main power supply by means of a switch with a contact separation of at least 3 mm.

1 PRECAUTIONS FOR SAFETY

WARNING

- **Ask an authorized dealer or qualified installation professional to install/maintain the air conditioner.**
Inappropriate installation may result in water leakage, electric shock or fire.
- **Turn off the main power supply switch or breaker before attempting any electrical work.**
Make sure all power switches are off. Failure to do so may cause electric shock.
- **Connect the connecting wire correctly.**
If the connecting wire is connected in a wrong way, electric parts may be damaged.
- **Be sure to connect the earth wire.**
When the earth work is incomplete, an electrical shock may be caused.
(Never connect the earth wire to gas pipe, water pipe, lightning rod, earth wire of telephone, and etc.)
- **When moving the air conditioner for the installation into another place, be very careful not to enter any gaseous matter other than the specified refrigerant into the refrigeration cycle.**
If air or any other gas is mixed in the refrigerant, the gas pressure in the refrigeration cycle becomes abnormally high and it as a result causes pipe burst and injuries on persons.
- **Do not modify this unit by removing any of the safety guards or by by-passing any of the safety interlock switches.**
- **Exposure of unit to water or other moisture before installation may cause a short-circuit of electrical parts.**
Do not store it in a wet basement or expose to rain or water.
- **After unpacking the unit, examine it carefully if there are possible damage.**
- **Hold the hanging brackets (4 positions) and do not apply force to other parts, especially the refrigerant pipe or the drain pipe.**
- **Do not install in a place that might increase the vibration of the unit.**
- **To avoid personal injury (with sharp edges), be careful when handling parts.**
- **Perform installation work properly according to the Installation Manual.**
Inappropriate installation may result in water leakage, electric shock or fire.
- **When the air conditioner is installed in a small room, provide appropriate measures to ensure that the concentration of refrigerant leakage occur in the room does not exceed the critical level.**
- **Install the air conditioner securely in a location where the base can sustain the weight adequately.**
- **Perform the specified installation work to guard against an earthquake.**
If the air conditioner is not installed appropriately, accidents may occur due to the falling unit.
- **If refrigerant gas has leaked during the installation work, ventilate the room immediately.**
If the leaked refrigerant gas comes in contact with fire, noxious gas may generate.
- **After the installation work, confirm that refrigerant gas does not leak.**
If refrigerant gas leaks into the room and flows near a fire source, such as a cooking range, noxious gas might generate.
- **Electrical work must be performed by a qualified electrician in accordance with the Installation Manual. Make sure the air conditioner uses an exclusive power supply.**
An insufficient power supply capacity or inappropriate installation may cause fire.
- **Use the specified wires for wiring connect the terminals securely fix.**
To prevent external forces applied to the terminals from affecting the terminals.
- **Conform to the regulations of the local electric company when wiring the power supply.**
Inappropriate grounding may cause electric shock.
- **Do not install the air conditioner in a location subject to a risk of exposure to a combustible gas.**
If a combustible gas leaks, and stays around the unit, a fire may occur.

2 SYSTEM CONTROL OF FRESH AIR INTAKE INDOOR UNIT

System able to be combined

The fresh air intake indoor unit is connectable to S-MMS (Super Modular Multi system). However this is not connectable to S-HRM (Super Heat Recovery Multi system and Mini-SMMS).

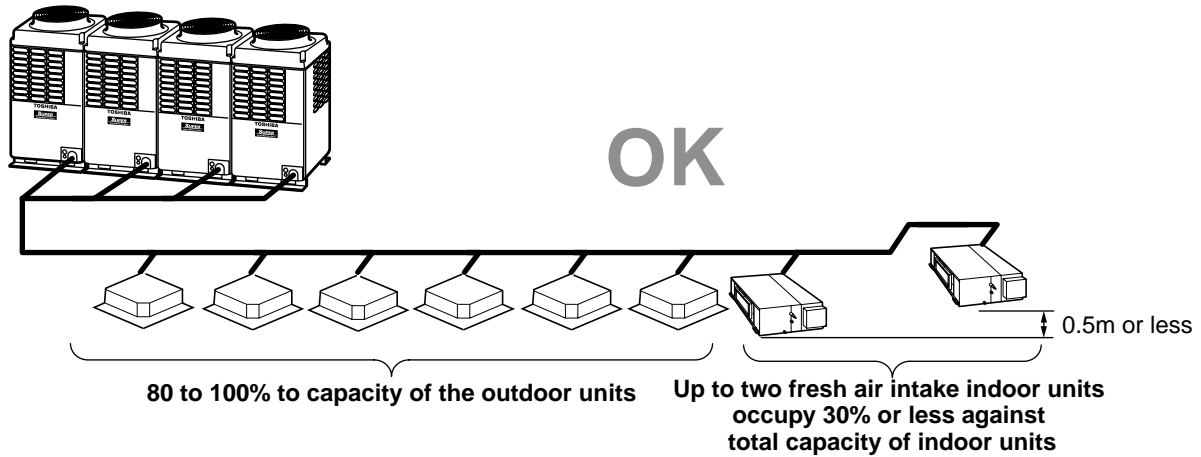

Keep the height difference between the fresh air intake indoor units to 0.5m or less.

- The fresh air intake indoor unit is usually used together with the indoor units on one refrigerant cycle of the multi system. The fresh air intake indoor unit only cannot be connected.

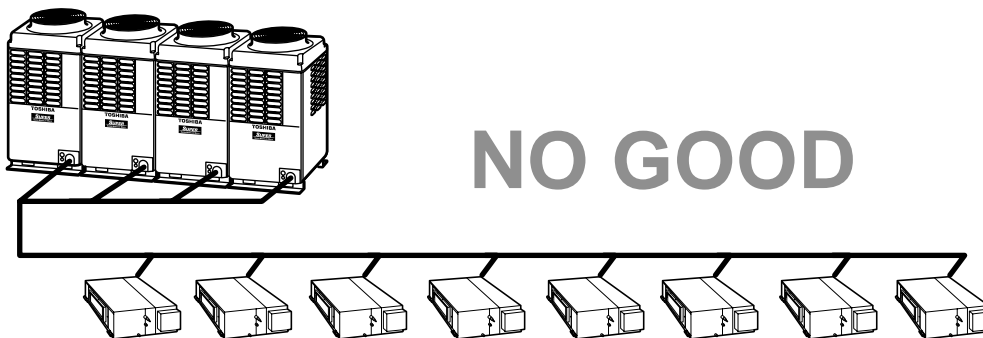

- The total capacity of the indoor units and the fresh air intake indoor units is restricted to 80% to 100% against the capacity of the outdoor units. (This restriction should be strictly kept for correct control of the refrigerant.)
- Up to two fresh air intake units can be connected on one line of the multi system. The allowable total capacity of the two fresh air intake indoor units shall be 30% or less against the total capacity of the indoor units (including the fresh air intake indoor units).

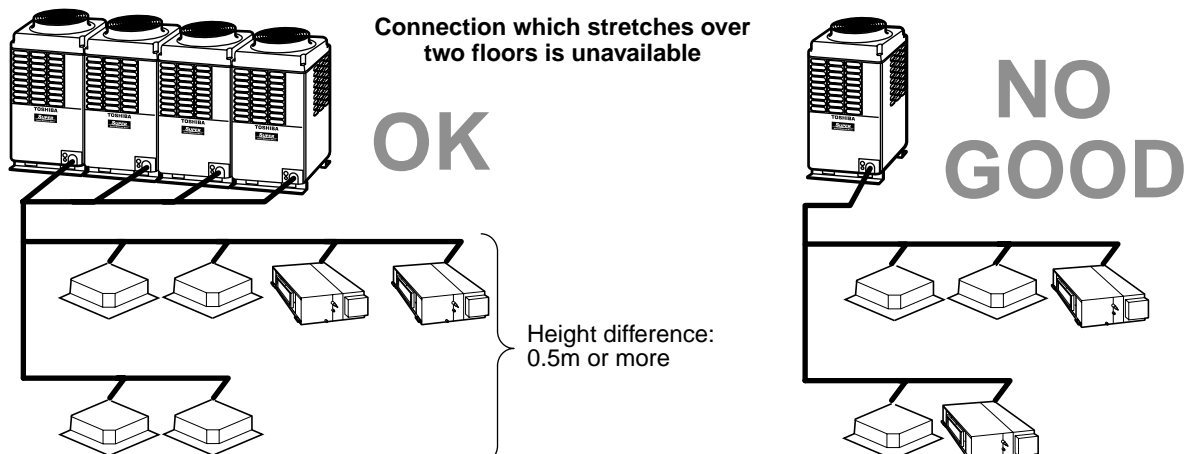

3 SELECTION OF INSTALLATION PLACE

WARNING

- **Install the air conditioner at enough strong place to withstand the weight of the unit.**
If the strength is not enough, the unit may fall down resulting in injury.
- **Install the air conditioner at a height 2.5m or more from the floor.**
If you insert your hands or others directly into the unit while the air conditioner operates, it is dangerous because you may contact with revolving fan or active electricity.

CAUTION

Upon approval of the customer, install the air conditioner in a place that satisfies the following conditions.

- Place where the unit can be installed horizontally.
- In the process after removing the ceiling panel, it important to reinforce the groundwork (framework) and keep a level correctly of the existing ceiling to prevent vibration of the ceiling panel.
- Place where a sufficient servicing space can be ensured for safety maintenance and check.
- Place where drained water will not cause any problem.

Avoid installing in the following places.

- Place exposed to air with high salt content (seaside area), or place exposed to large quantities of sulfide gas (hot spring). (Should the unit be used in these places, special protective measures are needed.)
- Place exposed to oil, vapor, oil smoke or corrosive gas.
- Place where organic solvent is used nearby.
- Place close to a machine generating high frequency or place such as a factory where the voltage frequently varies.
- Place where the discharged air blows directly into the window of the neighboring house. (For outdoor unit)
- Place where noise of the outdoor unit is easily transmitted. (When installing the air conditioner on the boundary with the neighbor, pay due attention to the level of noise.)
- Place with poor ventilation.
(Before air ducting work, check whether value of air volume, static pressure and duct resistance are correct.)
- Do not install this air conditioner on a vessel or a vehicle (including train).
(To avoid a trouble caused by vibration and so on)
- Do not install the fresh air intake indoor units at outdoors or under the eaves.

Installation space

Keep the space necessary for installation and service.

REQUIREMENT

1. Before installation of the unit, mount the accessories sold separately (Drain-up kit, etc.) to the unit.
In addition to the air inlet panel, set also the check port at the side face.
2. The check port should be 600 × 600mm.

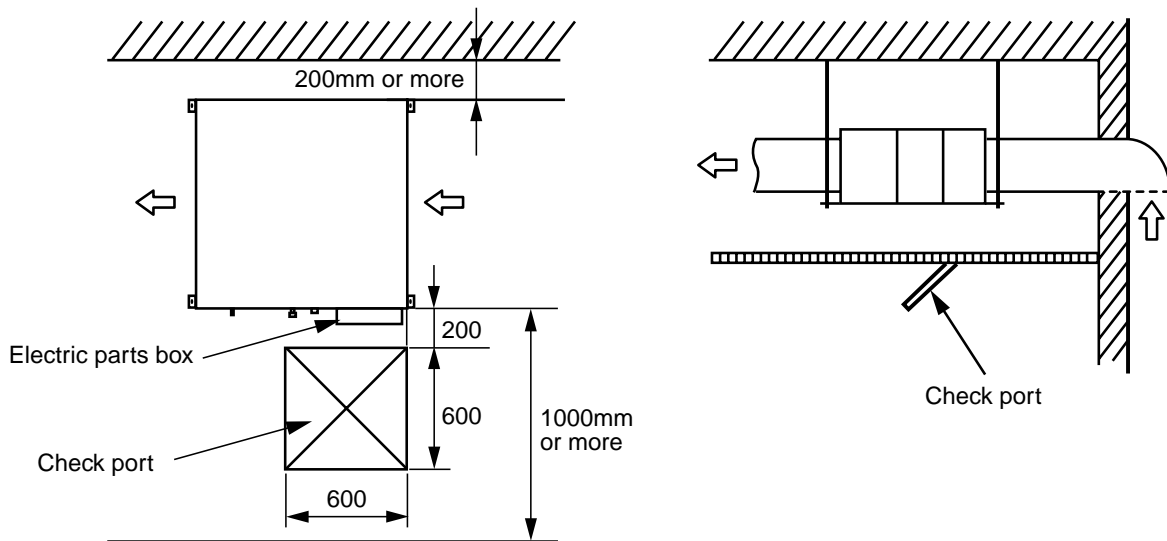

Installation under atmosphere of the high humidity

Although it has been confirmed that no trouble occurs on the unit, there is a fear of drip of the water if operation under high humidity condition continues.

In some cases including the rainy season, especially inside of the ceiling may become high-humidity atmosphere (dew-point temperature: 30°C (humidity: 80%) or higher).

1. Installation to inside of the ceiling with tiles on the roof
2. Installation to inside of the ceiling with slated roof
3. Installation to a place where inside of the ceiling is used for pathway.
 - In the above cases, additionally attach the thermal insulator (Glass wool, etc.) to all positions of the air conditioner, which come to contact with the high-humidity atmosphere.
In this case, arrange the side plate (Service plate) so that it is easily removed.
 - Apply also a sufficient thermal thickness 10mm or more to the duct and connecting part of the duct.

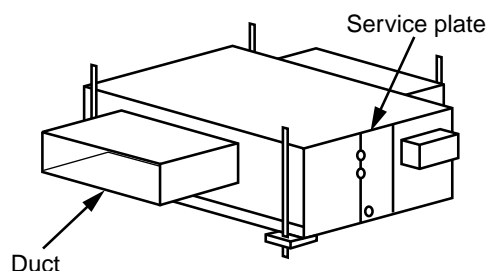

4 INSTALLATION OF INDOOR UNIT

⚠ WARNING

Install the air conditioner certainly to sufficiently withstand the weight.
 If the strength is insufficient, the unit may fall down resulting in human injury.
 Perform a specified installation work to guard against strong wind or earthquake.
 An incomplete installation can cause accidents by the units falling and dropping.

REQUIREMENT

Strictly comply with the following rules to prevent damage of the indoor units and human injury.

- Do not put a heavy article on the indoor unit. (Even units are packaged)
- Carry in the indoor unit as it is packaged if possible.
 If carrying in the indoor unit unpacked by necessity, be sure to use buffering cloth, etc. to not damage the unit.
- To move the indoor unit, hold the hooking metals (4 positions) only.
 Do not apply force to the other parts (refrigerant pipe, drain pan, foamed parts, or resin parts, etc.).
- Carry the package by two or more persons, and do not bundle it with PP band at positions other than specified.

External view

Installing the four 10mm-diameter hanging bolts

- Space the hanging bolts according to the dimensions shown in the diagrams below.
- Use 10mm-diameter hanging bolts (Required at the site).

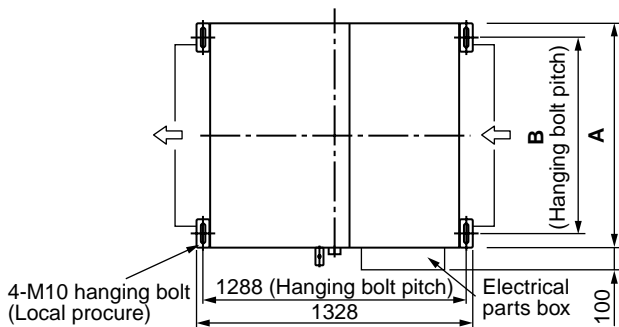

• Wired remote controller (RBC-AMT31E)

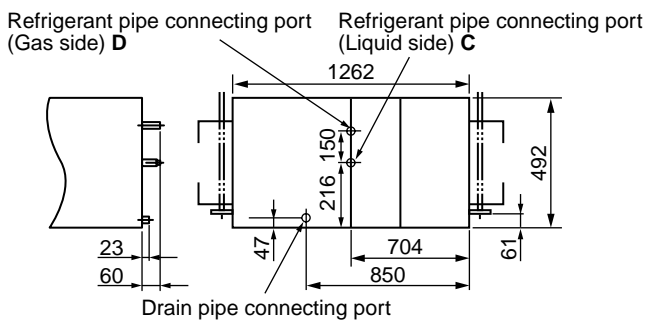
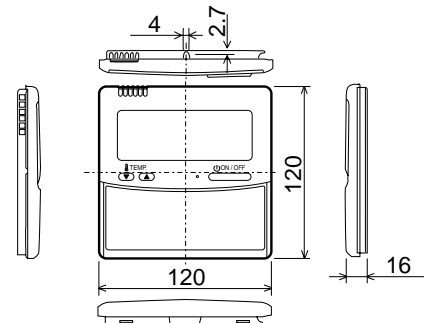

Considering piping and wire connecting works in the ceiling after hanging down the indoor unit, select an installation place and then determine the drawing-out direction of the pipes.

- If the ceiling has been already set, draw the refrigerant pipe, drain pipe, inter-unit wire between indoor and outdoor units, central control system wire and remote controller cord up to the positions where pipes and wires are connected before hanging down the indoor unit.
- Install the indoor unit/outdoor unit and also arrange the power supply wiring, connecting wiring and remote controller wiring 1m apart from the television and the radio in order to avoid image turbulence and noise.

Model MMD-	A	B	C	D
AP0481HFE	892	810	Ø9.5 flare	Ø15.9 flare
AP0721HFE AP0961HFE	1392	1260	Ø12.7 flare	Ø22.2 brazing

Mounting of the remote controller (Sold separately)

For mounting of the remote controller, refer to the Installation manual attached to the remote controller.

- Do not place the remote controller in the direct sunlight or at place near a heater.

Installation of hanging bolt

Use M10 hanging bolts (4 pcs, to be local procure).

Matching to the existing structure, set pitch according to size in the unit external view as shown below.

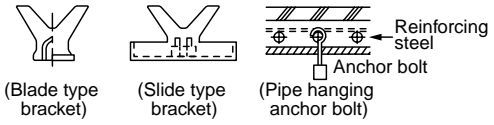
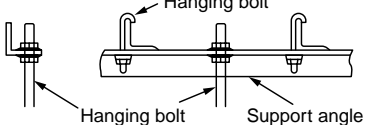
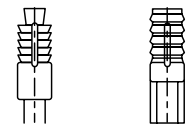
New concrete slab	Steel frame structure	Existing concrete slab
Install the bolts with insert brackets or anchor bolts.  (Blade type bracket) (Slide type bracket) (Pipe hanging anchor bolt)	Use existing angles or install new support angles.  Hanging bolt Support angle	Use a hole-in anchors, hole-in plugs, or a hole-in bolts. 

Preparation before installation

1. Check positional relation of the check port, unit, and hanging bolt.
2. Punch an opening hole for installation. (In case of existing ceiling)
 - * Punch an opening hole on the ceiling of installation, and perform unit piping, piping until the wiring connecting port (refrigerant, water supply, drain) and wiring work (power supply, connecting wiring, remote controller wiring).
3. Mount the hanging bolt. (Hanging bolt size: Use M10.)

Hanging up of unit

CAUTION

This unit is incorporated with drain pump and float switch. Never incline the main unit. Otherwise, malfunction of the float switch may be caused resulting in water leakage.

- Adjust the nut position (lower side).
- Hang up the main unit by hanging nut of hanging bolt to T groove of hanging bracket of the indoor unit.
- Using the level vial, etc., check that four sides are horizontal. (Horizontal degree: within 5mm)
- Attach canvas ducts (procured locally) to the air inlet and the air outlet so that vibration of the main unit does not travel to the duct or ceiling. Attach also acoustic-absorption material to the inner liner of the duct and the vibration-proof rubber to the hanging bolt.

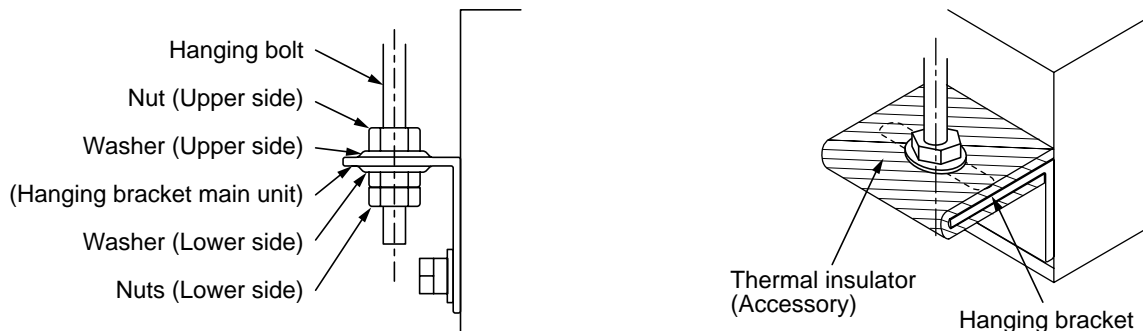

REQUIREMENT

- Using a level vial, etc., confirm the horizontal level of the indoor unit.
- Tighten the nut sufficiently, and fix it securely.

4 INSTALLATION OF INDOOR UNIT

Installation of indoor unit

1. Install temporarily the indoor unit.
 - Attach the hanging bracket to the hanging bolt. Be sure to fix the hanging bracket from both up and down sides of the hanging bracket by using the nuts (M10 procured locally) and the washer.
2. Using nut, adjust height of the main unit.
3. Check the main unit is horizontally installed.
 - Attach canvas ducts (procured locally) to the air inlet and the air outlet so that vibration of the main unit does not travel to the duct or ceiling. Attach also acoustic-absorption material to the inner liner of the duct and the vibration-proof rubber to the hanging bolt.

Thermal insulation

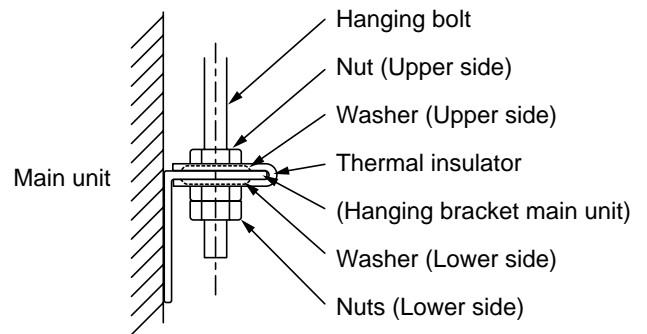

CAUTION

Make sure that the unit is hanging level.

If it is hung horizontally, the drain pan may overflow. Install the unit within the dimensions indicated below.

Front view

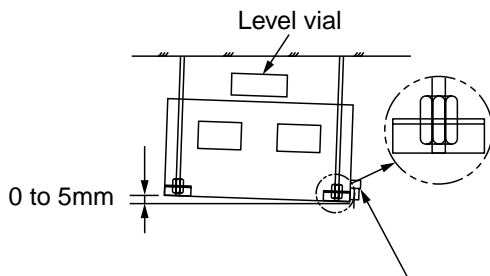

Install the main unit within 5mm while lowering the drain pipe connecting port side slightly.

Side view

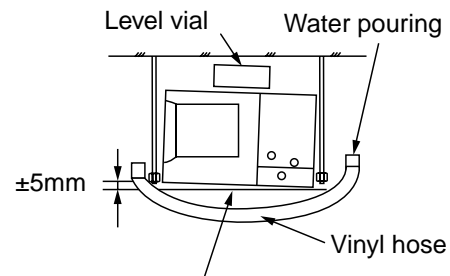

Install both air inlet and air supply port sides within $\pm 5\text{mm}$.

Using a level vial or vinyl hose, check whether the indoor unit is hung horizontally or not.

5 DUCT WORK

CAUTION

Be sure to apply heat insulation to the duct to prevent dewy condition.
If there is an incomplete duct work, the water leakage into the room may happen.

REQUIREMENT

- In order to prevent short circuits, design the duct work so that the intake and discharge openings are not adjacent to each other.
- If no air filter is installed, dust will collect in the heat exchanger, which may cause the air conditioner to fail or to leak. (Local procure)
- Set a filter chamber at air inlet side of the unit.
For a filter chamber, select an air filter with 50% or more (by weighing method) of dust collection efficiency.
- Be sure to set the duct at air inlet side with descending inclination because the suction duct of the this unit is exposed to outdoors and therefore rainwater, leaves and birds are easy to enter in if it is set horizontally. Attaching wire netting and others to end of the suction duct is also recommended.
- Connect the duct so that the air inlet sucks fresh air only.
Be sure to apply heat insulation for the duct to prevent dewing.
(Recommended material: Glass wool or foam polyethylene, Thickness: 25mm)
- When welding the duct at the site, sparks may enter in the air filter or thermal insulator.
To avoid spread of the fire, cover the duct with iron plate, etc.
- When penetrating metal lath, wire lath or metal plank with the metal duct, isolate the duct from the wall electrically.
- Set the canvas ducts at air inlet port and air supply port. It is to avoid conveyance of vibration, abnormal resonance sound and also to make easy the disassembly of the main unit in service time.
- Connect the ducts so that the ducts do not weight on the main unit.
If connecting the ducts directly to the main unit, the duct vibration abnormal sound from the main unit may happen, and also the filter and service panel cannot be detached.

- **Be sure to fix the ducts by using the hanging bolts.**

<Overview of duct connection>

NOTE : Parts except the fresh air intake indoor unit are to be locally procured.

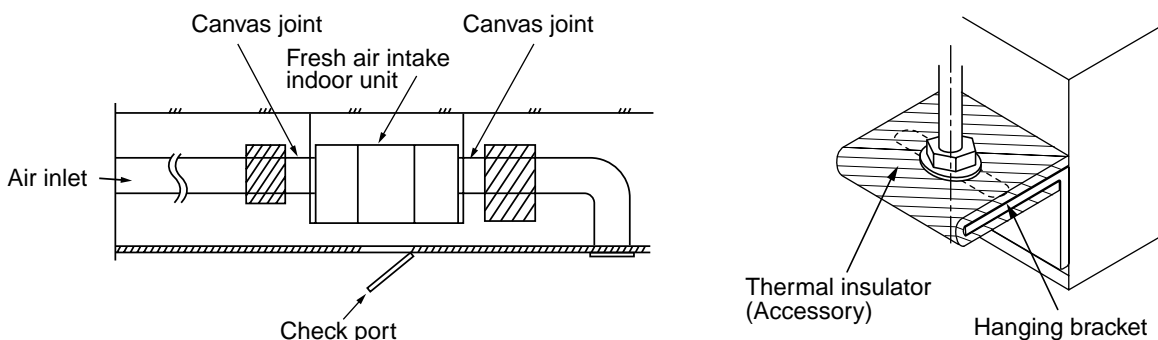

Duct Work

- After installing the product, perform the duct work according to the working diagram.

5 DUCT WORK

Connecting flange

Refer to size in the figure attached to the main unit.

<MMD-AP0481HFE>

<Air supply port connecting flange>

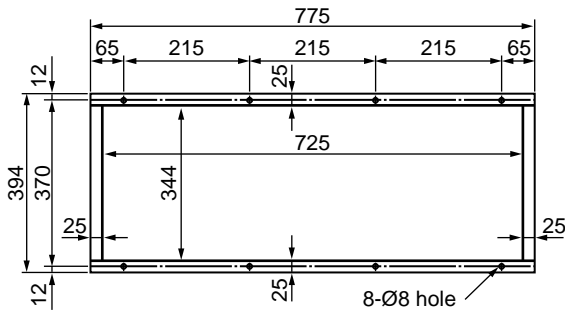

<MMD-AP0721HFE, AP0961HFE>

<Air supply port connecting flange>

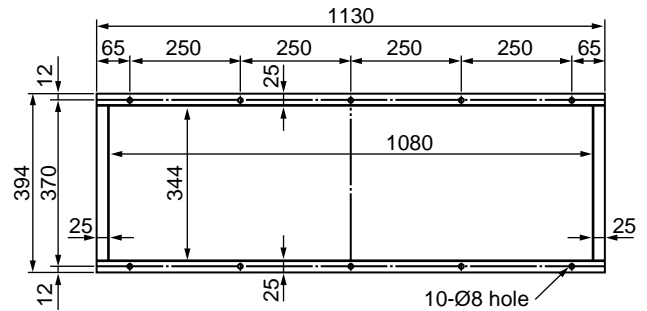

<Air inlet port connecting flange>

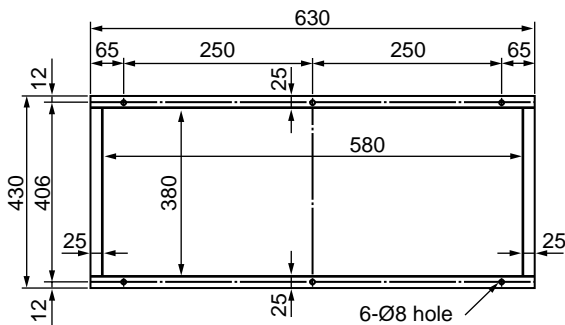

<Air inlet port connecting flange>

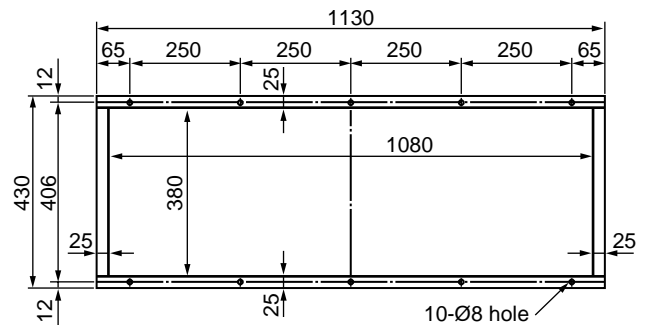

REQUIREMENT

If the air conditioner unit and the canvas joint are connected with the rivets, the fan and the refrigerating cycle cannot be checked.

Be sure to use the flange as shown in the above and tighten it by the bolts.

(Fixing bolts M6 x 12mm, Procured locally)

<Procured locally/Construction>

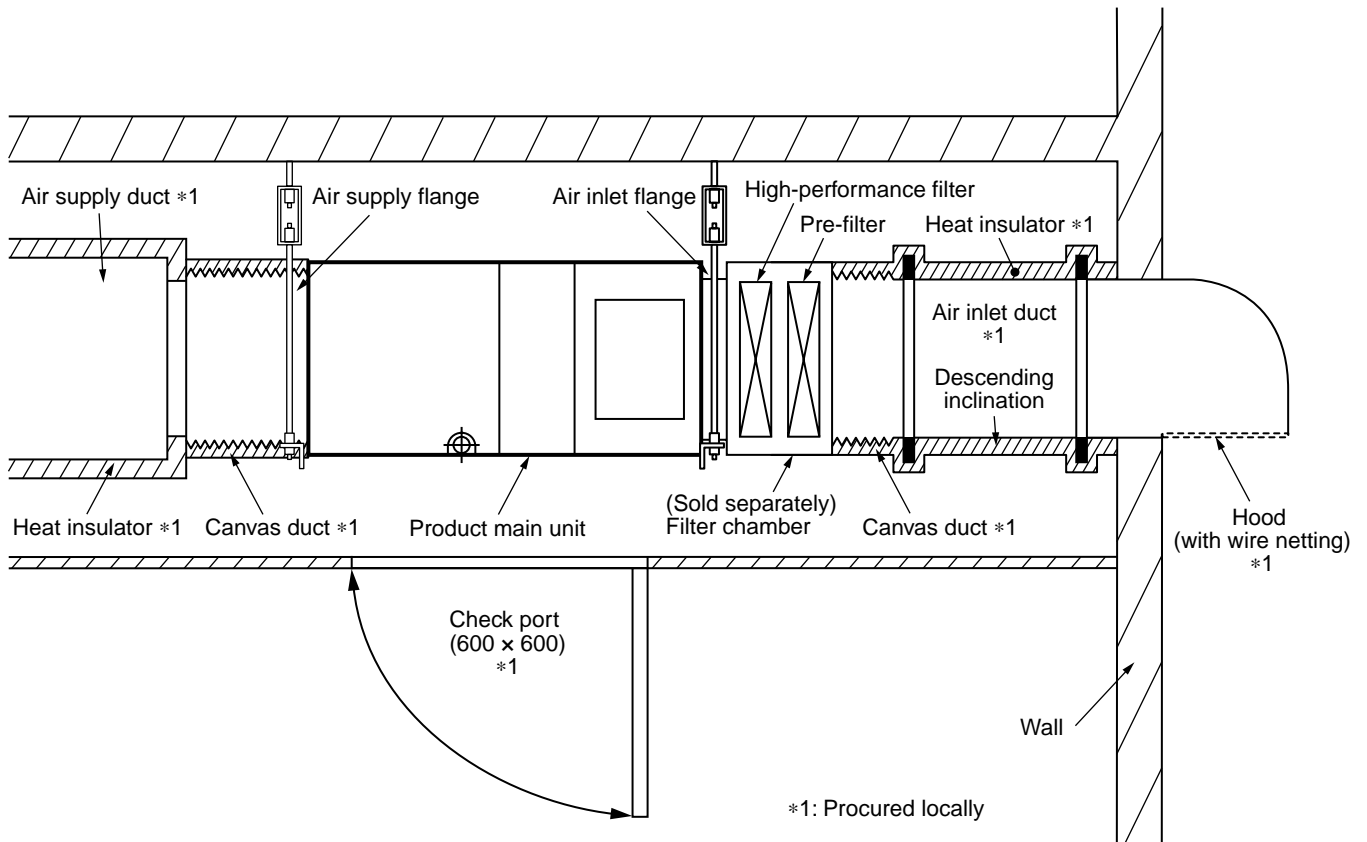

1. Air inlet duct

- Connect the air inlet duct (Procured locally) to the inlet flange.
Wrap aluminum tape around connecting part between the air inlet port flange and duct, or provide sealer so that air does not leak.
- For the fresh air intake port, attach a hood so that fresh air is sucked from lower side.
And attach wire netting, etc. to the air inlet of the hood.
- Set the air inlet duct at descending inclination so that water can be drained even if rainwater enters in.

2. Air supply duct

- Connect the air supply duct (Procured locally) to the Air supply flange.
Wrap aluminum tape around connecting part of the air supply port flange and duct or apply packing so that air does not leak.

6 DRAIN PIPING WORK

CAUTION

- Following the Installation Manual, perform the drain piping work so that water is properly drained, and apply a heat insulating so as not to cause a dewing. Inappropriate piping work may result in water leakage in the room and wet of furniture.

REQUIREMENT

- The draining method is a natural draining. Therefore, slope the piping outside of the unit downward (at 1/50 to 1/100), and do not put an angle halfway. If doing so, an abnormal sound may be caused.
- To prevent overflow of drain pipe, set a drain trap on its way as shown in the right figure. [The drain trap is required for preventing aspiration of smell through the drain pipe, and also for preventing hardness of draining because the differential pressure between the drain pan and atmosphere becomes large when the external static pressure is high (especially, at suction side).]
- Dust inside of the drain pipe is easy to be heaped at the drain trap. Be sure to set a plug so that the drain trap can be cleaned.
- Maximum horizontal drain pipe length should be less than 20m or shorter. If the pipe is long, set the support brackets with 1.5 to 2m interval to prevent waving.
- Mount the collective drain pipe as shown in the right figure.
- Do not mount an air purge pipe. Otherwise drain water spouts out resulted in water leak.
- Do not apply strength to the connecting part with the drain pipe.
- Do heat insulating securely to the indoor drain pipe.
- Be sure to do heat insulating to the connecting part with the indoor unit. Incomplete heat insulating may cause dewing.
- Do not directly connect the drain pipe to the drainage, etc. with ammonia smell; otherwise there is a possibility that ammonia ingredient of the drainage passes through the drain pipe and corrodes the heat exchanger of the indoor unit.

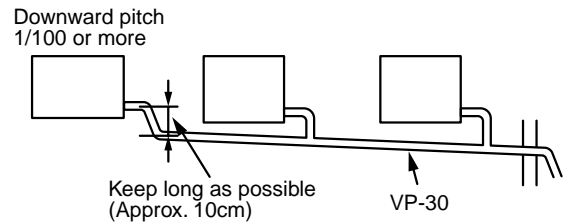

Piping/Heat insulating material

The following materials as below for piping and heat insulating process are procured locally.

Piping	Heat insulator
Hard vinyl chloride pipe VP25 (Outer dia. : Ø32mm)	Vesicant polyethylene : Thickness 10mm or more

Check the draining

Check the water drainage is surely performed at the trial operation. Check also no water leakage is found at the pipe connecting part.

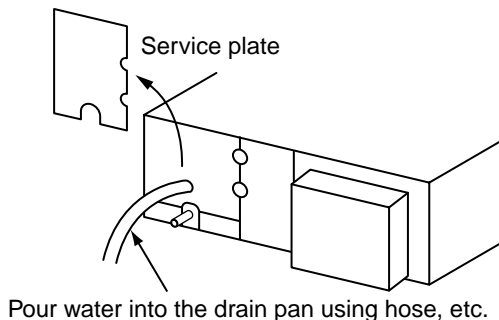

Drain up

When not securing down slope on the drain pipe, use a drain up kit sold separately. Also refer to the "Drain up kit installation manual".

Check the draining

After drain piping work, check that water drain is properly performed and water does not leak from the connecting part of the pipes. In this time, check also there is no abnormal sound of the motor of the drain pump. Be sure to check draining when installed in the heating period.

REQUIREMENT

- Be sure to check draining even if installing the unit in heating season.
- Using a kettle or hose, pour water gradually from the drain pan at the air supply port.

7 REFRIGERANT PIPING

WARNING

- If refrigerant gas has leaked during the installation work, ventilate the room immediately.
 - If the leaked refrigerant gas comes in contact with fire, noxious gas may generate.
- After the installation work, confirm that refrigerant gas does not leak.
 - If refrigerant gas leaks into the room and flows near a fire source, such as a cooking range, noxious gas may generate.

REQUIREMENT

When the refrigerant pipe is long, set the support brackets to fix the pipe with 2.5 to 3m intervals.
If the pipe is not fixed, abnormal sound may generate.
Be sure to use the flare nuts attached to the indoor unit or those fro R410A.

Permissible pipe length and permissible height difference

They are different according to the used outdoor unit.
For details, refer to the Installation Manual attached to the outdoor unit.

Piping material and dimensions

Piping material		Phosphor deoxidization seamless pipe for air conditioner	
Model		MMD-AP0481HFE	MMD-AP0721HFE, AP0961HFE
Pipe size (mm)	Gas side	Ø15.9	Ø22.2
	Liquid side	Ø9.52	Ø12.7

- Use a clean and new pipe, and check that impurity such as dust, oil, moisture, etc. does not adhere in the pipe.

Pipe Forming/End Positioning

Flaring

1. Cut the pipe with a pipe cutter.

- Flaring diam. meter size :
A (Unit : mm)

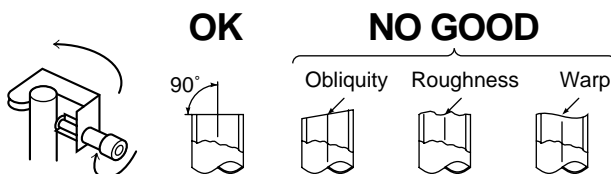
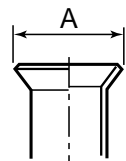

2. Insert a flare nut into the pipe, and flare the pipe.
As the flaring sizes of R410A differ from those of refrigerant R22, the flare tools newly manufactured for R410A are recommended.
However, the conventional tools can be used by adjusting projection margin of the copper pipe.

Outer diam. of copper pipe	A ⁺⁰ / _{-0.4} (mm)
	R410A
6.4	9.1
9.5	13.2
12.7	16.6
15.9	19.7

- * In case of flaring for R410A with the conventional flare tool, pull it out approx. 0.5 mm more than that for R22 to adjust to the specified flare size.
The copper pipe gauge is useful for adjusting projection margin size.

7 REFRIGERANT PIPING

- Projection margin in flaring :
B (Unit : mm)

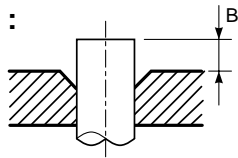

Rigid (Clutch type)

Outer diam. of copper pipe	R410A tool used		Conventional tool used
	R410A	R22	R410A
6.4	0 to 0.5	(Same as left)	1.0 to 1.5
9.5	0 to 0.5	(Same as left)	1.0 to 1.5
12.7	0 to 0.5	(Same as left)	1.0 to 1.5
15.9	0 to 0.5	(Same as left)	1.0 to 1.5

Imperial (Wing nut type)

Outer diam. of copper pipe	R410A
6.4	1.5 to 2.0
9.5	1.5 to 2.0
12.7	2.0 to 2.5
15.9	2.0 to 2.5

Connection of refrigerant pipe

Connect all the refrigerant pipes with flare connecting work.

- Since the atmospheric pressure only is sealed as the sealing gas, it is not abnormal that "Pushu..." sound is not heard when the flare nut is removed.
- Be sure to use a double spanner for pipe connecting work of the indoor unit.

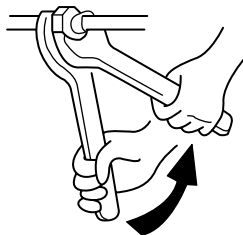

Work using double spanner

- Refer to the following table for tightening torque.

Connecting pipe outer dia. (mm)	Tightening torque (N•m)	Re-tightening torque (N•m)
Ø6.4	14 to 18 (1.4 to 1.8 kgf•m)	18 (1.8 kgf•m)
Ø9.5	33 to 42 (3.3 to 4.2 kgf•m)	42 (4.2 kgf•m)
Ø12.7	50 to 62 (5.0 to 6.2 kgf•m)	50 (5.0 kgf•m)
Ø15.9	68 to 82 (6.8 to 8.2 kgf•m)	68 (6.8 kgf•m)

Airtight test/Air purge, etc.

For airtight test, air purge, addition of refrigerant, and gas leak check, follow the Installation Manual attached to the outdoor unit.

REQUIREMENT

Be sure to use the tool such as charge hose exclusive to R410A.

Do not turn on the power until the airtight test and the vacuuming have finished. (If turning on the power, the incorporated PMV is closed fully and the period until the vacuuming finishes elongates.)

Open fully valves of the outdoor unit

Gas leak check

Check with a leak detector or soap water whether gas leaks or not, from the pipe connecting section or cap of the valve.

REQUIREMENT

Use a leak detector manufactured exclusively for HFC refrigerant (R410A, R134a, etc.).

Heat insulating process

Perform heat insulating for pipes at liquid side and gas side separately.

In cooling time, temperature at both liquid and gas sides becomes lower.

Therefore, perform heat insulating process sufficiently to avoid dewing.

- For heat insulator of pipe at gas side, be sure to use one with heat-resisting temp. 120°C or more.

REQUIREMENT

Apply the heat insulation to the pipe connecting section of the indoor unit securely up to the root without exposure of the pipe. (The pipe exposed to the outside causes water leak.)

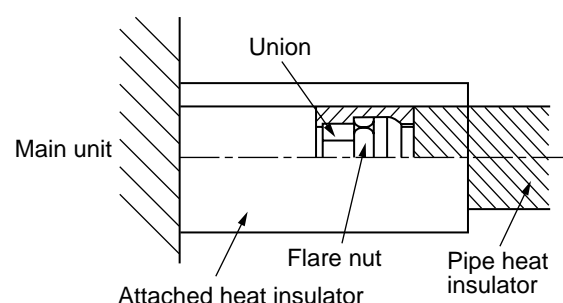

8 ELECTRIC WORK

WARNING

1. **Using the specified wires, ensure to connect the wires, and fix wires securely so that the external strength of the wires do not transmit to the connecting part of the terminals.**

Incomplete connection or fixation may cause a fire, etc.

2. **Be sure to connect earth wire. (Grounding work)**

Do not connect the earth wire to gas pipe, city water pipe, lightning rod, or the earth wire of telephone. Incomplete grounding causes an electric shock.

3. **For electric work, strictly follow to the Local Regulation in each country and the Installation Manual, and use an exclusive circuit.**

Capacity shortage of power circuit or incomplete installation may cause an electric shock or a fire.

CAUTION

- Be sure to install an earth leakage breaker.**

If an earth leakage breaker is not installed, an electric shock may be caused.

REQUIREMENT

- For power supply wiring, strictly conform to the Local Regulation in each country.
- For wiring of power supply of the outdoor units, follow to the Installation Manual of each outdoor unit.
- Never connect 220–240V power to the terminal blocks (A, B, U₁, U₂) for control wiring. (Otherwise, the system will be failed.)
- Perform the electric wiring so that it does not come to contact with the high-temperature part of the pipe. The coating may melt resulted in an accident.
- After connecting wires to the terminal blocks, provide a trap and fix wires with the wire clamp.
- Store the refrigerant piping line and control wiring line in the same line.
- Do not turn on the power of the indoor unit until vacuuming of the refrigerant pipes completes.
- Keep a margin (Approx. 100mm) on a wire to hang down the electric parts box at servicing, etc.

8 ELECTRIC WORK

Specifications

Power supply cord and communication wires are procured locally. For the power supply specifications, follow to the table below. If capacity is little, it is dangerous because overheat or seizure may be caused. For specifications of the power capacity of the outdoor unit and the power supply wires, refer to the Installation Manual attached to the outdoor unit.

Power supply (*1)	Power supply	220–240V ~ 50Hz, 220V ~ 60Hz	
	Power supply switch/Earth leakage breaker or power supply wiring/fuse rating for indoor units should be selected by the accumulated total current values of the indoor units.		
	Power supply wiring	Below 20m	Twist wire : 2.0 mm ²
Below 50m		Twist wire : 3.5 mm ²	
Communication line	Indoor/Outdoor inter-unit wiring (*2) (2 cables)	Wire size	(Up to 1000m) Twist wire : 1.25 mm ² (Up to 2000m) Twist wire : 2.00 mm ²
	Central control line wiring (*3) (2 cables)	Wire size	(Up to 1000m) Twist wire : 1.25 mm ² (Up to 2000m) Twist wire : 2.00 mm ²
	Remote controller wiring (*4) (2 cables)	Wire size	Twist wire : 0.5 to 2.0 mm ²

Indoor unit power supply (*1)

- For the power supply of the indoor unit, prepare the exclusive power supply separated from that of the outdoor unit.
- Arrange the power supply, earth leakage breaker, and main switch of the indoor unit connected to the same outdoor unit so that they are commonly used.
- Power supply cord specification : Cable 3-core 2.5mm², in conformity with Design 60245 IEC 57.

Indoor/Outdoor inter-unit wiring, Central controller wiring (*2) (*3)

- 2-core with polarity wires are used for the Indoor/Outdoor inter-unit wiring and Central controller wiring.
- To prevent noise trouble, use 2-core shield wire.
- The length of the communication line means the total length of the inter-unit wire length between indoor and outdoor units added with the central control system wire length.

Remote controller wiring (*4)

- 2-core with non-polarity wire is used for wiring of the remote controller wiring and group remote controllers wiring.

Remote controller wiring, remote controller inter-unit wiring	Twist wire: 0.5mm ² to 2.0mm ² × 2	
Total wire length of remote controller wiring and remote controller inter-unit wiring = L + L1 + L2 + ... Ln	In case of wired type only	Up to 500m
Total wire length of remote controller inter-unit wiring = L1 + L2 + ... Ln		Up to 200m

CAUTION

- The remote controller group connection between the fresh air intake indoor unit and the usual air conditioner unit is impossible. The remote controller wire (Communication line) and AC220–240V wires cannot be parallel to contact each other and cannot be stored in the same conduits. If doing so, a trouble may be caused on the control system due to noise, etc.
- Group control between the fresh air intake indoor unit and the normal air conditioner unit is impossible.

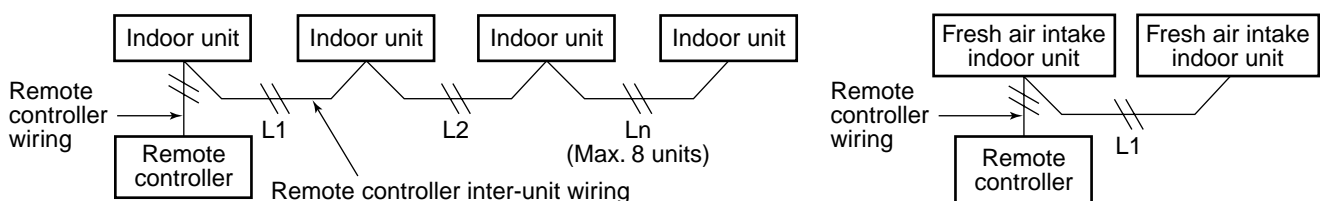

The group connection of the fresh air intake indoor unit with the indoor units for air conditioning is unavailable. Be careful that the group connection is available only between normal indoor units or between fresh air intake indoor units.

Wiring the indoor unit

Be sure to connect the wire while matching the terminal numbers. Incorrect connection causes a trouble.

<MMD-AP0481HFE>

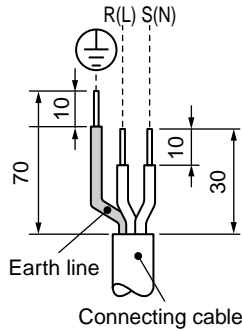
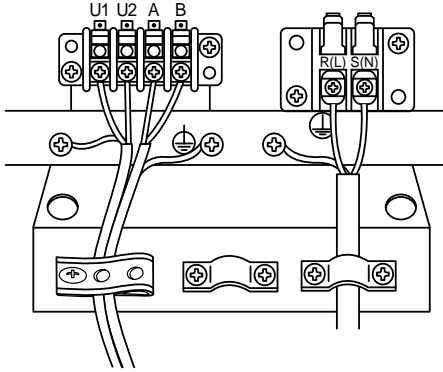

<MMD-AP0721HFE, AP0961HFE>

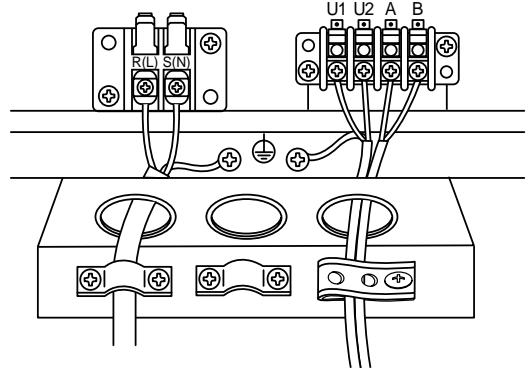

Remote controller wiring

- As the remote controller wire has no polarity, there is no problem if connections to indoor unit terminal blocks A and B are reversed.

<Wiring diagram>

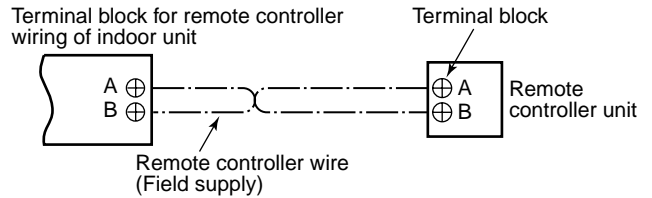

Wiring between indoor and outdoor units

<Wiring example>

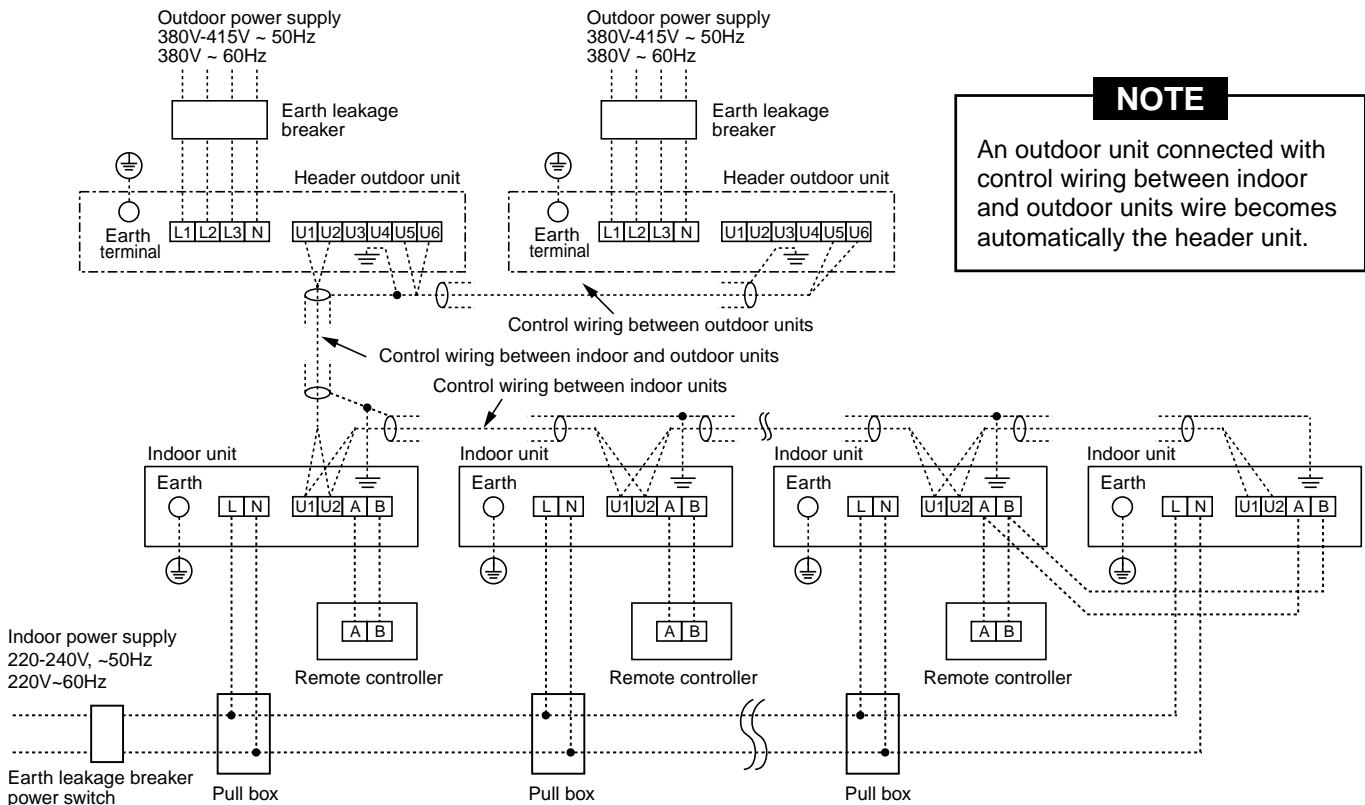

NOTE

An outdoor unit connected with control wiring between indoor and outdoor units wire becomes automatically the header unit.

Address setup

Set up the addresses according to the Installation Manual attached to the outdoor unit

9 APPLICABLE CONTROLS

NOTIFICATION

When using the equipment at the first time, it will take a lot of time that the remote controller accepts an operation after power was on. However, it is not a trouble.

• Automatic address

- While automatic addressing, the operation cannot be performed on the remote controller.
- For automatic addressing, Max. 10 minutes (generally, approx. 5 minutes) are required.

• When power will be turned on after finish of automatic addressing;

- It will require Max. 10 minutes (generally, approx. 3 minutes) that outdoor unit starts operation after power was on.

As all have been set to [Standard] at the shipment, change the setup of the indoor unit if necessary.

To change the setup, use the main remote controller (wired remote controller).

* The setup change for wireless remote controller, sub remote controller, or remote controller-less system (Central control remote controller only is provided.) is impossible. In these cases, prepare and mount a separate main remote controller.

Exchange of applicable control setup

Basic operation procedure for setup exchange

Change the setup while operation of the equipment stops.
(Be sure to stop the operation of a set.)

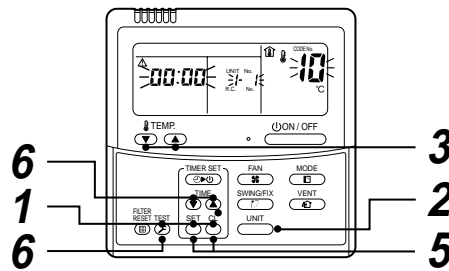

Procedure	Description
1	<p>When pushing SET, CL, and TEST buttons simultaneously for 4 seconds or more, after a while, the display part flashes as shown in the figure. Check that the displayed item code is [10].</p> <ul style="list-style-type: none"> • If the item code indicates other than [10], push TEST button to erase the display, and then retry the operation from the first step. (For some time after TEST button has been pushed, the operation of the remote controller cannot be accepted.) <p>(In a group control, the firstly displayed indoor unit No. becomes the center unit.) (* The display changes according to the indoor unit model.)</p>
2	<p>Every pushing UNIT button, the indoor unit No. in the group control is displayed successively. Select an indoor unit of which setup to be changed.</p> <p>In this time, the position of the indoor unit of which setup to be changed can be confirmed because the fan and the flap of the selected indoor unit work.</p>
3	<p>Using ▼, ▲ buttons of set temperature, specify the item code [**].</p>
4	<p>Using ▼, ▲ buttons of timer time, select set data [****].</p>
5	<p>Push SET button. In this time, if the display changes from flashing to lighting, the setup completes.</p> <ul style="list-style-type: none"> • To change the setup of an indoor unit other than the selected one, start operation from Procedure 2. • To change the setup of another setup in the selected indoor unit, start operation from Procedure 3. <p>Pushing CL button clears the set up contents which have been already set. In this case, retry from Procedure 2.</p>
6	<p>When the setup finished, push TEST button. (The setup is determined.)</p> <p>Pushing TEST button deletes the display and returns the status to normal stop status. (For some time after TEST button has been pushed, the operation of the remote controller cannot be accepted.)</p>

Change of lighting term of filter sign

According to the installation condition, the lighting term of the filter sign (Notification of filter cleaning) can be changed.

Follow to the basic operation procedure

(**1** → **2** → **3** → **4** → **5** → **6**).

- For the item code in Procedure **3**, specify [01].
- For the [Set data] in Procedure **4**, select the setup data of filter sign lighting term from the following table.

Setup data	Filter sign lighting term
0000	None
0001	150H
0002	2500H (At shipment from factory)
0003	5000H
0004	10000H

10 FAN CHARACTERISTICS

Fan Characteristics

REQUIREMENT

Set a volume damper to the air supply duct, and then adjust the air volume so that it is kept in the range of 70 to 110% against the standard air volume.

<MMD-AP0481HFE>

(Standard air volume: 1080m³/h, Lower limit air volume: 756m³/h, Upper limit air volume: 1188m³/h)

50Hz, 220V

50Hz, 230V

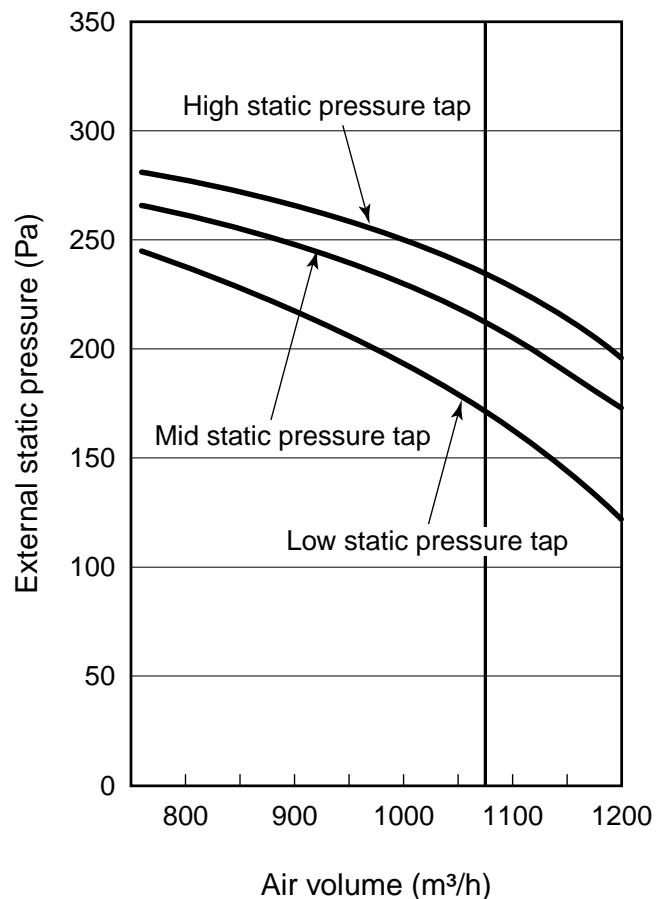
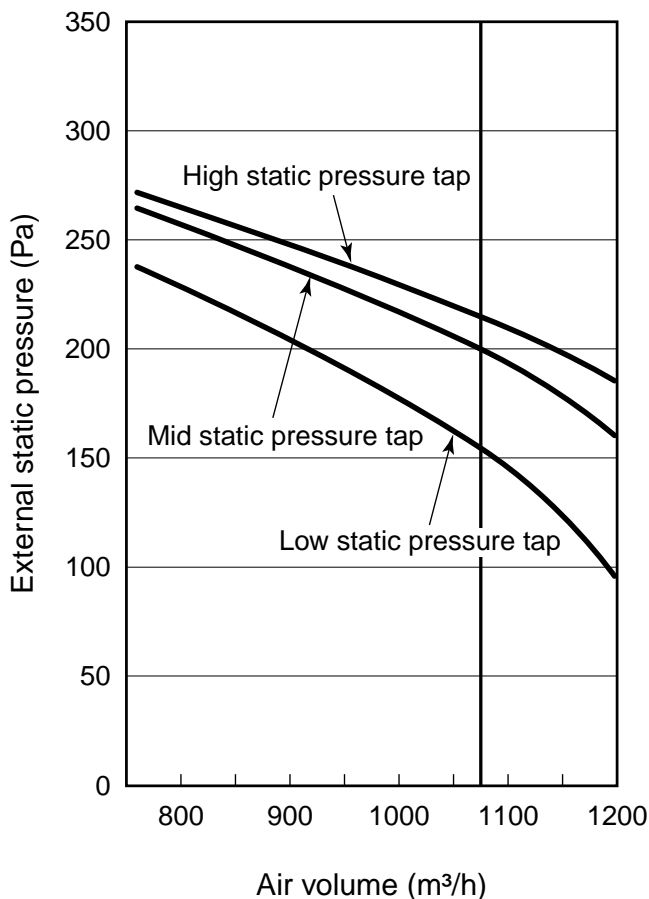
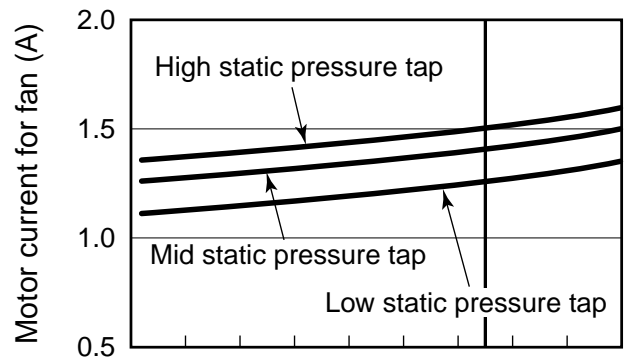
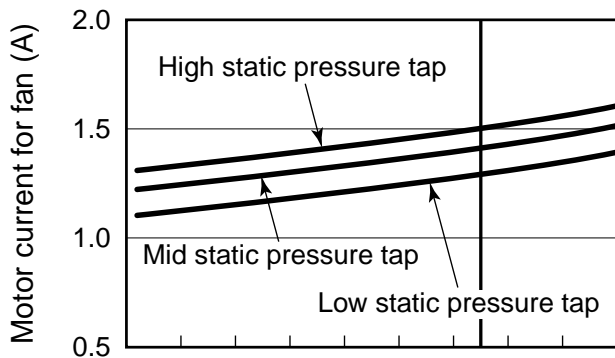

50Hz, 240V

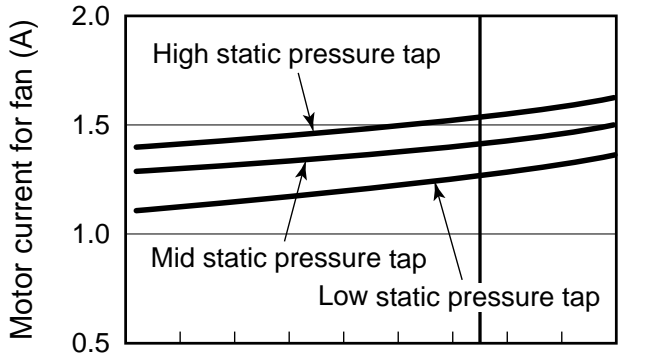

60Hz, 220V

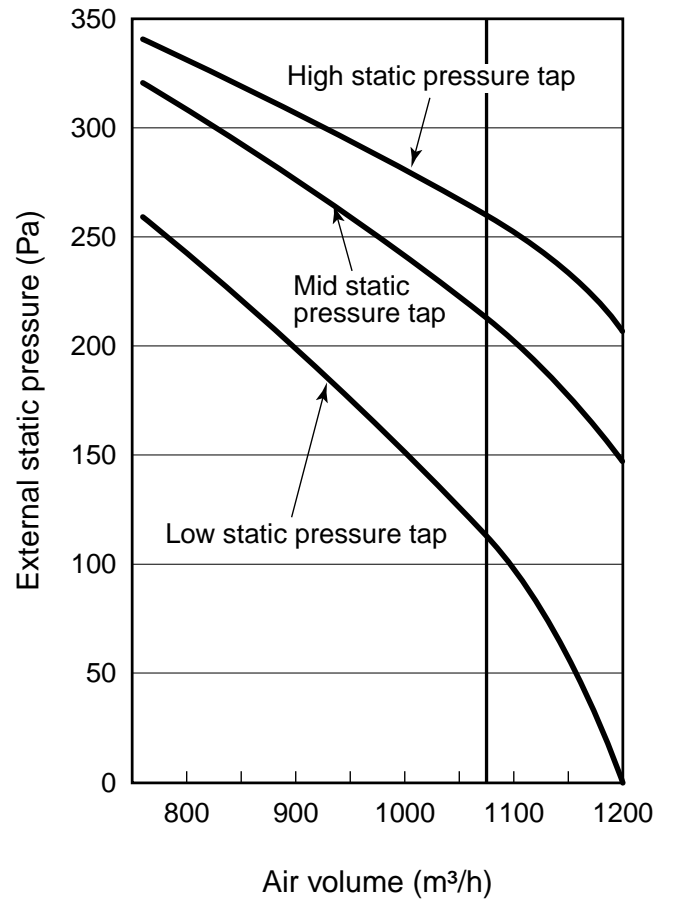
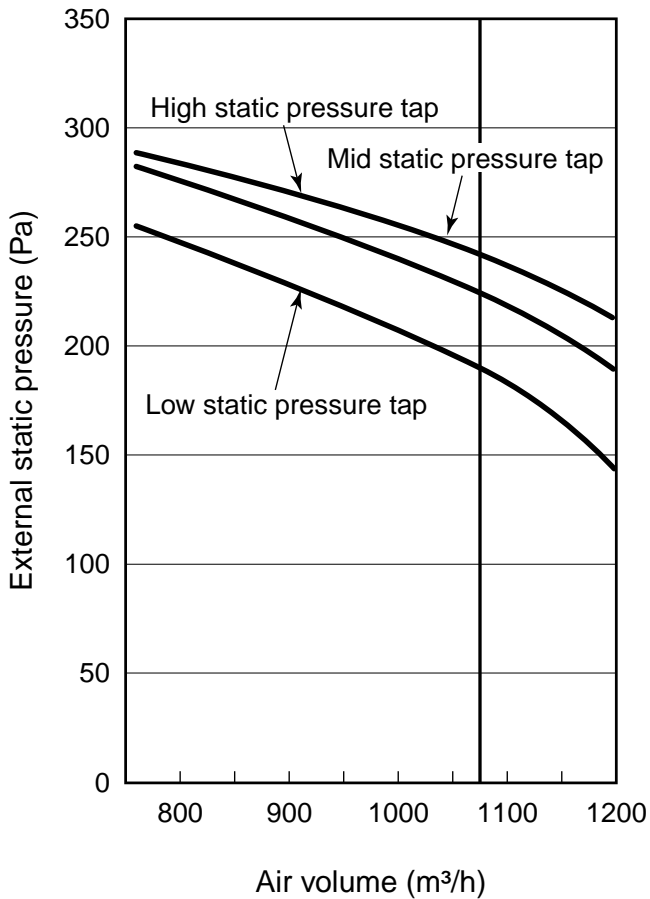
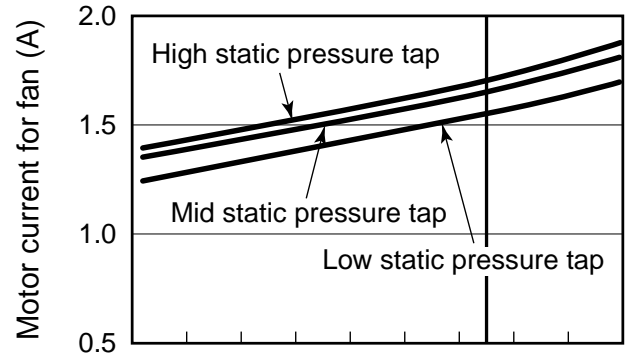

10 FAN CHARACTERISTICS

<MMD-AP0721HFE>

(Standard air volume: 1680m³/h, Lower limit air volume: 1176m³/h, Upper limit air volume: 1848m³/h)

50Hz, 220V

50Hz, 230V

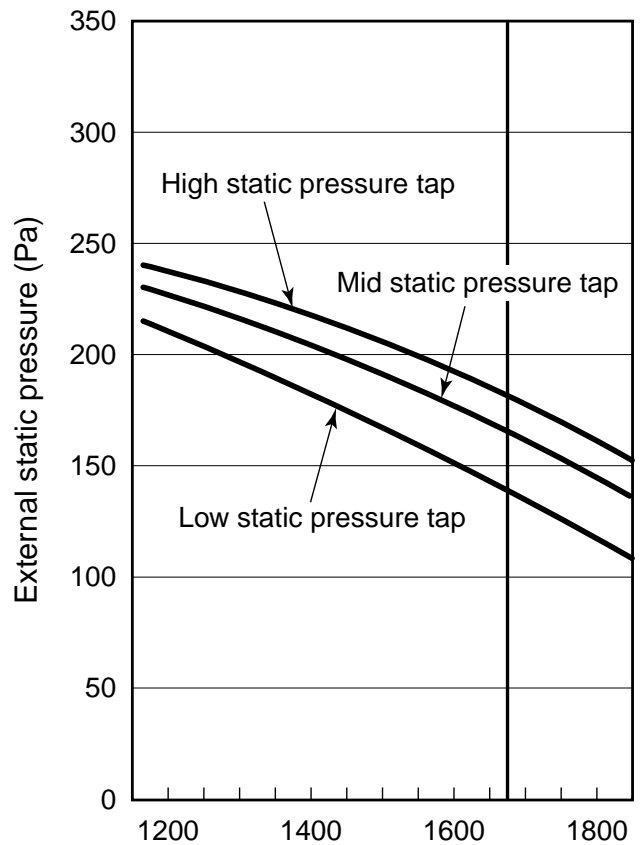
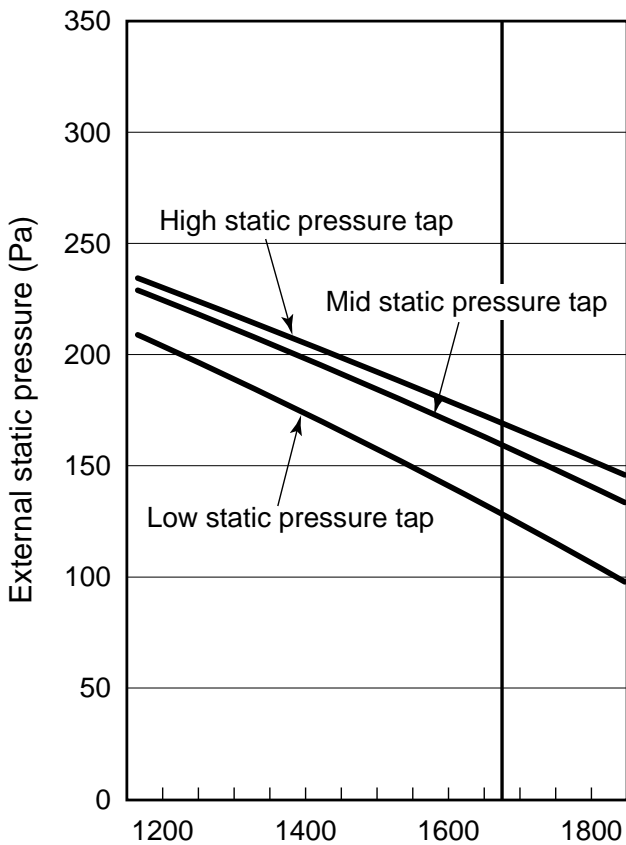
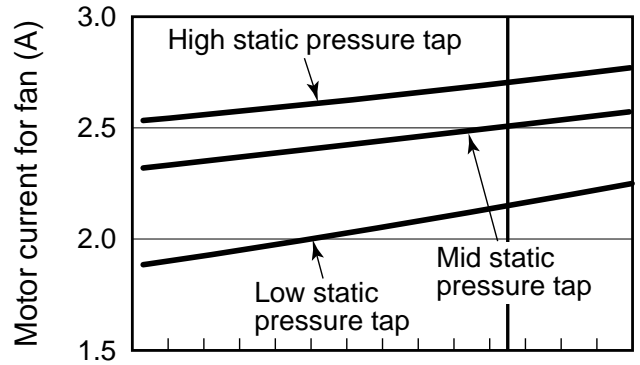
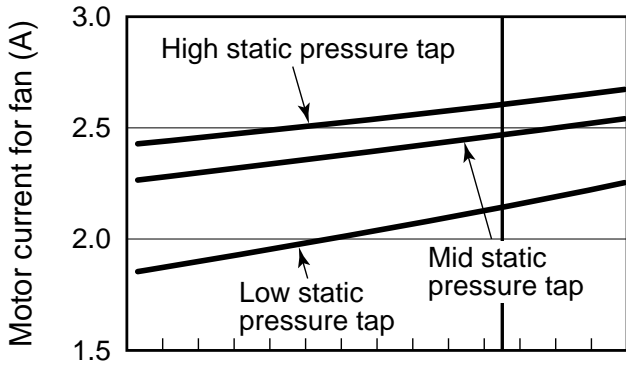

Air volume (m³/h)

Air volume (m³/h)

50Hz, 240V

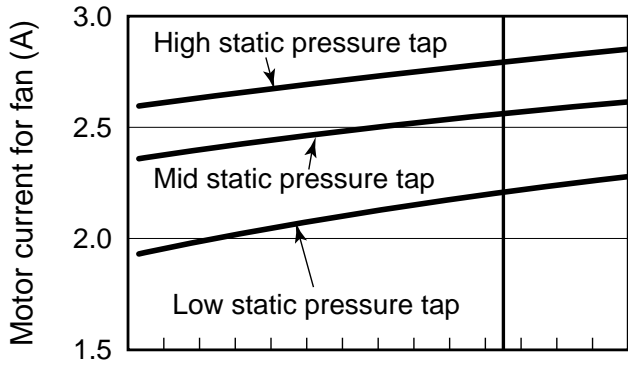

60Hz, 220V

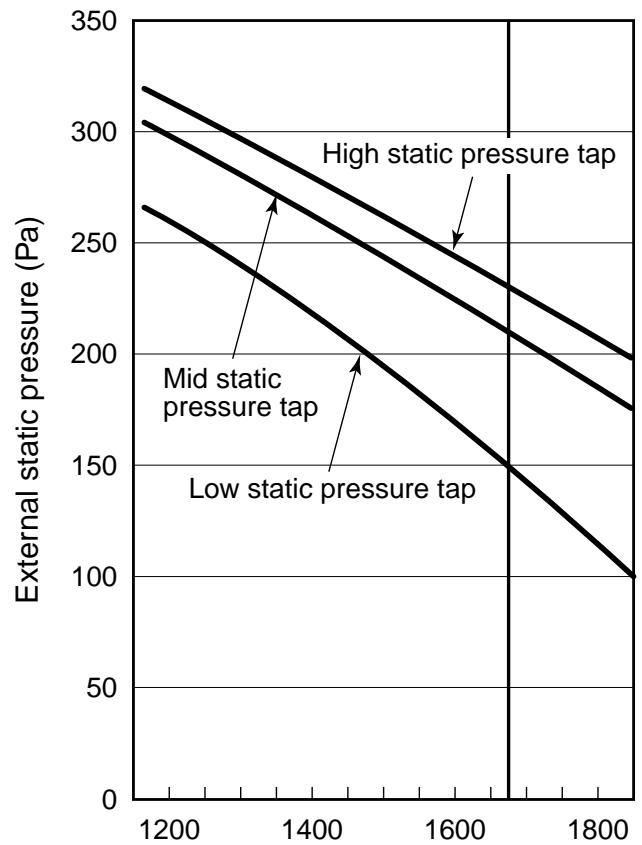
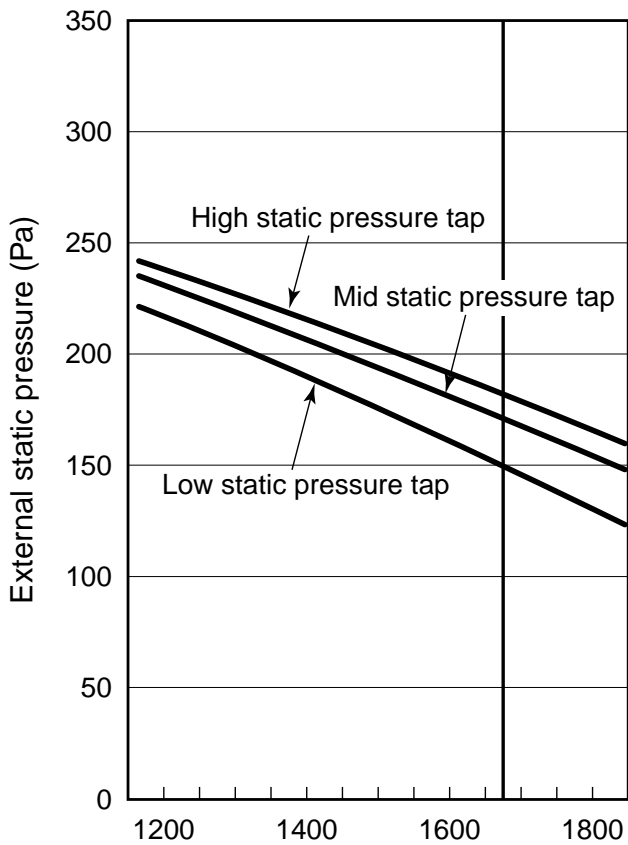
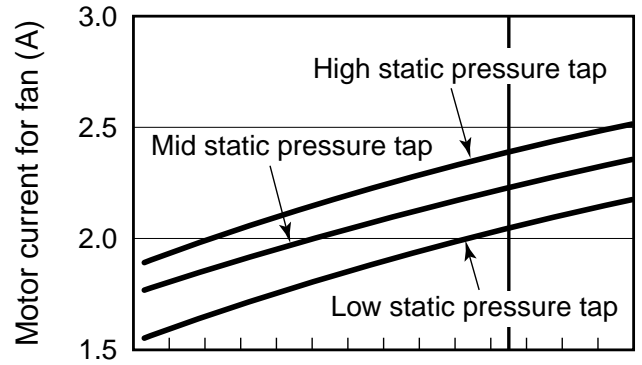

Air volume (m³/h)

Air volume (m³/h)

10 FAN CHARACTERISTICS

<MMD-AP0961HFE>

(Standard air volume: 2100m³/h, Lower limit air volume: 1470m³/h, Upper limit air volume: 2310m³/h)

50Hz, 220V

50Hz, 230V

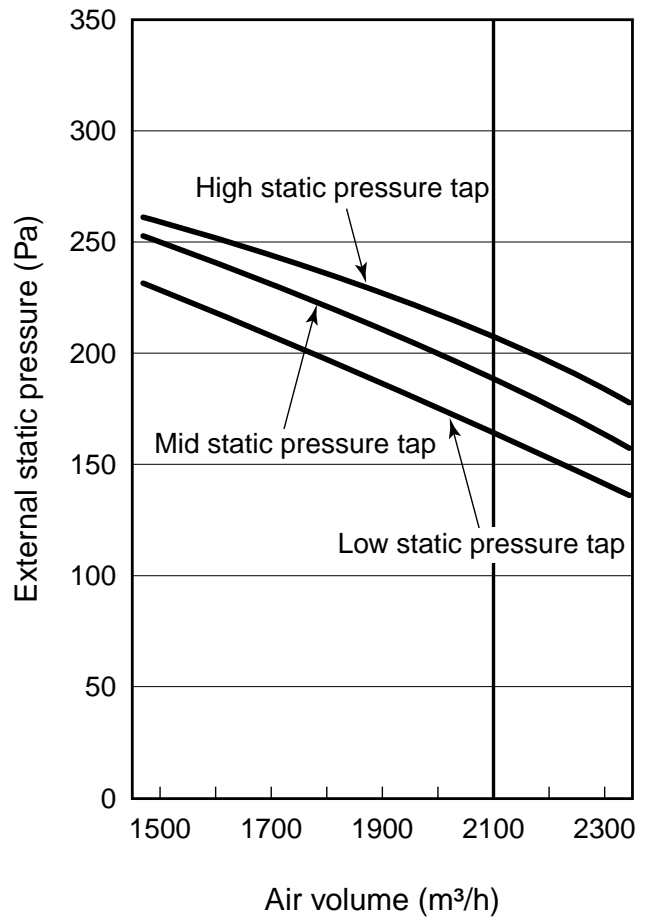
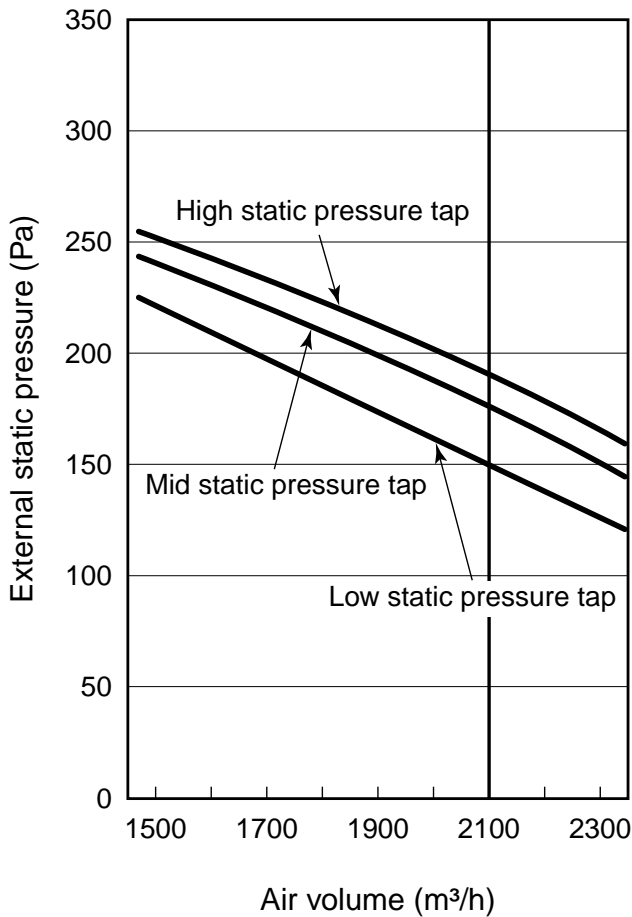
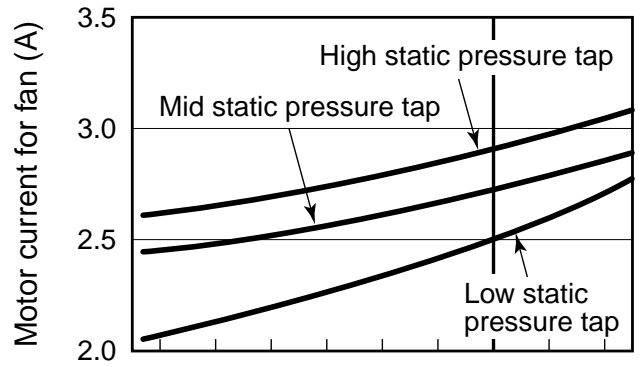
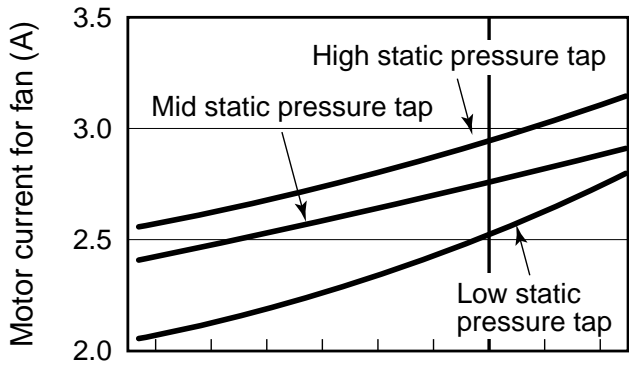

50Hz, 240V

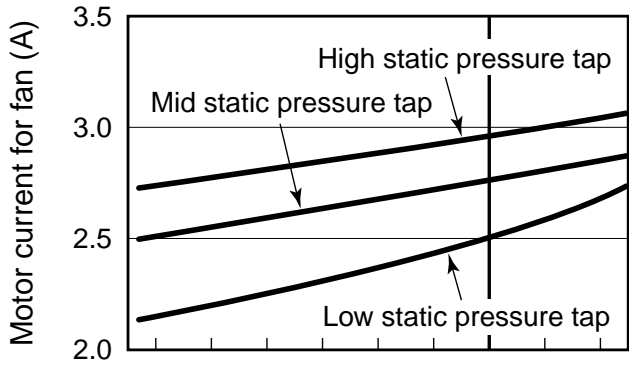

60Hz, 220V

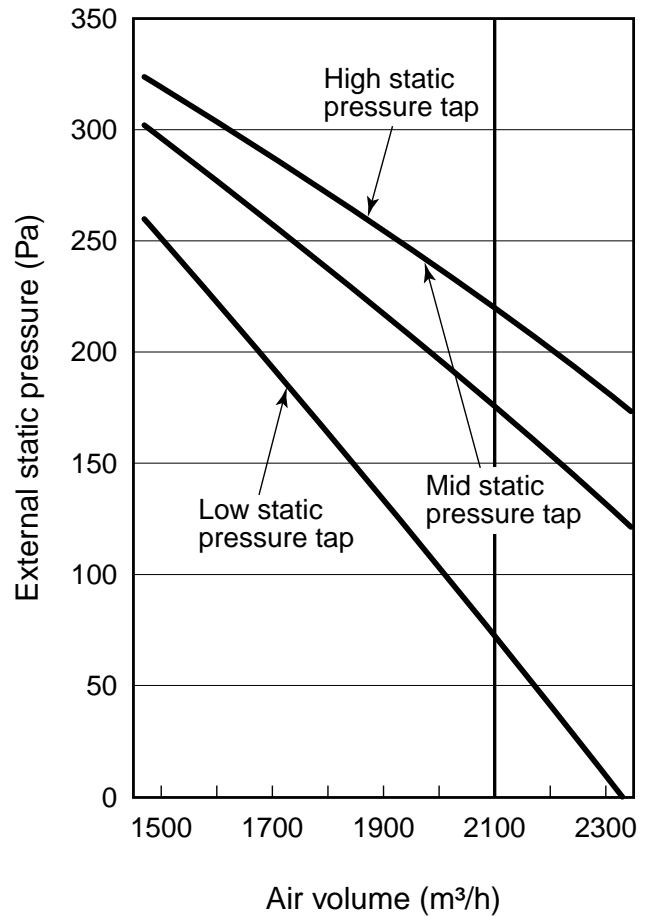
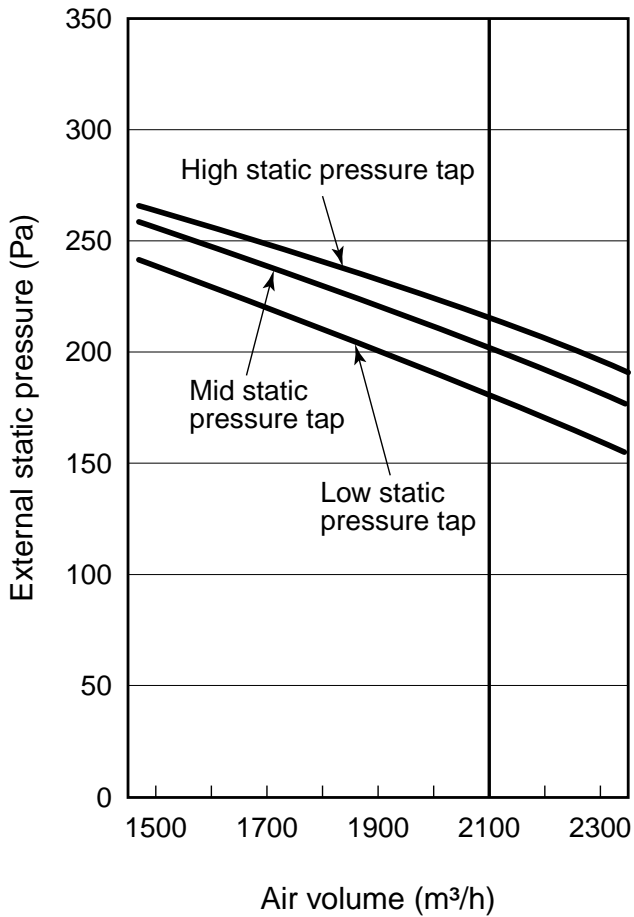
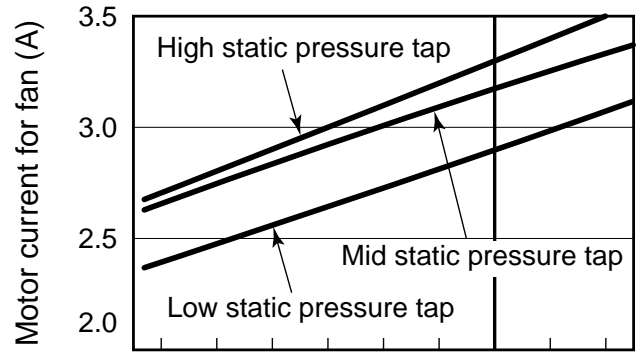

10 FAN CHARACTERISTICS

Wire connection change for fan motor

The motor wires for the fan have been connected to (F2) at shipment from the factory.
Change the wire connection if change of the external static pressure is required due to the duct resistance.

<MMD-AP0481HFE>

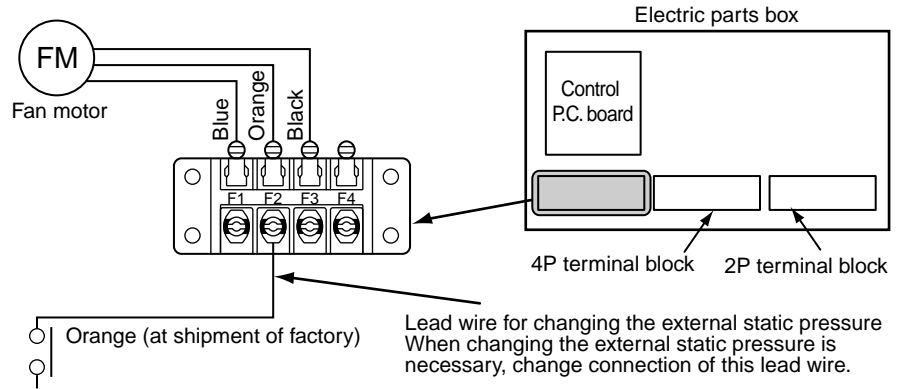

<MMD-AP0721HFE>

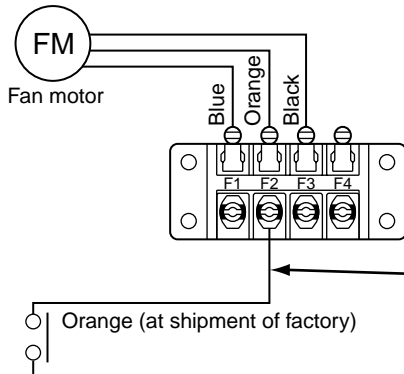

<MMD-AP0961HFE>

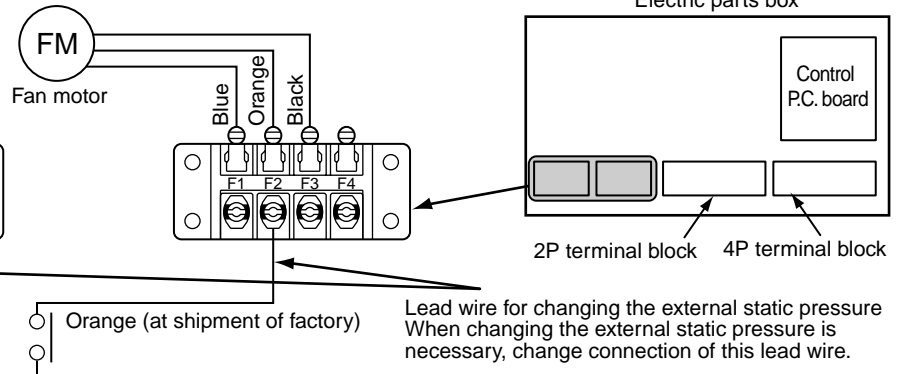

REQUIREMENT

When the external static pressure was changed, enter the changed static pressure value in the identification plate of the unit.

Terminal block No.	Fan motor wiring	Remarks
F1 (Low static pressure tap)	Blue (50 / 60Hz)	—
F2 (Intermediate static pressure tap)	Orange (50 / 60Hz)	At shipment from factory
F3 (High static pressure tap)	Black (50 / 60Hz)	—

11 TEST RUN

Before test operation

- Before turning on the power supply, carry out the following items.
 - 1) Using 500V-megger, check there is 1MΩ or more between the terminal block of the power supply and the earth. If 1MΩ or less is detected, do not run the unit.
 - 2) Check that all the valves of the outdoor unit are fully opened.
- Never push the electromagnetic contactor to carry out a forced test operation. (It is very dangerous because a protective device does not work.)

WARNING

To protect the compressor at starting time, keep power-ON condition before 12 hours or more.

How to execute test operation

- To carry out a fan operation in a single indoor unit, turn off the power once, short CN72 on P.C. board, and then turn on the power again. (Start the unit in FAN mode.) In this case, do not forget to clear short-circuit of CN72 after test operation.
- Using the remote controller, check the operation in the usual operation. For the operation procedure, refer to the attached Owner's Manual.

A forced test operation can be executed in the following procedure under condition of thermo-OFF of room temperature.

In order to prevent a serial operation, the forced test operation is released after 60 minutes and returns to the usual operation.

NOTE

Do not use a forced operation in cases other than test operation because it applies an excessive load to the air conditioner.

In case of wired remote controller

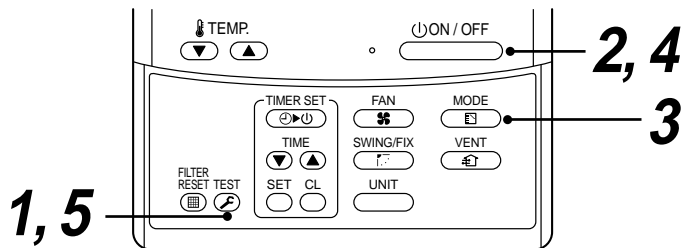

Procedure	Description	
1	Keep TEST button pushed for 4 seconds or more. [TEST] is displayed on the display part and the selection of mode in the test mode is permitted.	
2	Push ON/OFF button.	
3	Using MODE button, select the operation mode, [COOL] or [HEAT]. <ul style="list-style-type: none"> • Do not run the air conditioner in a mode other than [COOL] or [HEAT]. • The temperature controlling function does not work during test operation. • The detection of error is performed as usual. 	
4	After the test operation, push ON/OFF button to stop the operation. (Display part is same as procedure 1)	
5	Push TEST button to cancel (release from) the test operation mode. ([TEST] disappears on the display part and the status returns to a normal stop status.)	

12 TROUBLESHOOTING

Confirmation and check

When a trouble occurred in the air conditioner, the check code and the indoor unit No. appear on the display part of the remote controller.

The check code is only displayed during the operation.

If the display disappears, operate the air conditioner according to the following "Confirmation of error history" for confirmation.

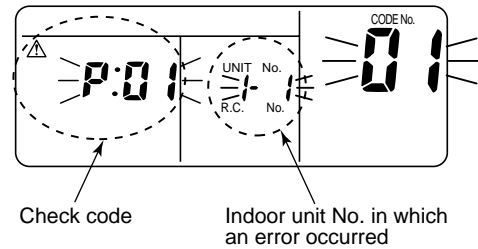

Confirmation of error history

When a trouble occurred on the air conditioner, the error history can be confirmed with the following procedure. (The error history is stored in memory up to 4 errors.)

This history can be confirmed from either operating status or stop status.

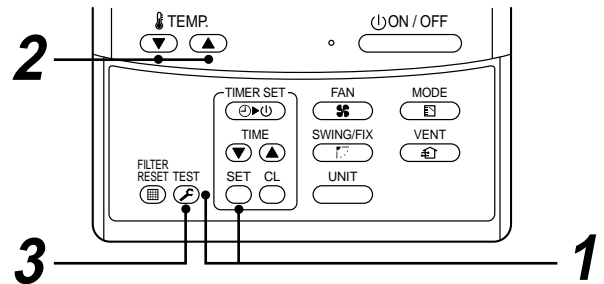

Procedure	Description
1	<p>When pushing [SET] and buttons simultaneously for 4 seconds or more, the right display appears.</p> <p>If [Service Check] is displayed, the mode enters in the error history mode.</p> <ul style="list-style-type: none"> • [01: Order of error history] is displayed in CODE No. window. • [Check Code] is displayed in CHECK window. • [Indoor unit address in which an error occurred] is displayed in UNIT No.
2	<p>Every pushing buttons, the error history stored in the memory is displayed in order. The numbers in CODE No. indicates CODE No. [01] (Latest) → [04] (Oldest).</p> <p>CAUTION</p> <p>Do not push button because all the error history of the indoor unit will be deleted.</p>
3	<p>After confirmation, push button to return to the usual display.</p>

Check method

On the remote controller (Main remote controller, Central control remote controller) and the interface P.C. board of the outdoor unit (I/F), a check display LCD (Remote controller) or 7-segment display (on the outdoor interface P.C. board) to display the operation is provided.

Therefore the operation status can be known. Using this self-diagnosis function, a trouble or position with error of the air conditioner can be found as shown in the table below.

Check code list

The following list shows each check code. Find the check contents from the list according to part to be checked.

- In case of check from indoor remote controller: See "Main remote controller display" in the list.
- In case of check from outdoor unit: See "Outdoor 7-segment display" in the list.
- In case of check from indoor unit with wireless remote controller: See "Sensor block display of receiving unit" in the list.

New check code

1. Difference between the new check code and the current system

The displaying method of the check code changes in this model and after.

	Check code in current system	New check code
Used characters	Hexadecimal notation, 2 digits	Alphabet + Decimal notation, 2 digits
Characteristics of code classification	Few classification of communication/incorrect setup system	Many classification of communication/incorrect setup system
Block display	Indoor P.C. board, Outdoor P.C. board, Cycle, Communication	Communication/Incorrect setup (4 ways), Indoor protection, Outdoor protection, Sensor, Compressor protection, etc.

<Display on wired remote controller>

- [] goes on.
- [UNIT No.] + Check code + Operation lamp (Green) flash

Display	Classification
A	Unused
C	Central control system error
E	Communication system error
F	Each sensor error (Failure)
H	Compressor protective system error
J	Unused
L	Setup error, Other errors
P	Protective device operation

13 MAINTENANCE



For maintenance, be sure to turn off the main power switch.

CAUTION

Do not handle the buttons with wet hands; otherwise an electric shock may be caused.

<Daily maintenance>

Cleaning of air filter

- 1 If  is displayed on the remote controller, contact to service on maintenance professional to cleaning the air filter.
- 2 Clogging of the air filter decreases cooling/heating efficiency.
- 3 After cleaning, push  .
 display disappears.

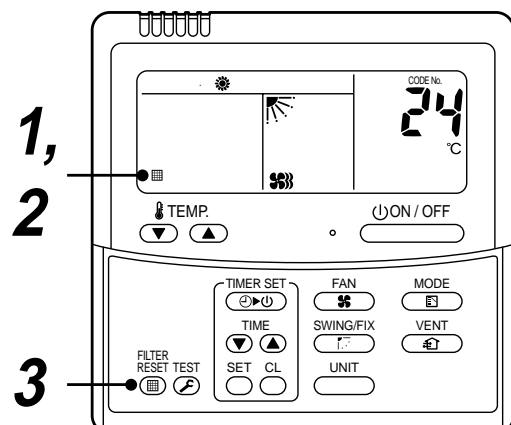

6. CONSTRUCTION VIEWS (EXTERNAL VIEWS)

6-1. Fresh Air Intake Indoor Unit for S-MMS

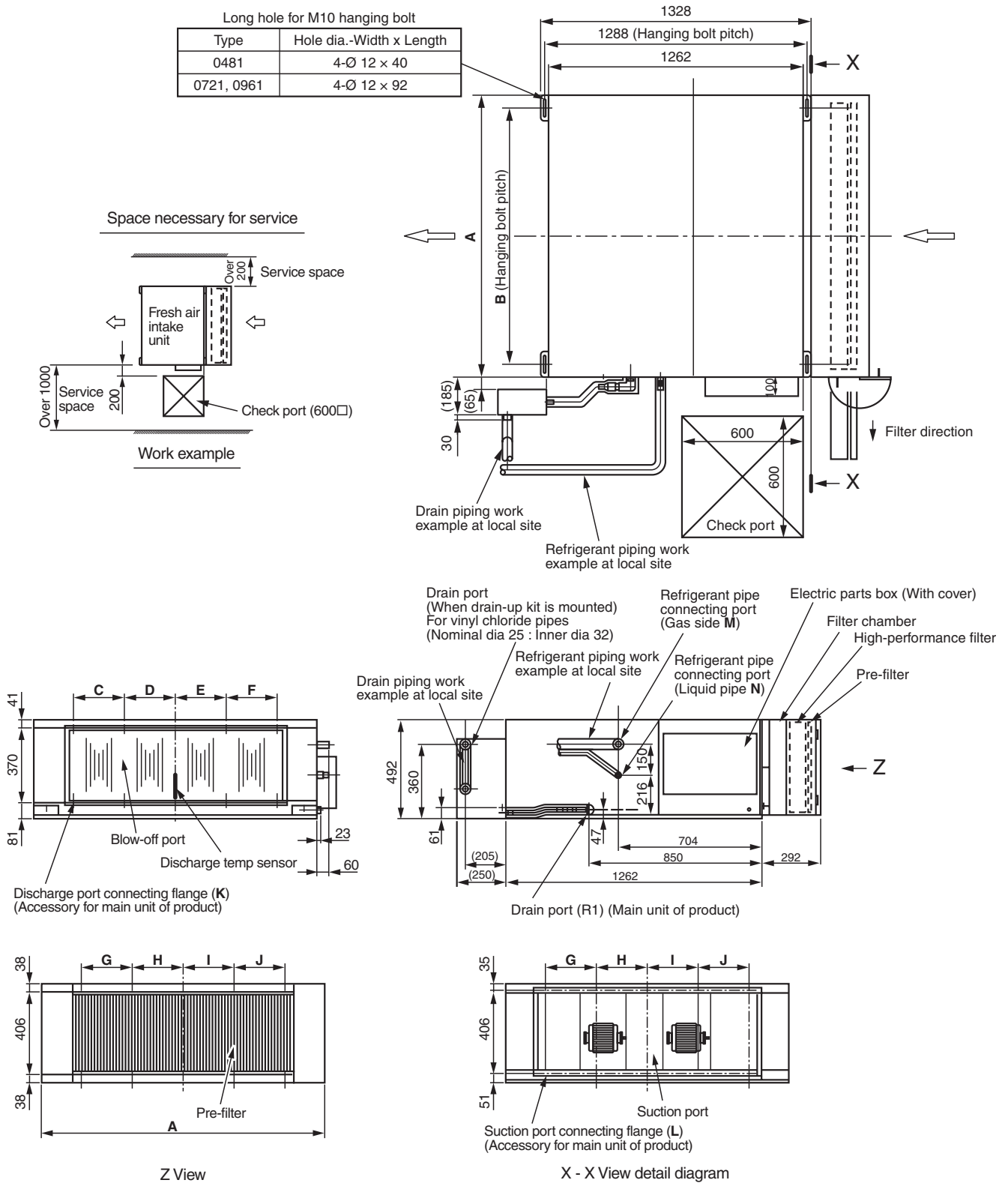

Note 1) The above figure indicates Model MMD-AP0721HFE and AP0961HFE, Model MMD-AP0481HFE one fan motor and one fan is provided.

AP0961HFE	1392	1260	250	250	250	250	250	250	250	250	250	10-M6	10-M6	Ø22.2 brazing	Ø12.7 flare
AP0721HFE	1392	1260	250	250	250	250	250	250	250	250	250	10-M6	10-M6	Ø22.2 brazing	Ø12.7 flare
AP0481HFE	892	810	215	107.5	107.5	215	—	250	250	—	—	8-M6	6-M6	Ø15.9 flare	Ø9.5 flare
Model MMD-	A	B	C	D	E	F	G	H	I	J	K	L	M	N	

7. WIRING DIAGRAM

7-1. Fresh Air Intake Indoor Unit for S-MMS MMD-AP0481HFE

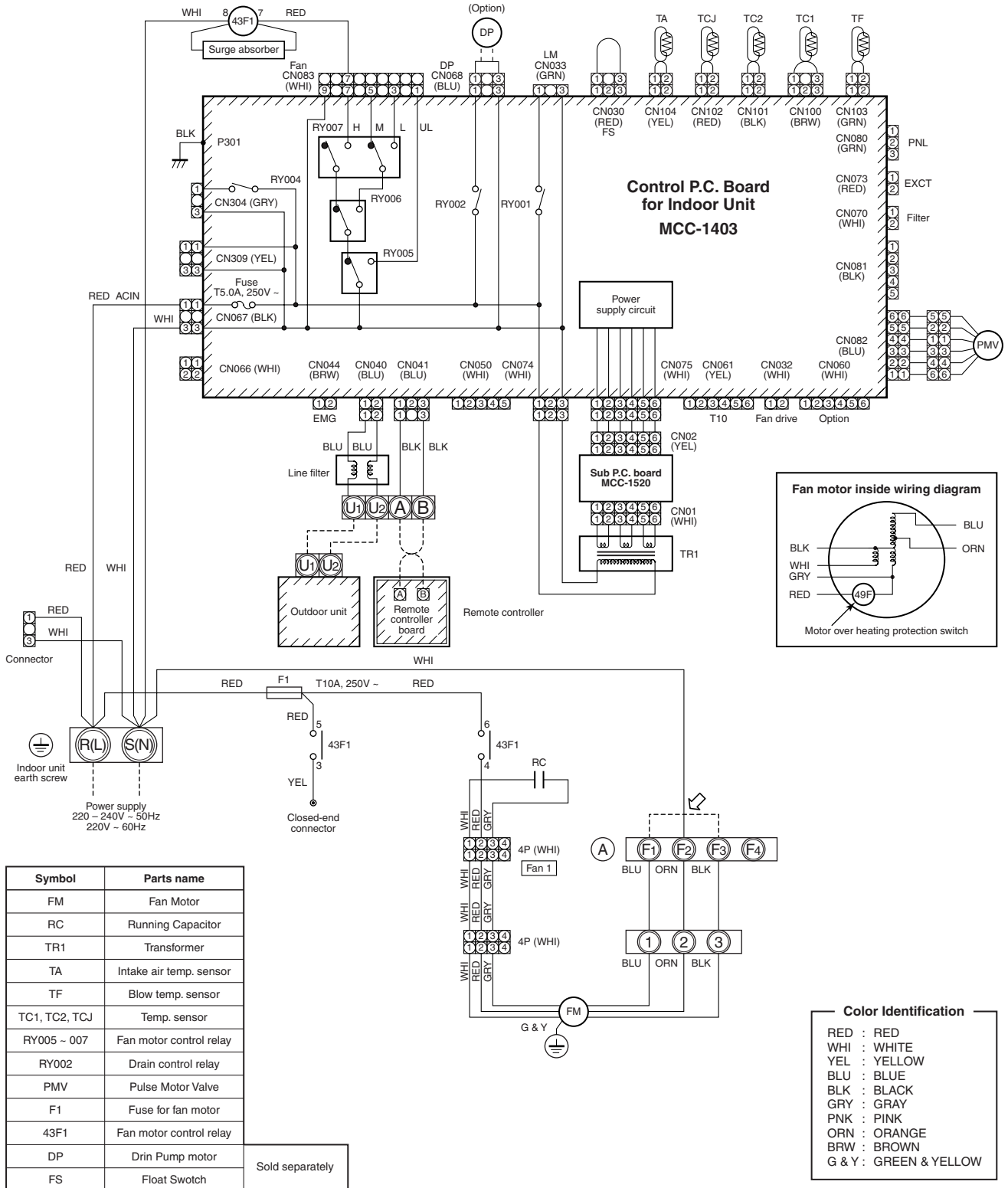

- ⊙ indicates the terminal block.
Letter at inside indicates the terminal number.
- A dotted line and broken line indicate the wiring at site.
- ▨ indicates the control P.C. board.
- When installing the drain pump connect the float switch connector to CN030 connector.
- Ⓐ position is connected to terminal block when change to static pressure.
Exchange the lead wire of arrow (↔) position after the terminal number as figure and lead wire's color of fan motor.

Terminal block No.	Fan motor wiring	Note
F1 (Low static pressure tap)	Blue (50/60Hz)	
F2 (Intermediate static pressure tap)	Orange (50/60Hz)	At shipment from factory
F3 (High static pressure tap)	Black (50/60Hz)	
F4	—	—

MMD-AP0721HFE, MMD-AP0961HFE

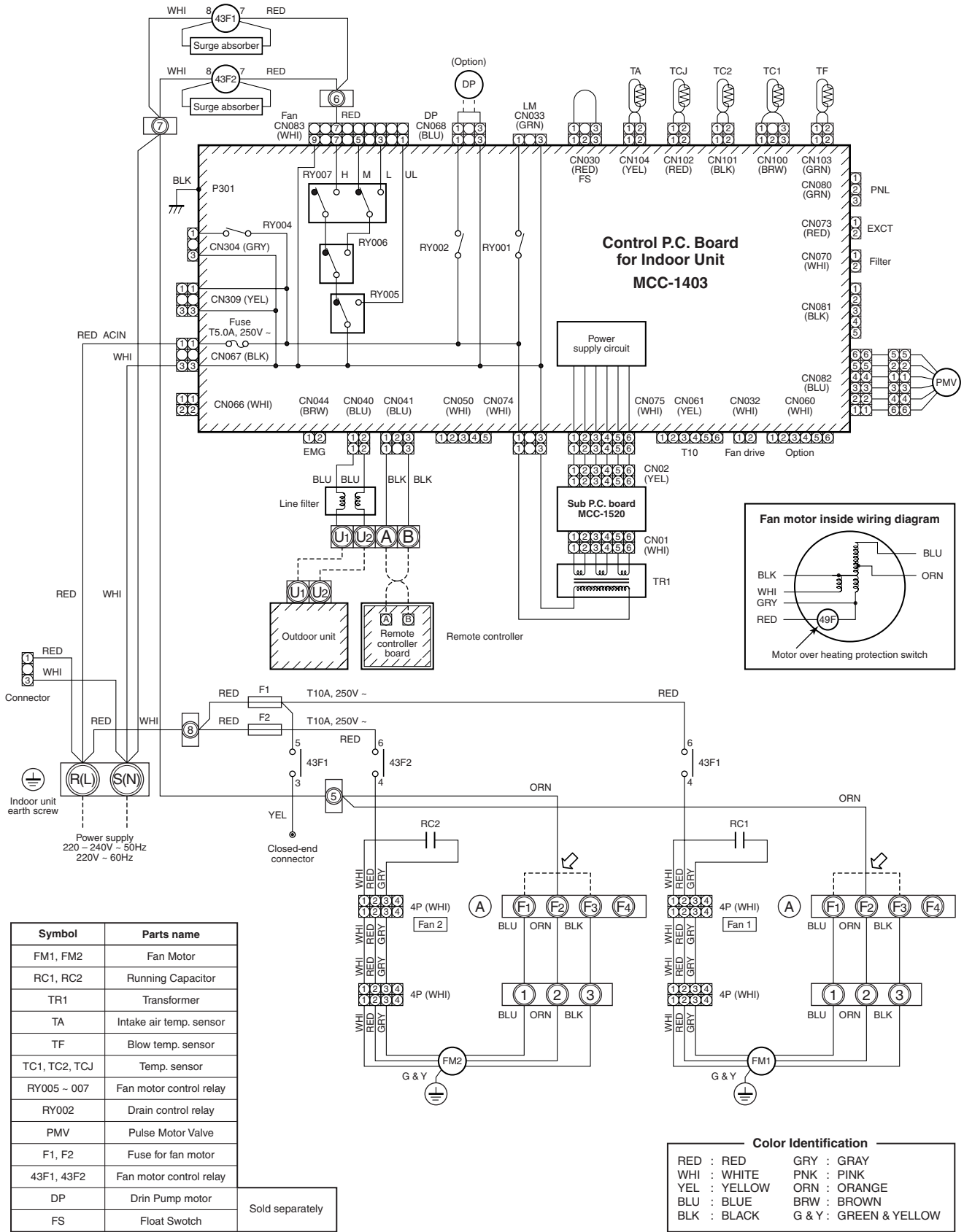

Symbol	Parts name	
FM1, FM2	Fan Motor	
RC1, RC2	Running Capacitor	
TR1	Transformer	
TA	Intake air temp. sensor	
TF	Blow temp. sensor	
TC1, TC2, TCJ	Temp. sensor	
RY005 - 007	Fan motor control relay	
RY002	Drain control relay	
PMV	Pulse Motor Valve	
F1, F2	Fuse for fan motor	
43F1, 43F2	Fan motor control relay	
DP	Drin Pump motor	Sold separately
FS	Float Switch	

Color Identification			
RED	: RED	GRY	: GRAY
WHI	: WHITE	PNK	: PINK
YEL	: YELLOW	ORN	: ORANGE
BLU	: BLUE	BRW	: BROWN
BLK	: BLACK	G & Y	: GREEN & YELLOW

- ⊙ indicates the terminal block.
Letter at inside indicates the terminal number.
- A dotted line and broken line indicate the wiring at site.
- ▨ indicates the control P.C. board.
- When installing the drain pump connect the float switch connector to CN030 connector.
- Ⓐ position is connected to terminal block when change to static pressure.
Exchange the lead wire of arrow (↔) position after the terminal number as figure and lead wire's color of fan motor.

Terminal block No.	Fan motor wiring	Note
F1 (Low static pressure tap)	Blue (50/60Hz)	
F2 (Intermediate static pressure tap)	Orange (50/60Hz)	At shipment from factory
F3 (High static pressure tap)	Black (50/60Hz)	
F4	—	—

8. REFRIGERATING CYCLE DIAGRAM

8-1. Fresh Air Intake Indoor Unit for S-MMS

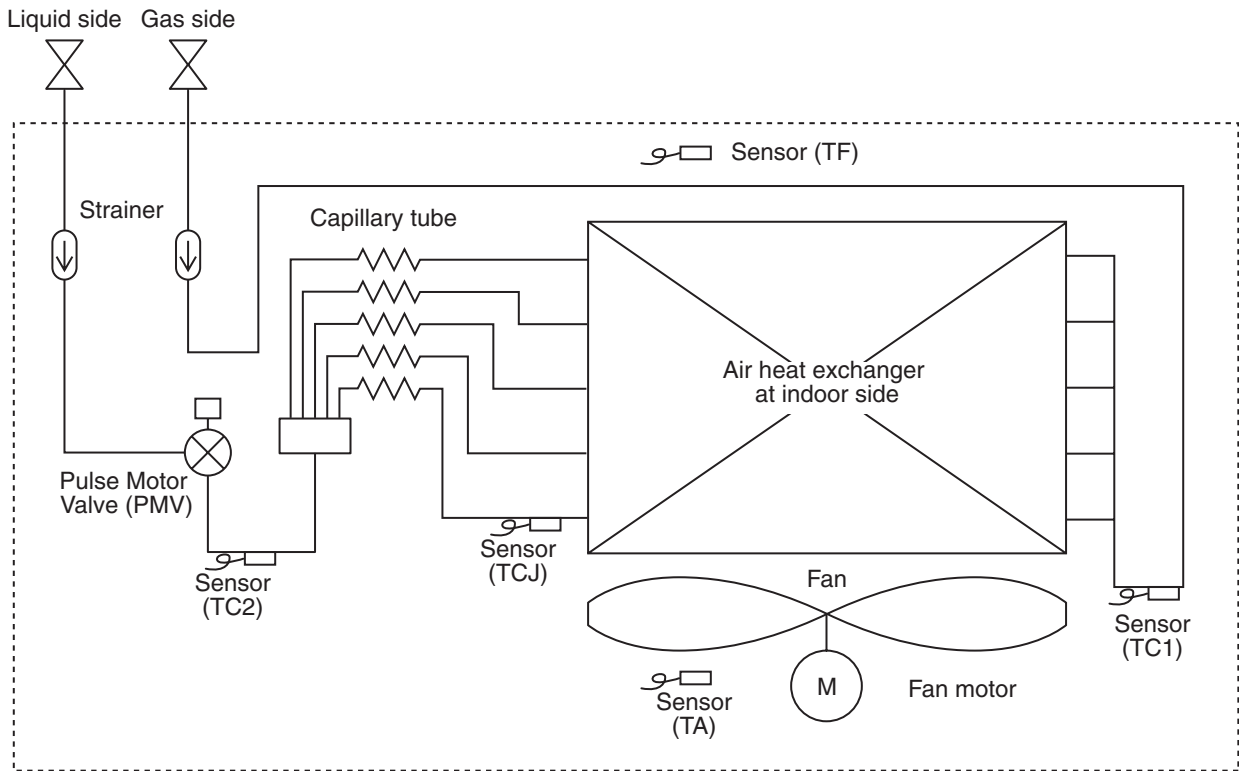

Functional part name		Function outline
Pulse motor valve	PMV	(Connector CN082 (6P): Blue) 1) Super heat control function in cooling operation 2) Under cool control function in heating operation 3) Cooling refrigerant oil recovery function 4) Heating refrigerant oil recovery function
Temperature sensor	1. TA	(Connector CN104 (2P): Yellow) 1) For detection of outdoor suction temperature
	2. TC1	(Connector CN100 (3P): Brown) 1) For super heat control of PMV in cooling operation
	3. TC2	(Connector CN101 (2P): Black) 1) For under cool control of PMV in heating operation
	4. TCJ	(Connector CN102 (2P): Red) 1) For super heat control of PMV in cooling operation
	5. TF	(Connector CN103 (2P): Green) 1) For detection of discharge temperature

9. CONTROL OUTLINE

9-1. Control Specifications

No.	Item	Outline of specifications	Remarks										
1	When power supply is reset	1) Distinction of outdoor units When the power supply is reset, the outdoor units are distinguished, and control is selected according to the distinguished result. 2) If the power supply is reset while a trouble occurs, the check code is once cleared. When abnormal status continues even if operation restarted by pushing ON/OFF button of the remote controller, the check code is displayed again on the remote controller.											
2	Operation selection	1) Based on the operation select command, the operation mode is selected. <table border="1" style="margin-left: auto; margin-right: auto;"> <thead> <tr> <th style="text-align: center;">Command from remote controller</th> <th style="text-align: center;">Control outline</th> </tr> </thead> <tbody> <tr> <td style="text-align: center;">STOP</td> <td>Fresh air intake indoor unit stops.</td> </tr> <tr> <td style="text-align: center;">FAN</td> <td>Fan operation</td> </tr> <tr> <td style="text-align: center;">COOL</td> <td>Cooling operation</td> </tr> <tr> <td style="text-align: center;">HEAT</td> <td>Heating operation</td> </tr> </tbody> </table> * DRY or AUTO mode cannot be selected.	Command from remote controller	Control outline	STOP	Fresh air intake indoor unit stops.	FAN	Fan operation	COOL	Cooling operation	HEAT	Heating operation	
Command from remote controller	Control outline												
STOP	Fresh air intake indoor unit stops.												
FAN	Fan operation												
COOL	Cooling operation												
HEAT	Heating operation												
3	Remote controller setup temperature	1) Adjustment range ① Adjustment range <ul style="list-style-type: none"> • In cooling or heating operation: 16 to 27°C ② At shipment from factory: <ul style="list-style-type: none"> • In cooling operation: 18°C • In heating operation: 25°C 											
4	Capacity control	1) Differed from other indoor air conditioners, the fresh air intake indoor unit usually operates with the maximum capacity.											
5	PMV control	1) Fresh air intake indoor unit controls PMV using the corrected value of each sensor according to the operation mode. ① COOL <ul style="list-style-type: none"> • SH control is performed by correcting indoor coil temp (TC1) and inlet air temp. from outside (TA). ② HEAT <ul style="list-style-type: none"> • UC control is performed by correcting indoor coil temp (TC2, TCJ) and inlet air temp. from outside (TA). 2) The value displayed by monitor function of the remote controller switch becomes the corrected sensor data. (See Monitor function of the remote controller switch.)	Data to be corrected: Inlet air temp. from outside (TA), Indoor coil temp (TCJ, TC2, TC1)										

No.	Item	Outline of specifications	Remarks																																							
6	Fan control	1) On the fresh air intake indoor unit, HH tap only is provided. 2) For 1 minute after operation start, the forced fan OFF control is invalid. 3) There is no cool air discharge preventive control. 4) When refrigerant is recovered while cooling or fan operation is selected, and when cooling oil is recovered while heating operation is selected, the fan continues operation. However the priority is given to forced fan OFF control																																								
7	Forced thermostat OFF	1) The thermostat is forcedly off by outdoor suction temperature (TA). <ul style="list-style-type: none"> • COOL : At $TA < 19^{\circ}\text{C}$ • HEAT : At $TA > 15^{\circ}\text{C}$ or $TA < -5^{\circ}\text{C}$ 2) The thermostat is forcedly off by outdoor suction temperature (TA) and remote controller setting temperature (TS). <ul style="list-style-type: none"> • COOL : At $TA < TS + 3^{\circ}\text{C}$ • HEAT : At $TA > TS - 3^{\circ}\text{C}$ 																																								
8	Forced fan OFF	1) The thermostat is forcedly off by outdoor suction temperature (TA). <ul style="list-style-type: none"> • COOL/FAN: At $TA < 5^{\circ}\text{C}$ • HEAT : At $TA < -5^{\circ}\text{C}$ 2) After fan-OFF status continued for 60 minutes, turn on the fan for 1 minute. The forced fan-OFF status continues or released by outdoor suction temperature (TA) in this time. <Release conditions> <ul style="list-style-type: none"> • COOL/FAN: At $TA \geq 5^{\circ}\text{C}$ • HEAT : At $TA \geq -5^{\circ}\text{C}$ 3) Other forced fan OFF release conditions <ul style="list-style-type: none"> • Operation stop • Operation mode exchange • Test run mode <div data-bbox="491 1547 1094 1850" style="border: 1px solid black; padding: 5px; margin-top: 10px;"> <table border="1" style="width: 100%; border-collapse: collapse; text-align: center;"> <thead> <tr> <th rowspan="2" style="width: 15%;">Operation mode</th> <th colspan="7" style="width: 85%;">Outside temp ($^{\circ}\text{C}$)</th> </tr> <tr> <th>-10</th> <th>0</th> <th>10</th> <th>20</th> <th>30</th> <th>40</th> <th>50</th> </tr> </thead> <tbody> <tr> <td>COOL</td> <td></td> <td>-5$^{\circ}\text{C}$</td> <td></td> <td></td> <td></td> <td>$T_s + 3$</td> <td>43$^{\circ}\text{C}$</td> </tr> <tr> <td>HEAT</td> <td></td> <td></td> <td>$T_s - 3$</td> <td></td> <td></td> <td></td> <td></td> </tr> <tr> <td>FAN</td> <td></td> <td></td> <td></td> <td></td> <td></td> <td></td> <td></td> </tr> </tbody> </table> </div>	Operation mode	Outside temp ($^{\circ}\text{C}$)							-10	0	10	20	30	40	50	COOL		-5 $^{\circ}\text{C}$				$T_s + 3$	43 $^{\circ}\text{C}$	HEAT			$T_s - 3$					FAN								Operation ready display
Operation mode	Outside temp ($^{\circ}\text{C}$)																																									
	-10	0	10	20	30	40	50																																			
COOL		-5 $^{\circ}\text{C}$				$T_s + 3$	43 $^{\circ}\text{C}$																																			
HEAT			$T_s - 3$																																							
FAN																																										

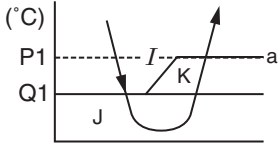
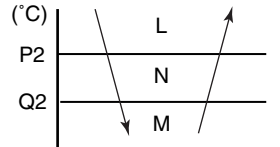
No.	Item	Outline of specifications	Remarks															
9	Freeze preventive control (Low temperature release)	<p>1) The cooling operation is performed as follows based on the detected temperature of TC1 sensor, TC2 sensor and TCJ sensor.</p> <ul style="list-style-type: none"> When [J] zone is detected for 5 minutes, thermostat is forcedly off. In [K] zone, timer counting pauses and is held. When [J] zone is detected, timer is cleared and returns to normal operation. If thermostat is forcedly off by continuation of [J] zone, indoor fan only operates until zone changes to [I] zone. <p>When the following conditions are satisfied, control function resets.</p> <p><Reset conditions></p> <ol style="list-style-type: none"> TC1 $\geq 12^{\circ}\text{C}$ and TC2 $\geq 12^{\circ}\text{C}$ and TCJ $\geq 12^{\circ}\text{C}$ 20 minutes passed after stop <div style="display: flex; align-items: flex-start;"> <div style="margin-right: 20px;">  <p>The graph shows temperature in degrees Celsius on the y-axis. A curve starts at a high temperature, drops through zone J, reaches a minimum, rises through zone I, and then through zone K. Horizontal lines represent levels P1 and Q1. A dashed line 'a' is also shown.</p> </div> <table border="1" data-bbox="805 795 1149 918"> <thead> <tr> <th></th> <th>TC1</th> <th>TC2, TCJ</th> </tr> </thead> <tbody> <tr> <td>P1</td> <td>10°C (5°C)</td> <td>-10°C</td> </tr> <tr> <td>Q1</td> <td>0°C</td> <td>-14°C</td> </tr> </tbody> </table> </div> <p>() value: When power supply is turned on, if the value is under this temperature, thermostat is forcedly off.</p> <p>2) The cooling operation is performed as follows based on the detected temperature of TC2 sensor and TCJ sensor.</p> <ul style="list-style-type: none"> When [M] zone is detected for 45 minutes, thermostat is forcedly off. In [N] zone, timer counting pauses and is held. When shifting to [M] zone again, timer counting restarts and continues. When [L] zone is detected, timer is cleared and operation returns to normal operation. <div style="display: flex; align-items: flex-start;"> <div style="margin-right: 20px;">  <p>The graph shows temperature in degrees Celsius on the y-axis. A curve starts at a high temperature, drops through zone L, reaches a minimum, rises through zone N, and then through zone M. Horizontal lines represent levels P2 and Q2.</p> </div> <table border="1" data-bbox="805 1467 1149 1590"> <thead> <tr> <th></th> <th>TC2, TCJ</th> </tr> </thead> <tbody> <tr> <td>P2</td> <td>5</td> </tr> <tr> <td>Q2</td> <td>-2.0</td> </tr> </tbody> </table> </div> <p><Reset conditions></p> <ol style="list-style-type: none"> TC1 $\geq 12^{\circ}\text{C}$ and TC2 $\geq 12^{\circ}\text{C}$ and TCJ $\geq 12^{\circ}\text{C}$ 20 minutes passed after stop 		TC1	TC2, TCJ	P1	10°C (5°C)	-10°C	Q1	0°C	-14°C		TC2, TCJ	P2	5	Q2	-2.0	
	TC1	TC2, TCJ																
P1	10°C (5°C)	-10°C																
Q1	0°C	-14°C																
	TC2, TCJ																	
P2	5																	
Q2	-2.0																	

No.	Item	Outline of specifications	Remarks
10	Drain-up kit (Separately sold kit)	1) In cooling operation (including Dry operation), the drain pump is usually operated. 2) If the float switch operates while drain pump operates, the compressor stops, the drain pump continues the operation, and a check code is output. 3) If the float switch operates while drain pump stops, the compressor stops and the drain pump operates. If the float switch keeps operating for approx. 4 minutes, a check code is output.	Check code [P10]
11	Cooling oil (Refrigerant) recovery control	When the indoor air conditioner which stops, in which thermostat is off, or which operates [FAN] performs the following control by receiving the cooling oil (refrigerant) recovery signal from the outdoor unit. ① Opens PMV of the indoor air conditioner with certain opening angle.	<ul style="list-style-type: none"> • Recovery operation is usually performed every 2 hours.
12	Heating refrigerant (oil) recovery control	When the indoor air conditioner which stops, in which thermostat is off, or which operates [FAN] performs the following control by receiving the heating refrigerant (oil) recovery signal from the outdoor unit. ① Opens PMV of the indoor air conditioner with certain opening angle. ② Detects temperature of TC2 and closes PMV.	<ul style="list-style-type: none"> • Recovery operation is usually performed every 1 hour.
13	Short intermittent operation compen- sation control	1) For 5 minutes after start of operation, the operation continues forcedly even if entering in thermostat OFF condition. (2) However cooling/heating selection, operation ready and protective control are given with priority, and thermostat is turned off.	
14	Remained heat elimination	1) If stopped from [HEAT] operation, the indoor fan operates for approx. 30 seconds.	
15	Filter sign display	1) Estimates operation time of the indoor fan, sends the filter exchange signal to remote controller when the specified time (2500H) passed and then displays it on LCD. 2) Clears the estimate timer when received filter reset signal from remote controller. In this time, if the specified time has passed, resets the measured time and erases the LCD display.	

No.	Item	Outline of specifications	Remarks																																																		
16	[Operation stand-by] [Heating stand-by] display	<p><Ready stand-by>: displayed on the remote controller.</p> <ol style="list-style-type: none"> 1) When the following check codes are indicated. <ul style="list-style-type: none"> • There is an indoor air conditioner which detected indoor overflow [P10]. • There is an indoor air conditioner which detected interlock warning [L30]. 2) During forced thermo OFF. <ul style="list-style-type: none"> • [COOL] operation is unavailable because other indoor air conditioner operates in [HEAT] mode. • COOL priority setting (Outdoor I/F P.C. board SW11-bit1 is ON) is made, and other indoor air conditioner operates in [COOL/DRY] mode. Therefore [HEAT] operation is unavailable. 3) When fan stops by forced fan OFF control. 4) The above indoor air conditioners unavailable to operate enter in [Standby] status with thermo-OFF. <p><HEAT stand-by>: displayed on the remote controller.</p> <ol style="list-style-type: none"> 1) Defrosting <ul style="list-style-type: none"> • Indoor fan stops because unit is under defrost operation. 	<ul style="list-style-type: none"> • [Operation stand-by] display • [Heating stand-by] display 																																																		
17	Central control mode selection	<ol style="list-style-type: none"> 1) The remote controller at indoor air conditioner side becomes able to select the operable contents of the unit by setup at the central controller side. 2) Setup contents <p>• In case of TCC-LINK central control</p> <table border="1" data-bbox="233 1288 1428 1590"> <thead> <tr> <th data-bbox="233 1288 437 1391" rowspan="2">Operation from TCC-LINK central controller</th> <th colspan="6" data-bbox="437 1288 1262 1323">Operation on RBC-ATM31E</th> <th data-bbox="1262 1288 1428 1391" rowspan="2">RBC-AMT31E</th> </tr> <tr> <th data-bbox="437 1323 572 1391">START/STOP setting</th> <th data-bbox="572 1323 708 1391">Operation selection</th> <th data-bbox="708 1323 844 1391">Timer setting</th> <th data-bbox="844 1323 979 1391">Temp setting</th> <th data-bbox="979 1323 1117 1391">Air speed setting</th> <th data-bbox="1117 1323 1262 1391">Air direction setting</th> </tr> </thead> <tbody> <tr> <td data-bbox="233 1391 437 1429">Single</td> <td data-bbox="437 1391 572 1429">○</td> <td data-bbox="572 1391 708 1429">○</td> <td data-bbox="708 1391 844 1429">○</td> <td data-bbox="844 1391 979 1429">○</td> <td data-bbox="979 1391 1117 1429">—</td> <td data-bbox="1117 1391 1262 1429">—</td> <td data-bbox="1262 1391 1428 1590" rowspan="5">[Central control] display</td> </tr> <tr> <td data-bbox="233 1429 437 1467">[Central 1]</td> <td data-bbox="437 1429 572 1467">✕</td> <td data-bbox="572 1429 708 1467">○</td> <td data-bbox="708 1429 844 1467">✕</td> <td data-bbox="844 1429 979 1467">○</td> <td data-bbox="979 1429 1117 1467">—</td> <td data-bbox="1117 1429 1262 1467">—</td> </tr> <tr> <td data-bbox="233 1467 437 1505">[Central 2]</td> <td data-bbox="437 1467 572 1505">✕</td> <td data-bbox="572 1467 708 1505">✕</td> <td data-bbox="708 1467 844 1505">✕</td> <td data-bbox="844 1467 979 1505">✕</td> <td data-bbox="979 1467 1117 1505">—</td> <td data-bbox="1117 1467 1262 1505">—</td> </tr> <tr> <td data-bbox="233 1505 437 1543">[Central 3]</td> <td data-bbox="437 1505 572 1543">○</td> <td data-bbox="572 1505 708 1543">✕</td> <td data-bbox="708 1505 844 1543">○</td> <td data-bbox="844 1505 979 1543">✕</td> <td data-bbox="979 1505 1117 1543">—</td> <td data-bbox="1117 1505 1262 1543">—</td> </tr> <tr> <td data-bbox="233 1543 437 1590">[Central 4]</td> <td data-bbox="437 1543 572 1590">○</td> <td data-bbox="572 1543 708 1590">✕</td> <td data-bbox="708 1543 844 1590">○</td> <td data-bbox="844 1543 979 1590">○</td> <td data-bbox="979 1543 1117 1590">—</td> <td data-bbox="1117 1543 1262 1590">—</td> </tr> </tbody> </table> <p data-bbox="204 1608 769 1641">(○ : Operation available, ✕: Operation unavailable)</p> <p data-bbox="204 1693 1369 1727">* For the Fresh air intake indoor unit, setting functions for air speed and air direction are not provided.</p>	Operation from TCC-LINK central controller	Operation on RBC-ATM31E						RBC-AMT31E	START/STOP setting	Operation selection	Timer setting	Temp setting	Air speed setting	Air direction setting	Single	○	○	○	○	—	—	[Central control] display	[Central 1]	✕	○	✕	○	—	—	[Central 2]	✕	✕	✕	✕	—	—	[Central 3]	○	✕	○	✕	—	—	[Central 4]	○	✕	○	○	—	—	<ul style="list-style-type: none"> • In central control mode, [Central control] display (Lights up) • Display flashes when item which operation is prohibited was changed from remote controller.
Operation from TCC-LINK central controller	Operation on RBC-ATM31E						RBC-AMT31E																																														
	START/STOP setting	Operation selection	Timer setting	Temp setting	Air speed setting	Air direction setting																																															
Single	○	○	○	○	—	—	[Central control] display																																														
[Central 1]	✕	○	✕	○	—	—																																															
[Central 2]	✕	✕	✕	✕	—	—																																															
[Central 3]	○	✕	○	✕	—	—																																															
[Central 4]	○	✕	○	○	—	—																																															

10-2. Indoor P.C. Board Optional Connector Specifications

Function	Connector No.	Pin No.	Specifications	Remarks
Ventilation output	CN032	①	DC12V	Setting at shipment: Linked operation; ON with indoor air conditioner operation, OFF with stop * Single operation setting by [VENT] button of remote controller is performed from remote controller. (DN=31)
		②	Output	
HA	CN061	①	Start/Stop input	HA Start/Stop input (J01: Provided/None=Pulse (At shipment from factory) / Static input selection)
		②	0V (COM)	
		③	RBC-AMT31E, RC-AS21E2 prohibition input	Operation stop of RBC-AMT31E is allowed / prohibited by input.
		④	Operation output	ON during operation (Answer back of HA)
		⑤	DC12V (COM)	
		⑥	Alarm output	ON during output of alarm
Option output	CN060	①	DC12V (COM)	
		②	Defrost output	ON during defrosting of outdoor unit
		③	Thermo-ON output	ON during real thermo-ON (Compressor ON)
		④	Cooling output	ON when operation mode is COOL
		⑤	Heating output	ON when operation mode is HEAT
		⑥	Fan output	ON when indoor fan is on (When purifier is used / Interlock wiring)
Outside abnormal input	CN080	①	DC12V (COM)	The check code "L30" is generated continuously for 1 minute and the operation stops forcedly.
		②	DC12V (COM)	
		③	Outside abnormal input	
Filter option error	CN070	①	Outside setting input	Setting of humidifier provided / none (Short plug attached at shipment from factory)
		②	0V	
CHK operation check	CN071	①	Check mode input	This function is used to check indoor operation. (The specified operation such as indoor fan "ON" is output without communication with outdoor or remote controller.)
		②	0V	
DISP display mode	CN072	①	Display mode input	This function enables the display mode to communicate with indoor air conditioner and remote controller only. (When power supply is turned on) Timer short (Usually)
		②	0V	
EXCT demand	CN073	①	Demand input	Forced thermo-OFF operation of indoor air conditioner.
		②	0V	

10-3. Function during Test Operation

■ Cooling / Heating Test Operation Check



The test operation for cooling/heating operation can be performed from either indoor remote controller or outdoor interface P.C. board.

1. Start / Stop operation of test operation

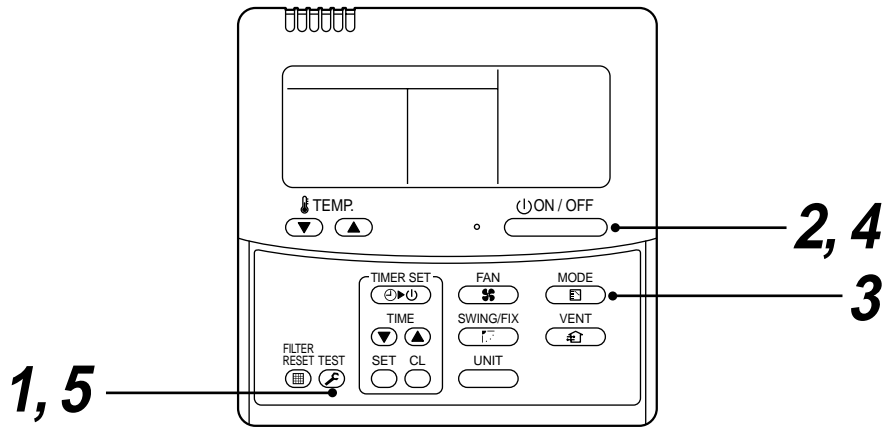
- Test operation from indoor remote controller

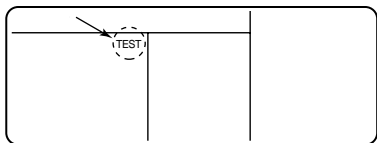
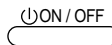
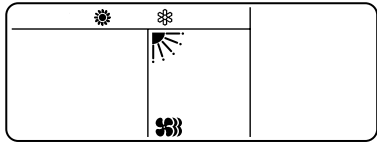
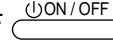

<Wired remote controller>

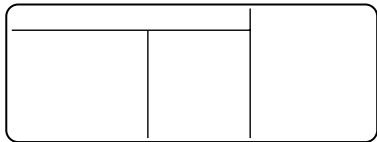
Procedure	Operation contents
1	When pushing [CHECK] button for 4 seconds or more, [TEST ] is displayed on the display part and the mode enters in Test operation mode. 
2	Push [ON / OFF ] button.
3	Using [MODE] button, select an operation mode, [COOL] or [HEAT]. <ul style="list-style-type: none"> • Do not use other than [COOL] / [HEAT] mode. • Temperature cannot be adjusted during test operation. • Detection of error is performed as usual. 
4	When test operation finished, push [ON / OFF ] button to stop operation. (The same display as Procedure 1 is displayed.)
5	Push [CHECK] button to release the Test operation mode. ([TEST ] display on the display part disappears and the status becomes normal stop status.) 

NOTE) The Test run operation returns to the normal operation after 60 minutes elapsed.

■ Operation Check Function for Indoor Air Conditioner (Function at Indoor Air Conditioner Side)

This function is to check the operation by the indoor air conditioner singly without communication with the remote controller or outdoor unit. This function is available regardless of system-ON or system-OFF.

However a trouble of the equipment may be caused if using this function for a long time. Use this function for approx. several minutes as a standard.

[Operation]

- 1) Short-cut CHK pin (CN71 on indoor P.C. board). In this time, the operation mode differs according to status of the indoor air conditioner.

Normal time : Float SW and fan motor are normal.

Abnormal time: Either float SW or fan motor is abnormal.

* A float switch is not provided on the fresh air intake indoor unit.

The short plugs for the float switch are already inserted at shipment from the factory.

- 3) Restricted to the normal time, if DISP pin (CN72 on indoor P.C. board) is short cut in addition to short-circuited CHK pin (CN71 on indoor P.C. board), you can set opening of indoor PMV only to the minimum opening (30pls). Opening DISP pin sets opening to the maximum opening (1500pls) again.

[Releasing]

Open the CHK pin. While the system is operating, it stops once but resets automatically after several minutes.

	CHK pin short-circuit		
	Normal time		Abnormal time
	DISP pin open	DISP pin short-circuit	
Fan motor	ON	ON	OFF
Indoor PMV (*)	Max. opening (1500pls)	Min. opening (30pls)	Min. opening (30pls)
Communication	All ignored	All ignored	All ignored
P.C. board LED	Go on	Go on	Flash

* When replacing the indoor PMV coil, set the indoor PMV to the maximum opening.

* For detailed positions of CHK pin (CN71 on indoor P.C. board) and DISP pin (CN72 on indoor P.C. board), refer to the indoor P.C. board MCC-1403.

10-4. Function Selection Setting for Indoor Air Conditioner (For setup, be sure to use a wired remote controller)

<Procedure> Select a function while the air conditioner stops by RBC-AMT31E only.

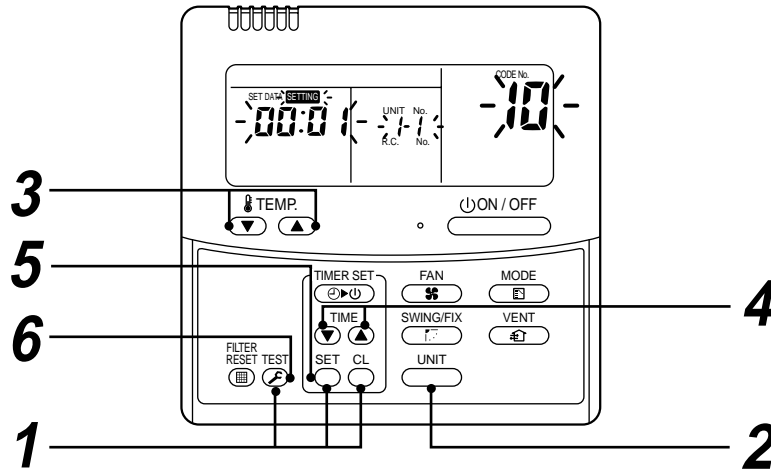

<Operation procedure>

1 ⇒ **2** ⇒ **3** ⇒ **4** ⇒ **5** ⇒ **6** END

1 Push **TEST** + **SET** + **CL** buttons concurrently for 4 seconds or more.

The unit No. firstly displayed indicates the indoor air conditioner address of the master unit of the group control. In this time, the fans of the selected indoor air conditioners operate.



2 Every pushing **UNIT** button displays the indoor air conditioner No. in the group control one by one. In this time, the fan of the selected indoor air conditioner only operates.



3 Using temperature setting **▼**, **▲** buttons, specify the item code [DN].



4 Using timer time **▼**, **▲** buttons, select a setting data.



5 Push **SET** button. (OK if display goes on)

- To change the selected indoor air conditioner, return to procedure **2**.
- To change an item to be set up, return to procedure **3**.



6 Pushing **TEST** button enters in the normal stop status.

Function Select Item No. (DN) Table
(Indicates items necessary to perform the applicable control at local site)

DN	Item	Contents	At shipment from factory
01	Filter sign lighting time	0000: None 0002: 2500H 0004: 10000H 0001: 150H 0003: 5000H	0002: 2500H
02	Filter dirty degree	0000: Standard 0001: Heavy dirt (Half of standard time)	0000: Standard
03	Central control address	0001: No.1 unit ~ 0064: No.64 unit 0099: Undefined	0099: Undefined
04	Priority to specific indoor air conditioner	0000: No priority 0001: Priority	0000: No priority
0d	Cooling/Heating AUTO mode provided / None	0000: AUTO Cooling/Heating provided 0001: No AUTO Cooling/Heating (Automatic selection by connected outdoor unit)	0001: No AUTO Cooling/Heating
0F	Cooling only	0000: Heat pump 0001: Cooling only (No [AUTO] [HEAT] display)	0000: Heat pump
10	Type	0000: (1-way Air Discharge Cassette Type) 0001: (4-way Air Discharge Cassette Type) ~ 0037	0016: Fresh air intake indoor unit
11	Indoor air conditioner capacity	0000: Undefined 0001 ~ 0034	According to capacity type
12	Line address	0001: No.1 unit ~ 0028: No.28 unit	0099: Undefined
13	Indoor air conditioner address	0001: No.1 unit ~ 0064: No.64 unit	0099: Undefined
14	Group address	0000: Single 0002: Group follower 0001: Group master	0099: Undefined
28	Automatic reset of power failure	0000: None 0001: Provided	0000: None
2E	HA terminal (T10) selection	0000: Normal (JEMA) 0001: Card input (shuffling omission)	0000: Normal (HA terminal)
31	Fan (Single operation)	0000: Unavailable 0001: Available	0000: Unavailable
C8	Fresh air intake indoor unit	0000: Undefined 0001: Mixed	0001: Mixed

10-5. Applicable Control of Indoor Air Conditioner

■ Control system using the remote control interface (TCB-IFCB4E)

[Wiring and Setting]

- In case of a group control, the system operates by connecting with any indoor air conditioner (Control P.C. board) in the group. However, when taking out operation error signal from the other air conditioners, take out from the single air conditioner.

1. Control items

- 1) Start/Stop input: Stops operation of air conditioner
- 2) Operation signal: Outputs that normal operation is performed
- 3) Error signal: Outputs during alarm (Serial communication error or indoor/Outdoor protective device) is operating

2. Wiring diagram using the remote control interface (TCB-IFCB4E)

- Input:** IFCB4E: No-voltage ON/OFF continuous signal
- Output:** No-voltage contact (For operation/ error display)
Contact capacity: Up to Maximum AC240V 1A

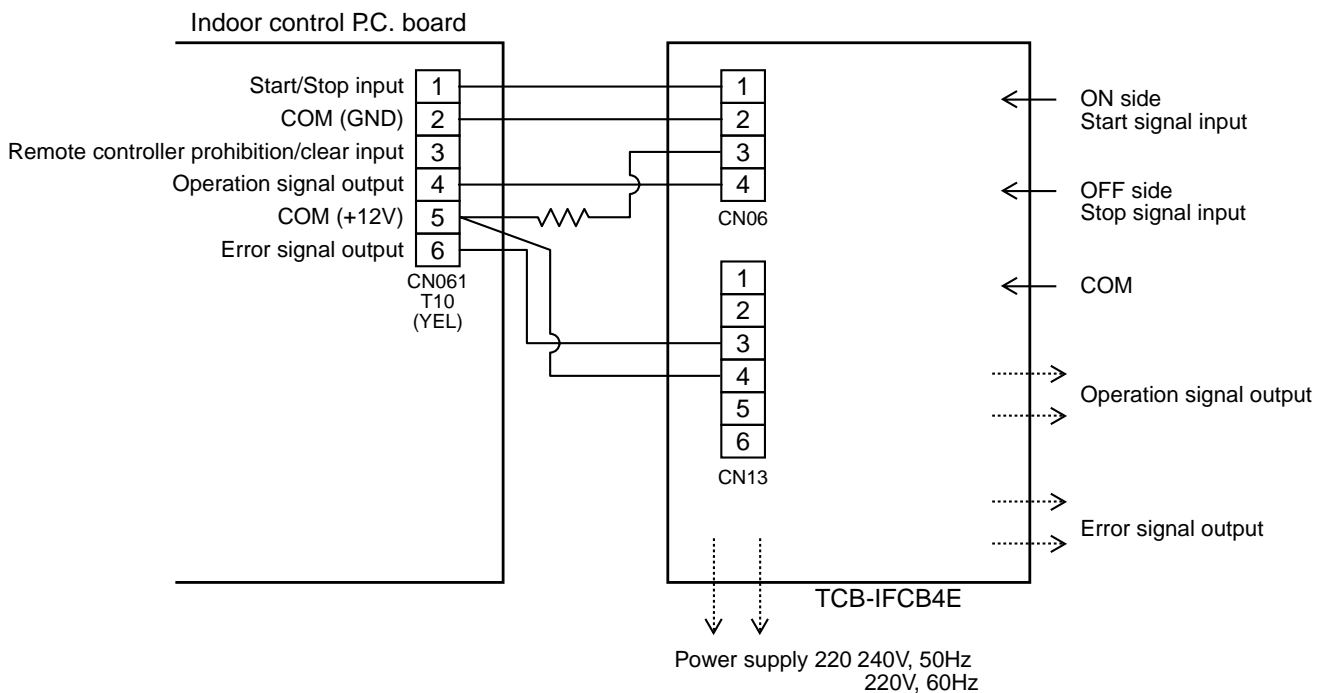

■ Operation of ventilating fan from remote controller

[Function]

- Total enthalpy heat exchanger and ventilating fan can be mounted in the system and they can be started / stopped from a wired remote controller.
- Operation of the ventilating fan is available even if the indoor air conditioner does not operate.
- Use a ventilating fan which can receive the no-voltage A contact as external input signal.
- In group control, all the units are batched and each unit cannot be singly operated.

1. Operation

Operate the wired remote controller switch in the following procedure:

- * Operation should be performed during stop of the unit.
- * Be sure to execute setting to the master unit. (Same in group control)
- * In group control, both master and follower units become available to operate when setting up to the master unit.

1 Push + + buttons concurrently for 4 seconds or more.

The unit No. firstly displayed indicates the indoor air conditioner address of the master unit of the group control. In this time, the fans of the selected indoor air conditioners operate.



2 Every pushing button displays the indoor air conditioner No. in the group control one by one. In this time, the fan of the selected indoor air conditioner only operates.



3 Using temperature setting , buttons, specify the item code 31.



4 Using timer time , buttons, select a setting data. (At shipment: 0000)

Setting data is as follows:

Setting data	Operation of total enthalpy heat exchanger or ventilating fan
0000	Unavailable (At shipment)
0001	Available



5 Push button. (OK if display goes on)

- To change the selected indoor air conditioner, return to procedure 2.
- To change an item to be set up, return to procedure 3.



6 Pushing button enters in the normal stop status.

2. Wiring

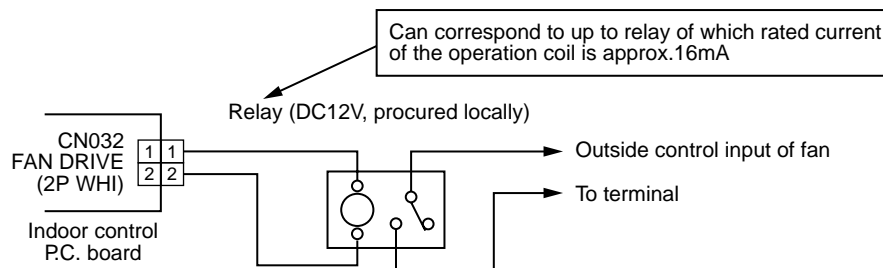

NOTE) Restrict wire length between indoor control P.C. board and relay within 2m.

■ Leaving-on prevention control

[Function]

- This control controls the indoor air conditioner singly.
The wire is connected to the control P.C. board of the indoor air conditioner.
- In group control, the wire is connected to the indoor air conditioner (Control P.C. board) and set the item code $\mathcal{Z}E$ to the connected indoor air conditioner.
- It is used when the external operation is unnecessary but the stop operation is necessary.
- If using a card switch box, card lock or etc. is used, turn-off omission of the indoor air conditioner can be prevented.
 - When inserting the card, ON/OFF operation from RBC-AMT31E is allowed.
 - When pulling off the card, the unit stops if the indoor air conditioner operates and Start/Stop operation from RBC-AMT31E is prohibited.

1. Control items

- 1) **External contact is ON:** ON/OFF operation from RBC-AMT31E is allowed.
(Status that card is inserted in the card switch box)
- 2) **External contact is OFF:** The unit forcedly stops when the indoor air conditioner operates.
(ON/OFF operation from RBC-AMT31E is prohibited.)
(Status that card is taken off from the card switch box)
 - In a case of the card switch box which does not become the above contact operation, convert it to relay with b contact.

2. Operation

Operate the wired remote controller switch in the following procedure:

* Operation should be performed during stop of the unit.

- 1 Push SET + CL + TEST buttons concurrently for 4 seconds or more.
- 2 Using setup temperature ▼ , ▲ buttons, specify the item code $\mathcal{Z}E$.
- 3 Using timer time ▼ , ▲ buttons, set the setting data to 0001 .
- 4 Push SET button.
- 5 Push TEST button. (The status becomes normal stop status.)

3. Wiring

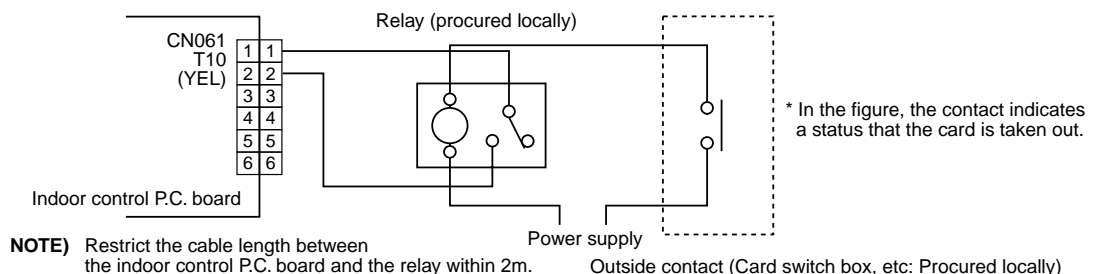

■ Demand control

When the relay is on, the operation becomes to forced thermo-OFF operation.

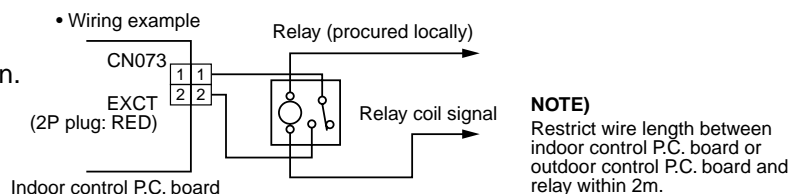

■ Setting of indoor air conditioner in “Specific indoor air conditioner priority” mode

Change the setting during stop of the system. (Be sure that setting is performed during stop of the system.)

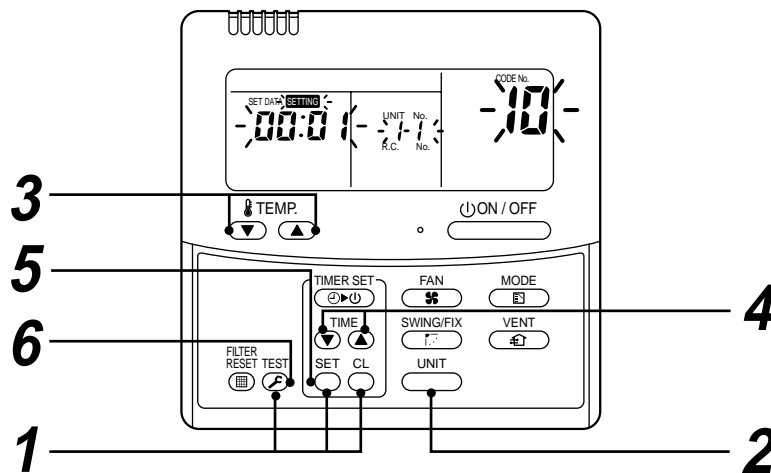

Procedure	Operation contents
1	<p>Push SET + CL + TEST buttons concurrently for 4 seconds or more.</p> <p>After some time, the display part flashes as shown below.</p> <p>Check the displayed item code is [10].</p> <ul style="list-style-type: none"> When the displayed item code is other than [10], push TEST button to erase the display and then start from the first step. (The operation from the remote controller is not accepted for approx. 1 minute after pushing TEST button.) (In group control, the firstly displayed indoor air conditioner No. becomes master unit.)
2	<p>Every pushing UNIT button, the indoor air conditioner No. in the group control is displayed one by one.</p> <p>Select an indoor air conditioner of which setting is changed.</p> <p>In this time, the location of the indoor air conditioner of which setting is changed can be confirmed because fan and flap of the selected indoor air conditioner operate.</p>
3	<p>Using the setting temperature ▼ / ▲ buttons, specify the item code [04].</p>
4	<p>Using the timer time ▼ / ▲ buttons, select the setting data [0001].</p> <p>Priority: 0001, Without priority: 0000</p>
5	<p>Push SET button. When the display changed from flashing to lighting, the setting finished.</p>
6	<p>After finish of setting, push TEST button. (Setting has determined.)</p> <p>When pushing TEST button, the display disappears and the status enters in the normal stop status.</p> <p>(After pushing TEST button, operation from the remote controller is nor accepted for approx. 1 minute.)</p>

(NOTE)

Only one indoor air conditioner can be set to “With priority”. When multiple indoor air conditioners are set to “With priority” in mistake, an error code (L05 or L06 : Indoor air conditioners priority duplicated) is displayed on the remote controller.

For the unit displaying “L05”, [0001 (With priority)] is set up. Leave one air conditioner to give priority among the indoor air conditioners displayed with “L05” and then return setup data of the other air conditioners to [0000 (No priority)].

Error code	Error contents
L05	Indoor air conditioners priority duplicated ([0001] is set up.)
L06	Indoor air conditioners priority duplicated ([0000] is set up.)

■ Monitor function of remote controller switch

Model: When using a remote controller RBC-AMT31E, the following monitor function is utilized.

Calling of display

<Contents>

Call the service monitor mode from the remote controller. The sensor temperature or operation status of each remote controller, indoor air conditioner and outdoor unit can be observed.

<Procedure>

- 1 Push **TEST** + **CL** buttons concurrently for 4 seconds or more to call the service monitor mode.

The service monitor goes on and firstly temperature of the item code **00** is displayed.



- 2 Push **TEMP.** **TEMP.** buttons to change item No. to one (item code) of the item to be monitored.

For display codes, see the following table.



- 3 Push **UNIT** button to change the item to be monitored and then monitor the sensor temperature or operation status of the indoor air conditioner and the outdoor unit in the refrigerant line.



- 4 Pushing **TEST** button returns display to the usual display.

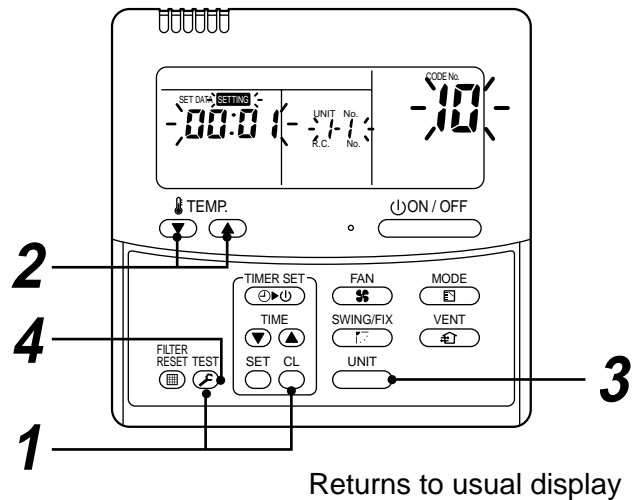

Returns to usual display

<Operation procedure>

1 → 2 → 3 → 4 ←

	Item code	Data name	Unit	Display type		Item code	Data name	Unit	Display type
Indoor air conditioner data (Note 2)	00	Inlet air temp. from outside (TA)	°C	x 1	Single data of outdoor unit (Note 4, 5)	10	Compressor 1 discharge temp (Td1)	°C	x 1
	01	Room temp (Remote controller)	°C	x 1		11	Compressor 1 discharge temp (Td2)	°C	x 1
	02	—	°C	x 1		12	High-pressure sensor detection pressure (Pd)	°C	x 100
	03	—	°C	x 1		13	Low-pressure sensor detection pressure (Ps)	MPa	x 100
	04	—	°C	x 1		14	Suction temp (TS)	MPa	x 1
	05	—	°C	x 1		15	Outdoor coil temp (TE)	°C	x 1
	06	Indoor blow-off temp (TF)	°C	x 1		16	Temp at liquid side (TL)	°C	x 1
	08	Indoor PMV opening	pls	x 10		17	External temp (TO)	°C	x 1
System data	0A	Connected No. of indoor air conditioners	unit			18	Low-pressure saturation temp (TU)	°C	x 1
	0B	Total HP of connected indoor air conditioners	HP	x 10		19	Compressor 1 current (I1)	A	x 10
	0C	Connected No. of outdoor units	unit			1A	Compressor 2 current (I2)	A	x 10
	0D	Total HP of outdoor units	HP	x 10		1B	PMV1 + 2 opening	pls	x 1/10
						1D	Compressor 1, 2 ON/OFF	—	(Note 3)
						1E	Outdoor fan mode	—	0 ~ 31
						1F	Outdoor unit HP	HP	x 1

(Note 1) The fresh air intake unit uses the corrected sensor data. Therefore the following data is not correctly displayed. The corrected sensor data is displayed.

- Outdoor suction temp (TA): See the item code [00] external temp.
- From 02 to 05, there are some data, but not actual.

(Note 2) In the group connection, only data of the master indoor air conditioner is displayed.

(Note 3) 01: Compressor 1 only is on.
10: Compressor 2 only is on.
11: Both compressor 1 and 2 are on.

(Note 4) The item codes are described in the example of center unit.

(Note 5) The upper digit of the item code indicates the outdoor unit No.

- 1: Center unit (A)
- 2: Terminal unit (B)
- 3: Terminal unit (C)
- 4: Terminal unit (D)

11. TROUBLE DIAGNOSES

11-1. Summary of trouble diagnoses

1. Before trouble diagnoses

a) Applicable models

All the super module multi models

(Fresh air intake indoor unit: MMD-APXXXHFE, Outdoor unit: MMY-APXXXT8, MMY-APXXXHT7)

b) Required tools / measuring instruments

- ⊕ , ⊖ screwdrivers, spanner, radio pincher, nipper, push-pin for reset switch, etc.
- Tester, thermometer, pressure gauge, etc.

c) Confirmation before check (The following operations are not abnormal.)

No.	Operation	Items to be checked
1	Compressor does not operate.	<ul style="list-style-type: none"> • Isn't it delaying for 3 minutes? (3 minutes after compressor-OFF) • Isn't it during thermostat-OFF? • Isn't it during operation of fan or timer? • Isn't it initial communication of the system?
2	Indoor fan does not rotate.	<ul style="list-style-type: none"> • Isn't the outside temp out of range of use temperature?
3	Outdoor fan does not rotate or air speed exchanges.	<ul style="list-style-type: none"> • Isn't it under control of cooling low outside air operation? • Isn't defrost function operating?
4	Indoor fan does not stop.	<ul style="list-style-type: none"> • Isn't it under control for waste heat elimination operation when heating operation stops?
5	Remote controller cannot use for Start/Stop operation.	<ul style="list-style-type: none"> • Isn't it under control operation from outside or remote position?
6	—	<ul style="list-style-type: none"> • Is wiring returned to the initial status?
7	—	<ul style="list-style-type: none"> • Are connecting wires of fresh air intake indoor unit and remote controller correct?

2. Procedure of trouble diagnoses

If a trouble occurred, check the unit in the following procedure.

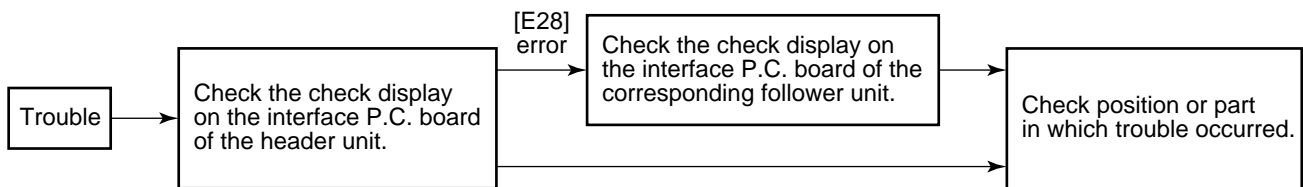

(NOTE)

In case of malfunction of microcomputer due to power supply circumstance or external noise other than after-mentioned check items, an incorrect diagnosis can be considered.

When there is any noise source, change wires of remote controller and signals to shield wires.

11-2. Checking Method

On the remote controller (Handy type, For Central control) and the interface P.C. board of the outdoor unit, LCD display part (Remote controller) to display the operation status or 7-segment display part (On the outdoor interface P.C. board) is provided. Using this self-diagnosis function, the judgment method of defective air conditioner or troubled position when a trouble occurred is described below:

The following table lists each check code that each device detects.

Confirm the check contents according to the checked position in the following table.

- Check from indoor remote controller or TCC-LINK central controller:
Refer to "Remote controller & TCC-LINK central display".
- Check from outdoor unit: Refer to "Outdoor segment display".

Check code display list (Indoor air conditioner)

(Detection by fresh air intake unit)

Check code display			Representative defective position	Error contents
TCC-LINK central & remote controller	Outdoor 7-segment			
		Sub-code		
E03	—	—	Regular communication error between indoor and remote controller	No communication from remote controller and network adapter (No communication of central control system)
E04	—	—	Regular communication error between indoor and outdoor units	No communication from outdoor unit
E08	E08	Duplicated indoor unit Nos.	Duplicated indoor units	Detection of address same to self address
E10	—	—	Communication error between indoor MCU and other MCU	MCU communication error between main and motor microcomputer
E18	—	—	Regular communication error between indoor master and follower units	Regular communication is impossible between indoor master and follower units
F01	—	—	Indoor heat exchanger temp sensor (TCJ) error	Open/short of heat exchanger temp sensor (TCJ) was detected.
F02	—	—	Indoor heat exchanger temp sensor (TC2) error	Open/short of heat exchanger temp sensor (TC2) was detected.
F03	—	—	Indoor heat exchanger temp sensor (TC1) error	Open/short of heat exchanger temp sensor (TC1) was detected.
F10	—	—	Outdoor suction temp sensor (TA) error	Open/short of outdoor suction temp sensor (TA) was detected.
F11	—	—	Blow-off temp sensor (TF) error	Open/short of blow-off temp sensor (TF) was detected.
F29	—	—	Indoor and other P.C. board error	Indoor EEPROM error (Other error may be detected in some cases.)
L03	—	—	Duplicated indoor group master unit setting	Multiple master units exist in a group.
L07	—	—	There is group line in single indoor air conditioner	Even one group connected indoor air conditioner exists in single indoor air conditioner.
L08	L08	—	Indoor group address unset	Indoor group address is not yet set. (Detected also at outdoor unit side)
L09	—	—	Indoor capacity unset	Indoor capacity is not yet set.
L20	—	—	Duplicated central control system address	Duplicated setup of central control system address
L30	L30	Detected indoor air conditioner No.	Input of indoor outside error (Interlock)	Abnormal stop by outside error (CN80) input
P01	—	—	Indoor AC fan error	Indoor AC fan error was detected. (Fan motor thermal relay operation)
P10	P10	Detected indoor air conditioner No.	Indoor overflow was detected.	Float switch operated.
P31	—	—	Other indoor air conditioner error	Follower unit of the group cannot operate by [E03/L03/L07/L08] alarm of master unit

(Detection by remote controller)

Check code display			Representative defective position	Error contents
Remote controller	Outdoor 7-segment			
		Sub-code		
E01	—	—	No main remote controller, Communication (receive) error of remote controller	Signal cannot be received from indoor air conditioner or main remote controller is not set. (including 2-remote controller control)
E02	—	—	Remote controller communication (send) error	Signal cannot be sent to indoor air conditioner.
E09	—	—	Duplicated main remote controllers	In 2-remote controller control, both remote controllers are set as main controller. (Indoor master unit stops with alarm and follower unit operation continues.)

(Detection by central controller)

Check code display			Representative defective position	Error contents
TCC-LINK central	Outdoor 7-segment			
		Sub-code		
C05	—	—	Communication (send) error of central control system	Signal of central control system cannot be sent, or there are multiple identical central devices (AI-NET).
C06	—	—	Communication (receive) error of central control system	Signal of central control system cannot be received.
—	—	—	There are multiple network adapters.	There are multiple network adapters on the remote controller communication line. (AI-NET)
C12	—	—	Multipurpose device control interface batch alarm	Device error, which is connected to multipurpose device control interface of the exclusive TCC-LINK/AI-NET
P30	—	—	Group follower unit error	Group follower unit error (For remote controller, unit No. and the above [***] detail display)

Check code display list (Outdoor unit)

Check code display		TCC-LINK central & Remote controller	Representative defective position	Error contents
Outdoor 7-segment	Sub-code			
E06	No. of indoor units of normal reception	E06	Decrease of indoor units	There is no communication from indoor unit. (Decrease of connected indoor units)
E07	—	(E04)	Indoor / Outdoor communication circuit error	Signal cannot be sent to indoor unit. (→ There is no communication from outdoor unit at indoor side.)
E08	Duplicated indoor unit Nos.	(E08)	Duplicated indoor addresses	Multiple indoor units having same address exists. (Detected also at indoor unit side)
E12	01: Indoor/Outdoor communication 02: Communication between outdoor units	E12	Automatic address start error	Automatic indoor address is operated during setting of automatic address of another line. Automatic outdoor address is operated during setting of automatic indoor address.
E15	—	E15	There is no indoor during automatic address is operating.	Signal from outdoor unit is not received while automatic address is operating.
E16	00: Capacity over 01 ~ : Connected units	E16	No. of connected indoor units/ Capacity over	Total capacity of indoor units is over. (Exceeds the total capacity of outdoor units × 105%)
E19	00: No center 02: Two or more center units	E19	No. of center outdoor units error	There is no center outdoor unit in one line or multiple center outdoor units in one line.
E20	01: Connected outdoor unit of other line 02: Connected indoor unit of other line	E20	Connected unit of other line during operation of automatic address	Indoor unit of other line is detected while automatic address is being set up.
E23	—	E23	Sending error of communication between outdoor units	Signal cannot be sent to other outdoor units.
E25	—	E25	Duplicated terminal outdoor address setup	Outdoor addresses manually set are duplicated.
E26	No. of outdoor units of normal reception	E26	Decrease of connected outdoor units	There is no communication from terminal outdoor unit. (Decrease of connected terminal outdoor units)
E28	Detection of outdoor unit No.	E28	Terminal outdoor unit error	Center outdoor unit detects error of terminal outdoor unit. (For terminal outdoor unit, details are displayed.)
E31	01: A3-IPDU1 error 02: A3-IPDU2 error 03: A3-IPDU1/2 error 04: Fan IPDU error 05: A3-IPDU1 + Fan IPDU error 06: A3-IPDU2 + Fan IPDU error 07: All IPDU error	E31	IPDU communication error	There is no communication of each IPDU (P.C. board) in inverter box.
F04	—	F04	Outdoor discharge temp sensor (TD1) error	Open / Short of discharge temp sensor (TD1) is detected.
F05	—	F05	Outdoor discharge temp sensor (TD2) error	Open / Short of discharge temp sensor (TD2) is detected.
F06	—	F06	Outdoor heat exchanger temp sensor (TE1) error	Open / Short of heat exchanger temp sensor (TE1) is detected.
F07	—	F07	Outdoor liquid temp sensor (TL) error	Open / Short of outdoor liquid temp sensor (TL) is detected.
F08	—	F08	Outdoor air temp sensor (TO) error	Open / Short of outdoor air temp sensor (TO) is detected.
F12	—	F12	Outdoor suction temp sensor (TS1) error	Open / Short of outdoor suction temp sensor (TS1) is detected.
F15	—	F15	Outdoor temp sensor (TE, TL) miswiring	Miswiring on temp sensor (TE, TL) is detected.
F16	—	F16	Outdoor pressure sensor (Pd, Ps) miswiring	Miswiring on outdoor pressure sensor (Pd, Ps) is detected.
F23	—	F23	Low voltage (Ps) sensor error	Output voltage of low pressure (Ps) sensor is zero.
F24	—	F24	High voltage (Pd) sensor error	Output voltage of high pressure (Pd) sensor is zero or abnormal value was detected during stop of compressor.
F31	—	F31	Outdoor EEPROM error	Outdoor EEPROM error (Center unit alarm stops and terminal units continue operation.)
H04	—	H04	Compressor 1 case thermostat operation	Case thermostat of compressor 1 performs protective operation.
H06	—	H06	Low-pressure protective operation	Low-pressure (Ps) sensor detects protective operation.
H07	—	H07	Protection for oil level drop detection	Protective operation is detected by oil level detection temp sensor (TK1 to TK4).
H08	01: TK1 sensor error 02: TK2 sensor error 03: TK3 sensor error 04: TK4 sensor error	H08	Oil level detection temp sensor (TK1 to TK4) error	Open / Short of oil level detection temp sensor (TK1 to TK4) is detected.
H14	—	H14	Compressor 2 case thermostat operation	Case thermostat of compressor 2 performs protective operation.
H16	01: TK1 oil circuit system error 02: TK2 oil circuit system error 03: TK3 oil circuit system error 04: TK4 oil circuit system error	H16	Oil level detection circuit system error	Temperature change of oil level detection temp sensor (TK1 to TK4) cannot be detected though compressor started the operation.

Check code display		TCC-LINK central & Remote controller	Representative defective position	Error contents
Outdoor 7-segment	Sub-code			
L04	—	L04	Duplication of outdoor line addresses	Line address setup is duplicated against outdoor unit in different refrigerant pipe line.
L06	No. of indoor units with priority (L05/L06) by single display)	L05	Duplicated indoor units with priority (Displayed in indoor unit with priority)	There are multiple indoor units with priority (against indoor unit with priority)
		L06	Duplicated indoor units with priority (Displayed on the unit other than indoor unit with priority)	There are multiple indoor units with priority (against indoor unit without priority)
L08	—	(L08)	Indoor group address unset	Indoor unit whose indoor group address is unset exists. (Detected also at indoor unit side)
L10	—	L10	Outdoor capacity unset	Capacity of outdoor unit is not set up. (Replace service P.C. board with a new one.)
L28	—	L28	Quantity over of connected outdoor units	No. of connected outdoor units exceeds 4 units.
L29	01: A3-IPDU1 error 02: A3-IPDU2 error 03: A3-IPDU1/2 error 04: Fan IPDU error 05: A3-IPDU1 + Fan IPDU error 06: A3-IPDU2 + Fan IPDU error 07: All IPDU error	L29	No. of IPDU error	No. of IPDU (PC board) in inverter box is few.
L30	Detection of indoor unit No.	(L30)	There is abnormal external input of indoor / outdoor units (Interlock)	There is indoor unit which stops abnormally by external error input in one line. (← Detected by indoor unit)
P03	—	P03	Outdoor discharge (TD1) temp error	High temperature error is detected on discharge temp sensor (TD1).
P05	01: Detection of open phase 02: Over-voltage	P05	Detection of open phase/ Detection of open phase (Incorrect phase)	Open phase/Phase order to motor is incorrect. Motor may not rotate clockwise, or may not rotate.
P07	01: Compressor 1 side 02: Compressor 2 side	P07	Heat sink overheat error	High temp error is detected on temp sensor (TH) built in outdoor IGBT
P10	Detection of indoor unit No.	(P10)	Overflow is detected in an indoor unit.	There is indoor unit which stops abnormally by detection of overflow in one line. (← Detected by indoor unit)
P13	—	P13	Outdoor liquid back detection error	It is judged as liquid back occurred from refrigerating cycle status.
P15	01: TS condition 02: TD condition	P15	Gas leak detected	Continuation of high temperature of outdoor suction temp sensor (TS1) over reference value is repeatedly detected.
P17	—	P17	Outdoor discharge (TD2) temp error	High temperature error is detected on discharge temp sensor (TD2)
P19	Detection of outdoor unit No.	P19	4-way valve reversal error	Refrigerating cycle error is detected in heating operation.
P20	—	P20	High-pressure protective operation	High-pressure (Pd) sensor detects value over reference value.

Check code display		TCC-LINK central & Remote controller	Representative defective position	Error contents
Outdoor 7-segment	Sub-code			
F13	01: Compressor 1 side 02: Compressor 2 side	F13	Error of temp sensor (TH) built in outdoor IGBT	Open/Short of temp sensor (TH) built in outdoor IGBT is detected.
H01	01: Compressor 1 side 02: Compressor 2 side	H01	Compressor break down	Detection circuit of inverter current (Idc) detects over-current.
H02	01: Compressor 1 side 02: Compressor 2 side	H02	Compressor error (Lock)	Compressor lock is detected.
H03	01: Compressor 1 side 02: Compressor 2 side	H03	Current detection circuit error	Abnormal current is detected during stop of compressor.
P04	01: Compressor 1 side 02: Compressor 2 side	P04	High pressure SW system operation	High pressure SW operates.
P22	04: rpm difference error 06: Max. rpm over 08: Out of order 0A: Idc operation 0C: Air flow lock 0d: Lock 0E: Synchronization error 0F: Control error	P22	IPDU error for outdoor fan	IPDU for outdoor fan detects each error.
P26	01: Compressor 1 side 02: Compressor 2 side	P26	G-Tr (IGBT) short-circuit protection error	Short-circuit protection operation (Momentary over-current) of compressor motor drive circuit element works.
P29	01: Compressor 1 side 02: Compressor 2 side	P29	Compressor position detection circuit system error	Position detection error of compressor motor is detected.

NOTE)

Even the same error contents such as communication error, the check codes display may differ according to the detected device.

In case of check code detected by a central controller of the remote controller, it does not exactly have direct influence to operation of the air conditioner.

11-3. Trouble Diagnoses by Check Display of the Remote Controller

In case of main remote controller (RBC-AMT31E)

1. Confirmation and check

When a trouble occurred on the air conditioner, the check code and the indoor air conditioner No. are displayed on the display part of the remote controller.

The check code is displayed during operation only.

If the display disappeared, follow to "Confirmation of error history" described below to perform operation and confirmation.

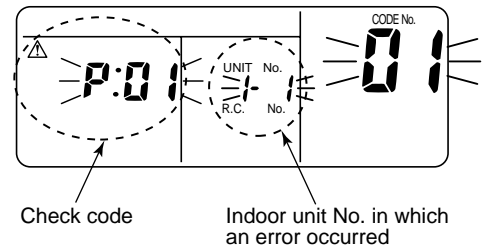

2. Confirmation of error history

When an error generated on the air conditioner, the error history can be confirmed in the following procedure. (Up to 4 errors history is stored in memory.)

It can be confirmed from operation status or stop status.

<Procedure> Confirmation should be performed during stop of the system.

1 Push **TEST** + **SET** buttons concurrently for 4 minutes or more to call the service check mode.

The service check goes on, the item code **01** is firstly displayed, and then the contents of the latest alarm are displayed.

The indoor air conditioner No. in which alarm generated and the alarm contents are displayed.



2 To monitor other error history, push **TEMP** buttons to change the error history No (Item code).

Item code **01** (Latest) à Item code **04** (Old)

NOTE): Four error histories are stored in memory.



3 Pushing **TEST** button returns the display to the normal display.

<Requirement>

Do not push **CL** button; otherwise all the error histories of the indoor air conditioners are deleted.

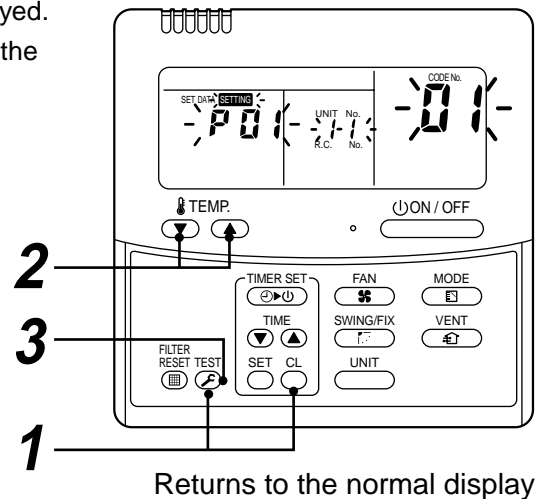

<Operation procedure>

1 → **2** → **3** ←

How to read the check monitor display

<7-segment display>



<Reading>

0 1 2 3 4 5 6 7 8 9 A b C d E F H J L P

In case of TCC-LINK central control remote controller (TCB-SC642TL)

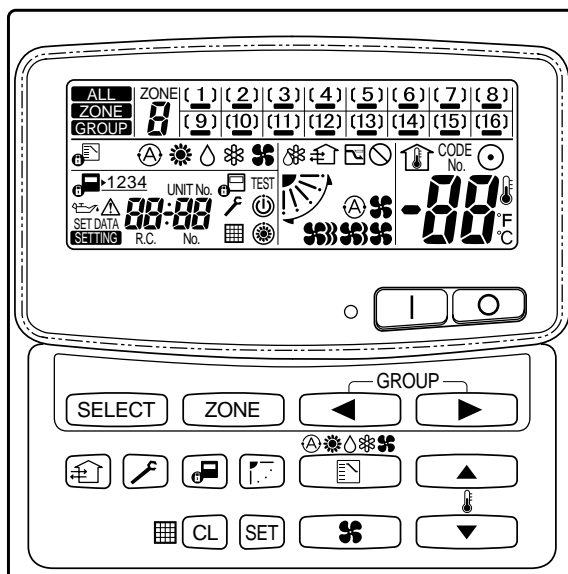

1. Confirmation and check

When a trouble occurred on the air conditioner, the check code and the indoor air conditioner No. are displayed on the display part of the remote controller.

The check code is displayed during operation only.

If the display disappeared, follow to "Confirmation of error history" described below to perform operation and confirmation.

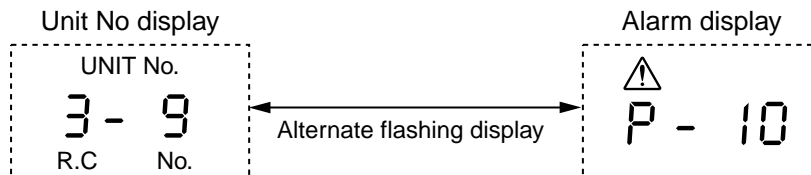

2. Confirmation of error history

When an error generated on the air conditioner, the error history can be confirmed in the following procedure. (Up to 4 errors history is stored in memory.)

It can be confirmed from operation status or stop status.

- 1) Push and buttons successively for 4 seconds or more.
- 2) Service check goes on and then the item code 01 goes on.
- 3) When selecting a group No (Flashing), the unit No display and the latest alarm history are alternatively displayed if there is alarm history.
 - * In this time, temperature cannot be set up.
- 4) To confirm other alarm history than the latest one, push TEMP / and select the item code (01 to 04).
- 5) To confirm alarm of the other group, push and select the group No.
 - Do not push button; otherwise all the alarm histories of the currently selected group are deleted.
- 6) To finish the service check, push button.

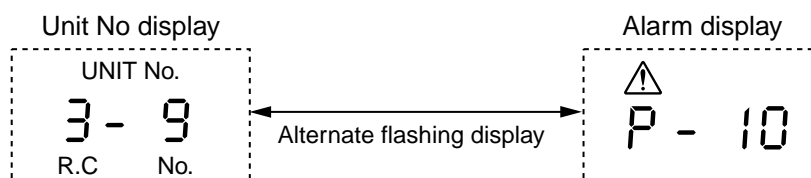

11-4. Check Code and Check Position Displayed on the Remote Controller and Outdoor Unit (7-Segment Display of Interface)

Check code			Detected position	Check code name	Status	Error detection condition	Check item (position)
Main remote controller	Outdoor 7-segment display						
	Check code	Sub-code					
E01	—	—	Remote controller	Communication error between indoor and remote controller (Detected at remote controller side)	Corresponding unit only stops.	Communication interrupted between indoor P.C. board and remote controller.	<ul style="list-style-type: none"> • Check remote controller inter-unit cable (A/B). • Check disconnection, connector contact error. • Check indoor power supply. • Check indoor P.C. board error. • Check remote controller address setup. (When two remote controllers operate) • Check remote controller P.C. board.
E02	—	—	Remote controller	Remote controller sending error	Corresponding unit only stops.	Signal could not be sent from remote controller to indoor unit.	<ul style="list-style-type: none"> • Check the communication wire of remote controller: Exchange remote controller.
E03	—	—	Indoor unit	Communication error between indoor and remote controller (Detected at indoor side)	Corresponding unit only stops.	No communication from remote controller (including wireless) and communication adaptor.	<ul style="list-style-type: none"> • Check remote controller and communication adaptor wiring.
E04	—	—	Indoor unit	Indoor/outdoor communication circuit error (Detected at indoor side)	Corresponding unit only stops.	Indoor unit does not receive communication from outdoor unit.	<ul style="list-style-type: none"> • Check power-ON order of indoor/outdoor. • Check indoor address setup. • Check inter-unit cabling between indoor and outdoor. • Check outdoor end terminal resistance setup (SW30-2).
E06	E06	No. of indoor units of normal reception	I/F	Decreased number of indoor units	All stop	When signal is not sent for a certain period from the indoor unit which has been used to send signals, [E06] is normally displayed.	<ul style="list-style-type: none"> • Check the power supply of indoor unit. (Power-ON) • Check connection of communication line between indoor and outdoor. • Check connector connection for communication in indoor P.C. board. • Check connector connection for communication in outdoor P.C. board. • Check indoor P.C. board failure. • Check outdoor P.C. board (I/F) failure.
—	E07	—	I/F	Indoor/outdoor communication circuit error (Detected at outdoor side)	All stop	Transmission from outdoor to indoor cannot continue for 30 seconds.	<ul style="list-style-type: none"> • Check outdoor end terminal resistance setup (SW30-2). • Check the communication connection between indoor and outdoor.
E08	E08	Duplicated indoor addresses	Indoor, I/F	Duplicated indoor addresses	All stop	Multiple indoor unit address setup are duplicated.	<ul style="list-style-type: none"> • Check indoor address. • Check the change of remote controller connection (Group / individual) after setup of indoor address.
E09	—	—	Remote controller	Duplicated master remote controllers	Corresponding unit only stops.	In 2-remote controller control (including wireless), both are setup as master (Header indoor unit stops and other indoor unit is operating.)	<ul style="list-style-type: none"> • Check remote controller setup. • Check remote controller P.C. board.
E10	—	—	Indoor unit	Communication error between indoor P.C. board assembly	Corresponding unit only stops.	There is any trouble in power line.	<ul style="list-style-type: none"> • Indoor P.C. board failure

Check code			Detected position	Check code name	Status	Error detection condition	Check item (position)
Main remote controller	Outdoor 7-segment display						
	Check code	Sub-code					
E12	E12	01: Indoor/outdoor communication 02: Between outdoors communication	I/F	Automatic address start error	All stop	<ul style="list-style-type: none"> When indoor automatic address started, other refrigerant circuit system was setting automatic address. When outdoor automatic address started, indoor automatic address was executed. 	<ul style="list-style-type: none"> Setup the address again after disconnecting communication connection with other refrigerant circuit system.
E15	E15	—	I/F	No corresponding indoor unit during automatic address	All stop	Indoor unit is not found when indoor automatic address start was set up.	<ul style="list-style-type: none"> Check the communication line connection between indoor and outdoor. Check the electric power line error in indoor. Check the noise of surrounding devices. Power failure Check indoor P.C. board error.
E16	E16	00: Capacity over 01 to: No. of connected units	I/F	No. of connected indoor units / Capacity over	All stop	<ul style="list-style-type: none"> Total capacity of indoor units exceeded 105% of total outdoor capacity. No. of connected indoor units are more than 48 units. <p>[Note] If this code appears after backup setup of outdoor unit trouble, set up "No capacity-over detection".</p> <p><Setup method of "No capacity-over detection"> Turn on SW09/Bit 2 on I/F P.C. board of outdoor header unit.</p>	<ul style="list-style-type: none"> Check the connection capacity of indoor unit. Check the HP capacity of indoor unit. Check the indoor/outdoor capacity setup Check the No. of connected indoor units. Check the outdoor I/F P.C. board error
E18	—	—	Indoor unit	Communication error between indoor header and follower units	Corresponding unit only stops.	Regular communication between indoor header and follower units.	<ul style="list-style-type: none"> Check cable of the remote controller. Check power cabling of indoor. Check P.C. board of indoor.
E19	E19	00: No center unit 02: Two or more center units	I/F	No. of center outdoor unit error	All stop	<ul style="list-style-type: none"> There are multiple outdoor header units in 1 line. There is none of outdoor header unit in 1 line. 	<ul style="list-style-type: none"> The outdoor unit connected with communication cable between indoor and outdoor (U1.U2) is the outdoor header unit. Check connection of communication line between indoor and outdoor. Check outdoor P.C. board(I/F) error.
E20	E20	01: Connection of outdoor of other line 02: Connection of indoor of other line	I/F	Other line unit connected during automatic address	All stop	Unit of other line was connected when indoor automatic address started.	Separate the cable between lines according to automatic address setup method in "Address setup".
E23	E23	—	I/F	Communication sending error between outdoor units	All stop	Transmission of other outdoor unit was unavailable for 30 seconds or more.	<ul style="list-style-type: none"> Check the power of outdoor unit. (Is the power turned on?) Check connection of communication wire or disconnection between outdoor units. Check the connector for communication on outdoor P.C. board. Check outdoor P.C. board (I/F) error. Check the end terminal resistance setup for communication between outdoor units.

Check code			Detected position	Check code name	Status	Error detection condition	Check item (position)
Main remote controller	Outdoor 7-segment display						
	Check code	Sub-code					
E25	E25	—	I/F	Duplicated outdoor terminal address setup	All stop	Outdoor addresses manually set up are duplicated.	Note Do not set up the outdoor address manually.
E26	E26	No. of normally received outdoor units	I/F	Decreased number of connected outdoor units	All stop	The signal was not returned for constant from the outdoor unit which was receiving signal.	<ul style="list-style-type: none"> Outdoor is performing backup. Check the power of outdoor unit. (Is the power turned on?) Check connection of inter-unit wire or disconnection between outdoor units. Check the connector connection for communication on outdoor P.C. board. Check outdoor P.C. board (I/F) error.
E28	E28	No. of detected outdoor units	I/F	Outdoor follower unit error	All stop	Outdoor header unit received error code from outdoor follower unit.	<ul style="list-style-type: none"> Check the check code of outdoor follower unit.
<div style="border: 1px solid black; padding: 5px; width: fit-content; margin: auto;"> <p><Convenient functions></p> <p>When pushing SW04 for 1 second or more under condition that [E28] is displayed on 7-segment display of outdoor header unit, the fan of outdoor unit which stopped abnormally starts rotating. If pushing SW04 and SW05 simultaneously, the fan of normal outdoor unit operates. When pushing SW05 singly, the operation of fan is cleared.</p> </div>							
E31	E31	01: 3A-IPDU1 error 02: 3A-IPDU2 error 03: 3A-IPDU1, 2 errors 04: Fan IPDU error 05: 3A-IPDU1 + Fan IPDU error 06: 3A-IPDU2 + Fan IPDU error 07: All IPDU error or communication error between IPDU and I/F P.C. board or outdoor I/F P.C. board error	I/F	IPDU communication error	All stop	Communication of each IPDU (P.C. board) in inverter box interrupted.	<ul style="list-style-type: none"> Check connection of communication connector and disconnection between IPDU and I/F P.C. board. Check outdoor P.C. board (I/F, IPDU, Fan IPDU) error. Check external noise. Check power supply P.C. board for fan error.
F01	—	—	Indoor unit	Indoor TCJ sensor error	Corresponding unit only stops.	Resistance value of sensor is infinite or zero. (Open/Short)	<ul style="list-style-type: none"> Check connection/cabling of TCJ sensor connector. Check characteristics of TCJ sensor resistance value. Check indoor P.C. board error.
F02	—	—	Indoor unit	Indoor TC2 sensor error	Corresponding unit only stops.	Resistance value of sensor is infinite or zero (Open/Short).	<ul style="list-style-type: none"> Check connection/cabling of TC2 sensor connector. Check characteristics of TC2 sensor resistance value. Check indoor P.C. board error.
F03	—	—	Indoor unit	Indoor TC1 sensor error	Corresponding unit only stops.	Resistance value of sensor is infinite or zero (Open/Short).	<ul style="list-style-type: none"> Check connection/cabling of TC1 sensor connector. Check characteristics of TC1 sensor resistance value. Check indoor P.C. board error.
F04	F04	—	I/F	TD1 sensor error	All stop	Resistance value of sensor is infinite or zero (Open/Short).	<ul style="list-style-type: none"> Check connection of TD1 sensor connector. Check characteristics of TD1 sensor resistance value. Check outdoor P.C. board (I/F) error.
F05	F05	—	I/F	TD2 sensor error	All stop	Resistance value of sensor is infinite or zero (Open/Short).	<ul style="list-style-type: none"> Check connection of TD2 sensor connector. Check characteristics of TD2 sensor resistance value. Check outdoor P.C. board (I/F) error.
F06	F06	—	I/F	TE1 sensor error	All stop	Resistance value of sensor is infinite or zero (Open/Short).	<ul style="list-style-type: none"> Check connection of TE1 sensor connector. Check characteristics of TE1 sensor resistance value. Check outdoor P.C. board (I/F) error.

Check code			Detected position	Check code name	Status	Error detection condition	Check item (position)
Main remote controller	Outdoor 7-segment display						
	Check code	Sub-code					
F07	F07	—	I/F	TL sensor error	All stop	<ul style="list-style-type: none"> Resistance value of sensor is infinite or zero (Open/Short). 	<ul style="list-style-type: none"> Check connection of TL sensor connector. Check characteristics of TL sensor resistance value. Check outdoor P.C. board (I/F) error.
F08	F08	—	I/F	TO sensor error	All stop	<ul style="list-style-type: none"> Resistance value of sensor is infinite or zero (Open/Short). 	<ul style="list-style-type: none"> Check connection of TO sensor connector. Check characteristics of TO sensor resistance value. Check outdoor P.C. board (I/F) error.
F10	—	—	Indoor	Indoor TA sensor error	Corresponding unit only stops.	<ul style="list-style-type: none"> Resistance value of sensor is infinite or zero (Open/Short). 	<ul style="list-style-type: none"> Check connection/cabling of TA sensor connector. Check characteristics of TA sensor resistance value. Check indoor P.C. board error.
F11	—	—	Indoor	Indoor TF sensor error	Corresponding unit only stops.	<ul style="list-style-type: none"> Resistance value of sensor is infinite or zero (Open/Short). 	<ul style="list-style-type: none"> Check connection/cabling of TF sensor connector. Check characteristics of TF sensor resistance value. Check indoor P.C. board error.
F12	F12	—	I/F	TS1 sensor error	All stop	<ul style="list-style-type: none"> Resistance value of sensor is infinite or zero (Open/Short). 	<ul style="list-style-type: none"> Check connection of TS1 sensor connector. Check characteristics of TS1 sensor resistance value. Check outdoor P.C. board (I/F) error.
F13	F13	01: Compressor 1 side 02: Compressor 2 side	IPDU	TH sensor error	All stop	<ul style="list-style-type: none"> Resistance value of sensor is infinite or zero (Open/Short). 	<ul style="list-style-type: none"> IGBT built-in temp sensor error → Exchange IPDU P.C. board.
F15	F15	—	I/F	Outdoor temp sensor miscabling (TE1, TL)	All stop	During operation of compressor in HEAT mode, the TE1 detection temp was higher than that of TL by the specified value continued for 3 minutes or more.	<ul style="list-style-type: none"> Check installation of TE1 sensor and TL sensor. Check characteristics of TE1 and TL sensor resistance value. Check outdoor P.C. board (I/F) error.
F16	F16	—	I/F	Outdoor pressure sensor miscabling (Pd, Ps)	All stop	High-pressure Pd sensor and low-pressure Ps sensor were exchanged, or output voltages of both sensors are zero.	<ul style="list-style-type: none"> Check connection of high-pressure Pd sensor connector. Check connection of low-pressure Ps sensor connector. Check pressure sensors Pd and Ps error. Check outdoor P.C. board (I/F) error. Check compression error of compressor.
F23	F23	—	I/F	Ps sensor error	All stop	Output voltage of Ps sensor was zero.	<ul style="list-style-type: none"> Misconnection of Ps sensor and Pd sensor connectors Check connection of Ps sensor connector. Check Ps sensor error. Check compression error of compressor. Check 4-way valve error. Check outdoor P.C. board (I/F) error. Check SV4 circuit error.
F24	F24	—	I/F	Pd sensor error	All stop	Output voltage of Pd sensor was zero. (Sensor Open) Pd > 4.15MPa during stop of compressor	<ul style="list-style-type: none"> Check connection of Pd sensor connector. Check Pd sensor error. Check outdoor P.C. board (I/F) error.
F29	—	—	Indoor	Indoor other error	Corresponding unit only stops.	Indoor P.C. board did not operate normally.	<ul style="list-style-type: none"> Check indoor P.C. board error (EEPROM error).
F31	F31	—	I/F	Outdoor EEPROM error	All stop (*1)	Outdoor P.C. board (I/F) did not operate normally.	<ul style="list-style-type: none"> Check power voltage. Check power noise. Check outdoor P.C. board (I/F) error.

(*1) All stop only in case of the header unit The follower unit continues operation.

Check code		Detected position	Check code name	Status	Error detection condition	Check item (position)	
Main remote controller	Outdoor 7-segment display						
	Check code						Sub-code
H01	H01	01: Compressor 1 side 02: Compressor 2 side	IPDU	Compressor breakdown	All stop	Inverter current detection circuit detected over-current and stopped.	<ul style="list-style-type: none"> • Check power voltage. (AC220–240V ± 10%). • Check compressor error. • Check cause of abnormal overload operation. • Check outdoor P.C. board (IPDU) error.
H02	H02	01: Compressor 1 side 02: Compressor 2 side	IPDU	Compressor error (lock) MG-SW error OCR operation	All stop	Over-current was detected several seconds after header compressor had started.	<ul style="list-style-type: none"> • Check compressor error. • Check power voltage. (AC380 –10%, 415V +10%). • Check cable of compressor and phase-missing. • Check connector/terminal connection on IPDU P.C. board. • Check conduction of case heater. (Check activation error due to liquid stagnation in compressor.) • Check outdoor P.C. board (IPDU) error. • Check outdoor MG-SW or OCR.
H03	H03	01: Compressor 1 side 02: Compressor 2 side	IPDU	Current detection circuit system error	All stop	While header compressor stopped, current flowed more than the specified current and was detected.	<ul style="list-style-type: none"> • Check cabling of current detection circuit system. • Check outdoor P.C. board (IPDU) error.
H04	H04	—	I/F	Compressor 1 case thermo operation	All stop	Compressor 1 case thermostat performed protective operation.	<ul style="list-style-type: none"> • Check compressor 1 case thermo circuit. (Connector, cable, P.C. board) • Check full opening of service valve. (Gas and liquid side) • Check outdoor PMV clogging. (PMV1, 2) • Check SV41 circuit leakage. • Check miscabling/misinstallation of SV41 and SV42. • Check valve open status of indoor PMV. • Check compressor error. • Check 4-way valve error. • Check refrigerant shortage.
H06	H06	—	I/F	Low-pressure protective operation	All stop	Low-pressure Ps detected operation lower than 0.02MPa.	<ul style="list-style-type: none"> • Check full opening of service valve. (Gas and liquid side) • Check outdoor PMV clogging. (PMV1, 2) • Check SV41 circuit and SV42 circuit error. • Check low-pressure Ps sensor error. • Check indoor air filter clogging. • Check valve open of indoor PMV. • Check refrigerant pipe clogging. • Check outdoor fan operation. (In heating mode) • Check refrigerant shortage.
H07	H07	—	I/F	Protection for oil level drop detection	All stop	The operating compressor detected oil shortage continuously for 2 hours.	<p><Check all the outdoor units in the corresponding line.></p> <ul style="list-style-type: none"> • Check full opening of service valve of balance pipe. • Check connection and installation of TK1, TK2, TK3, and TK4 sensors. • Check characteristics of TK1, TK2, TK3, and TK4 resistance values. • Check gas leak and oil leak in the same line. • Check refrigerant stagnation in compressor. • Check error of SV3A, SV3B, SV3C, SV3D, and SV3E valves. • Check clogging of oil separator oil return circuit. • Check clogging of oil-equation circuit.

MG-SW : Magnet Switch
OCR : Over-current Relay

Check code		Detected position	Check code name	Status	Error detection condition	Check item (position)	
Main remote controller	Outdoor 7-segment display						
	Check code						Sub-code
H08	H08	01: TK1 sensor error 02: TK2 sensor error 03: TK3 sensor error 04: TK4 sensor error	I/F	Oil level detective temp sensor error	All stop	<ul style="list-style-type: none"> Resistance value of sensor is infinite or zero. (Open/Short) 	<ul style="list-style-type: none"> Check connection of TK1 sensor connector. Check characteristics of TK1 sensor resistance value. Check outdoor P.C. board (I/F) error.
					All stop	<ul style="list-style-type: none"> Resistance value of sensor is infinite or zero. (Open/Short) 	<ul style="list-style-type: none"> Check connection of TK2 sensor connector. Check characteristics of TK2 sensor resistance value. Check outdoor P.C. board (I/F) error.
					All stop	<ul style="list-style-type: none"> Resistance value of sensor is infinite or zero. (Open/Short) 	<ul style="list-style-type: none"> Check connection of TK3 sensor connector. Check characteristics of TK3 sensor resistance value. Check outdoor P.C. board (I/F) error.
					All stop	<ul style="list-style-type: none"> Resistance value of sensor is infinite or zero. (Open/Short) 	<ul style="list-style-type: none"> Check connection of TK4 sensor connector. Check characteristics of TK4 sensor resistance value. Check outdoor P.C. board (I/F) error.
H14	H14	—	I/F	Compressor 2 case thermo operation	All stop	Compressor 2 case thermostat operated.	<ul style="list-style-type: none"> Check compressor 2 case thermo circuit. (Connector, cable, P.C. board) Check full opening of service valve. (Gas and liquid side) Check outdoor PMV clogging. (PMV1, 2) Check SV42 valve leak. Check miscabling/misinstallation of SV41 and SV42. Check valve opening of indoor PMV. Check refrigerant shortage. Check compressor error.
H16	H16	01: TK1 oil circuit system error 02: TK2 oil circuit system error 03: TK3 oil circuit system error 04: TK4 oil circuit system error	I/F	Oil level detective circuit system error MG-SW error OCR operation	All stop	Temperature change of TK1 could not be detected though compressor 1 started the operation.	<ul style="list-style-type: none"> Check TK1 sensor coming-off. Check characteristics of TK1 sensor resistance value. Check TK1, TK2, TK3, and TK4 misconnection. Check operation error of SV3E valve. Check capillary clogging of oil-equation circuit and operation error of stop valve. Check refrigerant stagnation in compressor. Check MG-SW or OCR.
					All stop	Temperature change of TK2 could not be detected though compressor 2 started the operation.	<ul style="list-style-type: none"> Check TK2 sensor coming-off. Check characteristics of TK2 sensor resistance value. Check TK1, TK2, TK3, and TK4 misconnection. Check SV3E valve operation. Check capillary clogging of oil equalization circuit and check stop valve operation. Check refrigerant stagnation in compressor shell. Check MG-SW or OCR.
					All stop	Temperature change of TK3 could not be detected though compressor started the operation.	<ul style="list-style-type: none"> Check TK3 sensor coming-off. Check characteristics of TK3 sensor resistance value. Check TK1, TK2, TK3, and TK4 misconnection. Check SV3E valve operation. Check capillary clogging of oil-equalization circuit and check valve operation. Check refrigerant stagnation in compressor shell. Check MG-SW or OCR.
					All stop	Temperature change of TK4 could not be detected though compressor started the operation, or the difference from other TK sensor changed for a constant time only within the specified range.	<ul style="list-style-type: none"> Check TK4 sensor coming-off. Check characteristics of TK4 sensor resistance value. Check TK1, TK2, TK3, and TK4 misconnection. Check SV3E valve operation. Check capillary clogging of oil-equalization circuit and check valve operation. Check refrigerant stagnation in compressor shell. Check MG-SW or OCR.

MG-SW : Magnet Switch
OCR : Over-current Relay

Check code		Detected position	Check code name	Status	Error detection condition	Check item (position)	
Main remote controller	Outdoor 7-segment display						
	Check code						Sub-code
L03	—	—	Indoor	Duplicated indoor center units	Corresponding unit only stops.	There are multiple center units in a group. <ul style="list-style-type: none"> • Check indoor address. • Check the change of remote controller connection (Group/individual) after indoor address setup. 	
L04	L04	—	I/F	Duplicated outdoor line address	All stop	Line address setup is duplicated against the outdoor unit in different refrigerant pipe system. <ul style="list-style-type: none"> • Check line address. 	
L05	—	—	I/F	Duplicated indoor units with priority (Displayed on indoor unit with priority)	All stop	Indoor units with priority were duplicated. <ul style="list-style-type: none"> • Check display of indoor unit with priority. 	
L06	L06	No. of indoor units with priority	I/F	Duplicated indoor units with priority (Displayed on the unit other than indoor unit with priority)	All stop	Indoor units with priority were duplicated. <ul style="list-style-type: none"> • Check display of indoor unit with priority and outdoor unit. 	
L07	—	—	Indoor	Group line in individual indoor unit.	Corresponding unit only stops.	At least one indoor unit connected to a group existed in the individual indoor units. <ul style="list-style-type: none"> • Check indoor address. 	
L08	L08	—	Indoor	Indoor group / address unset	Corresponding unit only stops.	Address was not yet set up. <ul style="list-style-type: none"> • Check indoor address. <p>Note) After installation, this code is displayed when the power is firstly turned on.</p>	
L09	—	—	Indoor	Indoor capacity unset	Corresponding unit only stops.	Indoor unit capacity was unset. <ul style="list-style-type: none"> Set up indoor capacity. (DN=11) 	
L10	L10	—	I/F	Outdoor capacity unset	All stop	On the I/F P.C. board for service, jumper line was not cut according to the model. <ul style="list-style-type: none"> Check model setup on outdoor I/F P.C. board A'ssy for service. 	
L20	—	—	Indoor	Duplicated central control addresses	All stop	Duplicated central control addresses <ul style="list-style-type: none"> • Check central control address. 	
L28	L28	—	I/F	Quantity over of connected outdoor units	All stop	There were more than four outdoor units. <ul style="list-style-type: none"> • Check No. of connected outdoor units. (Max. 4 units per 1 system) • Check communication line between outdoor units. • Check outdoor P.C. board (I/F) error. 	
L29	L29	01: IPDU1 error 02: IPDU2 error 03: IPDU1, 2 errors 04: Fan IPDU error 05: IPDU1 + Fan IPDU error 06: IPDU2 + Fan IPDU error 07: All IPDU error or communication error between IPDU and I/F P.C. board, or outdoor I/F P.C. board error	I/F	IPDU quantity error	All stop	No. of IPDU units detected when power was turned on were less. <ul style="list-style-type: none"> • Check model setup for outdoor I/F service P.C. board. • Check connection of UART communication connector. • Check IPDU, fan IPDU, and I/F P.C. board error. <p>Note) UART: Universal Asynchronous Receiver Transmitter</p>	
L30	L30	Detected indoor address	Indoor	Interlock in indoor unit from outside	Corresponding unit only stops.	<ul style="list-style-type: none"> • Outside error input terminal Detected signal to (CN80) for more 1 minute <ul style="list-style-type: none"> ■ Outside device is connected to connector (CN80): <ol style="list-style-type: none"> 1) Check outside device error. 2) Check indoor P.C. board error. ■ Outside device is not connected to connector (CN80): <ol style="list-style-type: none"> 1) Check indoor P.C. board error. 	
—	L31	—	I/F	Extended IC (Integrated Circuit) error	Operation continues.	P.C. board (I/F) parts error <ul style="list-style-type: none"> Check indoor (I/F) P.C. board. 	

Check code			Detected position	Check code name	Status	Error detection condition	Check item (position)
Main remote controller	Outdoor 7-segment display						
	Check code	Sub-code					
P01	—	—	Indoor	Indoor fan motor error	Corresponding unit only stops.		<ul style="list-style-type: none"> • Check the lock of fan motor (AC fan). • Check cabling.
P03	P03	—	I/F	Discharge temp TD1 error	All stop	Discharge temp (TD1) exceeded 115°C.	<ul style="list-style-type: none"> • Check full opening of outdoor service valves (Gas side, Liquid side). • Check clogging of outdoor PMV. (PMV1,2) • Check characteristics of TD1 sensor resistance value. • Check refrigerant shortage. • Check leakage of SV41 circuit. • Check SV4 circuit. (Miscabling and misinstallation of SV41 and SV42)
P04	P04	01: Compressor 1 side 02: Compressor 2 side	I/F	Actuation of high-pressure SW	All stop	High-pressure SW actuated.	<ul style="list-style-type: none"> • Check Pd pressure sensor error. • Check full opening of outdoor service valves (Gas side, Liquid side). • Check outdoor fan error. • Check outdoor fan motor error. • Check clogging of outdoor PMV. (PMV1,2) • Check clogging of indoor/outdoor heat exchangers. • Check short-circuiting of outdoor suction/discharge air. • Check clogging of SV2 circuit. • Check outdoor P.C. board (I/F) error. • Check indoor fan system error. (Cause of air volume decrease) • Check opening of indoor PMV. • Check miscabling of communication line between indoor and outdoor. • Check operation error of check valve of discharge pipe. • Check SV4 valve circuit. • Check refrigerant overcharge.
P05	P05	01: Power supply open phase 02: Power supply negative phase	I/F	Open phase negative phase	All stop	<ul style="list-style-type: none"> • Open phase was detected when the power turned on. • Negative phase was detected when the power turned on. 	<ul style="list-style-type: none"> • Check outdoor power line. • Check outdoor P.C. board (I/F) error.
P07	P07	01: Compressor 1 side 02: Compressor 2 side	IPDU, I/F	Heat sink overheat error	All stop	IGBT built-in temp sensor (TH) was overheated.	<ul style="list-style-type: none"> • Check power voltage. • Check outdoor fan system error. • Check clogging of heat sink cooling duct. • Check fixation between IGBT and heat sink. (Check screwing and contact.) • Check IPDU error.(IGBT built-in temp sensor (TH) error)
P10	P10	Indoor address with trouble	Indoor	Indoor overflow error	All stop	<ul style="list-style-type: none"> • Float switch operated. • Float switch circuit disconnected or the connector came off. 	<ul style="list-style-type: none"> • Check the float switch connector. • Check operation of drain pump unit. • Check the drain pump circuit. • Check clogging of drain pipe. • Check indoor P.C. board error.

Check code			Detected position	Check code name	Status	Error detection condition	Check item (position)
Main remote controller	Outdoor 7-segment display						
	Check code	Sub-code					
P13	P13	—	I/F	Outdoor liquid back detection error	All stop	<p><In cooling> While the system is operating in COOL mode, a high pressure value was detected in follower unit in which compressor did not operate.</p> <p><In heating> While the system is operating in HEAT mode, outdoor PMV of which opening degree was 100p or less for a certain time.</p>	<ul style="list-style-type: none"> • Check full close operation of outdoor PMV (1, 2). • Check Pd and Ps sensor error. • Check clogging of SV2 circuit. • Check clogging of balance pipe. • Check clogging of SV3B circuit. • Check outdoor P.C. board (I/F) error. • Check capillary clogging of oil return circuit from oil separator. • Check leakage of check valve of the main discharge pipe.
P15	P15	01: TS condition	I/F	Gas leak detection (TS1 condition)	All stop	<p>Suction temp exceeded the judgment standard temp for 10 minutes or more.</p> <p><TS error judgment standard temperature> In cooling operation: 60°C or higher In heating operation: 40°C or higher</p>	<ul style="list-style-type: none"> • Check refrigerant shortage. • Check full open of outdoor service valves (gas side, liquid side). • Check outdoor PMV clogging (PMV1, 2). • Check characteristics of TS1 sensor resistance value. • Check leakage of SV4 circuit.
		02: TD condition	I/F	Gas leak detection (TD condition)	All stop	Discharge temperature TD1 or TD2 was continuously 108°C or higher for 10 minutes.	<ul style="list-style-type: none"> • Check refrigerant shortage. • Check outdoor PMV clogging (PMV1, 2). • Check characteristics of TD1, TD2 sensor resistance value. • Check indoor air filter clogging. • Check pipe clogging. • Check SV4 circuit (Valve leakage, misinstallation)
P17	P17	—	I/F	Discharge temp TD2 error	All stop	Discharge temperature (TD2) exceeded 115°C.	<ul style="list-style-type: none"> • Check full opening of outdoor service valves (gas side, liquid side). • Check clogging of outdoor PMV (PMV1, 2). • Check characteristics of TD2 sensor resistance value. • Check leakage of SV42 circuit. • Check SV4 circuit. (Miscabling and misinstallation of SV41 and SV42)
P19	P19	Detected outdoor unit No.	I/F	4-way valve operation error	All stop	When abnormal refrigerating cycle data was detected in heating	<ul style="list-style-type: none"> • Check coil error and connector connection of 4-way valve. • Check characteristics of TS1/TE1 sensor resistance value. • Check characteristics of Pd, Ps pressure sensor output voltage. • Check misconnection of TE1 and TL sensors.
P20	P20	—	I/F	High-pressure protective operation	All stop	Pd sensor detected 3.6MPa or more.	<ul style="list-style-type: none"> • Check Pd pressure sensor error. • Check full opening of service valves (Gas side, Liquid side). • Check outdoor fan error. • Check outdoor fan motor error. • Check clogging of outdoor PMV. (PMV1,2) • Check clogging of indoor/outdoor heat exchangers. • Check air short-circuiting in outdoor unit. • Check clogging of SV2 circuit. • Check outdoor P.C. board (I/F) error. • Check indoor fan system error. (Cause of air volume decrease) • Check valve opening of indoor PMV. • Check miscabling of communication line between indoor and outdoor. • Check operation error of check valve of discharge pipe. • Check circuit of gas balance SV4 valve. • Check refrigerant overcharge.

Check code		Detected position	Check code name	Status	Error detection condition	Check item (position)	
Main remote controller	Outdoor 7-segment display						
	Check code						Sub-code
P22	P22	0: IGBT shortage 1: Position detection circuit error 3: Motor lock error 4: Motor current error detection C: TH sensor temp. error D: TH sensor error E: Vdc error	FAN-IPDU	Outdoor fan IPDU error	All stop	(Sub-code: 0) • Short-circuit current was detected at start time. • Short-circuit current was detected when checking IGBT short-circuit before start time.	• Check fan motor. (Interphase short-circuit) • Check fan IPDU error.
					All stop	(Sub-code: 1) • The standard value of detection circuit of fan IPDU current fluctuated at start time.	• Check fan IPDU error.
					All stop	(Sub-code: 3) • Abnormal current was detected within 30 seconds after start time.	• Check fan motor. (Lock, phase missing) • Check cause of abnormal overload at start time. • Check connection of connector to fan motor.
					All stop	(Sub-code: 4) • Short-circuit current was detected when 2 seconds or more passed after start time. • Over-current was detected when 30 seconds or more passed after start time.	• Check power supply voltage. • Check fan IPDU error.
					All stop	(Sub-code: C) • Heat sink sensor (TH) of fan IPDU detected 95°C error.	• Check outdoor fan system. • Check fan IPDU error. • Check fixation between fan IPDU and heat sink.
					All stop	(Sub-code: D) • Heat sink sensor (TH) of fan IPDU detected short-circuiting or open.	• Check fan IPDU error.
					All stop	(Sub-code: E) • Input power supply voltage of the fan IPDU over the setup value was detected. • Input power supply terminal of the fan IPDU was unconnected. • Power supply P.C. board error of the fan IPDU	• Check input power supply voltage of the fan IPDU. • Check power supply P.C. board error of the fan IPDU. • Check error of external electrolytic condenser.
P26	P26	01: Compressor 1 side 02: Compressor 2 side	IPDU	G-Tr short-circuit protection error	All stop	Instantaneous over-current was detected when compressor started.	• Check connector connection and wiring on IPDU P.C. board. • Check compressor error and defect of compressor coil. • Check outdoor P.C. board (IPDU) error.
P29	P29	01: Compressor 1 side 02: Compressor 2 side	IPDU	Compressor position detection circuit error	All stop	Position was not normally detected.	• Check connector connection and wiring. • Check compressor error and defect of compressor coil. • Check P.C. board (IPDU) error.
P31	—	—	Indoor	Other indoor error (Group follower unit error)	Corresponding unit only stops.	E07/L07/L03/L08 was detected when other indoor unit in the group was defective.	• Check indoor P.C. board.

Error detected by TCC-LINK central control device

Check code			Detected position	Check code name	Status	Error detection condition	Check item (position)
Display on central control device	Outdoor 7-segment display						
	Check code	Sub-code					
C05	—		TCC-LINK	TCC-LINK central control device transmission error	Operation continued.	Signal is not transmit from central control device.	<ul style="list-style-type: none"> • Check central control device error. • Check communication line error of central control device. • Check setup of end terminal resistance.
C06	—	—	—	TCC-LINK central control device receiving error	Operation continued.	Signal is not received from central control device.	<ul style="list-style-type: none"> • Check central control device error. • Check communication line error of central control device. • Check setup of end terminal resistance. • Check the power of connecting destination connected device. • Check P.C. board error of the connected device.
C12	—	—	General-purpose device I/F	Interface batch alarm of general-purpose control devices	Operation continued.	Error was input in general-purpose control device control interface.	<ul style="list-style-type: none"> • Check error input.
P30	Differs according to error contents of the with alarm		TCC-LINK	Follower unit error of group control	Operation continued.	An error occurred in follower unit of the group control. ([P30] is displayed only on the central control remote controller.)	<ul style="list-style-type: none"> • Check the check code of the unit with alarm.
	—	—	—	Duplicated central control address	Operation continued.	Central control addresses were duplicated.	<ul style="list-style-type: none"> • Check the address setup.

11-5. Sensor Characteristics

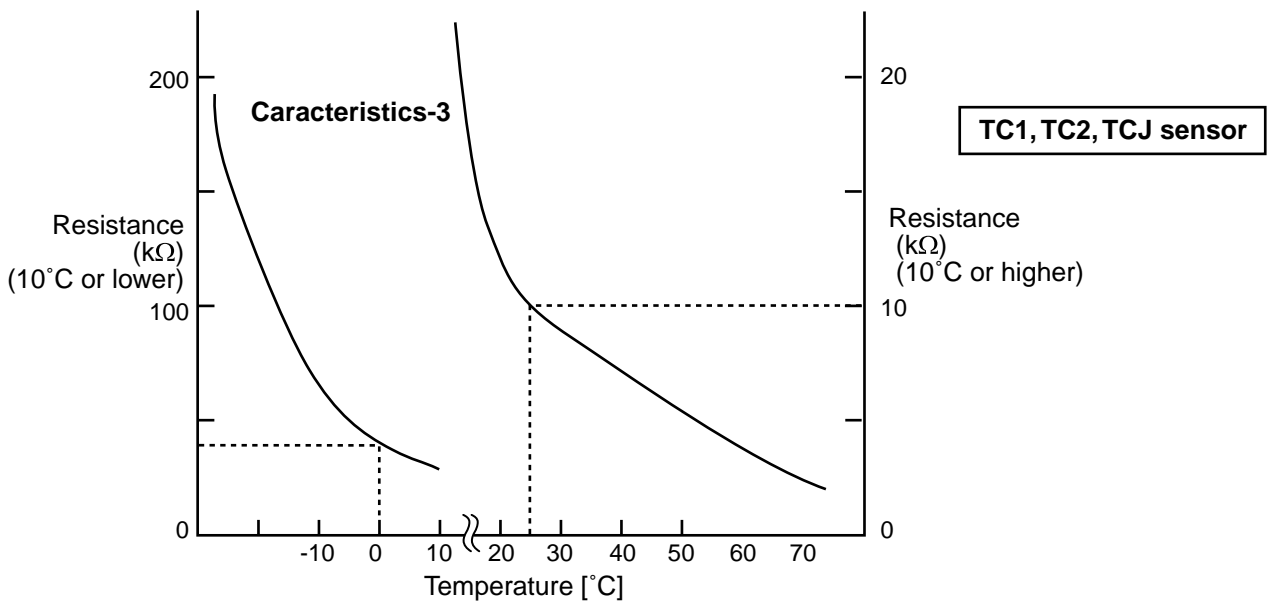
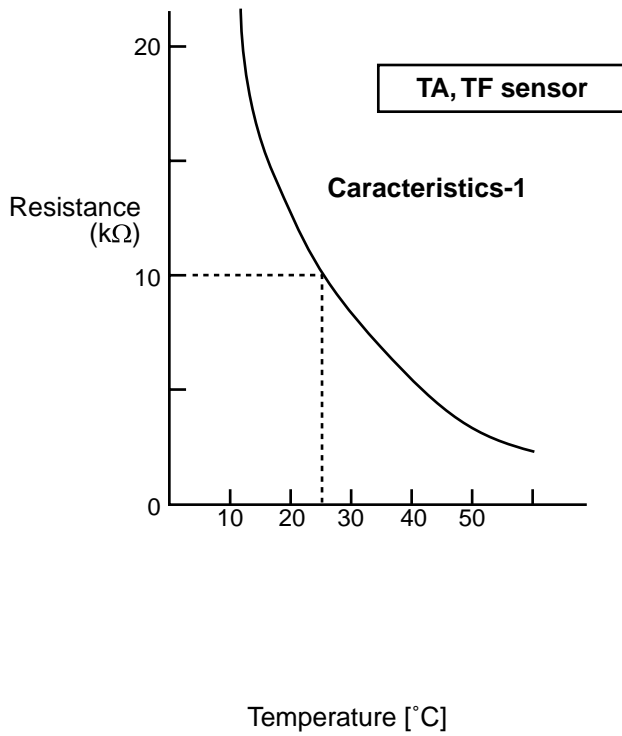

12. REPLACEMENT OF FAN ASSEMBLY

1 Remove the electric parts box cover.

Take off M4 screws (2 positions).

Electric parts box cover

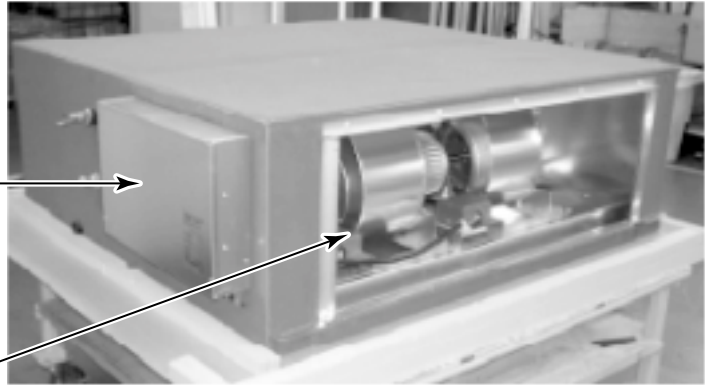

Fan assembly

- 1) The model in the left photo is AP0721, AP0961 types.
- 2) The one fan is provided to AP0481 type, two are provided to AP0721, AP0961 types, respectively. AP0481 type has the same configuration as AP0721, AP0961 types.

Remove the electric parts box cover.



2 Remove lead wires of the fan motor connected to the terminal block inside of the electric parts box.

One fan motor to AP0481 type, two fan motors to AP0721 / AP0961 type are provided.
(Photo: AP0961 type)

Remove Faston terminals of which wire color are blue (1), orange (2), black (3) in the fan motor lead wires.

Cut binding tie.

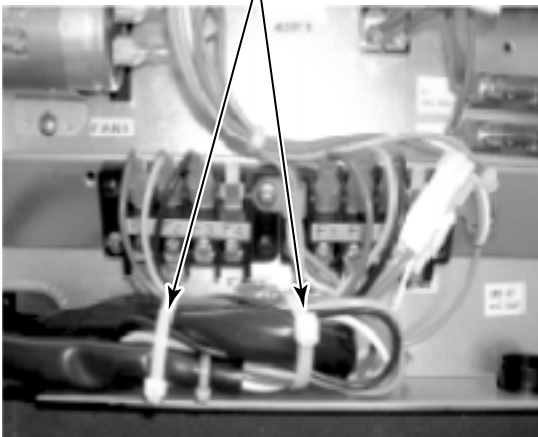

Remove the white and blue connectors.

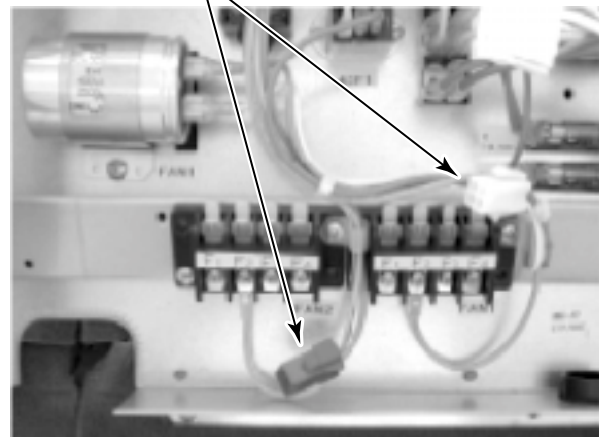

Status which tie wrap binding wire removed.

3 Take off eight M5 screws from the cabinet and then put them on the electric parts box.

Take off M5 screws (8 positions). →

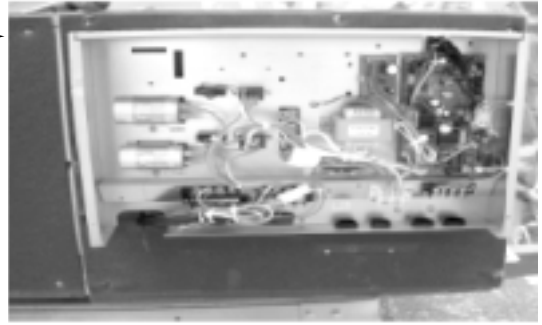

Remove the cover plate.

Cover plate

Take off the self tapping M4 screws (3 positions).

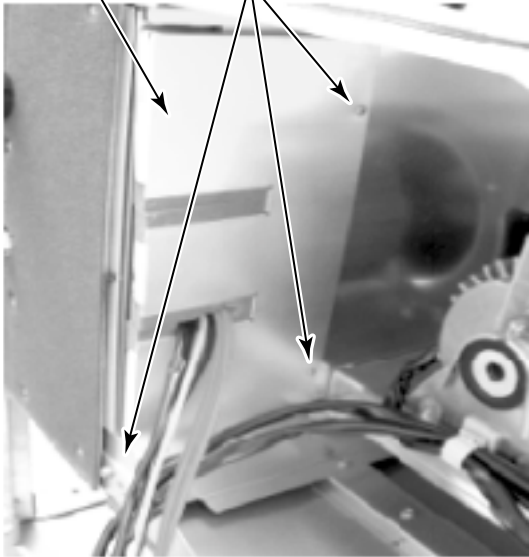

Removed status



4 Pull out the fan toward you.

Take off the self tapping M4 screws (3 positions).

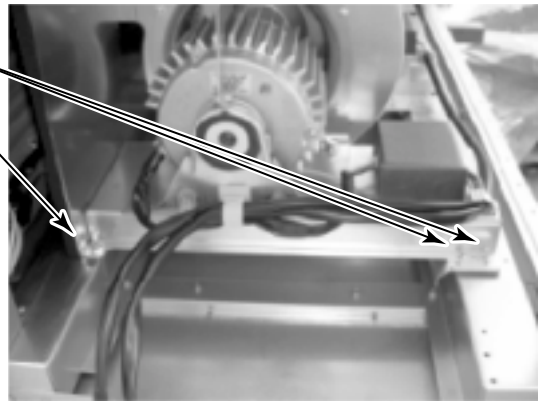

Status which all the fan assembly are pulled out.

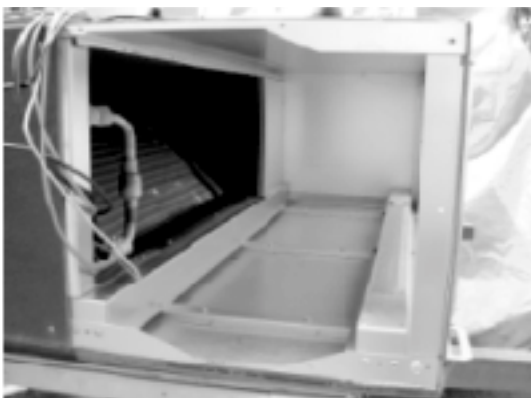

Pull out the fan toward you.

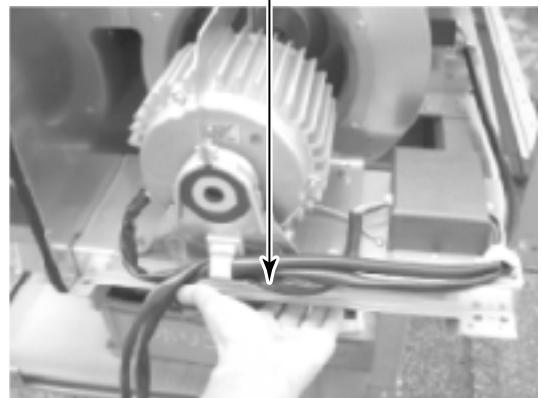

5 Remove the fan assembly from the air intake unit.

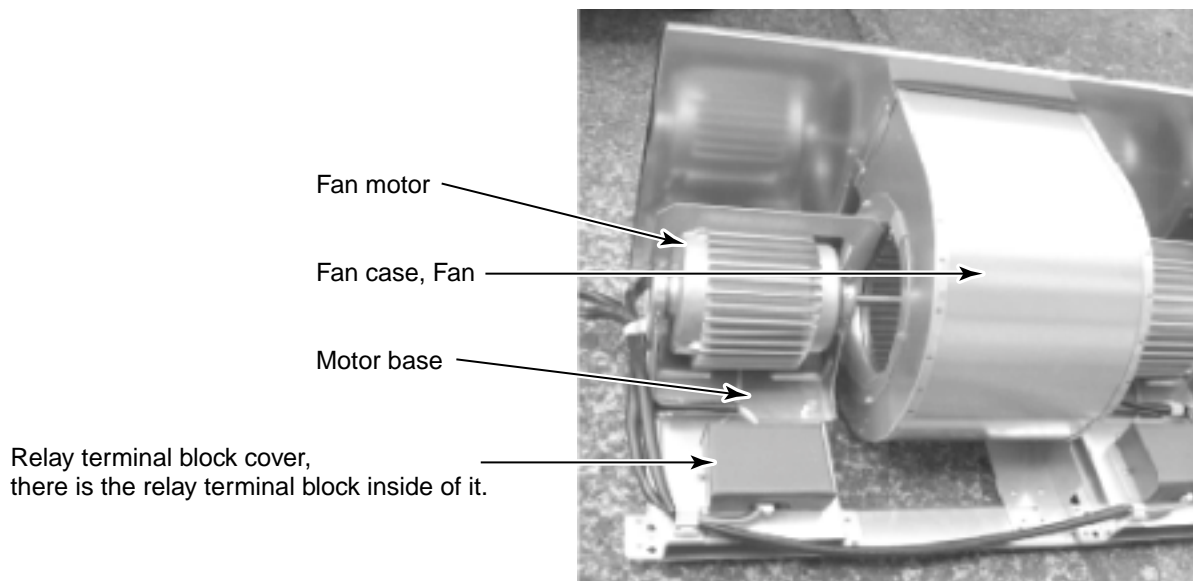

6 Replacement of fan and fan motor

Remove the relay terminal block cover.

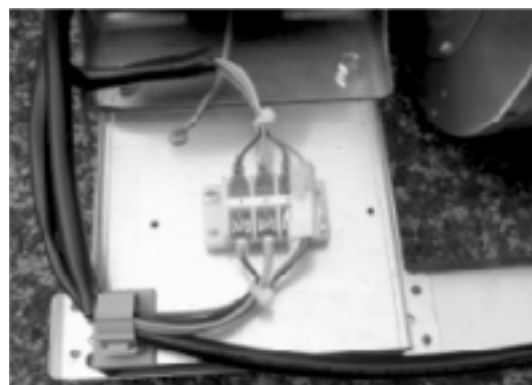

Remove the connector and Faston terminal.

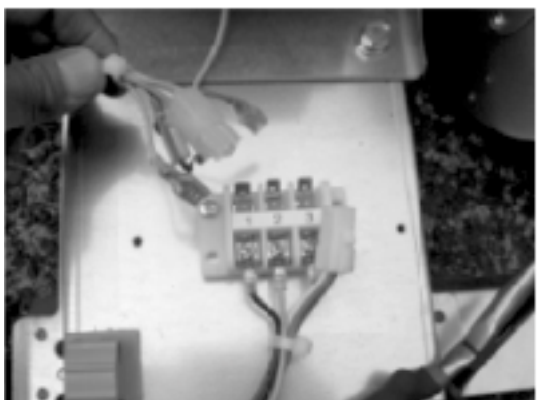

Remove the earth screw.



7 Remove the fan motor assembly from the fan assembly.

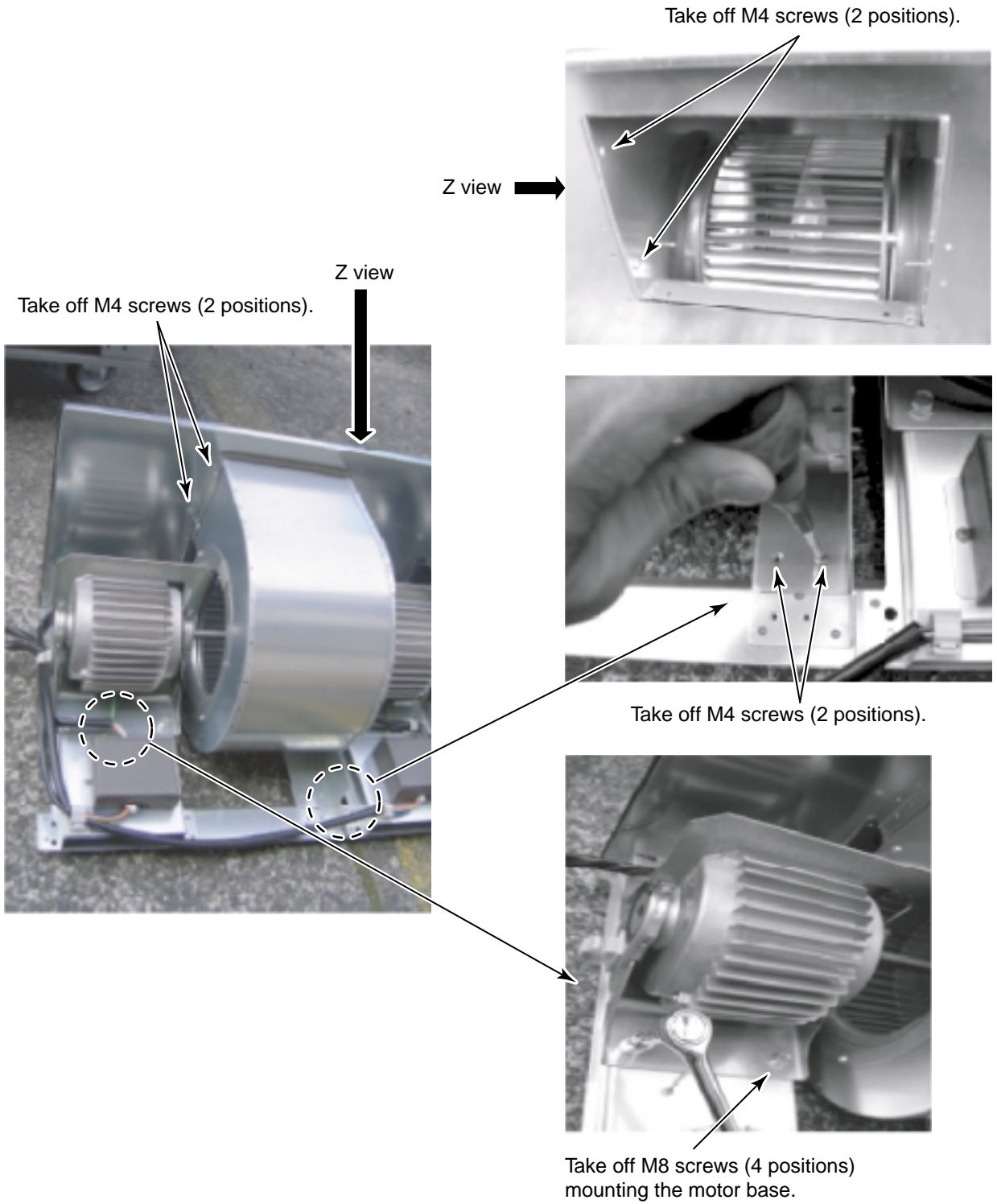

8 Remove parts to be replaced from the fan motor assembly.

Take off M4 screws (4 positions) from the bell mouth.

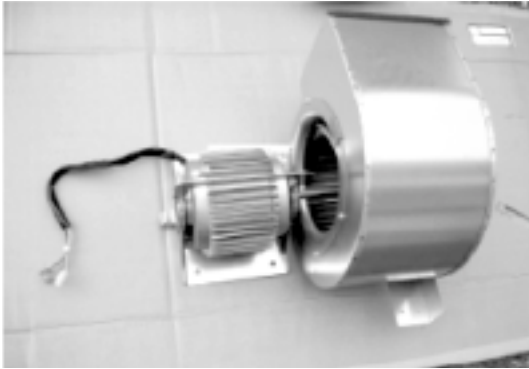

Loosen the setscrews.



Remove the fan



When replacing the fan motor, set it so that the model name label directs upward.

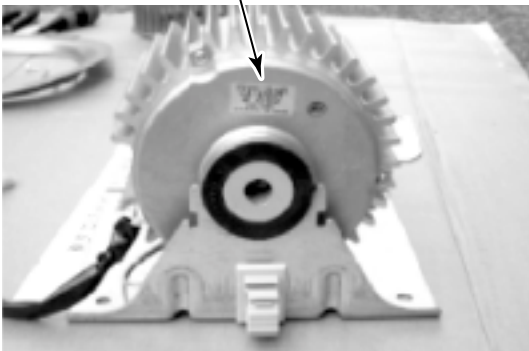

Replace the fan motor with a new one.

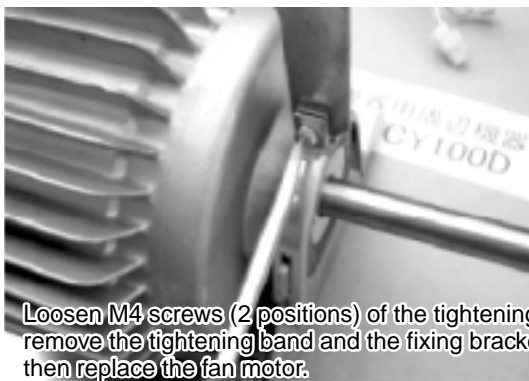
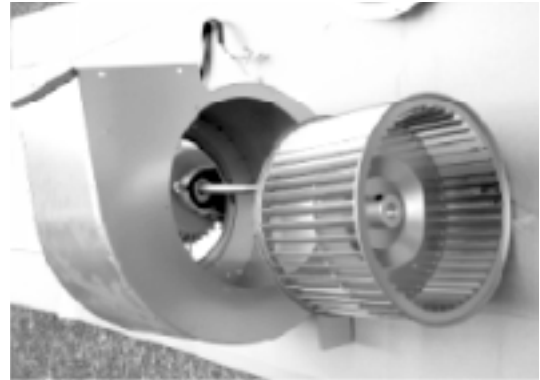

Loosen M4 screws (2 positions) of the tightening band, remove the tightening band and the fixing bracket and then replace the fan motor.

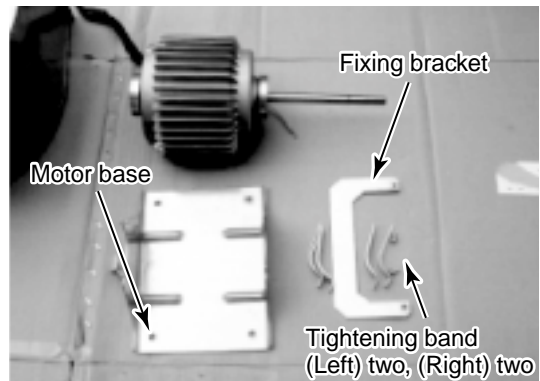

After replacement, assemble the fan in reverse procedure so that the assembly becomes the same status before replacement. Be sure there is no looseness of screws in assembling time. Check that the air blows off and the fan does not hit with the fan case, and also check there is no abnormal noise.

13. P.C. BOARD REPLACING PROCEDURES

Part code	Applicable Model	P.C. board Model	Label on P.C. board
431-6V-343	MMD-AP***HFE series	MCC-1403	03RD M02

<Set the type code and capacity code and then set DN [C8] = [0001].>

Notice when assembling P.C. board for indoor service

Before replacement, in the non-volatile memory (Hereinafter said EEPROM, IC10) installed on the indoor P.C. board, the important setting data such as type and capacity codes exclusive to the model at shipment from factory and moreover the line/indoor/group address which were set up (automatically/manually) at installation time are stored. Assemble and replace P.C. board for indoor service as described below.

After replacement, check the indoor air conditioner No. or group master/follower units to confirm whether setting contents are correct or not, and also confirm the cycle by a test run.

<Replacement procedure>

CASE 1

Under condition before replacement, power supply of the indoor air conditioner is able to turn on, and the setting contents can be read-out from the wired remote controller.

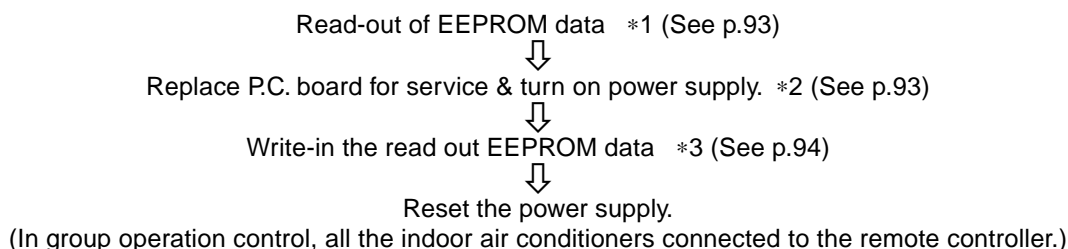

CASE 2

Under condition before replacement, power supply of the indoor air conditioner is unable to turn on, and the wired remote controller cannot be operated due to trouble of the power supply circuit to the remote controller. (P.C. board error)

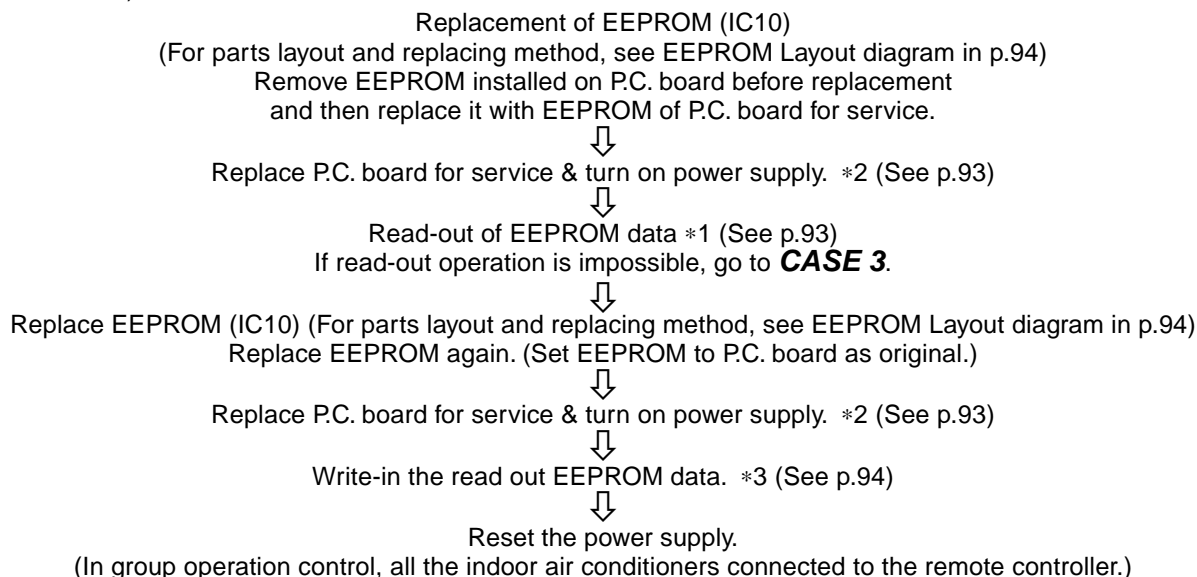

CASE 3

Before replacement, EEPROM is defective and read-out of setup contents is unavailable.

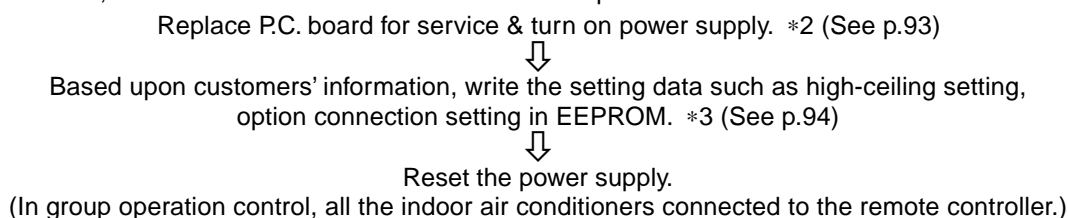

*1 Read-out operation of setting contents from EEPROM

(The other EEPROM contents of which settings were changed at local site than setting at shipment from factory are read out.)

- 1) Push **SET** + **CL** + **TEST** buttons concurrently for 4 seconds or more on the remote controller. **1**
(Corresponded to numbers in p.94. Remote controller operation diagram)
 - In case of group operation control, the firstly displayed unit No. is the master indoor air conditioner No. In this time, the item code (DN) displays **10**. The fan of the selected indoor air conditioner operates.
- 2) Every pushing **UNIT** button, the indoor air conditioner No. in the group control is successively displayed. **2**
Specify the indoor air conditioner No. to be replaced.
- 3) Using **TEMP** (**▼**) / (**▲**) buttons, the item code (DN) is increased / decreased one by one. **3**
- 4) At the first change the item code (DN) from **10** to **01**. (Setting of filter sign lighting time)
Note the contents of setting data displayed in this time.
- 5) Next change the item code (DN) by **TEMP** (**▼**) / (**▲**) buttons.
As same as above, note the contents of setting data.
- 6) After then repeat the procedure 5) and note the contents of the important setting data as shown in (Example) in the Attached table (p.95).
 - The item code (DN) is **01** to **FF**. In the part of the way, DN No. may skip.
- 7) After noting, push **TEST** button and return to the normal stop status. **6**
(Wait for approx. 1 minute until operation of the remote controller starts.)

Necessary item codes to the minimum

DN	Contents
10	Type
11	Indoor air conditioner capacity
12	Line address
13	Indoor address
14	Group address

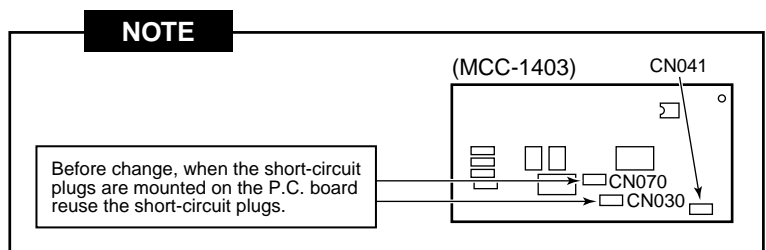

*2 Replacement of P.C. Board for Service

- 1) Replace the existing P.C. board with P.C. board for service.
In this time, shift the jumper wire (cut) setting (short-circuited) connection connector setting on the P.C. board before replacement to the new service P.C. board. (See the figure above.)
- 2) It is necessary to set the indoor air conditioner to be replaced and the remote controller to 1 : 1.
Turn on power supply of the indoor air conditioner by any one of the following methods according to the system configuration.
 - A) Case of single (individual) operation. Turn on power supply of the indoor air conditioner and proceed to ***3**.
 - B) Case of group operation
 - a) Power supply of the replaced indoor air conditioner only can be turned on.
Turn on power supply of the replaced indoor air conditioner and proceed to ***3**.
 - b) Power supplies of the indoor air conditioners cannot be turned on individually. (**CASE 1**)
 - i) Tentatively remove the group wires connected to terminal boards A and B of the replaced indoor air conditioner.
 - ii) Connect the remote controller wire only to the removed terminal block, turn on power supply of the indoor air conditioner and then proceed to ***3**.
* When the above methods are impossible, perform **CASE 2** below.
 - c) Power supplies of the indoor air conditioners cannot be turned on individually. (**CASE 2**)
 - i) Take off all CN41 connectors of the indoor air conditioners in the same group except the indoor air conditioner to be replaced.
 - ii) Turn on power supply of the indoor air conditioner and then proceed to ***3**.

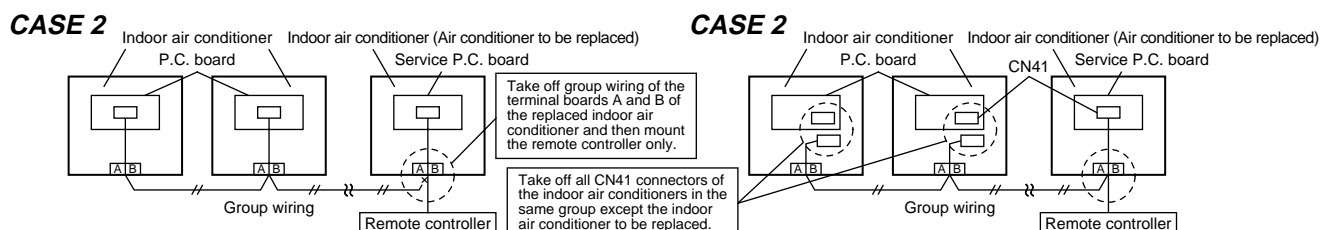

* Be sure to return the tentatively removed group wiring or CN41 connector to the original positions after finish of ***3** operation.

*3 Write-in operation of setting contents to EEPROM

(EEPROM setting contents mounted on the service P.C. board are those at shipment from factory.)

- 1) Push **SET** + **CL** + **TEST** buttons concurrently for 4 seconds or more on the remote controller. **1**
(Corresponded to numbers in p.94. Remote controller operation diagram) (*FLU* is displayed for UNIT No.)
In this time, the item code (DN) displays *10*. The fan of the indoor air conditioner operates.
- 2) Using **TEMP** (▼) / (▲) buttons, the item code (DN) is increased / decreased one by one. **3**
- 3) Firstly set type and capacity of the indoor air conditioner.
(The data at shipment from the factory is written in EEPROM by changing type and capacity.)
 - a) Set the item code (DN) to *10*. (As it is)
 - b) Set the type by **TIME** (▼) / (▲) buttons. **4**
(Fresh air intake unit (Duct type) is *0015*.): See attached table (p.95)
 - c) Push **SET** button. (OK if the display goes on.) **5**
 - d) Using **TEMP** (▼) / (▲) buttons, enter *11* to the item code (DN).
 - e) Set the capacity by **TIME** (▼) / (▲) buttons.
 - f) Push **SET** button. (OK if the display goes on.)

g) Using **TEMP** (▼) / (▲) buttons, enter *12* to the item code (DN).
 h) Set *0001* to the setting data by **TIME** (▼) / (▲) buttons.
 i) Push **SET** button. (OK if the display goes on.)

- j) Push **TEST** button to return the status to the normal stop status. **6**
- 4) Next write the contents such as address setting, which were set at the local site after installation in EEPROM.
- 5) Using **TEMP** (▼) / (▲) buttons, specify *11* to the item code (DN). (Setup of filter sign lighting time)
- 6) In this time, compare the contents of the displayed setting data (p.95) with contents noted in *1 (p.93) and the customers' information.
 - a) If data differs from them, change data to the noted contents by **TIME** (▼) / (▲) buttons and then push **SET** button. (OK if the display goes on.)
 - b) Do nothing if data matches with them.
- 7) Change the item code (DN) by **TEMP** (▼) / (▲) buttons. Check the contents of setting data as same as above and then change data to noted data contents before exchange.
- 8) After then repeat procedures 6) and 7).
- 9) After setting, push **TEST** button to return to the normal stop status. **6**

In a group operation, turn off the power supply once, return group wiring between indoor air conditioners and CN41 connector to the original status and then turn on power supplies of all the indoor air conditioners. (Wait for approx. 1 minute until operation of the remote controller.)

* The item code (DN) is *01* to *FF*. In the part of the way, DN No. may skip. When you changed data incorrectly and pushed **SET** button, you can return data to one before change by pushing **CL** button if item code (DN) is not yet changed.

<Remote controller operation diagram>

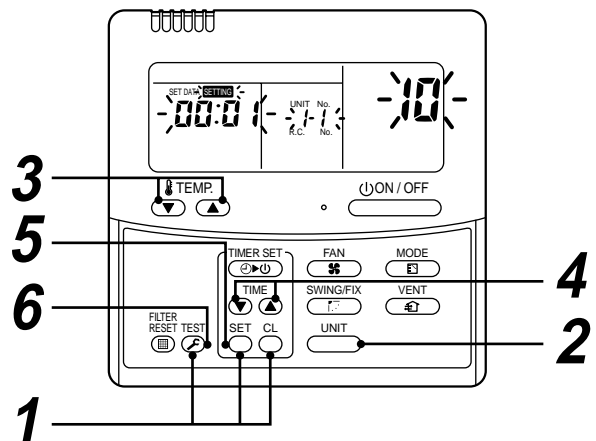

<EEPROM LAYOUT DIAGRAM>

EEPROM (IC10) is attached to IC socket. To remove it, use tweezers, etc. To attach it, match the direction as shown in the figure.

* When replacing EEPROM, be sure not to lead wire of IC.

P.C. board (MCC-1403)

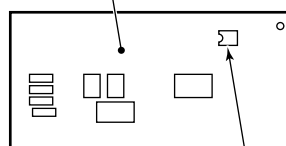

EEPROM (IC10)

Attach EEPROM so that notched direction of IC socket matches with direction of EEPROM.

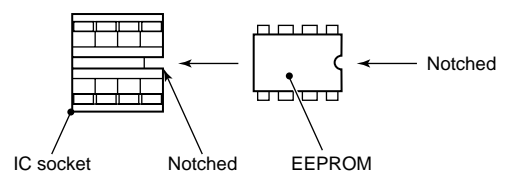

Setting contents note (Item code table (Example))

DN	Item	Contents memo	At shipment from factory
01	Filter sign lighting time		0002: 2500 hours
02	Filter dirty degree		0000: Standard
03	Central control address		0099: Undefined
06	Heating suction temp shift		0000: 0°C
0d	Existence of automatic cooling/heating mode		0001: No automatic mode
0F	Cooling only		0000: Heat pump
10	Type		0018: Fresh air intake unit (Duct type)
11	Indoor air conditioner capacity		According to capacity type
12	Line address		0099: Undefined
13	Indoor air conditioner address		0099: Undefined
14	Group address		0099: Undefined
28	Power failure automatic reset		0000: None
2A	Option/Abnormal input (CN70) selection		
2E	HA terminal (T10) selection		0000: Normal
40	Drain pump control		0001: Drain pump ON
60	Timer setting (Wired remote controller)		0000: Possible
72	Fan OFF in defrosting time		0001: To OFF

Type

Item code [10]

Setup data	Type	Model abb. name
0000	1-way Air Discharge Cassette	MMU-AP***SH
0001*	4-way Air Discharge Cassette	MMU-AP***H
0002	2-way Air Discharge Cassette	MMU-AP***WH
0003	1-way Air Discharge Cassette (Compact type)	MMU-AP***YH
0004	Concealed Duct Standard	MMD-AP***BH
0005	Slim Duct	MMD-AP***SPH MMD-AP***SH
0006	Concealed Duct High Static Pressure	MMD-AP***H
0007	Under Ceiling	MMC-AP***H
0008	High Wall	MMK-AP***H
0009		
0010	Floor Standing Cabinet	MML-AP***H
0011	Floor Standing Concealed	MML-AP***BH
0012		
0013	Floor Standing (Below 6HP)	MMF-AP***H
0014	Compact 4-way Air Discharge Cassette	MMU-AP***MH
0016	Fresh air intake indoor unit (Duct type)	MMU-AP***HFE

Indoor air conditioner capacity

Item code [11]

Setup data	Model	Setup data	Model
0000*	Invalid	0016	—
0001	007 type	0017	048 type
0002	—	0018	056 type
0003	009 type	0019	—
0004	—	0020	—
0005	012 type	0021	072 type
0006	—	0022	—
0007	015 type	0023	096 type
0008	—	0024	—
0009	018 type	0025	—
0010	—	0026	—
0011	024 type	0027	—
0012	027 type	0028	—
0013	030 type	~	—
0014	—	0034	—
0015	036 type		

* Initial setup value of EEPROM installed on the service P.C. board

<Set type code and capacity code, besides set DN [C8] = [0001].>

14. EXPLODED VIEWS AND PARTS LIST

14-1. Fresh Air Intake Indoor Unit for S-MMS

MMD-AP0481HFE

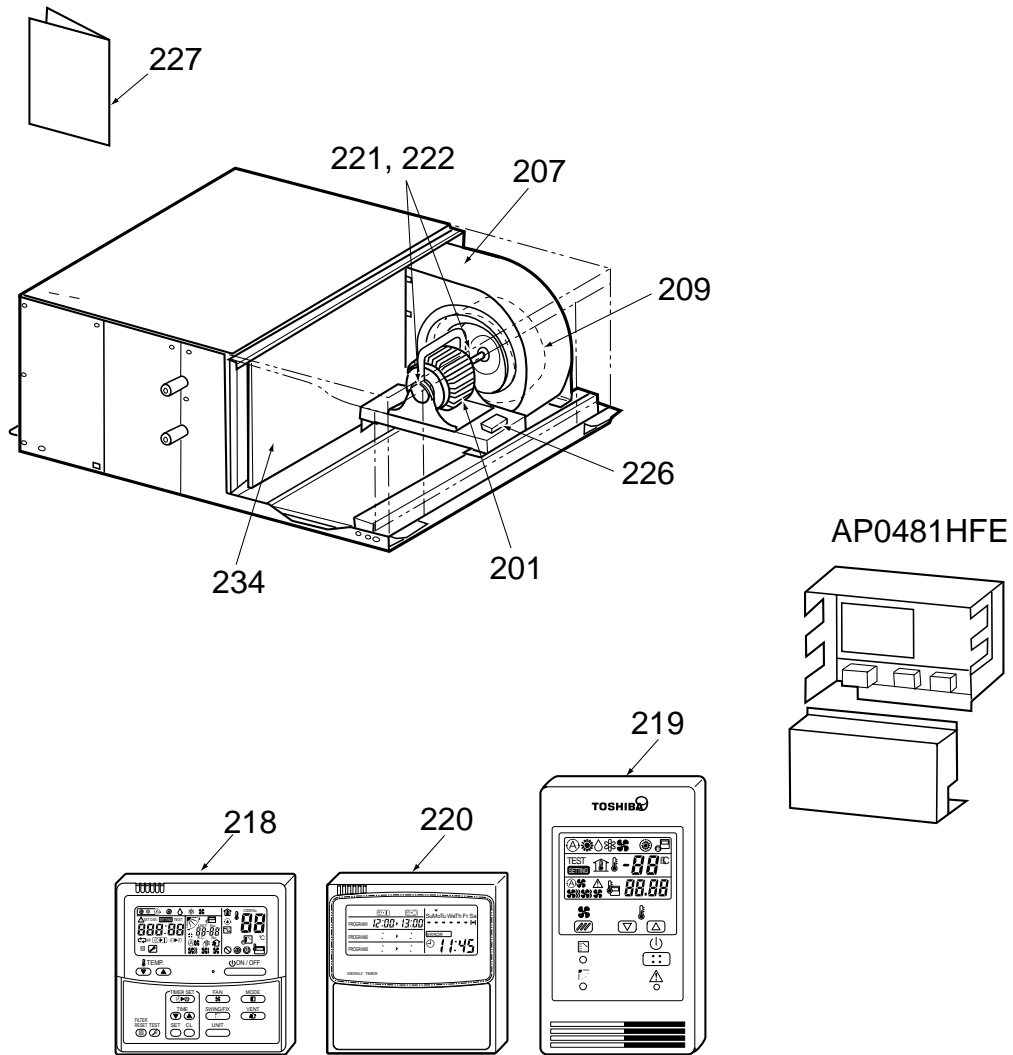

Location No.	Part No.	Description	MMD-AP0481HFE
201	4312C014	Motor, Fan, STF200-160-4AR	1
207	43122109	Case, Fan	1
209	43020352	Fan	1
218	4316V194	Remote Controller, SX-A1EE	1
219	4316V195	Remote Controller, SX-A11JE2	1
220	4316V196	Remote Controller, EX-W2JE2	1
221	43139154	Band, Motor, Left	2
222	43139155	Band, Motor, Right	2
226	43160549	Terminal, Block, JXO-3B	1
227	431S8064	Owners Manual	1
234	43172200	Pan Ass'y, Drain	1

MMD-AP0721HFE, MMD-AP0961HFE

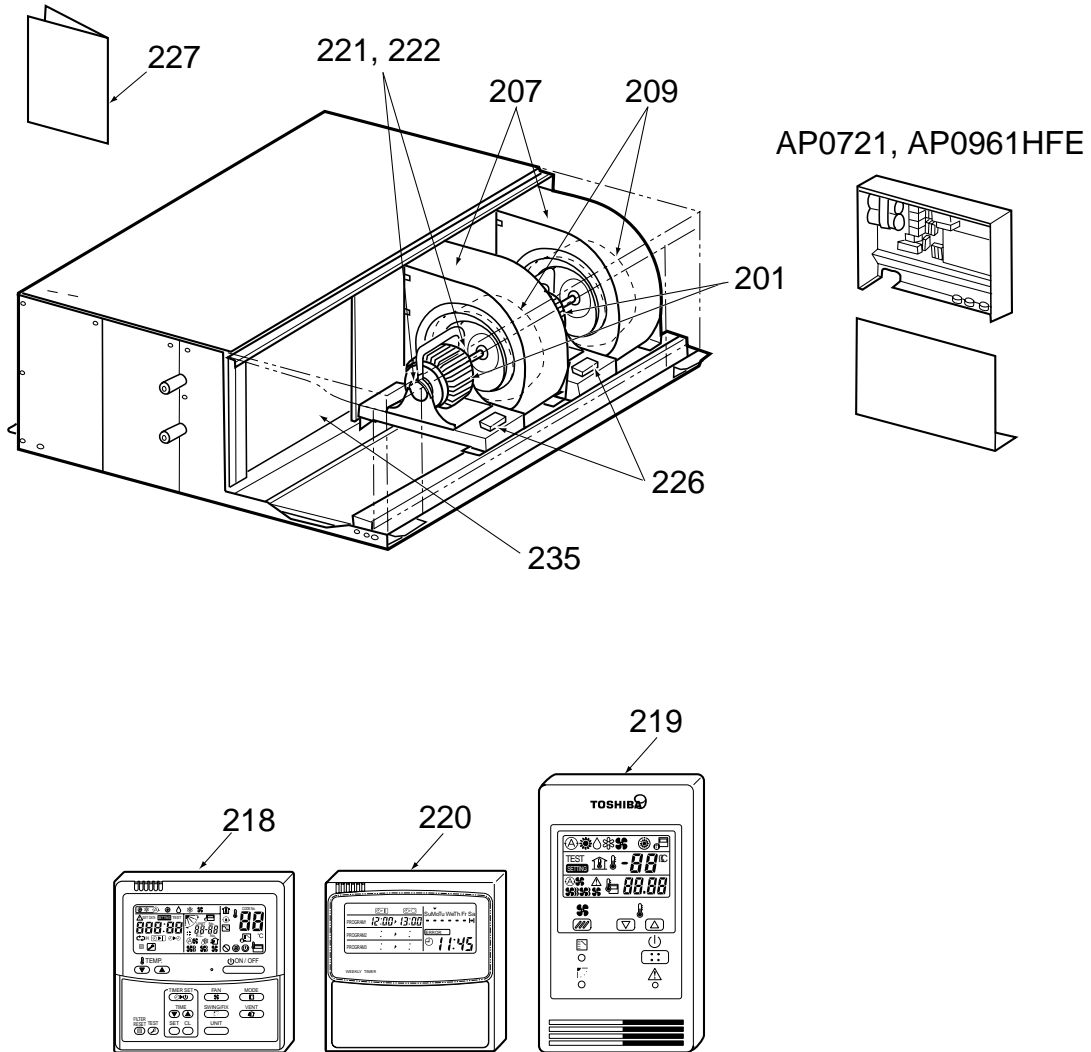

Location No.	Part No.	Description	MMD-AP0721HFE	MMD-AP0961HFE
201	4312C014	Motor, Fan, STF200-160-4AR	2	2
207	43122109	Case, Fan	2	2
209	43020352	Fan	2	2
218	4316V194	Remote Controller, SX-A1EE	1	1
219	4316V195	Remote Controller, SX-A11JE2	1	1
220	4316V196	Remote Controller, EX-W2JE2	1	1
221	43139154	Band, Motor, Left	4	4
222	43139155	Band, Motor, Right	4	4
226	43160549	Terminal, Block, JXO-3B	2	2
227	431S8064	Owners Manual	1	1
235	43172199	Pan Ass'y, Drain	1	1

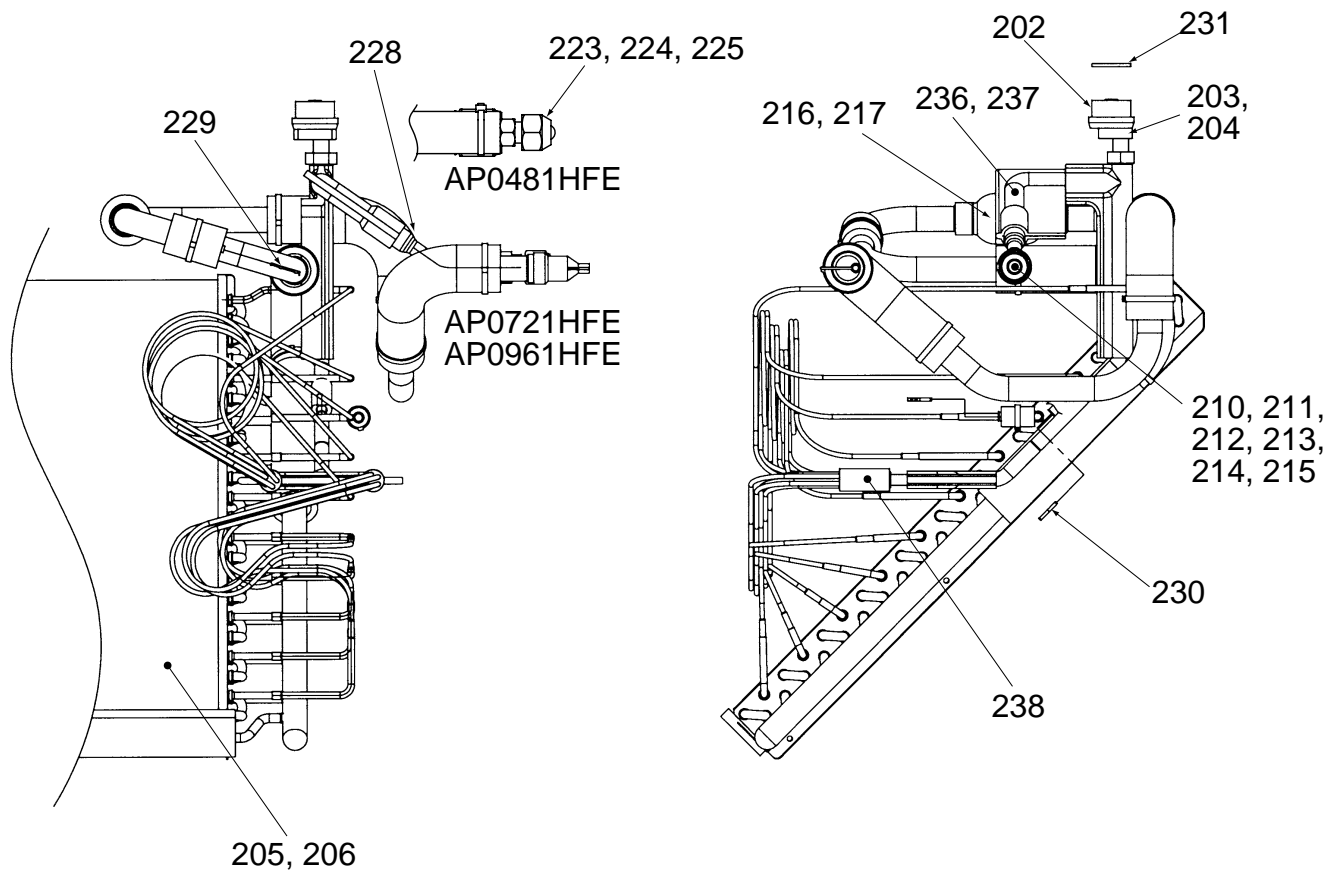

Location No.	Part No.	Description	MMD-AP0481HFE	MMD-AP0721HFE	MMD-AP0961HFE
202	43146707	Motor, PMV, EDM-MD12TF-3	1	1	1
203	43146723	Body, PMV	1	—	—
204	43146729	Body, PMV	—	1	1
205	4314J373	Evaporator Ass'y	1	—	—
206	4314J374	Evaporator Ass'y	—	1	1
210	43149355	Nut, Flare, 3/8 IN	1	—	—
211	43049776	Socket, 3/8 IN	1	—	—
212	43047609	Bonnet	1	—	—
213	43047688	Nut, Flare, 1/2 IN	—	1	1
214	43149332	Socket	—	1	1
215	43147195	Bonnet, 1/2 IN	—	1	1
216	4314Q053	Strainer, DIA 21	1	—	—
217	4314Q052	Strainer, DIA 45	—	1	1
223	43149352	Nut, Flare, 5/8 IN	1	—	—
224	43149354	Socket, 5/8 IN	1	—	—
225	43194029	Bonnet	1	—	—
228	43147649	Strainer	1	1	1
229	43107215	Holder, Sensor	1	1	1
230	43019904	Holder, Sensor	2	2	2
231	43149314	Sheet, PMV	1	1	1
236	4314Q067	Pipe Ass'y, Liquid	1	—	—
237	4314Q066	Pipe Ass'y, Liquid	—	1	1
238	43147706	Distributor	1	1	1

MMD-AP0481HFE

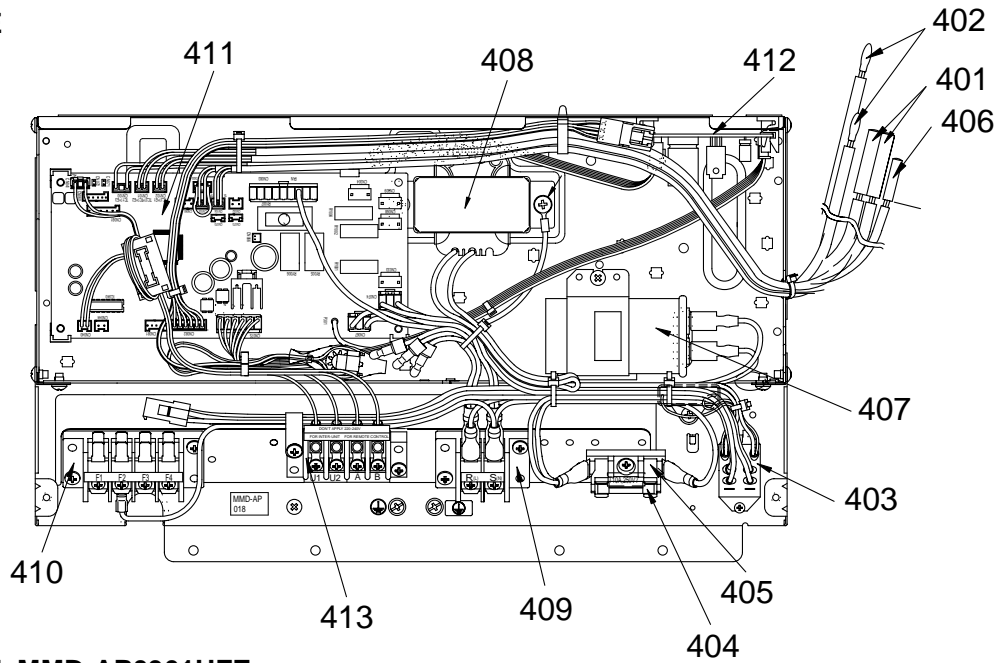

MMD-AP0721HFE, MMD-AP0961HFE

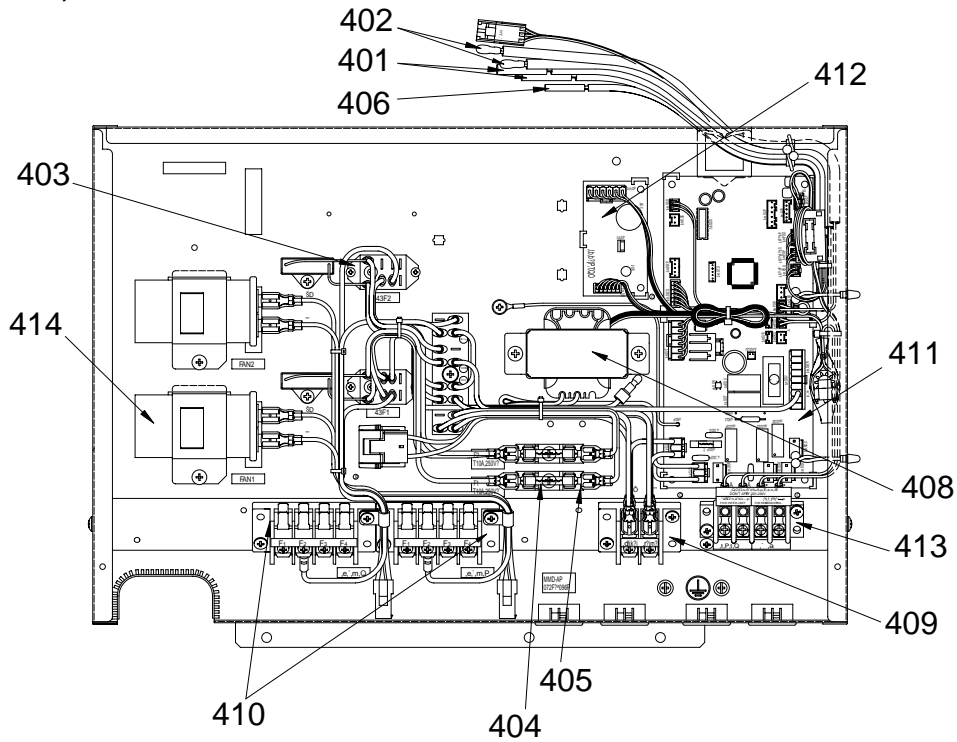

Location No.	Part No.	Description	MMD-AP0481HFE	MMD-AP0721HFE	MMD-AP0961HFE
401	43050425	Sensor Ass'y, TC (F6)	2	2	2
402	43050426	Sensor Ass'y, TA	2	2	2
403	43154173	Relay, LY2F-L, AC230V	1	2	2
404	43160577	Fuse, 10A	1	2	2
405	43060859	Fuse Block, 30A, 250V	1	2	2
406	43150320	Sensor Ass'y, TG (F4)	1	1	1
407	43155212	Capacitor, 400V, 8MF	1	—	—
408	43158204	Transformer, TT-13 (AC220V-240V)	1	1	1
409	43160575	Terminal, Block, 2P, 20A, AC300V	1	1	1
410	43160576	Terminal, Block, 4P, 20A	1	2	2
411	4316V343	P.C.board Ass'y, MCC-1520	1	1	1
412	4316V345	P.C.board Ass'y, MCC-1404	1	1	1
413	43160574	Terminal, 4P	1	1	1
414	43155208	Capacitor, 500V, 4MF	—	2	2

WARNINGS ON REFRIGERANT LEAKAGE

Check of Concentration Limit

The room in which the air conditioner is to be installed requires a design that in the event of refrigerant gas leaking out, its concentration will not exceed a set limit.

The refrigerant R410A which is used in the air conditioner is safe, without the toxicity or combustibility of ammonia, and is not restricted by laws to be imposed which protect the ozone layer. However, since it contains more than air, it poses the risk of suffocation if its concentration should rise excessively. Suffocation from leakage of R410A is almost non-existent. With the recent increase in the number of high concentration buildings, however, the installation of multi air conditioner systems is on the increase because of the need for effective use of floor space, individual control, energy conservation by curtailing heat and carrying power etc.

Most importantly, the multi air conditioner system is able to replenish a large amount of refrigerant compared with conventional individual air conditioners. If a single unit of the multi conditioner system is to be installed in a small room, select a suitable model and installation procedure so that if the refrigerant accidentally leaks out, its concentration does not reach the limit (and in the event of an emergency, measures can be made before injury can occur).

In a room where the concentration may exceed the limit, create an opening with adjacent rooms, or install mechanical ventilation combined with a gas leak detection device.

The concentration is as given below.

$$\frac{\text{Total amount of refrigerant (kg)}}{\text{Min. volume of the indoor unit installed room (m}^3\text{)}} \leq \text{Concentration limit (kg/m}^3\text{)}$$

The concentration limit of R410A which is used in multi air conditioners is 0.3kg/m³.

NOTE 1 :

If there are 2 or more refrigerating systems in a single refrigerating device, the amounts of refrigerant should be as charged in each independent device.

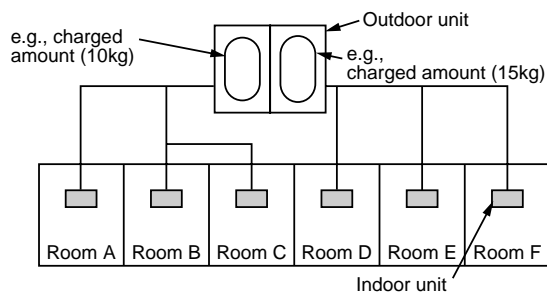

For the amount of charge in this example:

The possible amount of leaked refrigerant gas in rooms A, B and C is 10kg.

The possible amount of leaked refrigerant gas in rooms D, E and F is 15kg.

Important

NOTE 2 :

The standards for minimum room volume are as follows.

- (1) No partition (shaded portion)

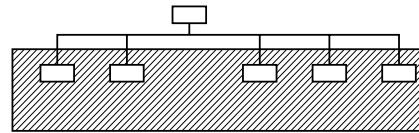

- (2) When there is an effective opening with the adjacent room for ventilation of leaking refrigerant gas (opening without a door, or an opening 0.15% or larger than the respective floor spaces at the top or bottom of the door).

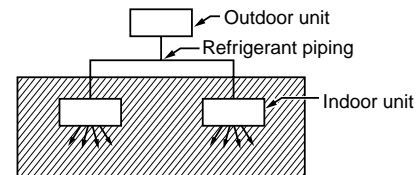

- (3) If an indoor unit is installed in each partitioned room and the refrigerant piping is interconnected, the smallest room of course becomes the object. But when a mechanical ventilation is installed interlocked with a gas leakage detector in the smallest room where the density limit is exceeded, the volume of the next smallest room becomes the object.

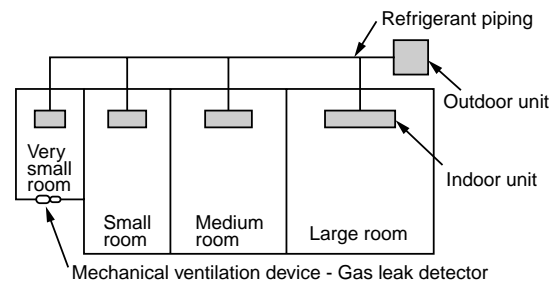

NOTE 3 :

The minimum indoor floor area compared with the amount of refrigerant is roughly as follows:
(When the ceiling is 2.7m high)

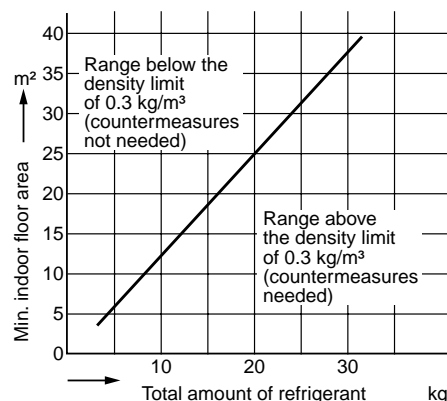

TOSHIBA CARRIER CORPORATION

2 CHOME 12-32, KONAN, MINATOKU, TOKYO, 108-0075, JAPAN

Copyright © 2007 TOSHIBA CARRIER CORPORATION, ALL Rights Reserved.