

TOSHIBA

FILE NO. A06-002

SERVICE MANUAL

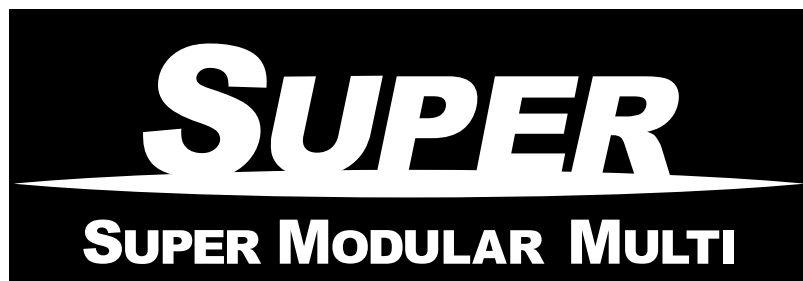

<Compact 4-Way Air Discharge Cassette Type>

MMU-AP0071MH

MMU-AP0091MH

MMU-AP0121MH

MMU-AP0151MH

MMU-AP0181MH









- This Service Manual describes contents of the Compact 4-Way Air Discharge Cassette indoor unit. For the outdoor unit, refer to the Manual with **FILE No. A03-009, A05-004, A05-015.**

CONTENTS







SAFETY CAUTION	3
1. CONSTRUCTION VIEWS (EXTERNAL VIEWS)	8
2. WIRING DIAGRAM	9
3. PARTS RATING	10
4. REFRIGERATING CYCLE DIAGRAM	34
5. CONTROL OUTLINE	35
6. APPLIED CONTROL	39
7. TROUBLESHOOTING	44
8. CONFIGURATION OF CONTROL CIRCUIT	94
9. DETACHMENTS	99
10. P.C. BOARD EXCHANGE PROCEDURES	108
11. EXPLODED VIEWS AND PARTS LIST	113

SAFETY CAUTION



The important contents concerned to the safety are described on the product itself and on this Service Manual. Please read this Service Manual after understanding the described items thoroughly in the following contents, and keep them.

 WARNING	
 Check earth wires.	Before troubleshooting or repair work, check the earth wire is connected to the earth terminals of the main unit, otherwise an electric shock is caused when a leak occurs. If the earth wire is not correctly connected, contact an electric engineer for rework.
 Prohibition of modification.	Do not modify the products. Do not also disassemble or modify the parts. It may cause a fire, electric shock or injury.
 Use specified parts.	For spare parts, use those specified (*). If unspecified parts are used, a fire or electric shock may be caused. *: For details, refer to the parts list.
 Do not bring a child close to the equipment.	Before troubleshooting or repair work, do not bring a third party (a child, etc.) except the repair engineers close to the equipment. It causes an injury with tools or disassembled parts. Please inform the users so that the third party (a child, etc.) does not approach the equipment.
 Insulating measures	Connect the cut-off lead cables with crimp contact, etc, put the closed end side upward and then apply a water-cut method, otherwise a leak or production of fire is caused at the users' side.
 No fire	When repairing the refrigerating cycle, take the following measures. 1) Be attentive to fire around the cycle. When using a gas stove, etc, be sure to put out fire before work; otherwise the oil mixed with refrigerant gas may catch fire. 2) Do not use a welder in the closed room. When using it without ventilation, carbon monoxide poisoning may be caused. 3) Do not bring inflammables close to the refrigerant cycle, otherwise fire of the welder may catch the inflammables.
 Refrigerant	Check the used refrigerant name and use tools and materials of the parts which match with it. For the products which use R410A refrigerant, the refrigerant name is indicated at a position on the outdoor unit where is easy to see. To prevent miss-charging, the route of the service port is changed from one of the former R22. For an air conditioner which uses R410A, never use other refrigerant than R410A. For an air conditioner which uses other refrigerant (R22, etc.), never use R410A. If different types of refrigerant are mixed, abnormal high pressure generates in the refrigerating cycle and an injury due to breakage may be caused. Do not charge refrigerant additionally. If charging refrigerant additionally when refrigerant gas leaks, the refrigerant composition in the refrigerating cycle changes resulted in change of air conditioner characteristics or refrigerant over the specified standard amount is charged and an abnormal high pressure is applied to the inside of the refrigerating cycle resulted in cause of breakage or injury. Therefore if the refrigerant gas leaks, recover the refrigerant in the air conditioner, execute vacuuming, and then newly recharge the specified amount of liquid refrigerant. In this time, never charge the refrigerant over the specified amount. When recharging the refrigerant in the refrigerating cycle, do not mix the refrigerant or air other than R410A into the specified refrigerant. If air or others is mixed with the refrigerant, abnormal high pressure generates in the refrigerating cycle resulted in cause of injury due to breakage. After installation work, check the refrigerant gas does not leak. If the refrigerant gas leaks in the room, poisonous gas generates when gas touches to fire such as fan heater, stove or cooking stove though the refrigerant gas itself is innocuous. Never recover the refrigerant into the outdoor unit. When the equipment is moved or repaired, be sure to recover the refrigerant with recovering device. The refrigerant cannot be recovered in the outdoor unit; otherwise a serious accident such as breakage or injury is caused.

⚠ WARNING

 Assembly/Cabling	<p>After repair work, surely assemble the disassembled parts, and connect and lead the removed cables as before. Perform the work so that the cabinet or panel does not catch the inner cables.</p> <p>If incorrect assembly or incorrect cable connection was done, a disaster such as a leak or fire is caused at user's side.</p>
 Insulator check	<p>After the work has finished, be sure to use an insulation tester set (500V mugger) to check the resistance is 2MW or more between the charge section and the non-charge metal section (Earth position).</p> <p>If the resistance value is low, a disaster such as a leak or electric shock is caused at user's side.</p>
 Ventilation	<p>When the refrigerant gas leaks during work, execute ventilation.</p> <p>If the refrigerant gas touches to a fire, poisonous gas generates. A case of leakage of the refrigerant and the closed room full with gas is dangerous because a shortage of oxygen occurs. Be sure to execute ventilation.</p>
 Be attentive to electric shock	<p>When checking the circuit inevitably under condition of the power-ON, use rubber gloves and others not to touch to the charging section.</p> <p>If touching to the charging section, an electric shock may be caused.</p>
 Compulsion	<p>When the refrigerant gas leaks, find up the leaked position and repair it surely.</p> <p>If the leaked position cannot be found up and the repair work is interrupted, pump-down and tighten the service valve, otherwise the refrigerant gas may leak into the room. The poisonous gas generates when gas touches to fire such as fan heater, stove or cooking stove though the refrigerant gas itself is innocuous.</p> <p>When installing equipment which includes a large amount of charged refrigerant such as a multi air conditioner in a sub-room, it is necessary that the density does not the limit even if the refrigerant leaks.</p> <p>If the refrigerant leaks and exceeds the limit density, an accident of shortage of oxygen is caused.</p> <p>For the installation/moving/reinstallation work, follow to the Installation Manual.</p> <p>If an incorrect installation is done, a trouble of the refrigerating cycle, water leak, electric shock or fire is caused.</p>
 Check after repair	<p>After repair work has finished, check there is no trouble.</p> <p>If check is not executed, a fire, electric shock or injury may be caused. For a check, turn off the power breaker.</p> <p>After repair work (installation of front panel and cabinet) has finished, execute a test run to check there is no generation of smoke or abnormal sound.</p> <p>If check is not executed, a fire or an electric shock is caused. Before test run, install the front panel and cabinet.</p>
 Check after reinstallation	<p>Check the following items after reinstallation.</p> <ol style="list-style-type: none"> 1) The earth wire is correctly connected. 2) The power cord is not caught in the product. 3) There is no inclination or unsteadiness and the installation is stable. <p>If check is not executed, a fire, an electric shock or an injury is caused.</p>

⚠ CAUTION

 Put on gloves	<p>Be sure to put on gloves (*) during repair work.</p> <p>If not putting on gloves, an injury may be caused with the parts, etc.</p> <p>(*) Heavy gloves such as work gloves</p>
 Cooling check	<p>When the power was turned on, start to work after the equipment has been sufficiently cooled.</p> <p>As temperature of the compressor pipes and others became high due to cooling/heating operation, a burn may be caused.</p>

• New Refrigerant (R410A)

This air conditioner adopts a new HFC type refrigerant (R410A) which does not deplete the ozone layer.

1. Safety Caution Concerned to New Refrigerant

The pressure of R410A is high 1.6 times of that of the former refrigerant (R22). Accompanied with change of refrigerant, the refrigerating oil has been also changed. Therefore, be sure that water, dust, the former refrigerant or the former refrigerating oil is not mixed into the refrigerating cycle of the air conditioner with new refrigerant during installation work or service work. If an incorrect work or incorrect service is performed, there is a possibility to cause a serious accident. Use the tools and materials exclusive to R410A to purpose a safe work.

2. Cautions on Installation/Service

- (1) Do not mix the other refrigerant or refrigerating oil.

For the tools exclusive to R410A, shapes of all the joints including the service port differ from those of the former refrigerant in order to prevent mixture of them.

- (2) As the use pressure of the new refrigerant is high, use material thickness of the pipe and tools which are specified for R410A.

- (3) In the installation time, use clean pipe materials and work with great attention so that water and others do not mix in because pipes are affected by impurities such as water, oxide scales, oil, etc. Use the clean pipes.

Be sure to brazing with flowing nitrogen gas. (Never use gas other than nitrogen gas.)

- (4) For the earth protection, use a vacuum pump for air purge.

- (5) R410A refrigerant is azeotropic mixture type refrigerant. Therefore use liquid type to charge the refrigerant. (If using gas for charging, composition of the refrigerant changes and then characteristics of the air conditioner change.)

3. Pipe Materials

For the refrigerant pipes, copper pipe and joints are mainly used. It is necessary to select the most appropriate pipes to conform to the standard. Use clean material in which impurities adhere inside of pipe or joint to a minimum.

- (1) Copper pipe

<Piping>

The pipe thickness, flare finishing size, flare nut and others differ according to a refrigerant type.

When using a long copper pipe for R410A, it is recommended to select "Copper or copper-base pipe without seam" and one with bonded oil amount 40mg/10m or less. Also do not use crushed, deformed, discolored (especially inside) pipes. (Impurities cause clogging of expansion valves and capillary tubes.)

<Flare nut>

Use the flare nuts which are attached to the air conditioner unit.

- (2) Joint

The flare joint and socket joint are used for joints of the copper pipe.

The joints are rarely used for installation of the air conditioner. However clear impurities when using them.

4. Tools

(1) Required Tools for R410A

Mixing of different types of oil may cause a trouble such as generation of sludge, clogging of capillary, etc. Accordingly, the tools to be used are classified into the following three types.

- 1) Tools exclusive for R410A (Those which cannot be used for conventional refrigerant (R22))
- 2) Tools exclusive for R410A, but can be also used for conventional refrigerant (R22)
- 3) Tools commonly used for R410A and for conventional refrigerant (R22)

The table below shows the tools exclusive for R410A and their interchangeability.

Tools exclusive for R410A (The following tools for R410A are required.)

Tools whose specifications are changed for R410A and their interchangeability

No.	Used tool	Usage	R410A air conditioner installation		Conventional air conditioner installation
			Existence of new equipment for R410A	Whether conven- tional equipment can be used	Whether new equipment can be used with conventional refrigerant
①	Flare tool	Pipe flaring	Yes	*(Note 1)	Yes
②	Copper pipe gauge for adjusting projection margin	Flaring by conventional flare tool	Yes	*(Note 1)	*(Note 1)
③	Torque wrench	Connection of flare nut	Yes	No	No
④	Gauge manifold	Evacuating, refrigerant charge, run check, etc.	Yes	No	No
⑤	Charge hose				
⑥	Vacuum pump adapter	Vacuum evacuating	Yes	No	Yes
⑦	Electronic balance for refrigerant charging	Refrigerant charge	Yes	Yes	Yes
⑧	Refrigerant cylinder	Refrigerant charge	Yes	No	No
⑨	Leakage detector	Gas leakage check	Yes	No	Yes
⑨	Charging cylinder	Refrigerant charge	(Note 2)	No	No

(Note 1) When flaring is carried out for R410A using the conventional flare tools, adjustment of projection margin is necessary. For this adjustment, a copper pipe gauge, etc. are necessary.

(Note 2) Charging cylinder for R410A is being currently developed.

General tools (Conventional tools can be used.)

In addition to the above exclusive tools, the following equipments which serve also for R22 are necessary as the general tools.

- | | |
|--|---|
| <ol style="list-style-type: none"> (1) Vacuum pump
Use vacuum pump by
attaching vacuum pump adapter. (2) Torque wrench (3) Pipe cutter (4) Reamer (5) Pipe bender (6) Level vial | <ol style="list-style-type: none"> (7) Screwdriver (+, -) (8) Spanner or Monkey wrench (9) Hole core drill (10) Hexagon wrench (Opposite side 4mm) (11) Tape measure (12) Metal saw |
|--|---|

Also prepare the following equipments for other installation method and run check.

- | | |
|--|---|
| <ol style="list-style-type: none"> (1) Clamp meter (2) Thermometer | <ol style="list-style-type: none"> (3) Insulation resistance tester (4) Electroscop |
|--|---|

5. Recharge of Refrigerant

When recharge of the refrigerant is required, charge the new refrigerant with the specified amount in the procedure as described below.

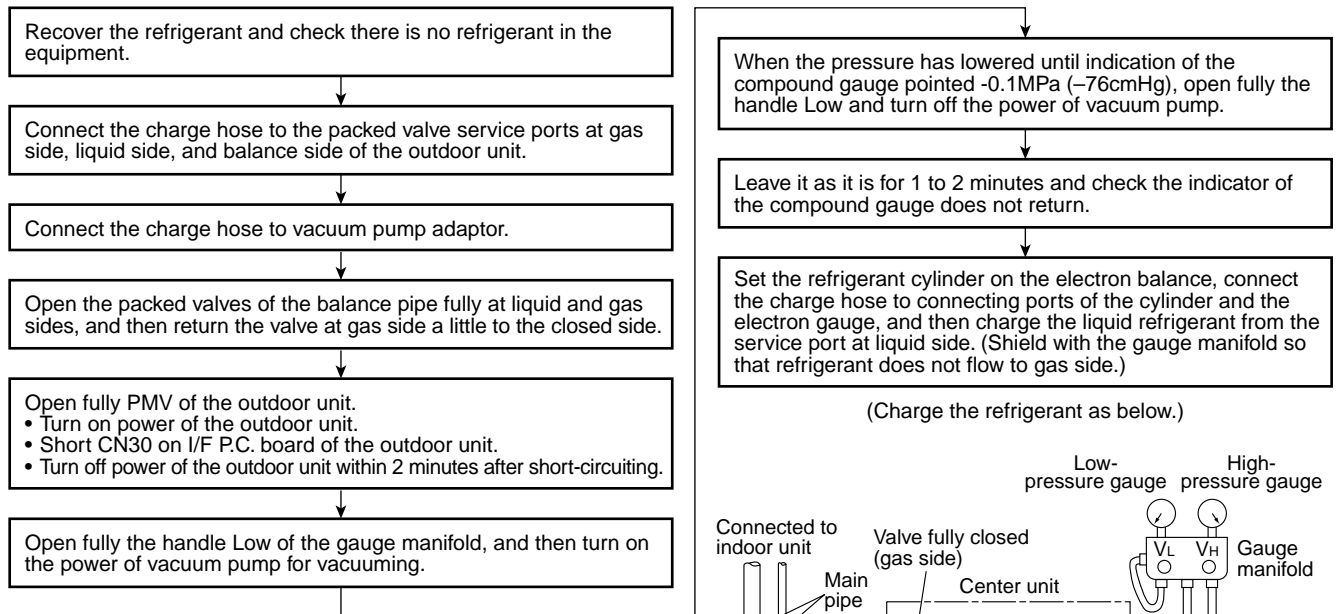

- ① Never charge the refrigerant over the specified amount.
- ② Do not charge the additional refrigerant.
If charging refrigerant additionally when refrigerant gas leaks, the refrigerant composition in the refrigerating cycle changes resulted in change of air conditioner characteristics or refrigerant over the specified standard amount is charged and an abnormal high pressure is applied to the inside of the refrigerating cycle resulted in cause of breakage or injury.

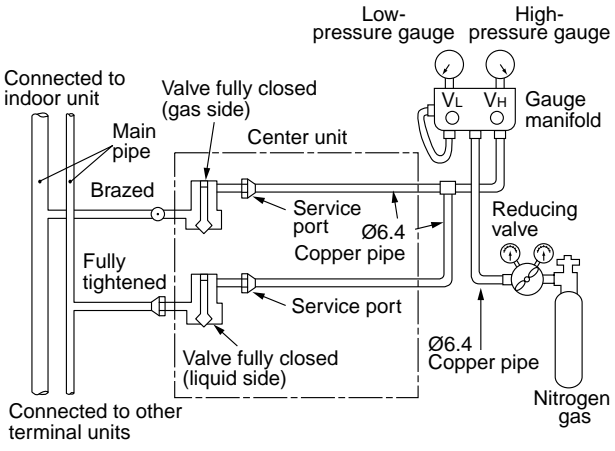

4mm-hexagonal wrench is required.

- ① Set the equipment so that liquid refrigerant can be charged.
- ② When using a cylinder with siphon pipe, liquid can be charged without inverting the cylinder.

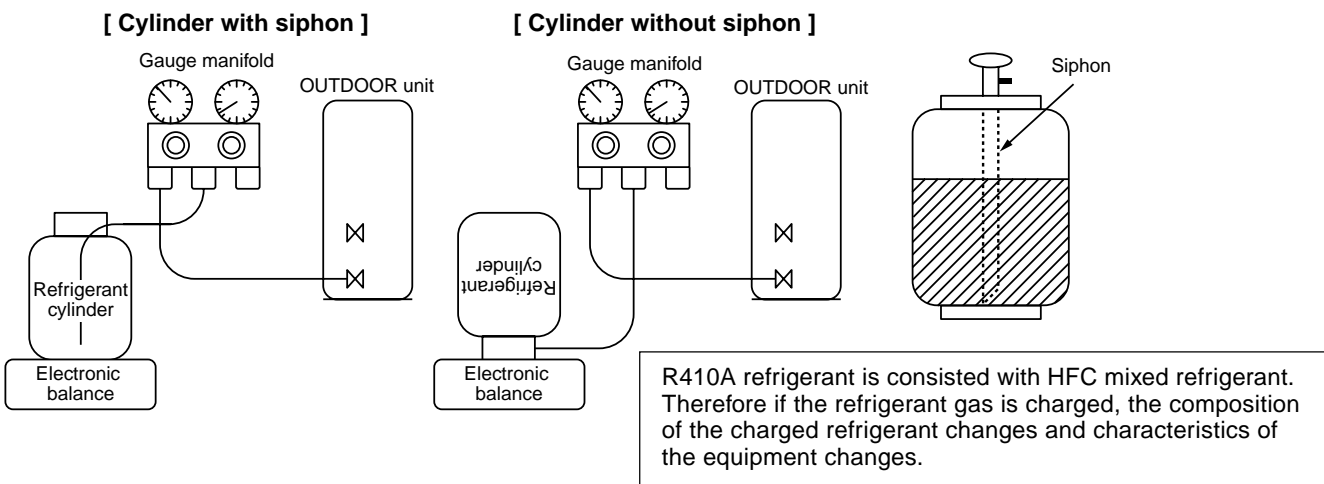

6. Environment

Use "Vacuum pump method" for an air purge (Discharge of air in the connecting pipe) in installation time.

- Do not discharge flon gas into the air to protect the earth environment.
- Using the vacuum pump method, clear the remained air (Nitrogen, etc.) in the unit. If the air remains, the pressure in the refrigerating cycle becomes abnormally high and an injury and others are caused due to burst.

1. CONSTRUCTION VIEWS (EXTERNAL VIEWS)

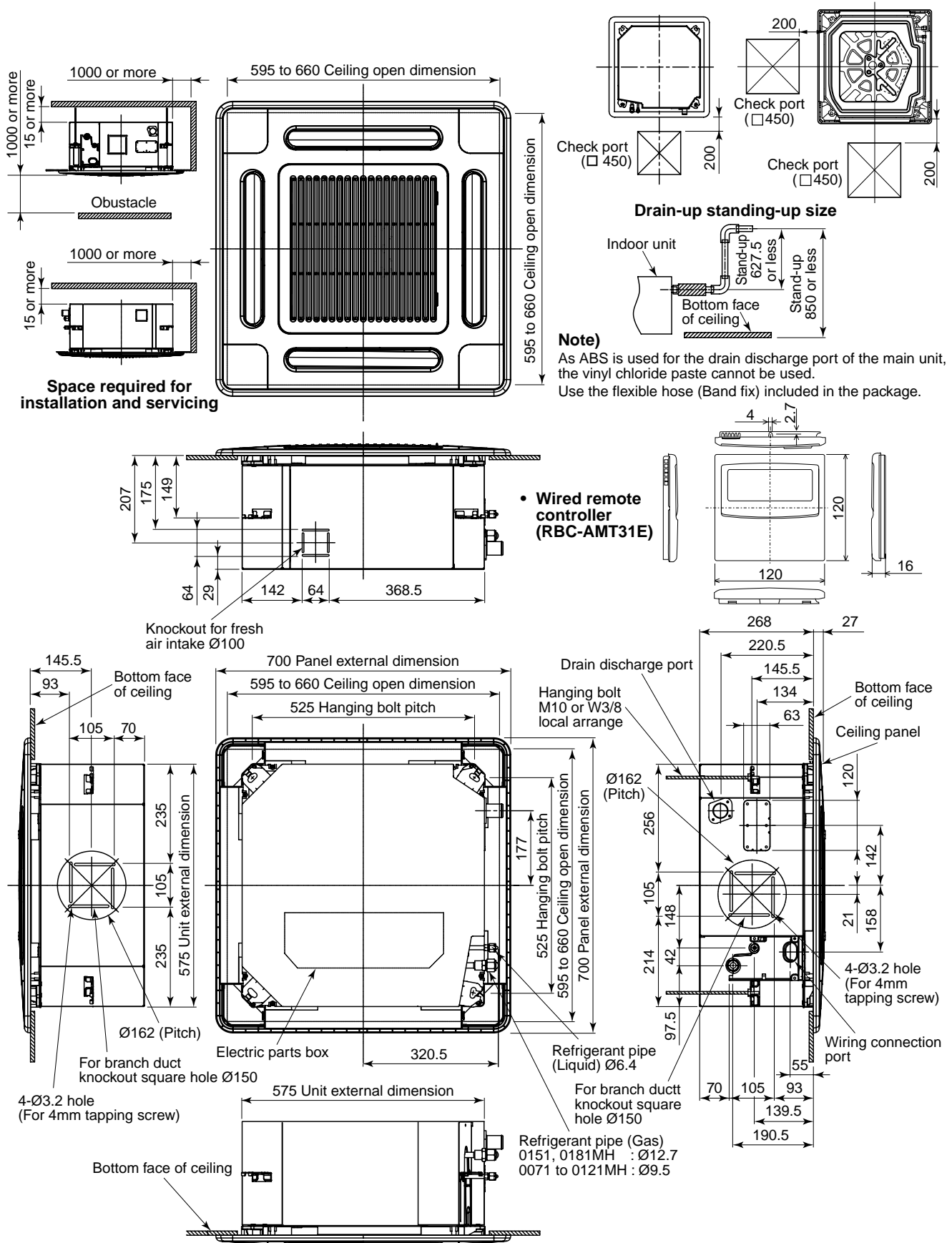

2. WIRING DIAGRAM

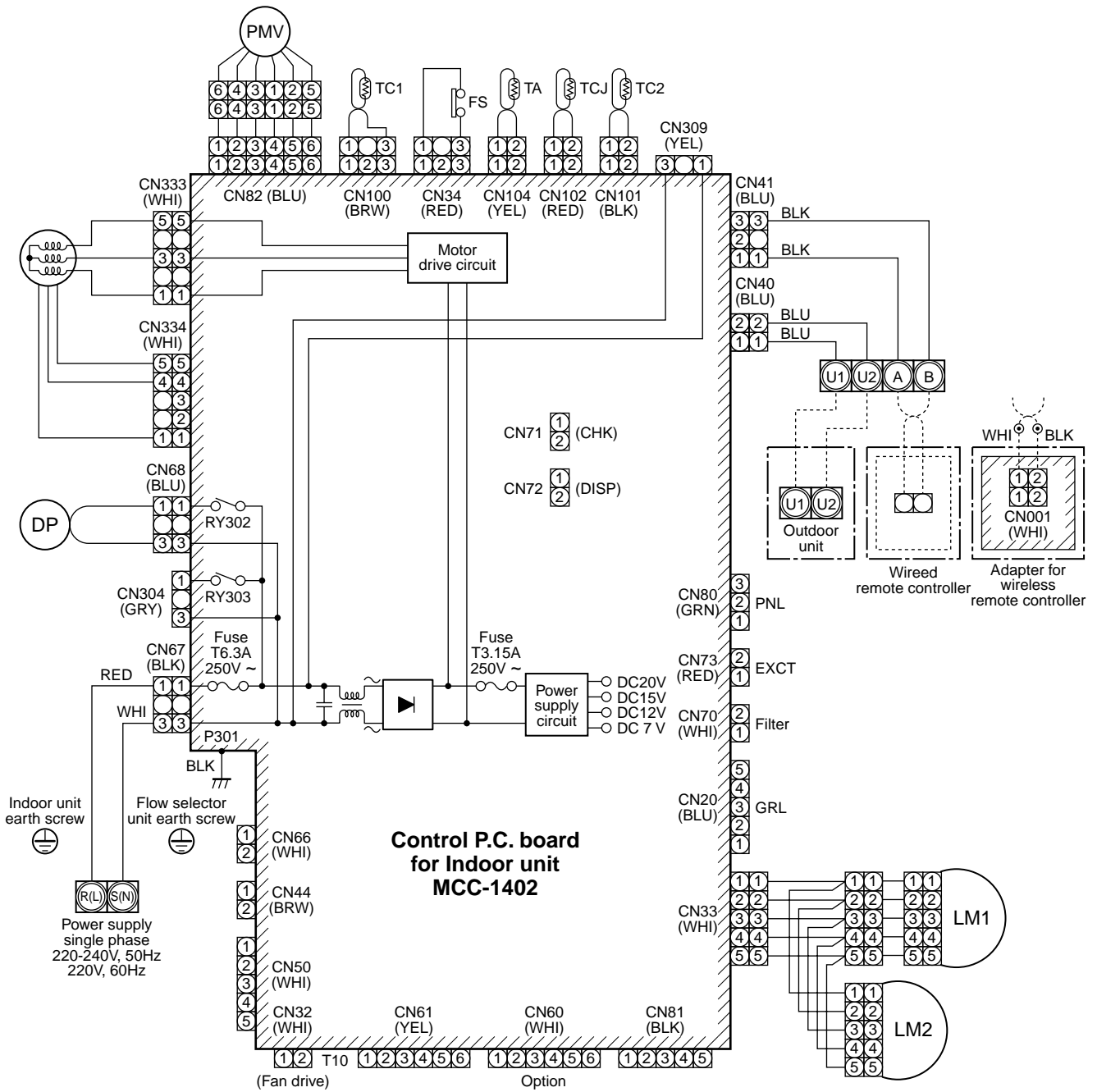

Symbol	Parts name
FM	Fan motor
TA	Indoor temp. sensor
TC1	Temp. sensor
TCJ	Temp. sensor
TC2	Temp. sensor
LM1, LM2	Louver motor
DP	Drain pump motor
FS	Float switch
RY302	Drain control relay
PMV	Pulse motor valve

Color indication
RED : RED
WHI : WHITE
YEL : YELLOW
BLU : BLUE
BLK : BLACK
GRY : GRAY
PNK : PINK
ORN : ORANGE
BRW : BROWN
GRN : GREEN

- ① indicates the terminal block letter.
Letter at inside indicates the terminal number.
- A dotted line and broken line indicate the wiring at site.
- ▨ indicates a control P.C. board.

3. PARTS RATING

3-1. Parts Rating

Model	MMU-	AP0071MH	AP0091MH	AP0121MH	AP0151MH	AP0181MH
Fan motor		SWF-230-60-1R				
Motor for horizontal grille		MP24Z3N				
Pulse motor		EDM-MD12TF-3				
Pulse motor valve		EDM-B25YGTF-3			EDM-B40YGTF-3	
TA sensor		Lead wire length : 155mm Vinyl tube				
TC1 sensor		Ø4 size lead wire length : 1400mm Vinyl tube				
TC2 sensor		Ø6 size lead wire length : 1500mm Vinyl tube (Black)				
TCJ sensor		Ø6 size lead wire length : 1400mm Vinyl tube (Red)				
Float switch		FS-0218-103				
Drain pump motor		ADP-1409				

3-2. Name of Each Part

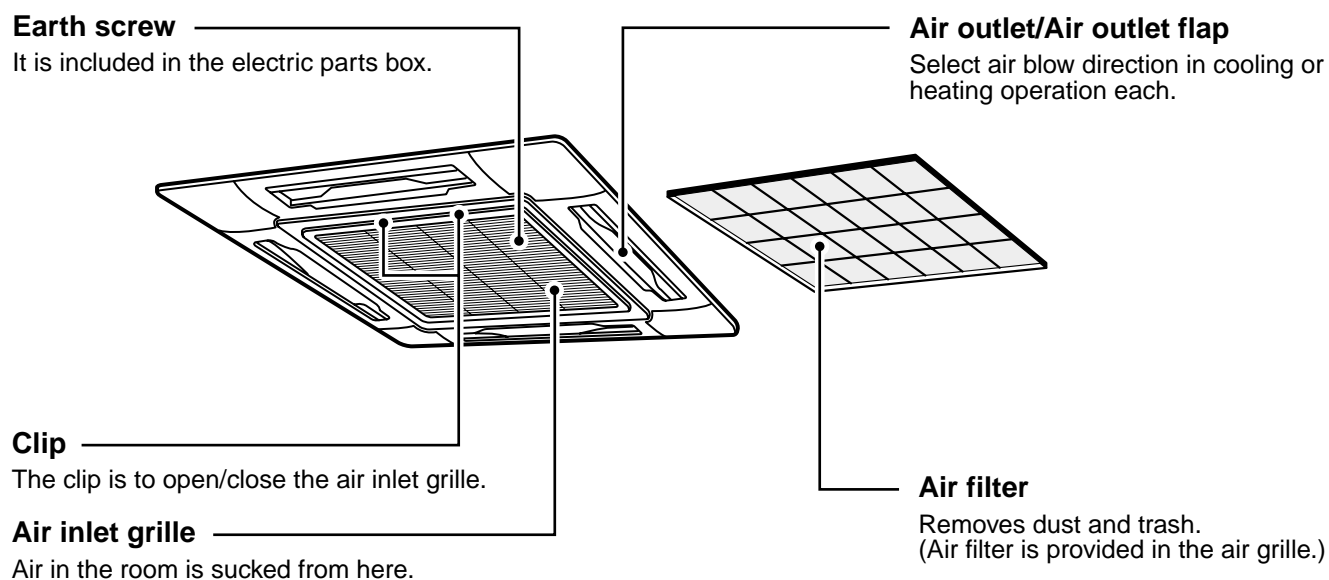

3-3. Parts Name of Remote Controller

Display section

In the display example, all indicators are displayed for the explanation. In reality only, the selected contents are indicated.

- When turning on the leak breaker at the first time, [SET DATA] flashes on the display part of the remote controller. While this display is flashing, the model is being automatically confirmed. Accordingly, wait for a while after [SET DATA] display has disappeared, and then use the remote controller.

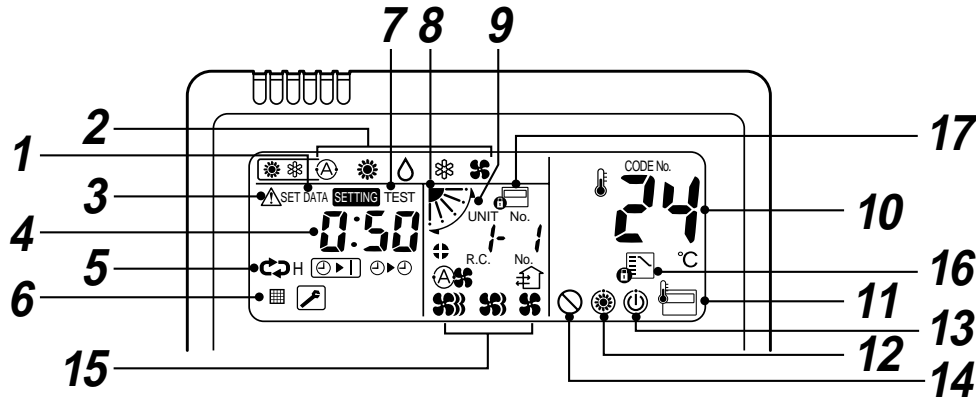
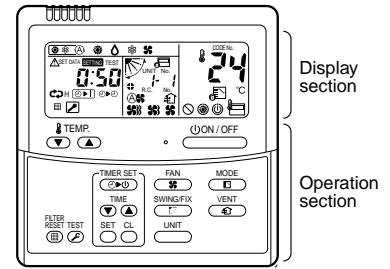

1 SET DATA display

Displayed during setup of the timer.

2 Operation mode select display

The selected operation mode is displayed.

3 CHECK display

Displayed while the protective device works or a trouble occurs.

4 Timer time display

Time of the timer is displayed. (When a trouble occurs, the check code is displayed.)

5 Timer SETIN setup display

When pushing the Timer SET button, the display of the timer is selected in order of [OFF] [ON] → [OFF] repeat OFF timer → [ON] → No display.

6 Filter display

If "FILTER" is displayed, clean the air filter.

7 TEST run display

Displayed during a test run.

8 Flap position display

Displays flap position.

9 SWING display

Displayed during up/down movement of the flap.

10 Set up temperature display

The selected set up temp. is displayed.

11 Remote controller sensor display

Displayed while the sensor of the remote controller is used.

12 PRE-HEAT display

Displayed when the heating operation starts.

While this indication is displayed, the indoor fan stops.

13 Operation ready display

Displayed when cooling or heating operation is impossible because the outdoor temperature goes out of the operable range.

14 No function display

Displayed if there is no function even if the button is pushed.

15 Air volume select display

The selected air volume mode is displayed.

(AUTO) (HIGH)
(MED.) (LOW)

16 Mode select control display

Displayed when pushing "Operation mode select" button while the operation mode is fixed to heating or cooling by the system manager of the air conditioner.

17 Central control display

Displayed when using the remote controller together with the central control remote controller, etc.

If Remote controller is prohibited at the centralcontrol side, flashes when operating

ON/OFF, MODE, DOWN / UP buttons and

the change is not accepted.

(The contents available to be set up on the remote controller differ according to the central control mode. For details, refer to Owner's Manual of the central control remote controller.)

Operation section

Push each button to select a desired operation.

This remote controller can operate the maximum 8 indoor units.

- The details of the operation needs to be set up once, afterward, the air conditioner can be used by pushing

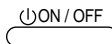
 button only.

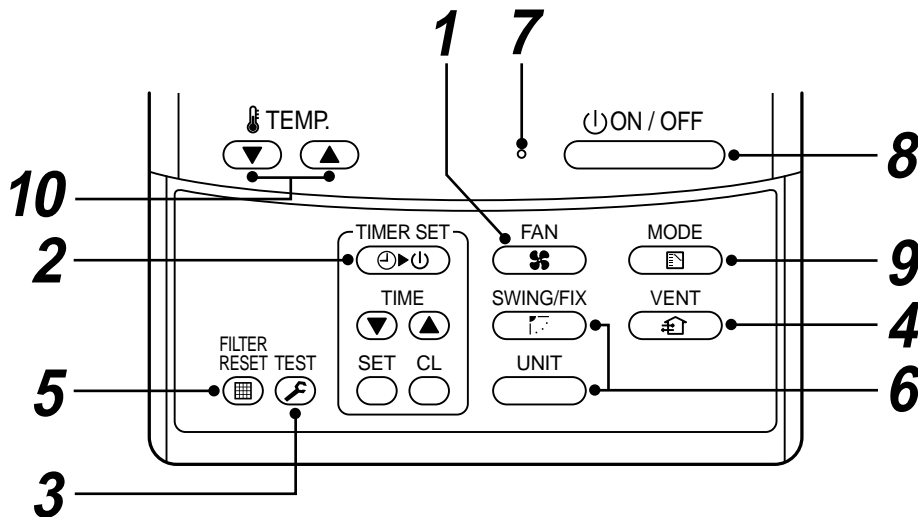

1 Air volume select button

Selects the desired air volume mode.

2 Timer set button

TIMER SET button is used when the timer is set up.

3 Check button

The CHECK button is used for the check operation. During normal operation, do not use this button.

4 Fan button

FAN button is used when a fan which is sold on the market or etc. is connected.

5 Filter reset button

Resets (Erases) "FILTER  " display.

6 Wind direction and Swing

 :

If the multiple indoor units are operated by only one remote controller, select the units when the air direction is adjusted.

 :

Set up the auto swing and angle of the flap.

7 Operation lamp

Lamp is lit during the operation. Lamp is off when stopped.

Although it flashes when operating the protection device or abnormal time.

8 button

When the button is pushed, the operation starts, and it stops by pushing the button again.



When the operation has stopped, the operation lamp and all the displays disappear.

9 Operation select button

Selects desired operation mode.

10 Set up temperature button

Adjusts the room temperature.

Set the desired set temperature by pushing  or  .

OPTION :

Remote controller sensor

Usually the TEMP. sensor of the indoor unit senses the temperature. The temperature on the surrounding of the remote controller can also be sensed. For details, contact the dealer from which you have purchased the air conditioner.

- In case that one remote controller controls the multiple indoor units, the setup operation is unavailable in group control.

3-4. Correct Usage

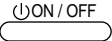
When you use the air conditioner for the first time or when you change the SET DATA value, follow the procedure below. From the next time, the operation displayed on the remote controller will start by pushing the  button only.

Preparation

Turn on the main power switch and/or the leakage breaker.

- When the power supply is turned on, a partition line is displayed on the display part of the remote controller.
- * After the power supply is turned on, the remote controller does not accept an operation for approx. 1 minute, but it is not a failure.

REQUIREMENT

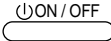
- While using the air conditioner, operate it only with  button without turning off the main power switch and the leak breaker.

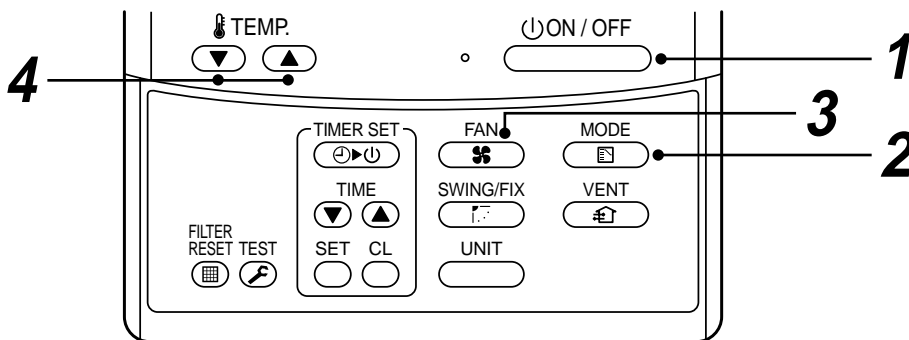



1 Push button.

The operation lamp goes on, and the operation starts.

2 Select an operation mode with the “MODE ” button.





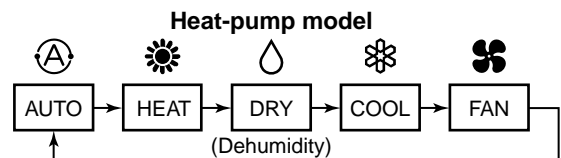
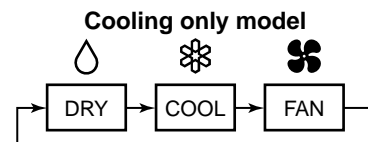

One push of the button, and the display changes in the order shown on the right.

- In HEAT  mode, if the room temperature reaches to the set temperature, the outdoor unit stops and the air flow becomes ULTRA LOW and the air volume decreases.
- In the heating mode, the fan stops so that cool air is not discharged and Heat  is displayed.



3 Select air volume with “FAN ” button.

One push of the button, and the display changes in the order shown on the right.

- When air volume is “AUTO ”, air volume differs according to the temperature difference between set temp. and room temp.
- In DRY  mode, “AUTO ” is displayed and the air volume is LOW.
- In heating operation, if the room temperature is not heated sufficiently with VOLUME “LOW ” operation, select “MED. ” or “HIGH ” operation.



4 Determine the set up temperature by pushing the “TEMP. ” or “TEMP. ” button.

Stop

Push  button.

The operation lamp goes off, and the operation stops.

3-5. Automatic Operation (Super Heat Recovery Type Only)

When you set the air conditioner in **A** mode or switch over from AUTO operation because of some settings change, it will automatically select either cooling, heating, or fan only operation depending on the indoor temperature.

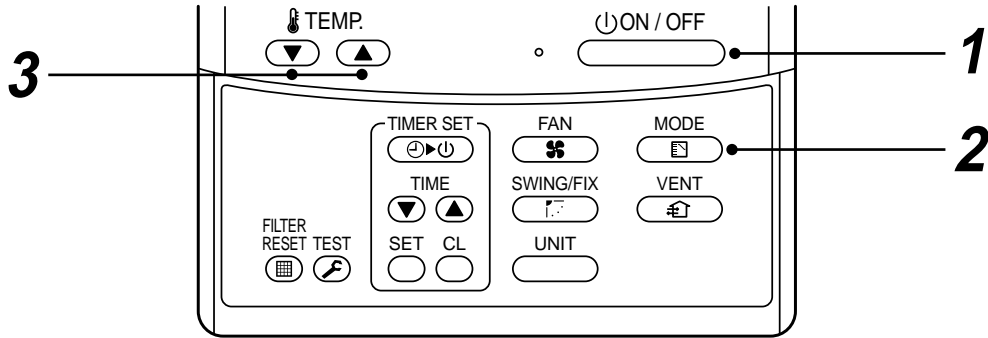

Start

1 **ON/OFF** button

Push this button to start the air conditioner.

2 **Mode select button (MODE)**

Select Auto.

3 **Temperature button**

Set the desired temperature.

- In case of cooling, start the operation after approx. 1 minute.
- In case of heating, the operation mode is selected in accordance with the room temperature and operation starts after approximately 3 to 5 minutes.
- When you select the Auto mode, it is unnecessary to set the fan speed. The FAN speed display will show AUTO and the fan speed will be automatically controlled.
- After the heating operation has stopped, FAN operation may continue for approx. 30 seconds.
- When the room temperature reaches the set temperature and the outdoor unit stops, the super low wind is discharged and the air volume decreases excessively. During defrost operation, the fan stops so that cool air is not discharged and "HEAT READY" is displayed.
- If the Auto mode is uncomfortable, you can select the desired conditions manually.

NOTE

When restarting the operation after stop

- When restarting the operation immediately after stop, the air conditioner does not operate for approx. 3 minutes to protect the machine.

Stop

Push **ON/OFF** button.

Push this button again to stop the air conditioner.

3-6. TIMER Operation

A type of timer operation can be selected from the following three types.

OFF timer : The operation stops when the time of timer has reached the set time.

Repeat OFF timer : Every time, the operation stops after the set time has passed.

ON timer : The operation starts when the time of timer has reached the set time.

Timer operation

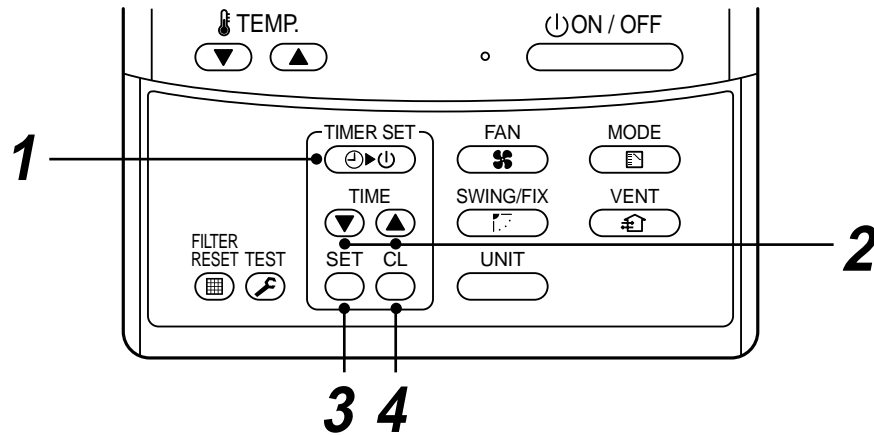

1 Push TIMER SET button.

- The timer display (type) changes for every push of the button.
- SET DATA and timer time displays flash.

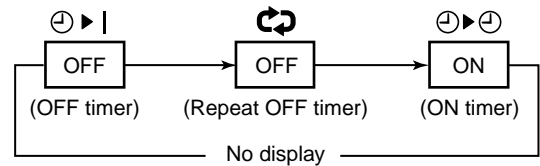

2 Push to select "SET TIME".

For every push of  button, the set time increases in the unit of 0.5 hr (30 minutes).

The maximum set time is 72.0 hr.

For every push of  button, the set time decreases in the unit of 0.5 hr (30 minutes).

The minimum set time is 0.5 hr.

3 Push SET button.

- **SETTING** display disappears and timer time display goes on.
(When ON timer is activated, timer time, ON timer  are displayed and other displays disappear.)

Cancel of timer operation

4 Push CL button.

- TIMER display disappears.

NOTICE

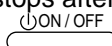
- When the operation stops after the timer reached the preset time, the Repeat OFF timer resumes the operation by pushing  button and stops the operation after the time of the timer has reached the set time.

3-7. Adjustment of Wind Direction

- While the air conditioner stops, the horizontal flap (Up/Down air direction adjustment plate) automatically directs upward.
- While the air conditioner is in ready status for heating, the horizontal flap (Up/Down air direction adjustment plate) directs upward. The swinging operation starts after heating ready status has been cleared, but “SWING ↷” is displayed on the remote controller even if the status is ready to heating.

How to set up the air direction

Push  button during operation.

1 Every pushing the button, the air direction changes.

In Heating operation

Set the horizontal flap (Up/Down air direction adjustment plate) downward. If directing it upward, the hot air may not come to the foot come to the foot.

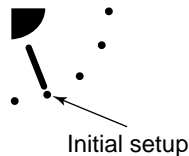

In Cooling / Dry operation

Set the horizontal flap (Up/Down air direction adjustment plate) upward. If directing it downward, the dew may fall on near the air air outlet port or it drips.

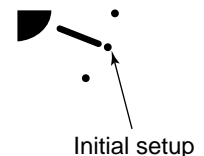

How to start swinging

2 Push  button.

Set direction of the horizontal flap (Up/Down air direction adjustment plate) to the lowest position and then push  button again.

- [SWING ↷] is displayed and the air direction automatically changes upward/downward.
- In case when one remote controller controls the multiple indoor units, each indoor unit can be selected and its air direction can be set up.

How to stop swinging



3 Push  button again during swinging of the horizontal flap.

- The horizontal flap can be stopped at the desired position. After then the air direction can be again set up from the uppermost position by pushing  button.

* While the horizontal flap is set downward in cooling/drying operation, it does not stop.

If stopping the horizontal flap which directs downward during swinging, it stops after moving to the 3rd position from the top position.

4 

- To set up the air direction individually, push  button to display each indoor unit No. in a group control. Then set up the air direction to a displayed indoor unit.
- If there is no display, all the indoor units can be operated collectively.
- Every pushing  button, the display exchanges as shown in the figure.

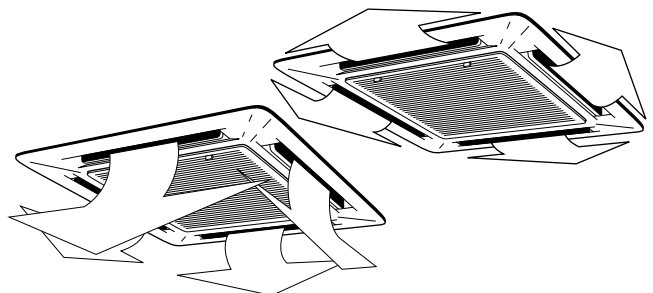
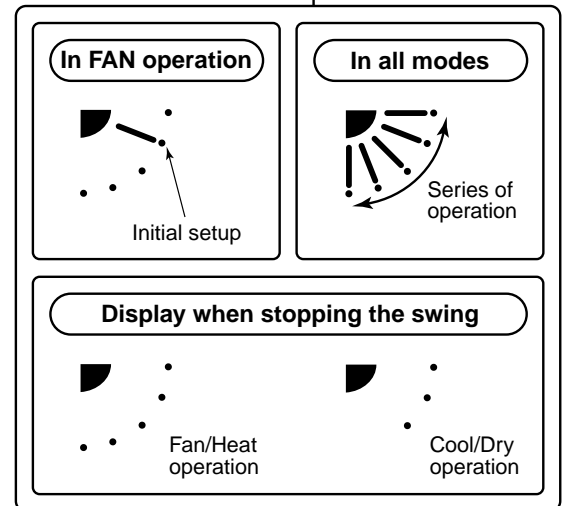
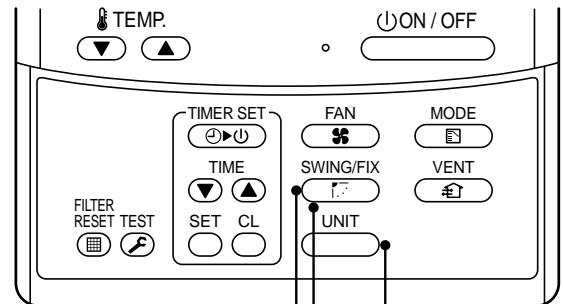
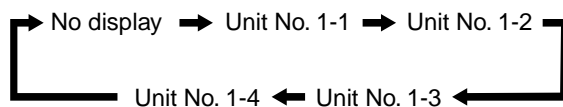

3-8. Information

Confirmation before operation

- Turn on the power switch 12 hours before starting the operation.
- Make sure whether earth wire is connected.
- Make sure the air filter is connected to the indoor unit.

Heating capacity

- A heat pump system which absorbs heat from outside of the room and then discharges heat into the room is adopted for heating. If the outside temperature falls, the heating capacity decreases.
- When the outside temperature is too low, it is recommended to use this air conditioner together with other heating equipment.

Defrost during heating operation

- In heating operation, if there is frost on the outdoor unit, the operation changes automatically to the defrost operation (Approx. 2 to 10 minutes) to increase the heating efficiency.
- During defrost operation, the fan of the indoor unit stops.

3-minutes protection

- When restarting the operation just after the operation has been stopped or the main power switch has turned on, the outdoor unit does not work for approx. 3 minutes in order to protect the air conditioner.

Power failure

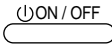
- If a power failure occurred during operation, all operations stop.
- When the power is returned after a power failure, the operation lamp notifies the power-ON by flashing operation lamp on the remote controller.
- When restarting the operation, push  button again.

Fan rotation in stopped unit

- In heating operation even in the stopped indoor unit, the fan rotates once for several minutes per approx. an hour when the other indoor unit is operating to protect the air conditioner.

Protective device (High pressure switch)

This device stops automatically an operation when excessive force is applied on the air conditioner.

If the protective device works, the operation stops and the operation lamp flashes.

When the protective device works, the indication  and the check code are displayed on the display section of the remote controller. In the following cases, the protective device may work.

In cooling operation



- The suction port or discharge port of the outdoor unit is closed.
- A strong wind continuously blows to the discharge port of the outdoor unit.

In heating operation

- Dust or waste adheres excessively to air filter of the indoor unit.
- The discharge port of the indoor unit is closed.

If the protective device works, turn off the main power switch, solve the cause, and then start the operation again.

Cooling/Heating operation of Super Modular Multi system air conditioner

- Although each indoor unit can be individually controlled in the Super Modular Multi system air conditioner, the cooling operation and the heating operation cannot be simultaneously performed in the multiple indoor units which are connected to an outdoor unit.
- If the cooling operation and the heating operation are simultaneously performed, the indoor unit which executes cooling operation stops, and  on the operation section lights up. On the other hand, the indoor unit which executes heating operation continues running. In a case that the manager of the air conditioner has fixed the operation to cooling or heating, an operation other than that set up is unavailable. If an operation other than that set up is executed,  on the operation section lights up and the operation stops.

Characteristics of heating operation

- The wind is not out just after starting an operation. The hot wind starts to blow 3 to 5 minutes after (Time differs according to indoor/outdoor temperature.) the indoor heat exchanger has warmed up.
- During operation, the outdoor unit may stop if the outside temperature rises.

3-9. Air Conditioner Operations and Performance

3 minutes protection function

3-minutes protection function prevents the air conditioner from starting for initial 3 minutes after the main power switch/circuit breaker is turned on for re-starting the air conditioner.

Power failure

Power failure during operation will stop the unit completely.

- To restart the operation, push the START/STOP button on the remote controller.
- Lightning or a wireless car telephone operating nearby may cause the unit to malfunction. Turn off the main power switch or circuit breaker and then turn them on again. Push the START/STOP button on the remote controller to restart.

Heating characteristics

Preheating operation

The air conditioner will not deliver warm air immediately after it is turned on. Warm air will start to flow out after approximately 5 minutes when the indoor heat exchanger warmed up.

Warm air control (In heating operation)

When the room temperature reaches the set temperature, the fan speed is automatically reduced to prevent to blow cold draft. At this time, the outdoor unit will stop.

Defrosting operation

If the outdoor unit is frosted during the heating operation, defrosting starts automatically (for approximately 2 to 10 minutes) to maintain the heating capacity.

- The fans in both indoor and outdoor units will stop during the defrosting operation.
- During the defrosting operation, the defrosted water will be drained from the bottom plate of the outdoor unit.

Heating capacity

In the heating operation, the heat is absorbed from the outside and brought into the room. This way of heating is called heat pump system. When the outside temperature is too low, it is recommended to use another heating apparatus in combination with the air conditioner.

Attention to snowfall and freeze on the outdoor unit

- In snowy areas, the air inlet and air outlet of the outdoor unit are often covered with snow or frozen up. If snow or freeze on the outdoor unit is left as it is, it may cause machine failure or poor warming.
- In cold areas, pay attention to the drain hose so that it perfectly drains water without water remaining inside for freeze prevention. If water freezes in the drain hose or inside the outdoor unit, it may cause machine failure or poor warming.

Air conditioner operating conditions







For proper performance, operate the air conditioner under the following temperature conditions:

Cooling operation	Outdoor temperature : -5°C to 43°C
	Room temperature : 21°C to 32°C (Dry valve temp.), 15°C to 24°C (Wet valve temp.)
	CAUTION Room relative humidity – less than 80 %. If the air conditioner operates in excess of this figure, the surface of the air conditioner may cause dewing.
Dry operation	Outdoor temperature : 15°C to 43°C (Maximum suction air temp. 46°C)
	Room temperature : 17°C to 32°C
Heating operation	Outdoor temperature : -15°C to 15°C (Wet valve temp.)
	Room temperature : 15°C to 28°C (Dry valve temp.)

If air conditioner is used outside of the above conditions, safety protection may work.

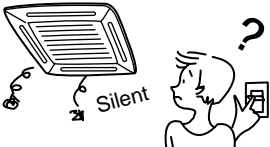
3-10. When the Following Symptoms are Found

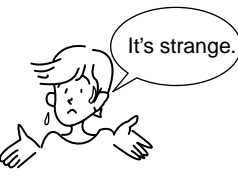
Check the points described below before asking repair servicing.









Symptom		Cause
Check again.	Outdoor unit <ul style="list-style-type: none"> • White misty cold air or water is out. • Sometimes, noise "Pushu !" is heard. 	<ul style="list-style-type: none"> • Fan of the outdoor unit stops automatically and performs defrost operation. • Solenoid valve works when defrost operation starts or finishes.
	Indoor unit <ul style="list-style-type: none"> • "Swish" sound is heard sometimes. • Slight "Pishi!" sound is heard. • Discharge air smells. • The operation lamp flashes • "STANDBY  " indication is lit.  <ul style="list-style-type: none"> • Sound or cool air is output from the stand by indoor unit. • When power of the air conditioner is turned on, "Ticktock" sound is heard. 	<ul style="list-style-type: none"> • When the operation has started, during the operation, or immediately after the operation has stopped, a sound such as water flows may be heard, and the operation sound may become larger for 2 or 3 minutes immediately after the operation has started. They are flowing sound of refrigerant or draining sound of dehumidifier. • This is sound generated when heat exchanger, etc. expand and contract slightly due to change of temperature. • Various smell such as one of wall, carpet, clothes, cigarette, or cosmetics adhere to the air conditioner. • Flashes when power is turned on again after power failure, or when power switch is turned on. • When cooling operation cannot be performed because another indoor unit performs heating operation. • When the manager of the air conditioner has fixed the operation to COOL or HEAT, and an operation contrary to the setup operation is performed. • When fan operation stopped to prevent discharge of hot air. • Since refrigerant is flowed temporarily to prevent stay of oil or refrigerant in the stand by indoor unit, sound of flowing refrigerant, "Kyururu" or "Shaa" may be heard or white steam when other indoor unit operates in HEAT mode, and cold air in COOL mode may be blow-out. • Sound is generated when the expansion valve operates when power has been turned on.
It is not a failure.	Operates or stops automatically.	<ul style="list-style-type: none"> • Is the timer "ON" or "OFF"?
	Does not operate. 	<ul style="list-style-type: none"> • Is it a power failure? • Is the power switch turned off? • Is the power fuse or breaker blown? • Has the protective device operated? (The operation lamp goes on.) • Is the timer "ON"? (The operation lamp goes on.) • Are COOL and HEAT selected simultaneously? ("STANDBY  " indication is lit on the display column of the remote controller.)
	Air is not cooled or warmed sufficiently. 	<ul style="list-style-type: none"> • Is the suction port or discharge port of the outdoor unit obstructed? • Are any door or window open? • Is the air filter clogged with dust? • Is discharge flap of the indoor unit set at appropriate position? • Is air selection set to "LOW" "MED.", and is the operation mode set to "FAN"? • Is the setup temp. the appropriate temperature? • Are COOL and HEAT selected simultaneously? ("STANDBY  " indication is lit on the display column of the remote controller.)

When the following symptoms are found, stop the operation immediately, turn off the power switch, and contact the dealer which you have purchased the air conditioner.

- Activation of switch is unstable.
- Fuse or breaker is blown periodically.
- Foreign matters or water entered by mistake.
- When if activation cause of the protective device has been removed, the operation is not performed.
- Other unusual status occurred.

Accessory parts and Parts to be procured locally

□ Accessory parts

Part name	Q'ty	Shape	Usage
Installation Manual	1	This manual	(Ensure hand over to customer)
Heat insulating pipe	2		For heat insulation of the pipe connecting section
Installation pattern	1		For checking of ceiling opening and the main unit position
Installation gauge	2		For positioning of the ceiling position (To be used with the installation pattern)
Pattern fixing screw	4	M5 x 16L	For attach the installation pattern
Heat insulator	1		For heat insulation of drain connecting section
Washer	8		For hanging unit
Hose band	1		For connecting drain pipe
Flexible hose	1		For adjusting core-out of drain pipe
Heat insulator A	1		For sealing of wire connecting port
Heat insulator B	1		For sealing of wire connecting port

Refrigerant piping

- Piping material used for the conventional refrigerant cannot be used.
- Use copper pipe only with a wall thickness of 0.8 mm or more for Ø6.4, Ø9.5, Ø12.7.
- Flare nut and flare operations are also different from those of the conventional refrigerant. Use the flare nut fitted to the indoor unit of the air conditioner.

1 PRECAUTIONS FOR SAFETY

- Ensure that all Local, National and International regulations are satisfied.
- Important safety information are described in this installation manual. Please ensure this manual is read thoroughly and kept for future reference.
- After the installation work, perform a trial operation to check for any problem. Follow the Owner's Manual to explain how to use and maintain the unit to the customer.
- Turn off the main power supply switch (or breaker) before any unit maintenance.
- Ask the customer to keep the Installation Manual together with the Owner's Manual.

CAUTION

New Refrigerant Air Conditioner Installation

- **THIS AIR CONDITIONER FEATURES A NEW HFC REFRIGERANT (R410A) WHICH DOES NOT DEplete OZONE LAYER.**

The pressure of R410A is 1.6 times higher than that of former refrigerant R22. The refrigerating oil has also been changed. Therefore be sure that any former refrigerant, refrigerant oil or any other contaminants do not enter the refrigerating cycle of the air conditioner, during either installation or service work. If incorrect tools or operating procedures are used, there is a possibility of a serious accident. Use only tools and materials that have been designed to operate with R410A.

To prevent the risk of charging with an incorrect refrigerant, the dimensions of the charging port connections are different to those used for conventional refrigerant. Therefore only tools designed to operate with R410A can be used.

For connecting pipes, use piping specifically designed for R410A.

During installation, ensure pipes are clean and ensure contaminants do not enter in the pipes as the system is affected by impurities such as water, oxide scales, dirt, oil, etc. Do not use existing pipe work from previous installation as this will cause problems due to pressure resistances and impurities within the pipe.

CAUTION

To Disconnect the Appliance from Main Power Supply.

This appliance must be connected to the main power supply by means of a switch with a contact separation of at least 3 mm.

⚠ WARNING

- **Ask an authorized dealer or qualified installation professional to install/maintain the air conditioner.**
Inappropriate installation may result in water leakage, electric shock or fire.
- **Turn off the main power supply switch or breaker before attempting any electrical work.**
Make sure all power switches are off. Failure to do so may cause an electric shock.
- **Connect all of the installation wiring correctly.**
If the installation wiring is incorrect electrical parts may be damaged.
- **During the transportation and installation of the air conditioning unit, ensure that gaseous matter other than the specified refrigerant does not enter into the refrigeration cycle.**
If a refrigerant becomes contaminated with foreign gases, the gas pressure within the refrigerant cycle will become abnormally high and may result in the fracture of pipe work and possible human injury.
- **Do not modify this unit by removing any of the safety guards or by overriding any of the safety interlock switches.**
- **Exposure of the unit to water or other forms of moisture before installation may cause a short-circuit of the electrical parts.**
Do not store it in a wet basement or expose to rain or water.
- **After unpacking the unit, examine for possible damage.**
- **Do not install in a place that might increase the vibration of the unit.**
- **To avoid personal injury (with sharp edges), be careful when handling parts.**
- **Perform installation work properly according to the Installation Manual.**
Inappropriate installation may result in water leakage, electric shock or fire.
- **When the air conditioner is installed in a small room, provide appropriate measures to ensure that in the event of a refrigerant leak the rooms does not exceed the critical level.**

1 PRECAUTIONS FOR SAFETY

- **Install the air conditioner securely in a location where the base can sustain the weight of the unit adequately.**
- **Perform the specified installation work to guard against an earthquake.**
If the air conditioner is not installed appropriately, accidents may occur due to the unit falling.
- **If refrigerant gas has leaked during the installation work, ventilate the room immediately.**
If the leaked refrigerant gas comes in contact with fire, noxious gases may be generated.
- **After the installation work, confirm that refrigerant gas does not leak.**
If refrigerant gas leaks into the room and flows near a fire source, such as a cooking range, noxious gases may be generated.
- **Electrical work must be performed by a qualified electrician in accordance with the Installation Manual. Ensure the power supply to the air conditioner is exclusive to that unit only.**
An insufficient power supply capacity or inappropriate installation may cause fire.
- **Use only the specified wiring during the unit installation. Ensure that all terminals are securely fixed, so preventing any external forces having a negative effect on the terminals.**
- **Conform to the regulations of the local electric authority when wiring the power supply.**
Inappropriate grounding may cause an electric shock.
- **Do not install the air conditioner in a location that may be subjected to a risk of exposure to a combustible gas.**
If a combustible gas leaks and becomes concentrated around the unit, a fire may occur.

2 SELECTION OF INSTALLATION PLACE

⚠ WARNING

- **The air conditioner must be installed in a location that can support the weight of the unit effectively.**
If the unit is not installed on a foundation that can support its weight effectively, the unit may fall down, resulting in possible human injury.
- **Where required ensure that the units installation is sufficient enough to withstand against an earthquake.**
An insufficient installation could result in the unit falling, causing possible human injury.
- **Install the air conditioner at a minimum height of 2.5 m from the floor.**
Do not insert your hands or others into the unit while the air conditioner is operating.

⚠ CAUTION

Upon approval from the customer, install the air conditioner in a place that satisfies the following conditions.

- A place where the unit can be installed horizontally.
 - A place where a sufficient servicing space can be maintained for safety maintenance and unit check.
 - A place where the drain water can be exited from the unit, without causing a problem.
- Avoid installing in the following places.**
- Places exposed to air with a high salt content (seaside area), or places exposed to large quantities of sulfide gas (hot spring). (Should the unit be used in these places, special protective measures are needed.)
 - Places exposed to oil, vapor, oil smoke or corrosive gas.
 - Places where organic solvent is used nearby.
 - Places close to a machine generating high frequency.
 - Places where the discharged air blows directly into the window of the neighbouring house. (For outdoor unit)
 - Places where the noise from the outdoor unit can be easily transmitted to the neighboring property. (When installing the air conditioner on the boundary with a neighbor, pay due attention to the level of noise.)
 - Places with poor ventilation.

Installation space

Ensure there is sufficient space to install the unit and to perform maintenance work as and when required. Keep 15mm or more for clearance between top plate of the indoor unit and the ceiling surface.

Installation space

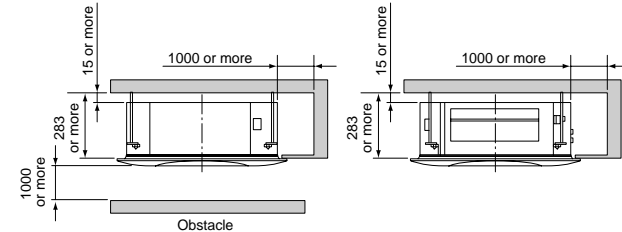

Ceiling height

Model MMU-AP	Installable ceiling height
0071 to 0121 type	Up to 2.7 m
0151 to 0181 type	Up to 3.5 m

When the ceiling height exceeds the standard distance of a 4-way air discharge cassette as detailed in the following table. The air-flow may not be sufficient to heat the room. It is therefore necessary to set the unit to high ceiling mode or adjust the direction of the ceiling discharge.

For setup of the high ceiling mode, refer to the details of Applicable controls "To incorporate a filter sold separately" and "In case of installation to high ceiling" within this Manual.

Installable ceiling height list

Indoor unit capacity type	0071 to 0121 type			0151 type			0181 type			Setup of high ceiling
	4-way	3-way	2-way	4-way	3-way	2-way	4-way	3-way	2-way	Setup data
Standard (At shipment)	2.7	—	—	2.9	—	—	3.2	—	—	0000
High ceiling (2)	—	—	—	3.2	—	—	3.4	—	—	0002
High ceiling (3)	—	—	—	3.5	—	—	3.5	—	—	0003

(Unit: m)

REQUIREMENT

- When high ceiling (1) or (3) is used with 4-way blowing, a draft is easily recognized due to drop of discharge temperature.

The air filter cleaning signal duration (Notification of filter cleaning) on the remote controller can be changed according to the condition of installation.

If the room is not heated due to the installation place or construction of the room, the detection temperature of heating can be raised.

For setup method, refer to "Change of lighting term of filter sign" and "Increased heating effect" in the Applicable controls of this Manual.

2 SELECTION OF INSTALLATION PLACE

In case of wireless type

The wireless remote controller can be operated up to a maximum of 8 m from the infra-red receiver.

Therefore ensure that the remote controller will be mounted and used within this stated parameter.

- To prevent malfunction do not mount or operate in a location that is subjected to either a fluorescent lamp or direct sunlight.
- A maximum of 6 indoor units with wireless remote controller can be installed within the same room.

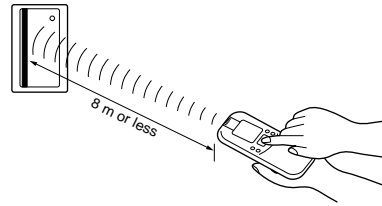

3 INSTALLATION OF INDOOR UNIT

WARNING

The installation of the air conditioning unit must be positioned in a location that can sufficiently support its weight and give protection against adverse environmental conditions.

Failure to do so may result in unit damage and possible human injury.

Any incomplete installation may also cause possible risk of human injury.

- Unpack the package, take out the product and then place it on the floor so that the same surface directs underneath as it is placed in the package.
- Never put the products taken out from the packing box in a pile, or put other load on them; otherwise there is a possibility to damage electric parts, fan parts, draining mechanism, and etc.

If the both sides are turned over, a deformation of mounting metal of the ceiling panel which is sold separately, etc may be caused. Accordingly the product may be damaged and the installation becomes impossible in some cases.

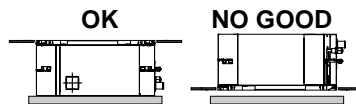

REQUIREMENT

Strictly comply to the following rules to prevent damage of the indoor units and human injury.

- Do not place heavy objects on the indoor unit. (Even when units are still packaged)
- Always carry the unit as packaged from the factory wherever possible.
- If carrying in the indoor unit unpacked by necessity, be sure to use buffering cloth, etc. to prevent damaging the unit.
- To move the indoor unit, hold the hanging brackets (4 positions) only. Do not apply force to other parts (refrigerant pipe, drain pan, foamed parts, or resin parts etc.).
- To be carried by two or more persons. Do not strap the unit in positions other than that stated.

Dimensional view

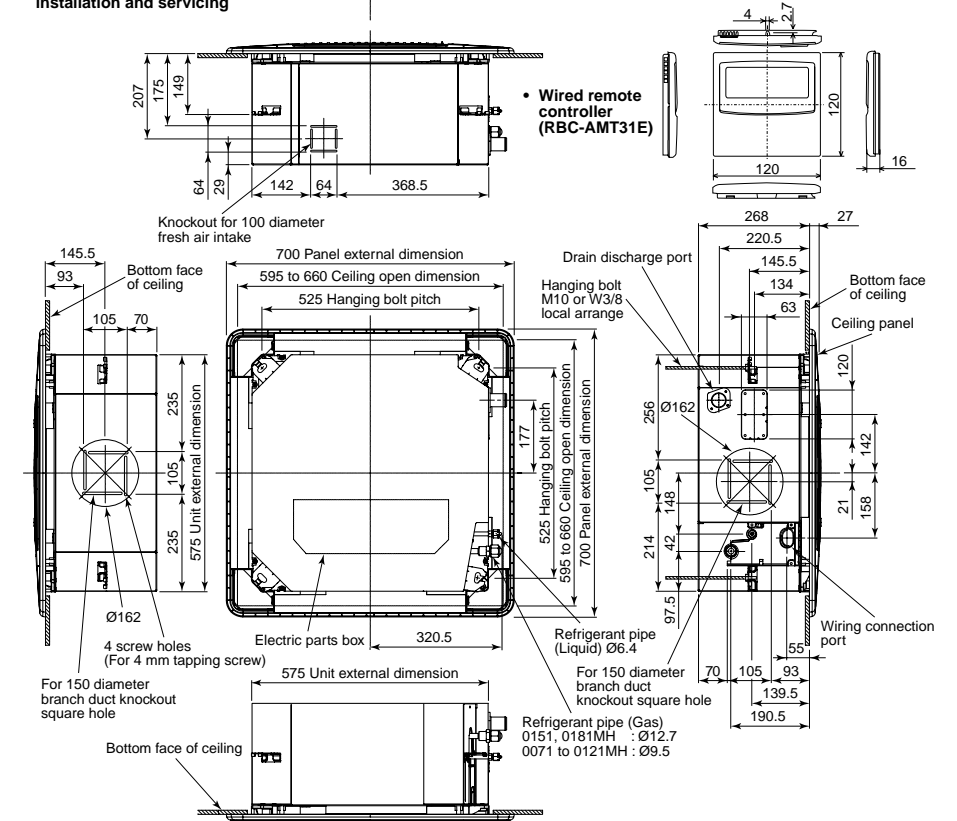
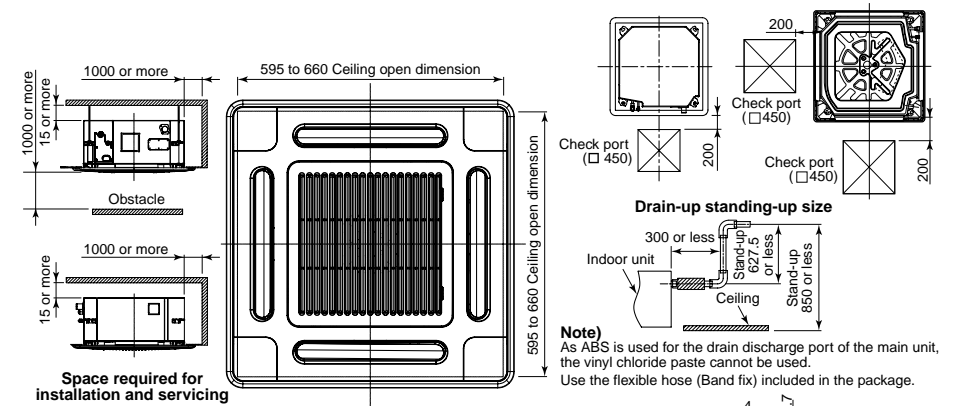

3 INSTALLATION OF INDOOR UNIT

Ceiling opening and installation of hanging bolts

- Evaluate and determine the piping and wiring requirements inside the ceiling prior to the hanging of the unit.
- After installation place of the indoor unit has been determined, create opening in ceiling and install the hanging bolts.
- For the ceiling opening size and pitch for hanging bolts refer to the dimensional drawing and the supplied installation pattern.
- Once the ceiling void has been created, ensure that the drain pipe, refrigerant pipes, inter-connecting wires and all control wires are in place prior to installing the actual indoor unit.

Please procure the hanging bolts and nuts for installation of the indoor unit at local site.

Hanging bolt	M10 or W3/8	4 pieces
Nut	M10 or W3/8	12 pieces

How to use the supplied installation pattern

The installation pattern is enclosed within the packaging of the air conditioner.

Existing ceiling void

Use the pattern to determine the position and size of the opening and location of the hanging bolts.

New ceiling void

Use the pattern to determine the position of the new ceiling opening. Cut off slit section of the main unit of the installation pattern. Cut off the outside of the pattern according to size of the ceiling opening. (There is a slit on the standard opening size section.)

- Install the indoor unit after installation of the hanging bolts.
- Using the supplied pattern attach it to the indoor unit using the supplied fixing screws (M5 × 16L 4off). (Screw pattern to the ceiling panel hanging brackets of the indoor unit)
- When creating the opening ensure it is as per the outer dimensions of the supplied pattern.

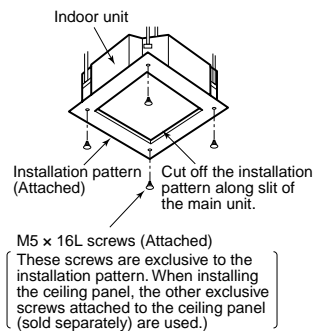

Treatment of ceiling

The ceiling differs according to the structure of the building. For details, consult your architect.

In the process after the ceiling panels have been removed, it is important to reinforce the ceiling construction and ensure the ceiling remains in a horizontal position. This is to prevent possible vibration of the ceiling panels.

- Cut and remove the ceiling material.
- Reinforce the cut surface of the ceiling construction and add support for fixing the end of ceiling panel.

Installation of hanging bolt

Use M10 hanging bolts (4 off, locally procured).

When mounting the unit, set the pitch of the hanging bolts according to the size of the unit as detailed on the dimensional drawing.

New concrete slab	Steel frame structure	Existing concrete slab
Install the bolts with insert brackets or anchor bolts. (Blade type bracket) (Slide type bracket) (Pipe hanging anchor bolt)	Use existing angles or install new support angles. Hanging bolt Support angle	Use a hole-in anchors, hole-in plugs, or a hole-in bolts.

Installation of indoor unit

- Attach the nut (M10 or W3/8: Procured locally) and washer (Ø34 mm) to the hanging bolt.
 - Put washers at either side of the T-groove on the hanging bracket of the indoor unit in order to hang the unit.
 - Using a spirit level, check that all four sides are horizontal. (Horizontal positioned within 5 mm)
 - Cut off the installation gauge from the installation pattern.
 - Using the installation gauge check and adjust clearance between the indoor unit and the ceiling opening (1) (10 to 42 mm on each side). Ensure that the unit is level to the ceiling and within a distance of (2) 23 mm to 28 mm below.
- The installation gauge has details of how to use printed on it.

Note) Install the indoor unit so that the end part of opening does not come into contact with the drain socket piping.

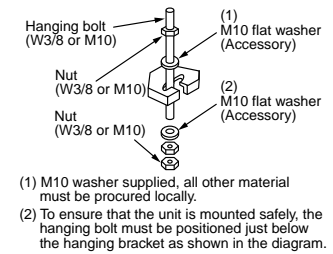
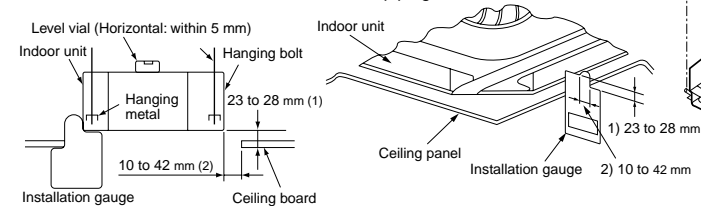

REQUIREMENT

Before installation of the indoor unit be sure to remove the transportation cushion found between the fan and the bell mouth. Running the unit without removing the cushion may damage the fan motor.

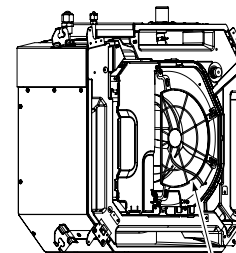

Be sure to remove the cushion for transportation between the fan and the bell mouth.

Installation of ceiling panel (Sold separately)

Install the ceiling panel after completion of the installation of the indoor unit, including all piping and wiring.

Install the ceiling panel as per the supplied Installation Manual.

Check the installation dimensions of the indoor unit and the ceiling opening are correct and then install.

REQUIREMENT

Ensure the ceiling panel is mated to the ceiling surface or the indoor unit.

If the panel and unit are not mated together this may result in the formation of dew condensation causing a possible water leak.

First remove the 4 corner caps from the ceiling panel and fit to the indoor unit.

Installation of remote controller (Sold separately)

For installation of the wired remote controller, follow the Installation Manual supplied with the remote controller.

- Do not expose remote controller to direct sunlight or excessive heat.
- When using a wireless type remote controller check receiver on the indoor unit receives a signal.
- For a wireless type controller ensure that it is used and mounted a minimum distance of 1m apart from any other electrical devices (TV, Stereo, etc). As this may cause interference with the devices.

4 DRAIN PIPING WORK

CAUTION

- Install the drain piping so that the water drains effectively.
- Apply heat insulation to prevent dew condensation from forming.
- Incorrectly installed pipe work may result in a water leak.

Pipe material/Insulator and size

The following materials for piping work and insulation are to be procured locally.

Pipe material	Hard vinyl chloride pipe socket for VP25 Hard vinyl chloride pipe VP25 (Outer diameter Ø32 mm)
Insulator	Foamed polyethylene foam, thickness: 10 mm or more

REQUIREMENT

- Ensure insulating of the drain pipes and connecting parts on the indoor units.
- The drain pipe should have a downward slope of at least 1/100 and ensure there are no swells or blockages as this will cause abnormal sounds.
- The maximum traverse length of drain pipe is 20 m. Provide support brackets at intervals of 1.5 to 2 m where necessary to prevent movement.
- Install the combined piping as shown in the illustration.
- Do not create an air purge in the pipework, as the water would leak from this point.

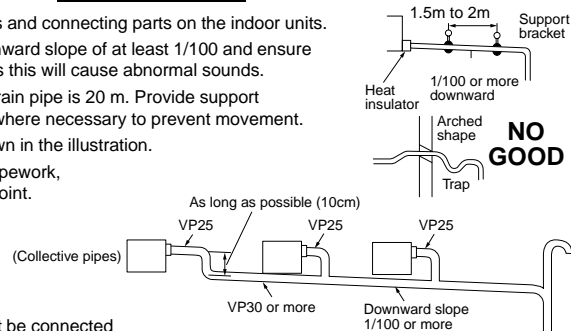

- The hard vinyl-chloride pipe cannot be connected directly to the drain pipe connecting port of the indoor unit. For connection with the drain pipe connecting port, ensure that the supplied flexible hose is fitted.
- Adhesive agent cannot be used for the pipe connecting port (hard socket) on the indoor unit. Be sure to use the supplied hose band for fixing, otherwise there is a risk of damage or water leakage from the drain pipe connecting port.

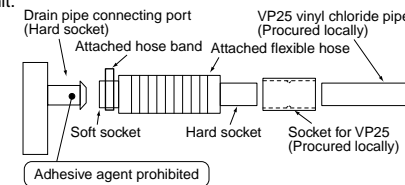

Connection of flexible hose

- Insert the soft socket of the supplied flexible hose into the connecting port of the drain pipe.
- Align the supplied hose band to the pipe connecting port end, and tighten.

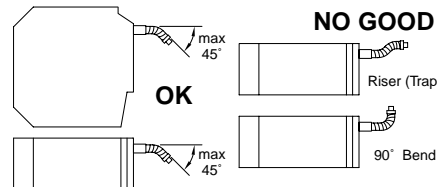

REQUIREMENT

- Fix the soft socket with the supplied hose band, tighten at the upper position of the unit.
- The supplied flexible hose can bend up to a maximum of 45°

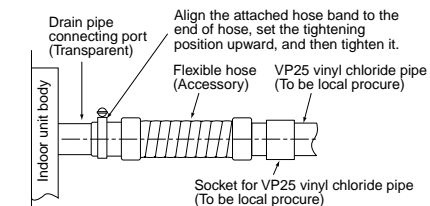

Connection of drain pipe

- Connect the hard socket (Procured locally) to the hard socket side of the supplied flexible hose which has been installed.
- Connect the drain pipes (Procured locally) in turn to the connected hard sockets.

REQUIREMENT

- Using an adhesive agent for vinyl chloride, connect the hard vinyl chloride pipes so that water does not leak.
- Allow sufficient time for the adhesive to set and harden. (Refer to the instructions of the adhesive.)

Drain up

When it is not possible to achieve a natural downward slope on the drain pipe, you can create a vertical lift (Drain up) on the pipe.

- Set the height of the drain pipe within 850 mm from the bottom surface of the ceiling.
- The drain pipe should be piped from the drain pipe connecting port horizontally for a maximum of 300 mm and then piped vertically.
- After piping the vertical lift, ensure the pipe work is set to a downward gradient.

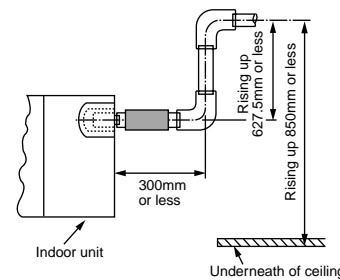

Check the draining

After completion of drain piping, check water drains away and that no water leaks from any of the connecting parts. At the same time check for any abnormal sounds from the drain pump. Ensure drainage is checked during cooling mode.

When the electric work has finished:

- Before installing the ceiling panel, pour water as shown in the following figure, check water drains from the drain pipe connecting port (Transparent) in COOL mode and then check there are no water leaks from the drain pipes.

When the electric work has not finished:

- Pull out the float switch connector (3P: Red) from P.C. board connector (CN34: Red) of the electric parts box. (Ensure the power is turned off.)
- Connect the single-phase 220-240V, 1N, 50Hz (or 220V, 1N, 60Hz) power to the terminal blocks R (L) and S (N). (Never apply 220-240V to (A), (B), (U1) and (U2).)
- Pour water referring to the next page figure. (Amount: 1500 cc to 2000 cc)
- When the power is turned on, the drain pump motor drives automatically. Check water is drained from the drain pipe connecting port (Transparent), and then check there is no water leak from the drain pipes.
- After checking for water leaks on the drain, turn off the power supply, and re-attach the float switch connector to the original position (CN34) on the P.C. board and refit the electric parts box.

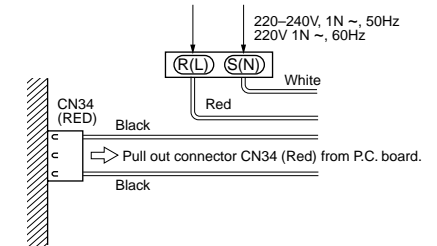

4 DRAIN PIPING WORK

Thermal insulating process

- After checking of the draining, using the supplied thermal insulation fit to the flexible hose leaving no clearance at the connecting part of the indoor unit.
- Fit locally procured thermal insulation to the drain pipe leaving no clearance between the supplied insulation.

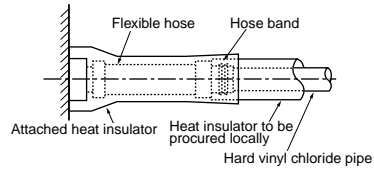

CAUTION

Ensure water is poured slowly.

To reduce risk of water spreading throughout the unit, resulting in a possible fault.

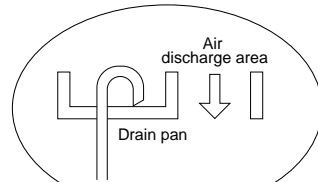

Check panel

Insert the leading part of the hose between the heat exchanger and the drain pan, and then bend it downward.

Polyethylene hand pump for pouring water in drain pan

Vessel Water (1500cc to 2000cc)

5 REFRIGERANT PIPING

WARNING

- If refrigerant gas leaks during the installation work, ventilate the room immediately.
 - If the leaked refrigerant comes in contact with fire, noxious gas may generate.
- After the installation work, confirm that refrigerant does not leak.
 - If refrigerant gas leaks into the room and flows near to a source of fire, noxious gas may be generated.

REQUIREMENT

When using long length of refrigerant piping. Provide support brackets at intervals of 2.5 m to 3 m. If the pipes are not fixed abnormal sounds may be generated. Ensure the supplied R410A flare nuts are used.

Permissible pipe length and permissible height difference

This differs depending on the outdoor units. For details, refer to the Installation Manual supplied with the outdoor unit.

Piping material and dimensions

Piping material		Phosphor deoxidization seamless pipe for air conditioner	
Indoor unit capacity type	MMU-	AP0071 to AP0121 type	AP0151 to AP0181 type
Pipe size (mm)	Gas side	Ø9.5	Ø12.7
	Liquid side	Ø6.4	Ø6.4

- Use new and clean pipe, ensuring that the pipes are not contaminated with dust, oil, moisture, etc.

Pipe flaring

Flaring

1. Cut the pipe with a pipe cutter.

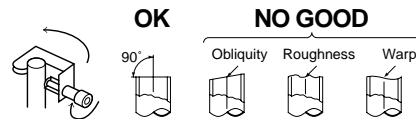

2. Place flare nut onto the pipe, and flare the pipe. (Use the flare nut fitted to the unit or one that is R410A compatible)

As the flaring sizes of R410A differ from that used on R22. It is recommended to use a dedicated R410A flaring tool. However a conventional flare tool can be used, by adjustment of the projection of the copper pipe.

- Flaring diam. meter size : A (Unit : mm)



Outer diam. of copper pipe	A $+0.4$ -0.4
	R410A
6.4	9.1
9.5	13.2
12.7	16.6
15.9	19.7

* In case of flaring for R410A with the conventional flare tool, make a margin of 0.5 mm longer than that of R22 pipe so that the flare size matches with the specified size.

The copper pipe gauge is useful for adjusting the projection margin size.

5 REFRIGERANT PIPING

- Projection margin in flaring :
B (Unit : mm)

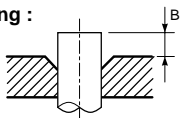

Rigid (Clutch type)

Outer diam. of copper pipe	R410A tool used		Conventional tool used	
	R410A	R22	R410A	R22
6.4	0 to 0.5	(Same as left)	1.0 to 1.5	0.5 to 1.0
9.5	0 to 0.5	(Same as left)	1.0 to 1.5	0.5 to 1.0
12.7	0 to 0.5	(Same as left)	1.0 to 1.5	0.5 to 1.0
15.9	0 to 0.5	(Same as left)	1.0 to 1.5	0.5 to 1.0

Imperial (Wing nut type)

Outer diam. of copper pipe	R410A	R22
6.4	1.5 to 2.0	1.0 to 1.5
9.5	1.5 to 2.0	1.0 to 1.5
12.7	2.0 to 2.5	1.5 to 2.0
15.9	2.0 to 2.5	1.5 to 2.0

Connection of refrigerant pipe

Connect all the refrigerant pipes with the flare connection method

- As the unit is sealed to atmospheric pressure. It is not abnormal that no "Push..." sound will be heard upon the removal of the flare nut.
- Ensure use of two spanners for the connecting of the pipe work to the indoor unit.

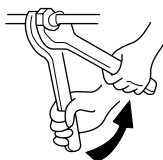

Work using double spanner

- Refer to the following table for tightening torque.

Connecting pipe outer dia. (mm)	Tightening torque (N•m)	Re-tightening torque (N•m)
Ø6.4	14 to 18 (1.4 to 1.8 kgf•m)	18 (1.8 kgf•m)
Ø9.5	33 to 42 (3.3 to 4.2 kgf•m)	42 (4.2 kgf•m)
Ø12.7	50 to 62 (5.0 to 6.2 kgf•m)	50 (5.0 kgf•m)
Ø15.9	68 to 82 (6.8 to 8.2 kgf•m)	68 (6.8 kgf•m)

Airtight test/Air purge, etc.

For carrying out airtight test, air purge, gas leak check and addition of refrigerant refer to the Installation Manual supplied with the outdoor unit.

Open fully valves of the outdoor unit

Gas leak check

Using a leak detector or soapy water, check for gas leaks at the connecting pipe work and the caps on the service valves.

REQUIREMENT

Use a leak detector designed specifically for HFC refrigerant (R410A, R134a, etc.).

Heat insulating process

Fit heat insulation to the gas and liquid pipes separately.

During cooling mode, the temperature of the liquid and the gas pipes are reduced. Therefore ensure sufficient insulation is fitted to prevent dew condensation.

- On the gas side ensure that the heat insulation used is heat resistant to a minimum temperature of 120°C
- Using the supplied heat insulation. Insulate the interconnecting parts of the indoor unit, ensuring that there is no exposure of any refrigerant pipe work. As detailed in the illustration below.

REQUIREMENT

Apply the thermal insulation to the pipe connecting section of the indoor unit securely up to the root without exposure of the pipe. (The pipe exposed to the outside causes water leak.)

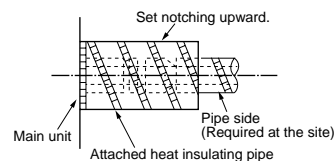

6 ELECTRIC WORK

WARNING

- Using the specified wires, ensure the wires are connected and securely fixed so that no external force can transmit to the connecting part of the terminals.
Poor connection may cause risk of fire, etc.
- Ensure connection of earth wire. (Grounding work)
Do not connect the earth wire to a gas pipe, mains water pipe, lightning rod, or the earth wire of a telephone. Incorrect earthing will cause risk of an electric shock.
- For electrical installation work, strictly follow the Local and national Regulations of each country and the Installation Manual. A designated power supply must be used.
Capacity shortage of the power supply or incomplete installation may cause an electric shock or a fire.

CAUTION

Ensure an earth leakage breaker is installed.

Failure to install, may result in an electric shock.

REQUIREMENT

- For power supply wiring, strictly conform to the Local authorities in each country.
- For wiring of the power supply of the outdoor units, follow to the outdoor unit Installation Manual.
- Never connect 220–240V control wiring to the terminal blocks (U1, U2, A, B) fault will be. (Caused.)
- Arrange the electrical wiring so that they do not come into contact with high-temperature parts of the pipe work; this is to prevent the risk of insulation melting and causing a possible accident.
- After connecting wires to the terminal block. Secure wiring with cable clamp.
- Store wiring install control wiring and refrigerant piping within the same line.
- Do not turn on power of the indoor unit until vacuuming of the refrigerant pipe has finished.

6 ELECTRIC WORK

Power supply specifications

Power supply wiring and communication wiring are to be procured locally.

For the power supply specification, follow the table below. Ensure power supply is adequate. An insufficient power supply could result in unit failure.

For specification of the power capacity of the outdoor unit and the power supply wires, refer to the Installation Manual supplied with the outdoor unit.

Indoor unit power supply (*1)	Power supply	220–240V, 1N ~ 50Hz 220V, 1N ~ 60Hz	
	Power supply switch/Earth leakage breaker or power supply wiring/fuse rating for indoor units should be selected by the accommodated total current values of the indoor units.		
	Power supply wiring	20 m or less	Twist wire : 2.5 mm ²
Communication line	Indoor/Outdoor inter-unit wiring (*2)	50 m or less	Twist wire : 3.5 mm ²
		Q'ty	2
	Central control line wiring (*3)	Wire size	(Up to 1000 m) Twist wire : 1.25 mm ² (Up to 2000 m) Twist wire : 2.0 mm ²
		Q'ty	2
	Remote controller wiring (*4)	Wire size	(Up to 1000 m) Twist wire : 1.25 mm ² (Up to 2000 m) Twist wire : 2.0 mm ²
		Q'ty	2
		Wire size	Twist wire : 0.5 to 2.0 mm ²

Indoor unit power supply (*1)

- Indoor unit power supply, must have a dedicated supply and be separate to that of the outdoor unit.
- Arrange the power supplies to the indoor and outdoor units, so that a common earth leakage breaker and main switch can be used.
- Power supply cable specification : Cable 3-core 2.5 mm², in conformity with Design 60245 IEC 57.

Indoor/Outdoor inter-unit wiring, Central controller wiring (*2) (*3)

- Use a 2 core non polarity cable.
- To prevent any possible noise issues, use a shielded 2 core wire.
- The total stated length of communication wiring is determined by the interconnecting length of indoor to outdoor cable plus the length of the central control communication cable.

Remote controller wiring (*4)

- For wiring remote controllers, a 2 core polarity cable must be used.

Remote controller wiring, remote controller inter-unit wiring	Twist wire: 0.5mm ² to 2.0 mm ² × 2
---	---

Total wire length of remote controller wiring and remote controller inter-unit wiring = L + L1 + L2 + ... Ln	In case of wired type only	Up to 500 m
	In case of wireless type included	Up to 400 m
Total wire length of remote controller inter-unit wiring = L1 + L2 + ... Ln		Up to 200 m

CAUTION

The remote controller wire (Communication line) and AC220–240V (Power supply) wires cannot be parallel to contact each other and cannot be stored in the same conduits. If doing so, a trouble may be caused on the control system due to noise, etc.

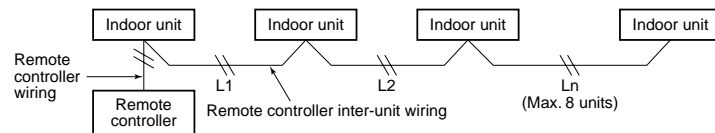

Cable connection

REQUIREMENT

- Be sure to locate the cable through the cable connection port of the indoor unit.
- Ensure additional wire length of approximately 100 mm at the indoor unit electric parts box. This is to enable ease of any service work in the future.
- The low-voltage circuit is provided for the remote controller.

- Remove the cover of the electric parts box by removing the mounting screws (3 pcs.) and push the hooking section. (The cover of the electric parts box remains hanged to the hinge.)
- Tighten the screws on the terminal block and secure the cables with cord clamp fitted to the electric parts box. (Do not apply tension to the connecting section of the terminal block.)
- Using the supplied thermal insulation for the sealing of the cable connecting port, seal the cable connecting port. (Otherwise dew condensation may be caused.)
- Mount the cover of the electric parts box ensuring the cables are not pinched. (Mount the cover after the ceiling panel has been wired to the electric box.)

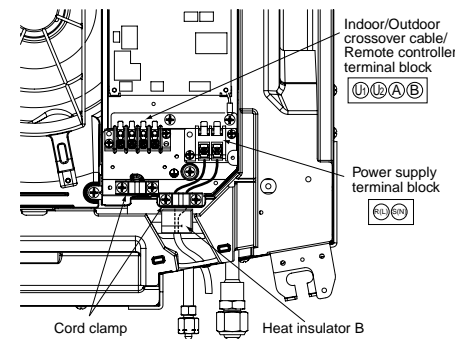
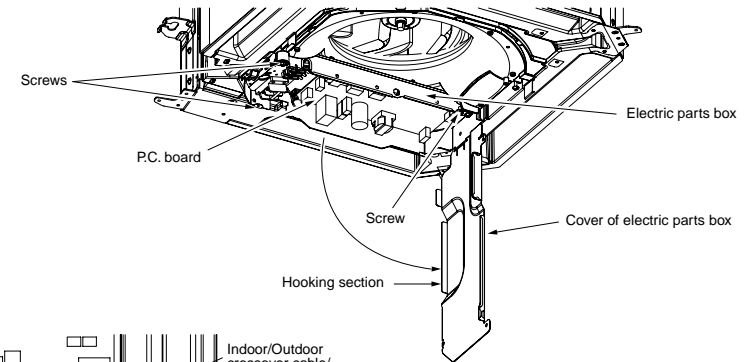

Thermal insulation to cabling connecting port

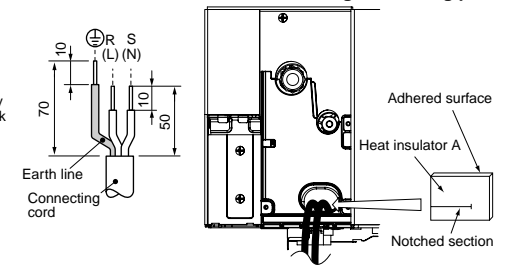

6 ELECTRIC WORK

Remote controller wiring

- Strip approximately 14 mm of insulation off of the connecting wires.
- As the remote controller wire has no polarity, there is no problem if connections to indoor unit terminal blocks A and B are reversed.

Wiring diagram

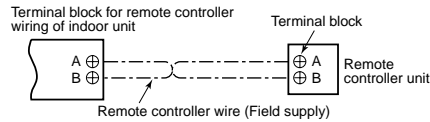

Wiring between indoor and outdoor units

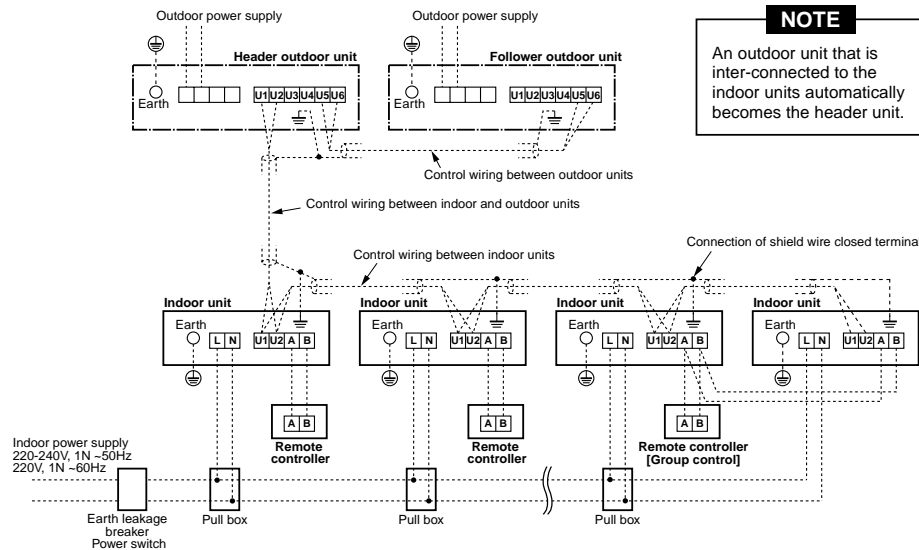

Address setup

Set up the addresses as per the Installation Manual supplied with the outdoor unit.

Wiring on the ceiling panel

As per the Installation Manual of the ceiling panel, connect the connector (2P: Red) of the ceiling panel to the connector (5P: White) onto the P.C. board within the electric parts box.

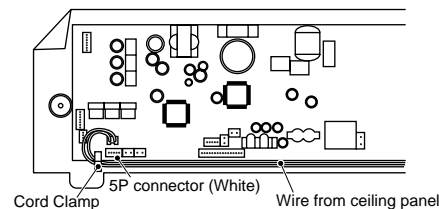

7 APPLICABLE CONTROLS

NOTIFICATION

When using the equipment for the first time, the remote controller will not accept any commands for a short period of time.

Automatic address

- While automatic addressing no operations can be performed on the remote controller.
- Automatic addressing will take a maximum duration of 10 minutes (generally 5 minutes).

Upon turning on the unit after completion of automatic addressing, a maximum period of 10 minutes (generally 3 minutes) are required prior to the start up operation of the outdoor unit.

All indoor units are shipped from factory as standard. Change if necessary.

To change the setup use the main remote controller (wired remote controller).

* The setup change for wireless remote controller, sub remote controller or a unit without a controller (Centrally controlled.) is not possible. In such cases, temporarily install a separate main remote controller.

Applicable control setup

Basic operation procedure for setup change

Change the setup while operation of the equipment is stopped. (Be sure to stop the operation of a set.)

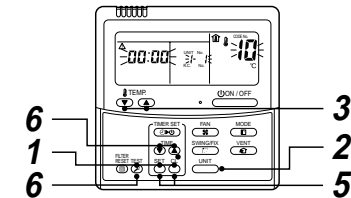

Procedure	Description
1	<p>Push the SET, CL and TEST buttons simultaneously for 4 seconds or more, after a while, the display part flashes as shown in the figure.</p> <p>Check that the displayed item code is [10].</p> <ul style="list-style-type: none"> If the item code indicates any characters other than [10], push the TEST button to erase the display and retry the operation from the first step. (For some time after the TEST button has been pushed, the operation of the remote controller cannot be accepted.) <p>(In a group control, the firstly displayed indoor unit No. becomes the center unit.)</p> <p>(* The display changes according to the indoor unit model.)</p>
2	<p>Each time the UNIT button is pushed, the indoor unit No. in the group control is displayed consecutively.</p> <p>Select the indoor unit that requires a change to the setup.</p> <p>During this time the indoor unit that is selected can be confirmed as the louver and fan will be operated.</p>
3	<p>Using the TEMP and CL buttons, select the item code [**].</p>
4	<p>Using the TIME and CL buttons, select set data [****].</p>
5	<p>Push the SET button. During this time, if the display changes from flashing to permanently on, the setup is complete.</p> <ul style="list-style-type: none"> To change the setup of an indoor unit that is not selected, restart operation from Procedure 2. To change to a different setup within the selected indoor unit, restart operation from Procedure 3. <p>Pushing the CL button clears the set up contents which has been set. In this case, restart from Procedure 2.</p>
6	<p>When the setup is finished, push the TEST button. (The setup is configured.)</p> <p>Pushing the TEST button deletes the display and returns the status to the normal stopped status.</p> <p>(For a period of time after the TEST button has been pushed, the remote controller will not accept any commands.)</p>

7 APPLICABLE CONTROLS

In case of installation to high ceiling

When the unit is to be installed at a height that exceeds the standard value, adjustment to the air volume is necessary.

- For the "Setup data" in Procedure 2, select from the "Installable ceiling height list".

Installable ceiling height list

Indoor unit capacity type	0071 to 0121 type			0151 type			0181 type			Setup of high ceiling
	4-way	3-way	2-way	4-way	3-way	2-way	4-way	3-way	2-way	Setup data
Standard (At shipment)	2.7	—	—	2.9	—	—	3.2	—	—	0000
High ceiling (2)	—	—	—	3.2	—	—	3.4	—	—	0002
High ceiling (3)	—	—	—	3.5	—	—	3.5	—	—	0003

(Unit: m)



In case of remote controller-less (Group control)

To set the unit to high ceiling operation, there is a method that requires the changing of the short plugs on the indoor P.C. board. The details are shown in the below table.

This method is only to be used where a standard wired remote controller (Group control) is not used.

* Upon changing the high ceiling setting

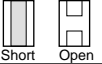
- Select setting by the changing of the short plugs on the indoor P.C. board.

Short plug position	Set data	Filter sold separately
		
	0000	Standard filter (At shipment)
	0003	High ceiling (3)

- Short plug position (CN112, CN111, CN110 from the left)

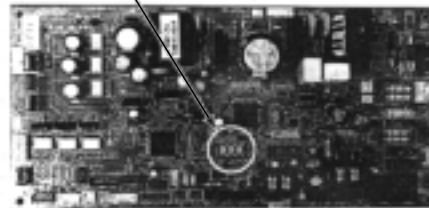

Change of lighting time of filter sign

Depending on the conditions of the installation, the time period of the filter clean sign can be changed.

Follow to the basic operation procedure

(1 → 2 → 3 → 4 → 5 → 6).

- For the item code in Procedure 3, specify [01].
- For the [Set data] in Procedure 4, select the setup data of filter sign lighting time from the following table.

Setup data	Filter sign lighting time
0000	None
0001	150H
0002	2500H (At shipment from factory)
0003	5000H
0004	10000H

Group control

In a group control, a remote controller can control up to a maximum of 8 units.

- For cabling procedure and cables of the individual line (Identical refrigerant line) system, refer to "Electric work" in this Manual.
- Wiring between indoor units in a group is performed in the following method.

Connect the indoor units by connecting the remote controller inter-unit cables from the remote controller terminal blocks (A, B) of the indoor unit connected with a remote controller to the remote controller terminal blocks (A, B) of the other indoor unit. (No polarity)

- For address setup, refer to the Installation Manual supplied with the outdoor unit.

Increased heating effect

If it is not possible to achieve satisfactory heating due to the installation environment or the structure of the room. The detected temperature can be increased. Also use a circulator, etc to circulate hot air near the ceiling.

Follow to the basic operation procedure

(1 → 2 → 3 → 4 → 5 → 6).

- For the item code in Procedure 3, specify [06].
- For the set data in Procedure 4, select the setup data of the required temperature shift value from the table below.

Setup data	Detection temp shift value
0000	No shift
0001	+1°C
0002	+2°C (At shipment from factory)
0003	+3°C
0004	+4°C
0005	+5°C
0006	+6°C

8 TEST RUN

Before test operation

- Before turning on the power supply, carry out the following procedures.
 - Using 500V-megger, check there is 1MΩ or more between the terminal block of the power supply and the earth. If 1MΩ or less is detected, do not run the unit.
 - Check that all the valves of the outdoor unit are fully opened.
- Never push the electromagnetic contactor to carry out a forced test operation. (It is very dangerous because a protective device does not work.)

WARNING

To protect the compressor at startup. Ensure the power supply is left on for 12 or more hours before operation.

How to execute test operation

- To carry out a fan operation in a single indoor unit, firstly turn off the power supply to the unit. Then short CN72 found on the P.C. board. Once completed turn the power to the unit back on and start the unit in FAN only mode. Upon completion of the test do not forget to remove the short circuit on CN72.
- Using the remote controller, check the unit is in normal operation. For the operation procedure, refer to the supplied Owner's Manual. A forced test operation can be executed in the following procedure under the condition of thermo.-OFF of room temperature. In order to prevent the test operation from running continuously, the operation will cease after a period of 60 minutes. The unit will then return back to its original operation.

NOTE

Do not use a forced operation in cases other than test operation because it applies an excessive load onto the air conditioner.

In case of wired remote controller

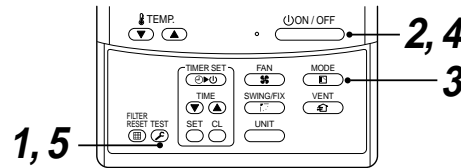

Procedure	Description
1	Keep the TEST button pushed down for 4 seconds or more. [TEST] is displayed on the display part and the selection of the test mode is permitted.
2	Push ON/OFF button.
3	Using MODE button, select the operation mode, [COOL] or [HEAT]. <ul style="list-style-type: none"> Do not run the air conditioner in a mode other than [COOL] or [HEAT]. The temperature controlling function will not work during the test operation. Fault detection will perform as usual.
4	After the test operation, push the ON/OFF button to stop the operation. (Display part is the same as procedure 1)
5	Push the TEST button to cancel (release from) the test operation mode. ([TEST] disappears on the display part and the status returns to normal.)

In case of wireless remote controller

Procedure	Description
1	Remove a small screw which fixes the nameplate of the receiver unit. Remove the nameplate of the sensor section by inserting a minus screwdriver, etc into the notch at the bottom of the plate, and set the Dip switch to [TEST RUN ON].
2	Execute a test operation with TEST button on the wireless remote controller. <ul style="list-style-type: none"> LED flash during test operation. Under status of [TEST RUN ON], the temperature adjustment from the wireless remote controller is invalid. Do not use this method in the operation other than test operation because the equipment is damaged.
3	Use either COOL or HEAT operation mode for a test operation. <ul style="list-style-type: none"> The outdoor unit does not operate approx. 3 minutes after power-ON and operation stop.
4	After the test operation finished, stop the air conditioner from the wireless remote controller, and return Dip switch of the receiver section as before. (A 60-minutes timer clearing function is attached to the receiver section in order to prevent a continuous test operation.)

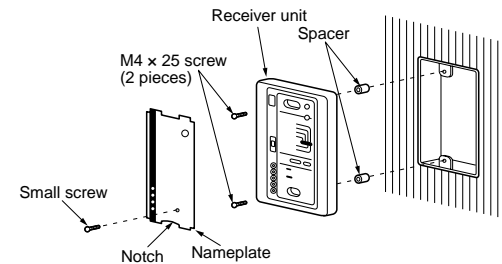

9 TROUBLESHOOTING

Confirmation and check

When a fault occurs in the air conditioner, the check code and the indoor unit No. will appear on the display part of the remote controller.

The check code will only be displayed while the unit is in operation.

If the display disappears, operate the air conditioner according to the following "Confirmation of error history" for confirmation.

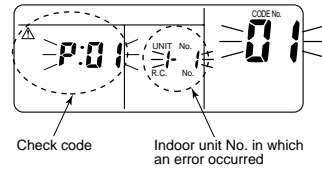

Confirmation of error history

When a fault occurs in the air conditioner, the error history can be confirmed with the following procedure. (The error history is stored in memory and can contain up to 4 errors).

This history can be confirmed from either the operating status or the stop status.

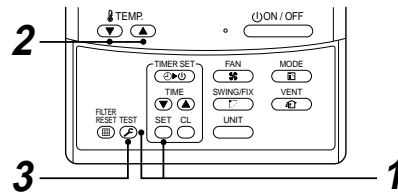

Procedure	Description
1	<p>When pushing the SET and TEST buttons simultaneously for 4 seconds or more, the display similar to the one shown in the figure to the right will appear.</p> <p>If [Service Check] is displayed, the fault code will be stored in the error history mode.</p> <ul style="list-style-type: none"> • 01 (Order of error history) is displayed in CODE No. window. • Check Code is displayed in the CHECK window. • The indoor unit address, where the fault has occurred will be displayed in the UNIT No. window.
2	<p>When pushing the TEMP. and ON/OFF buttons, the error history stored within the memory will be displayed in chronological order.</p> <p>The numbers displayed within the CODE No. window can vary between 1 and 4. 1 being the most recent fault and 4 being the oldest.</p> <p>CAUTION</p> <p>Do not push the CL button as this will erase all of the error history for that indoor unit.</p>
3	<p>After confirmation, push the TEST button. This will return the display back to its original mode.</p>

Check method

On the remote controller (Main remote controller, Central control remote controller) and the interface P.C. board of the outdoor unit, a check display LCD (Remote controller) or 7-segment display (on the outdoor interface P.C. board) operation is provided. Therefore the operation status can be known. Using this self-diagnosis function, a fault and the location of this fault within the air conditioning system can be located, as shown in the table below.

Check code list

The following list shows each check code. Find the check contents from the list according to part to be checked.

- In case of a fault from the indoor remote controller: See "Main remote controller display" in the list.
- In case of a fault from the outdoor unit: See "Outdoor 7-segment display" in the list.
- In case of a fault from the indoor unit with a wireless remote controller: See "Sensor block display of receiving unit" in the list.

Terminology

IPDU : Intelligent Power Drive Unit
 ○ : Lighting, □ : Flashing, ● : Goes off
 ALT. : Flashing is alternately when there are two flashing LED.
 SIM : Simultaneous flashing when there are two flashing LED.

Main remote controller display	Check code		Wireless remote controller				Check code name	Judging device
	Outdoor 7-segment display	Auxiliary code	Operation	Timer	Ready	Flash		
E01	—	—	□	●	●	●	Communication error between indoor and remote controller (Detected at remote controller side)	Remote controller
E02	—	—	□	●	●	●	Remote controller transmission error	Remote controller
E03	—	—	□	●	●	●	Communication error between indoor and remote controller (Detected at indoor side)	Indoor
E04	—	—	●	●	□	□	Communication circuit error between indoor/outdoor (Detected at indoor side)	Indoor
E06	E06	No. of indoor units in which sensor has been normally received	●	●	□	□	Decrease of No. of indoor units	I/F
—	E07	—	●	●	□	□	Communication circuit error between indoor/outdoor (Detected at outdoor side)	I/F
E08	E08	Duplicated indoor addresses	□	●	●	●	Duplicated indoor addresses	Indoor / I/F
E09	—	—	□	●	●	●	Duplicated main remote controllers	Remote controller
E10	—	—	□	●	●	●	Communication error between indoor MCU	Indoor
E12	E12	:01: Indoor/Outdoor communication :02: Communication between outdoor units	□	●	●	●	Automatic address start error	I/F
E15	E15	—	●	●	□	□	Indoor is nothing during automatic addressing	I/F
E16	E16	:00: Capacity over :01 ~: No. of connected units	●	●	□	□	Capacity over / No. of connected indoor units	I/F
E18	—	—	□	●	●	●	Communication error between indoor units	Indoor
E19	E19	:00: Header is nothing :02: Two or more header units	●	●	□	□	Outdoor header units quantity error	I/F
E20	E20	:01: Outdoor of other line connected :02: Indoor of other line connected	●	●	□	□	Other line connected during automatic address	I/F
E23	E23	—	●	●	□	□	Sending error in communication between outdoor units	I/F
E25	E25	—	●	●	□	□	Duplicated follower outdoor addresses	I/F
E26	E26	No. of outdoor units which received signal normally	●	●	□	□	Decrease of No. of connected outdoor units	I/F
E28	E28	Detected outdoor unit number	●	●	□	□	Follower outdoor unit error	I/F
E31	E31	:01: IPDU1 error :02: IPDU2 error :03: IPDU1, 2 error :04: Fan IPDU error :05: IPDU + Fan IPDU error :06: IPDU2 + Fan IPDU error :07: All IPDU error	●	●	□	□	IPDU communication error	I/F

9 TROUBLESHOOTING

Main remote controller display	Check code		Wireless remote controller				Check code name	Judging device
	Outdoor 7-segment display		Sensor block display of receiving unit					
	Auxiliary code		Operation	Timer	Ready	Flash		
F01	—	—	☒	☒	●	ALT	Indoor TCJ sensor error	Indoor
F02	—	—	☒	☒	●	ALT	Indoor TC2 sensor error	Indoor
F03	—	—	☒	☒	●	ALT	Indoor TC1 sensor error	Indoor
F04	F04	—	☒	☒	○	ALT	TD1 sensor error	I/F
F05	F05	—	☒	☒	○	ALT	TD2 sensor error	I/F
F06	F06	—	☒	☒	○	ALT	TE1 sensor error	I/F
F07	F07	—	☒	☒	○	ALT	TL sensor error	I/F
F08	F08	—	☒	☒	○	ALT	TO sensor error	I/F
F10	—	—	☒	☒	●	ALT	Indoor TA sensor error	Indoor
F12	F12	—	☒	☒	○	ALT	TS1 sensor error	I/F
F13	F13	:01: Comp. 1 side :02: Comp. 2 side	☒	☒	○	ALT	TH sensor error	IPDU
F15	F15	—	☒	☒	○	ALT	Outdoor temp. sensor miscabling (TE, TL)	I/F
F16	F16	—	☒	☒	○	ALT	Outdoor pressure sensor miscabling (Pd, Ps)	I/F
F23	F23	—	☒	☒	○	ALT	Ps sensor error	I/F
F24	F24	—	☒	☒	○	ALT	Pd sensor error	I/F
F29	—	—	☒	☒	●	SIM	Indoor other error	Indoor
F31	F31	—	☒	☒	○	SIM	Indoor EEPROM error	I/F
H01	H01	:01: Comp. 1 side :02: Comp. 2 side	●	☒	●		Compressor break down	IPDU
H02	H02	:01: Comp. 1 side :02: Comp. 2 side	●	☒	●		Magnet switch error Overcurrent relay operation Compressor trouble (lock)	MG-SW Overcurrent relay IPDU
H03	H03	:01: Comp. 1 side :02: Comp. 2 side	●	☒	●		Current detect circuit system error	IPDU
H04	H04	—	●	☒	●		Comp 1 case thermo operation	I/F
H06	H06	—	●	☒	●		Low pressure protective operation	I/F
H07	H07	—	●	☒	●		Oil level down detective protection	I/F
H08	H08	:01: TK1 sensor error :02: TK2 sensor error :03: TK3 sensor error :04: TK4 sensor error	●	☒	●		Oil level detective temp sensor error	I/F
H14	H14	—	●	☒	●		Comp 2 case thermo operation	I/F
H16	H16	:01: TK1 oil circuit system error :02: TK2 oil circuit system error :03: TK3 oil circuit system error :04: TK4 oil circuit system error	●	☒	●		Oil level detective circuit error Magnet switch error Overcurrent relay operation	MG-SW Overcurrent relay
L03	—	—	☒	●	☒	SIM	Indoor center unit duplicated	Indoor
L04	L04	—	☒	○	☒	SIM	Outdoor line address duplicated	I/F
L05	—	—	☒	●	☒	SIM	Duplicated indoor units with priority (Displayed in indoor unit with priority)	I/F
L06	L06	No. of indoor units with priority	☒	●	☒	SIM	Duplicated indoor units with priority (Displayed in unit other than indoor unit with priority)	I/F
L07	—	—	☒	●	☒	SIM	Group line in individual indoor unit	Indoor
L08	L08	—	☒	●	☒	SIM	Indoor group/Address unset	Indoor, I/F
L09	—	—	☒	●	☒	SIM	Indoor capacity unset	Indoor
L10	L10	—	☒	○	☒	SIM	Outdoor capacity unset	I/F
L20	L20	—	☒	○	☒	SIM	Duplicated central control addresses	Indoor
L28	L28	—	☒	○	☒	SIM	Over No. of connected outdoor units	I/F
L29	L29	:01: IPDU1 error :02: IPDU2 error :03: IPDU3 error :04: Fan IPDU error :05: IPDU1 + Fan IPDU error :06: IPDU2 + Fan IPDU error :07: All IPDU error	☒	○	☒	SIM	No. of IPDU error	I/F
L30	L30	Detected indoor address	☒	○	☒	SIM	Indoor outside interlock	Indoor
—	L31	—	—	—	—	—	Extended I/C error	I/F

Main remote controller display	Check code		Wireless remote controller				Check code name	Judging device
	Outdoor 7-segment display		Sensor block display of receiving unit					
	Auxiliary code		Operation	Timer	Ready	Flash		
P01	—	—	●	☒	☒	ALT	Indoor fan motor error	Indoor
P03	P03	—	☒	●	☒	ALT	Discharge temp. TD1 error	I/F
P04	P04	:01: Comp. 1 side :02: Comp. 2 side	☒	●	☒	ALT	High-pressure SW system operation	IPDU
P05	P05	:01: Phase-missing detection :02: Phase error	☒	●	☒	ALT	Phase-missing detection/Phase error	I/F
P07	P07	:01: Comp. 1 side :02: Comp. 2 side	☒	●	☒	ALT	Heat sink overheat error	IPDU, I/F
P10	P10	Detected indoor address	●	☒	☒	ALT	Indoor overflow error	Indoor
P12	—	—	●	☒	☒	ALT	Indoor fan motor error	Indoor
P13	P13	—	●	☒	☒	ALT	Outdoor liquid back detection error	I/F
P15	P15	:01: TS condition :02: TD condition	☒	●	☒	ALT	Gas leak detection	I/F
P17	P17	—	☒	●	☒	ALT	Discharge temp. TD2 error	I/F
P19	P19	Detected outdoor unit number	☒	●	☒	ALT	4-way valve inverse error	I/F
P20	P20	—	☒	●	☒	ALT	High-pressure protective operation	I/F
P22	P22	:0 : IGBT short :1 : Fan motor position detective circuit error :3 : Fan motor trouble :C : TH sensor temp. error (Heat sink overheat) :D : TH sensor error :E : Vdc output error	☒	●	☒	ALT	Outdoor fan IPDU error	IPDU
P26	P26	:01: Comp. 1 side :02: Comp. 2 side	☒	●	☒	ALT	G-TR short protection error	IPDU
P29	P29	:01: Comp. 1 side :02: Comp. 2 side	☒	●	☒	ALT	Comp position detective circuit system error	IPDU
P31	P31	—	☒	●	☒	ALT	Other indoor unit error (Group terminal unit error)	Indoor

Error detected by TCC-LINK central control device

Central control device indication	Check code		Wireless remote controller				Check code name	Judging device
	Outdoor 7-segment display		Sensor block display of receiving unit					
	Auxiliary code		Operation	Timer	Ready	Flash		
C05	—	—	—	—	—	—	Sending error in TCC-LINK central control device	TCC-LINK
C06	—	—	—	—	—	—	Receiving error in TCC-LINK central control device	TCC-LINK
C12	—	—	—	—	—	—	Batch alarm of general-purpose equipment control interface	General-purpose equipment I/F
P30	—	Differs according to error contents of unit with occurrence of alarm	—	—	—	—	Group control branching unit error	TCC-LINK
—	—	—	—	—	—	(L20 is displayed.)	Duplicated central control addresses	

Terminology

TCC-LINK : TOSHIBA Carrier Communication Link.

9 TROUBLESHOOTING

New check code

1. Difference between the new check code and the current system

The displaying method of the check code will change from this model onwards.

	New check code
Used characters	Alphabet + Decimal notation, 2 digits
Characteristics of code classification	Many classification of communication/incorrect setup system
Block display	Communication/Incorrect setup (4-ways), Indoor protection, Outdoor protection, Sensor, Compressor protection, etc.

Display on wired remote controller

- [▲] goes on.
- [UNIT No.] + Check code + Operation lamp (Green) flash

Display on sensor part of wireless remote controller

- Block display will show a combination of [U] [E] [H] symbols.

Display on 7-segment in outdoor unit

- Unit No. and check code are displayed.
- In case of error the auxiliary code, check code and sub-code are displayed alternately.

Display	Classification
A	Unused
C	Central control system error
E	Communication system error
F	Each sensor error (Failure)
H	Compressor protective system error
J	Unused
L	Setup error, Other errors
P	Protective device operation

2. Special mention

- When the air conditioner stops and the error is cleared, the check code display on the remote controller will also disappear.

However, if the error continues after the unit has been stopped, the check code will immediately be displayed when the unit is restarted.

10 MAINTENANCE

Prior to maintenance, ensure the power supply is turned off.

CAUTION

Do not handle the buttons with wet hands as this will cause the risk of electric shock.

Daily maintenance

Cleaning of air filter

- 1 If [] is displayed on the remote controller, maintenance to the air filter is required.
- 2 Clogging of the air filter decreases cooling/heating efficiency.
- 3 After cleaning, push the . [] display disappears.

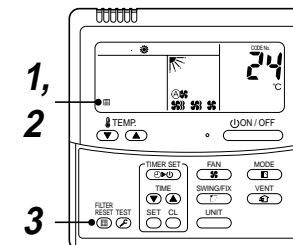

[4-way Air Discharge Cassette Type]

- 1 Open the air inlet grille.
 - Slide the air inlet grille buttons to detach the air inlet grille from the main ceiling panel. Lower the grille slowly while holding.
- 2 Take out the air filter.
 - Push the extrusion of the air filter away from the grille and remove.
- 3 Cleaning with water or vacuum cleaner
 - If dirt is heavy, clean the air filter using tepid water with a neutral detergent or just water.
 - After cleaning with water, dry the air filter sufficiently in a shaded place.
- 4 Mount the air filter.
- 5 Close the air inlet grille.
 - Close the air inlet grille, slide the button to locate into the ceiling panel fixing securely.
- 6 Push the .
 - [] display disappears.

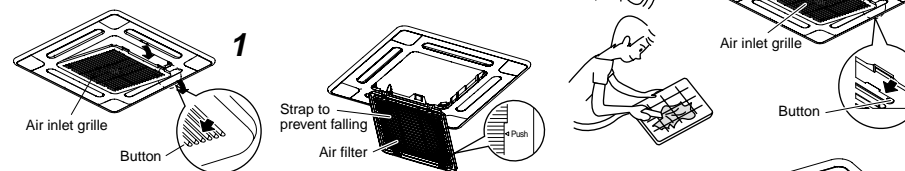

Cleaning of air outlet flap

The air outlet flap can be removed to clean if necessary.

- 1 Remove the air outlet flap.
 - Holding both ends of the air outlet flap, remove it by sagging the center downwards.
- 2 Clean the air outlet flap with water.
 - If dirt is heavy, clean the air outlet flap using tepid water with neutral detergent or just water.
- 3 Mount the air outlet flap.
 - First push in the one side, and insert the opposite side by sagging the center downwards.

Be careful to insert the flap in the correct direction.

Insert the flap with the printed mark facing upwards, and the arrow on the flap pointing in the outward direction.

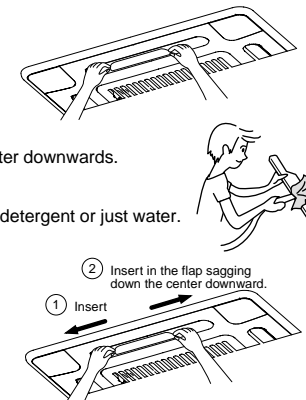



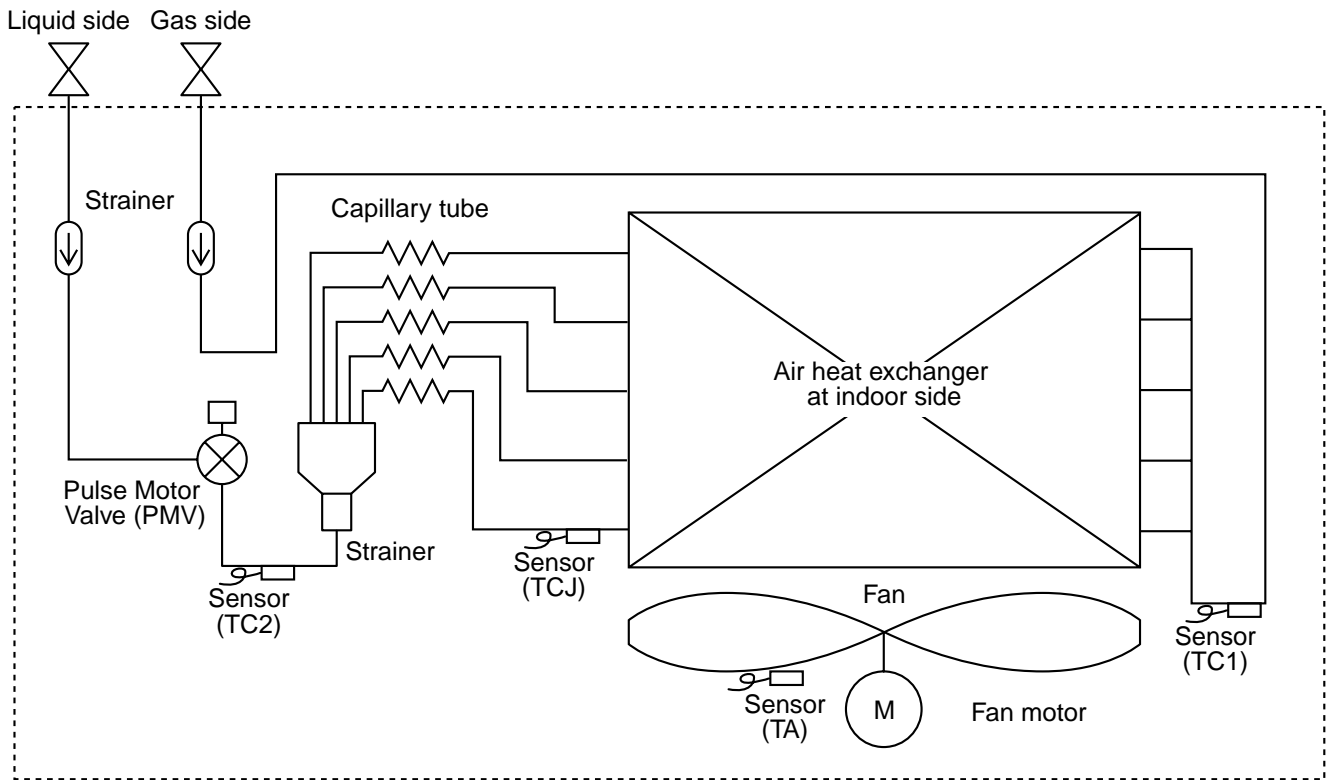

4. REFRIGERATING CYCLE DIAGRAM



Functional part name		Functional outline
Pulse Motor Valve	PMV	(Connector CN082 (6P): Blue) 1) Controls super heat in cooling operation 2) Controls under cool in heating operation 3) Recovers refrigerant oil in cooling operation 4) Recovers refrigerant oil in heating operation
Temp. sensor	1. TA	(Connector CN104 (2P): Yellow) 1) Detects indoor suction temperature
	2. TC1	(Connector CN100 (3P): Brown) 1) Controls PMV super heat in cooling operation
	3. TC2	(Connector CN101 (2P): Black) 1) Controls PMV under cool in heating operation
	4. TCJ	(Connector CN102 (2P): Red) 1) Controls PMV super heat in cooling operation





5. CONTROL OUTLINE

5-1. Control Specifications

No.	Item	Outline of specifications	Remarks																					
1	Power supply is reset.	1. Distinction of outdoor unit When the power supply is reset, the outdoor units are distinguished, and control is exchanged according to the distinctive results. 2. Check code clear When the power supply is reset, the check code is also reset once. If an abnormal status which the check code appears after Start/Stop button of the remote controller has been pushed continues, the check code is displayed again on the remote controller.																						
2	Operation select	1. Based upon the operation select command from the remote controller or central controller, the operation mode is selected. <table border="1" style="margin: 10px 0;"> <thead> <tr> <th>Remote controller command</th> <th>Control outline</th> </tr> </thead> <tbody> <tr> <td>STOP</td> <td>Stops air conditioner.</td> </tr> <tr> <td>FAN</td> <td>Fan operation</td> </tr> <tr> <td>COOL</td> <td>Cooling operation</td> </tr> <tr> <td>DRY</td> <td>Dry operation</td> </tr> <tr> <td>HEAT</td> <td>Heating operation</td> </tr> <tr> <td>COOL/HEAT AUTO</td> <td>COOL/HEAT AUTO operation</td> </tr> </tbody> </table> Heating operation is automatically selected with difference between setup temperature and room temperature.	Remote controller command	Control outline	STOP	Stops air conditioner.	FAN	Fan operation	COOL	Cooling operation	DRY	Dry operation	HEAT	Heating operation	COOL/HEAT AUTO	COOL/HEAT AUTO operation								
Remote controller command	Control outline																							
STOP	Stops air conditioner.																							
FAN	Fan operation																							
COOL	Cooling operation																							
DRY	Dry operation																							
HEAT	Heating operation																							
COOL/HEAT AUTO	COOL/HEAT AUTO operation																							
3	Room temp. control	1. Adjustment range, set temperature on remote controller (°C) <table border="1" style="margin: 10px 0;"> <thead> <tr> <th></th> <th>All cooling</th> <th>All heating</th> </tr> </thead> <tbody> <tr> <td>Wired type</td> <td>18 to 29°C</td> <td>18 to 29°C</td> </tr> <tr> <td>Wireless type</td> <td>18 to 30°C</td> <td>16 to 30°C</td> </tr> </tbody> </table> 2. From the item code 06, the setup temperature in heating operation can be corrected. <table border="1" style="margin: 10px 0;"> <tbody> <tr> <td>Setup data</td> <td>0</td> <td>2</td> <td>4</td> <td>6</td> </tr> <tr> <td>Setup temp. correction</td> <td>+0°C</td> <td>+2°C</td> <td>+4°C</td> <td>+6°C</td> </tr> </tbody> </table> Setup at shipment <table border="1" style="margin: 10px 0;"> <tbody> <tr> <td>Setup data</td> <td>2</td> </tr> </tbody> </table>		All cooling	All heating	Wired type	18 to 29°C	18 to 29°C	Wireless type	18 to 30°C	16 to 30°C	Setup data	0	2	4	6	Setup temp. correction	+0°C	+2°C	+4°C	+6°C	Setup data	2	Heating suction temperature shift
	All cooling	All heating																						
Wired type	18 to 29°C	18 to 29°C																						
Wireless type	18 to 30°C	16 to 30°C																						
Setup data	0	2	4	6																				
Setup temp. correction	+0°C	+2°C	+4°C	+6°C																				
Setup data	2																							
4	Automatic capacity control	1. Based upon difference between Ta and Ts, the operation frequency is indicated to the outdoor unit.	TS: Set temperature Ta: Room temperature																					
5	Air volume control	1. By the command from the remote controller, "HIGH  ", "MED  ", or "LOW  " and "AUTO  " operation is executed. 2. While air speed is in AUTO mode, the air speed is changed according to the difference between Ta and Ts.																						

No.	Item	Outline of specifications	Remarks															
6	Prevention of cold air discharge	<p>1. In all heating operation, the upper limit of the fan tap is set by one with higher temperature of TC2 sensor and TCJ sensor.</p> <ul style="list-style-type: none"> When B zone has continued for 6 minutes, the operation shifts to C zone. In defrost time, the control point is set to +6°C. <p>A zone: OFF B zone: Over 26°C, below 28°C, ULTRA LOW C zone: Over 28°C, below 30°C, LOW D zone: Over 30°C, below 32°C, MED E zone: HIGH</p>	<ul style="list-style-type: none"> In D and E zones, priority is given to remote controller air speed setup. In A “” is displayed. 															
7	Freeze prevention control (Low temp. release)	<p>1. In all cooling operation, the air conditioner operates as described below based upon temp. detected by TC1, TC2 and TCJ sensors.</p> <p>To prevent the heat exchanger from freezing, the operation stops.</p> <ul style="list-style-type: none"> When “J” zone is detected for 5 minutes, the command frequency becomes “S0” to the outdoor unit. In “K” zone, the timer count is interrupted, and held. When “I” zone is detected, the timer is cleared and the operation returns to the normal operation. When the command frequency became S0 with continuation of “J” zone, operation of the the indoor fan in LOW mode until it reaches the “I” zone. <p>It is reset when the following conditions are satisfied.</p> <p>Reset conditions</p> <ol style="list-style-type: none"> TC1 ≥ 12°C and TC2 ≥ 12°C and TCJ ≥ 12°C 30 minutes passed after stop. <table border="1" data-bbox="730 1288 1088 1422"> <thead> <tr> <th></th> <th>TC1</th> <th>TC2, TCJ</th> </tr> </thead> <tbody> <tr> <td>P1</td> <td>10°C (5°C)</td> <td>-10°C</td> </tr> <tr> <td>Q1</td> <td>0°C</td> <td>-14°C</td> </tr> </tbody> </table> <p>2. In all cooling operation, the air conditioner operates as described below based upon temp. detected by TC2 and TCJ sensors.</p> <ul style="list-style-type: none"> When “M” zone is detected for 45 minutes, the command frequency becomes “S0” to the outdoor unit. In “N” zone, the timer count is interrupted and held. When shifting to “M” zone again, the timer count restarts and continues. If “L” zone is detected, the timer is cleared and the operation returns to normal operation. <p>Reset conditions</p> <ol style="list-style-type: none"> TC1 ≥ 12°C and TC2 ≥ 12°C and TCJ ≥ 12°C 30 minutes passed after stop. <table border="1" data-bbox="858 1915 1088 2049"> <thead> <tr> <th></th> <th>TC2, TCJ</th> </tr> </thead> <tbody> <tr> <td>P2</td> <td>5°C</td> </tr> <tr> <td>Q2</td> <td>-2.0°C</td> </tr> </tbody> </table>		TC1	TC2, TCJ	P1	10°C (5°C)	-10°C	Q1	0°C	-14°C		TC2, TCJ	P2	5°C	Q2	-2.0°C	<p>() value:</p> <p>When the power supply is turned on, the Forced thermo becomes OFF if the temperature is less than this indicated temperature.</p> <p>* In a Model without TC2, TC2 is not judged.</p>
	TC1	TC2, TCJ																
P1	10°C (5°C)	-10°C																
Q1	0°C	-14°C																
	TC2, TCJ																	
P2	5°C																	
Q2	-2.0°C																	

No.	Item	Outline of specifications	Remarks
8	Recovery control for cooling refrigerant and oil	<ol style="list-style-type: none"> 1. The indoor unit which stops operation, thermostat is OFF, or operates in FAN mode opens PMV of the indoor unit by the specified opening degree when cooling refrigerant or oil recovery signal is received from the outdoor unit. 2. Drain pump of Compact 4-way Air Discharge Cassette type operates during recovery control mode. 	<ul style="list-style-type: none"> • Recovery operation is usually executed every 2 hours.
9	Recovery control for heating refrigerant and oil	<p>The indoor unit which stops operation, thermostat is OFF, or operates in FAN mode performs the following controls when the heating refrigerant/Oil recovery signal is received from the outdoor unit.</p> <ol style="list-style-type: none"> 1. Opens PMV of the indoor unit by the specified opening degree. 2. Stops the fan. 3. Compact 4-way Air Discharge Cassette type air conditioner rotates the indoor fan with Ultra Low Fan operation for approx. 1 minute after recovery control. 4. After recovery control, drain pump of Compact 4-way Air Discharge Cassette type will operate. 	<ul style="list-style-type: none"> • In the indoor unit which thermostat is OFF, or operates in FAN mode, "Ⓢ" lamp goes on. • Recovery operation is usually executed every 1 hour. (In this time the flap directs upward)
10	Short intermittent operation compensation control	<ol style="list-style-type: none"> 1. For 5 minutes after the operation has started, the operation is continued even if entering thermostat-OFF condition. 2. However, if the thermostat has been turned off by changing the set up temp., the thermostat is OFF with even the above condition. The protective control has priority. 	
11	Drain pump control	<ol style="list-style-type: none"> 1. During "COOL" operation (including DRY operation), the drain pump operates. 2. While the drain pump operates, if the float switch works, the drain pump continues operation and a check code is displayed. 3. While the drain pump stops, if the float switch works, turn off the capacity demand command, stop the operation, and operate the drain pump. If the float switch continues operating for approx. 5 minutes, the operation stops and the check code is displayed. 	Check code [P10]
12	Elimination of remaining heat	<ol style="list-style-type: none"> 1. When the air conditioner stops in the "HEAT" mode, drive the indoor fan with "LOW" mode for approx. 30 seconds. 	
13	Auto flap control	<ol style="list-style-type: none"> 1. When the flap signal has been received from the remote controller, the louver operates if the indoor fan is operating. 2. In Compact 4-way Air Discharge Cassette type, the discharge flap automatically directs upward if the operation stops. 3. In Compact 4-way Air Discharge Cassette type, the discharge flap directs upward if the heating operation is being prepared. 	
14	Filter sign display (None in wireless type) * Provided in the separately laid type TCB-AX21E.	<ol style="list-style-type: none"> 1. The operation time of the indoor fan is integrated and stored in memory, and the filter exchange signal is sent to the remote controller to display on the remote controller LCD after the specified time. 2. When the filter reset signal is received from the remote controller, time of the integrated timer is cleared. In this time, if the specified time has passed, the measured time is reset and LCD display disappears. 	

No.	Item	Outline of specifications	Remarks
15	 and  display (Operation and heating stand-by)	<p><Operation standby> Display on remote controller</p> <ol style="list-style-type: none"> <ul style="list-style-type: none"> “P05” is one of displays of power wire missing. “P05” of power cable is detected. “COOL/DRY” operation cannot be performed because the other indoor unit is under “HEAT” operation. “HEAT” operation cannot be performed because COOL priority is set (Outdoor I/F P.C. board SW11 1-bit is ON) and the other indoor unit is under “COOL/DRY” operation. “FAN” operation cannot be performed because the system performs “Heat oil/Refrigerant recovery” operation. There is a unit in which indoor overflow “P10” is detected. There is a unit in which interlock alarm “P23” is detected. The above indoor units unavailable to operate waits under condition of thermostat OFF. <p><HEAT standby> Display on remote controller</p> <ol style="list-style-type: none"> <ul style="list-style-type: none"> During HEAT operation, the fan rotates with lower air speed than one specified in order to prevent discharge of cold draft or stops. (including case that defrost operation is being performed) “HEAT” operation cannot be performed because COOL priority is set (Outdoor I/F P.C. board SW11 bit 1 is ON) and the other indoor unit is under “COOL/DRY” operation. “HEAT standby” is displayed until the above conditions are released. 	<ul style="list-style-type: none">  goes on.  goes on.
16	Selection of central control mode	<ol style="list-style-type: none"> The contents which can be changed on the remote controller at indoor unit side can be selected by setup at the central controller side. In case of operation from TCC-LINK central controller (TCB-SC642 TLE2, etc.) <p>[Central control mode 1] : Cannot operate</p> <p>[Central control mode 2] : Cannot operate, stop, select mode, set up temp.</p> <p>[Central control mode 3] : Cannot select mode, set up temp.</p> <p>[Central control mode 4] : Cannot select mode</p> RBC-AMT31E (Wired remote controller) <p>While mode is the central control mode,  “CENTRAL” lights on the display part of the remote controller.</p>	<p>If operation is performed from the remote control “CENTRAL CONTROL” mode, the status is notified with receiving sound.</p>

6. APPLIED CONTROL

6-1. Setup of Selecting Function in Indoor Unit (Be sure to Execute Setup by a Wired Remote Controller)

<Procedure> Execute the setup operation while the unit stops.

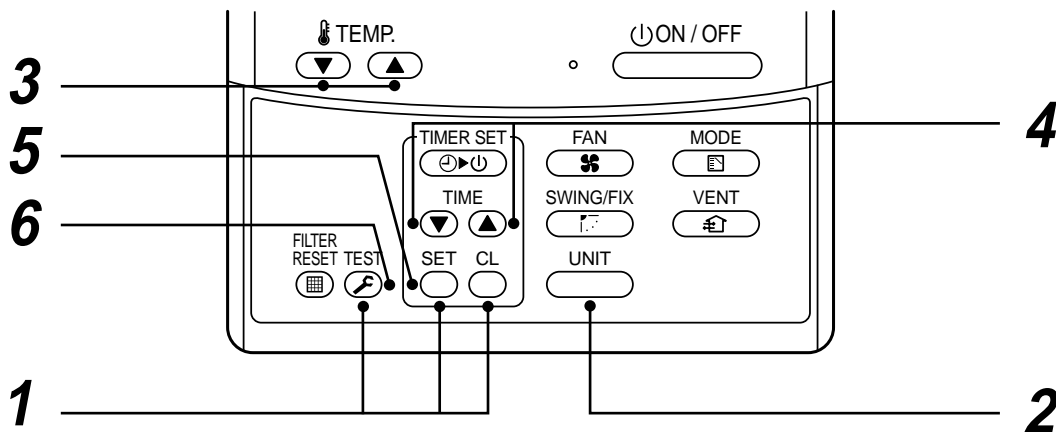

1 Push **SET**, **CL**, and **TEST** buttons simultaneously for 4 seconds or more.

The firstly displayed unit No. indicates the header indoor unit address in the group control.
In this time, the fan of the selected indoor unit is turned on.

2 Every pushing **UNIT** button, the indoor unit numbers in the group control are successively displayed. In this time, the fan of the selected indoor unit only is turned on.

3 Specify the item code (DN) using the setup temperature **▼** and **▲** buttons.

4 Select the setup data using the timer time **▼** and **▲** buttons.

(When selecting the DN code to “33”, change the temperature indication of the unit from “°C” to “°F” on the remote controller.)

5 Push **SET** button. (OK if display goes on.)

- To change the selected indoor unit, return to procedure **2**.
- To change the item to be set up, return to procedure **3**.

6 Pushing **TEST** button returns the status to normal stop status.

Table: Function selecting item numbers (DN)
(Items necessary to perform the applied control at the local site are described.)

DN	Item	Description	At shipment
01	Filter display delay timer	0000 : None 0002 : 2500H 0004 : 10000H 0001 : 150H 0003 : 5000H	0002 : 2500H
02	Dirty state of filter	0000 : Standard 0001 : High degree of dirt (Half of standard time)	0000 : Standard
03	Central control address	0001 : No.1 unit to 0064 : No.64 unit 0099 : Unfixed	0099 : Unfixed
04	Specific indoor unit priority	0000 : No priority 0001 : Priority	0000 : No priority
06	Heating temp shift	0000 : No shift to 0001 : +1°C 0002 : +2°C to 0010 : +10°C (Up to +6 recommended)	0002 : +2°C (Floor type 0000: 0°C)
0d	Existence of [AUTO] mode	0000 : Provided 0001 : Not provided (Automatic selection from connected outdoor unit)	0001 : Not provided
0E	Follows operation mode of the header unit	0000 : Does not follow 0001 : Follows	0000 : Not provided
0F	Cooling only	0000 : Heat pump 0001 : Cooling only (No display of [AUTO] [HEAT])	0000 : Heat pump
10	Type	0014: Compact 4-way Air Discharge Cassette	0014: Compact 4-way A/D only
11	Indoor unit capacity	0000 : Unfixed 0001 to 0034	According to capacity type
12	Line address	0001 : No.1 unit to 0030 : No.30 unit	0099 : Unfixed
13	Indoor unit address	0001 : No.1 unit to 0064 : No.64 unit	0099 : Unfixed
14	Group address	0000 : Individual 0002 : Follower unit of group 0001 : Header unit of group	0099 : Unfixed
1E	Temp difference of [AUTO] mode selection COOL → HEAT, HEAT → COOL	0000 : 0 deg to 0010 : 10 deg (For setup temperature, reversal of COOL/HEAT by ± (Data value)/2)	0003 : 3 deg (Ts±1.5)
28	Automatic restart of power failure	0000 : None 0001 : Restart	0000 : None
2A	Selection of option/error input (CN70)	0000 : Filter input 0002 : None 0001 : Alarm input (Air washer, etc.)	0002 : None
2E	HA terminal (CN61) select	0000 : Usual 0002 : Fire alarm input 0001 : Leaving-ON prevention control	0000 : Usual (HA terminal)
31	Ventilating fan control	0000 : Unavailable 0001 : Available	0000 : Unavailable
32	TA sensor selection	0000 : Body TA sensor 0001 : Remote controller sensor	0000 : Body TA sensor
33	Temperature unit select	0000 : °C (at factory shipment) 0001 : °F	0000 : °C
5d	High ceiling selection (Air volume selection)	[Compact 4-way Air Discharge Cassette type] 0000 : AP007 to AP012; Below 2.7m AP015; Below 2.9m AP018; Below 3.2m 0002 : AP015; Below 3.2m AP018; Below 3.4m 0003 : AP015, AP018; Below 3.5m	0000 : Standard
60	Timer set (Wired remote controller)	0000 : Available (Operable) 0001 : Unavailable (Operation prohibited)	0000 : Available

TYPE

Item code [10]

Setup data	Type	Abbreviated Model name
0014	Compact 4-way Air Discharge Cassette	MMU-AP XXX MH

Indoor unit capacity

Item code [11]

Setup data	Model
0001	007
0003	009
0005	012
0007	015
0009	018

6-2. Applied Control in Indoor Unit

■ Remote location ON/OFF control box (TCB-IFCB-4E)

[Wiring and setup]

- Use the exclusive connector for connection with the indoor control P.C. board.
- In a group control, the system can operate when connecting with any indoor unit (Control P.C. board) in the group. However when taking out the operation/error signal from the other unit, it is necessary to take out from each unit individually.

(1) Control items

- 1) Start/Stop input signal : Operation start/stop in unit
- 2) Operation signal : Output during normal operation
- 3) Error signal : Output during alarm
(Serial communication error or indoor/outdoor protective device) operation

(2) Wiring diagram using remote control interface (TCB-IFCB-4E)

- Input IFCB-4E : No voltage ON/OFF serial signal
- Output No voltage contact for operation, error display
Contact capacity: Below Max. AC240V 0.5A

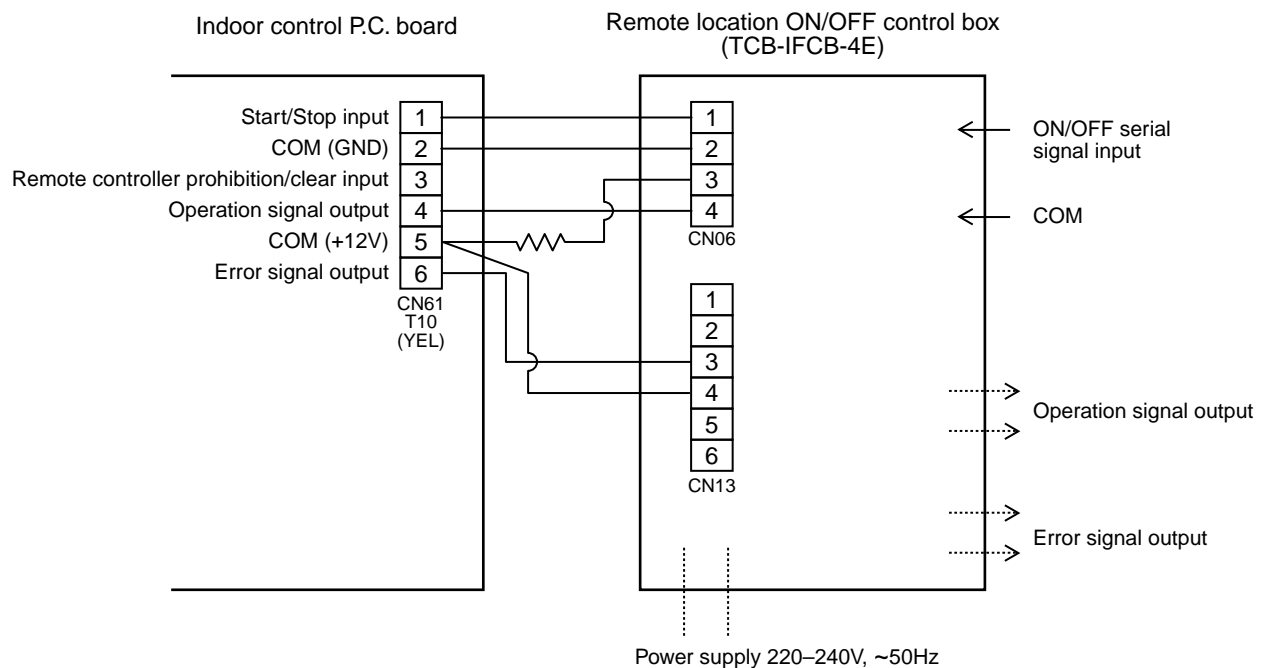

■ Ventilating fan control from remote controller

[Function]

- The start/stop operation can be operated from the wired remote controller when air to air heat exchanger or ventilating fan is installed in the system.
- The fan can be operated even if the indoor unit is not operating.
- Use a fan which can receive the no-voltage A contact as an outside input signal.
- In a group control, the units are collectively operated and they can not be individually operated.

(1) Operation

Handle a wired remote controller in the following procedure.

- * Use the wired remote controller during stop of the system.
- * Be sure to set up the wired remote controller to the header unit. (Same in group control)
- * In a group control, if the wired remote controller is set up to the header unit, both header and follower units are simultaneously operable.

1 Push concurrently **SET** + **CL** + **TEST** buttons for 4 seconds or more.

The unit No. displayed firstly indicates the header indoor unit address in the group control.

In this time, the fan of the selected indoor unit turns on.

2 Every pushing **UNIT** button, the indoor unit numbers in group control are displayed successively.

In this time, the fan of the selected indoor unit only turns on.

3 Using the setup temp **▼** or **▲** button, specify the item code **31**.

4 Using the timer time **▼** or **▲** button, select the setup data. (At shipment: **0000**)

The setup data are as follows:

Setup data	Handling of operation of air to air heat exchanger or ventilating fan
0000	Unavailable (At shipment)
0001	Available

5 Push **SET** button. (OK if display goes on.)

- To change the selected indoor unit, go to the procedure **2**).
- To change the item to be set up, go to the procedure **3**).

6 Pushing **TEST** returns the status to the usual stop status.

(2) Wiring

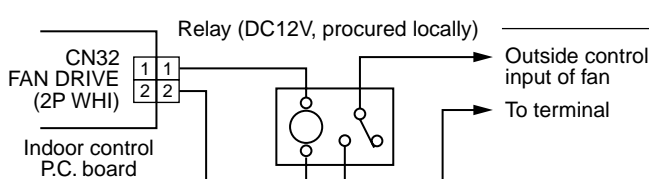

Note) Determine the cable length between the indoor control P.C. board and the relay within 2m.

Compact 4-way Air Discharge Cassette type
 4-way Air Discharge Cassette type
 1-way Air Discharge Cassette type (2 series)
 Concealed Duct Standard type
 Slim Duct type
 Under Ceiling type
 High Wall type
 } model :

Corresponds up to a relay in which rated current of the operation coil is approx. 75mA
 Other type models:
 Correspond up to a relay in which rated current of the operation coil is approx. 16mA (Does not correspond to a terminal block type relay on the market.)

■ Leaving-ON prevention control

[Function]

- This function controls the indoor units individually. It is connected with cable to the control P.C. board of the indoor unit.
- In a group control, it is connected with cable to the indoor unit (Control P.C. board), and the item code \overline{ZE} is set to the connected indoor unit.
- It is used when the start operation from outside if unnecessary but the stop operation is necessary.
- Using a card switch box, card lock, etc, the forgotten-OFF of the indoor unit can be protected.
 - When inserting a card, start/stop operation from the remote controller is allowed.
 - When taking out a card, the system stops if the indoor unit is operating and start/stop operation from the remote controller is forbidden.

(1) Control items

- 1) Outside contact ON : The start/stop operation from the remote controller is allowed.
(Status that card is inserted in the card switch box)
- 2) Outside contact OFF : If the indoor unit is operating, it is stopped forcibly.
(Start/Stop prohibited to remote controller)
(Status that card is taken out from the card switch box)

* When the card switch box does not perform the above contact operation, convert it using a relay with b contact.

(2) Operation

Handle the wired remote controller switch in the following procedure.

* Use the wired remote controller switch during stop of the system.

- 1 Push concurrently SET + CL + TEST buttons for 4 seconds or more.
- 2 Using the setup temp ∇ or \blacktriangle button, specify the item code \overline{ZE} .
- 3 Using the timer time ∇ or \blacktriangle button, set 0001 to the setup data.
- 4 Push SET button.
- 5 Push TEST button. (The status returns to the usual stop status.)

(3) Wiring

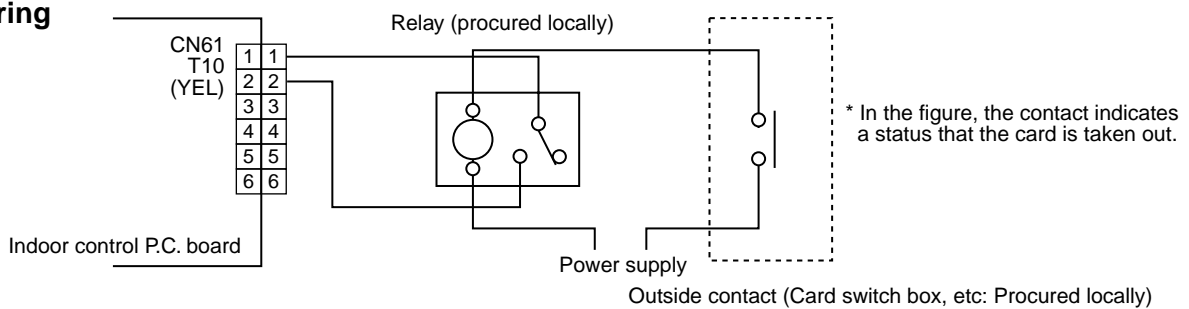

■ Power peak-cut from indoor unit

When the relay is turned on, a forced thermostat-OFF operation starts.

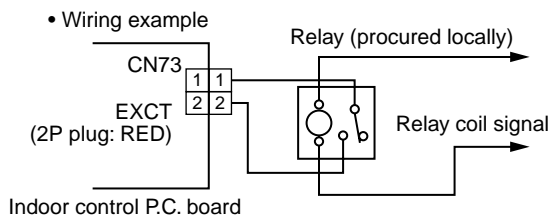

Note) Determine the cable length between the indoor or outdoor control P.C. board and the relay within 2m.

7. TROUBLESHOOTING

7-1. Troubleshooting Summary

1. Before troubleshooting

1) Applied models

① **S-MMS Multi type models**

Indoor unit: MMX-APXXX,
Outdoor unit: MMY-MAPXXXHT8, MMY-MAPXXXT7

② **Super Heat Recovery Multi type models**

Indoor unit: MMX-APXXX,
Outdoor unit: MMY-MAPXXXFT8

③ **Mini-S-MMS Multi type models**

Indoor unit: MMX-APXXX,
Outdoor unit: MCY-MAPXXXHT, MCY-MAPXXXHT2D

2) Required tools / measuring devices

- Screwdrivers (Philips, Minus), spanner, radio pinchers, nipper, push pin for reset switch, etc.
- Tester, thermometer, pressure gauge, etc.

3) Confirmation before check (The following items are not troubles.)

No.	Operation	Check items
1	Compressor does not operate.	<ul style="list-style-type: none"> • Is not delayed for 3 minutes? (3 minutes after compressor-OFF) • Is not thermostat OFF? • Is not the fan operating or timer? • Is not the system initially communicating? Heating operation cannot be performed under condition of outside temperature 21°C or higher. Cooling operation cannot be performed under condition of outside temperature -5°C or lower.
2	Indoor fan does not work.	<ul style="list-style-type: none"> • Is not the cold draft prevention being controlled in heating operation?
3	Outdoor fan does not rotate, or fan speed changes.	<ul style="list-style-type: none"> • Is not low cooling operation being controlled? • Is not a defrost operation being performed?
4	Indoor fan does not stop.	<ul style="list-style-type: none"> • Is not after-heat elimination operation being controlled after heating operation?
5	Start/stop operation on remote controller is unavailable.	<ul style="list-style-type: none"> • Is not auxiliary unit or remote control being operated?
6	—	<ul style="list-style-type: none"> • Is connecting wire of indoor unit or remote controller correct?

2. Troubleshooting procedure

When a trouble occurred, advance the check operation in the following procedure.

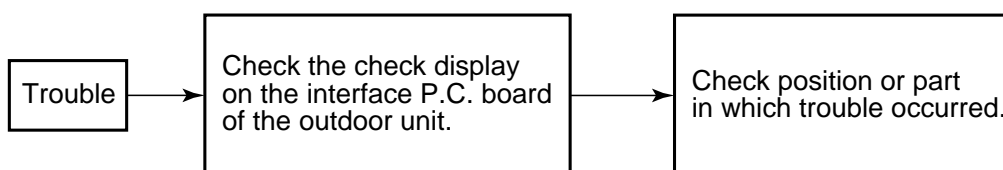

NOTE) While a check operation is performed, a malfunction of the microprocessor may be caused due to condition of the power supply or the external noise. If there is any noise source, change wires of the remote controller and signal wires to shield wires.

7-2. Check Method

On the remote controller (Main remote controller, Central control remote controller) and the interface P.C. board of the outdoor unit, a check display LCD (Remote controller) or 7-segment display (on the outdoor interface P.C. board) to display the operation is provided. Therefore the operation status can be known. Using this self-diagnosis function, a trouble or position with trouble of the air conditioner can be found as shown in the table below.

Check code list

The following list shows each check code. Find the check contents from the list according to part to be checked.

- In case of check from indoor remote controller: See “Main remote controller display” in the list.
- In case of check from outdoor unit: See “Outdoor 7-segment display” in the list.
- In case of check from indoor unit with wireless remote controller: See “Sensor block display of receiving unit” in the list.

IPDU: Intelligent Power Drive Unit

○ : Lighting, ✕ : Flashing, ● : Goes off

ALT.: Flashing is alternately when there are two flashing LED.

SIM: Simultaneous flashing when there are two flashing LED

Main remote controller display	Check code		Wireless remote controller				Check code name	Judging device
	Outdoor 7-segment display	Auxiliary code	Operation	Timer	Ready	Flash		
E01	—	—	✕	●	●		Communication error between indoor and remote controller (Detected at remote controller side)	Remote controller
E02	—	—	✕	●	●		Remote controller transmission error	Remote controller
E03	—	—	✕	●	●		Communication error between indoor and remote controller (Detected at indoor side)	Indoor
E04	—	—	●	●	✕		Communication circuit error between indoor/outdoor (Detected at indoor side)	Indoor
E06	E06	No. of indoor units in which sensor has been normally received	●	●	✕		Decrease of No. of indoor units	I/F
—	E07	—	●	●	✕		Communication circuit error between indoor/outdoor (Detected at outdoor side)	I/F
E08	E08	Duplicated indoor addresses	✕	●	●		Duplicated indoor addresses	Indoor / I/F
E09	—	—	✕	●	●		Duplicated main remote controllers	Remote controller
E10	—	—	✕	●	●		Communication error between indoor MCU	Indoor
E12	E12	:01: Indoor/Outdoor communication :02: Communication between outdoor units	✕	●	●		Automatic address start error	I/F
E15	E15	—	●	●	✕		Indoor is nothing during automatic addressing	I/F
E16	E16	:00: Capacity over :01 -: No. of connected units	●	●	✕		Capacity over / No. of connected indoor units	I/F
E18	—	—	✕	●	●		Communication error between indoor units	Indoor
E19	E19	:00: Header is nothing :02: Two or more header units	●	●	✕		Outdoor header units quantity error	I/F
E20	E20	:01: Outdoor of other line connected :02: Indoor of other line connected	●	●	✕		Other line connected during automatic address	I/F
E23	E23	—	●	●	✕		Sending error in communication between outdoor units	I/F
E25	E25	—	●	●	✕		Duplicated follower outdoor addresses	I/F
E26	E26	No. of outdoor units which received signal normally	●	●	✕		Decrease of No. of connected outdoor units	I/F
E28	E28	Detected outdoor unit number	●	●	✕		Follower outdoor unit error	I/F
E31	E31	:01: IPDU1 error :02: IPDU2 error :03: IPDU1, 2 error :04: Fan IPDU error :05: IPDU + Fan IPDU error :06: IPDU2 + Fan IPDU error :07: All IPDU error	●	●	✕		IPDU communication error	I/F

Check code		Wireless remote controller				Check code name	Judging device	
Main remote controller display	Outdoor 7-segment display		Sensor block display of receiving unit					
	Auxiliary code	Operation	Timer	Ready	Flash			
F01	—	—	☒	☒	●	ALT	Indoor TCJ sensor error	Indoor
F02	—	—	☒	☒	●	ALT	Indoor TC2 sensor error	Indoor
F03	—	—	☒	☒	●	ALT	Indoor TC1 sensor error	Indoor
F04	F04	—	☒	☒	○	ALT	TD1 sensor error	I/F
F05	F05	—	☒	☒	○	ALT	TD2 sensor error	I/F
F06	F06	—	☒	☒	○	ALT	TE1 sensor error	I/F
F07	F07	—	☒	☒	○	ALT	TL sensor error	I/F
F08	F08	—	☒	☒	○	ALT	TO sensor error	I/F
F10	—	—	☒	☒	●	ALT	Indoor TA sensor error	Indoor
F12	F12	—	☒	☒	○	ALT	TS1 sensor error	I/F
F13	F13	:01: Comp. 1 side :02: Comp. 2 side	☒	☒	○	ALT	TH sensor error	IPDU
F15	F15	—	☒	☒	○	ALT	Outdoor temp. sensor miscabling (TE, TL)	I/F
F16	F16	—	☒	☒	○	ALT	Outdoor pressure sensor miscabling (Pd, Ps)	I/F
F23	F23	—	☒	☒	○	ALT	Ps sensor error	I/F
F24	F24	—	☒	☒	○	ALT	Pd sensor error	I/F
F29	—	—	☒	☒	●	SIM	Indoor other error	Indoor
F31	F31	—	☒	☒	○	SIM	Indoor EEPROM error	I/F
H01	H01	:01: Comp. 1 side :02: Comp. 2 side	●	☒	●		Compressor break down	IPDU
H02	H02	:01: Comp. 1 side :02: Comp. 2 side	●	☒	●		Magnet switch error Overcurrent relay operation Compressor trouble (lock)	MG-SW Overcurrent relay IPDU
H03	H03	:01: Comp. 1 side :02: Comp. 2 side	●	☒	●		Current detect circuit system error	IPDU
H04	H04	—	●	☒	●		Comp 1 case thermo operation	I/F
H06	H06	—	●	☒	●		Low pressure protective operation	I/F
H07	H07	—	●	☒	●		Oil level down detective protection	I/F
H08	H08	:01: TK1 sensor error :02: TK2 sensor error :03: TK3 sensor error :04: TK4 sensor error	●	☒	●		Oil level detective temp sensor error	I/F
H14	H14	—	●	☒	●		Comp 2 case thermo operation	I/F
H16	H16	:01: TK1 oil circuit system error :02: TK2 oil circuit system error :03: TK3 oil circuit system error :04: TK4 oil circuit system error	●	☒	●		Oil level detective circuit error Magnet switch error Overcurrent relay operation	I/F MG-SW Overcurrent relay
L03	—	—	☒	●	☒	SIM	Indoor center unit duplicated	Indoor
L04	L04	—	☒	○	☒	SIM	Outdoor line address duplicated	I/F
L05	—	—	☒	●	☒	SIM	Duplicated indoor units with priority (Displayed in indoor unit with priority)	I/F
L06	L06	No. of indoor units with priority	☒	●	☒	SIM	Duplicated indoor units with priority (Displayed in unit other than indoor unit with priority)	I/F
L07	—	—	☒	●	☒	SIM	Group line in individual indoor unit	Indoor
L08	L08	—	☒	●	☒	SIM	Indoor group/Address unset	Indoor, I/F
L09	—	—	☒	●	☒	SIM	Indoor capacity unset	Indoor
L10	L10	—	☒	○	☒	SIM	Outdoor capacity unset	I/F
L20	L20	—	☒	○	☒	SIM	Duplicated central control addresses	Indoor
L28	L28	—	☒	○	☒	SIM	Over No. of connected outdoor units	I/F
L29	L29	:01: IPDU1 error :02: IPDU2 error :03: IPDU3 error :04: Fan IPDU error :05: IPDU1 + Fan IPDU error :06: IPDU2 + Fan IPDU error :07: All IPDU error	☒	○	☒	SIM	No. of IPDU error	I/F
L30	L30	Detected indoor address	☒	○	☒	SIM	Indoor outside interlock	Indoor
—	L31	—	—	—	—		Extended I/C error	I/F

Check code		Wireless remote controller				Check code name	Judging device	
Main remote controller display	Outdoor 7-segment display		Sensor block display of receiving unit					
	Auxiliary code		Operation	Timer	Ready			Flash
P01	—	—	●	☒	☒	ALT	Indoor fan motor error	Indoor
P03	P03	—	☒	●	☒	ALT	Discharge temp. TD1 error	I/F
P04	P04	01: Comp. 1 side 02: Comp. 2 side	☒	●	☒	ALT	High-pressure SW system operation	IPDU
P05	P05	01: Phase-missing detection 02: Phase error	☒	●	☒	ALT	Phase-missing detection /Phase error	I/F
P07	P07	01: Comp. 1 side 02: Comp. 2 side	☒	●	☒	ALT	Heat sink overheat error	IPDU, I/F
P10	P10	Detected indoor address	●	☒	☒	ALT	Indoor overflow error	Indoor
P12	—	—	●	☒	☒	ALT	Indoor fan motor error	Indoor
P13	P13	—	●	☒	☒	ALT	Outdoor liquid back detection error	I/F
P15	P15	01: TS condition 02: TD condition	☒	●	☒	ALT	Gas leak detection	I/F
P17	P17	—	☒	●	☒	ALT	Discharge temp. TD2 error	I/F
P19	P19	Detected outdoor unit number	☒	●	☒	ALT	4-way valve inverse error	I/F
P20	P20	—	☒	●	☒	ALT	High-pressure protective operation	I/F
P22	P22	0 — : IGBT short 1 — : Fan motor position detective circuit error 3 — : Fan motor trouble C — : TH sensor temp. error (Heat sink overheat) D — : TH sensor error E — : Vdc output error	☒	●	☒	ALT	Outdoor fan IPDU error	IPDU
P26	P26	01: Comp. 1 side 02: Comp. 2 side	☒	●	☒	ALT	G-TR short protection error	IPDU
P29	P29	01: Comp. 1 side 02: Comp. 2 side	☒	●	☒	ALT	Comp position detective circuit system error	IPDU
P31	P31	—	☒	●	☒	ALT	Other indoor unit error (Group terminal unit error)	Indoor

Error detected by TCC-LINK central control device

Check code		Wireless remote controller				Check code name	Judging device	
Central control device indication	Outdoor 7-segment display		Sensor block display of receiving unit					
	Auxiliary code		Operation	Timer	Ready			Flash
C05	—	—	—				Sending error in TCC-LINK central control device	TCC-LINK
C06	—	—	—				Receiving error in TCC-LINK central control device	TCC-LINK
C12	—	—	—				Batch alarm of general-purpose equipment control interface	General-purpose equipment I/F
P30	Differs according to error contents of unit with occurrence of alarm		—				Group control branching unit error	TCC-LINK
	—	—	(L20 is displayed.)				Duplicated central control addresses	

The check code

1. The TCC LINK check code

The displaying method of the check code.

TCC Link		Display	Classification
Used characters	Alphabet + Decimal notation, 2 digits	A	Unused
Characteristics of code classification	Many classification of communication/incorrect setup system	C	Central control system error
Block display	Communication/Incorrect setup (4 ways), Indoor protection, Outdoor protection, Sensor, Compressor protection, etc.	E	Communication system error
		F	Each sensor error (Failure)
		H	Compressor protective system error
		J	Unused
		L	Setup error, Other errors
		P	Protective device operation

< Display in wired remote controller >

- [△] goes on.
- [UNIT No.] + Check code + Operation lamp (Green) flash

<Display on sensor part in wireless remote controller>

- Block display of combination of [⏻] [⊖] [⊗]

<Display on 7-segment in outdoor unit>

- Unit No. and check code are displayed.
- In a case of error with auxiliary code, the check code and the auxiliary code are displayed alternately.

2. Special mention

- The check code of the remote controller is displayed only while the air conditioner is operating (Remote controller start button ON).

When the air conditioner stopped and the error has been cleared, the check code display on the remote controller also disappears.

However, if the error continues after stop of the operation, the check code is immediately displayed with restarting of the operation.

7-3. Troubleshooting by Check Display on Remote Controller

In case of wired remote controller (RBC-AMT31E)

1. Confirmation and check

When a trouble occurred on the air conditioner, the check code and the indoor unit No. are displayed on the display section of the remote controller.

The check code is displayed while the air conditioner operates.

If the display disappeared, operate the air conditioner and check the error based upon the following "Confirmation of error history".

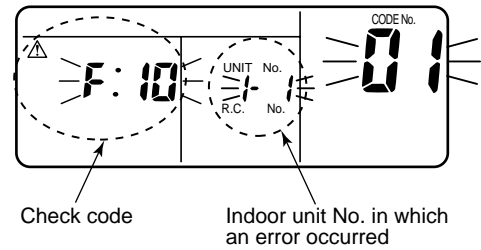

2. Confirmation of error history

When a trouble occurred on the air conditioner, the error history can be confirmed with the following procedure.

(Up to 4 error histories are stored in memory.)

This history can be confirmed from either operating status or stop status.

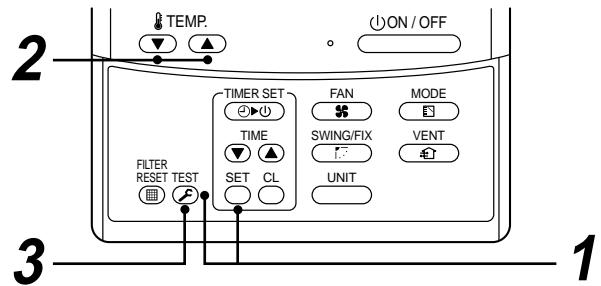

Procedure	Description
1	<p>When pushing SET and TEST buttons simultaneously for 4 seconds or more, the below display appears.</p> <p>If [Service Check] is displayed, the mode enters in the error history mode.</p> <ul style="list-style-type: none"> • [01: Error history order] is displayed in code number window. • [Check Code] is displayed in check code window. • [Indoor unit address with error] is displayed in UNIT No.
2	<p>Every pushing temp. set ▼ / ▲ buttons, the error histories stored in the memory are displayed in order.</p> <p>The numbers in item code indicates item code [01] (Latest) to [04] (Oldest).</p> <p>CAUTION</p> <p>Do not push [CL] button because all the error histories of the indoor unit will be deleted.</p>
3	<p>After confirmation, push TEST button to return to the usual display.</p>

In case of central remote controller (TCB-SC642TLE)

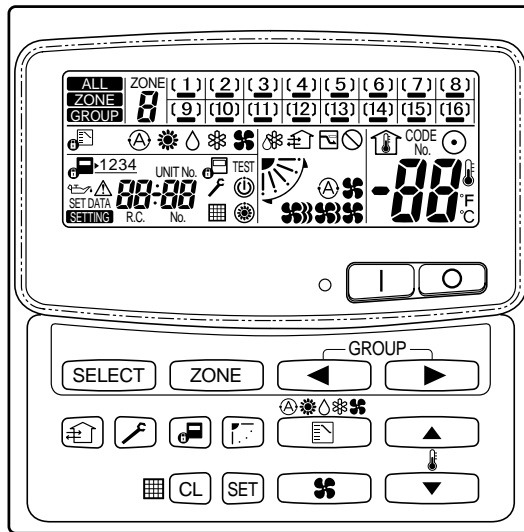

1. Confirmation and check

When a trouble occurred on the air conditioner, the check code and the indoor unit No. are displayed on the display section of the remote controller.

The check code is displayed while the air conditioner operates.

If the display disappeared, operate the air conditioner and check the error based upon the following "Confirmation of error history".

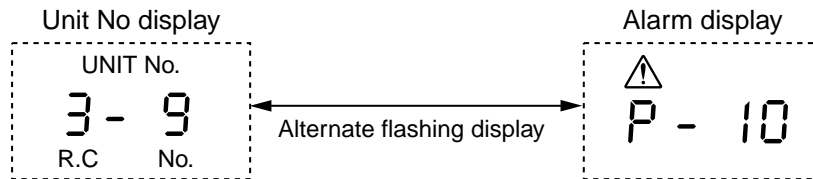

2. Confirmation of error history

When a trouble occurred on the air conditioner, the error history can be confirmed with the following procedure. (Up to 4 error histories are stored in memory.)

This history can be confirmed from either operating or stop.

- 1) Push and buttons in succession for 4 seconds or more.
- 2) SERVICE CHECK goes on and Item code 01 goes on.
- 3) When selecting (flash) the group number if there is the alarm history, the UNIT number and the latest alarm history are displayed alternately.
 - * In this time, the temperature cannot be set up.
- 4) To confirm the alarm history other than the latest one, push temp. set / to select Item code (01 to 04).
- 5) To confirm the alarm in the other group, push and / to select the group number. Do not push button because all the alarm histories of the currently selected group are deleted.
- 6) To finish the service check, push button.

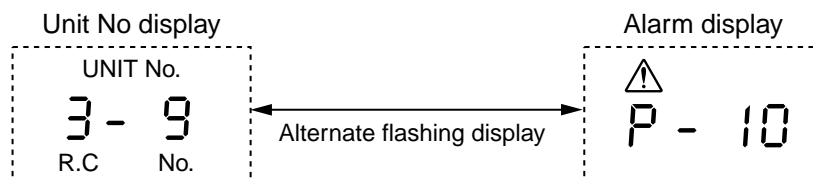

7-4. Check Code and Check Position Displayed on the Remote Controller and Outdoor Unit (7-Segment Display of Interface)

Check code			Detected position	Check code name	Status	Error detection condition	Check item (position)
Main remote controller	Outdoor 7-segment display						
	Check code	Auxiliary code					
E01	—	—	Remote controller	Communication error between indoor and remote controller (Detected at remote controller side)	Corresponding unit only stops.	Communication interrupted between indoor P.C. board and remote controller.	<ul style="list-style-type: none"> • Check remote controller inter-unit cable (A/B). • Check disconnection, connector contact error. • Check indoor power supply. • Check indoor P.C. board error. • Check remote controller address setup. (When two remote controllers operate) • Check remote controller P.C. board.
E02	—	—	Remote controller	Remote controller sending error	Corresponding unit only stops.	Signal could not be sent from remote controller to indoor unit.	<ul style="list-style-type: none"> • Check the communication wire of remote controller: Exchange remote controller.
E03	—	—	Indoor unit	Communication error between indoor and remote controller (Detected at indoor side)	Corresponding unit only stops.	No communication from remote controller (including wireless) and communication adapter.	<ul style="list-style-type: none"> • Check remote controller and communication adapter wiring.
E04	—	—	Indoor unit	Indoor/outdoor communication circuit error (Detected at indoor side)	Corresponding unit only stops.	Indoor unit does not receive communication from outdoor unit.	<ul style="list-style-type: none"> • Check power-ON order of indoor/outdoor. • Check indoor address setup. • Check inter-unit cabling between indoor and outdoor. • Check outdoor end terminal resistance setup (SW30-2).
E06	E06	No. of indoor units which received signal normally	I/F	Decreased number of indoor units	All stop	When signal is not sent for a certain period from the indoor unit which has been used to send signals, [E06] is normally displayed.	<ul style="list-style-type: none"> • Check the power supply of indoor unit. (Power-ON) • Check connection of communication line between indoor and outdoor. • Check connector connection for communication in indoor P.C. board. • Check connector connection for communication in outdoor P.C. board. • Check indoor P.C. board failure. • Check outdoor P.C. board (I/F) failure.
—	E07	—	I/F	Indoor/outdoor communication circuit error (Detected at outdoor side)	All stop	Transmission from outdoor to indoor cannot continue for 30 seconds.	<ul style="list-style-type: none"> • Check outdoor terminator resistor setup (SW30-2). • Check the communication connection between indoor and outdoor.
E08	E08	Duplicated indoor addresses	Indoor I/F	Duplicated indoor addresses	All stop	Multiple indoor unit address setup are duplicated.	<ul style="list-style-type: none"> • Check indoor address. • Check the change of remote controller connection (Group / individual) after setup of indoor address.
E09	—	—	Remote controller	Duplicated master remote controllers	Corresponding unit only stops.	In 2-remote controller control (including wireless), both are setup as master (Header indoor unit stops and other indoor unit is operating.)	<ul style="list-style-type: none"> • Check remote controller setup. • Check remote controller P.C. board.
E10	—	—	Indoor unit	Communication error between indoor P.C. board assembly	Corresponding unit only stops.	There is any trouble in power line.	<ul style="list-style-type: none"> • Indoor P.C. board failure

Main remote controller	Check code		Detected position	Check code name	Status	Error detection condition	Check item (position)
	Outdoor 7-segment display						
	Check code	Auxiliary code					
E12	E12	01: Indoor/outdoor communication 02: Between outdoors communication	I/F	Automatic address start error	All stop	<ul style="list-style-type: none"> When indoor automatic address started, other refrigerant circuit system was setting automatic address. When outdoor automatic address started, indoor automatic address was executed. 	<ul style="list-style-type: none"> Setup the address again after disconnecting communication connection with other refrigerant circuit system.
E15	E15	—	I/F	No corresponding indoor unit during automatic address	All stop	Indoor unit is not found when indoor automatic address start was set up.	<ul style="list-style-type: none"> Check the communication line connection between indoor and outdoor. Check the electric power line error in indoor. Check the noise of surrounding devices. Power failure Check indoor P.C. board error.
E16	E16	00: Capacity over 01 to: No. of connected units	I/F	No. of connected indoor units / Capacity over	All stop	<ul style="list-style-type: none"> Total capacity of indoor units exceeded 135% of total outdoor capacity. No. of connected indoor units are more than 48 units. <p>[Note] If this code appears after backup setup of outdoor unit trouble, set up "No. capacity-over detection". <Setup method of "No. capacity-over detection"> Turn on SW09/Bit 2 on I/F P.C. board of outdoor header unit.</p>	<ul style="list-style-type: none"> Check the connection capacity of indoor unit. Check the HP capacity of indoor unit. Check the indoor/outdoor capacity setup Check the No. of connected indoor units. Check the outdoor I/F P.C. board error
E18	—	—	Indoor unit	Communication error between indoor header and follower units	Corresponding unit only stops.	Regular communication between indoor header and follower units	<ul style="list-style-type: none"> Check cable of the remote controller. Check power cabling of indoor. Check P.C. board of indoor.
E19	E19	00: No header unit 02: Two or more header units	I/F	Outdoor unit quantity error	All stop	<ul style="list-style-type: none"> There are multiple outdoor units in 1 line. There is none of outdoor unit in 1 line. 	<ul style="list-style-type: none"> The outdoor unit connected with communication cable between indoor and outdoor (U1.U2) is the outdoor unit. Check connection of communication line between indoor and outdoor. Check outdoor P.C. board(I/F) error.
E20	E20	01: Connection of outdoor of other line 02: Connection of indoor of other line	I/F	Other line unit connected during automatic address	All stop	Unit of other line was connected when indoor automatic address started.	Separate the cable between lines according to automatic address setup method in "Address setup".
E23	E23	—	I/F	Communication sending error between outdoor units	All stop	Transmission of other outdoor unit was unavailable for 30 seconds or more.	In this model, only one outdoor unit is provided to one refrigerant line. Be sure to check there is no communication connection with outdoor unit in the other refrigerant line.
E25	E25	—	I/F	Duplicated outdoor follower address setup	All stop	Outdoor addresses manually set up are duplicated.	Note) Do not set up the outdoor address manually.
E26	E26	No. of normally received outdoor units	I/F	Decreased number of connected outdoor units	All stop	The signal was not returned for constant from the outdoor unit which was receiving signal.	In this model, only one outdoor unit is provided to one refrigerant line. Be sure to check there is no communication connection with outdoor unit in the other refrigerant line.
E28	E28	No. of detected outdoor units	I/F	Outdoor follower unit error	All stop	Outdoor header unit received error code from outdoor follower unit.	<ul style="list-style-type: none"> Check the check code of outdoor follower unit.

<Convenient functions>

When pushing SW04 for 1 second or more under condition that [E28] is displayed on 7-segment display of outdoor header unit, the fan of outdoor unit which stopped abnormally starts rotating.
If pushing SW04 and SW05 simultaneously, the fan of normal outdoor unit operates.
When pushing SW05 singly, the operation of fan is cleared.

Main remote controller	Check code		Detected position	Check code name	Status	Error detection condition	Check item (position)
	Outdoor 7-segment display						
	Check code	Auxiliary code					
E31	E31	01: IPDU1 error 02: IPDU2 error 03: IPDU1, 2 errors 04: Fan IPDU error 05: IPDU1 + Fan IPDU error 06: IPDU2 + Fan IPDU error 07: All IPDU error or communication error between IPDU and I/F P.C. board or outdoor I/F P.C. board error	I/F	IPDU communication error	All stop	Communication of each IPDU (P.C. board) in inverter box interrupted.	<ul style="list-style-type: none"> • Check connection of communication connector and disconnection between IPDU and I/F P.C. board. • Check outdoor P.C. board (I/F, IPDU, Fan IPDU) error. • Check external noise. • Check power supply P.C. board for fan error.
F01	—	—	Indoor unit	Indoor TCJ sensor error	Corresponding unit only stops.	<ul style="list-style-type: none"> • Resistance value of sensor is infinite or zero (Open/Short) 	<ul style="list-style-type: none"> • Check connection/cablings of TCJ sensor connector. • Check characteristics of TCJ sensor resistance value. • Check indoor P.C. board error.
F02	—	—	Indoor unit	Indoor TC2 sensor error	Corresponding unit only stops.	<ul style="list-style-type: none"> • Resistance value of sensor is infinite or zero (Open/Short). 	<ul style="list-style-type: none"> • Check connection/cablings of TC2 sensor connector. • Check characteristics of TC2 sensor resistance value. • Check indoor P.C. board error.
F03	—	—	Indoor unit	Indoor TC1 sensor error	Corresponding unit only stops.	<ul style="list-style-type: none"> • Resistance value of sensor is infinite or zero (Open/Short). 	<ul style="list-style-type: none"> • Check connection/cablings of TC1 sensor connector. • Check characteristics of TC1 sensor resistance value. • Check indoor P.C. board error.
F04	F04	—	I/F	TD1 sensor error	All stop	<ul style="list-style-type: none"> • Resistance value of sensor is infinite or zero (Open/Short) 	<ul style="list-style-type: none"> • Check connection of TD1 sensor connector. • Check characteristics of TD1 sensor resistance value. • Check outdoor P.C. board (I/F) error.
F05	F05	—	I/F	TD2 sensor error	All stop	<ul style="list-style-type: none"> • Resistance value of sensor is infinite or zero (Open/Short) 	<ul style="list-style-type: none"> • Check connection of TD2 sensor connector. • Check characteristics of TD2 sensor resistance value. • Check outdoor P.C. board (I/F) error.
F06	F06	—	I/F	TE1 sensor error	All stop	<ul style="list-style-type: none"> • Resistance value of sensor is infinite or zero (Open/Short). 	<ul style="list-style-type: none"> • Check connection of TE1 sensor connector. • Check characteristics of TE1 sensor resistance value. • Check outdoor P.C. board (I/F) error.
F07	F07	—	I/F	TL sensor error	All stop	<ul style="list-style-type: none"> • Resistance value of sensor is infinite or zero (Open/Short). 	<ul style="list-style-type: none"> • Check connection of TL sensor connector. • Check characteristics of TL sensor resistance value. • Check outdoor P.C. board (I/F) error.
F08	F08	—	I/F	TO sensor error	All stop	<ul style="list-style-type: none"> • Resistance value of sensor is infinite or zero (Open/Short). 	<ul style="list-style-type: none"> • Check connection of TO sensor connector. • Check characteristics of TO sensor resistance value. • Check outdoor P.C. board (I/F) error.
F10	—	—	Indoor	Indoor TA sensor error	Corresponding unit only stops.	<ul style="list-style-type: none"> • Resistance value of sensor is infinite or zero (Open/Short). 	<ul style="list-style-type: none"> • Check connection/cablings of TA sensor connector. • Check characteristics of TA sensor resistance value. • Check indoor P.C. board error.
F12	F12	01: TS1 02: TS2	I/F	TS1, TS2 sensor error	All stop	<ul style="list-style-type: none"> • Resistance value of sensor is infinite or zero (Open/Short). 	<ul style="list-style-type: none"> • Check connection of TS1 or TS2 sensor connector. • Check characteristics of TS1, TS2 sensor resistance value. • Check outdoor P.C. board (I/F) error.

Main remote controller	Check code		Detected position	Check code name	Status	Error detection condition	Check item (position)
	Outdoor 7-segment display						
	Check code	Auxiliary code					
F13	F13	01: Compressor 1 side 02: Compressor 2 side	IPDU	TH sensor error	All stop	<ul style="list-style-type: none"> Resistance value of sensor is infinite or zero (Open/Short). 	<ul style="list-style-type: none"> IGBT built-in temp sensor error → Exchange IPDU P.C. board.
F15	F15	—	I/F	Outdoor temp sensor miscabling (TE1, TL)	All stop	During operation of compressor in HEAT mode, the TE1 detection temp was higher than that of TL by the specified value continued for 3 minutes or more.	<ul style="list-style-type: none"> Check installation of TE1 sensor and TL sensor. Check characteristics of TE1 and TL sensor resistance value. Check outdoor P.C. board (I/F) error.
F16	F16	—	I/F	Outdoor pressure sensor miscabling (Pd, Ps)	All stop	High-pressure Pd sensor and low-pressure Ps sensor were exchanged, or output voltages of both sensors are zero.	<ul style="list-style-type: none"> Check connection of high-pressure Pd sensor connector. Check connection of low-pressure Ps sensor connector. Check pressure sensors Pd and Ps error. Check outdoor P.C. board (I/F) error. Check compression error of compressor.
F23	F23	—	I/F	Ps sensor error	All stop	Output voltage of Ps sensor was zero.	<ul style="list-style-type: none"> Misconnection of Ps sensor and Pd sensor connectors Check connection of Ps sensor connector. Check Ps sensor error. Check compression error of compressor. Check 4-way valve error. Check outdoor P.C. board (I/F) error. Check SV4 circuit error.
F24	F24	—	I/F	Pd sensor error	All stop	Output voltage of Pd sensor was zero. (Sensor Open) Pd > 4.15MPa during stop of compressor	<ul style="list-style-type: none"> Check connection of Pd sensor connector. Check Pd sensor error. Check outdoor P.C. board (I/F) error.
F29	—	—	Indoor	Indoor other error	Corresponding unit only stops.	Indoor P.C. board did not operate normally.	<ul style="list-style-type: none"> Check indoor P.C. board error (EEPROM error).
F31	F31	—	I/F	Outdoor EEPROM error	All stop (*1)	Outdoor P.C. board (I/F) did not operate normally.	<ul style="list-style-type: none"> Check power voltage. Check power noise. Check outdoor P.C. board (I/F) error.
H01	H01	01: Compressor 1 side 02: Compressor 2 side	IPDU	Compressor breakdown	All stop	Inverter current detection circuit detected over-current and stopped.	<ul style="list-style-type: none"> Check power voltage. (AC220–240V ± 10%). Check compressor error. Check cause of abnormal overload operation. Check outdoor P.C. board (IPDU) error.
H02	H02	01: Compressor 1 side 02: Compressor 2 side	IPDU	Compressor error (lock) MG-SW error OCR operation	All stop	Over-current was detected several seconds after header compressor had started.	<ul style="list-style-type: none"> Check compressor error. Check power voltage. (AC380–10%, 415V +10%). Check cable of compressor and phase-missing. Check connector/terminal connection on IPDU P.C. board. Check conduction of case heater. (Check activation error due to liquid stagnation in compressor.) Check outdoor P.C. board (IPDU) error. Check outdoor MG-SW or OCR.

(*1) All stop only in case of the header unit The follower unit continues operation.

MG-SW : Magnet Switch, OCR : Over-current Relay

Check code			Detected position	Check code name	Status	Error detection condition	Check item (position)
Main remote controller	Outdoor 7-segment display						
	Check code	Auxiliary code					
H03	H03	01: Compressor 1 side 02: Compressor 2 side	IPDU	Current detection circuit system error	All stop	While header compressor stopped, current flowed more than the specified current and was detected.	<ul style="list-style-type: none"> • Check cabling of current detection circuit system. • Check outdoor P.C. board (IPDU) error.
H04	H04	—	I/F	Compressor 1 case thermo operation	All stop	Compressor 1 case thermostat performed protective operation.	<ul style="list-style-type: none"> • Check compressor 1 case thermo circuit. (Connector, cable, P.C. board) • Check full opening of service valve. (Gas and liquid side) • Check outdoor PMV clogging. (PMV1, 2, 3) • Check SV41 circuit leakage. • Check miscabling/misinstallation of SV41 and SV42. • Check valve open status of indoor PMV. • Check 4-way valve error. • Check refrigerant shortage. • Check SV5 leak. • Check SV11 circuit. (Wiring, OFF at one side only) • Check mispiping of discharge gas/suction gas main pipe. • Check Flow selector unit. <p>Check leakage of SVD valve and SVS valve. (Check leakage of SVDD valve and SVSS.)</p> <p>Check mispiping of FS unit connecting pipe (Suction gas/Discharge gas), wiring between FS unit and indoor unit, and connection of connectors.</p> <p>Check miswiring of SVS/SVD valves.</p>
H06	H06	—	I/F	Low-pressure protective operation	All stop	Low-pressure Ps detected operation lower than 0.02MPa.	<ul style="list-style-type: none"> • Check full opening of service valve. (Discharge gas, suction gas and liquid side) • Check outdoor PMV clogging. (PMV1, 2) • Check SV2 circuit and SV4 circuit error. • Check low-pressure Ps sensor error. • Check indoor air filter clogging. • Check valve open of indoor PMV. • Check refrigerant pipe clogging. • Check outdoor fan operation. (All heating, mainly heating, part cooling operation) • Check refrigerant shortage. • Check clogging of circuit at auxiliary heat exchanger side. (PMV3, SV12, check valve) • Check 4-way valve error. (Reversal error) • Check mispiping of discharge gas/suction gas main pipe. • Check Flow selector unit. <p>Check miswiring of discharge gas/suction gas pipe to FS unit.</p> <p>Check wiring between FS unit and indoor unit.</p> <p>Check miswiring of SVD/SVS valves, misinstallation of coil.</p> <p>Check opened status of SVS valve.</p>

Main remote controller	Check code		Detected position	Check code name	Status	Error detection condition	Check item (position)
	Outdoor 7-segment display						
	Check code	Auxiliary code					
H07	H07	—	I/F	Protection for oil level drop detection	All stop	The operating compressor detected oil shortage continuously for 2 hours.	<p><Check all the outdoor units in the corresponding line.></p> <ul style="list-style-type: none"> • Check full opening of service valve of balance pipe. • Check connection and installation of TK1, TK2, TK3, and TK4 sensors. • Check characteristics of TK1, TK2, TK3, and TK4 resistance values. • Check gas leak and oil leak in the same line. • Check refrigerant stagnation in compressor. • Check error of SV3A, SV3B, SV3C, SV3D, and SV3E valves. • Check clogging of oil separator oil return circuit. • Check clogging of oil-equation circuit. <p><Check clogging of oil equation pipe between compressors.></p> <ul style="list-style-type: none"> • Check TS1, TS2 sensors (Miswiring and misinstallation of TS1 and TS2) • Check leakage of SV6 circuit. • Check FS unit. <p>Leakage of check valve of bypass between liquid pipe and discharge gas pipe Misrouting of discharge/suction gas connection Miswiring of SVD/SVS valve/Misinstallation of coil</p> <ul style="list-style-type: none"> • Check whether there is no setup missing of indoor unit in all cooling operation mode
H08	H08	01: TK1 sensor error 02: TK2 sensor error 03: TK3 sensor error 04: TK4 sensor error	I/F	Oil level detective temp sensor error	All stop	• Resistance value of sensor is infinite or zero. (Open/Short)	<ul style="list-style-type: none"> • Check connection of TK1 sensor connector. • Check characteristics of TK1 sensor resistance value. • Check outdoor P.C. board (I/F) error.
					All stop	• Resistance value of sensor is infinite or zero. (Open/Short)	<ul style="list-style-type: none"> • Check connection of TK2 sensor connector. • Check characteristics of TK2 sensor resistance value. • Check outdoor P.C. board (I/F) error.
					All stop	• Resistance value of sensor is infinite or zero. (Open/Short)	<ul style="list-style-type: none"> • Check connection of TK3 sensor connector. • Check characteristics of TK3 sensor resistance value. • Check outdoor P.C. board (I/F) error.
					All stop	• Resistance value of sensor is infinite or zero. (Open/Short)	<ul style="list-style-type: none"> • Check connection of TK4 sensor connector. • Check characteristics of TK4 sensor resistance value. • Check outdoor P.C. board (I/F) error.
H14	H14	—	I/F	Compressor 2 case thermo operation	All stop	Compressor 2 case thermostat operated.	<ul style="list-style-type: none"> • Check compressor 2 case thermo circuit. (Connector, cable, P.C. board) • Check full opening of service valve. (Gas and liquid side) • Check outdoor PMV clogging. (PMV1, 2) • Check SV42 valve leak. • Check miscabling/misinstallation of SV41 and SV42. • Check valve opening of indoor PMV. • Check 4-way valve error. • Check refrigerant shortage. • Check SV11 circuit. (Wiring, OFF at one side only) • Check misrouting of discharge gas/suction gas main pipe. • Check Flow selector unit. <p>Check leakage of SVD valve and SVS valve. (Check leakage of SVDD valve and SVSS.) Check misrouting of FS unit connecting pipe (Suction gas/Discharge gas), wiring between FS unit and indoor unit, and connection of connectors. Check miswiring of SVS/SVD valves.</p>

Main remote controller	Check code		Detected position	Check code name	Status	Error detection condition	Check item (position)
	Outdoor 7-segment display						
	Check code	Auxiliary code					
H16	H16	01: TK1 oil circuit system error 02: TK2 oil circuit system error 03: TK3 oil circuit system error 04: TK4 oil circuit system error	I/F	Oil level detective circuit system error MG-SW error OCR operation	All stop	Temperature change of TK1 could not be detected though compressor 1 started the operation.	<ul style="list-style-type: none"> • Check TK1 sensor coming-off. • Check characteristics of TK1 sensor resistance value. • Check TK1, TK2, TK3, and TK4 misconnection. • Check operation error of SV3E valve. • Check capillary clogging of oil-equation circuit and operation error of stop valve. • Check refrigerant stagnation in compressor. • Check MG-SW or OCR.
						Temperature change of TK2 could not be detected though compressor 2 started the operation.	<ul style="list-style-type: none"> • Check TK2 sensor coming-off. • Check characteristics of TK2 sensor resistance value. • Check TK1, TK2, TK3, and TK4 misconnection. • Check SV3E valve operation. • Check capillary clogging of oil equalization circuit and check stop valve operation. • Check refrigerant stagnation in compressor shell. • Check MG-SW or OCR.
						Temperature change of TK3 could not be detected though compressor started the operation.	<ul style="list-style-type: none"> • Check TK3 sensor coming-off. • Check characteristics of TK3 sensor resistance value. • Check TK1, TK2, TK3, and TK4 misconnection. • Check SV3E valve operation. • Check capillary clogging of oil-equalization circuit and check valve operation. • Check refrigerant stagnation in compressor shell. • Check MG-SW or OCR.
						Temperature change of TK4 could not be detected though compressor started the operation, or the difference from other TK sensor changed for a constant time only within the specified range.	<ul style="list-style-type: none"> • Check TK4 sensor coming-off. • Check characteristics of TK4 sensor resistance value. • Check TK1, TK2, TK3, and TK4 misconnection. • Check SV3E valve operation. • Check capillary clogging of oil-equalization circuit and check valve operation. • Check refrigerant stagnation in compressor shell. • Check MG-SW or OCR.
L03	—	—	Indoor	Duplicated indoor center units	Corresponding unit only stops.	There are multiple center units in a group.	<ul style="list-style-type: none"> • Check indoor address. • Check the change of remote controller connection (Group/individual) after indoor address setup.
L04	L04	—	I/F	Duplicated outdoor line address	All stop	Line address setup is duplicated against the outdoor unit in different refrigerant pipe system.	<ul style="list-style-type: none"> • Check line address.
L05	—	—	I/F	Duplicated indoor units with priority (Displayed on indoor unit with priority)	All stop	Indoor units with priority were duplicated.	<ul style="list-style-type: none"> • Check display of indoor unit with priority.

Main remote controller	Check code		Detected position	Check code name	Status	Error detection condition	Check item (position)
	Outdoor 7-segment display						
	Check code	Auxiliary code					
L06	L06	No. of indoor units with priority	I/F	Duplicated indoor units with priority (Displayed on the unit other than indoor unit with priority)	All stop	Indoor units with priority were duplicated.	• Check display of indoor unit with priority and outdoor unit.
L07	—	—	Indoor	Group line in individual indoor unit.	Corresponding unit only stops.	At least one indoor unit connected to a group existed in the individual indoor units.	• Check indoor address.
L08	L08	—	Indoor	Indoor group / address unset	Corresponding unit only stops.	Address was not yet set up.	• Check indoor address. Note) After installation, this code is displayed when the power is firstly turned on.
L09	—	—	Indoor	Indoor capacity unset	Corresponding unit only stops.	Indoor unit capacity was unset.	Set up indoor capacity. (DN=11)
L10	L10	—	I/F	Outdoor capacity unset	All stop	On the I/F P.C. board for service, jumper line was not cut according to the model.	Check model setup on outdoor I/F P.C. board Assy for service.
L17	L17	—	I/F	Inconsistent models of outdoor units		Outdoor units of 1 series and those of 2 series were mixed.	• Check outdoor units.
L18	L18	Corresponding indoor address	I/F	FS unit system error	Corresponding unit only stops.	An indoor unit which is not connected with FS unit is driving without setup for cooling only mode.	• Check setup of remote controller (DN=[OFF]). • Check FS unit. Check pipe connection to FS unit. (Mis piping between discharge gas and suction gas) Check miswiring/misinstallation of SVS/SVD valves.
L20	—	—	Indoor	Duplicated central control addresses	All stop	Duplicated central control addresses	• Check central control address. • Check network adaptor P.C. board. (In case of AI-NET)
L28	L28	—	I/F	Quantity over of connected outdoor units	All stop	There were more than four outdoor units.	• Check No. of connected outdoor units. (Max. 4 units per 1 system) • Check communication line between outdoor units. • Check outdoor P.C. board (I/F) error.
L29	L29	01: IPDU1 error 02: IPDU2 error 03: IPDU1, 2 errors 04: Fan IPDU error 05: IPDU1 + Fan IPDU error 06: IPDU2 + Fan IPDU error 07: All IPDU error or communication error between IPDU and I/F P.C. board, or outdoor I/F P.C. board error	I/F	IPDU quantity error	All stop	No. of IPDU units detected when power was turned on were less.	• Check model setup for outdoor I/F service P.C. board. • Check connection of UART communication connector. • Check IPDU, fan IPDU, and I/F P.C. board error. Note) UART: Universal Asynchronous Receiver Transmitter
L30	L30	Detected indoor address	Indoor	Interlock in indoor unit from outside	Corresponding unit only stops.	• Outside error input terminal Detected signal to (CN80) for more 1 minute	■ Outside device is connected to connector (CN80): 1) Check outside device error. 2) Check indoor P.C. board error. ■ Outside device is not connected to connector (CN80): 1) Check indoor P.C. board error. Check indoor (I/F) P.C. board.
—	L31	—	I/F	Extended IC (Integrated Circuit) error	Operation continues.	P.C. board (I/F) parts error	Check indoor (I/F) P.C. board.

Main remote controller	Check code		Detected position	Check code name	Status	Error detection condition	Check item (position)
	Outdoor 7-segment display						
	Check code	Auxiliary code					
P01	—	—	Indoor	Indoor fan motor error	Corresponding unit only stops.		<ul style="list-style-type: none"> • Check the lock of fan motor (AC fan). • Check cabling.
P03	P03	—	I/F	Discharge temp TD1 error	All stop	Discharge temp (TD1) exceeded 115°C.	<ul style="list-style-type: none"> • Check full opening of outdoor service valves (Gas side, Liquid side). • Check clogging of outdoor PMV. (PMV1,2) • Check characteristics of TD1 sensor resistance value. • Check refrigerant shortage. • Check 4-way valve error. • Check leakage of SV41 circuit. • Check SV4 circuit. (Miswiring and misinstallation of SV41 and SV42) • Check leakage of SV5 circuit. • Check leakage of SV6 circuit. (Capillary clogging, valve operation error) • Check mispiping of discharge gas/suction gas main pipe. • Check Flow selector unit. • Check leakage of SVD valve and SVS valve. (Check leakage of SVDD valve and SVSS.) • Check mispiping of FS unit connecting pipe (Suction gas/Discharge gas), wiring between FS unit and indoor unit, and connection of connectors. • Check miswiring of SVS/SVD valves.
P04	P04	01: Compressor 1 side 02: Compressor 2 side	I/F	Actuation of high-pressure SW	All stop	High-pressure SW actuated.	<ul style="list-style-type: none"> • Check Pd pressure sensor error. • Check full opening of outdoor service valves (Gas side, Liquid side). • Check outdoor fan error. • Check outdoor fan motor error. • Check clogging of outdoor PMV. (PMV1,2) • Check clogging of indoor/outdoor heat exchangers. • Check short-circuiting of outdoor suction/discharge air. • Check clogging of SV2 circuit. • Check outdoor P.C. board (I/F) error. • Check indoor fan system error. (Cause of air volume decrease) • Check opening of indoor PMV. • Check miscabling of communication line between indoor and outdoor. • Check operation error of check valve of discharge pipe. • Check SV4 valve circuit. • Check SV5 valve circuit. • Check refrigerant overcharge. • Check mispiping of discharge gas/suction gas main pipe. • Check circuit clogging at auxiliary heat exchanger side. (PMV3, SV12, check valve) • Check FS unit. • Check clogging of SVD valve and operation error. • Check wiring inside of FS unit. (SVD/SVS coil miswiring, etc.) • Check wiring between FS unit and indoor unit. (Miswiring, Disconnection, Wiring missing)
P05	P05	01: Power supply open phase 02: Power supply negative phase	I/F	Open phase negative phase	All stop	<ul style="list-style-type: none"> • Open phase was detected when the power turned on. • Negative phase was detected when the power turned on. 	<ul style="list-style-type: none"> • Check outdoor power line. • Check outdoor P.C. board (I/F) error.

Main remote controller	Check code		Detected position	Check code name	Status	Error detection condition	Check item (position)
	Outdoor 7-segment display						
	Check code	Auxiliary code					
P07	P07	01: Compressor 1 side 02: Compressor 2 side	IPDU I/F	Heat sink overheat error	All stop	IGBT built-in temp sensor (TH) was overheated.	<ul style="list-style-type: none"> • Check power voltage. • Check outdoor fan system error. • Check clogging of heat sink cooling duct. • Check fixation between IGBT and heat sink. (Check screwing and contact.) • Check IPDU error.(IGBT built-in temp sensor (TH) error).
P10	P10	Indoor address with trouble	Indoor	Indoor overflow error	All stop	<ul style="list-style-type: none"> • Float switch operated. • Float switch circuit disconnected or the connector came off. 	<ul style="list-style-type: none"> • Check the float switch connector. • Check operation of drain pump unit. • Check the drain pump circuit. • Check clogging of drain pipe. • Check indoor P.C. board error.
P12	—	—	Indoor	Indoor fan motor error	Corresponding unit only stops.	<ul style="list-style-type: none"> • The value of motor speed deviated from target value was detected for certain time. • Over-current protection operated. 	<ul style="list-style-type: none"> • Check connection of fan connector and wiring. • Check fan motor error. • Check indoor P.C. board error. • Check influence of outside air control. • Check indoor type code (DN=10) and the capacity code (DN=11).
P13	P13	—	I/F	Outdoor liquid back detection error	All stop	<p><In heating> While the system is operating in HEAT mode, outdoor PMV of which opening degree was 100 pulse or less for a certain time.</p>	<ul style="list-style-type: none"> • Check full close operation of outdoor PMV (1, 2). • Check Pd and Ps sensor error. • Check clogging of SV2 circuit. • Check clogging of 4-way valve error circuit. • Check outdoor P.C. board (I/F) error. • Check capillary clogging of oil return circuit from oil separator. • Check TS1, TS2 sensor error.
P15	P15	01: TS condition	I/F	Gas leak detection (TS1 condition)	All stop	<p>Suction temp exceeded the judgment standard temp for 10 minutes or more.</p> <p><TS error judgment standard temperature> In cooling operation: 60°C or higher In heating operation: 40°C or higher</p>	<ul style="list-style-type: none"> • Check refrigerant shortage. • Check full open of outdoor service valves (gas side, liquid side). • Check outdoor PMV clogging (PMV1, 2). • Check characteristics of TS1 sensor resistance value. • Check 4-way valve error. • Check leakage of SV4 circuit. • Check leakage of SV5 circuit. • Check mispiping of discharge gas/suction gas main pipe. • Check Flow selector unit. • Check leakage of SVD valve and SVS valve. (Check leakage of SVDD valve and SVSS.) • Check mispiping of FS unit connecting pipe (Suction gas/Discharge gas), wiring between FS unit and indoor unit, and connection of connectors. • Check miswiring of SVS/SVD valves.
		02: TD condition	I/F	Gas leak detection (TD condition)	All stop	<p>Discharge temperature TD1 or TD2 was continuously 108°C or higher for 10 minutes.</p>	<ul style="list-style-type: none"> • Check refrigerant shortage. • Check outdoor PMV clogging (PMV1, 2). • Check characteristics of TD1, TD2 sensor resistance value. • Check indoor air filter clogging. • Check pipe clogging. • Check SV4 circuit (Valve leakage, misinstallation) • Check mispiping of discharge gas/suction gas main pipe. • Check Flow selector unit. • Check leakage of SVD valve and SVS valve. (Check leakage of SVDD valve and SVSS.) • Check mispiping of FS unit connecting pipe (Suction gas/Discharge gas), wiring between FS unit and indoor unit, and connection of connectors. • Check miswiring of SVS/SVD valves.

Main remote controller	Check code		Detected position	Check code name	Status	Error detection condition	Check item (position)
	Outdoor 7-segment display						
	Check code	Auxiliary code					
P17	P17	—	I/F	Discharge temp TD2 error	All stop	Discharge temperature (TD2) exceeded 115°C.	<ul style="list-style-type: none"> • Check full opening of outdoor service valves (gas side, liquid side). • Check clogging of outdoor PMV (PMV1, 2). • Check characteristics of TD2 sensor resistance value. • Check 4-way valve error. • Check leakage of SV42 circuit. • Check SV4 circuit. (Miscabling and misinstallation of SV41 and SV42) • Check leakage of SV5 valve circuit. • Check SV6 circuit. (Clogging, Valve operation error) • Check mispiping of discharge gas/suction gas main pipe. • Check Flow selector unit. <p>Check leakage of SVD valve and SVS valve. (Check leakage of SVDD valve and SVSS.)</p> <p>Check mispiping of FS unit connecting pipe (Suction gas/Discharge gas), wiring between FS unit and indoor unit, and connection of connectors.</p> <p>Check miswiring of SVS/SVD valves.</p>
P19	P19	Detected outdoor unit No.	I/F	4-way valve operation error	All stop	When abnormal refrigerating cycle data was detected in heating	<ul style="list-style-type: none"> • Error of 4-way valve error. • Check coil error and connector connection of 4-way valve. • Check characteristics of TS1/TE1 sensor resistance value. • Check characteristics of Pd, Ps pressure sensor output voltage. • Check misconnection of TE1 and TL sensors. • Check Flow selector unit. <p>Check leakage of SVD valve and SVS valve. (Check leakage of SVDD valve and SVSS.)</p> <p>Check mispiping of FS unit connecting pipe (Suction gas/Discharge gas).</p>
P20	P20	—	I/F	High-pressure protective operation	All stop	Pd sensor detected 3.6MPa or more.	<ul style="list-style-type: none"> • Check Pd pressure sensor error. • Check full opening of service valves (Gas side, Liquid side). • Check outdoor fan error. • Check outdoor fan motor error. • Check clogging of outdoor PMV. (PMV1,2) • Check clogging of indoor/outdoor heat exchangers. • Check air short-circuiting in outdoor unit. • Check clogging of SV2 circuit. • Check outdoor P.C. board (I/F) error. • Check indoor fan system error. (Cause of air volume decrease) • Check valve opening of indoor PMV. • Check miscabling of communication line between indoor and outdoor. • Check operation error of check valve of discharge pipe. • Check circuit of gas balance SV4 valve. • Check mispiping of discharge gas/suction gas main pipe. • Check operation error of check valve of discharge gas pipe. • Check circuit of SV11 valve. (Clogging, OFF at one side only) • Check clogging of circuit at auxiliary heat exchanger side. (Miswiring, Disconnection, Wiring missing) • Check Flow selector unit. <p>Check leakage of SVD valve and operation error.</p> <p>Check wiring inside of FS unit. (SVD/SVS coil miswiring, etc.)</p> <p>Check wiring between FS unit and indoor unit. (Miswiring, Disconnection, Wiring missing)</p> <ul style="list-style-type: none"> • Check circuit of SV5 valve. • Check refrigerant overcharge.

Check code			Detected position	Check code name	Status	Error detection condition	Check item (position)
Main remote controller	Outdoor 7-segment display						
	Check code	Auxiliary code					
P22	P22	0: IGBT shortage 1: Position detection circuit error 3: Motor lock error 4: Motor current error detection C: TH sensor temp. error D: TH sensor error E: Vdc error	FAN-IPDU	Outdoor fan IPDU error	All stop	(Auxiliary code: 0) • Short-circuit current was detected at start time. • Short-circuit current was detected when checking IGBT short-circuit before start time.	• Check fan motor. (Interphase short-circuit) • Check fan IPDU error.
					All stop	(Auxiliary code: 1) • The standard value of detection circuit of fan IPDU current fluctuated at start time.	• Check fan IPDU error.
					All stop	(Auxiliary code: 3) • Abnormal current was detected within 30 seconds after start time.	• Check fan motor. (Lock, phase missing) • Check cause of abnormal overload at start time. • Check connection of connector to fan motor.
					All stop	(Auxiliary code: 4) • Short-circuit current was detected when 2 seconds or more passed after start time. • Over-current was detected when 30 seconds or more passed after start time.	• Check power supply voltage. • Check fan IPDU error.
					All stop	(Auxiliary code: C) • Heat sink sensor (TH) of fan IPDU detected 95°C error.	• Check outdoor fan system. • Check fan IPDU error. • Check fixation between fan IPDU and heat sink.
					All stop	(Auxiliary code: D) • Heat sink sensor (TH) of fan IPDU detected short-circuiting or open.	• Check fan IPDU error.
					All stop	(Auxiliary code: E) • Input power supply voltage of the fan IPDU over the setup value was detected. • Input power supply terminal of the fan IPDU was unconnected. • Power supply P.C. board error of the fan IPDU	• Check input power supply voltage of the fan IPDU. • Check power supply P.C. board error of the fan IPDU. • Check error of external electrolytic condenser.
P26	P26	01: Compressor 1 side 02: Compressor 2 side	IPDU	G-Tr short-circuit protection error	All stop	Instantaneous over-current was detected when compressor started.	• Check connector connection and wiring on IPDU P.C. board. • Check compressor error and defect of compressor coil. • Check outdoor P.C. board (IPDU) error.
P29	P29	01: Compressor 1 side 02: Compressor 2 side	IPDU	Compressor position detection circuit error	All stop	Position was not normally detected.	• Check connector connection and wiring. • Check compressor error and defect of compressor coil. • Check P.C. board (IPDU) error.
P31	—	—	Indoor	Other indoor error (Group follower unit error)	Corresponding unit only stops.	E07/L07/L03/L08 was detected when other indoor unit in the group was defective.	• Check indoor P.C. board.

Error detected by TCC-LINK central control device

Display on central control device	Check code		Detected position	Check code name	Status	Error detection condition	Check item (position)
	Outdoor 7-segment display						
	Check code	Auxiliary code					
C05	—		TCC-LINK	TCC-LINK central control device transmission error	Operation continued.	Signal is not transmit from central control device.	<ul style="list-style-type: none"> • Check central control device error. • Check communication line error of central control device. • Check setup of terminator resistor.
C06	—			TCC-LINK central control device receiving error	Operation continued.	Signal is not received from central control device.	<ul style="list-style-type: none"> • Check central control device error. • Check communication line error of central control device. • Check setup of terminator resistor. • Check the power of connecting destination connected device. • Check P.C. board error of the connected device.
C12	—		HA control interface	Interface batch alarm of HA control interface	Operation continued.	Error was input in HA control interface	<ul style="list-style-type: none"> • Check error input.
P30	Differs according to error contents of the with alarm		TCC-LINK	Follower unit error of group control	Operation continued.	An error occurred in follower unit of the group control. ([P30] is displayed only on the central remote controller.)	<ul style="list-style-type: none"> • Check the check code of the unit with alarm.
	(L20 is displayed.)			Duplicated central control address	Operation continued.	Central control addresses were duplicated.	<ul style="list-style-type: none"> • Check the address setup.

Cautions when servicing for compressor

1. Removing wires of both compressors check output of the inverter as described below.

How to check inverter output

1. Turn off the power supply.
2. Remove the compressor lead cables from the compressors.
(Be sure to remove lead cables of both compressors.)
3. Turn on the power supply and start cooling or heating operation.
In this time, pay attention to touch the fasten receptacle terminal lug of the compressor leads so that they do not contact with other fasten receptacle terminal lug or other position (unit cabinet, etc.).
4. Check output voltage of compressor lead cable at inverter side.

When the output voltage does not satisfy the criteria in the following table, replace IPDU P.C. board.

No.	Measured position	Criteria
1	Between Red and White	400 V to 650 V
2	Between White and Black	400 V to 650 V
3	Between Black and Red	400 V to 650 V

- * After checking the output, when connecting the compressor lead again to the compressor terminal, check surely there is no distortion on the fasten terminal lug. If it is loosened, caulk it with pinchers, etc and then connect lead to the terminal.

How to check resistance of compressor winding

1. Turn off the power supply.
2. Remove the compressor lead cables from the compressors.
In each compressor, check the winding resistance between phases and resistance of the outdoor cabinet using a tester.
 - Is not it earthed?
→ Normal if $10\text{M}\Omega$ or more are measured
 - Is not shorted between windings?
→ Normal if 0.7Ω to 0.9Ω are measured (Use a precise digital tester.)

How to check the outdoor fan motor

1. Turn off the power supply.
2. Take off three connectors (U.V.W) from the fan IPDU P.C. board.
3. Turn the fan with hands. If the fan does not turn, it is a fan motor error (Lock). Replace the fan motor.
If the fan turns, measure the winding resistance between the phases of the connector (Motor winding) with a tester. If 13 to 33Ω are measured, it is normal. (Use a digital tester.)

7-5. Diagnosis Procedure for Each Check Code

Check code	Check code name	Cause of operation
[E01]	Communication error between indoor and remote controller (Detected at remote controller side)	<ol style="list-style-type: none"> 1. Remote controller inter-unit cable error 2. Indoor power error 3. Indoor P.C. board error 4. Remote controller address setup error 5. Remote controller P.C. board error

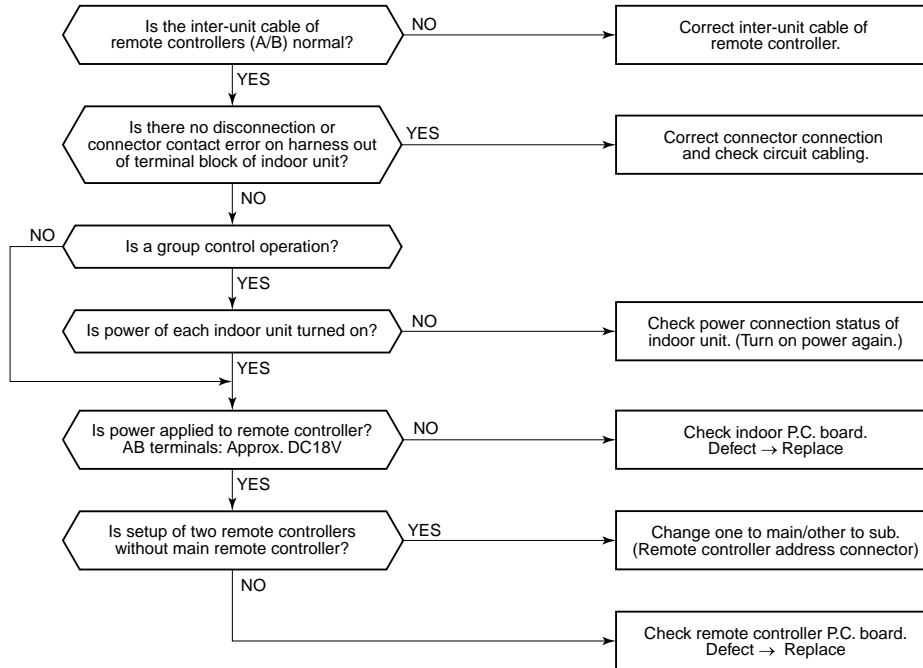

Check code	Check code name	Cause of operation
[E02]	Remote controller sending error	Signal could not be sent to indoor unit. Check the communication wire of the remote controller.

* It is not displayed on 7-segment display of the central control controller.

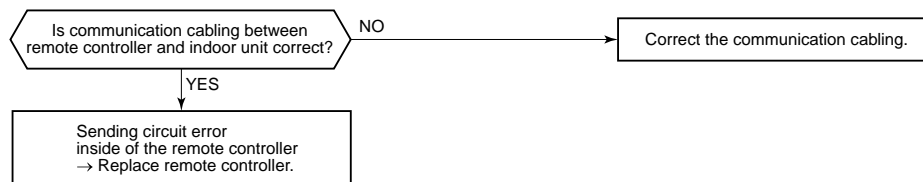

Check code	Check code name	Cause of operation
[E03]	Communication error between indoor and remote controller (Detected at indoor side)	No communication from remote controller and communication adaptor

This error is detected when the indoor unit cannot receive a signal from the remote controller. Check communication wires of the remote controllers A and B. As communication is impossible, this check code [E03] is not displayed on the main remote controller. It is displayed on TCC-LINK central controller.

Check code	Check code name	Cause of operation
[E04]	Indoor/Outdoor communication circuit error (Detected at indoor side)	<ol style="list-style-type: none"> 1. Power of outdoor unit was firstly turned on. 2. Connection error of communication line between indoor and outdoor 3. End terminal resistance setup error on communication between indoor and outdoor 4. Address setup error

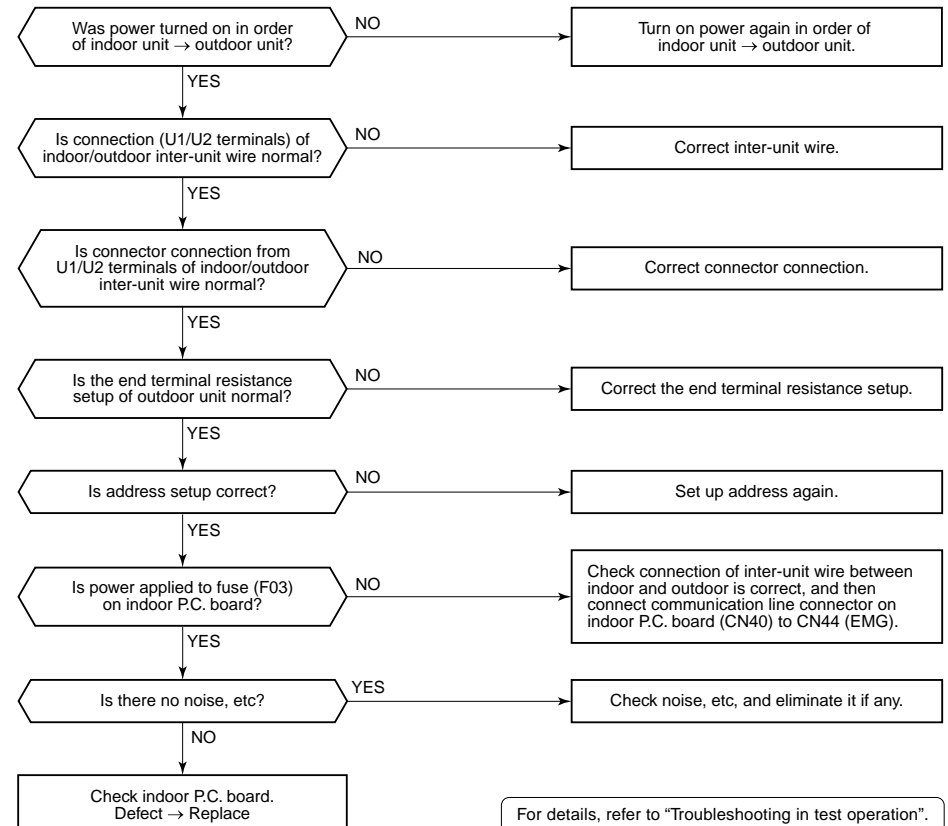

Check code	Check code name	Cause of operation
[E06]	Decreased number of indoor units	<ol style="list-style-type: none"> 1. Communication lines (U1, U2) connection error between indoor and outdoor 2. Connector connection error of communication for indoor P.C. board 3. Connector connection error of communication for outdoor I/F board 4. Power supply of indoor unit (Is power turned on?)

Auxiliary code : No. of indoor units which received signals normally

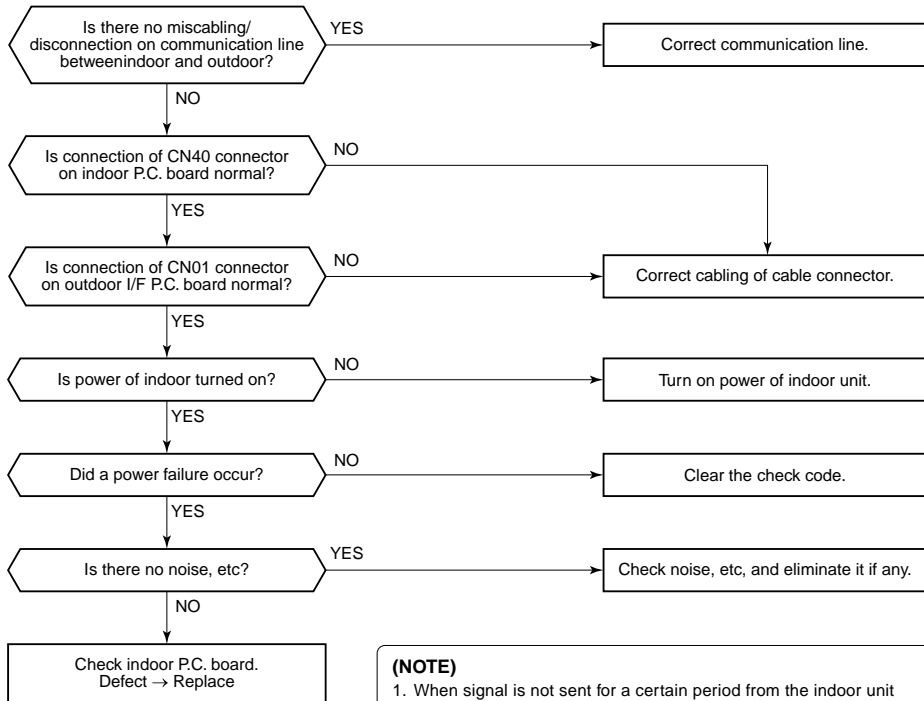

(NOTE)
 1. When signal is not sent for a certain period from the indoor unit which has used to send signals normally, [E06] is displayed.

Check code	Check code name	Cause of operation
[E07]	Indoor/Outdoor communication circuit error (Detected at outdoor side)	<ol style="list-style-type: none"> 1. Indoor/outdoor communication end terminal resistance setup error 2. Indoor/outdoor communication connection error

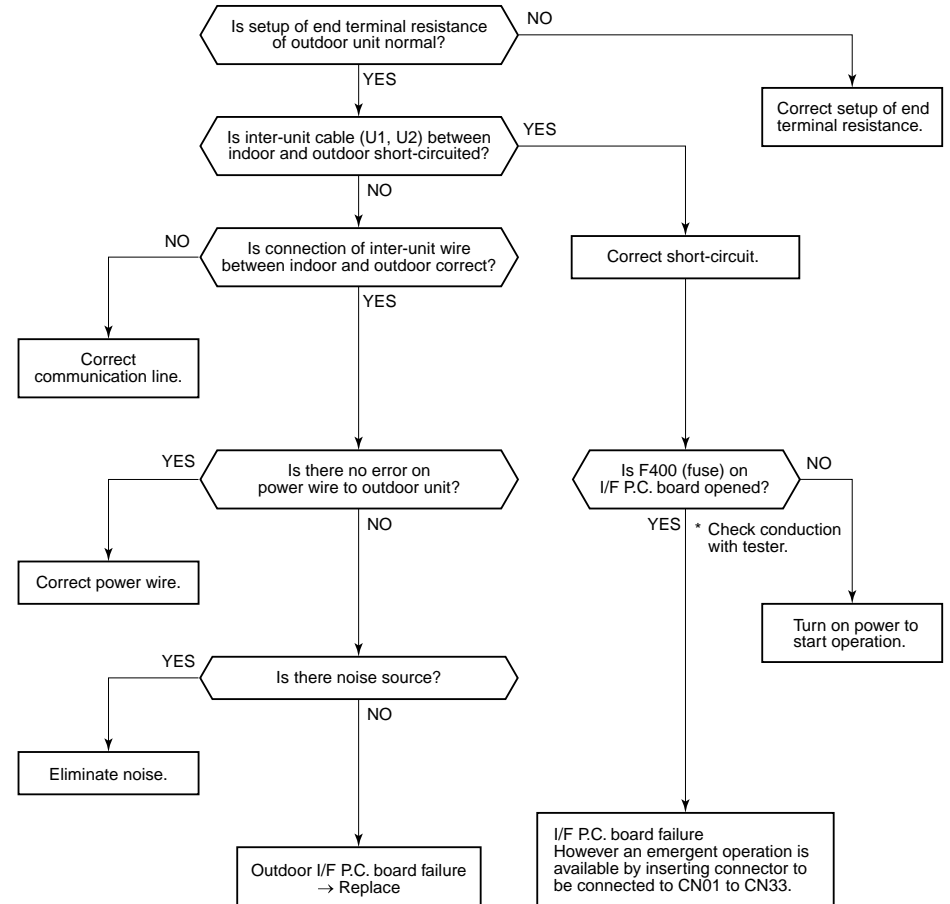

Check code	Check code name	Cause of operation
[E08]	Duplicated indoor addresses	Indoor addresses are duplicated.

Auxiliary code : Duplicated indoor address

Using a main remote controller (RBC-AMT21E), check the setup item codes (DN code) 12, 13, and 14. When there is no address duplication, check to the following flowchart.

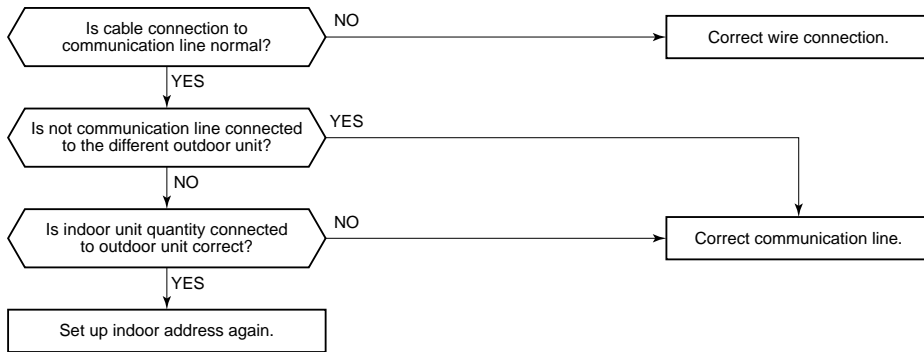

Check code	Check code name	Cause of operation
[E09]	Duplicated master remote controller	Setup of master remote controller is duplicated.

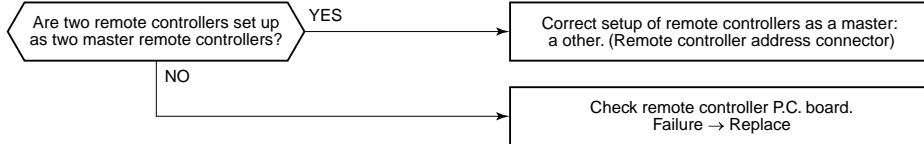

Check code	Check code name	Cause of operation
[E10]	Communication error in indoor P.C. board A'ssy	Indoor P.C. board error A'ssy failure

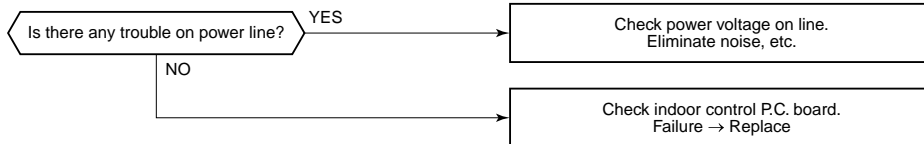

Check code	Check code name	Cause of operation
[E12]	Automatic address start error	1. When indoor automatic address started, other refrigerant circuit system was setting automatic address. (Sub code : 01) 2. When outdoor automatic address started, the indoor automatic address was being set. (Sub-code: 02)

Auxiliary code : 01: Communication between indoor and outdoor 02: Communication between outdoor units

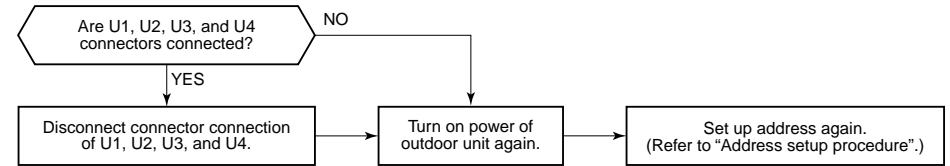

Check code	Check code name	Cause of operation
[E15]	No corresponding indoor unit during automatic address	1. Communication line connection error between indoor and outdoor. 2. Indoor power system error 3. Noise from surrounding devices 4. Power failure 5. Indoor P.C. board error

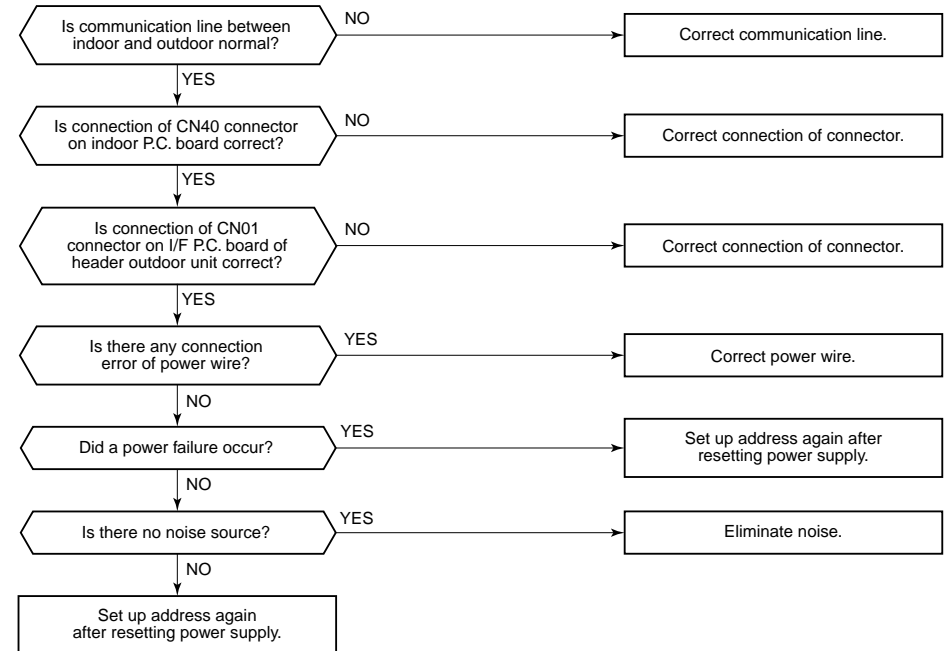

Check code	Check code name	Cause of operation
[E16]	Connected indoor units capacity over	1. There are 48 or more connected indoor units. 2. Capacity over of total connected indoor units. 3. Incorrect setup of indoor/outdoor capacity

Auxiliary code : 00 : Capacity over 01 : - : Number of connected indoor units

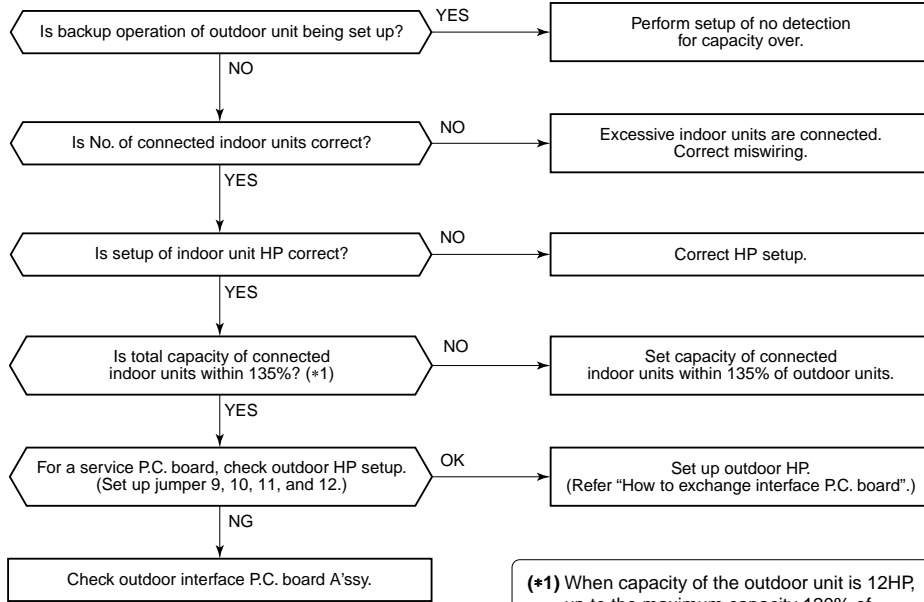

(*1) When capacity of the outdoor unit is 12HP, up to the maximum capacity 120% of indoor units can be connected.

Check code	Check code name	Cause of operation
[E18]	Communication error between indoor header and follower	Regular communication between indoor header and follower is unavailable.

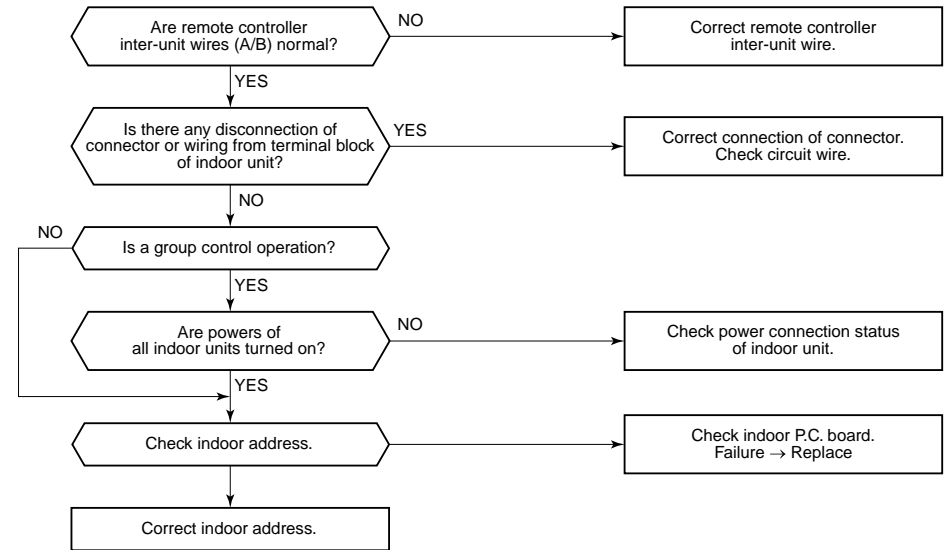

Check code	Check code name	Cause of operation
[E19]	Header outdoor units quantity error	1. Misconnection of inter-unit cable between indoor and outdoor 2. Outdoor I/F P.C. board error

Auxiliary code : 00: No header unit 02: Two or more header units

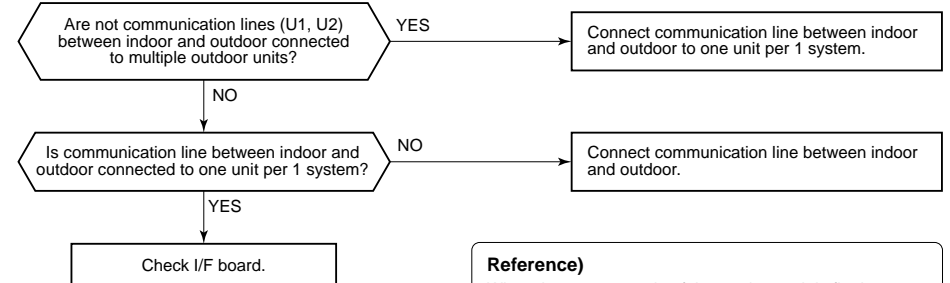

Reference)
When the power supply of the outdoor unit is firstly turned on, the check code [E19 00] is displayed until the power supplies of the indoor units are turned on. However it is not an error. If the power supplies of the indoor units are turned on, the check code is automatically reset.

Check code	Check code name	Cause of operation
[E20]	Unit connected to other line during automatic address	When starting automatic indoor address, a device in other line is connected.

Auxiliary code : 01: Connection of outdoor in other line 02: Connection of indoor unit in other line

Separate the wire between lines according to address setup method.

Check code	Check code name	Cause of operation
[E23]	Communication sending error between outdoor units	1. Inter-unit cable connection error between outdoor units 2. Communication connector connection error between outdoor units, I/F P.C. board error 3. End terminal resistance setup error between outdoor units

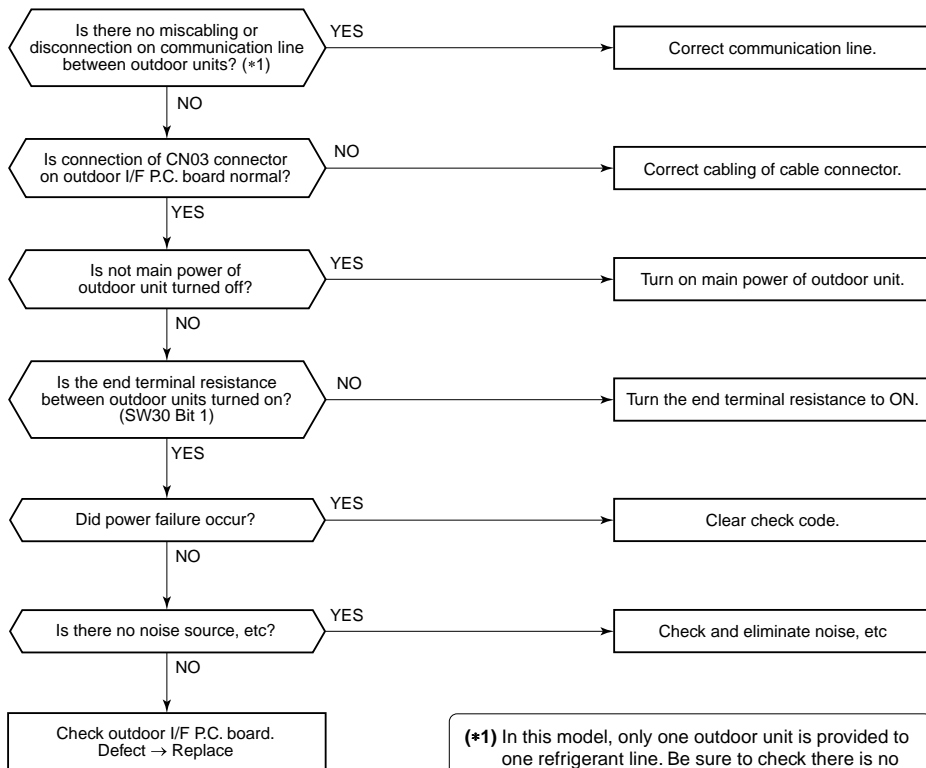

(*1) In this model, only one outdoor unit is provided to one refrigerant line. Be sure to check there is no communication connection with outdoor unit in the other refrigerant line.

Check code	Check code name	Cause of operation
[E25]	Duplicated address setup of terminal outdoor units	Addresses are duplicated by manual setting of outdoor address

Never set up the outdoor address manually.

Check code	Check code name	Cause of operation
[E26]	Decrease of connected outdoor units	1. Outdoor unit backup setup 2. Outdoor power error 3. Communication line connection error between outdoor units 4. Connector connection error for communication 5. Outdoor I/F P.C. board error

Auxiliary code : No. of outdoor units which received signals normally

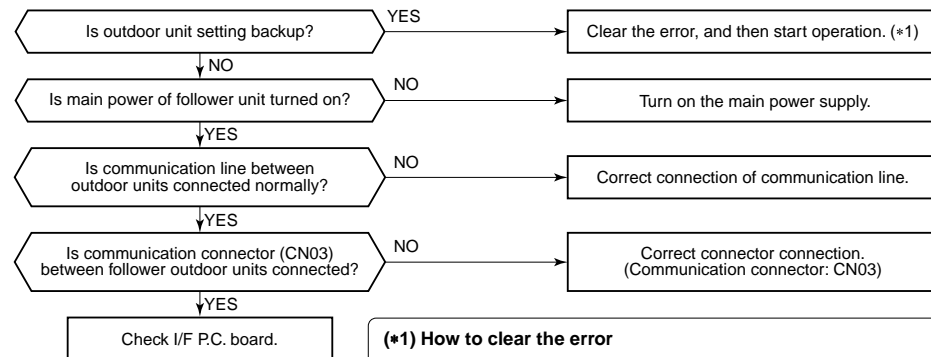

(*1) How to clear the error
Set SW01/SW02/SW03 on I/F P.C. board of header unit to 2/16/1, and push SW04 for 5 seconds or more. (7-segment display: [Er.] [CL])

• In this model, only one outdoor unit is provided to one refrigerant line. Be sure to check there is no communication connection with outdoor unit in the other refrigerant line.

Check code	Check code name	Cause of operation
[E28]	Terminal outdoor unit error	Terminal unit error

Auxiliary code : Detected outdoor unit number

SA n error occurred on the terminal unit. Confirm the check code of the terminal unit using 7-segment display on the I/F P.C. board of the terminal unit and check it according to the diagnostic procedure for each check code.
<How to specify the terminal outdoor unit on which error occurred>
 Under condition that [E28] is displayed on the 7-segment display of the header unit, when pushing SW04 for 1 second or more, the fan of the outdoor unit which stopped due to the error rotates. If pushing SW05 alone, fan running is released.

Check code	Check code name	Cause of operation
[E31]	IPDU communication error	1. Connection error of communication line between IPDU and I/F P.C. board 2. I/F P.C. board error 3. IPDU P.C. board error 4. External noise

Auxiliary code :
 01: IPDU1 error 02: IPDU2 error
 03: IPDU1, 2 error 04: Fan IPDU error
 05: IPDU1, fan IPDU error 06: IPDU2, fan IPDU error
 07: All IPDU error or communication line error between IPDU-I/F P.C. boards, or outdoor I/F P.C. board error

* If the fan IPDU is abnormal, be sure to check the voltage output on the fan power supply P.C. board.

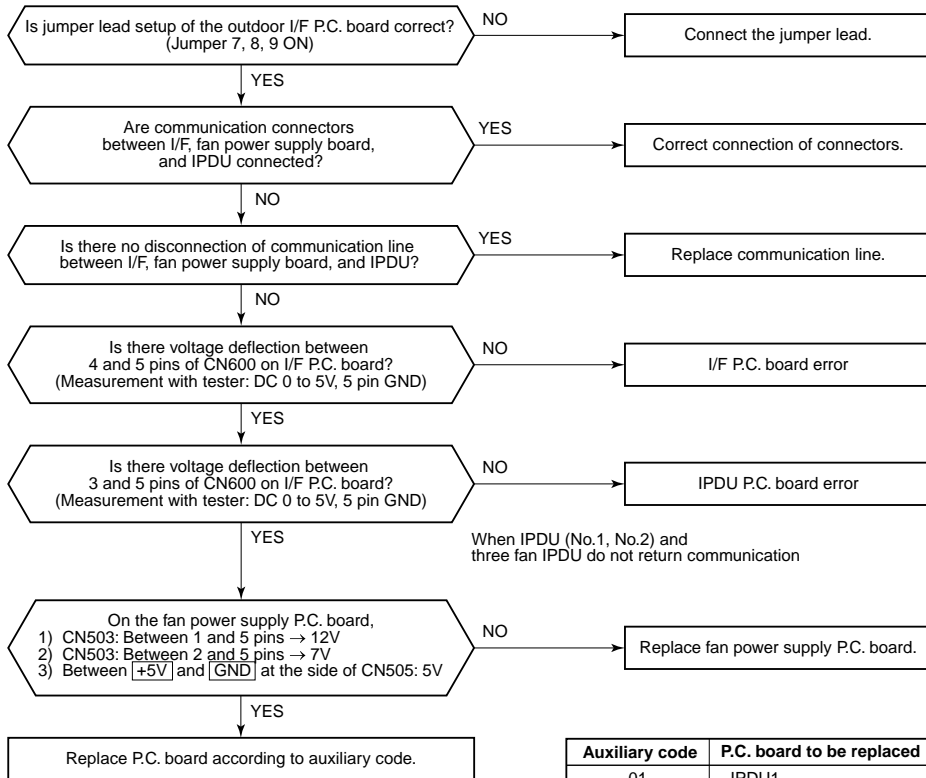

Auxiliary code	P.C. board to be replaced
01	IPDU1
02	IPDU2
03	IPDU1, 2
04	Fan IPDU
05	IPDU1, fan IPDU
06	IPDU2, fan IPDU
07	IPDU1, 2, fan IPDU, I/F

Check code	Check code name	Cause of operation
[F01]	Indoor TCJ sensor error	TCJ sensor Open/Short

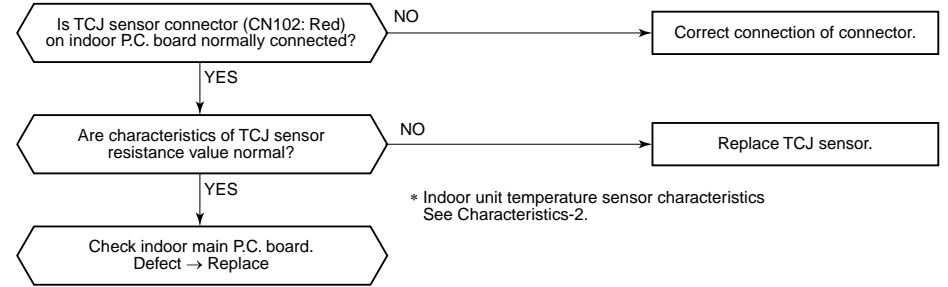

Check code	Check code name	Cause of operation
[F02]	Indoor TC2 sensor error	TC2 sensor Open/Short

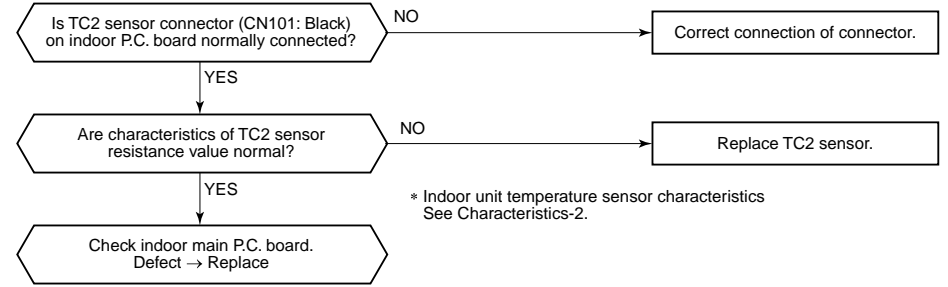

Check code	Check code name	Cause of operation
[F03]	Indoor TC1 sensor error	TC1 sensor Open/Short

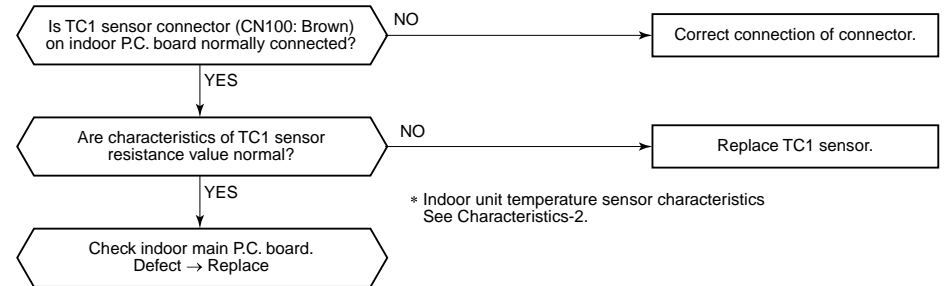

Check code	Check code name	Cause of operation
[F04]	TD1 sensor error	TD1 sensor Open/Short

This error code means detection of Open/Short of TD1 sensor. Check disconnection of circuit for connection of connector (TD1 sensor: CN502, White) and characteristics of sensor resistance value. (Refer to Outdoor unit temperature sensor characteristics.)
If sensor is normal, replace outdoor I/F P.C. board.

Check code	Check code name	Cause of operation
[F05]	TD2 sensor error	TD2 sensor Open/Short

This error code means detection of Open/Short of TD2 sensor. Check disconnection of circuit for connection of connector (TD2 sensor: CN503, Pink) and characteristics of sensor resistance value. (Refer to Outdoor unit temperature sensor characteristics.)
If sensor is normal, replace outdoor I/F P.C. board.

Check code	Check code name	Cause of operation
[F06]	TE1 sensor error	TE1 sensor Open/Short

This error code means detection of Open/Short of TE1 sensor. Check disconnection of circuit for connection of connector (TE1 sensor: CN505, Green) and characteristics of sensor resistance value. (Refer to Outdoor unit temperature sensor characteristics.)
If sensor is normal, replace outdoor I/F P.C. board.

Check code name	Check code name	Cause of operation
[F07]	TL sensor error	TL sensor Open/Short

This error code means detection of Open/Short of TL sensor. Check disconnection of circuit for connection of connector (TL sensor: CN521, White) and characteristics of sensor resistance value. (Refer to Outdoor unit temperature sensor characteristics.)
If sensor is normal, replace outdoor I/F P.C. board.

Check code name	Check code name	Cause of operation
[F08]	TO sensor error	TO sensor Open/Short

This error code means detection of Open/Short of TO sensor. Check disconnection of circuit for connection of connector (TO sensor: CN507, Yellow) and characteristics of sensor resistance value. (Refer to Outdoor unit temperature sensor characteristics.)
If sensor is normal, replace outdoor I/F P.C. board.

Check code name	Check code name	Cause of operation
[F10]	Indoor TA sensor error	TA sensor Open/Short

This error code means detection of Open/Short of TA sensor. Check disconnection of circuit for connection of connector (TA sensor: CN104, Yellow) and characteristics of sensor resistance value. (Refer to Outdoor unit temperature sensor characteristics.)
If sensor is normal, replace indoor P.C. board.

Check code name	Check code name	Cause of operation
[F12]	TS sensor error	TS1, TS2 sensor Open/Short

Auxiliary code : 01: TS1 sensor 02 : TS2 sensor

This error code means detection of Open/Short of TS sensor. Check disconnection of circuit for connection of connector (TS1 sensor: CN504, White TS2 sensor: CN522, Black) and characteristics of sensor resistance value. (Refer to Outdoor unit temperature sensor characteristics.)
If sensor is normal, replace outdoor I/F P.C. board.

Check code name	Check code name	Cause of operation
[F13]	TH sensor error	IGBT built-in sensor error in A3-IPDU

Auxiliary code : 01: Compressor 1 side 02: Compressor 2 side

This error code means IGBT built-in temperature sensor error. Check connection of connectors CN06 on IPDU P.C. board and CN600 on I/F P.C. board.
If sensor is normal, replace IPDU P.C. board.

Check code name	Check code name	Cause of operation
[F15]	Outdoor temp sensor miscabling (TE1, TL)	1. Misinstallation and misconnection of TE1 sensor and TL sensor 2. Resistance characteristics error of TE1 sensor and TL sensor 3. Outdoor P.C. board (I/F) error

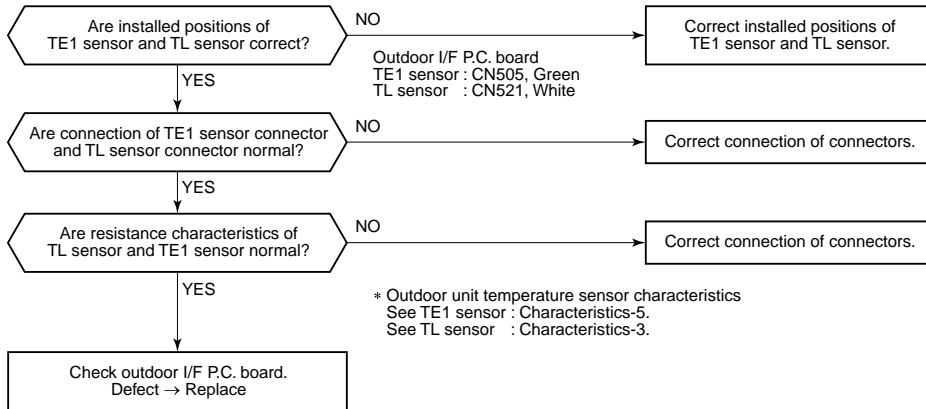

* TE1 sensor : Outdoor heat exchanger temp sensor
TL sensor : Temp sensor between liquid tanks of outdoor PMV1/2

Check code name	Check code name	Cause of operation
[F16]	Outdoor pressure sensor miscabling (Pd, Ps)	1. High-pressure Pd sensor and low-pressure sensor Ps are exchanged. 2. Output voltage of each sensor is zero.

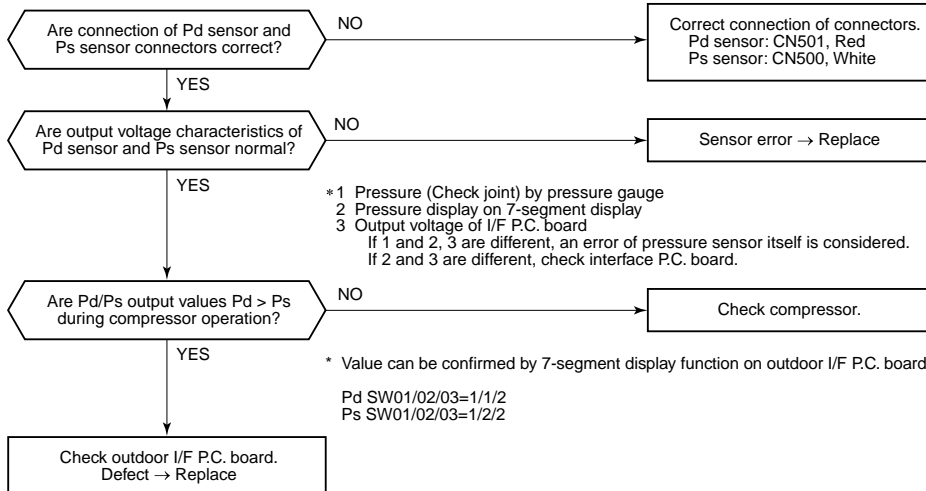

Check code name	Check code name	Cause of operation
[F23]	Ps sensor error	Output voltage error of Ps sensor

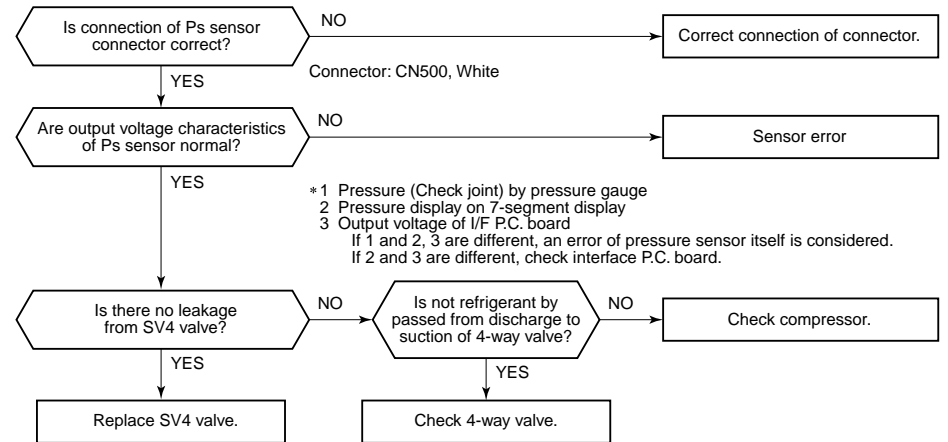

Check code name	Check code name	Cause of operation
[F24]	Pd sensor error	Output voltage error of Pd sensor

It is output voltage error of Pd sensor. Check disconnection of connection of connector (Pd sensor: CN501) circuit and output voltage of sensor.
If the sensor is normal, replace outdoor I/F P.C. board.

Check code name	Check code name	Cause of operation
[F29]	Indoor other error	Indoor P.C. board error EEROM error

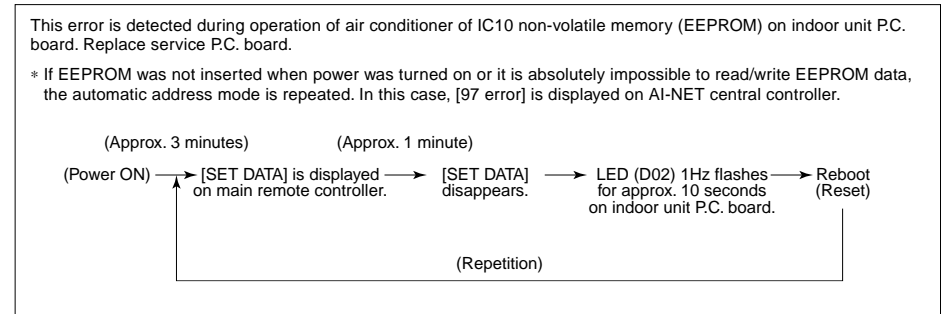

Check code name	Check code name	Cause of operation
[F31]	Outdoor EEPROM error	1. Outdoor unit power error (Voltage, noise, etc.) 2. Outdoor I/F P.C. board error



Check code name	Check code name	Cause of operation
[H01]	Compressor breakdown	1. Outdoor unit power line error 2. Compressor circuit system error 3. Compressor error 4. Cause of abnormal overload operation 5. IPDU P.C. board error

Auxiliary code : 01: Compressor 1 side 02: Compressor 2 side

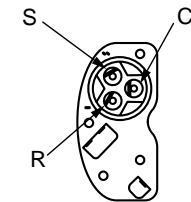
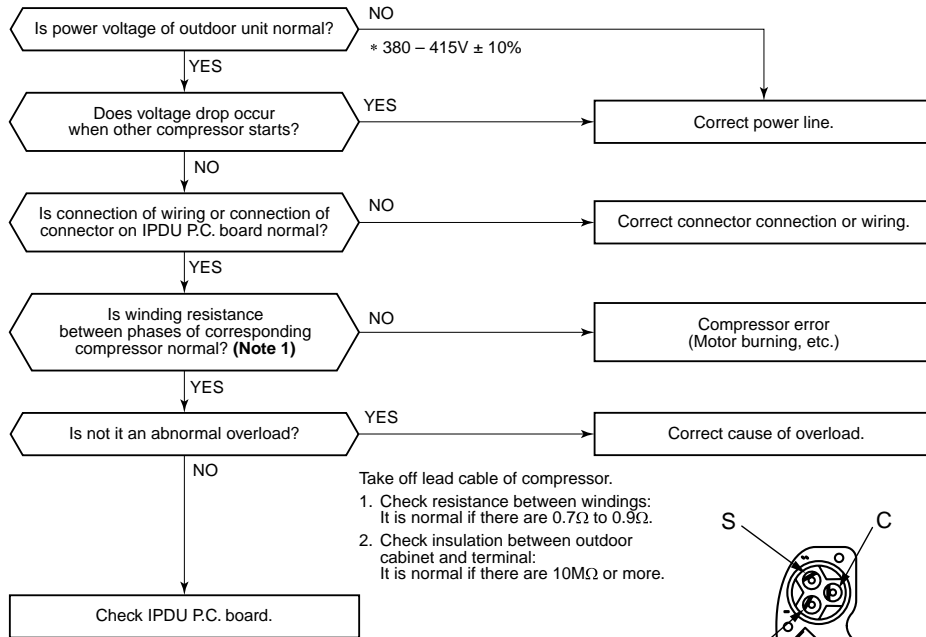

Details of compressor power connecting section

Note 1
* After checking the output, when connecting the compressor lead again to the compressor terminal, check surely there is no distortion on the Fasten receptacle terminal. If it is loosened, caulk it with pinchers, etc and then connect lead to the terminal firmly.

Check code name	Check code name	Cause of operation
[H02]	Compressor error (Lock)	1. Outdoor unit power line error 2. Compressor circuit system error 3. Compressor error 4. Refrigerant stagnation in compressor shell 5. IPDU P.C. board error

Auxiliary code : 01: Compressor 1 side 02: Compressor 2 side

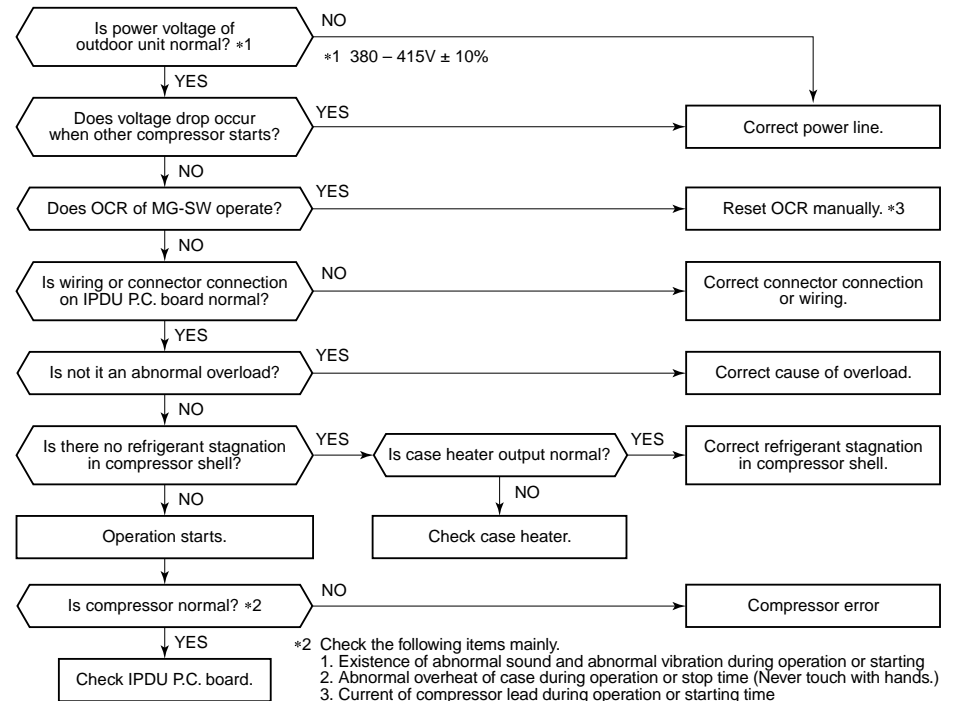

Check code name	Check code name	Cause of operation
[H03]	Current detective circuit system error	1. Cabling or connector connection error on IPDU P.C. board 2. IPDU P.C. board error

Auxiliary code : 01: Compressor 1 side 02: Compressor 2 side

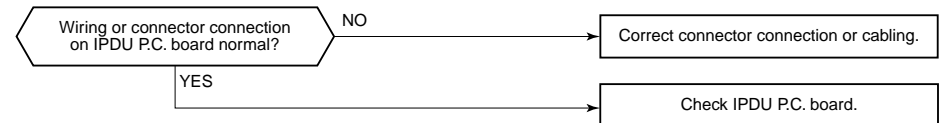

Check code name	Check code name	Cause of operation
[H04]	Compressor 1 case thermo operation	1. Case thermo circuit error 2. I/F P.C. board error 3. Service valve closed 4. Outdoor PMV clogging 5. SV4 valve leak, Coil misinstallation 6. 4-way valve error 7. Compressor error 8. Refrigerant shortage
[H14]	Compressor 2 case thermo operation	

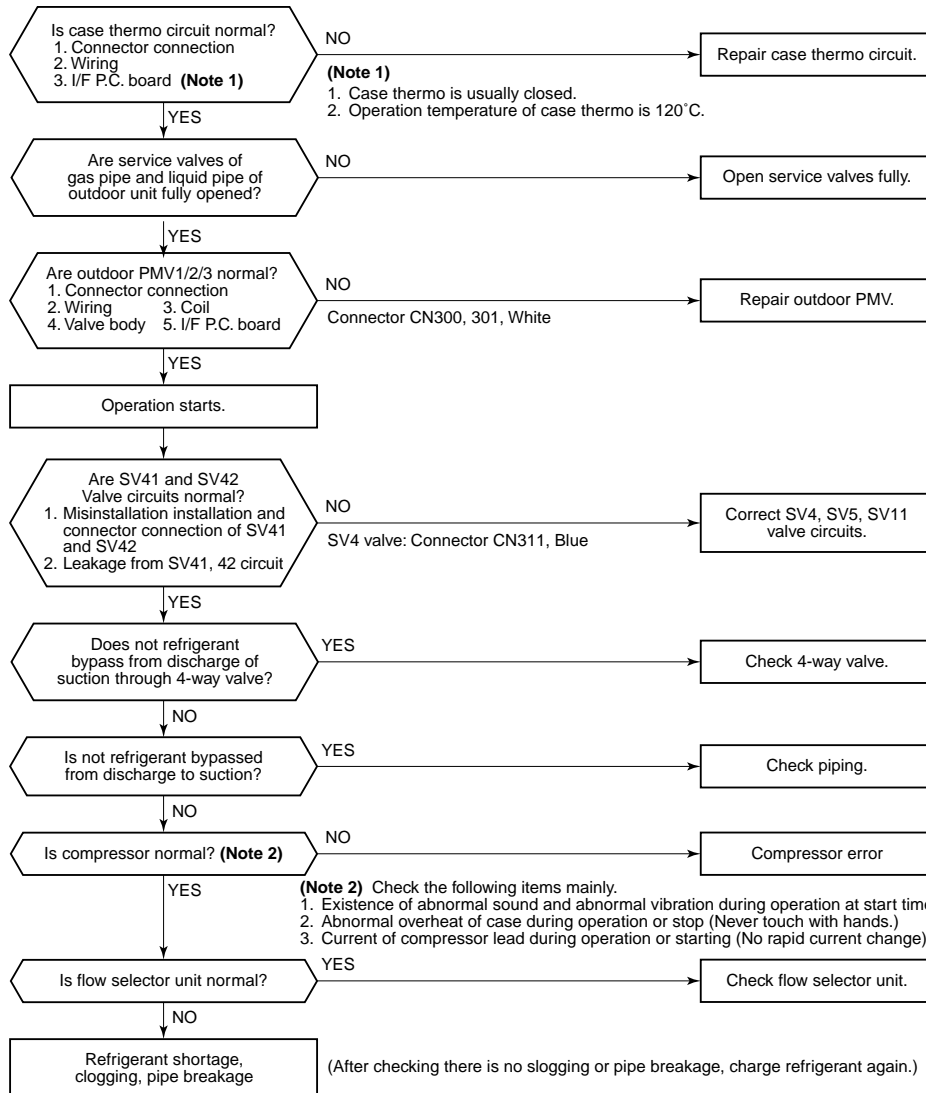

Check code name	Check code name	Cause of operation
[H06]	Low-pressure protective operation	1. Service valve close 2. Ps sensor error 3. SV2, SV4 circuit error 4. Miscabling of communication between indoor and outdoor 5. Indoor/outdoor fan and condenser error 6. Indoor/outdoor PMV clogging 7. Indoor/outdoor heat exchanger clogging 8. Refrigerant shortage

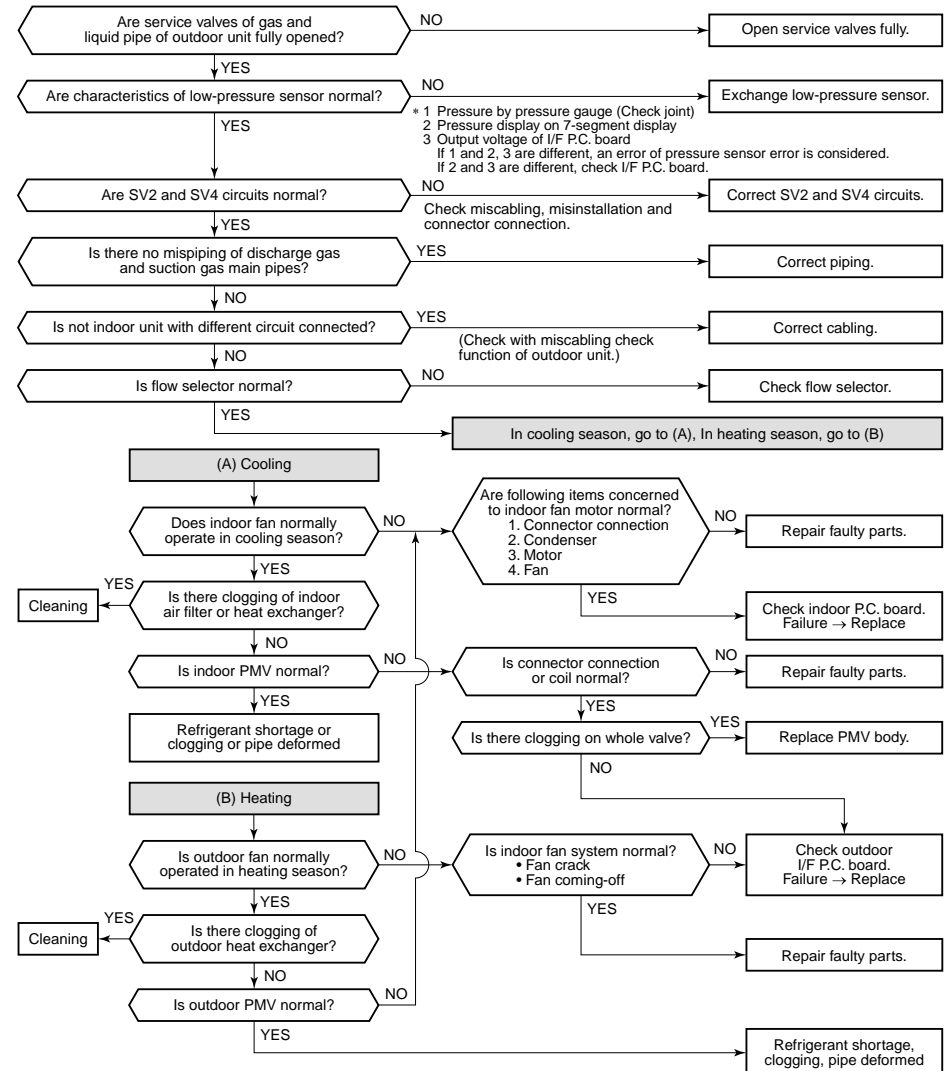

Check code name	Check code name	Cause of operation
[H07]	Oil level down detection protection	1. Valves of balance pipes closed. 2. Miscabling or misinstallation of TK1 to TK4 sensors 3. TK1 to TK4 sensor error 4. Gas leak or oil leak of all outdoor units 5. Refrigerant stagnation of compressor case 6. SV3A, 3B, 3D, 3C, 3E valve error 7. Clogging of oil return circuit from oil separator 8. Clogging of oil-equation circuit system

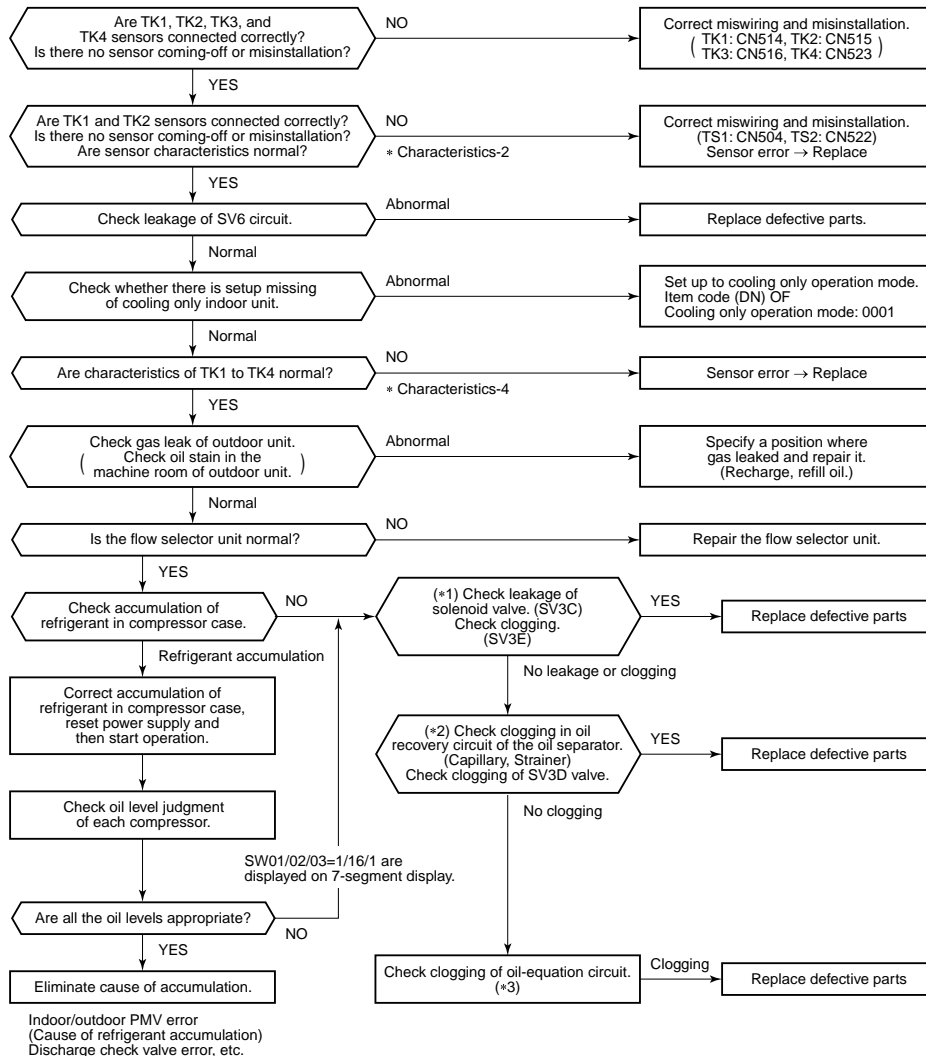

(Reference) If refrigerant is accumulated in the compressor case, oil level short may be judged.

In some cases, it may be difficult to check the leakage of clogging in the following condition of refrigerant stagnation in low ambient temperature condition.

In this case, take a longer operating time prior to check.

(Criterion: Discharge temperature of TD1 and TD2 are 60°C or higher)

(*1)

a) Leakage check for SV3A valve (For multiple outdoor unit system)

- Turn off the power supply, take off connector of SV3A valve, and then start a test operation after power-ON.
- Check the temperature change at secondary side of SV3A valve during operation. (① in the figure.)
→ If temperature is raised, it is a leakage of SV3A valve. Replace SV3A valve.

b) Leakage check for SV3C valve

- Turn off the power supply, take off connector of SV3C valve, and then start a test operation after power-ON.
- After operation for several minutes, check temperature at secondary side of SV3C valve. (② in the figure.)
→ If temperature is high (equivalent to discharge temperature TD), it is a leakage of SV3C valve. Replace SV3C valve.
(Even if there is leakage from SV3C valve does not occur, temperature of SV3C valve at secondary side rises during operation. When the checked temperature is equivalent to TD temperature, it is a leakage of SV3C valve. Replace SV3C valve.)

c) Clogging check for SV3B valve (For multiple outdoor unit system)

- While outdoor unit is operated, set up SW01/02/03 = [2] [1] [3] to 7-segment display [Hr] [2], and push SW04 for 2 seconds or more.
- Set up SW02 = [9], and turn on SV3A, SV3B, SV3C valves. (7-segment display [Hr] [3-])
- While outdoor unit is operating, check temperature change at secondary side of SV3B valve. (③ in the figure.)
→ If temperature does not rise (equivalent to suction temperature), it is a clogging of SV3B valve. Replace SV3B valve.

d) Clogging for SV3E valve

Reset the power supply.



Referring to "Valve forced open/close function" of the outdoor unit, check ON/OFF operation (Sound, coil surface temp up) of SV3E valve is performed.



Start test operation in COOL or HEAT mode.



After operation for several minutes, check the pipe temperature at the secondary side of SV3E valve whether temperature changes or not. If it is equivalent to outside temperature, clogging of SV3E is considered. (④ in the figure.)

(Reference)

If SV3E valve is clogged, temperature of all TK1, TK2, TK3, and TK4 do not change.

(*2) Clogging check for SV3D valve of oil return circuit from oil separator

a) Oil return circuit

- While outdoor unit is operating, check temperature (secondary side of capillary) on oil return circuit. (⑤ in the figure.)
→ If temperature is low (equivalent to suction temperature), a clogging of strainer of oil return circuit or capillary is considered. Repair the clogged part.

b) Clogging check for SV3D valve

- While outdoor unit is operating, set up SW01/02/03 = [2] [1] [3] to 7-segment display [Hr] [2], and push SW04 for 2 seconds or more.
- Set up SW02 = [6], and turn on SV3D valve. (7-segment display [Hr] [3d])
- If temperature is low at secondary side of the valve or it does not change, clogging of valve, capillary, or strainer is considered. (⑥ in the figure.)

(*3) Check for solenoid valve of outdoor unit (For multiple outdoor unit system)

a) Clogging check for SV3A valve

- While outdoor unit is operating, set up SW01/02/03 = [2] [1] [3] to 7-segment display [Hr] [2], and push SW04 for 2 seconds or more.
- Set up SW02 = [4], and turn on SV3A valve. (7-segment display [Hr] [3A])
- If temperature is low at secondary side of the valve or it does not change, clogging of valve or check valve is considered. (① in the figure.)

b) Leakage check for SV3C valve

- While outdoor unit is operating, set up SW01/02/03 = [2] [1] [3] to 7-segment display [Hr] [2], and push SW04 for 2 seconds or more.
- Set up SW02 = [6], and turn on SV3C valve. (7-segment display [Hr] [3C])
- If temperature does not change (up), clogging of valve or strainer is considered. (② in the figure.)

(*4)

a) Clogging check for oil-equalization circuit

- Drive the outdoor unit. (Drive both compressors in the unit.)
- After driving for 10 minutes, check temperature of TK1 and TK2 sensors and temperature of oil-equalization circuit capillary (⑦ in the figure) were raised.

(Criterion)

TK1, TK2=Td1, Td2 temperature – Approx. 10 to 30°C

Oil-equalization capillary tubes should be higher sufficiently than outside air temperature and suction temperature.

- If temperature is low, a malfunction of capillary, strainer, or check valve is considered. Repair the defective parts.

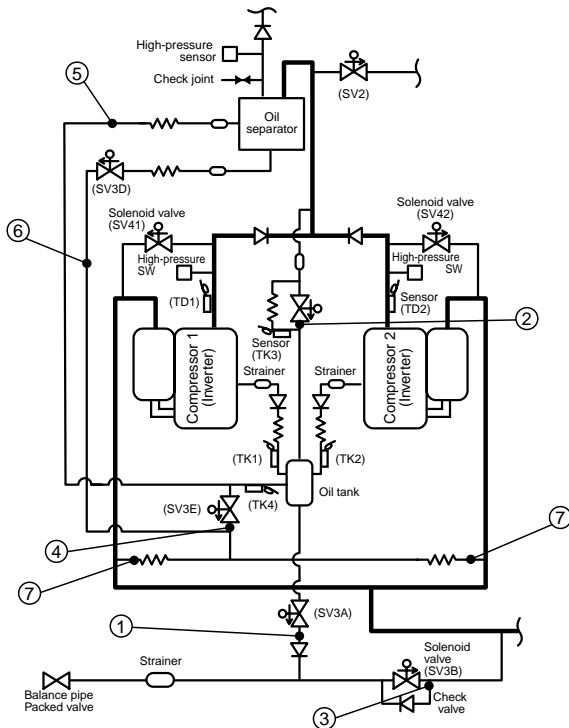

Check code name	Check code name	Cause of operation
[H08]	Oil level detective temperature sensor error	TK1 to TK4 sensor Open/Short

Auxiliary code : 01: TK1 sensor error 02: TK2 sensor error 03: TK3 sensor error 04: TK4 sensor error

The detected error is an oil level detective temperature sensor error. Check disconnection of the wiring and resistance value of the sensor. If the sensors are normal, replace the outdoor I/F P.C. board.

Circuit	Connector
TK1	CN514 (Black)
TK2	CN515 (Green)
TK3	CN516 (Red)
TK4	CN523 (Yellow)

Check code name	Check code name	Cause of operation
[H16]	TK1 temperature detective circuit error (Auxiliary code : 01)	<ol style="list-style-type: none"> 1. Coming-off of TK1 sensor, miscabling, characteristics error of resistance value 2. Oil-equalization circuit error (Check valve, capillary clogging, strainer clogging) 3. Refrigerant stagnation in case of compressor shell

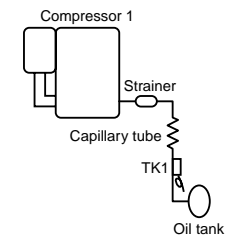
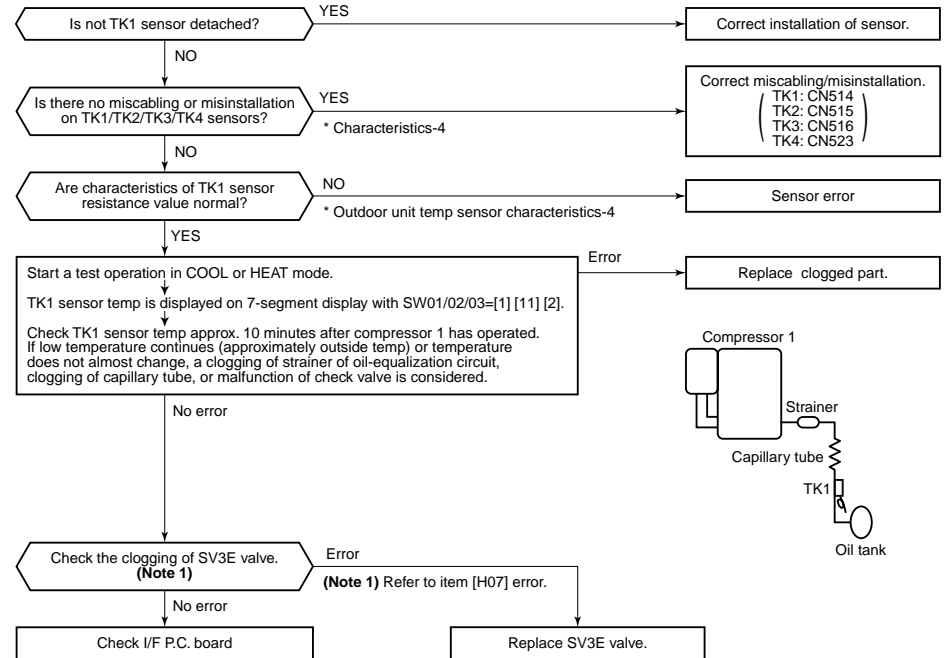

Check code name	Check code name	Cause of operation
[H16]	Oil level detective circuit system error (Auxiliary code : 02)	1. Detachment of TK2 sensor, miscabling, characteristics error of resistance value 2. Oil-equalization circuit error (Check valve, capillary clogging, strainer clogging) 3. Refrigerant stagnation in compressor shell

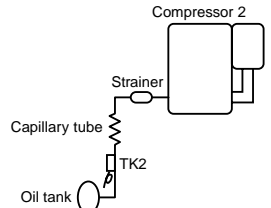
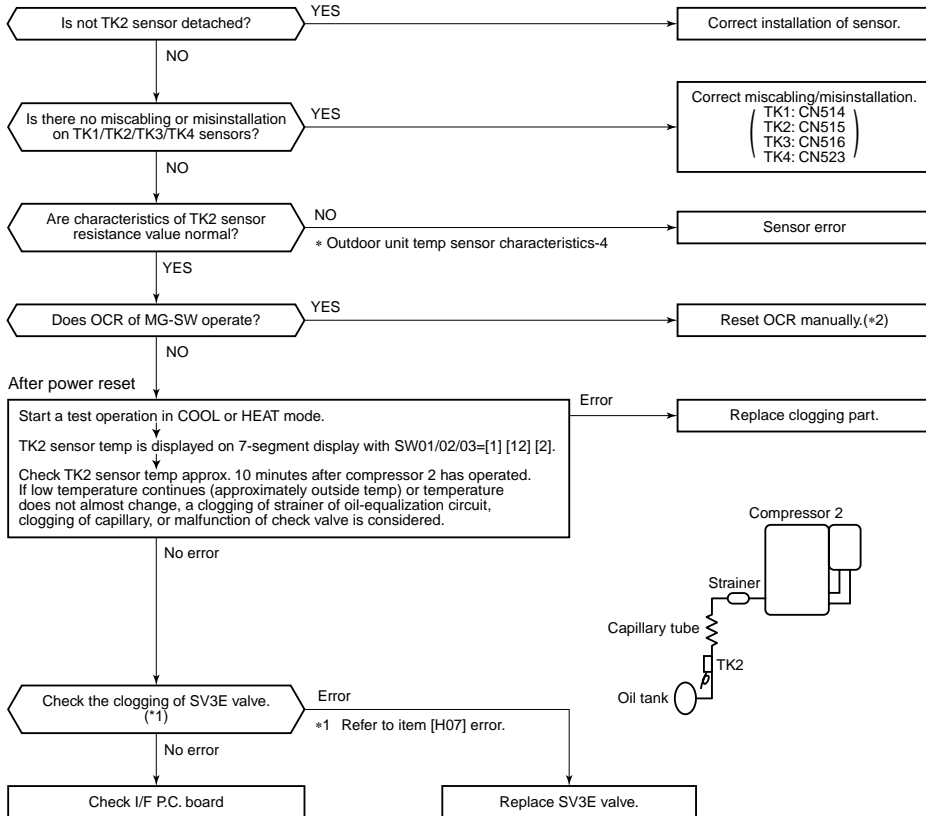

Check code name	Check code name	Cause of operation
[H16]	TK3 temperature detective circuit error (Auxiliary code : 03)	1. Detachment of TK3 sensor, miscabling, characteristics error of resistance value 2. Error of SV3C valve circuit periphery (Check capillary clogging, strainer clogging) 3. Refrigerant stagnation in compressor shell

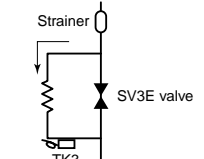
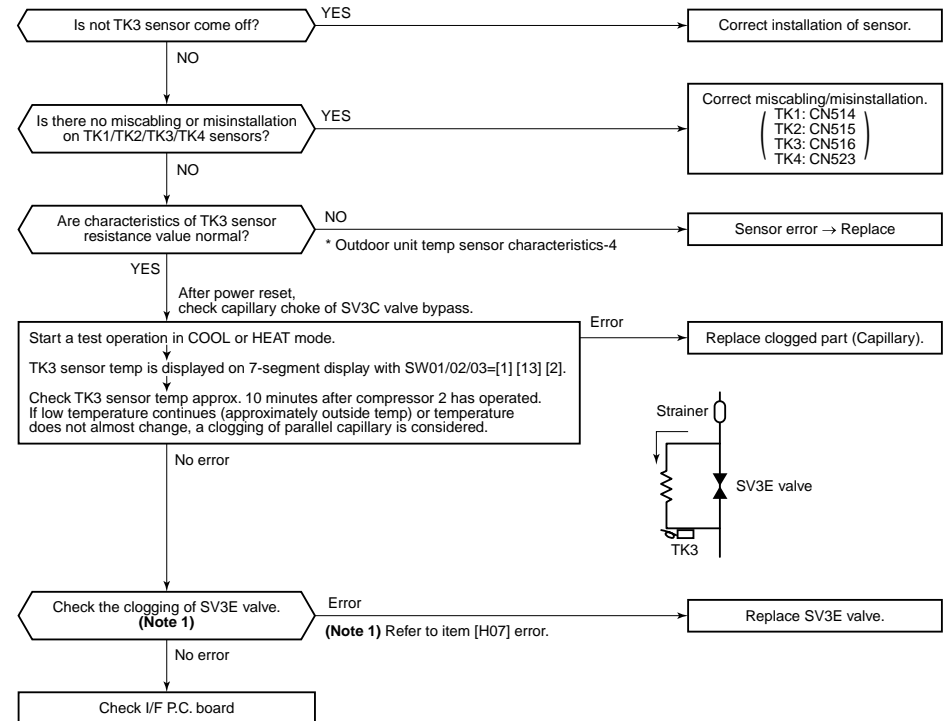

Check code name	Check code name	Cause of operation
[H16]	TK4 temperature detective circuit error (Auxiliary code : 04)	1. Detachment of TK4 sensor, miscabling, characteristics error of resistance value 2. Check clogging and malfunction of SV3E valve circuit. 3. Oil-equalization circuit error (Check capillary clogging, strainer clogging) 4. Refrigerant stagnation in compressor shell

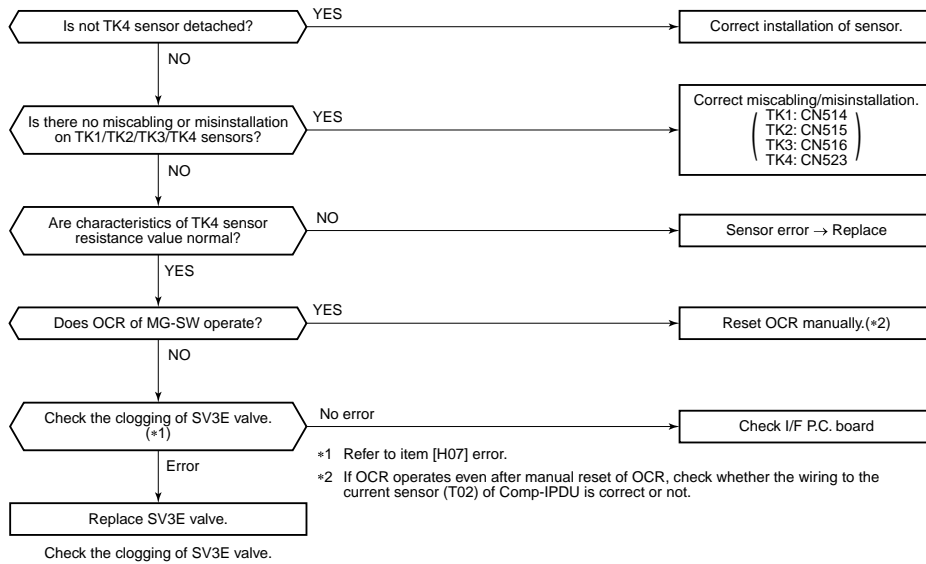

*1 Refer to item [H07] error.
 *2 If OCR operates even after manual reset of OCR, check whether the wiring to the current sensor (T02) of Comp-IPDU is correct or not.

Check code name	Check code name	Cause of operation
[L03]	Duplicated indoor header units	There were two or more indoor header units in some remote controller group control.

1) Check the connection changing of the remote controller after the connection has been changed.
 2) If the group configuration and address are normal when power has been turned on, the mode automatically shifts to address setup mode. (Re-setup of address) → Refer to "Address setup".

Check code name	Check code name	Cause of operation
[L04]	Duplicated setup of outdoor line address	Outdoor line addresses are duplicated.

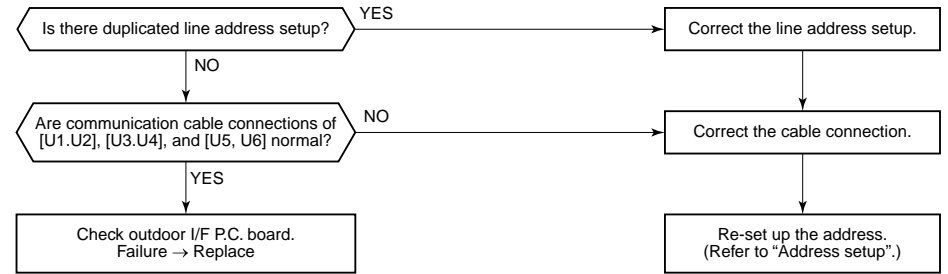

Check code name	Check code name	Cause of operation
[L05]	Duplicated indoor units with priority (Displayed on indoor unit with priority)	1. Two or more prior indoor units exist.

This check code is displayed on the set indoor unit when setup of indoor unit with priority is duplicated.
 • Priority setup with two or more units is not available. Choose one prior unit in one refrigerant circuit system.

Check code name	Check code name	Cause of operation
[L06]	Duplicated indoor units with priority (Displayed on the indoor unit other than one with priority and on the outdoor unit)	Two or more indoor units with priority are duplicated.

Auxiliary code : No. of indoor units with priority

When indoor unit with priority is duplicated, this check code is displayed on the unit other than the setup indoor unit and outdoor unit.
 • As only one indoor unit with priority is valid, change the setup.

Check code name	Check code name	Cause of operation
[L07]	Group line in individual indoor unit	The group line is connected in the individual indoor unit.

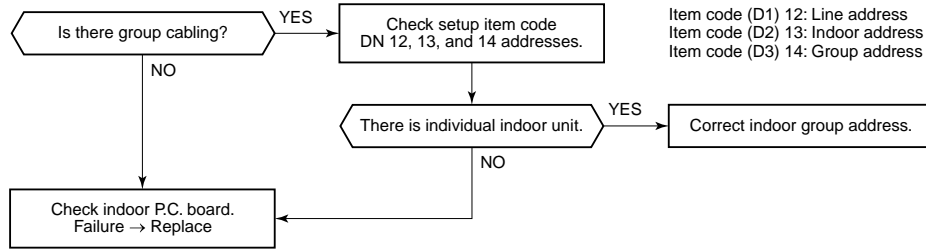

Check code name	Check code name	Cause of operation
[L08]	Indoor group / address unset	Indoor address unset

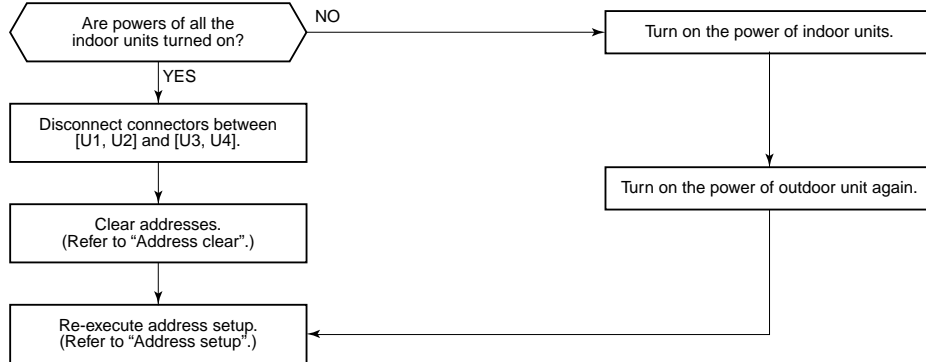

Note) This code is displayed when the power is turned on at the first time after installation. (Because the address is not yet set up)

Check code name	Check code name	Cause of operation
[L09]	Indoor capacity unset	Indoor capacity unset

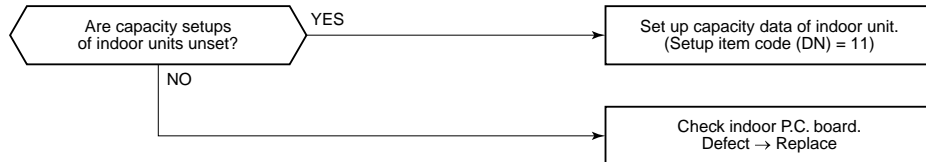

Check code name	Check code name	Cause of operation
[L10]	Outdoor capacity unset	On the outdoor I/F P.C. board for service, the model selecting jumper has not been set up so as to match with the model.

I/F P.C. board A'ssy service for the outdoor unit is common to this series. A setup for model selection different from that for P.C. board with trouble is necessary. Set up a model based upon the P.C. board A'ssy exchange procedure.

Check code name	Check code name	Cause of operation
[L17]	Inconsistent models of outdoor units	There are outdoor units on the communication line other than Super Module Multi Flex type such as Super Module Multi or Super Module Multi ice regenerative type

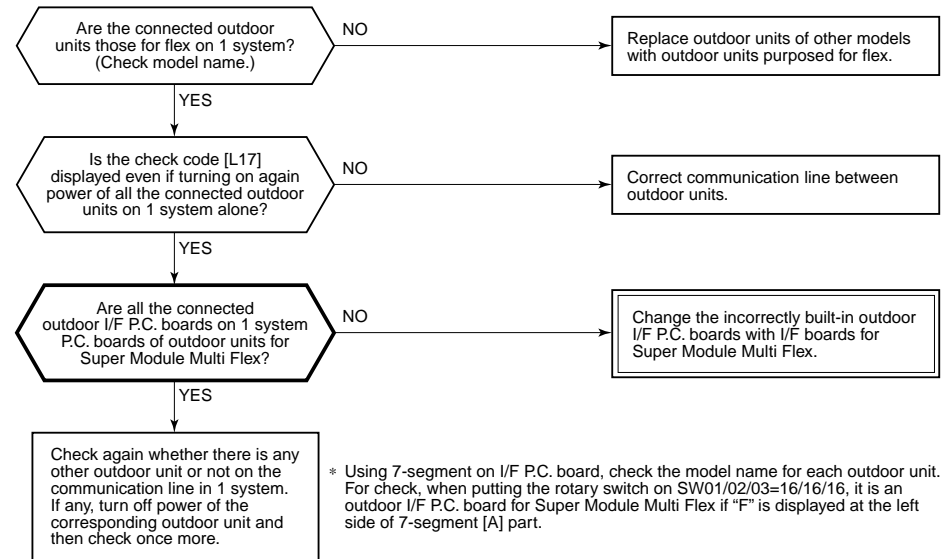

Check code name	Check code name	Cause of operation
[L18]	Flow selector unit system error	An indoor unit which has been operated in cooling only mode is operated in heating mode without setup for cooling only mode.

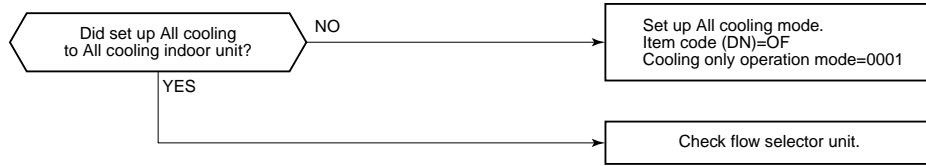

Check code name	Check code name	Cause of operation
[L20]	Duplicated central control addresses	Central control addresses are duplicated.

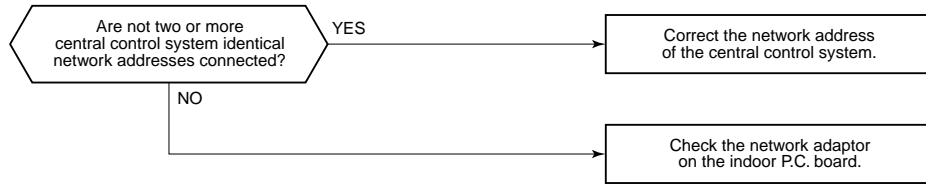

Check code name	Check code name	Cause of operation
[L28]	Quantity over of connected outdoor units	1. Quantity over of connected outdoor units 2. Connection error of communication line between outdoor units 3. Outdoor I/F P.C. board error

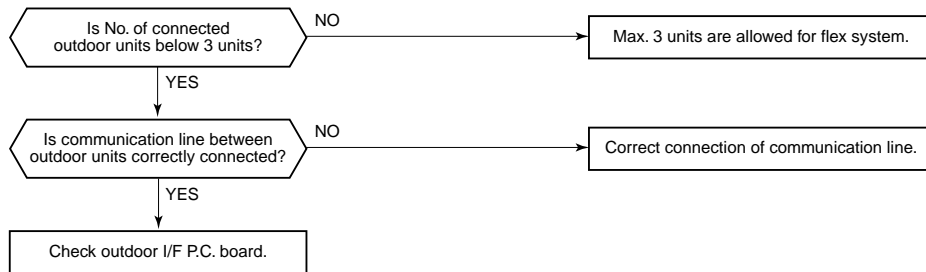

Check code name	Check code name	Cause of operation
[L29]	IPDU quantity error	1. Incorrect model setup in service for I/F P.C. board 2. Communication error between IPDU, fan IPDU and I/F 3. IPDU, fan IPDU, I/F P.C. board error

Auxiliary code :
 01: IPDU1 error
 02: IPDU2 error
 03: IPDU1, 2 error
 04: Fan IPDU error
 05: IPDU1, fan IPDU error
 06: IPDU2, fan IPDU error
 07: All IPDU error or disconnection of communication line between IPDU-I/F P.C. board or outdoor I/F P.C. board error

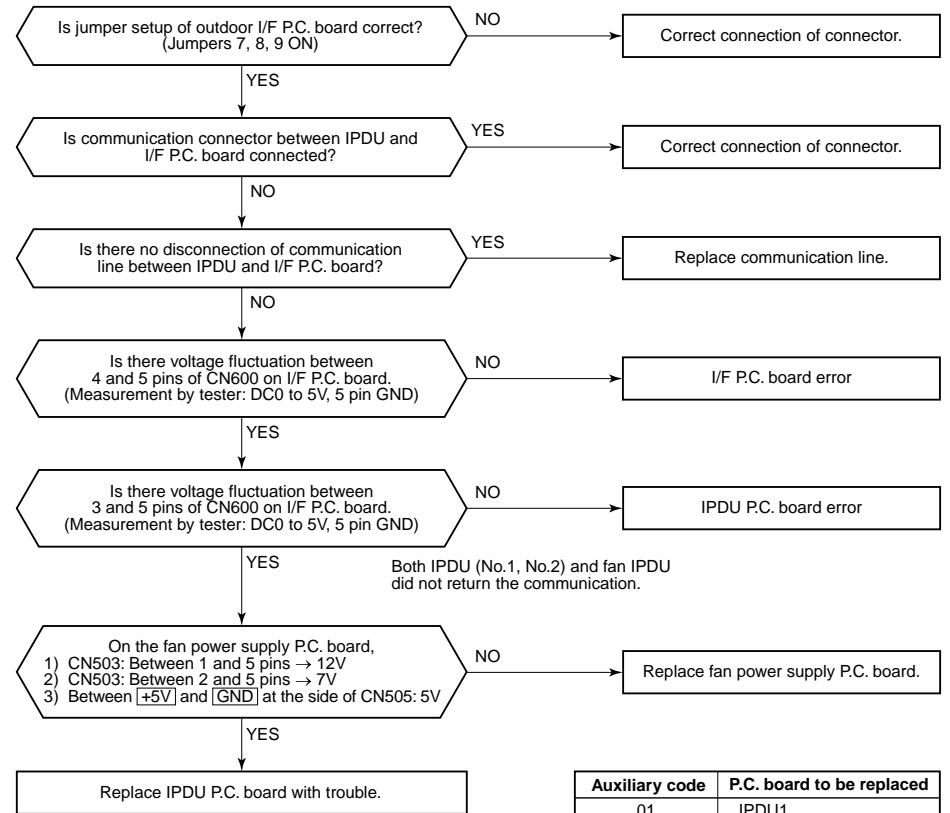

Auxiliary code	P.C. board to be replaced
01	IPDU1
02	IPDU2
03	IPDU1, 2
04	Fan IPDU
05	IPDU1, fan IPDU
06	IPDU2, fan IPDU
07	IPDU1, 2, fan IPDU, I/F

Check code name	Check code name	Cause of operation
[L30]	Interlock in indoor unit from outside	Outside error was input.

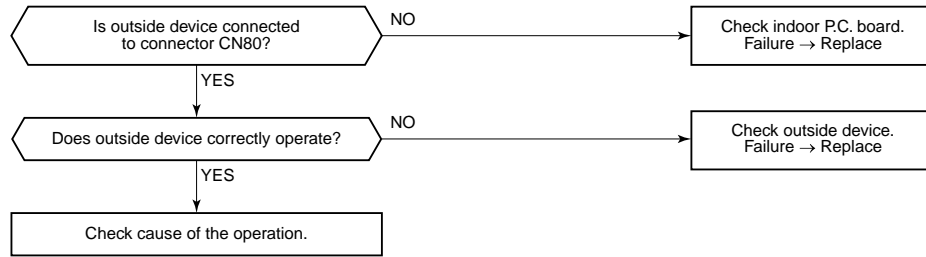

Check code name	Check code name	Cause of operation
[L31]	Extended IC error	1. Outdoor unit power error 2. Outdoor I/F P.C. board error

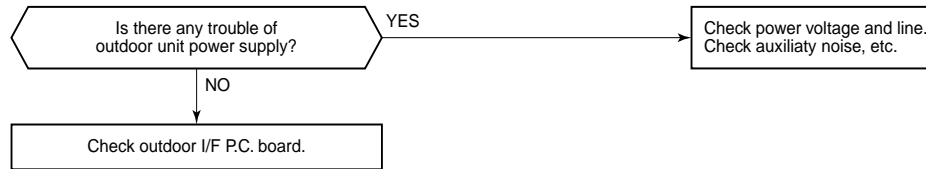

Check code name	Check code name	Cause of operation
[P01]	Indoor fan motor error	1. Cabling error 2. Check fan motor.

* For the models installed with AC fan motor only

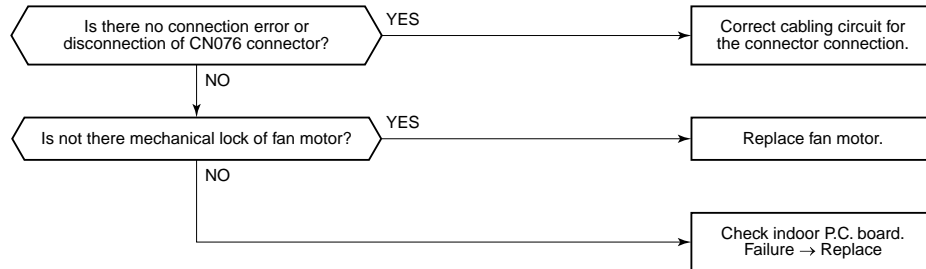

Check code name	Check code name	Cause of operation
[P03]	Discharge temp TD1 error	1. Service valve of outdoor unit closed. 2. Outdoor PMV1, 2 error 3. TD sensor error 4. Refrigerant short, clogging in pipe 5. 4-way valve error 6. SV4 circuit leakage, misinstallation 7. SV5 circuit leakage 8. SV6 circuit clogging 9. Discharge gas/Suction gas pipes mispiping 10. Flow selector unit error

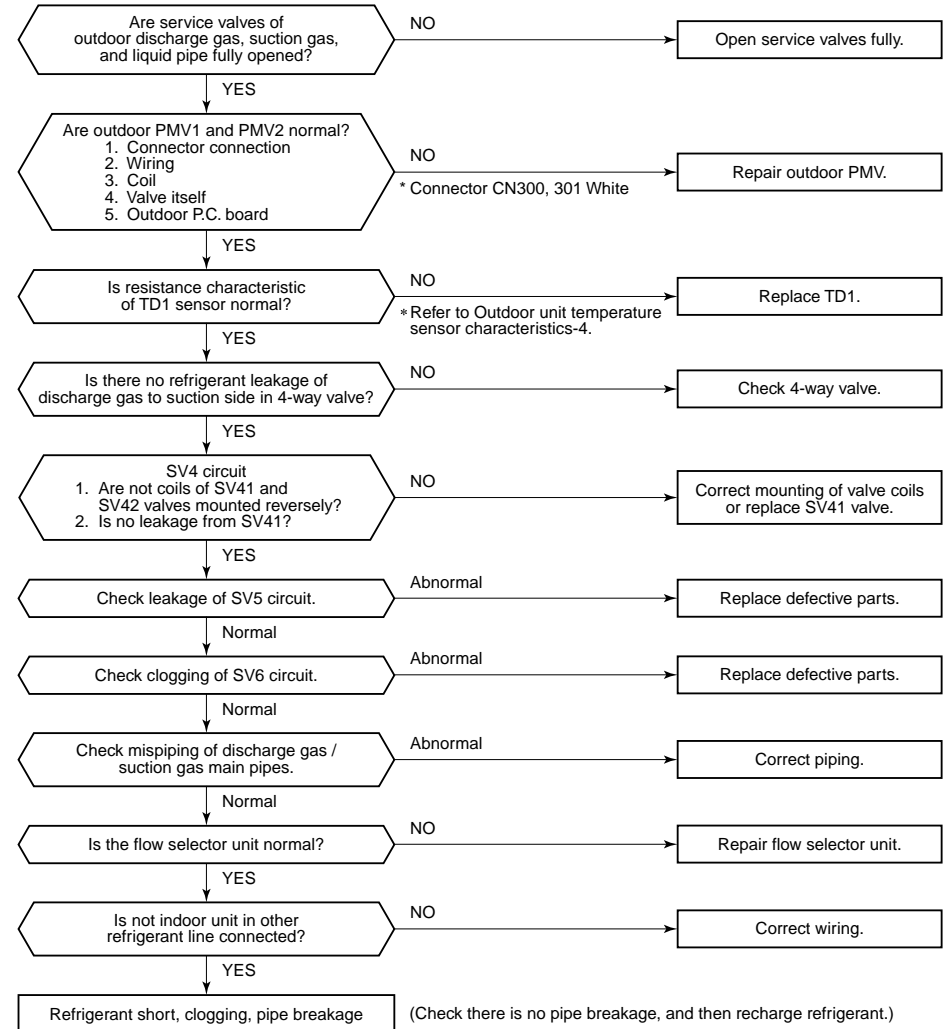

Check code name	Check code name	Cause of operation
[P04]	Actuation of high-pressure SW	1. High-pressure SW error 2. Service valve closed 3. Pd sensor error 4. Indoor/outdoor fan error 5. Indoor/outdoor PMV choke 6. Indoor/outdoor heat exchanger clogging, air short circuit 7. SV2 circuit error 8. SV4 circuit error 9. SV5 circuit error 10. Discharge line check valve malfunction 11. Refrigerant overcharge

Auxiliary code : Compressor 1 side 02: Compressor 2 side

Note) High-pressure SW is normally closed. (B contact)

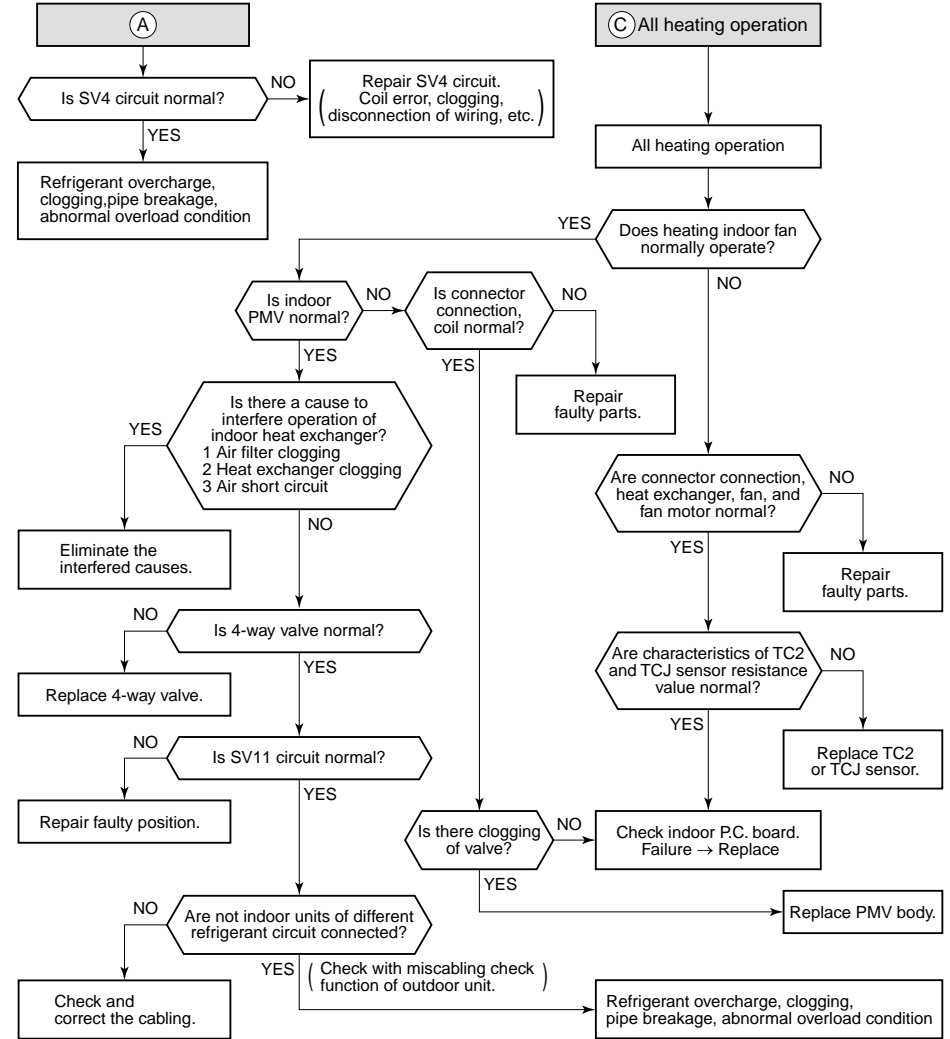
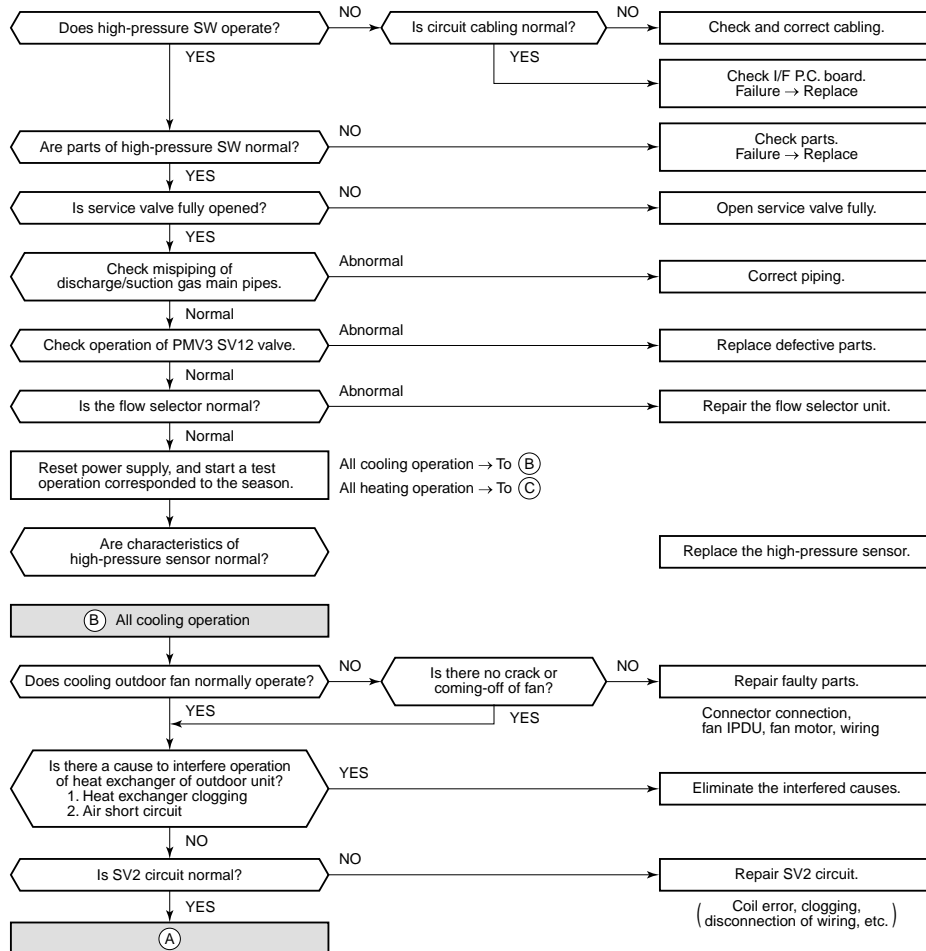

Check code name	Check code name	Cause of operation
[P05]	Open phase, negative phase	1. Power supply open phase 2. Power supply negative phase

- Check the phase power line of outdoor unit.
- Check error of outdoor I/F P.C. board.
- Check there is no looseness, etc of terminal.

Check code name	Check code name	Cause of operation
[P07]	Heat sink overheat error	1. Power voltage error 2. Outdoor fan system error 3. Heat sink installation error 4. Clogging of hear sink cooling duct 5. IPDU P.C. board error (TH sensor error)

Auxiliary code : 01: Compressor 1 side 02: Compressor 2 side

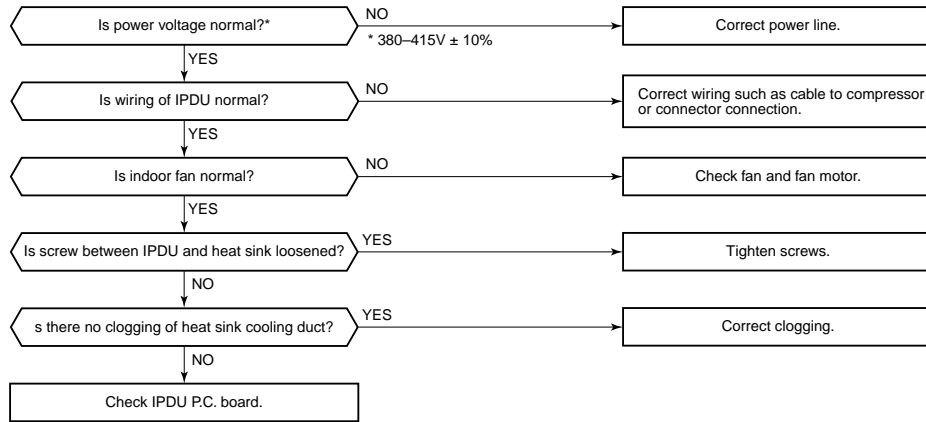

Check code name	Check code name	Cause of operation
[P10]	Indoor overflow error	1. Float SW operation error 2. Drain pump operation error 3. Clogging of drain pipe 4. Indoor P.C. board error

Auxiliary code : Indoor address with trouble

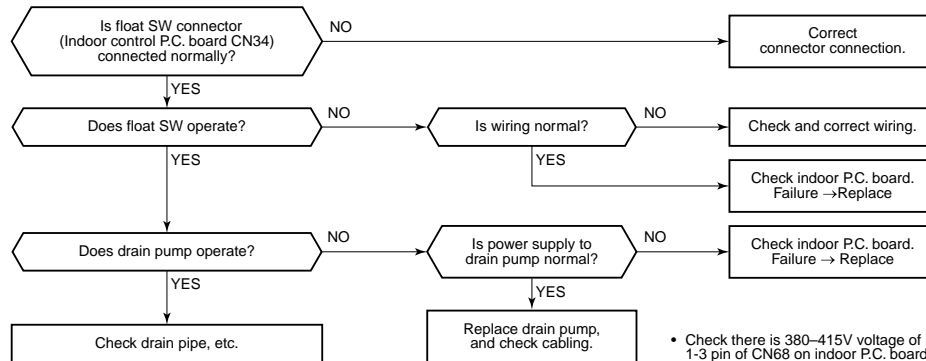

Check code name	Check code name	Cause of operation
[P12]	Indoor fan motor error	1. Cabling error of fan motor connector 2. Fan motor error 3. Indoor P.C. board error

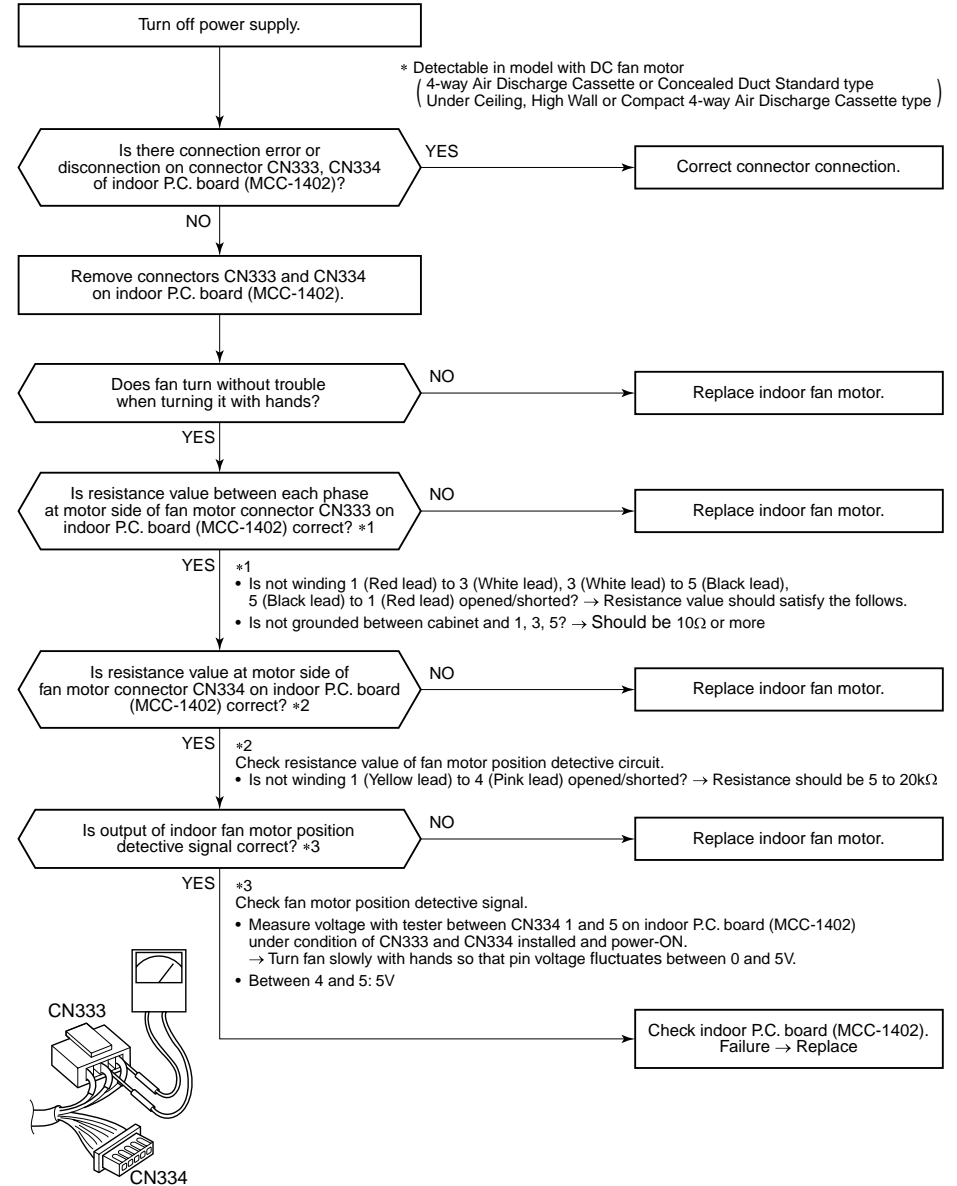

Check code name	Check code name	Cause of operation
[P13]	Outdoor liquid back detection error	1. PMV1/PMV2 error 2. Pd sensor, Ps sensor error 3. Clogging of SV2 circuit 4. Clogging of SV3B circuit, balance pipe 5. Leakage of main discharge pipe 6. Outdoor I/F P.C. board error

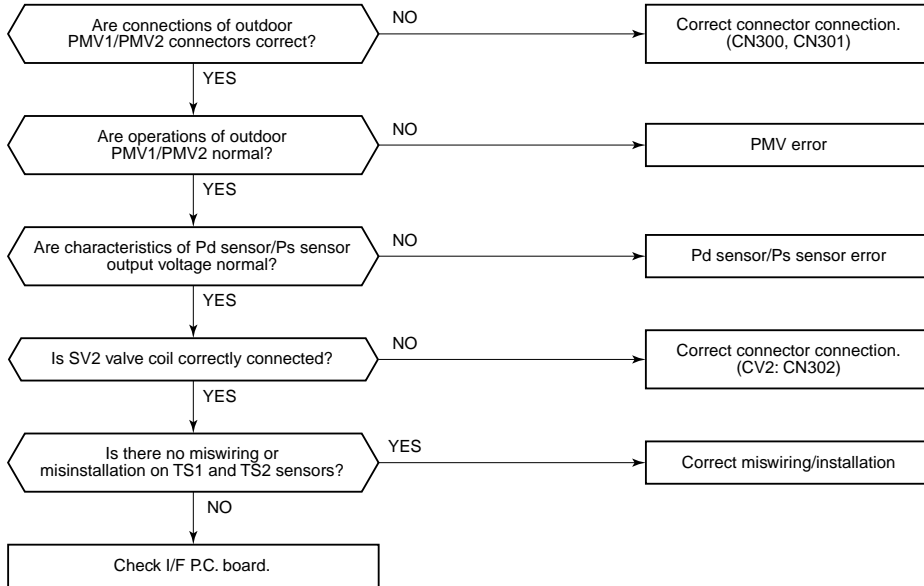

Check code name	Check code name	Cause of operation
[P15]	Gas leak detection TS condition (Auxiliary code : 01)	1. Outdoor unit service valve closed 2. Outdoor PMV error 3. TS1 sensor error 4. Refrigerant shortage, clogging refrigerant circuit 5. 4-way valve error 6. SV4 circuit error

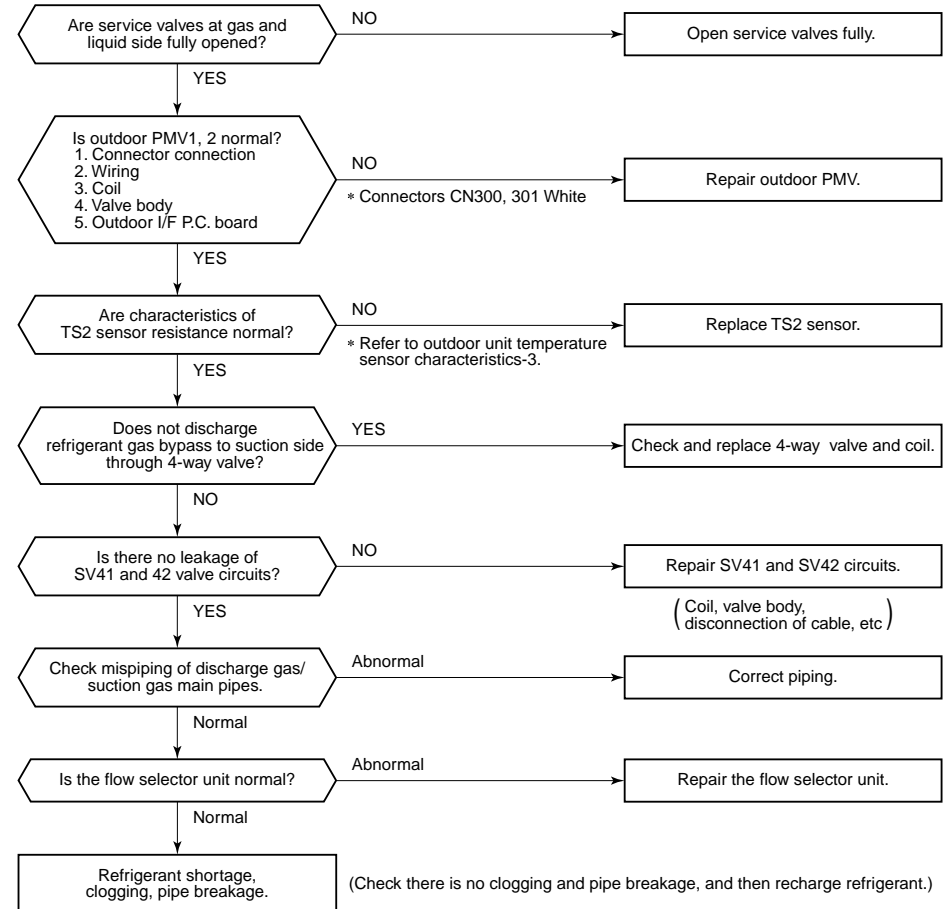

Check code name	Check code name	Cause of operation
[P15]	Gas leak detection TD condition (Auxiliary code : 02)	1. Outdoor unit service valve closed 2. Outdoor PMV error 3. TD sensor error 4. SV4 circuit error 5. Refrigerant shortage, clogging refrigerant circuit

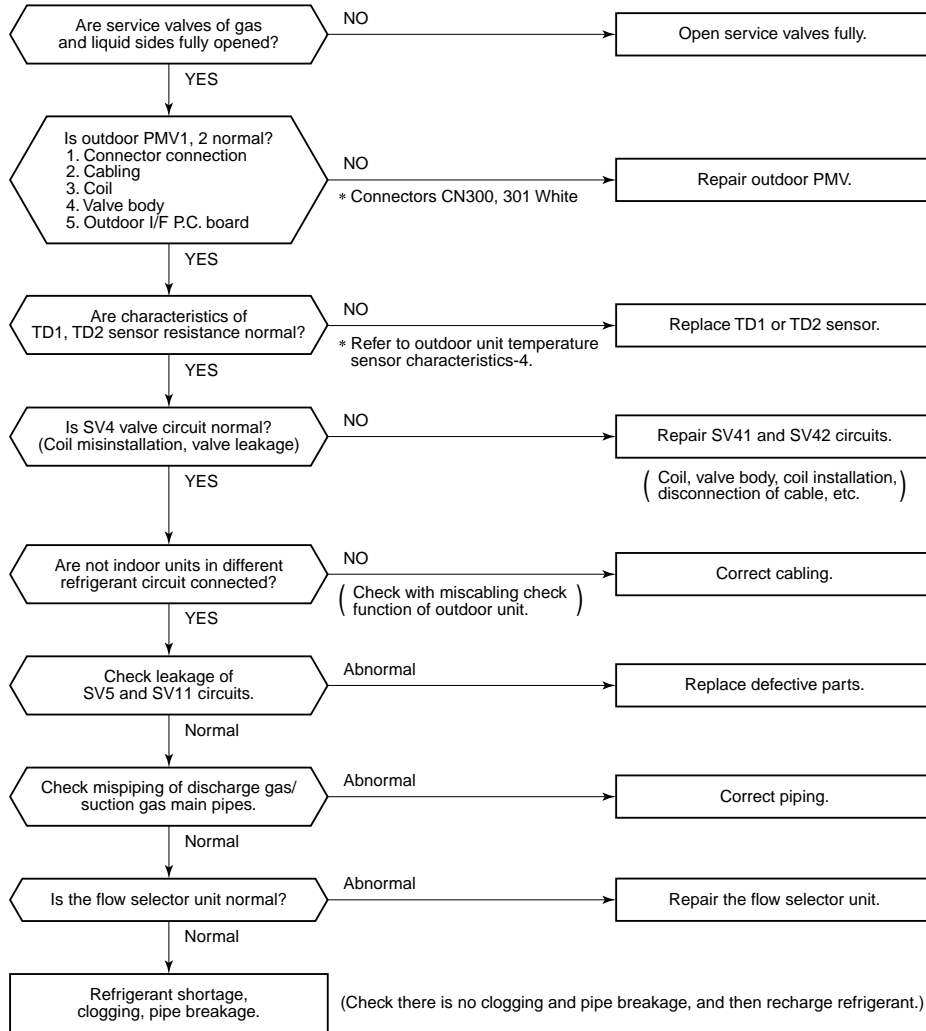

Check code name	Check code name	Cause of operation
[P17]	Discharge temp TD2 error	1. Outdoor unit service valve closed 2. Outdoor PMV error 3. TD sensor error 4. Refrigerant shortage, clogging of refrigerant circuit 5. 4-way valve error 6. SV4 circuit leakage, misinstallation 7. SV5 circuit leakage 8. SV6 circuit clogging 9. Mispiping of discharge gas/suction gas pipes 10. Flow selector unit error

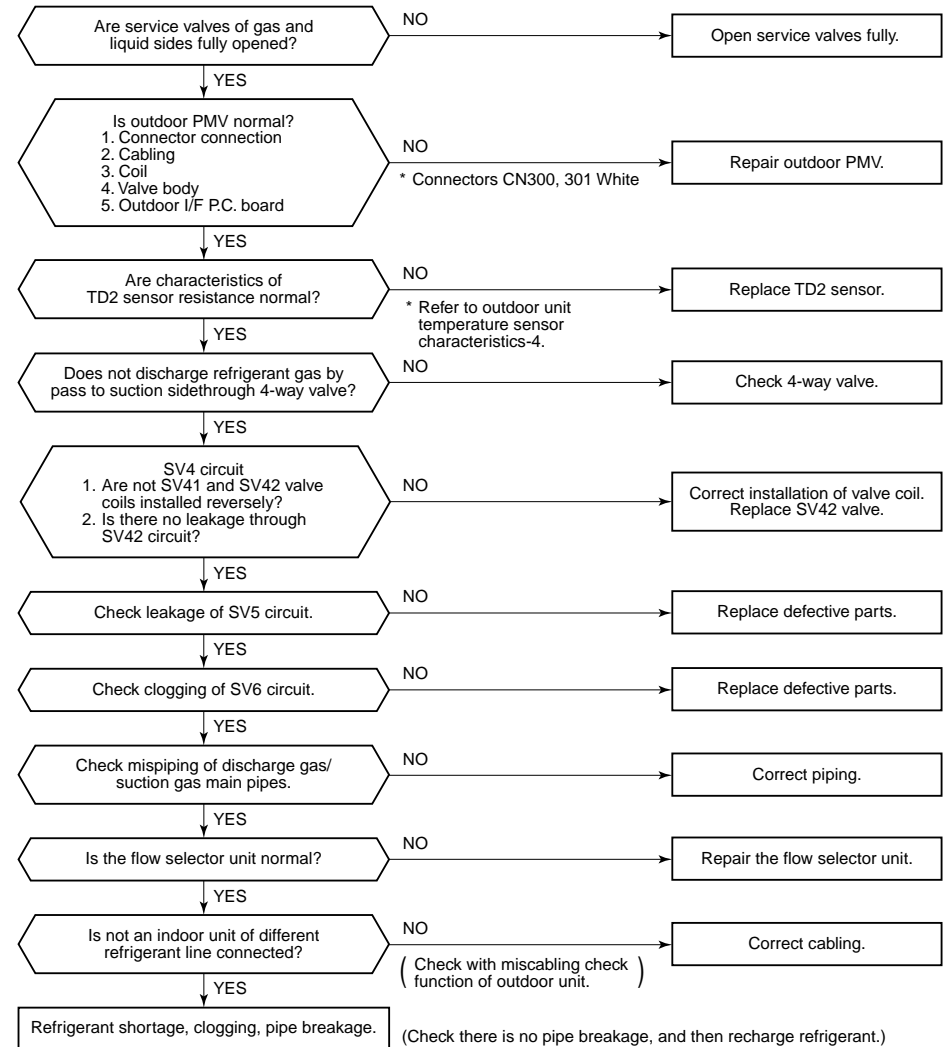

Check code name	Check code name	Cause of operation
[P19]	4-way valve operation error	1. 4-way valve error 2. TS1 sensor/TE1 sensor error 3. Pd sensor/Ps sensor error 4. TE sensor/TL sensor misconnection

Auxiliary code : Detected outdoor unit No.

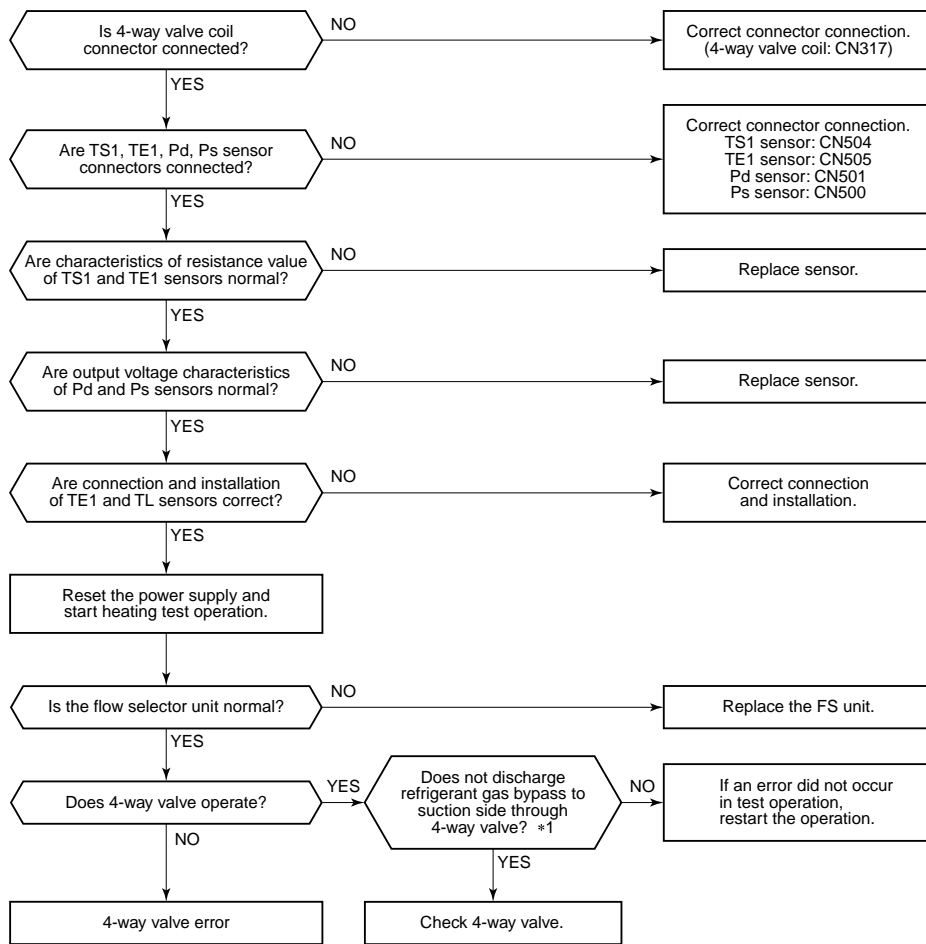

*1 Check TS and TE temperature of the outdoor unit which compressors is operated.
 (I/F) SW01=[1], SW02=[6], SW03=[2] → TS sensor temperature
 SW01=[1], SW02=[7], SW03=[2] → TE sensor temperature
<Judgment criteria>
 TE sensor: Normal if TE ≤ 20°C except summer season (Outside temp 20°C or lower)
 TS sensor: Normal if TS ≤ 40°C except summer season (Outside temp 20°C or lower)

Check code name	Check code name	Cause of operation
[P20]	High-pressure protective operation	1. Pd sensor error 2. Service valve closed. 3. Indoor/outdoor fan error 4. Indoor/outdoor PMV clogging 5. Indoor/outdoor heat exchanger clogging 6. SV2 circuit error 7. SV4 circuit error 8. SV5 circuit error 9. Outdoor I/F P.C. board error 10. Operation error of check valve of main discharge pipe 11. Refrigerant overcharge

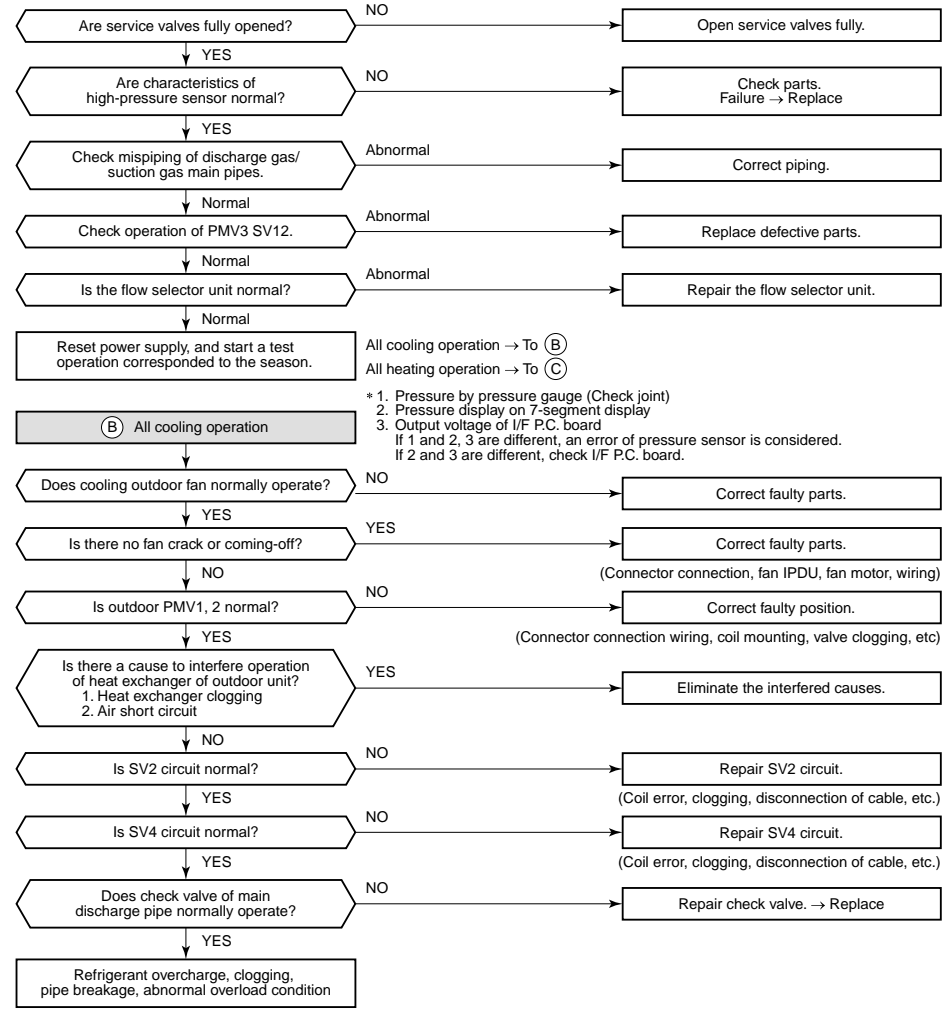

* 1. Pressure by pressure gauge (Check joint)
 2. Pressure display on 7-segment display
 3. Output voltage of I/F P.C. board
 If 1 and 2, 3 are different, an error of pressure sensor is considered.
 If 2 and 3 are different, check I/F P.C. board.

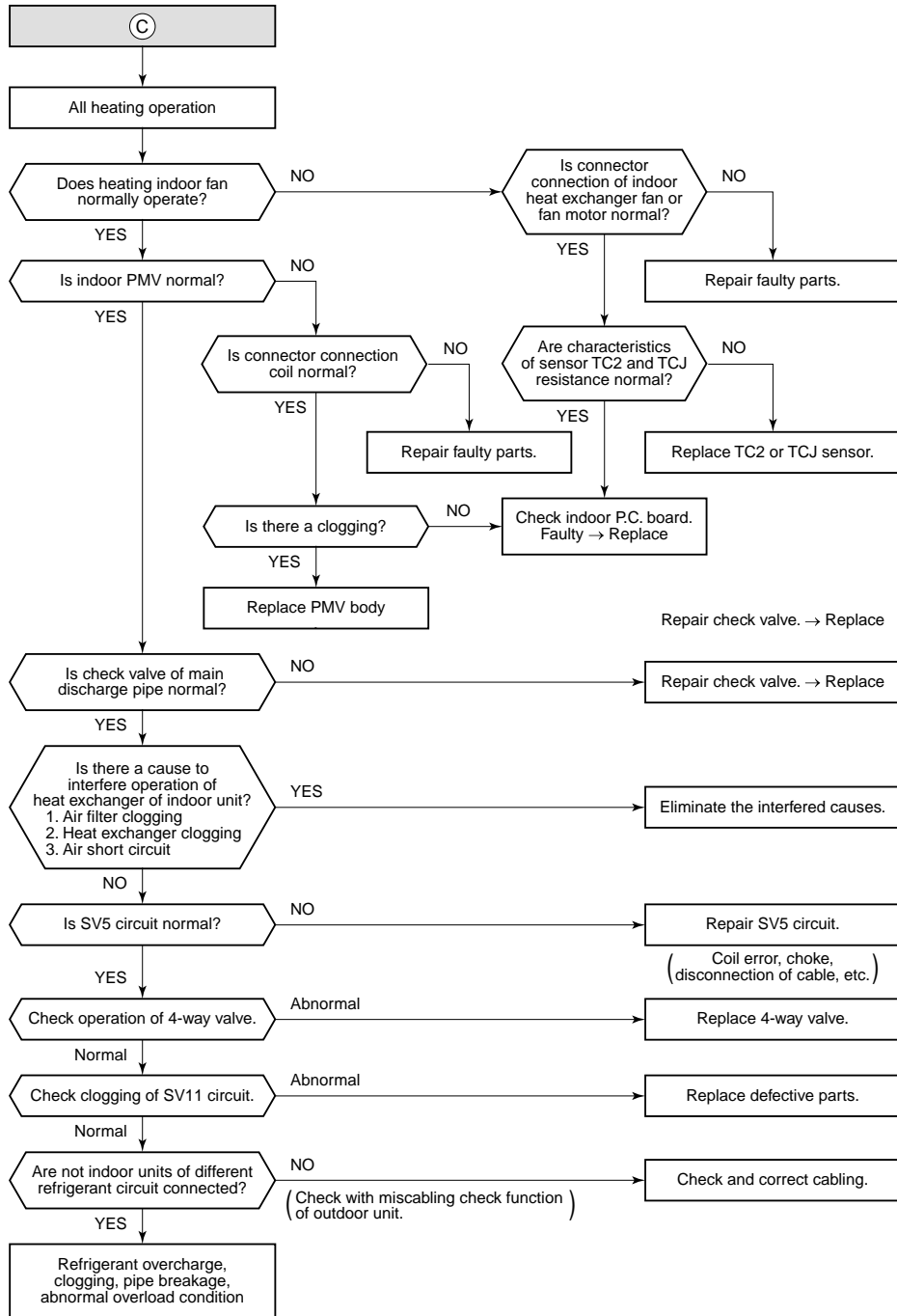

Check code name	Check code name	Cause of operation
[P22]	Outdoor fan IPDU error	1. Fan lock 2. Fan IPDU P.C. board error 3. Overload cause 4. External cause such as blast 5. Fan IPDU power P.C. board error

Auxiliary code: 0* : IGBT short circuit
 3* : Motor lock error
 C* : TH sensor error (Heat sink overheating)
 E* : Vdc error
 1* : Position detect circuit error
 4* : Motor current error detected
 D* : TH sensor error

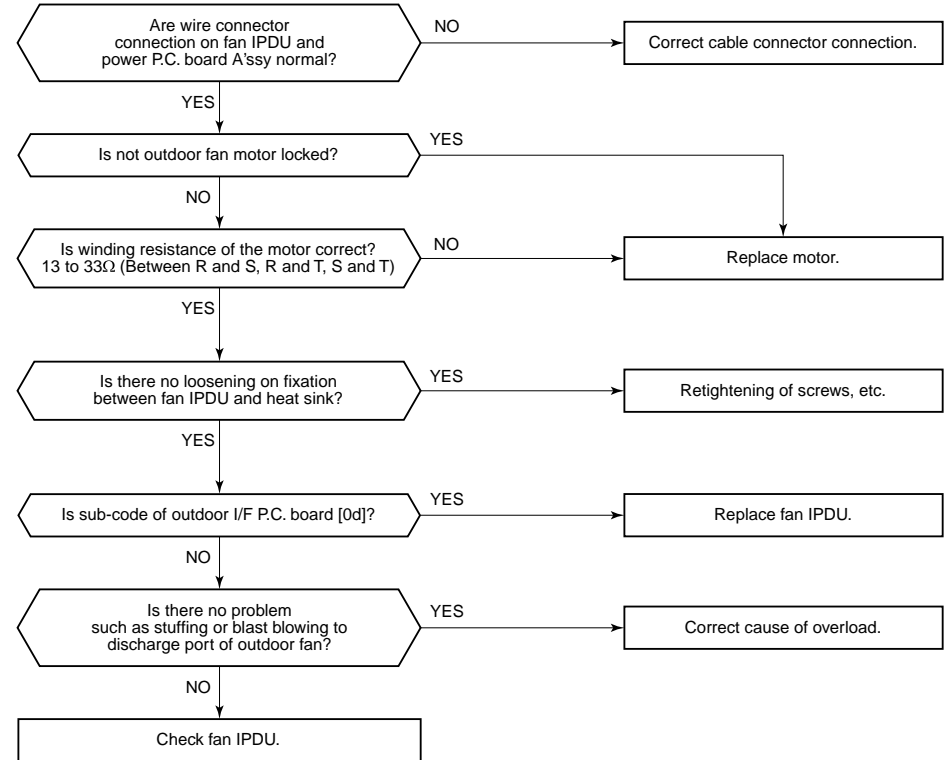

Check code name	Check code name	Cause of operation
[P26]	G-Tr short-circuit protection error	1. Outdoor unit power error 2. IPDU error/Cable connection error 3. Compressor error 4. IPDU P.C. board error

Auxiliary code : 01: Compressor 1 side 02: Compressor 2 side

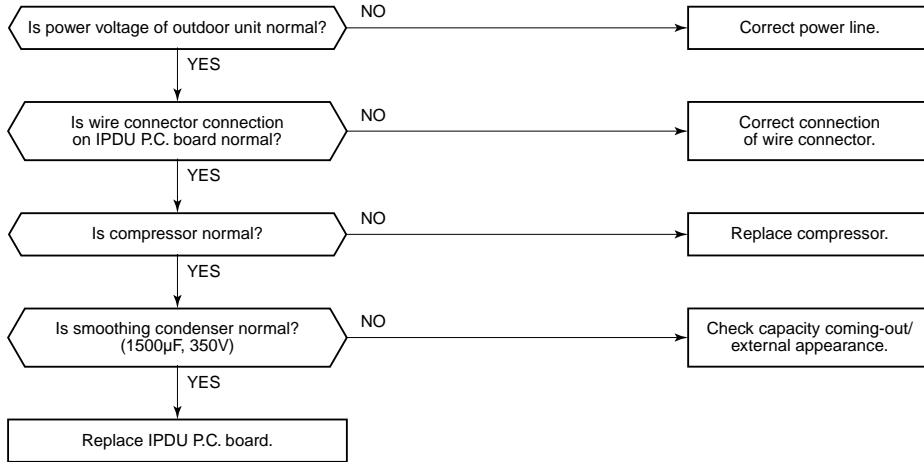

Check code name	Check code name	Cause of operation
[P29]	Compressor position detective circuit error	1) Cable/connector connection error 2) Compressor error 3) IPDU P.C. board error

Auxiliary code : 01: Compressor 1 side 02: Compressor 2 side

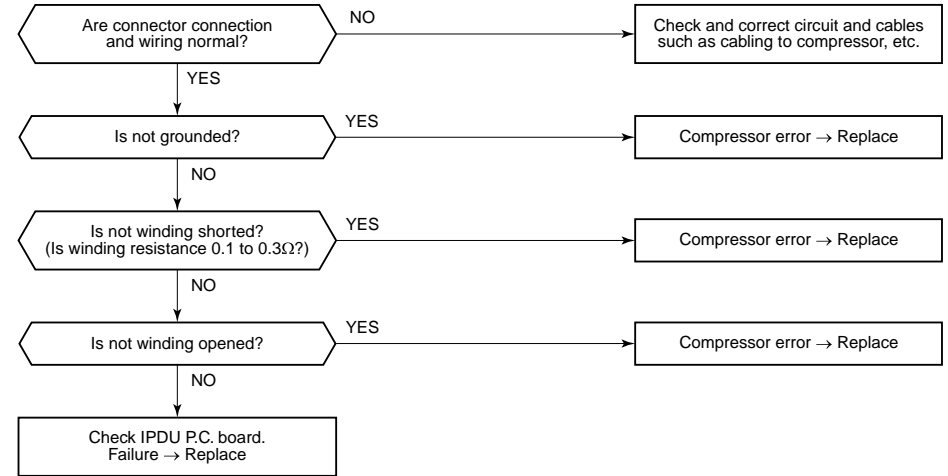

Check code name	Check code name	Cause of operation
[P31]	Other indoor error (Group follower unit error)	Other indoor unit in the group is abnormal.

When the header unit of the group detected [E03, L03, L07, L08 error], the follower unit of the group displays [P31] error and stops. There are no check code display and alarm record of the main remote controller.

7-6. 7-Segment Display Function

■ 7-segment display on the outdoor unit (Interface P.C. board)

On the interface control P.C. board, 7-segment LED to check the operating status is provided on the control P.C. board.

The displayed contents are changed by combining the setup numbers of the rotary switches (SW01, SW02, and SW03) on P.C. board.

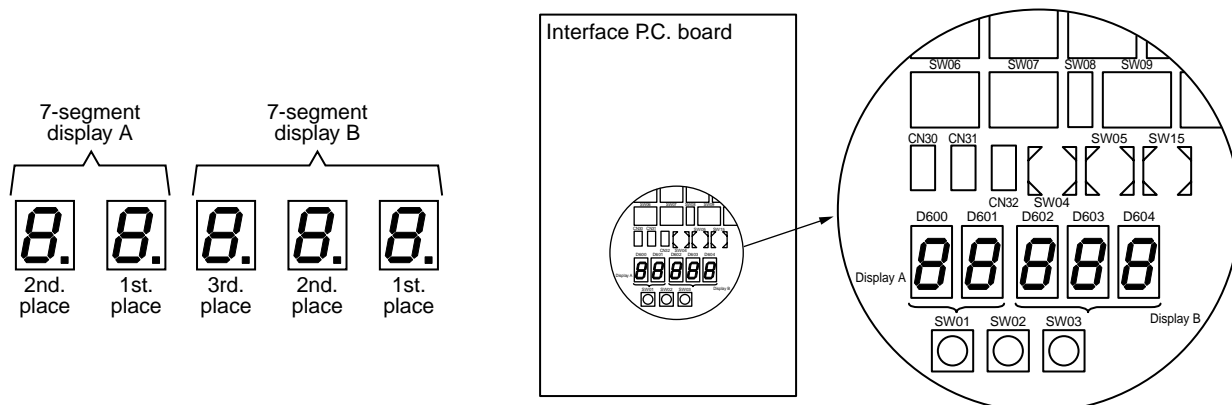

◆ Check procedure in case of stop with trouble

When the system stopped due to a trouble of the outdoor unit, execute a check in the following procedure.

1. Open the panel of the outdoor unit, and then check the 7-segment display.

The check code is displayed at the right side of 7-segment display B.

[U1][000] ([000]: Check code)

* Switch setup when confirming the check code: SW01 [1], SW02 [1], SW03 [1]

However the check code [000] is displayed for 3 seconds and the auxiliary code [000] for 1 second are alternately displayed if an auxiliary code is provided.

2. Confirm the check code, and then conduct the check operation based on the procedure of each check code diagnosis.

3. [U1][E28] on 7-segment display means a trouble on the follower unit.

Push the push-switch SW04 on the header unit for several seconds. (2 seconds or more)

As only the fan of the outdoor unit with a trouble drives, open the panel of the corresponding unit, and then confirm the check code displayed with 7-segment.

4. Perform the check operation based on the procedure of each check code diagnosis.

How to read the check monitor

<7-segment display>

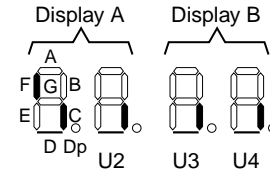

1. Data display of system information (Displayed on the header outdoor unit only)

SW01	SW02	SW03	Display contents				
1	1	3	Refrigerant name	Displays refrigerant name.		A	B
				Model with refrigerant R410A		r4	10A
				Model with refrigerant R407C		r4	07C
	2	System capacity	A	[5] to [48] : 5 to 48HP			
			B	[HP]			
	3	No. of outdoor units	A	[1] to [4] : 1 to 4 units			
			B	[P]			
	4	No. of connected indoor units/ No. of units with cooling thermo ON	A	[0] to [48] : 0 to 48 units (No. of connected units)			
			B	[C0] to [C48] : 0 to 48 units (No. of units with cooling thermo ON)			
	5	No. of connected indoor units/ No. of units with heating thermo ON	A	[0] to [48] : 0 to 48 units (No. of connected units)			
			B	[H0] to [H48] : 0 to 48 units (No. of units with heating thermo ON)			
	6	Compressor command correction amount	A	Data is displayed with hexadecimal notation			
			B				
	7	Release control	A	Normal time : [r], During release control: [r1]			
			B	—			
	8	Oil-equalization control	A	Normal time : [oiL-0]			
B			During oil equation : [oiL-1]				
9	Oil-equalization request	A	Displays with segment LED lighting pattern				
		B	 <p>F in the left figure goes on: Header requests oil equalization. C in the left figure goes on: Follower requests oil-equalization. (Outdoor unit number)</p>				
10	Refrigerant/oil recovery operation	A	During sending of cooling refrigerant oil recovery signal : [C1]. Normal time : [C]				
		B	During sending of heating refrigerant oil recovery signal : [H1]. Normal time : [H]				
11	Automatic address	A	[Ad]				
		B	Automatic addressing : [FF], Normal time : []				
12	Demand operation	A	[dU]				
		B	Normal time : []. In 50% to 90% : [50 to 90] When controlling by communication line input : [E50 to E90]				
13	Optional control (P.C. board input)	Displays optioned control status		A	B		
		Operation mode selection : In heating with priority (Normal)		h.*	*.*.*.		
		Priority on cooling		c.*	*.*.*.		
		Heating only		H.*	*.*.*.		
		Cooling only		C.*	*.*.*.		
		Priority on No. of operating indoor units		n.*	*.*.*.		
		Priority on specific indoor unit		U.*	*.*.*.		
		Batch start/stop : Normal		*.*.*.	*.*.*.		
		Start input		*.1.	*.*.*.		
		Stop input		*.0.	*.*.*.		
		Night low-noise operation : Normal		*.*.	*.*.*.		
		Operation input		*.*.	1.*.*.		
		Snow fan operation : Normal		*.*.	*.*.*.		
Operation input		*.*.	*.1.*.				
14	Option control (BUS line input)	Same as above					
15	Unused						
16	—	A	—				
		B	—				

* mark: Indicates none on display

2. Data display of outdoor unit information (Displayed on each outdoor unit)

SW01	SW02	SW03	Display contents					
1	1	1	Error data	A	Displays outdoor unit number: [U1] to [U4]			
				B	Displays check code (Latest code only is displayed.) There is no check code: [— — —] There is auxiliary code: Check code [* * *] for 3 seconds, auxiliary code [— * *] for 1 second alternately			
					<SW04> push function : Fan of unit with error only drives. 7-segment A: [E1] <SW04 + SW05> push function : Fan of normal unit only drives. 7-segment A: [E0] <SW05> push function : Interruption of fan operation function			
	2		—	A	—			
				B	—			
3			Operation mode	A	Stop: [] Normal cooling: [C], Normal heating: [H], Normal defrost: [J]			
				B	—			
4			Outdoor unit HP	A	5HP: [5], 6HP: [6], 8HP: [8], 10HP: [10], 12HP: [12]			
				B	[HP]			
5			Compressor operation command	A	No.1 compressor operation command is displayed. Data display with Hexadecimal notation: [00 to FF]			
				B	No.2 compressor operation command is displayed. Data display with Hexadecimal notation: [00 to FF]			
					<SW04> push function : Inverter frequency is exchanged to decimal notation. 7-segment display (A/B) : [* *] [* * H] (Normal display by pushing <SW05>)			
6			Outdoor fan step	A	[FP]			
				B	Step 0 to 31: [0 to 31]			
7			Compressor backup	A	Displays No.1 compressor setup status Normal: [], Backup setup: [C1]			
				B	Displays No.2 compressor setup status Normal: [], Backup setup: [C2]			
8			—	A	—			
				B	—			
9			Control valve output data	Displays control output status of solenoid valve			A	B
				4-way valve: ON	H. 1	… … …		
				4-way valve: OFF	H. 0	… … …		
10				SV2: ON / SV5: OFF	2. 1	… 5. 0		
				SV2: OFF / SV5: ON	2. 0	… 5. 1		
11				SV3A: ON / SV3B: OFF / SV3C: OFF /SV3D: OFF	3. 1	0 0 0		
				SV3A: OFF / SV3B: ON / SV3C: OFF /SV3D: OFF	3. 0	1 0 0		
				SV3A: OFF / SV3B: OFF / SV3C: ON /SV3D: OFF	3. 0	0 1 0		
				SV3A: OFF / SV3B: OFF / SV3C: OFF /SV3D: ON	3. 0	0 0 1		
12				SV41: ON / SV42: OFF	4. …	1 0 …		
				SV41: OFF / SV42: ON	4. …	0 1 …		
13				—	… … …	… … …		
				—	… … …	… … …		
14		PMV1 /PMV2 opening		Displays opening data (Decimal) (Total opening)			* *	* *. P
15		—	—			… *	* *. P	
16			Oil level judgment status	A	[oL] <SW05> push SW function: The following data is displayed for 2 seconds. * During oil shortage in compressor 1: [L …], during oil shortage in compressor 2: [… L]			
				B	Initial display: [… … …], Oil level judgment result: [A. #. *] Judgment result of compressor 1 in [#], compressor 2 in [*] (0: Normal, 1, 2: Shortage) is displayed.			

3. Data display of outdoor cycle (Displayed on each outdoor unit)

SW01	SW02	SW03	Display contents					
1	1	2	Pd pressure data	Pd pressure (MPaG) is displayed with decimal data. (MPaG: Approx. 1/10 value of kg/cm ² G data)		A	B	
						P d.	*. *. *	
			2	Ps pressure data	Ps pressure (MPaG) is displayed with decimal data.		P S.	*. *. *
			3	PL pressure conversion data	Estimated pressure of liquid line (MPaG) is displayed with decimal data.		P L.	*. *. *
			4	TD1 sensor data	Temperature sensor data (°C) is displayed with decimal notation.	Symbol	t d	1
						Data	*	*. *. *
			5	TD2 sensor data	<ul style="list-style-type: none"> Symbol display for 1 sec. and data display for 3 sec. are alternately displayed. Data is displayed in [*]. 	Symbol	t d	2
						Data	*	*. *. *
			6	TS1 sensor data	<ul style="list-style-type: none"> Negative data is displayed as [- * * * *]. 	Symbol	t S	1
						Data	*	*. *. *
			7	TS2 sensor data		Symbol	tS	2
						Data	*	*. *. *
			8	TE sensor data		Symbol	tE	—
						Data	—	—
			9	TL sensor data		Symbol	t L	
						Data	*	*. *. *
10	TO sensor data		Symbol	t o				
			Data	*	*. *. *			
11	TK1 sensor data		Symbol	F 1				
			Data	*	*. *. *			
12	TK2 sensor data		Symbol	F 2				
			Data	*	*. *. *			
13	TK3 sensor data		Symbol	F 3				
			Data	*	*. *. *			
14	TK4 sensor data		Symbol	F 4				
			Data	*	*. *. *			
15	—	A	—					
			B	—				
16	—	A	—					
			B	—				

4. Data display of indoor unit information (Displayed on the header unit only)

SW01	SW02	SW03	Display contents			
4	1 to 16	1 to 3	Receiving status of indoor BUS communication	B	Receiving time: [... .. 1], Not received: [... ..]	
5			Indoor check code	B	No check code: [— —]	
6			Indoor capacity (HP) horse power	B	0.2, 0.5, 0.8, ... 1, 1.2, 1.7, ... 2, 2.5, ... 3, 3.2, ... 4, ... 5, ... 6, ... 8, 10, 16, 20	
7			Indoor request command (S code)	B	Data is displayed with Hexadecimal notation [... .. 0 to F] : Heating	
8			Indoor PMV opening data	B	Data is displayed with Hexadecimal notation	
9			Indoor TA sensor data	B	Data is displayed with Hexadecimal notation	
10			Indoor TF sensor data	B	Data is displayed with Hexadecimal notation	
11			Indoor TCJ sensor data	B	Data is displayed with Hexadecimal notation	
12			Indoor TC1 sensor data	B	Data is displayed with Hexadecimal notation	
13			Indoor TC2 sensor data	B	Data is displayed with Hexadecimal notation	

NOTE) Indoor address No. is chosen by changing SW02 and SW03.

SW03	SW02	Indoor address	7-segment display A
1	1 to 16	SW02 setup number	[01] to [16]
2	1 to 16	SW02 setup number + 16	[17] to [32]
3	1 to 16	SW02 setup number + 32	[33] to [48]

5. Outdoor EEPROM write-in error code display (Displayed on the header unit only)

* The latest error code written in EEPROM of each outdoor unit is displayed.

(It is used when confirming the error code after power supply has been reset.)

Set SW01 to 03 as shown in the following table, and the push SW04 for 5 seconds or more to display an error code.

W01	SW02	SW03	Display contents	7-segment display	
				A	B
1	1	16	The latest error code of the header unit 1 (U1)	E. r	1. ---
	2		The latest error code of the follower unit 1 (U2)	E. r	2. ---
	3		The latest error code of the follower unit 2 (U3)	E. r	3. ---

■ 7-segment display A, B

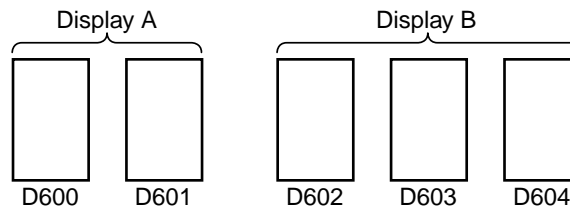

7-7. Sensor Characteristics

Indoor Unit

■ Temperature sensor characteristics

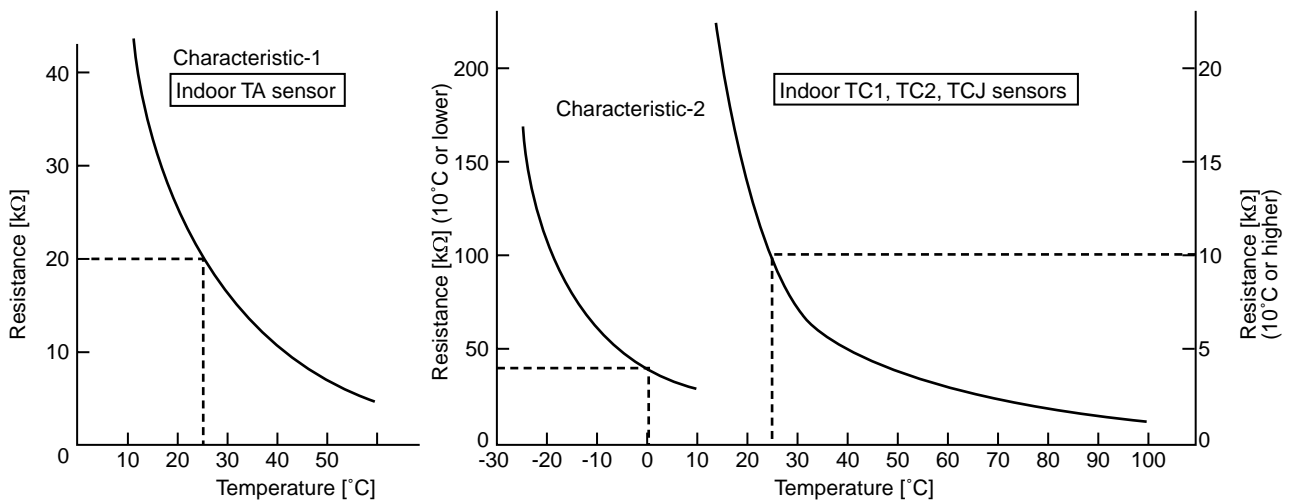

8. CONFIGURATION OF CONTROL CIRCUIT

8-1. Indoor Unit

8-1-1. Indoor Controller Block Diagram

Compact 4-way Air Discharge Cassette Type

1. Connection of wired remote controller

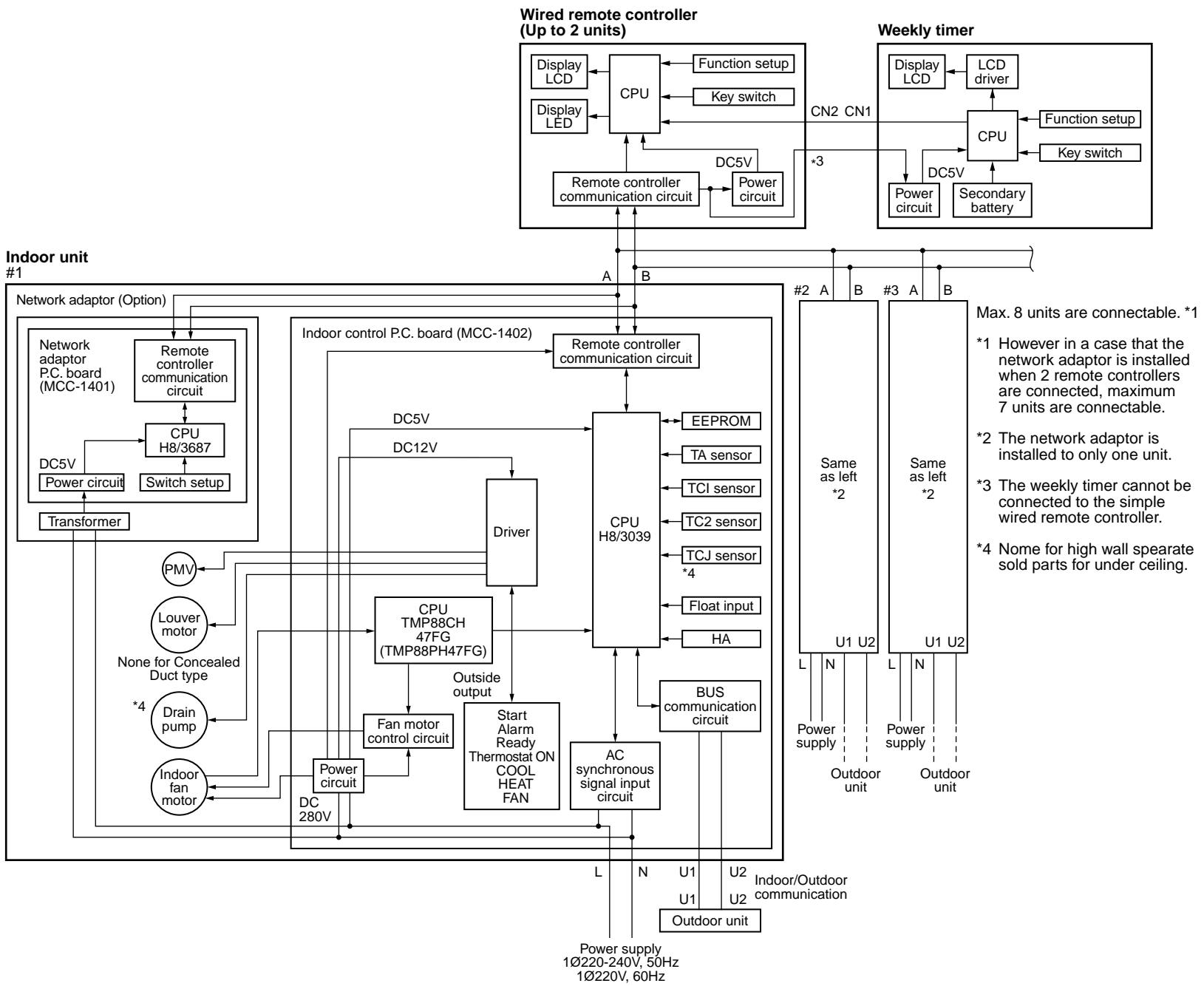

Indoor unit #1

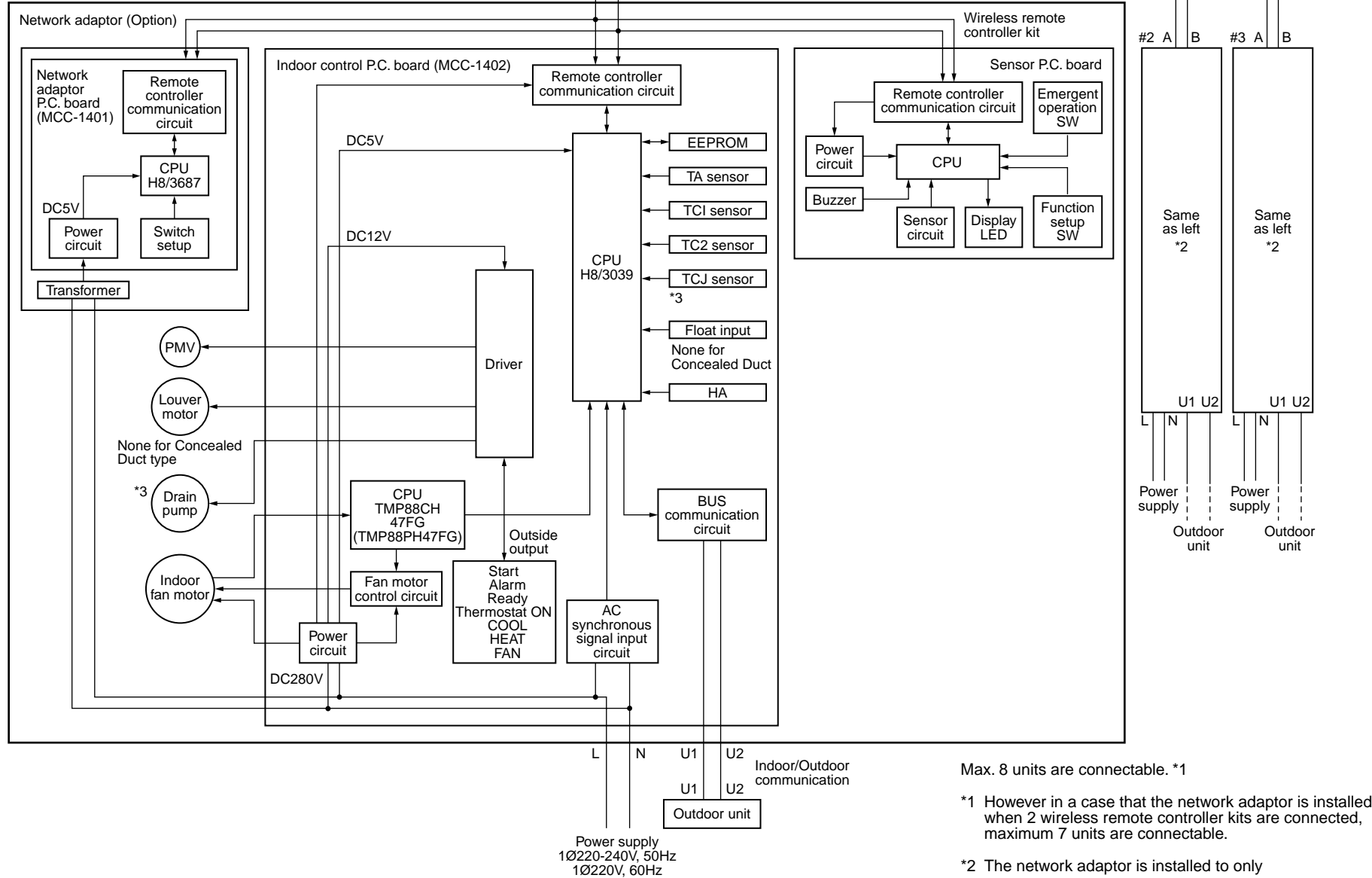

Power supply
 1Ø220-240V, 50Hz
 1Ø220V, 60Hz

Max. 8 units are connectable. *1

*1 However in a case that the network adaptor is installed when 2 wireless remote controller kits are connected, maximum 7 units are connectable.

*2 The network adaptor is installed to only

*3 None for high wall spearatesold parts for under ceiling. One unit.

**2. Connection of wireless remote controller kit
 Compact 4-way Air Discharge Cassette Type**

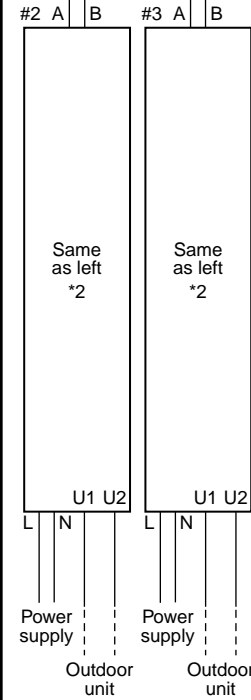

3. Connection of both remote controller and wireless remote controller kit Compact 4-way Air Discharge Cassette Type

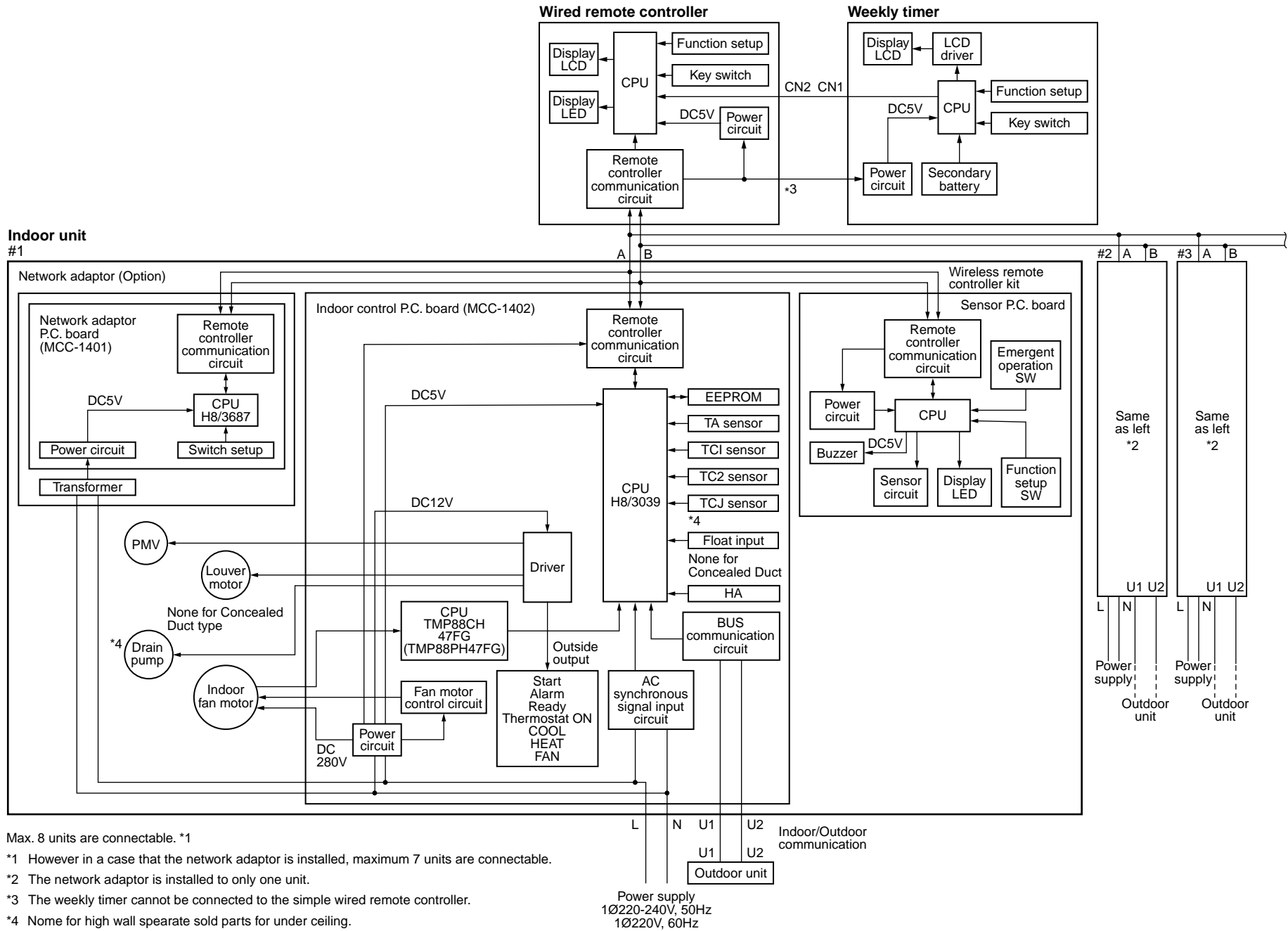

Max. 8 units are connectable. *1

*1 However in a case that the network adaptor is installed, maximum 7 units are connectable.

*2 The network adaptor is installed to only one unit.

*3 The weekly timer cannot be connected to the simple wired remote controller.

*4 None for high wall separate sold parts for under ceiling.

8-1-2. Indoor Print Circuit Board
MCC-1402
Compact 4-way Air Discharge Cassette Type

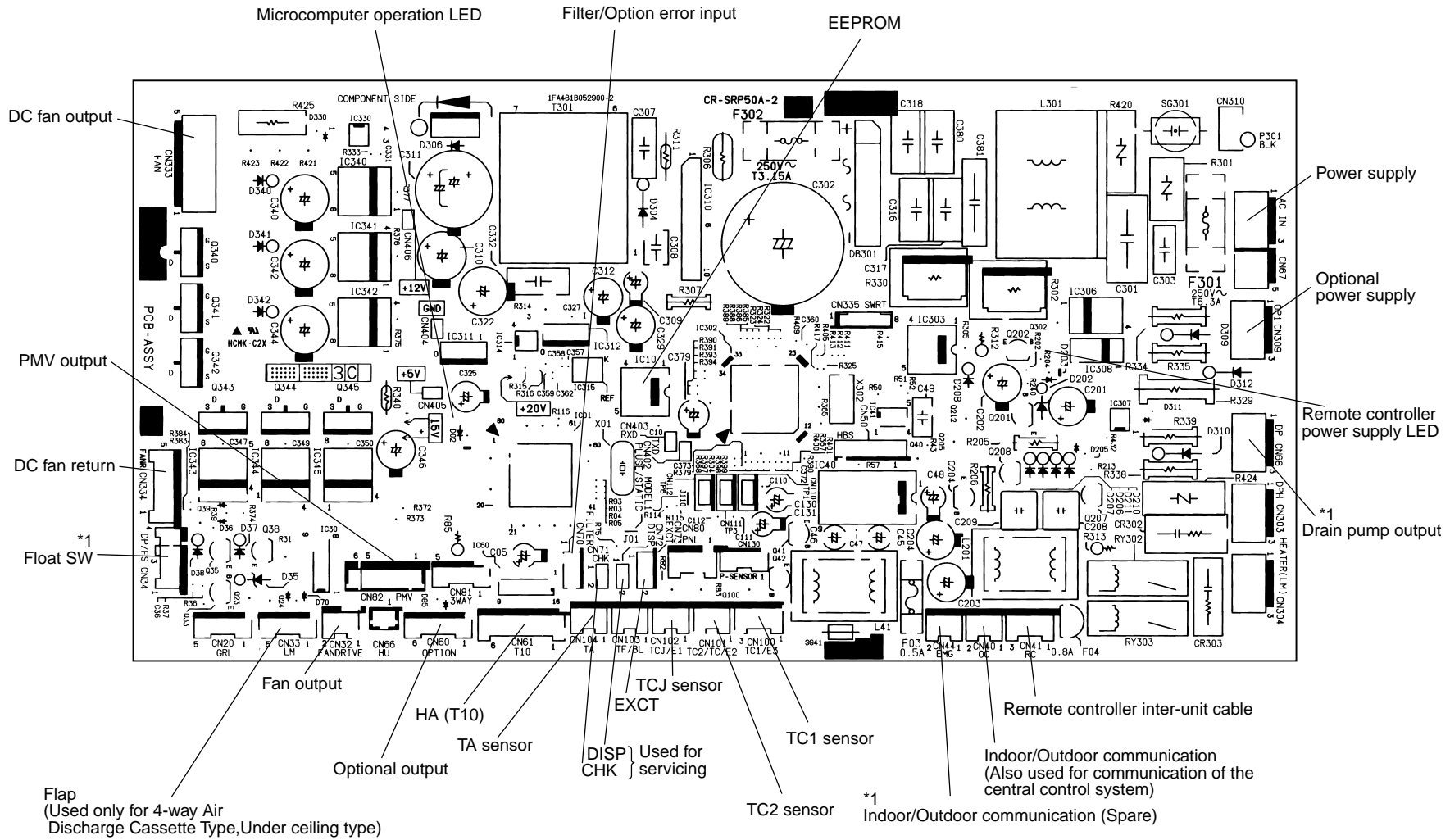

*1 : Used only for under-ceiling, high wall

8-1-3. Optional Connector Specifications of Indoor P.C. Board

Function	Connector No.	Pin No.	Specifications	Remarks
Humidifier output	CN66	①	DC12V	In heating, thermo ON, Fan ON, Humidifier output ON * Humidifier provided, Drain pump ON is set up by CN70 short-circuit or from remote controller. (DN=40)
		②	Output	
Fan output	CN32	①	DC12V	Shipment setup: ON with indoor unit operation and OFF with stop are linked. * Single operation by FAN button on remote controller is set up from remote controller (DN=31)
		②	Output	
—	CN61	①	ON/OFF input	HA ON/OFF input (J01: YES/NO=Pulse (At shipment) / Static input select)
		②	0V (COM)	
		③	Main prohibition input	Operation stop of main remote controller is permitted / prohibited by input.
		④	Operation output	ON during operation (Answerback of HA)
		⑤	DC12V (COM)	
		⑥	Alarm output	ON during alarm output
Option output	CN60	①	DC12V (COM)	
		②	Defrost output	ON when outdoor unit is defrosted
		③	Thermo ON output	ON during Real thermostat ON (Compressor ON)
		④	COOL output	ON when operation mode is cooling system (COOL, DRY, Cool/Heat Auto cooling)
		⑤	HEAT output	ON when operation mode is heating system (HEAT, Cool/Heat Auto cooling)
		⑥	Fan output	ON when indoor fan is ON (During use of air cleaner/Interlock cabling)
Outside error input	CN80	①	DC12V (COM)	Generate check code "L30" (for 1 minute continuously) to stop forcedly the operation.
		②	DC12V (COM)	
		③	Outside error input	
—	CN20	—	—	—
—	CN70	—	—	—
CHK operation check	CN71	①	Check mode input	Used for indoor operation check. (Outdoor does not communicate with remote controller, and outputs specified operation such as indoor fan "H", drain pump ON, etc.)
		②	0V	
DISP exhibition mode	CN72	①	Display mode input	Exhibition mode enables to communicate by indoor unit and remote controller only. (When power has been turned on.) Timer short (Usual)
		②	0V	
EXCT demand	CN73	①	Demand input	Indoor unit forced thermostat OFF operation
		②	0V	

9. DETACHMENTS

9-1. Indoor Unit

MMU-AP0071MH, AP0091MH, AP0121MH, AP0151MH, AP0181MH

Ceiling panel: RBC-UM11PG-E

Preparing work:

1. Before work, be sure to stop the power supply of the air conditioner and turn off switch of the power supply breaker. (Otherwise an electric shock may be caused.)
2. Be sure to put on the gloves when working; otherwise an injury may be caused with parts sharp edges etc.

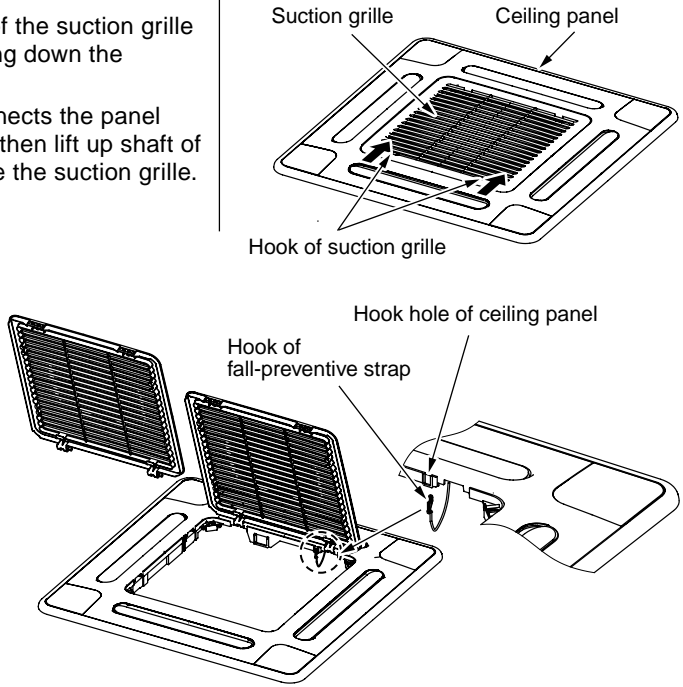
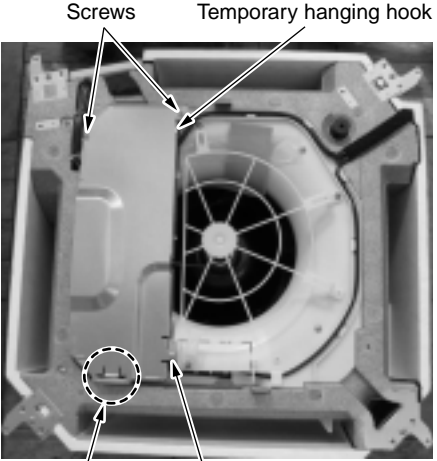
No.	Part name	Procedure	Remarks
①	Suction grille	<p>1. Detachment</p> <ol style="list-style-type: none"> 1) Slide hooks (2 positions) of the suction grille to inner side, and then hang down the suction grille. 2) Take off the strap that connects the panel and the suction grille, and then lift up shaft of the suction grille to remove the suction grille. <p>2. Attachment</p> <ol style="list-style-type: none"> 1) Hook shaft of the suction grille to the panel. 2) Hook strap of the suction grille to the original position of the panel. 3) Close the suction grille and slide the hooks outward to fix it. 	 <p>Suction grille Ceiling panel</p> <p>Hook of suction grille</p> <p>Hook hole of ceiling panel</p> <p>Hook of fall-preventive strap</p>
②	Electric parts cover	<p>1. Detachment</p> <ol style="list-style-type: none"> 1) Perform work of procedure ① -1. 2) Take off screws (Ø4 × 10, 3 pcs.) fixing the electric parts cover. 3) Remove the electric parts cover from the temporary hanging hook of the electric parts cover, and then open the cover. <p>2. Attachment</p> <ol style="list-style-type: none"> 1) Close the electric parts cover and hook the cover hole to the temporary hanging hook. 2) Tighten the fixing screws. (Ø4 × 10, 3 pcs.) 	 <p>Screws Temporary hanging hook</p> <p>Screw</p> <p>Unnecessary to remove this hook.</p>

No.	Part name	Procedure	Remarks
③	Adjust corner cover	<p>1. Detachment</p> <ol style="list-style-type: none"> 1) Perform work of procedure of ① -1. 2) Turn clockwise screws (4 positions) at the suction port corner until adjust corner cover rises up. <p>NOTE) When you work, keep the torque at below 12N•m. Do not use an electric screwdriver; otherwise the mechanism of adjust corner cover may be damaged and not be removed.</p> <ol style="list-style-type: none"> 3) Pull downward the risen-up part of adjust corner cover and remove it. 4) Remove the strap of adjust corner cover. <p>2. Attachment</p> <ol style="list-style-type: none"> 1) Attach the strap of adjust corner cover to the panel, hook claws of adjust corner cover to the panel corner, and then push the opposite side into the panel. 2) Turn screws (4 positions) of the suction port corner counterclockwise until bump between adjust corner cover and panel disappears. <p>NOTE) When you work, keep the torque at below 12N•m. Do not use an electric screwdriver; otherwise the mechanism of adjust corner cover may be damaged and not be removed.</p>	
④	Ceiling panel	<p>1. Detachment</p> <ol style="list-style-type: none"> 1) Perform works of procedure ① -1-, ② -1-, and ③ -1. 2) Remove the flap connector (CN33, White, 5P) connected to the control P.C. board and then take off the lead wire from the clamp. <p>NOTE) Remove the connectors after unlocking the lock of the housing.</p> <ol style="list-style-type: none"> 3) Take off screws (M5, 4 pcs.) fixing the ceiling panel. 4) Push the temporary bracket to inner side to remove the ceiling panel. <p>2. Attachment</p> <ol style="list-style-type: none"> 1) Hook the panel to the temporary bracket of the drain pan of the main body. <p>NOTE) The panel has directionality. Therefore mount the panel according to the temporary bracket and the bracket mounting position.</p> <ol style="list-style-type: none"> 2) Tighten the fixing screws. (M5, 4 pcs.) 3) Connect flap connector of the ceiling panel to the connector (CN33, White, 5P) of the control P.C. board. 	

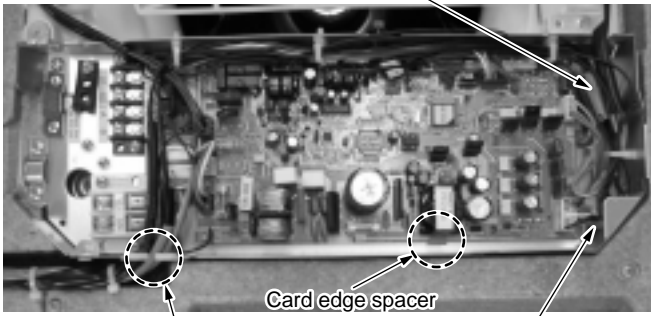
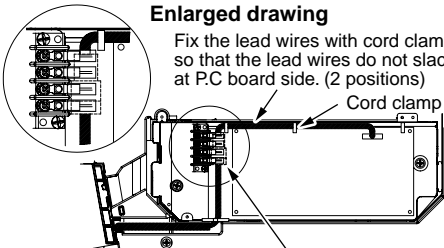
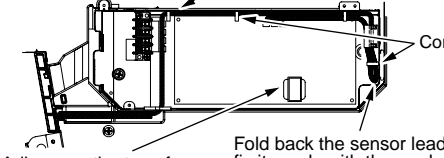
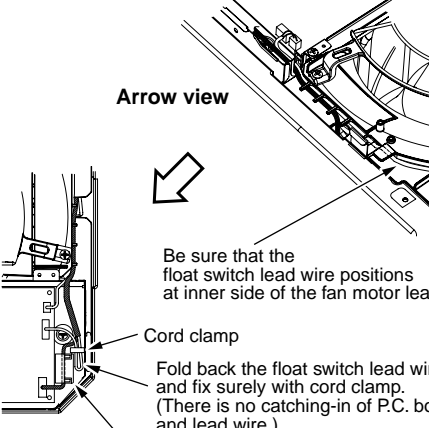
No.	Part name	Procedure	Remarks
⑤	Control P.C. board	<p>1. Detachment</p> <ol style="list-style-type: none"> 1) Perform works of procedure ① -1- and ② -1-. 2) Remove the connectors connected from the control P.C. board to other parts. CN33 : Flap motor (5P, White) CN34 : Float switch (3P, Red) CN41 : Terminal block of remote controller (3P, Blue) CN40 : Terminal block of crossover between inside and outside (2P, Blue) CN68 : Drain pump (3P, Blue) CN67 : Terminal block of power supply (3P, Black) CN100: TC1 sensor (3P, Brown) CN101: TC2 sensor (2P, Black) CN102: TCJ sensor (2P, Red) CN104: Room temp sensor (2P, Yellow) CN82 : PMV (6P, Blue) CN333: Fan motor power supply (5P, White) CN334: Fan motor position detection (5P, White) <p>NOTE) Remove the connectors after unlocking the lock of the housing.</p> <ol style="list-style-type: none"> 3) Unlock the lock of the card edge spacer (6 positions) and then remove the control P.C. board. <p>2. Attachment</p> <ol style="list-style-type: none"> 1) Fix the control P.C. board to the card edge spacer. (6 positions) 2) Connect the connectors as original before being removed in item 1. <p>NOTE) For drawing of each wire and position of ferrite core, perform wiring same as those before removing. If there is incomplete drawing of wire, short or water leakage of the parts may be caused.</p>	 <p>Ferrite core for sensor lead</p> <p>Card edge spacer</p> <p>Drawing-out port of lead wire</p> <p>Ferrite core for fan motor</p>
		<p>Enlarged drawing</p> <p>Fix the lead wires with cord clamp so that the lead wires do not slacken at P.C. board side. (2 positions)</p>  <p>Details of PMV lead wire drawing</p> <p>As shown in the figure, store PMV lead wire connected with connector assembly so that the connector positions under wire of the terminal.</p> <p>Fix the sensor lead wires firmly with the cord clamp so that they do not touch with the caution plate of the terminal block and they do not slacken at P.C. board side. (3 positions) Arrange the clamp at the position as shown in the figure.</p>  <p>Details of sensor lead wire drawing</p> <p>Fold back the sensor lead wire and adhere on the transformer. fix it surely with the cord clamp.</p>	<p>Arrow view</p>  <p>Be sure that the float switch lead wire positions at inner side of the fan motor lead wire.</p> <p>Cord clamp</p> <p>Fold back the float switch lead wire and fix surely with cord clamp. (There is no catching-in of P.C. board and lead wire.)</p> <p>Arrange at position as shown in the figure.</p> <p>Details of fan motor lead wire drawing</p>

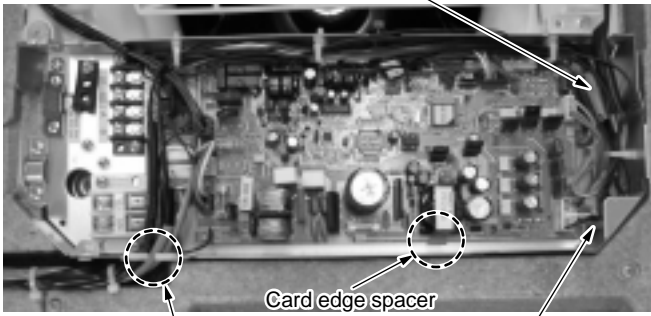
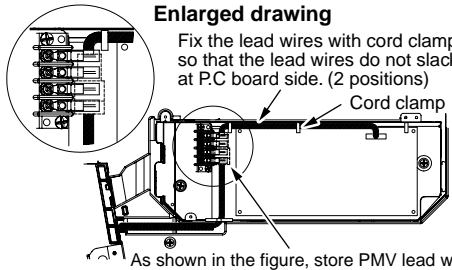
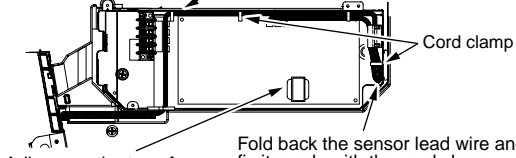
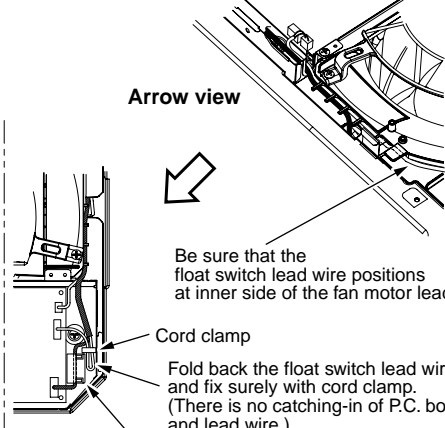
No.	Part name	Procedure	Remarks
⑥	Electric parts box	<p>1. Detachment</p> <ol style="list-style-type: none"> 1) Perform works of procedure ① -1-and ② -1. 2) Remove connectors of the lead wire connected to the following connectors of the control P.C. board. CN33 : Flap motor (5P, White) CN34 : Float switch (3P, Red) CN68 : Drain pump (3P, Blue) CN100: TC1 sensor (3P, Brown) CN101: TC2 sensor (2P, Black) CN102: TCJ sensor (2P, Red) CN82 : PMV (6P, Blue) CN333: Fan motor power supply (5P, White) CN334: Fan motor position detection (5P, White) <p>NOTE) Remove the connectors after unlocking the lock of the housing.</p> <ol style="list-style-type: none"> 3) Remove each lead wire from cord clamps in the electric parts box. 4) Remove the power supply wiring, remote controller wiring, and crossover wiring. 5) Take off screws (Ø4 × 10, 2 pcs.) <p>2. Attachment</p> <ol style="list-style-type: none"> 1) Tighten screws (Ø4 × 10, 2 pcs.) fixing the electric parts box. 2) Connect the connectors as original before being removed in item 1. 3) Perform power supply wiring, remote controller wiring, and crossover wiring between inside and outside. <p>NOTE) For drawing of each wire and position of ferrite core, perform wiring same as those before removing. If there is incomplete drawing of wire, short or water leakage of the parts may be caused.</p>	 <p>Enlarged drawing Fix the lead wires with cord clamp so that the lead wires do not slacken at P.C board side. (2 positions)</p>  <p>Details of PMV lead wire drawing As shown in the figure, store PMV lead wire connected with connector assembly so that the connector positions under wire of the terminal.</p> <p>Fix the sensor lead wires firmly with the cord clamp so that they do not touch with the caution plate of the terminal block and they do not slacken at P.C. board side. (3 positions) Arrange the clamp at the position as shown in the figure.</p>  <p>Details of sensor lead wire drawing Fold back the sensor lead wire and adhere on the transformer. fix it surely with the cord clamp.</p> <p>Arrow view Be sure that the float switch lead wire positions at inner side of the fan motor lead wire.</p>  <p>Details of fan motor lead wire drawing Cord clamp Fold back the float switch lead wire and fix surely with cord clamp. (There is no catching-in of P.C. board and lead wire.) Arrange at position as shown in the figure.</p>

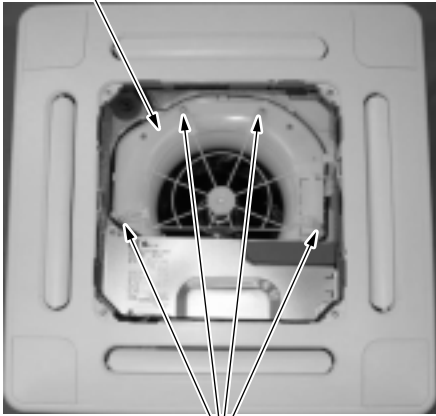
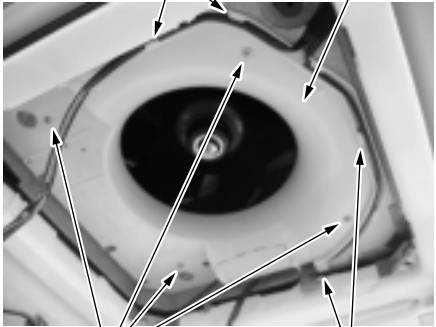
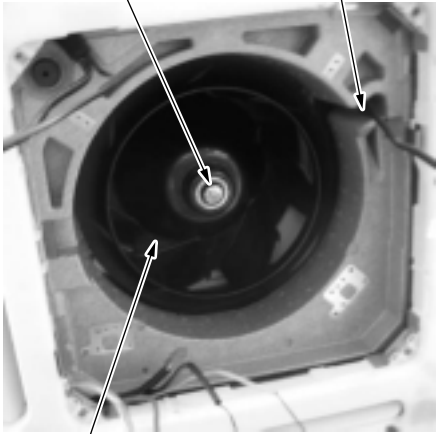
No.	Part name	Procedure	Remarks
⑦	Fan guard	<p>1. Detachment</p> <ol style="list-style-type: none"> 1) Perform work of procedure ① -1. 2) Take off screws fixing the fan guard. ($\varnothing 4 \times 10$, [Screws for plastic molding] 4 pcs.) <p>NOTE) The specification of fixing screws for the fan guard differs from those of other fixing screws. Therefore keep them separately from other screws.</p> <p>2. Attachment</p> <ol style="list-style-type: none"> 1) Attach screws for fixing the fan guard. ($\varnothing 4 \times 10$, [Screws for plastic molding] 4 pcs.) 	 <p>Fan guard</p> <p>4 screws</p>
⑧	Bell mouth	<p>1. Detachment</p> <ol style="list-style-type: none"> 1) Perform work of procedure ⑥ -1. 2) Take off the lead wires of the drain pump, float switch, and fan motor from the bell mouth. 3) Take off fixing screws of the bell mouth. ($\varnothing 4 \times 10$, 4 pcs.) <p>2. Attachment</p> <ol style="list-style-type: none"> 1) Mount the bell mouth with screws. ($\varnothing 4 \times 10$, 4 pcs.) 2) Perform wiring as original before being removed. <p>NOTE) Pinch lead wire of the drain pump and float switch with lead wire fixing claws of the bell mouth and perform wiring along the guide.</p>	 <p>Fixing claws for lead wires</p> <p>Bell mouth</p> <p>4 screws</p> <p>Fixing claws for lead wires</p>
⑨	Turbo fan	<p>1. Detachment</p> <ol style="list-style-type: none"> 1) Perform work of procedure ⑧ -1. 2) Take off the nut (M6 nut 1 pc.) of the turbo fan. <p>NOTE) Use a box wrench for attachment and detachment of the turbo fan. If using a monkey wrench etc, the other parts may be damaged in work.</p> <p>2. Attachment</p> <ol style="list-style-type: none"> 1) Insert the turbo fan into the fan motor so that boss of the turbo fan matches with cut surface of the fan motor, and then tighten it with nut. <p>NOTE) Tightening torque of turbo fan: $5.9 \pm 0.6\text{N.m}$ Apply looseness-preventing agent to the nut after tightening.</p>	 <p>Fan motor fixing M6 nut</p> <p>Drawing-out port of fan motor lead wire</p> <p>Turbo fan</p>

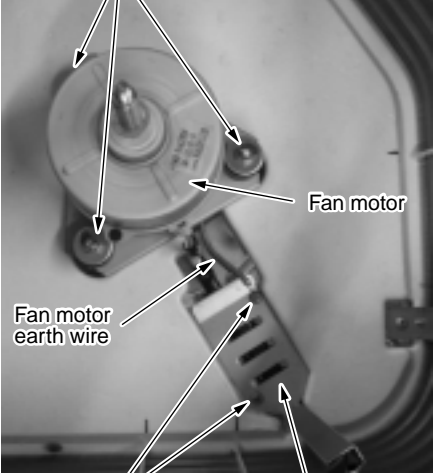
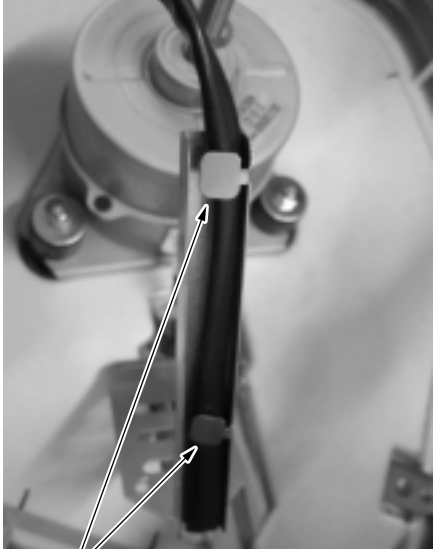
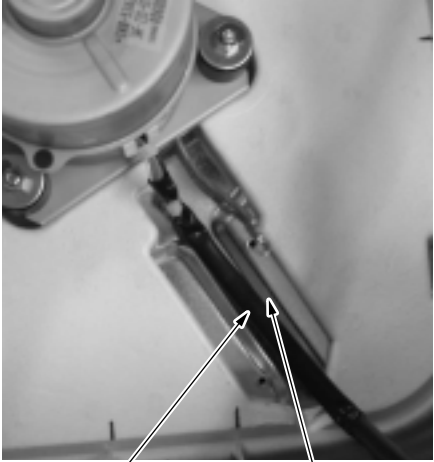
No.	Part name	Procedure	Remarks
⑩	Fan motor	<p>1. Detachment</p> <ol style="list-style-type: none"> 1) Perform work of procedure ⑨. 2) Take off screws fixed with lead holding bracket of the fan motor. (Ø4 × 10, 2 pcs.) 3) Open wiring holding part of the fan motor lead holding bracket and then take off the fan motor lead wire from the bracket. 4) Take off fixing nuts for the fan motor to remove the fan motor.(M 3 pcs.) <p>NOTE) Use a box wrench for attachment and detachment of the fan motor fixing nuts; otherwise contact or damage for other parts may be caused.</p> <p>2. Attachment</p> <ol style="list-style-type: none"> 1) Mount the fan motor with the fixing nuts. <p>NOTE) Tightening torque of turbo fan: $5.9 \pm 0.6\text{N.m}$ Apply looseness-preventing agent (as paints) to the nut after tightening. <ol style="list-style-type: none"> 2) Attach the fan motor lead wire holder. <p>NOTE)</p> <ul style="list-style-type: none"> • For the fan motor lead wire, fix the lead wire holding bracket along concave part of the ceiling panel. (There is no catch-in of lead wire and ceiling panel.) • When fixing the lead wire bracket, tighten fan motor earth together with the lead wire. • For this work, do not use an electric screwdriver. • Take note the damage of earth terminal. <ol style="list-style-type: none"> 3) Bend the lead wire holding part and fix the fan motor lead wire. <p>NOTE) Be sure that the lead wire does not come to contact with the heat exchanger.</p> </p>	<p>Fixing nut for fan motor</p>  <p>Fan motor</p> <p>Fan motor earth wire</p> <p>Fixing screw</p> <p>Holding metal fitting for fan motor lead wire</p>  <p>Wiring holding bracket</p>  <p>Fan motor lead wire</p> <p>Concave part of ceiling panel</p>

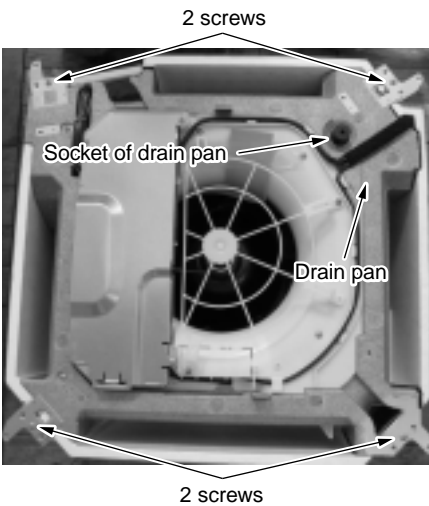
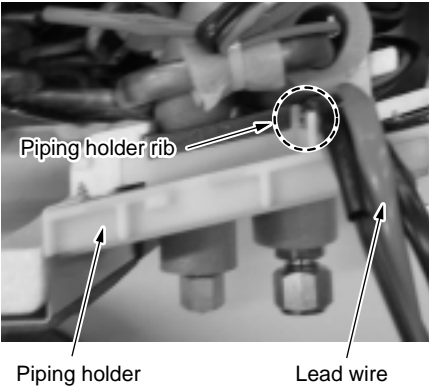
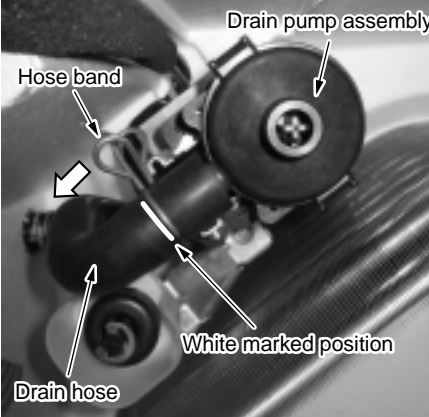
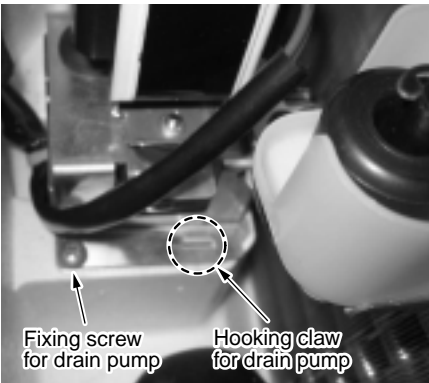
No.	Part name	Procedure	Remarks
⑪	Drain pan	<p>1. Detachment</p> <ol style="list-style-type: none"> 1) Perform works of procedure ④ -1 and ⑧ -1. 2) Remove the drain cap and extract drain water accumulated in the drain pan. <p>NOTE) When removing the drain cap, be sure to receive drain water with a bucket, etc.</p> <ol style="list-style-type: none"> 3) Take off screws fixing the drain pan to remove the drain pan. (Ø4×10, 4 pcs.) <p>2. Attachment</p> <ol style="list-style-type: none"> 1) Insert the drain cap into the drain pan. <p>NOTE) Put a stick or others into hole at center of the drain cap, and then insert the drain cap until it strikes on the socket of the drain pan.</p> <ol style="list-style-type: none"> 2) Draw each lead wire to the correct positions, and then insert the drain pan into the main unit. <p>NOTE) Draw lead wires of the drain pump and the float switch along the guide of the cabinet. Insert the drain pan along the guides of sensors (TC1, TC2, TCJ) and PMV lead wire. The drain pan and each lead wire are not caught in; otherwise water leakage may be caused.</p> <ol style="list-style-type: none"> 3) Fix the drain pan with screws. (Ø4 × 10, 4 pcs.) 	 
⑫	Drain pump assembly	<p>1. Detachment</p> <ol style="list-style-type: none"> 1) Perform work of procedure ⑪ -1. 2) Pick up the hose band and slide it from the pump connecting part to remove the drain hose. 3) Take off screws (Ø4 × 10, 3 pcs.) fixing the drain pump assembly, and then move hooking claw (1 position) of the main body from the drain pump assembly to remove the drain pump assembly. <p>2. Attachment</p> <ol style="list-style-type: none"> 1) Fix the drain pump assembly as original. <p>NOTE) For fixing, use a hooking claw (1 position) and screws (3 positions). When screwing, be sure not to run on the hooking claw at main body side.</p> <ol style="list-style-type: none"> 2) Mount the drain hose and the hose band as original. <p>NOTE) Insert the drain hose up to the end of pump connecting part, and then put the band at white marked position of the hose.</p>	 

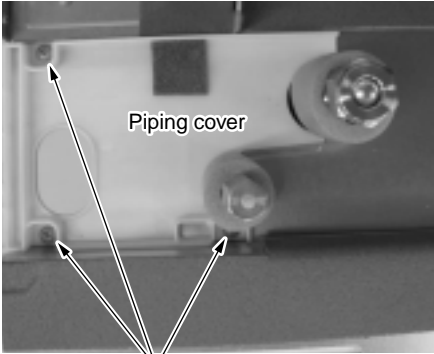
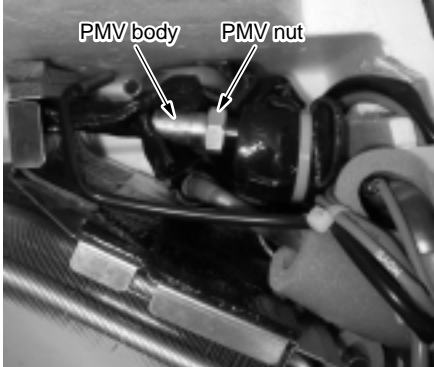
No.	Part name	Procedure	Remarks
⑬	PMV (Pulse Motor Valve)	<p>1. Detachment</p> <ol style="list-style-type: none"> 1) Perform work of procedure ⑪ -1. 2) Take off screws (Ø4 × 10, 3 pcs.) fixing the piping cover to remove the piping cover. 3) Cut off binding band that binds the PMV lead wires. 4) Peel butyl rubber of PMV a little and remove PMV motor with a spanner wrench. <p>NOTE) For attachment and detachment of PMV motor, use a 14mm or 19mm spanner wrench.</p> <p>2. Attachment</p> <ol style="list-style-type: none"> 1) Mount PMV motor with a spanner wrench. <p>NOTE) PMV motor tightening torque: $7.84 \pm 0.78\text{N.m}$</p> <ol style="list-style-type: none"> 2) Perform wiring of PMV and sensor lead as original. <p>NOTE) Arrange each wire as original.</p> <ol style="list-style-type: none"> 3) Fix the piping cover with screws. 	 

<Details of sensor lead wire drawing>

As shown in the figure, make draining shape on the lead wire (Black) once, and then fix it with bind band.

Fix the head of bind band and lead wire at inner side of the position in the figure so that they do not stick out to outside.

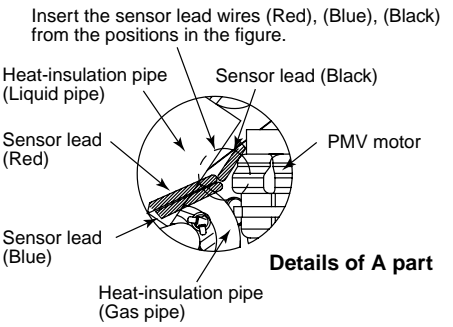
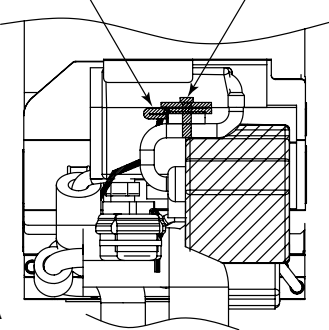
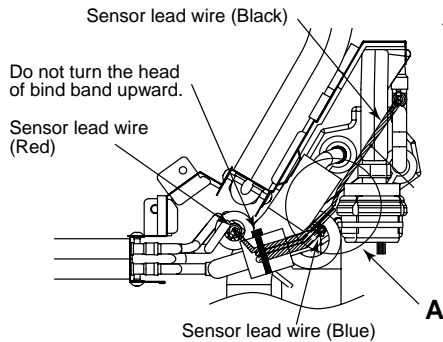

As shown in the figure, hook the sensor and PMV lead wires to the claw of the No.13 piping cover, and then pass them so that they are stored in this groove.

When mounting the piping cover, check each lead wire does not hit PMV motor.

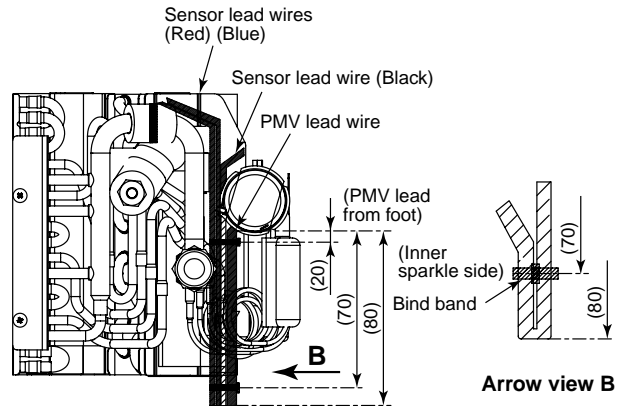
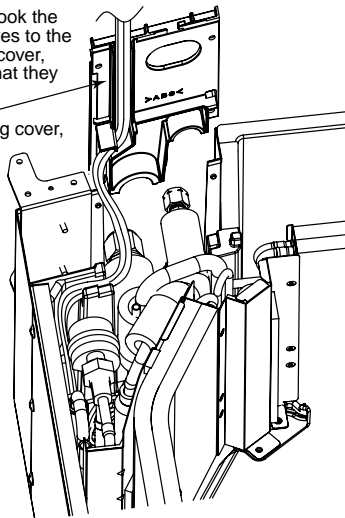

Bundle each sensor lead wire (Red), (Blue), (Black), and PMV lead wire, fold back toward you at position in the figure, and then fix them with bind band.

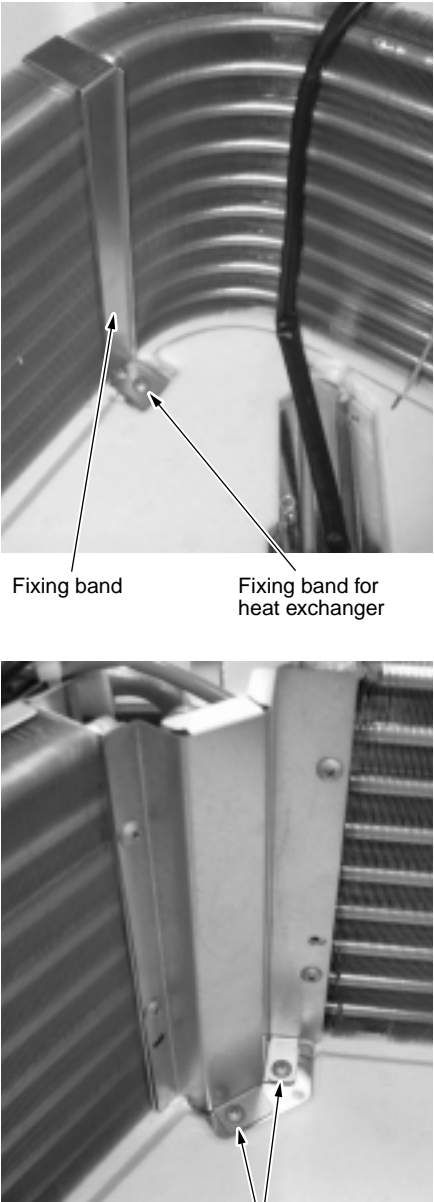
No.	Part name	Procedure	Remarks
⑭	Heat exchanger	<p>1. Detachment</p> <ol style="list-style-type: none"> 1) Recover refrigerant gas. 2) Remove the refrigerant pipe at indoor unit side. 3) Perform work of procedure ⑪ -1. 4) Take off screws (Ø4 × 10, 3 pcs.) fixing the piping cover to remove the piping cover. 5) While holding the heat exchanger, remove fixing band and fixing screws (Ø4 × 10, 3 pcs.) and then remove the heat exchanger. <p>2. Attachment</p> <ol style="list-style-type: none"> 1) Mount parts in order, heat exchanger → fixing band → piping cover → drain pan → bell mouth → electric parts box as original. <p>NOTE) Arrange wires as original.</p> <ol style="list-style-type: none"> 2) Attach the removed connectors and wires as original. 3) Connect the refrigerant pipe as original, and then perform vacuuming. 	 <p>Fixing band Fixing band for heat exchanger</p> <p>2 fixing screws for heat exchanger</p>

10. P.C. BOARD EXCHANGE PROCEDURES

10-1. Exchange of P.C. Board for Indoor Service

Part code	Model type	P.C. board model	Label display on P.C. board
431-6V-269	MMU-AP ** 1H series MMU-AP ** 1MH series MMC-AP ** 1H series MMK-AP ** 1H series MMD-AP ** 1SPH/SH series MMU-AP ** 2SH series	MCC-1402	03DD M05

Requirement at exchange of P.C. board assembly for indoor service

Before exchange, in the fixed memory (hereinafter EEPROM, IC10) installed on the indoor P.C. board, the type exclusive to the model and the capacity code are stored at shipment from the factory. The important setup data such as line/indoor/group address which are set up (Auto/Manual) or high ceiling exchange setup at installation time, respectively.

Proceed with exchange of P.C. board assembly for indoor service in the following procedure.

After exchange work, check again the setup for indoor unit No. or group header/follower units to confirm whether the setup contents are correct or not, and then check also the refrigerant circuit system by a test operation, etc.

<Exchange procedure>

Method 1

Before exchange, it is possible to turn on power of the indoor unit and read out the setup contents from the wired remote controller.

Readout of EEPROM data: **Procedure 1**



Exchange of P.C. board for service & power ON: **Procedure 2**



Writing-in of the readout EEPROM data: **Procedure 3**



Power supply reset (All the indoor units connected to the remote controller in case of group operation control)

Method 2

Before exchange, it is impossible to read out the setup contents due to EEPROM error.

Exchange of P.C. board for service & power ON: **Procedure 2**



Writing-in of the setup data such as the model name, capacity code, indoor unit address high ceiling setup, connection setup of option, etc to EEPROM based upon customer's information: **Procedure 3**



Power supply reset (All the indoor units connected to the remote controller in case of group operation control)

Procedure 1 : Readout setup contents from EEPROM

(Contents of EEPROM with setup changed at local site include setup at shipment from the factory are read out.)

1. Push **SET** + **CL** + **TEST** buttons simultaneously for 4 seconds or more. **1**
 - * In a group operation control, the firstly displayed unit No. indicates the header indoor unit No.
In this case, **10** is displayed in the item code (DN). The fan of the selected indoor unit operates, and also starts swinging in a model with flap.
2. Every pushing **UNIT**, the indoor unit Nos. in the group control are displayed successively. **2**
Specify the indoor unit No. to be exchanged.
 - * The fan of the selected indoor unit operates, and also starts swinging in a model with flap.
3. Using temperature setup **▼** / **▲** buttons, the item code (DN) can be moved up/down one by one. **3**
4. First change the item code (DN) from **10** → **01**. (Setup of filter sign lighting time)
In this time, make a note of contents of the displayed setup data.
5. In the next time, change the item code (DN) using **▼** / **▲** buttons.
Make a note of contents of the setup data as same as the above.
6. Then repeat item 5., and make a note of contents of the important setup data as indicated in the attached table (Example).
 - * The item code (DN) is consisted with **01** to **FF**.
DN No. may jump on the way.
7. When noting has finished, push **TEST** button to return to the normal stop status. **6**
(It requires approx. 1 minute to operate the remote controller.)

Item code necessary at minimum

DN	Contents
10	Type
11	Indoor unit capacity
12	Line address
13	Indoor address
14	Group address

Type and capacity of the indoor unit are necessary to set up the revolution frequency of the fan.

<Remote controller operation diagram>

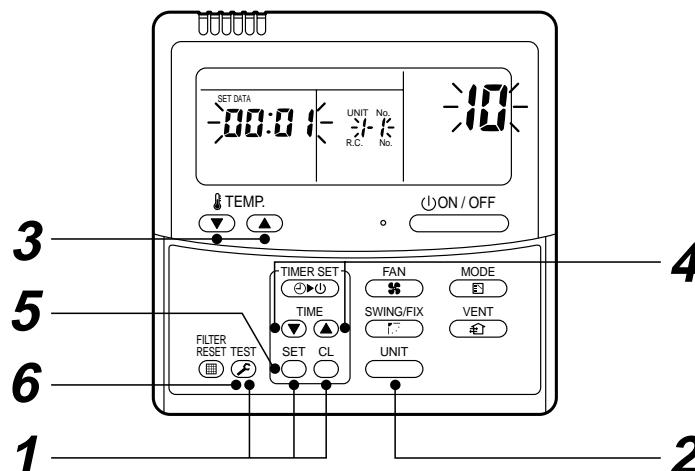

Procedure 2 : Exchange of P.C. board for service

1. Exchange P.C. board with a P.C. board for service.

In this time, the jumper line (cut) setup or the (short-circuit) connecting connector setup on the previous P.C. board should be reflected on P.C. board for service. (See the blow figures.)

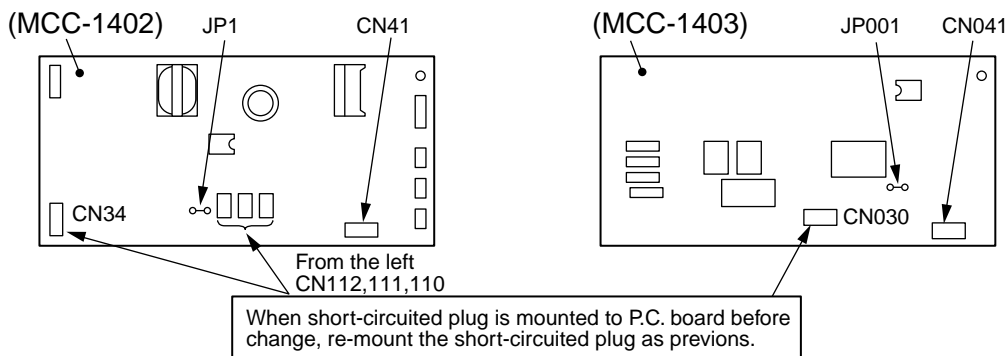

2. It is necessary to set Indoor unit to be exchanged : Remote controller = 1 : 1

Based upon the system configuration, turn on power of the indoor unit with one of the following items.

1) Single (Individual) operation

Turn on power of the indoor units and proceed to **Procedure 3**.

2) Group operation

A) In case that power of the exchanged indoor unit only can be turned on

Turn on power of the exchanged indoor unit only and proceed to **Procedure 3**.

B) In case that power of the indoor units cannot be turned on individually (**Case 1**)

a) Remove temporarily the group wire connected to the terminal blocks A and B of the exchanged indoor unit.

b) After connecting the remote controller wire only to the removed terminal block, turn on power of the indoor units and proceed to **Procedure 3**.

* When the above methods cannot be used, follow to the two cases below.

C) In case that power of the indoor units cannot be turned on individually (**Case 2**)

a) Remove all CN41 connectors of the indoor units in the same group except those of the exchanged indoor unit.

b) Turn on power of the indoor units and proceed to **Procedure 3**.

* After **Procedure 3** operation has finished, be sure to return the temporarily removed group wire or CN41 connector to the original connection.

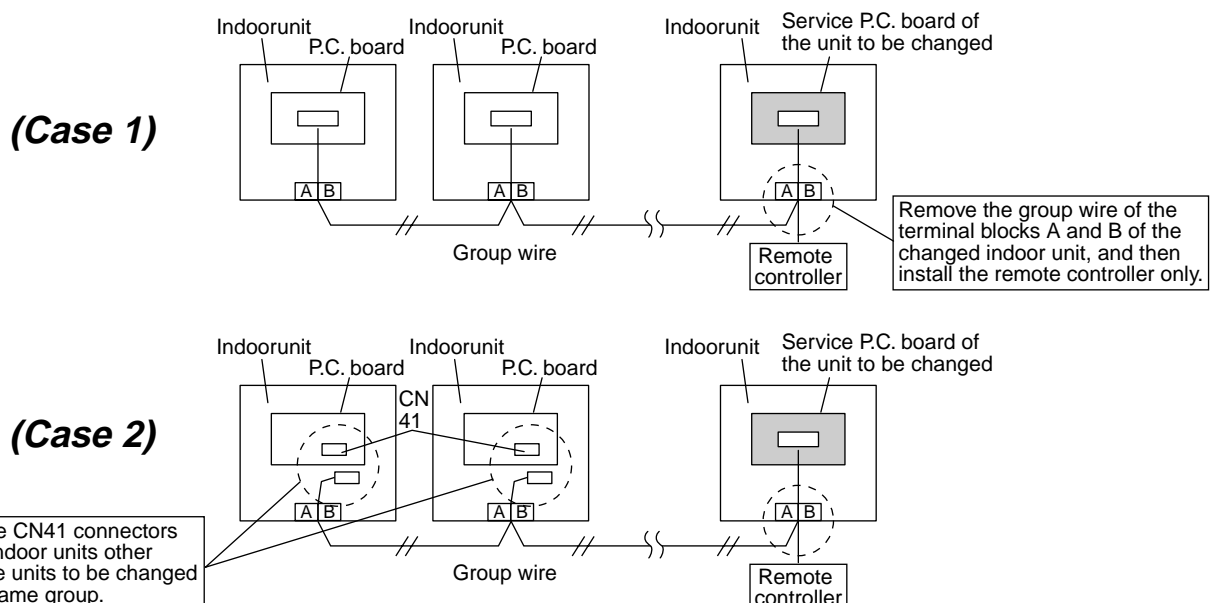

Procedure 3 : Writing-in of setup contents to EEPROM

(The EEPROM contents which are installed on the service P.C. board have been set up at shipment from the factory.)

1. Push **SET** + **CL** + **TEST** buttons simultaneously for 4 seconds or more. **1**
(**ALL** is displayed in the UNIT No box.)
In this time, **10** is displayed in the item code (DN). The fan of the indoor unit operates, and also starts swinging in a model with flap.
2. Using temperature setup (▼) / (▲) buttons, the item code (DN) can be moved one step up 1 or down one by one. **3**
3. First set up the type and capacity code of the indoor unit.
(The data at shipment from the factory is written in EEPROM by changing the type and capacity code.)
 - 1) Set **10** to the item code (DN). (As before)
 - 2) Using the timer time (▼) / (▲) buttons, set up the type. **4**
(For example, 0001 indicates 4-way Air Discharge Cassette type.): Refer to the attached table.
 - 3) Push **SET** button. (OK if display goes on.) **5**
 - 4) Using temperature setup (▼) / (▲) buttons, set **11** to the item code (DN).
 - 5) Using the timer time (▼) / (▲) buttons, set up the capacity code.
(For example, 0012 indicates 027 type.): Refer to the attached table.
 - 6) Push **SET** button. (OK if display goes on.)
 - 7) Push **TEST** button to return to the normal stop status.
4. In the next, the contents such as address setup, which were set up at the local site after installation are written in EEPROM. Execute again the operation in the above item 1.).
5. Using temperature setup (▼) / (▲) buttons, set **11** to the item code (DN).
(Lighting time setup for filter sign)
6. Compare the contents of the setup data which is displayed in this time with contents noted in a memo in **Procedure 1** and customer's information.
 - 1) If data is incorrect, change it using the timer time (▼) / (▲) buttons so that it matches with contents noted in a memo, and then push **SET** button. (OK if display goes on.)
 - 2) Do nothing if data is same as those in the memo.
7. Using temperature setup (▼) / (▲) buttons, change the item code (DN).
Check also the contents of the setup data and then change them it to those in the memo.
8. Then repeat operations in items 6. and 7.
9. After setup operation, push **TEST** button to return to the normal stop status. **6**
In a group operation, turn off the power supply once, return the group wires between indoor units and CN41 connectors as before, and then turn on power of all the indoor units.
(It requires approx. 1 minute to operate the remote controller.)
* The item code (DN) is consisted with **11** to **FF**. DN No. may jump on the way.
Even if pushing **SET** button after changing the data incorrectly, the data can be returned to one before change by pushing **CL** button before changing the item code (DN).

<EEPROM layout>

EEPROM (IC10) is attached to IC socket. To remove it, use a pair of tweezers, etc.
To attach EEPROM, arrange the direction as shown in the following figures.

* In exchanging time, pay attention not to bend the lead wire of IC.

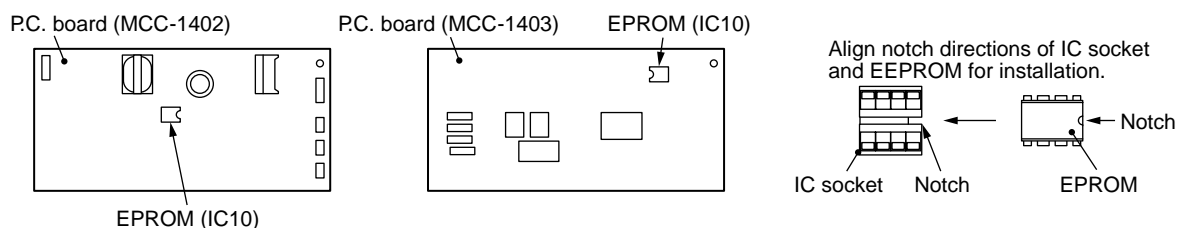

<Make a note of the setup contents. (Item code list (Example))>

DN	Item	Memo	Setup at shipment from factory
01	Filter sign lighting time		According to type
02	Dirty condition of filter		0000: Standard
03	Central control address		0099: Undefined
06	Heating inlet temp. shift		0002: +2°C (Floor standing: 0)
0d	Cooling Auto mode existence		0001: No auto mode cooling/heating
0F	Cooling only/Heat pump select		0000: Heat pump
10	Type		According to model type
11	Indoor unit capacity		According to capacity code
12	Line address		0099: Undefined
13	Indoor unit address		0099: Undefined
14	Group address		0099: Undefined
19	Flap type (Air direction adjustment)		According to type
1E	Temp. width between cooling and heating automatic selective control points		0003: 3 deg (Ts ± 1.5)
28	Automatic restart from power failure		0000: None
2E	HA terminal (T10) selection		0000: Normal
32	Sensor select		0000: Body sensor
5d	High ceiling selection		0000: Standard
60	Timer setup (Wired remote controller)		0000: Possible

Type
Item code [10]

Setup data	Type	Model abb. name
0000	1-way Air Discharge Cassette	MMU-AP***SH
0001*	4-way Air Discharge Cassette	MMU-AP***H
0002	2-way Air Discharge Cassette	MMU-AP***WH
0003	1-way Air Discharge Cassette (Compact type)	MMU-AP***YH
0004	Concealed Duct Standard	MMD-AP***BH
0005	Slim Duct	MMD-AP***SPH MMD-AP***SH
0006	Concealed Duct High Static Pressure	MMD-AP***H
0007	Under Ceiling	MMC-AP***H
0008	High Wall	MMK-AP***H
0009		
0010	Floor Standing Cabinet	MML-AP***H
0011	Floor Standing Concealed	MML-AP***BH
0012		
0013	Floor Standing (Below 6HP)	MMF-AP***H
0014	Compact 4-way Air Discharge Cassette	MMU-AP***MH

Indoor unit capacity
Item code [11]

Setup data	Model	Setup data	Model
0000*	Invalid	0016	—
0001	007 type	0017	048 type
0002	—	0018	056 type
0003	009 type	0019	—
0004	—	0020	—
0005	012 type	0021	072 type
0006	—	0022	—
0007	015 type	0023	096 type
0008	—	0024	—
0009	018 type	0025	—
0010	—	0026	—
0011	024 type	0027	—
0012	027 type	0028	—
0013	030 type	~	—
0014	—	0034	—
0015	036 type		

* The initial setup value of EEPROM installed on the service P.C. board

11. EXPLODED VIEWS AND PARTS LIST

11-1. Ceiling Panel

RBC-UM11PG(W)E

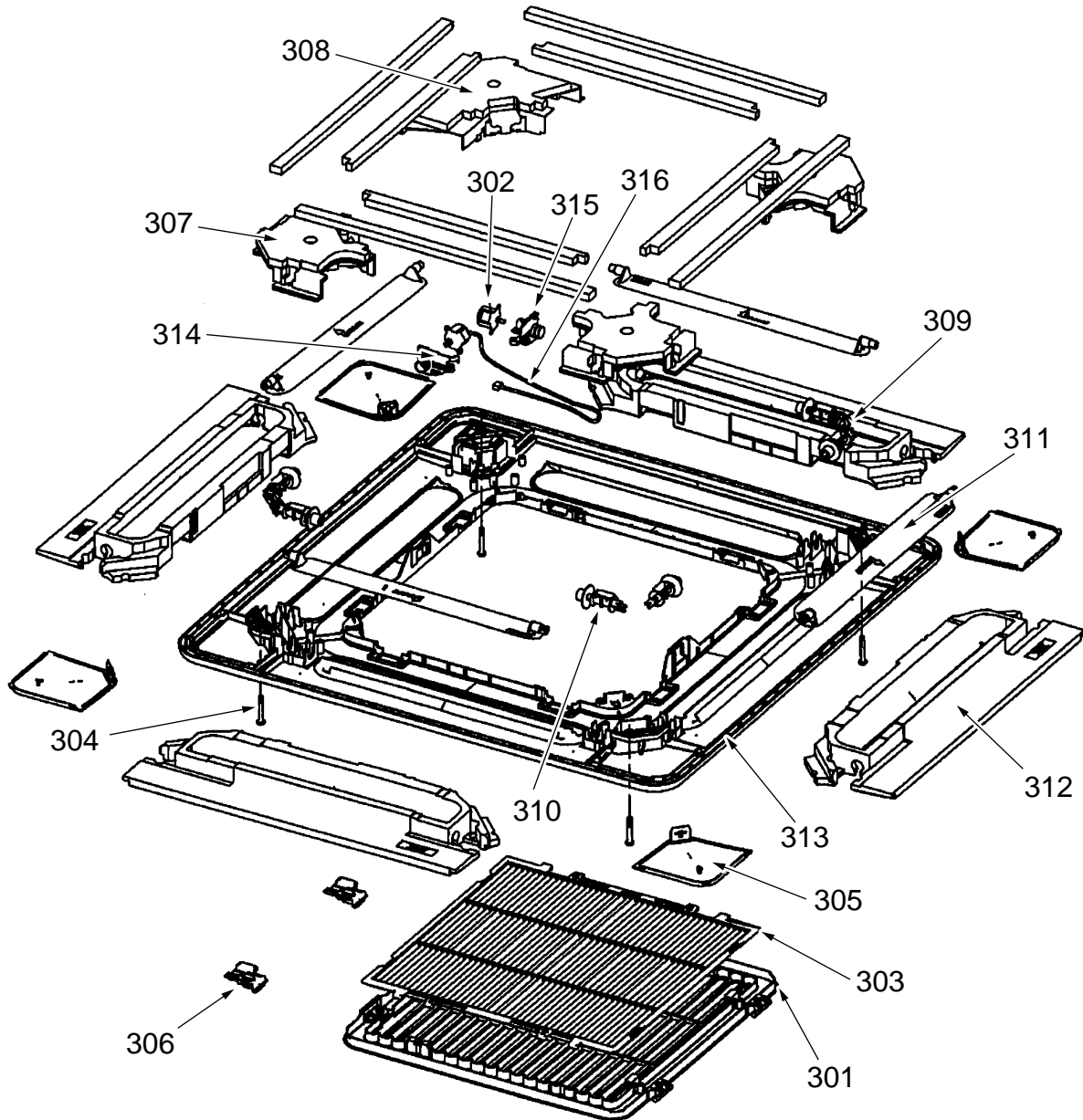

Location No.	Part No.	Description
301	43109414	Grille, Air Inlet
302	4302C059	Motor, Louver
303	43180332	Air Filter
304	43497012	Screw
305	43100322	Cover, Panel Ass'y
306	43107259	Grille, Catch
307	43122089	Cover, Joint (For Joint)
308	43122090	Cover, Joint (For Motor)

Location No.	Part No.	Description
309	43122091	Joint, Kit (A)
310	43122092	Joint, Kit (B)
311	43122093	Louver
312	43107261	Outlet, Air Form
313	43100369	Panel
314	43107262	Fix, Motor
315	43107263	Fix, Motor
316	43160580	Lead, Motor

11-2. Compact 4-way Air Discharge Cassette Type

MMU-AP0071MH, AP0091MH, AP0121MH, AP0151MH, AP0181MH

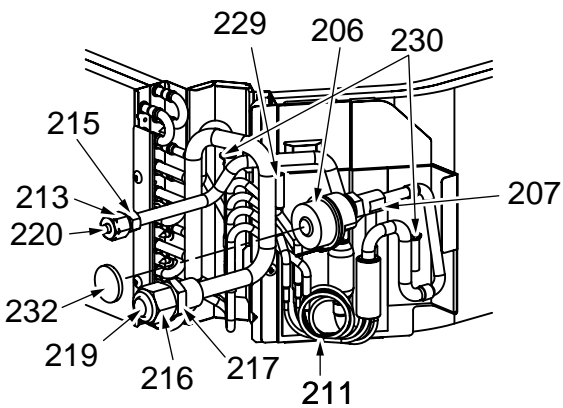
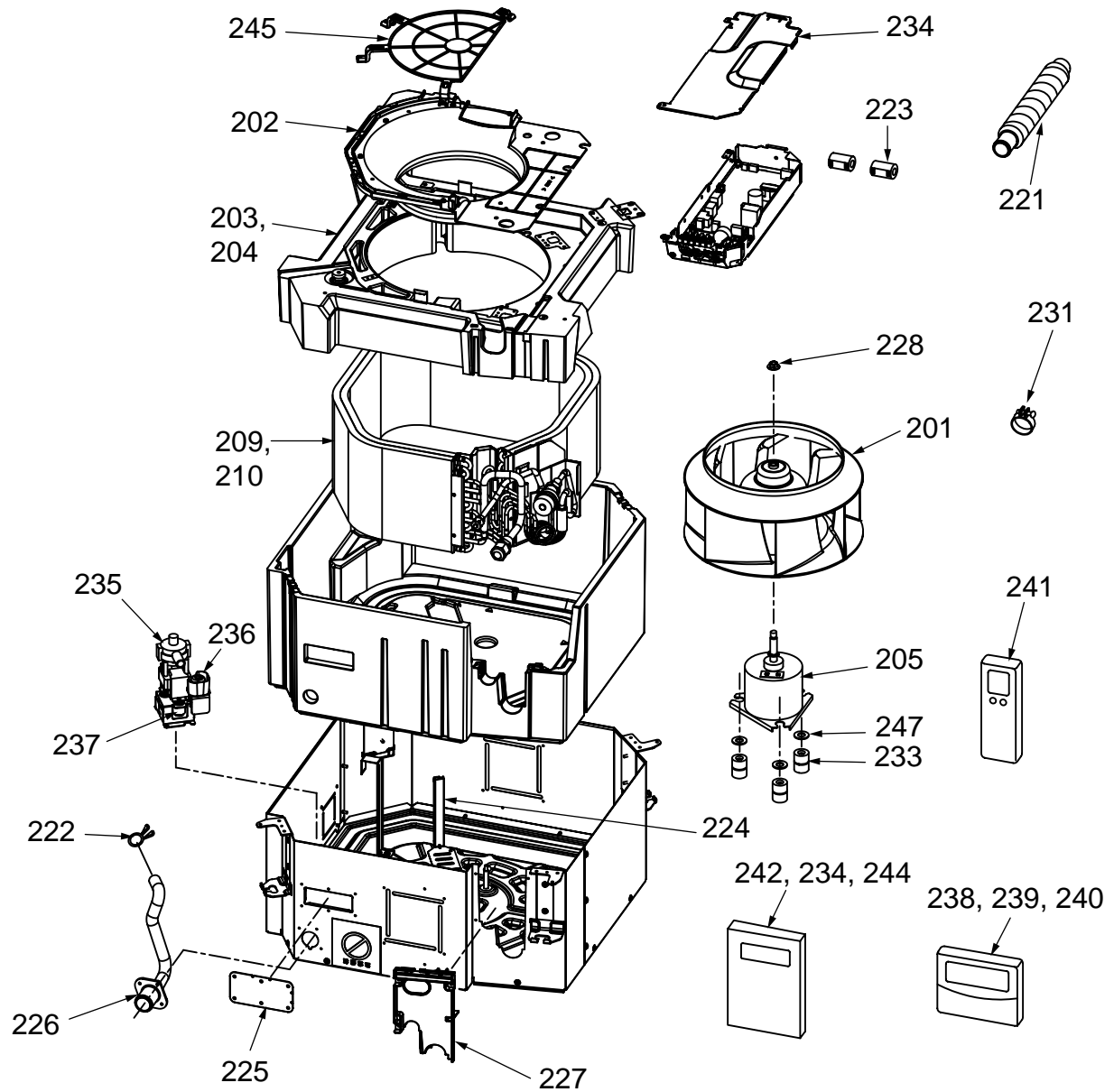

0151MH, 0181MH

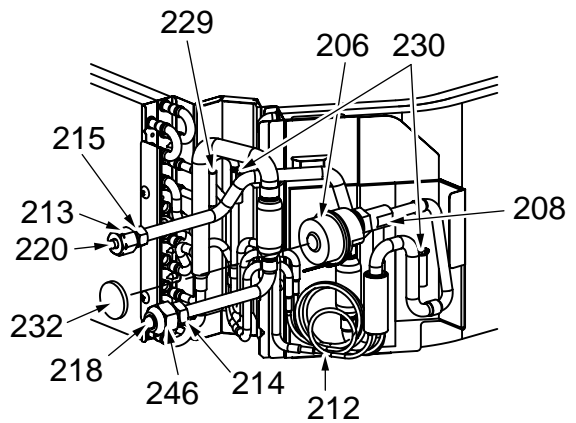

0071MH, 0091MH, 0121MH

Location No.	Part No.	Description	Remarks	Model Name MMU-AP				
				0071MH	0091MH	0121MH	0151MH	0181MH
201	43120225	Fan Ass'y, Turbo		1	1	1	1	1
202	43122094	Bell Mouth		1	1	1	1	1
203	43172185	Pan Ass'y, Drain					1	1
204	43172186	Pan Ass'y, Drain		1	1	1		
205	43121738	Motor, Fan	SWF-230-60-1R	1	1	1	1	1
206	43146707	Motor, PMV	EDM-MD12TF-3	1	1	1	1	1
207	43146713	Valve, PMV	EDM-B25YGTF-3	1	1	1		
208	43146714	Valve, PMV	EDM-B40YGTF-3				1	1
209	4314J263	Refrigeration Cycle Ass'y					1	1
210	4314J264	Refrigeration Cycle Ass'y		1	1	1		
211	4314Q006	Distributor Ass'y					1	1
212	4314Q007	Distributor Ass'y		1	1	1		
213	43047685	Nut, Flare	1/4 IN	1	1	1	1	1
214	43049776	Socket	3/8 IN	1	1	1		
215	43149351	Socket	1/4 IN	1	1	1	1	1
216	43047688	Nut, Flare	1/2 IN				1	1
217	43149353	Socket	1/2 IN				1	1
218	43047609	Bonnet		1	1	1		
219	43147195	Bonnet	1/2 IN				1	1
220	43049697	Bonnet		1	1	1	1	1
221	43170244	Hose, Drain		1	1	1	1	1
222	43079249	Band, Hose		1	1	1	1	1
223	43060029	Filter, Noise		2	2	2	2	2
224	43163052	Holder, Lead, Fan Motor		1	1	1	1	1
225	43119482	Cover Ass'y Body		1	1	1	1	1
226	43170248	Hose, Drain		1	1	1	1	1
227	43119483	Cover, Pipe		1	1	1	1	1
228	43097212	Nut		1	1	1	1	1
229	43107215	Holder, Sensor		1	1	1	1	1
230	43019904	Holder, Sensor		2	2	2	2	2
231	43179135	Band, Hose		1	1	1	1	1
232	43149314	Sheet, PMV		1	1	1	1	1
233	43139137	Rubber, Cushion		3	3	3	3	3
234	43162056	Cover, E-Box		1	1	1	1	1
235	43177001	Pump, Drain		1	1	1	1	1
236	43151289	Switch, Float		1	1	1	1	1
237	43179126	Rubber, Pump Drain		3	3	3	3	3
238	43166002	Remote Controller	SX-A1EE	1	1	1	1	1
239	43166004	Remote Controller	SX-A11JE2	1	1	1	1	1
240	43166005	Remote Controller	EX-W2JE2	1	1	1	1	1
241	43166006	Remote Controller	WH-H1JE2	1	1	1	1	1
242	4311M422	Owner's Manual	MMY-MAP1201HT8	1	1	1	1	1
243	4318T727	Owner's Manual	MCY-MAP0401HT	1	1	1	1	1
244	4318T631	Owner's Manual	MMY-MAP1201FT8	1	1	1	1	1
245	43119475	Guard Fan		1	1	1	1	1
246	43149355	Nut, Flare	3/8 IN	1	1	1		
247	43197155	Washer		3	3	3	3	3

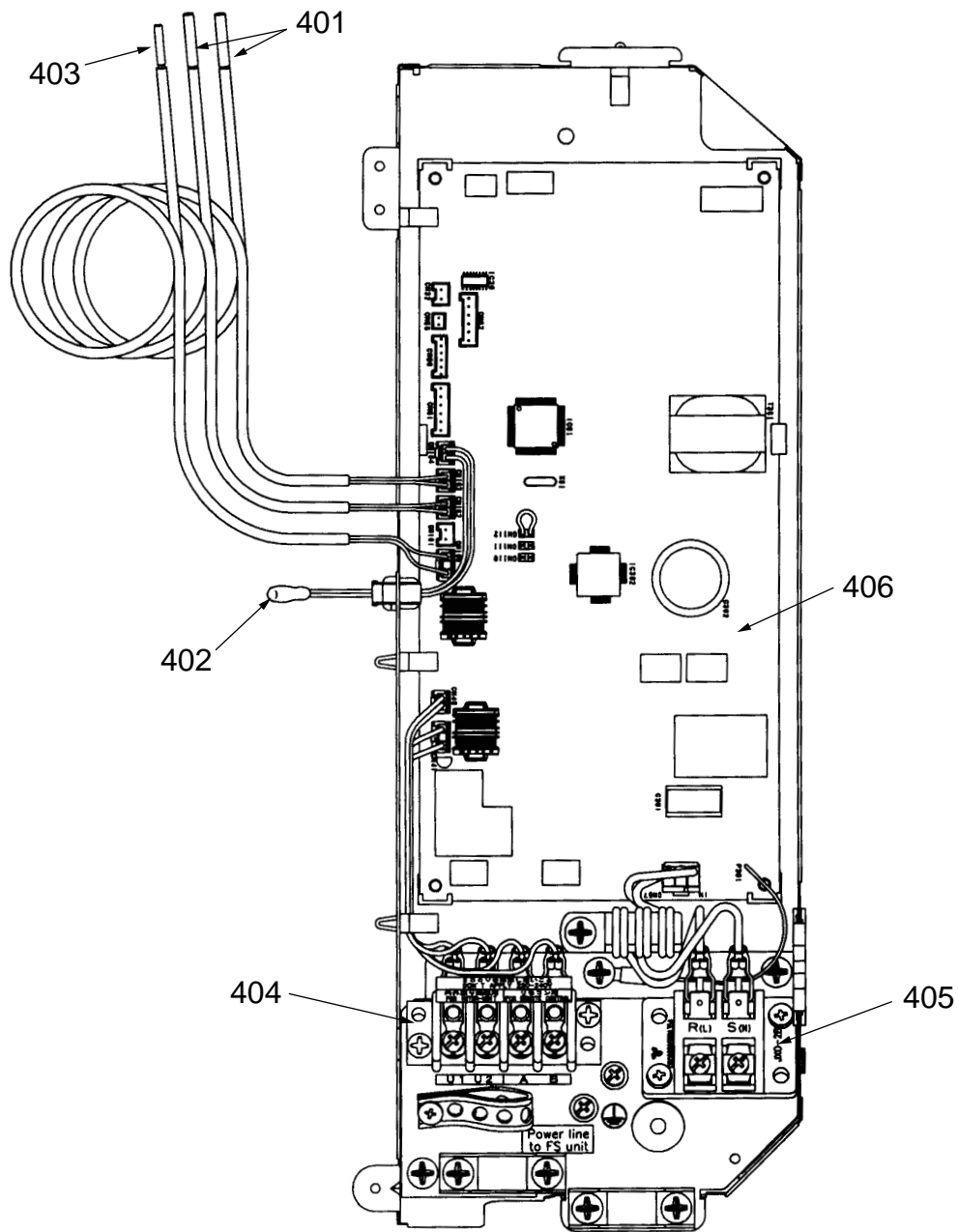

Location No.	Part No.	Description	Model Name MMU-AP				
			0071MH	0091MH	0121MH	0151MH	0181MH
401	43050425	Sensor Ass'y, Service, TC	2	2	2	2	2
402	43050426	Sensor, Service, TA	1	1	1	1	1
403	43050320	Sensor Ass'y, Service, TG	1	1	1	1	1
404	43160574	Terminal, 4P	1	1	1	1	1
405	43160575	Terminal Block, 2P, 20A	1	1	1	1	1
406	4316V289	P.C. Board Ass'y, MCC-1402	1	1	1	1	1

TOSHIBA CARRIER CORPORATION

2 CHOME 12-32, KONAN, MINATOKU, TOKYO, 108-0075, JAPAN

Copyright © 2005 TOSHIBA CARRIER CORPORATION, ALL Rights Reserved.