

TOSHIBA

FILE NO. SVM-05052

SERVICE MANUAL

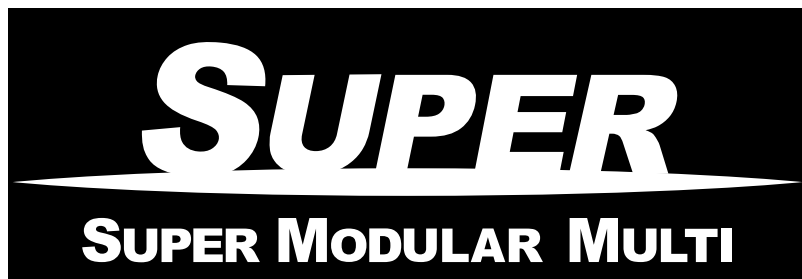

<High Wall Type>

MMK-AP0072H

MMK-AP0092H

MMK-AP0122H









- This Service Manual describes contents of the new High Wall indoor unit.
For the outdoor unit, refer to the Manual with **FILE NO. A03-009**.
- The service parts will be supplied by TCTC.







CONTENTS



SAFETY CAUTION	3
1. CONSTRUCTION VIEWS (EXTERNAL VIEWS)	8
2. WIRING DIAGRAM	9
3. PARTS RATING	10
4. REFRIGERATING CYCLE DIAGRAM	23
5. CONTROL OUTLINE	24
6. APPLIED CONTROL	30
7. TROUBLESHOOTING	37
8. CONFIGURATION OF CONTROL CIRCUIT	111
9. HOW TO REPLACE MAIN PARTS	113
10. REPLACEMENT OF SERVICE INDOOR P.C. BOARD	118
11. EXPLODED VIEWS AND PARTS LIST	123

SAFETY CAUTION

The important contents concerned to the safety are described on the product itself and on this Service Manual. Please read this Service Manual after understanding the described items thoroughly in the following contents, and keep them.

 WARNING	
 Check earth wires.	Before troubleshooting or repair work, check the earth wire is connected to the earth terminals of the main unit, otherwise an electric shock is caused when a leak occurs. If the earth wire is not correctly connected, contact an electric engineer for rework.
 Prohibition of modification.	Do not modify the products. Do not also disassemble or modify the parts. It may cause a fire, electric shock or injury.
 Use specified parts.	For spare parts, use those specified (*). If unspecified parts are used, a fire or electric shock may be caused. *: For details, refer to the parts list.
 Do not bring a child close to the equipment.	Before troubleshooting or repair work, do not bring a third party (a child, etc.) except the repair engineers close to the equipment. It causes an injury with tools or disassembled parts. Please inform the users so that the third party (a child, etc.) does not approach the equipment.
 Insulating measures	Connect the cut-off lead cables with crimp contact, etc, put the closed end side upward and then apply a water-cut method, otherwise a leak or production of fire is caused at the users' side.
 No fire	When repairing the refrigerating cycle, take the following measures. 1) Be attentive to fire around the cycle. When using a gas stove, etc, be sure to put out fire before work; otherwise the oil mixed with refrigerant gas may catch fire. 2) Do not use a welder in the closed room. When using it without ventilation, carbon monoxide poisoning may be caused. 3) Do not bring inflammables close to the refrigerant cycle, otherwise fire of the welder may catch the inflammables.
 Refrigerant	Check the used refrigerant name and use tools and materials of the parts which match with it. For the products which use R410A refrigerant, the refrigerant name is indicated at a position on the outdoor unit where is easy to see. To prevent miss-charging, the route of the service port is changed from one of the former R22. For an air conditioner which uses R410A, never use other refrigerant than R410A. For an air conditioner which uses other refrigerant (R22, etc.), never use R410A. If different types of refrigerant are mixed, abnormal high pressure generates in the refrigerating cycle and an injury due to breakage may be caused. Do not charge refrigerant additionally. If charging refrigerant additionally when refrigerant gas leaks, the refrigerant composition in the refrigerating cycle changes resulted in change of air conditioner characteristics or refrigerant over the specified standard amount is charged and an abnormal high pressure is applied to the inside of the refrigerating cycle resulted in cause of breakage or injury. Therefore if the refrigerant gas leaks, recover the refrigerant in the air conditioner, execute vacuuming, and then newly recharge the specified amount of liquid refrigerant. In this time, never charge the refrigerant over the specified amount. When recharging the refrigerant in the refrigerating cycle, do not mix the refrigerant or air other than R410A into the specified refrigerant. If air or others is mixed with the refrigerant, abnormal high pressure generates in the refrigerating cycle resulted in cause of injury due to breakage. After installation work, check the refrigerant gas does not leak. If the refrigerant gas leaks in the room, poisonous gas generates when gas touches to fire such as fan heater, stove or cooking stove though the refrigerant gas itself is innocuous. Never recover the refrigerant into the outdoor unit. When the equipment is moved or repaired, be sure to recover the refrigerant with recovering device. The refrigerant cannot be recovered in the outdoor unit; otherwise a serious accident such as breakage or injury is caused.

 WARNING	
 Assembly/Cabling	<p>After repair work, surely assemble the disassembled parts, and connect and lead the removed cables as before. Perform the work so that the cabinet or panel does not catch the inner cables.</p> <p>If incorrect assembly or incorrect cable connection was done, a disaster such as a leak or fire is caused at user's side.</p>
 Insulator check	<p>After the work has finished, be sure to use an insulation tester set (500V mugger) to check the resistance is 2MW or more between the charge section and the non-charge metal section (Earth position).</p> <p>If the resistance value is low, a disaster such as a leak or electric shock is caused at user's side.</p>
 Ventilation	<p>When the refrigerant gas leaks during work, execute ventilation.</p> <p>If the refrigerant gas touches to a fire, poisonous gas generates. A case of leakage of the refrigerant and the closed room full with gas is dangerous because a shortage of oxygen occurs. Be sure to execute ventilation.</p>
 Be attentive to electric shock	<p>When checking the circuit inevitably under condition of the power-ON, use rubber gloves and others not to touch to the charging section.</p> <p>If touching to the charging section, an electric shock may be caused.</p>
 Compulsion	<p>When the refrigerant gas leaks, find up the leaked position and repair it surely.</p> <p>If the leaked position cannot be found up and the repair work is interrupted, pump-down and tighten the service valve, otherwise the refrigerant gas may leak into the room. The poisonous gas generates when gas touches to fire such as fan heater, stove or cooking stove though the refrigerant gas itself is innocuous.</p> <p>When installing equipment which includes a large amount of charged refrigerant such as a multi air conditioner in a sub-room, it is necessary that the density does not the limit even if the refrigerant leaks.</p> <p>If the refrigerant leaks and exceeds the limit density, an accident of shortage of oxygen is caused.</p> <p>For the installation/moving/reinstallation work, follow to the Installation Manual.</p> <p>If an incorrect installation is done, a trouble of the refrigerating cycle, water leak, electric shock or fire is caused.</p>
 Check after repair	<p>After repair work has finished, check there is no trouble.</p> <p>If check is not executed, a fire, electric shock or injury may be caused. For a check, turn off the power breaker.</p> <p>After repair work (installation of front panel and cabinet) has finished, execute a test run to check there is no generation of smoke or abnormal sound.</p> <p>If check is not executed, a fire or an electric shock is caused. Before test run, install the front panel and cabinet.</p>
 Check after reinstallation	<p>Check the following items after reinstallation.</p> <ol style="list-style-type: none"> 1) The earth wire is correctly connected. 2) The power cord is not caught in the product. 3) There is no inclination or unsteadiness and the installation is stable. <p>If check is not executed, a fire, an electric shock or an injury is caused.</p>

 CAUTION	
 Put on gloves	<p>Be sure to put on gloves (*) during repair work.</p> <p>If not putting on gloves, an injury may be caused with the parts, etc.</p> <p>(*) Heavy gloves such as work gloves</p>
 Cooling check	<p>When the power was turned on, start to work after the equipment has been sufficiently cooled.</p> <p>As temperature of the compressor pipes and others became high due to cooling/heating operation, a burn may be caused.</p>

• New Refrigerant (R410A)

This air conditioner adopts a new HFC type refrigerant (R410A) which does not deplete the ozone layer.

1. Safety Caution Concerned to New Refrigerant

The pressure of R410A is high 1.6 times of that of the former refrigerant (R22). Accompanied with change of refrigerant, the refrigerating oil has been also changed. Therefore, be sure that water, dust, the former refrigerant or the former refrigerating oil is not mixed into the refrigerating cycle of the air conditioner with new refrigerant during installation work or service work. If an incorrect work or incorrect service is performed, there is a possibility to cause a serious accident. Use the tools and materials exclusive to R410A to purpose a safe work.

2. Cautions on Installation/Service

- (1) Do not mix the other refrigerant or refrigerating oil.

For the tools exclusive to R410A, shapes of all the joints including the service port differ from those of the former refrigerant in order to prevent mixture of them.

- (2) As the use pressure of the new refrigerant is high, use material thickness of the pipe and tools which are specified for R410A.

- (3) In the installation time, use clean pipe materials and work with great attention so that water and others do not mix in because pipes are affected by impurities such as water, oxide scales, oil, etc. Use the clean pipes.

Be sure to brazing with flowing nitrogen gas. (Never use gas other than nitrogen gas.)

- (4) For the earth protection, use a vacuum pump for air purge.

- (5) R410A refrigerant is azeotropic mixture type refrigerant. Therefore use liquid type to charge the refrigerant. (If using gas for charging, composition of the refrigerant changes and then characteristics of the air conditioner change.)

3. Pipe Materials

For the refrigerant pipes, copper pipe and joints are mainly used. It is necessary to select the most appropriate pipes to conform to the standard. Use clean material in which impurities adhere inside of pipe or joint to a minimum.

- (1) Copper pipe

<Piping>

The pipe thickness, flare finishing size, flare nut and others differ according to a refrigerant type.

When using a long copper pipe for R410A, it is recommended to select "Copper or copper-base pipe without seam" and one with bonded oil amount 40mg/10m or less. Also do not use crushed, deformed, discolored (especially inside) pipes. (Impurities cause clogging of expansion valves and capillary tubes.)

<Flare nut>

Use the flare nuts which are attached to the air conditioner unit.

- (2) Joint

The flare joint and socket joint are used for joints of the copper pipe.

The joints are rarely used for installation of the air conditioner. However clear impurities when using them.

4. Tools

(1) Required Tools for R410A

Mixing of different types of oil may cause a trouble such as generation of sludge, clogging of capillary, etc. Accordingly, the tools to be used are classified into the following three types.

- 1) Tools exclusive for R410A (Those which cannot be used for conventional refrigerant (R22))
- 2) Tools exclusive for R410A, but can be also used for conventional refrigerant (R22)
- 3) Tools commonly used for R410A and for conventional refrigerant (R22)

The table below shows the tools exclusive for R410A and their interchangeability.

Tools exclusive for R410A (The following tools for R410A are required.)

Tools whose specifications are changed for R410A and their interchangeability

No.	Used tool	Usage	R410A air conditioner installation		Conventional air conditioner installation
			Existence of new equipment for R410A	Whether conven- tional equipment can be used	Whether new equipment can be used with conventional refrigerant
①	Flare tool	Pipe flaring	Yes	*(Note 1)	Yes
②	Copper pipe gauge for adjusting projection margin	Flaring by conventional flare tool	Yes	*(Note 1)	*(Note 1)
③	Torque wrench	Connection of flare nut	Yes	No	No
④	Gauge manifold	Evacuating, refrigerant charge, run check, etc.	Yes	No	No
⑤	Charge hose				
⑥	Vacuum pump adapter	Vacuum evacuating	Yes	No	Yes
⑦	Electronic balance for refrigerant charging	Refrigerant charge	Yes	Yes	Yes
⑧	Refrigerant cylinder	Refrigerant charge	Yes	No	No
⑨	Leakage detector	Gas leakage check	Yes	No	Yes
⑨	Charging cylinder	Refrigerant charge	(Note 2)	No	No

(Note 1) When flaring is carried out for R410A using the conventional flare tools, adjustment of projection margin is necessary. For this adjustment, a copper pipe gauge, etc. are necessary.

(Note 2) Charging cylinder for R410A is being currently developed.

General tools (Conventional tools can be used.)

In addition to the above exclusive tools, the following equipments which serve also for R22 are necessary as the general tools.

- | | |
|---|---|
| (1) Vacuum pump
Use vacuum pump by
attaching vacuum pump adapter. | (7) Screwdriver (+, -) |
| (2) Torque wrench | (8) Spanner or Monkey wrench |
| (3) Pipe cutter | (9) Hole core drill |
| (4) Reamer | (10) Hexagon wrench (Opposite side 4mm) |
| (5) Pipe bender | (11) Tape measure |
| (6) Level vial | (12) Metal saw |

Also prepare the following equipments for other installation method and run check.

- | | |
|-----------------|----------------------------------|
| (1) Clamp meter | (3) Insulation resistance tester |
| (2) Thermometer | (4) Electroscope |

5. Recharge of Refrigerant

When recharge of the refrigerant is required, charge the new refrigerant with the specified amount in the procedure as described below.

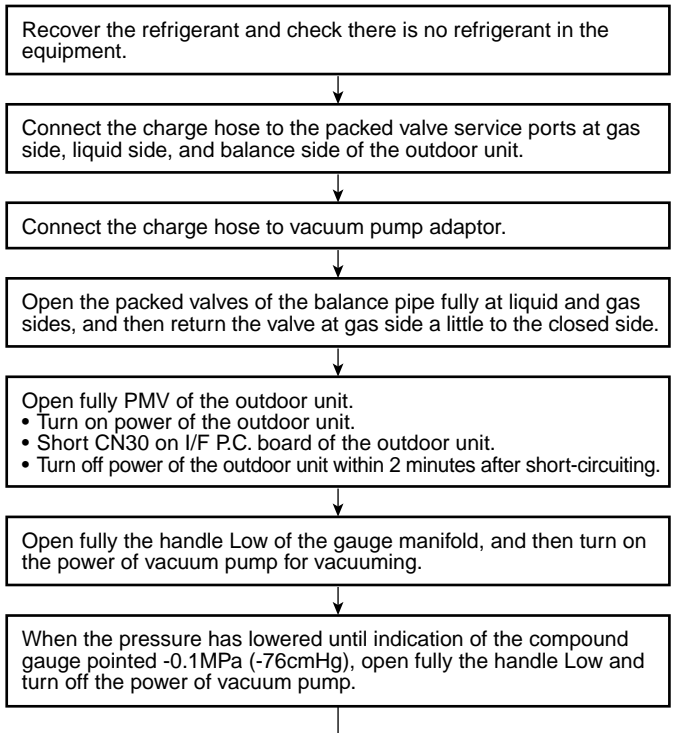

- ① Never charge the refrigerant over the specified amount.
- ② Do not charge the additional refrigerant. If charging refrigerant additionally when refrigerant gas leaks, the refrigerant composition in the refrigerating cycle changes resulted in change of air conditioner characteristics or refrigerant over the specified standard amount is charged and an abnormal high pressure is applied to the inside of the refrigerating cycle resulted in cause of breakage or injury.

Leave it as it is for 1 to 2 minutes and check the indicator of the compound gauge does not return.

Set the refrigerant cylinder on the electron balance, connect the charge hose to connecting ports of the cylinder and the electron gauge, and then charge the liquid refrigerant from the service port at liquid side. (Shield with the gauge manifold so that refrigerant does not flow to gas side.)

(Charge the refrigerant as below.)

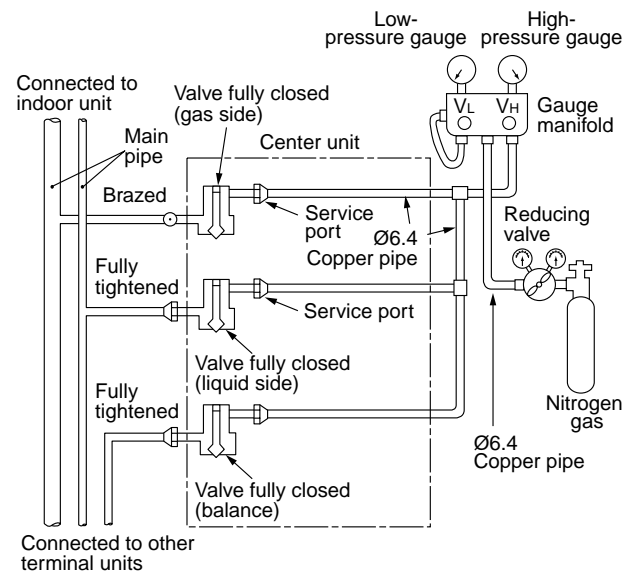

4mm-hexagonal wrench is required.

- ① Set the equipment so that liquid refrigerant can be charged.
- ② When using a cylinder with siphon pipe, liquid can be charged without inverting the cylinder.

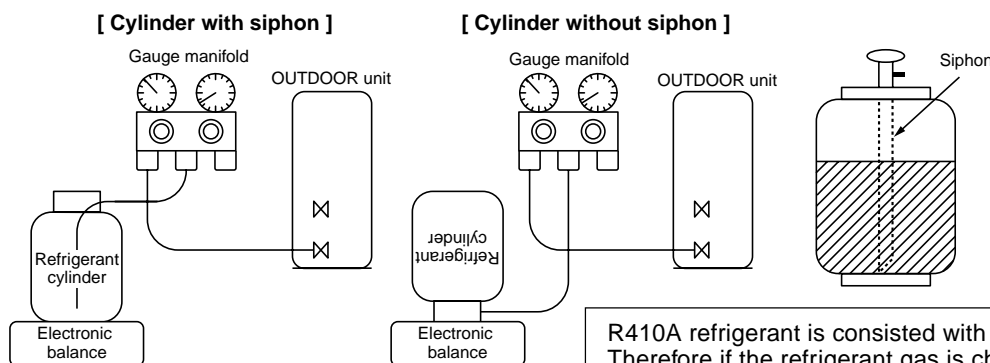

R410A refrigerant is consisted with HFC mixed refrigerant. Therefore if the refrigerant gas is charged, the composition of the charged refrigerant changes and characteristics of the equipment changes.

6. Environment

Use "Vacuum pump method" for an air purge (Discharge of air in the connecting pipe) in installation time.

- Do not discharge flon gas into the air to protect the earth environment.
- Using the vacuum pump method, clear the remained air (Nitrogen, etc.) in the unit. If the air remains, the pressure in the refrigerating cycle becomes abnormally high and an injury and others are caused due to burst.

1. CONSTRUCTION VIEWS (EXTERNAL VIEWS)

Model: MMK-AP0072H, AP0092H, AP0122H

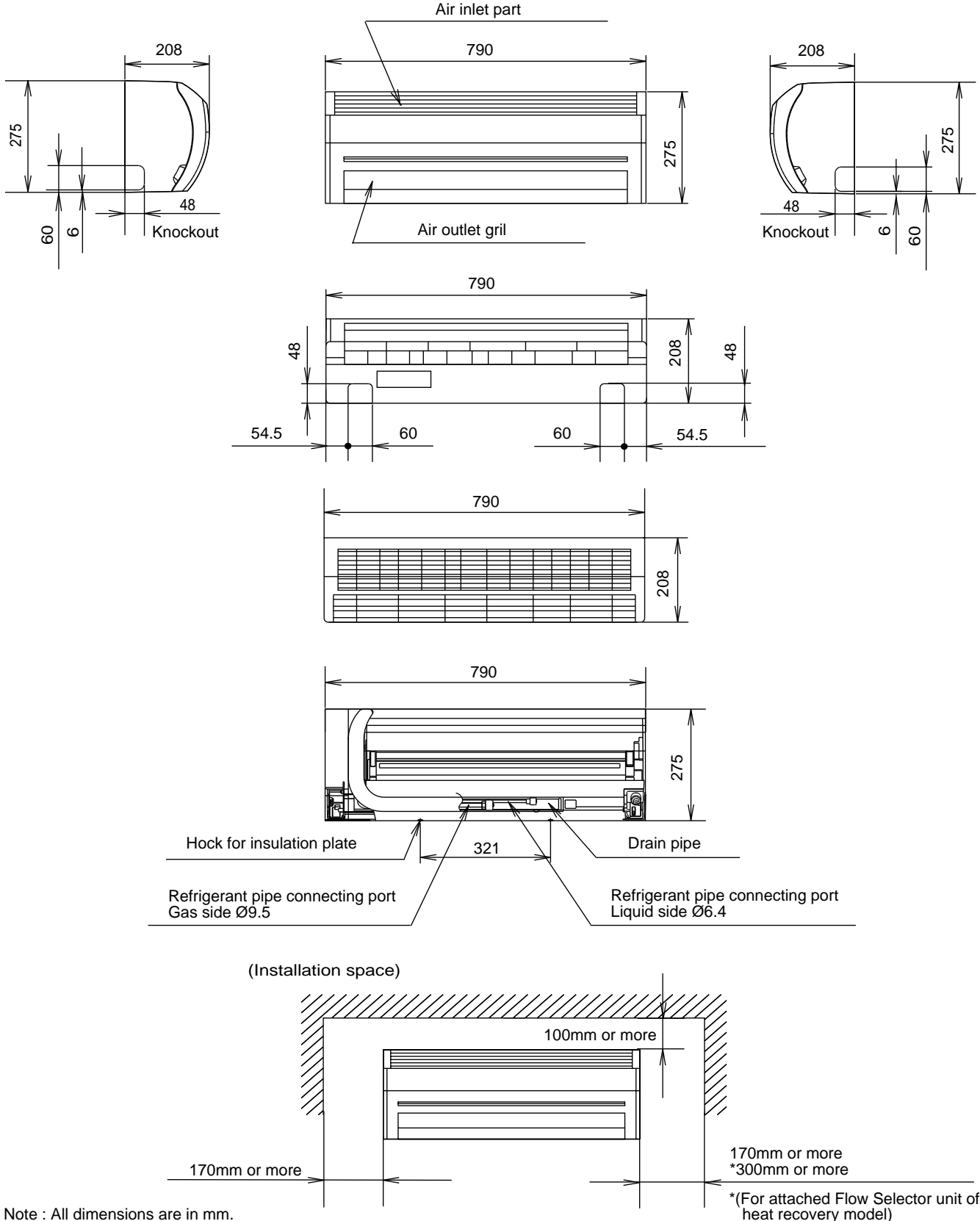

Note : All dimensions are in mm.

*(For attached Flow Selector unit of heat recovery model)

2. WIRING DIAGRAM

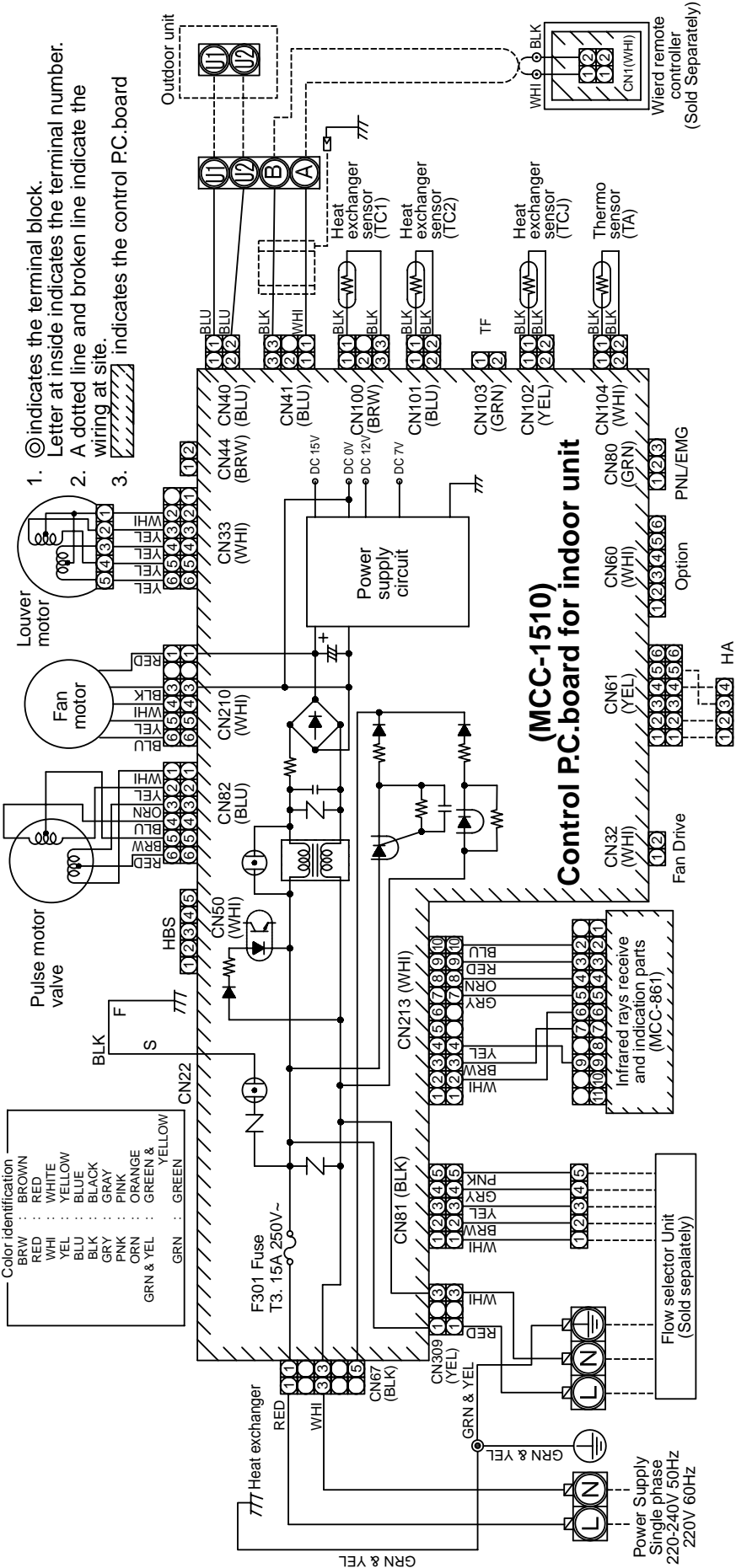

3. PARTS RATING

3-1. Parts Rating

No.	Parts Name	Type	Specications
1	Fan motor (for indoor)	ICF-340-30 MF-340-30	Output (Rated) 30W, 280-340V DC
2	Grille motor	MP24Z	
3	Thermo. Sensor (TA sensor)	318mm	10k Ω at 25°C
4	Heat exchanger sensor (TC1 sensor)	Ø4, 600mm	10k Ω at 25°C
5	Heat exchanger sensor (TC2 sensor)	Ø6, 800mm	10k Ω at 25°C
6	Heat exchanger sensor (TCJ sensor)	Ø6, 800mm	10k Ω at 25°C

3-2. Name of Each Part

Air inlet grille

Air in the room is sucked from here.

Earth screw

Earth screws are provided in the electric parts box.

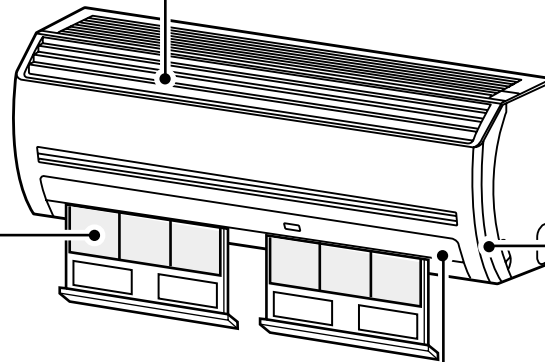

Air filter

Removes dust and trash.
(Air filter is provided in the air inlet grille.)

Air outlet/Air outlet flap

Change the direction of the air to be discharged according to cool/heat mode.

3-3. Parts Name of Remote Controller

Operation section

- Using a remote controller, maximum 8 indoor units can be operated.
- After the operation contents have been once set up, the remote controller can be operated by pushing ON/OFF buttons only.

In reality only, the selected contents are indicated.

- When turning on the leak breaker at the first time, [SET DATA] flashes on the display part of the remote controller. While this display is flashing, the model is being automatically confirmed. Accordingly, wait for a while after [SET DATA] display has disappeared, and then use the remote controller.

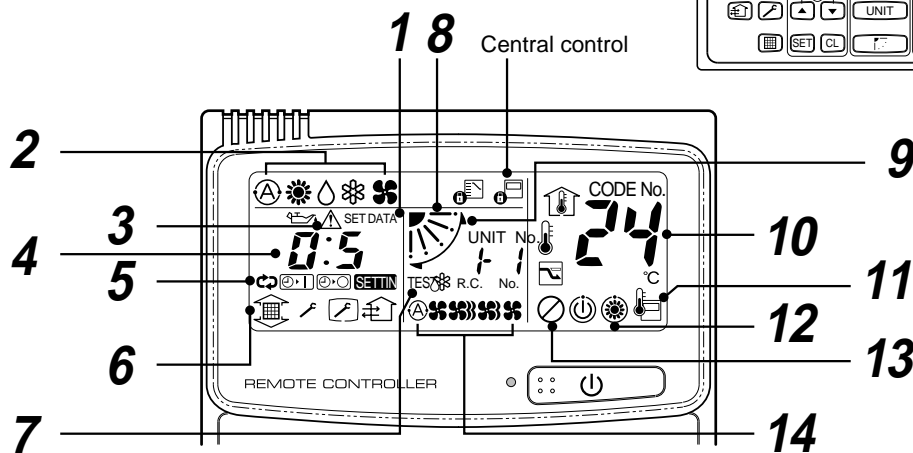
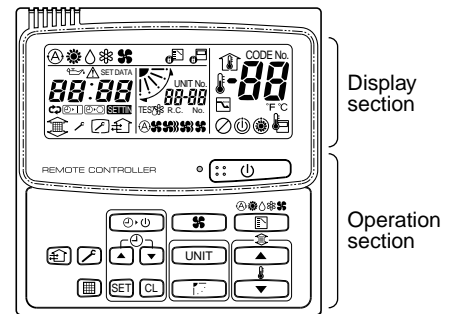

1 SET DATA display

Displayed during setup of the timer.

2 Operation mode select display

The selected operation mode is displayed.

3 CHECK display

Displayed while the protective device works or a trouble occurs.

4 Timer time display

Time of the timer is displayed. (When a trouble occurs, the check code is displayed.)

5 Timer SETIN setup display

When pushing the Timer SETIN button, the display of the timer is selected in order of [OFF] → [OFF] repeat OFF timer → [ON] → No display.

6 Filter display

If "FILTER

7 TEST run display

Displayed during a test run.

8 Flap position display

Displays flap position.

9 SWING display

Displayed during up/down movement of the flap.

10 Set up temperature display

The selected set up temp. is displayed.

11 Remote controller sensor display

Displayed while the sensor of the remote controller is used.

12 PRE-HEAT display

Displayed when the heating operation starts or defrost operation is carried out.

While this indication is displayed, the indoor fan stops or the mode enters in LOW.

13 No function display

Displayed if there is no function even if the button is pushed.

14 Air volume select display

The selected air volume mode is displayed.

- (AUTO)
- (HIGH)
- (MED.)
- (LOW)

15 Stand by display

Displayed when unit cannot start cooling operation because other indoor units are being heating operation.

Operation section

Push each button to select a desired operation.

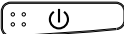
- The details of the operation needs to be set up once, afterward, the air conditioner can be used by pushing  button only.

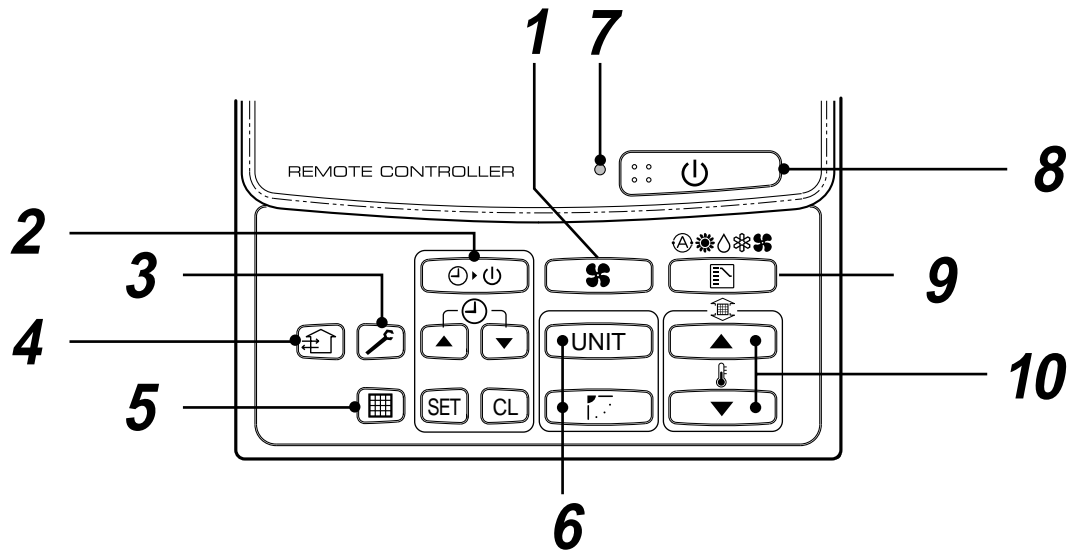

1 Air volume select button

Selects the desired air volume mode.

2 Timer set button

TIMER SET button is used when the timer is set up.

3 Check button

The CHECK button is used for the check operation. During normal operation, do not use this button.

4 Fan button

FAN button is used when a fan which is sold on the market or etc. is connected.

- If "No function" is displayed on the remote controller when pushing the FAN button, a fan is not connected.

5 Filter reset button

Resets (Erases) "FILTER " display.

6 UNIT and AUTO flap button

 Select a unit No.

 Automatic swing or adjust flap angle

7 Operation lamp

Lamp is lit during the operation. Lamp is off when stopped.

Although it flashes when operating the protection device or abnormal time.

8 button

When the button is pushed, the operation starts, and it stops by pushing the button again.

When the operation has stopped, the operation lamp and all the displays disappear.



9 Operation select button

Selects desired operation mode.

10 Set up temperature button

Adjusts the room temperature.

Set the desired set temperature by pushing

 or .

OPTION :

Remote controller sensor

Usually the TEMP. sensor of the indoor unit senses the temperature. The temperature on the surrounding of the remote controller can also be sensed. For details, contact the dealer from which you have purchased the air conditioner.

3-4. Correct Usage

When you use the air conditioner for the first time or when you change the SET DATA value, follow the procedure below. From the next time, the operation displayed on the remote controller will start by pushing the

 button only.

Preparation

Turn on the main power switch and/or the leakage breaker.

- When the power supply is turned on, a partition line is displayed on the display part of the remote controller.
- * After the power supply is turned on, the remote controller does not accept an operation for approx. 1 minute, but it is not a failure.

REQUIREMENT

- While using the air conditioner, operate it only with  button without turning off the main power switch and the leak breaker.

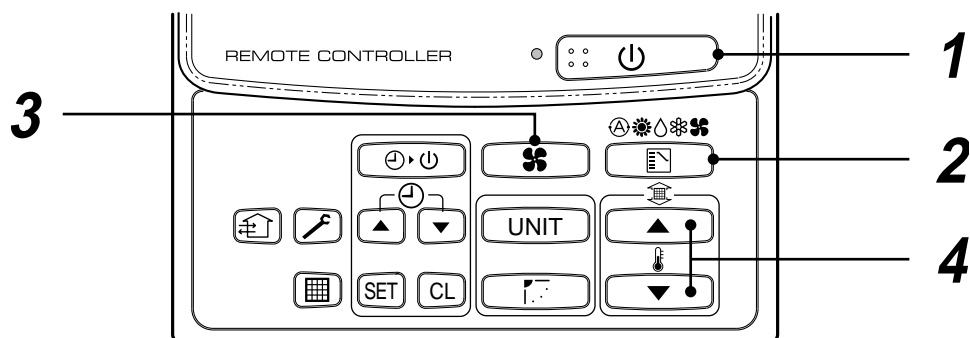



1 Push button.

The operation lamp goes on, and the operation starts.

2 Select an operation mode with the “MODE” button.

One push of the button, and the display changes in the order shown on the right.

- In HEAT  mode, if the room temperature reaches to the set temperature, the outdoor unit stops and the air flow becomes LOW and the air volume decreases.
- In the defrost mode, the fan stops so that cool air is not discharged and PRE-DEF  is displayed.

Cooling only model

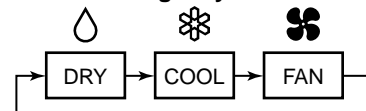



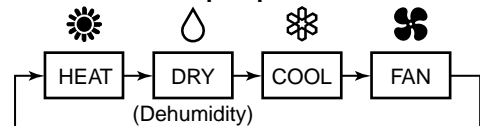



Heat-pump model

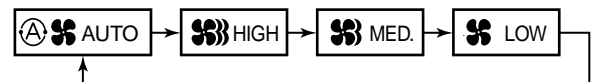

3 Select air volume with “FAN ” button.

One push of the button, and the display changes in the order shown on the right.



- When air volume is “AUTO ”, air volume differs according to the temperature difference between set temp. and room temp.
- In DRY  mode, “AUTO ” is displayed and the air volume is LOW.
- In heating operation, if the room temperature is not heated sufficiently with VOLUME “LOW ” operation, select “MED. ” or “HIGH ” operation.

4 Determine the set up temperature by pushing the “TEMP. ” or “TEMP. ” button.

Stop

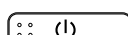
Push  button.

The operation lamp goes off, and the operation stops.

3-5. Automatic Operation (Super Heat Recovery Type Only)

When you set the air conditioner in $\text{\textcircled{A}}$ mode or switch over from AUTO operation because of some settings change, it will automatically select either cooling, heating, or fan only operation depending on the indoor temperature.

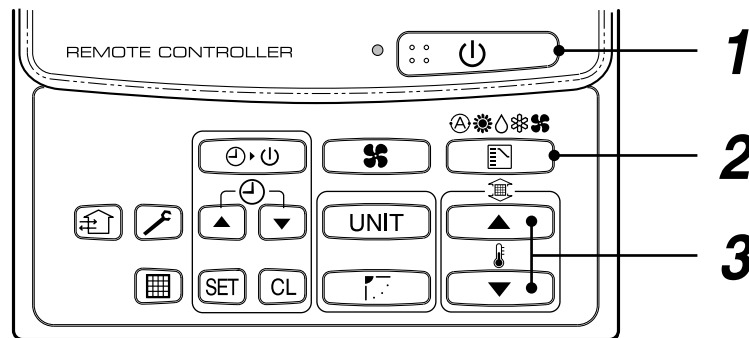

Start

1 button

Push this button to start the air conditioner.

2 Mode select button (MODE)

Select Auto.

3 Temperature button

Set the desired temperature.

- In case of cooling, start the operation after approx. 1 minute.
- In case of heating, the operation mode is selected in accordance with the room temperature and operation starts after approximately 3 to 5 minutes.
- When you select the Auto mode, it is unnecessary to set the fan speed. The FAN speed display will show AUTO and the fan speed will be automatically controlled.
- After the heating operation has stopped, FAN operation may continue for approx. 30 seconds.
- When the room temperature reaches the set temperature and the outdoor unit stops, the super low wind is discharged and the air volume decreases excessively. During defrost operation, the fan stops so that cool air is not discharged and "HEAT READY" is displayed.
- If the Auto mode is uncomfortable, you can select the desired conditions manually.

NOTE

When restarting the operation after stop

- When restarting the operation immediately after stop, the air conditioner does not operate for approx. 3 minutes to protect the machine.

Stop

Push button.

Push this button again to stop the air conditioner.

3-6. TIMER Operation

A type of timer operation can be selected from the following three types.

- OFF timer : The operation stops when the time of timer has reached the set time.
 Repeat OFF timer : Every time, the operation stops after the set time has passed.
 ON timer : The operation starts when the time of timer has reached the set time.

Timer operation

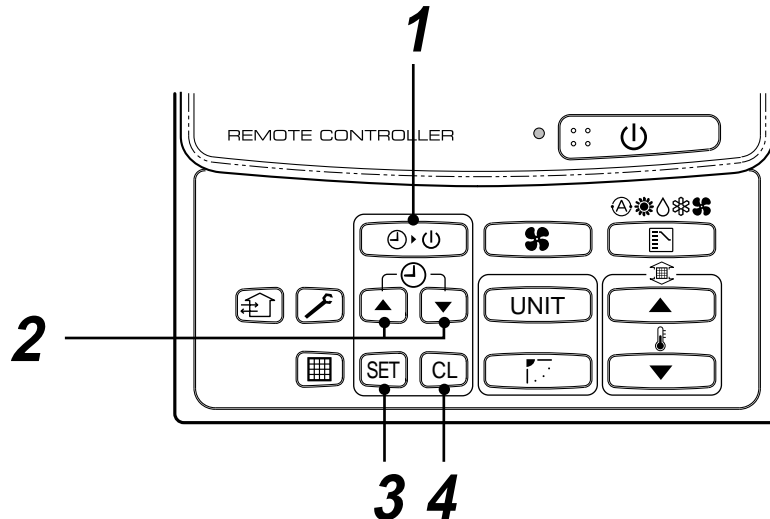

1 Push TIMER SET button.

- The timer display (type) changes for every push of the button.
- SET DATA and  display flashes.

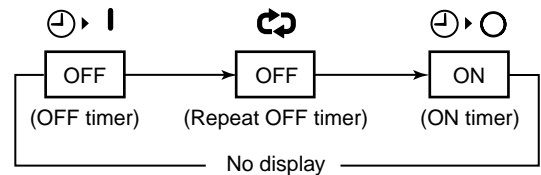

2 Push to select "SET TIME".

For every push of  button, the set time increases in the unit of 0.5 hr (30 minutes).

The maximum set time is 72.0 hr.

For every push of  button, the set time decreases in the unit of 0.5 hr (30 minutes).

The minimum set time is 0.5 hr.

3 Push SET button.

- SET DATA display disappears and  display goes on.
 (When ON timer is activated, time is displayed, and after time of the timer has been up, displays other than ON disappear.)

Cancel of timer operation

4 Push CL button.

- TIMER display disappears.

NOTICE

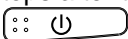
- When the operation stops after the timer reached the preset time, the Repeat OFF timer resumes the operation by pushing  button and stops the operation after the time of the timer has reached the set time.

3-7. Re-Installation

DANGER

**Ask the dealer or an installation professional to re-install the air conditioner to a new place or move it to another place and to observe the following items.
If the air conditioner is inappropriately by installed by yourself, it may cause electric shock or fire.**

Do not install the air conditioner in the following places

- Do not install the air conditioner in any place within 1 m from a TV, stereo, or radio set. If the unit is installed in such place, noise transmitted from the air conditioner affects the operation of these appliances.
- Do not install the air conditioner near a high frequency appliance (sewing machine or massager for business use, etc.), otherwise the air conditioner may malfunction.
- Do not install the air conditioner in a humid or oily place, or in a place where steam, soot, or corrosive gas is generated.
- Do not install the air conditioner in a salty place such as seaside area.
- Do not install the air conditioner in a place where a great deal of machine oil is used.
- Do not install the air conditioner in a place where it is usually exposed to strong wind such as in seaside area or on the roof or upper floor of a building.
- Do not install the air conditioner in a place where sulfurous gas generated such as in a spa.
- Do not install the air conditioner in a vessel or mobile crane. Be careful with noise or vibrations
- Do not install the air conditioner in a place where noise by outdoor unit or hot air from its air outlet annoys your neighbors.
- Install the air conditioner on a solid and stable foundation so that it prevents transmission of resonating, operation noise and vibration.
- If one indoor unit is operating, some sound may be audible from other indoor units that are not operating.



3-8. Troubles and Causes

CAUTION

If any of the following conditions occur, turn off the main power supply switch and immediately contact the dealer :

- The operation lamps flash at short intervals (5 Hz) even though you have tried turning off the power supply and turning on again after 2 or 3 minutes.
- Switch operation does not work properly.
- The main power fuse often blows out, or the circuit breaker is often activated.
- A foreign matter or water fall inside the air conditioner.
- Any other unusual conditions are observed.

3-9. Information

Confirmation before operation

- Turn on the power switch 12 hours before starting the operation.
- Make sure whether earth wire is connected.
- Make sure the air filter is connected to the indoor unit.

Heating capacity

- A heat pump system which absorbs heat from outside of the room and then discharges heat into the room is adopted for heating. If the outside temperature falls, the heating capacity decreases.
- When the outside temperature is too low, it is recommended to use this air conditioner together with other heating equipment.

Defrost during heating operation

- In heating operation, if there is frost on the outdoor unit, the operation changes automatically to the defrost operation (Approx. 2 to 10 minutes) to increase the heating efficiency.
- During defrost operation, the fan of the indoor unit stops.

3-minutes protection

- When restarting the operation just after the operation has been stopped or the main power switch has turned on, the outdoor unit does not work for approx. 3 minutes in order to protect the air conditioner.

Power failure

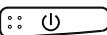
- If a power failure occurred during operation, all operations stop.
- When the power is returned after a power failure, the operation lamp notifies the power-ON by flashing operation lamp on the remote controller.
- When restarting the operation, push  button again.

Fan rotation in stopped unit

- In heating operation even in the stopped indoor unit, the fan rotates once for several minutes per approx. an hour when the other indoor unit is operating to protect the air conditioner.

Protective device (High pressure switch)

This device stops automatically an operation when excessive force is applied on the air conditioner.

If the protective device works, the operation stops and the operation lamp flashes.

When the protective device works, the indication



and the check code are displayed on the display section of the remote controller. In the following cases, the protective device may work.

In cooling operation



- The suction port or discharge port of the outdoor unit is closed.
- A strong wind continuously blows to the discharge port of the outdoor unit.

In heating operation

- Dust or waste adheres excessively to air filter of the indoor unit.
- The discharge port of the indoor unit is closed.

If the protective device works, turn off the main power switch, solve the cause, and then start the operation again.

Cooling/Heating operation of Super Modular Multi system air conditioner

- Although each indoor unit can be individually controlled in the Super Modular Multi system air conditioner, the cooling operation and the heating operation cannot be simultaneously performed in the multiple indoor units which are connected to an outdoor unit.
- If the cooling operation and the heating operation are simultaneously performed, the indoor unit which executes cooling operation stops, and  on the operation section lights up. On the other hand, the indoor unit which executes heating operation continues running. In a case that the manager of the air conditioner has fixed the operation to cooling or heating, an operation other than that set up is unavailable. If an operation other than that set up is executed,  on the operation section lights up and the operation stops.

Characteristics of heating operation

- The wind is not out just after starting an operation. The hot wind starts to blow 3 to 5 minutes after (Time differs according to indoor/outdoor temperature.) the indoor heat exchanger has warmed up.
- During operation, the outdoor unit may stop if the outside temperature rises.

3-10. Adjustment of Air Direction

To increase the cooling/heating efficiency, be sure to make proper use of the discharge flap for cooling or heating operation.

As the characteristics of air, cool air collects at lower levels, and hot air collects at higher levels.

CAUTION

Set the flap so that air blows out horizontally.

If cooling operation is performed with the flap blowing air downwards, the air outlet or surface of the flap will be wet with dew, and dewdrop may fall down.

Setup of air direction and swinging

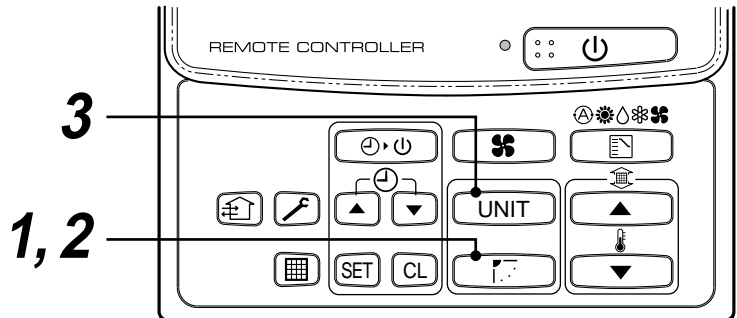
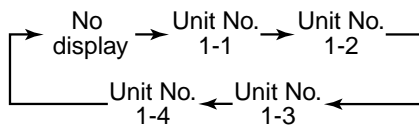

1 Push during operation.

- is displayed and the air direction is automatically exchanged upward/downward.

When a remote controller operates the multiple indoor units, an indoor unit is selected and air direction can be individually set up.

2 Push again during swinging of the flap.

- You can stop the flap at the desired position.

3 Auto flap button

- Push to set up the air direction individually in each indoor unit. Then the indoor unit No. in a group control is displayed. For the displayed indoor unit, set up the air direction.
- If the unit No. is not displayed, all the indoor units are operated at the same time.
- Every pushing , the display is exchanged as follows:

[High Wall Type]

<Up/Down air direction adjustment>

In cooling operation

In cooling operation, use the air outlet flap with horizontal set point so that cool air diffuses the whole room.

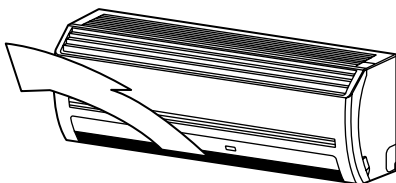

In heating operation

In heating operation, use the air outlet flap with downward set point so that the hot air is spread to the floor.

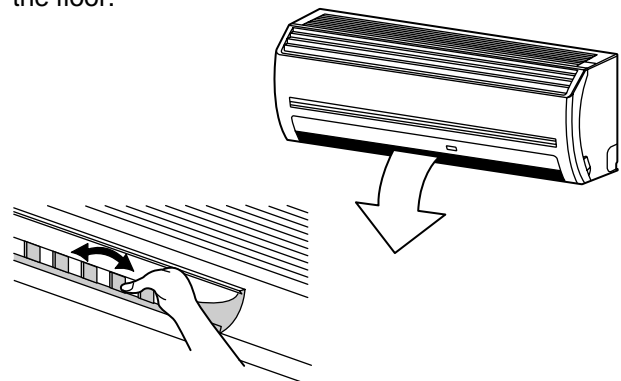

<Left/Right air direction adjustment>

When you change the blowout direction to left/right, direct the vertical flap inside of the air outlet flap to desired direction.

3-11. Air Conditioner Operations and Performance

3 minutes protection function

3-minutes protection function prevents the air conditioner from starting for initial 3 minutes after the main power switch/circuit breaker is turned on for re-starting the air conditioner.

Power failure

Power failure during operation will stop the unit completely.

- To restart the operation, push the START/STOP button on the remote controller.
- Lightning or a wireless car telephone operating nearby may cause the unit to malfunction. Turn off the main power switch or circuit breaker and then turn them on again. Push the START/STOP button on the remote controller to restart.

Heating characteristics

Preheating operation

The air conditioner will not deliver warm air immediately after it is turned on. Warm air will start to flow out after approximately 5 minutes when the indoor heat exchanger warmed up.

Warm air control (In heating operation)

When the room temperature reaches the set temperature, the fan speed is automatically reduced to prevent to blow cold draft. At this time, the outdoor unit will stop.

Defrosting operation

If the outdoor unit is frosted during the heating operation, defrosting starts automatically (for approximately 2 to 10 minutes) to maintain the heating capacity.

- The fans in both indoor and outdoor units will stop during the defrosting operation.
- During the defrosting operation, the defrosted water will be drained from the bottom plate of the outdoor unit.

Heating capacity

In the heating operation, the heat is absorbed from the outside and brought into the room. This way of heating is called heat pump system. When the outside temperature is too low, it is recommended to use another heating apparatus in combination with the air conditioner.

Attention to snowfall and freeze on the outdoor unit

- In snowy areas, the air inlet and air outlet of the outdoor unit are often covered with snow or frozen up. If snow or freeze on the outdoor unit is left as it is, it may cause machine failure or poor warming.
- In cold areas, pay attention to the drain hose so that it perfectly drains water without water remaining inside for freeze prevention. If water freezes in the drain hose or inside the outdoor unit, it may cause machine failure or poor warming.

Air conditioner operating conditions

For proper performance, operate the air conditioner under the following temperature conditions:

Cooling operation	Outdoor temperature : -5°C to 43°C
	Room temperature : 21°C to 32°C (Dry valve temp.), 15°C to 24°C (Wet valve temp.)
	CAUTION Room relative humidity – less than 80 %. If the air conditioner operates in excess of this figure, the surface of the air conditioner may cause dewing.
Dry operation	Outdoor temperature : 15°C to 43°C (Maximum suction air temp. 46°C)
	Room temperature : 17°C to 32°C
Heating operation	Outdoor temperature : -15°C to 15°C (Wet valve temp.)
	Room temperature : 15°C to 28°C (Dry valve temp.)

If air conditioner is used outside of the above conditions, safety protection may work.

3-12. Maintenance

For maintenance, be sure to turn off the main power switch.

⚠ WARNING

- Please do not intend to do the daily maintenance and/or Air Filter cleaning by yourself. Otherwise, you may contact with revolving fan or active electricity when you insert your hands into the unit during running of the air conditioners.

⚠ CAUTION

Do not handle the buttons with wet hands; otherwise an electric shock may be caused.

Cleaning of air filter

- When [FILTER] is displayed on the remote controller, maintain the air filter.
- Clogging of air filter decreases cooling/heating effect.

FILTER display
Notifies the time to clean the air filter.

FILTER reset
Push the FILTER switch after cleaning. "FILTER" display disappears.

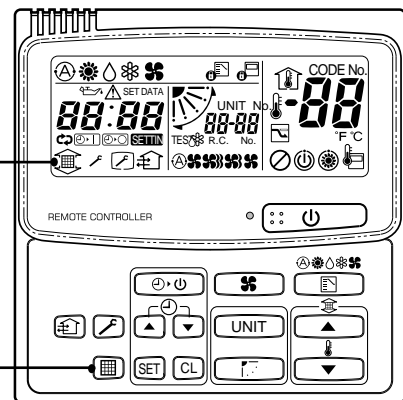

⚠ WARNING

- Be sure to turn off the main power switch prior to the maintenance.
- Please do not intend to do the daily maintenance and/or Air Filter cleaning by yourself. Cleaning of the air filter and other parts of the air filter involves dangerous work in high places, so be sure to have a service person do it. Do not attempt it yourself.

<Daily maintenance>

- Open the air inlet grille. Lift the air inlet grille up to the horizontal position.
- Take hold of the left and right handles of the air filter and lift it up slightly, then pull downward to take it out from the filter holder.

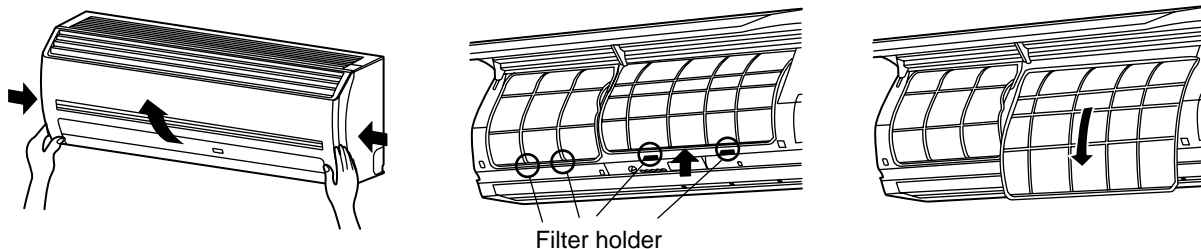

NOTE

- For cleaning of air filter, use a cleaner or brush clean. If stain is heavy, it is effective to wash the air filter in tepid water mixed with neutral detergent.
- After washing, rinse it well, and dry it in the shade.
- Install again the air filter which has been cleaned.



Return the air filter

- Insert the upper portion of air filter confirming to fit it is right and left edges on the indoor unit until it is firmly set.
- Close the air inlet grille.

If the FILTER lamp on the indoor unit is indicated, press the FILTER button on the remote controller or the TEMPORARY button on the indoor unit to turn off the lamp.

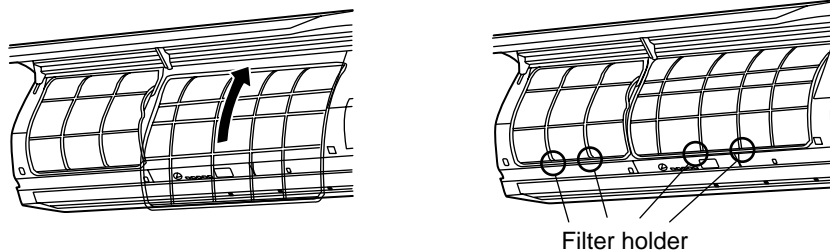

Cleaning the air inlet grille

1. Remove the air inlet grille.
Hold the two sides of the air inlet grille and open upwards.
Move the center arm to the left and remove the grille.
2. Wash it with water using a soft sponge or towel.
(Do not use metallic scrubbing brush or other hard brushes.)
 - Use of such hard objects will cause scratches on the surface of the grille, and the metal coating to peel off.
 - If very dirty, clean the air inlet grille with a neutral detergent for kitchen use, and rinse it off with water.
3. Wipe out water from the air inlet grille and dry it.
4. Fit the left and right arms of the air inlet grille to the shafts on the two sides of the air conditioner and push in completely, and then push in the center arm.
5. Check that the center arm has been completely inserted and close the air inlet grille.
 - Push the arrow locations (Four) at the bottom of the air inlet grille to check whether the grill is completely closed.

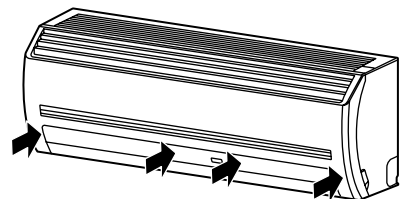
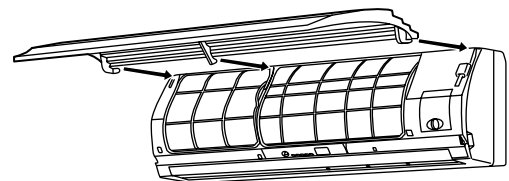
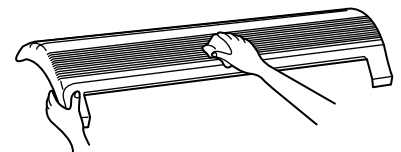
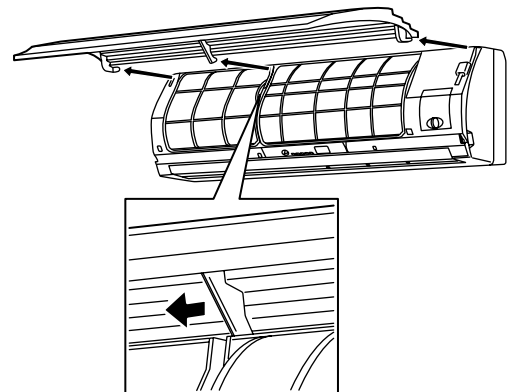

Cleaning of main unit / remote controller

CAUTION

- Wipe them with soft and dry cloth.
- A cloth dampened with cold water may be used on the indoor unit if it is very dirty.
- Never use a damp cloth on the main unit and remote controller.
- Do not use a chemically-treated duster for wiping or leave such materials on the unit for long. It may damage or fade the surface of the unit.
- Do not use benzine, thinner, polishing powder, or similar solvents for cleaning. These may cause the plastic surface to crack or deform.

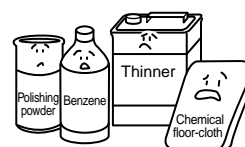

Do not use.

3-13. When the Following Symptoms are Found

Check the points described below before asking repair servicing.

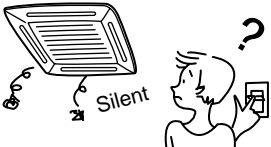
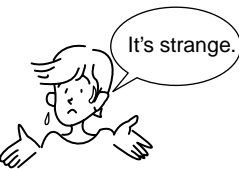
Symptom		Cause
Check again.	Outdoor unit <ul style="list-style-type: none"> • White misty cold air or water is out. • Sometimes, noise "Pushu!" is heard. 	<ul style="list-style-type: none"> • Fan of the outdoor unit stops automatically and performs defrost operation. • Solenoid valve works when defrost operation starts or finishes.
	Indoor unit <ul style="list-style-type: none"> • "Swish" sound is heard sometimes. • Slight "Pishi!" sound is heard. • Discharge air smells. • The operation lamp flashes • "STANDBY" indication is lit.  <ul style="list-style-type: none"> • Sound or cool air is output from the stand by indoor unit. • When power of the air conditioner is turned on, "Ticktock" sound is heard. 	<ul style="list-style-type: none"> • When the operation has started, during the operation, or immediately after the operation has stopped, a sound such as water flows may be heard, and the operation sound may become larger for 2 or 3 minutes immediately after the operation has started. They are flowing sound of refrigerant or draining sound of dehumidifier. • This is sound generated when heat exchanger, etc. expand and contract slightly due to change of temperature. • Various smell such as one of wall, carpet, clothes, cigarette, or cosmetics adhere to the air conditioner. • Flashes when power is turned on again after power failure, or when power switch is turned on. • When cooling operation cannot be performed because another indoor unit performs heating operation. • When the manager of the air conditioner has fixed the operation to COOL or HEAT, and an operation contrary to the setup operation is performed. • When fan operation stopped to prevent discharge of hot air. • Since refrigerant is flowed temporarily to prevent stay of oil or refrigerant in the stand by indoor unit, sound of flowing refrigerant, "Kyururu" or "Shaa" may be heard or white steam when other indoor unit operates in HEAT mode, and cold air in COOL mode may be blow-out. • Sound is generated when the expansion valve operates when power has been turned on.
It is not a failure.	Operates or stops automatically.	<ul style="list-style-type: none"> • Is the timer "ON" or "OFF"?
	Does not operate. 	<ul style="list-style-type: none"> • Is it a power failure? • Is the power switch turned off? • Is the power fuse or breaker blown? • Has the protective device operated? (The operation lamp goes on.) • Is the timer "ON"? (The operation lamp goes on.) • Are COOL and HEAT selected simultaneously? ("STANDBY" indication is lit on the display column of the remote controller.)
	Air is not cooled or warmed sufficiently. 	<ul style="list-style-type: none"> • Is the suction port or discharge port of the outdoor unit obstructed? • Are any door or window open? • Is the air filter clogged with dust? • Is discharge louver of the indoor unit set at appropriate position? • Is air selection set to "LOW" "MED", and is the operation mode set to "FAN"? • Is the setup temp. the appropriate temperature? • Are COOL and HEAT selected simultaneously? ("STANDBY" indication is lit on the display column of the remote controller.)

When the following symptoms are found, stop the operation immediately, turn off the power switch, and contact the dealer which you have purchased the air conditioner.

- Activation of switch is unstable.
- Fuse or breaker is blown periodically.
- Foreign matters or water entered by mistake.
- When if activation cause of the protective device has been removed, the operation is not performed.
- Other unusual status occurred.

4. REFRIGERATING CYCLE DIAGRAM

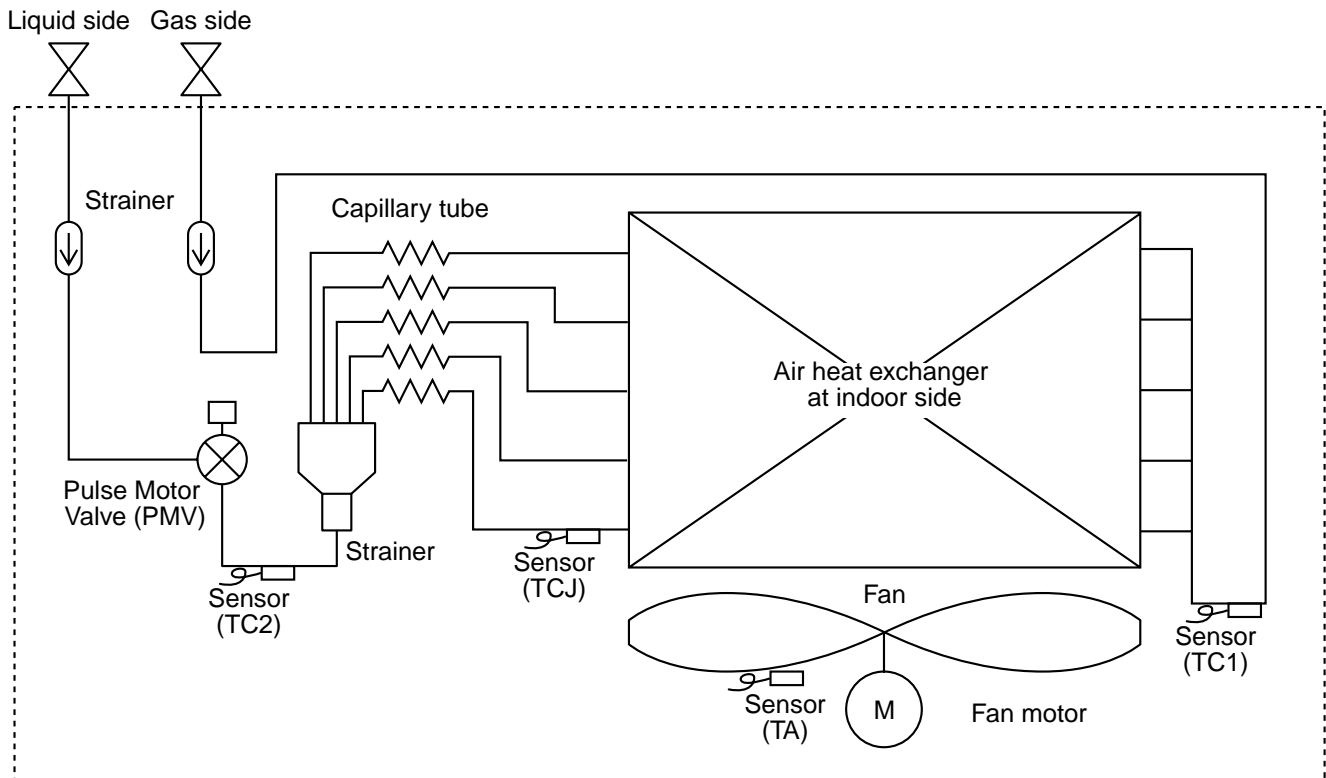





Functional part name		Functional outline
Pulse Motor Valve	PMV	(Connector CN082 (6P): Blue) 1) Controls super heat in cooling operation 2) Controls under cool in heating operation 3) Recovers refrigerant oil in cooling operation 4) Recovers refrigerant oil in heating operation
Temp. sensor	1. TA	(Connector CN104 (2P): White) 1) Detects indoor suction temperature
	2. TC1	(Connector CN100 (3P): Brown) 1) Controls PMV super heat in cooling operation
	3. TC2	(Connector CN101 (2P): Blue) 1) Controls PMV under cool in heating operation
	4. TCJ	(Connector CN102 (2P): Yellow) 1) Controls PMV super heat in cooling operation



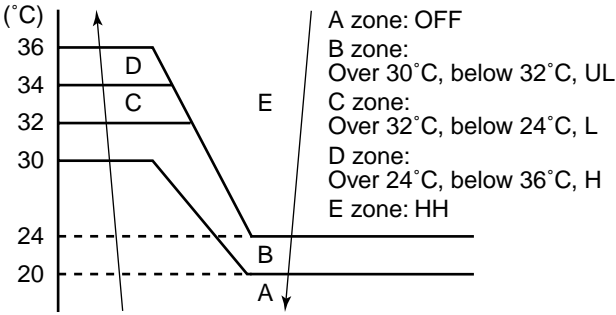
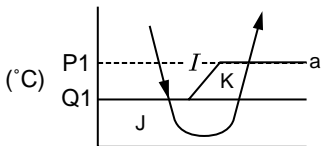
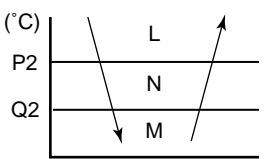

5. CONTROL OUTLINE

5-1. Indoor Unit Control Specifications

No.	Item	Outline of specifications	Remarks																					
1	Power supply is reset.	<p>(1) Distinction of outdoor unit When the power supply is reset, the outdoor units are distinguished, and control is exchanged according to the distinctive results.</p> <p>(2) Check code clear When the power supply is reset, the check code is also reset once. If an abnormal status which the check code appears after Start/Stop button of the remote controller has been pushed continues, the check code is displayed again on the remote controller.</p>	<ul style="list-style-type: none"> • Judgment of outdoor unit • Exchange of cooling-only unit • Exchange of standard model with the flex model 																					
2	Operation select	<p>(1) Based upon the operation select command from the remote controller or central controller, the operation mode is selected.</p> <table border="1"> <thead> <tr> <th>Remote controller command</th> <th>Control outline</th> </tr> </thead> <tbody> <tr> <td>STOP</td> <td>Stops air conditioner.</td> </tr> <tr> <td>FAN</td> <td>Fan operation</td> </tr> <tr> <td>COOL</td> <td>Cooling operation</td> </tr> <tr> <td>DRY</td> <td>Dry operation</td> </tr> <tr> <td>HEAT</td> <td>Heating operation</td> </tr> <tr> <td>AUTO</td> <td>Cooling or HEAT operation mode is automatically selected by Ta and Ts and the unit starts operation.</td> </tr> </tbody> </table> <p>(2) Operation command permission mode Neither AUTO mode of the standard model nor HEAT mode of Cooling-only model can be selected. When a wireless remote control is used, the mode is notified by the receiving sound Pi, Pi (Twice) and alternative flashing of "☺" and "☹". To release the alternative flashing, change the mode on the wireless remote controller.</p>	Remote controller command	Control outline	STOP	Stops air conditioner.	FAN	Fan operation	COOL	Cooling operation	DRY	Dry operation	HEAT	Heating operation	AUTO	Cooling or HEAT operation mode is automatically selected by Ta and Ts and the unit starts operation.								
Remote controller command	Control outline																							
STOP	Stops air conditioner.																							
FAN	Fan operation																							
COOL	Cooling operation																							
DRY	Dry operation																							
HEAT	Heating operation																							
AUTO	Cooling or HEAT operation mode is automatically selected by Ta and Ts and the unit starts operation.																							
3	Room temp. control	<p>(1) Adjustment range Set temperature on remote controller (°C)</p> <table border="1"> <thead> <tr> <th></th> <th>In cooling/drying</th> <th>In heating</th> </tr> </thead> <tbody> <tr> <td>Wired type</td> <td>18 to 29°C</td> <td>18 to 29°C</td> </tr> <tr> <td>Wireless type</td> <td>17 to 30°C</td> <td>17 to 30°C</td> </tr> </tbody> </table> <p>(2) From the item code 06, the setup temperature in heating operation can be corrected.</p> <table border="1"> <thead> <tr> <th>Setup data</th> <th>0</th> <th>2</th> <th>4</th> <th>6</th> </tr> </thead> <tbody> <tr> <td>Setup temp. correction</td> <td>+0°C</td> <td>+2°C</td> <td>+4°C</td> <td>+6°C</td> </tr> </tbody> </table> <p>Setup at shipment</p> <table border="1"> <tbody> <tr> <td>Setup data</td> <td>2</td> </tr> </tbody> </table>		In cooling/drying	In heating	Wired type	18 to 29°C	18 to 29°C	Wireless type	17 to 30°C	17 to 30°C	Setup data	0	2	4	6	Setup temp. correction	+0°C	+2°C	+4°C	+6°C	Setup data	2	Heating suction temperature shift
	In cooling/drying	In heating																						
Wired type	18 to 29°C	18 to 29°C																						
Wireless type	17 to 30°C	17 to 30°C																						
Setup data	0	2	4	6																				
Setup temp. correction	+0°C	+2°C	+4°C	+6°C																				
Setup data	2																							
4	Automatic capacity control	(1) Based upon difference between Ta and Ts, the operation frequency of the outdoor unit varies.	Ta: Room temperature Ts: Setup temperature																					
5	Air volume control	<p>(1) By the command from the remote controller, "HIGH (HH)", "MED (H)", or "LOW (L)" "AUTO" operation is executed. For the wireless remote controller type, "HH", "H+", "H", "L+", "L", or "AUTO" operation is executed.</p> <p>(2) While air speed is in AUTO mode, the air speed is changed according to the difference between Ta and Ts.</p>	HH > H+ > H > L+ > L > LL																					

No.	Item	Outline of specifications	Remarks															
6	Prevention of cold air discharge	<p>(1) In heating operation, the upper limit of the fan tap is set by one with higher temperature of TC2 sensor and TCJ sensor.</p> <ul style="list-style-type: none"> When B zone has continued for 6 minutes, the operation shifts to C zone. In defrost time, the control point is set to +6°C.  <p>A zone: OFF B zone: Over 30°C, below 32°C, UL C zone: Over 32°C, below 24°C, L D zone: Over 24°C, below 36°C, H E zone: HH</p>	<ul style="list-style-type: none"> In D and E zones, priority is given to remote controller air speed setup. In A and B zones, "⊗" is displayed. 															
7	Freeze prevention control (Low temp. release)	<p>(1) In cooling operation, the air conditioner operates as described below based upon temp. detected by TC1, TC2 and TCJ sensors.</p> <p>To prevent the heat exchanger from freezing, the operation stops.</p> <ul style="list-style-type: none"> When "J" zone is detected for 5 minutes, the forced thermo is OFF. In "K" zone, the timer count is interrupted, and held. When "I" zone is detected, the timer is cleared and the operation returns to the normal operation. When the forced thermo-OFF became S0 with continuation of "J" zone, operation of the the indoor fan in LOW (L) mode until it reaches the "I" zone. <p>It is reset when the following conditions are satisfied.</p> <p>Reset conditions</p> <ol style="list-style-type: none"> TC1 ≥ 12°C and TC2 ≥ 12°C and TCJ ≥ 12°C 20 minutes passed after stop.  <table border="1" data-bbox="766 1299 1085 1433"> <thead> <tr> <th></th> <th>TC1</th> <th>TC2, TCJ</th> </tr> </thead> <tbody> <tr> <td>P1</td> <td>10°C (5°C)</td> <td>10°C</td> </tr> <tr> <td>Q1</td> <td>0°C</td> <td>-14°C</td> </tr> </tbody> </table> <p>(2) In cooling operation, the air conditioner operates as described below based upon temp. detected by TC2 and TCJ sensors.</p> <ul style="list-style-type: none"> When "M" zone is detected for 45 minutes, the forced thermo is OFF. In "N" zone, the timer count is interrupted and held. When shifting to "M" zone again, the timer count restarts and continues. If "L" zone is detected, the timer is cleared and the operation returns to normal operation. <p>Reset conditions</p> <ol style="list-style-type: none"> TC1 ≥ 12°C and TC2 ≥ 12°C and TCJ ≥ 12°C 20 minutes passed after stop.  <table border="1" data-bbox="853 1915 1085 2049"> <thead> <tr> <th></th> <th>TC2, TCJ</th> </tr> </thead> <tbody> <tr> <td>P2</td> <td>5°C</td> </tr> <tr> <td>Q2</td> <td>-2.0°C</td> </tr> </tbody> </table>		TC1	TC2, TCJ	P1	10°C (5°C)	10°C	Q1	0°C	-14°C		TC2, TCJ	P2	5°C	Q2	-2.0°C	
	TC1	TC2, TCJ																
P1	10°C (5°C)	10°C																
Q1	0°C	-14°C																
	TC2, TCJ																	
P2	5°C																	
Q2	-2.0°C																	

No.	Item	Outline of specifications	Remarks
8	Recovery control for cooling refrigerant and oil	(1) The indoor unit which stops operation, thermostat is OFF, or operates in FAN mode opens PMV of the indoor unit by the specified opening degree when signal of refrigerant recovery or oil recovery is received. (2) The indoor fan operates for approx. 1 minute during controlling the recovery or after recovery control has finished.	<ul style="list-style-type: none"> Recovery operation is usually executed every 2 hours.
9	Recovery control for heating refrigerant and oil	The indoor unit which stops operation, thermostat is OFF, or operates in FAN mode performs the following controls when signal of refrigerant recovery or oil recovery is received. (1) Opens PMV of the indoor unit by the specified opening degree. (2) Stops the fan.	<ul style="list-style-type: none"> In the indoor unit which cooling thermostat is OFF, or operates in FAN mode, "⏻" lamp goes on. Recovery operation is usually executed every 1 hour.
10	Short intermittent operation compensation control	(1) For 5 minutes after the operation has started, the operation is continued even if entering thermostat-OFF condition. (2) However, Cooling/Heating exchange and the system protective control precede and thermostat is OFF.	
11	Elimination of remaining heat	(1) When the air conditioner stops in the "HEAT" mode, drive the indoor fan with "LOW" mode for approx. 30 seconds.	
12	Flap control	(1) Flap position setup (Wired type) <ul style="list-style-type: none"> The flap position can be set up in the following operation range. <p style="text-align: center;">In cooling/dry operation In heating/fan operation</p> <div style="display: flex; justify-content: space-around; align-items: center;">   </div> <ul style="list-style-type: none"> In group operation, the flap positions can be set up collectively or individually. (2) Swing setup <ul style="list-style-type: none"> The swinging position can be moved in the following operation range. <p style="text-align: center;">All modes</p> <div style="text-align: center;">  </div> <ul style="list-style-type: none"> In group operation, the swinging positions can be set up collectively or individually. (3) Fix set up (Wireless type) Keep pressing or pressing briefly the FIX button to move the flap in the desired direction. Operating angle of flap will be different during cooling, dry and heating operation. (4) When the unit stops, the flap automatically closes. (5) While the heating operation is ready, the flap automatically moves upward.	
13	Filter sign display (None in wireless type) * Provided in the separately laid type TCB-AX21E.	(1) The operation time of the indoor fan is integrated and stored in memory, and the filter exchange signal is sent to the remote controller to display on the remote controller LCD after the specified time. (150H) (2) When the filter reset signal is received from the remote controller, time of the integrated timer is cleared. In this time, if the specified time has passed, the measured time is reset and LCD display disappears.	

No.	Item	Outline of specifications	Remarks
14	 and  display (Operation and heating stand-by)	<p><Operation standby> Display on wired type</p> <p>(1)</p> <ul style="list-style-type: none"> • “P05” is one of displays of power wire missing and when it’s detected. • “COOL/DRY” operation cannot be performed because the other indoor unit is under “HEAT” operation. • “HEAT” operation cannot be performed because COOL priority is set (Outdoor I/F P.C. board SW11 bit 1 is ON) and the other indoor unit is under “COOL/DRY” operation. • “FAN” operation cannot be performed because the system performs “Heat oil/Refrigerant recovery” operation. • There is a unit in which indoor overflow “P10” is detected. • There is a unit in which interlock alarm “P23” is detected. <p>(2) The above indoor units unavailable to operate waits under condition of thermostat OFF.</p> <p><HEAT standby> Display on remote controller</p> <p>(1)</p> <ul style="list-style-type: none"> • HEAT thermostat is OFF. • During HEAT operation, the fan rotates with lower air speed than one specified in order to prevent discharge of cold draft or stops. (including case that defrost operation is being performed) • “HEAT” operation cannot be performed because COOL priority is set (Outdoor I/F P.C. board SW11 bit 1 is ON) and the other indoor unit is under “COOL/DRY” operation. <p>(2) “HEAT standby” is displayed until the above conditions are released.</p>	<ul style="list-style-type: none"> •  goes on. • Not displayed on the wired type. •  goes on.
15	Selection of central control mode	<p>(1) The contents which can be changed on the remote controller at indoor unit side can be selected by setup at the central controller side.</p> <p>(2) In case of operation from TCC-LINK central controller (TCB-SC642TLE, etc.)</p> <p>[Central control mode 1] : Cannot operate</p> <p>[Central control mode 2] : Cannot operate, stop, select mode, set up temp.</p> <p>[Central control mode 3] : Cannot select mode, set up temp.</p> <p>[Central control mode 4] : Cannot select mode</p>	<p>Display at RBC-AMT21E (wired remote controller) side</p> <ul style="list-style-type: none"> • While mode is the central control mode,  “CENTRAL” lights on the display part of the remote controller. <p>Display at Wireless type side</p> <ul style="list-style-type: none"> • While the central control mode is set up, the contents possible to be operated are same though the display lamp does not change. An operation executed from the wireless remote controller in Central control mode is notified by the receiving sounds Pi, Pi, Pi, Pi, Pi (Five times).

No.	Item	Outline of specifications	Remarks
16	Hi POWER operation (Wireless remote control specific operations)	<p>When you press the Hi POWER button during cooling, heating or A operation, the air conditioner will start the following operation.</p> <ul style="list-style-type: none"> • Cooling operation Performs the cooling operation at 1°C lower than the setting temperature. Only when the fan speed before the Hi POWER operation is not high, the fan speed will be increased. • Heating operation Performs the heating operation at 2°C higher than the setting temperature. Only when the fan speed before the Hi POWER operation is not high, the fan speed will be increased. 	
17	ECO timer operation (Wireless remote control specific operations)	<p>When you press the ECO button during cooling, heating or A operation, the air conditioner will start the following operation.</p> <p>The fan speed display will indicate AUTO and low speed will be used.</p> <ul style="list-style-type: none"> • Cooling operation In the operation suppression zone, where capacity is kept to the minimum, overcooling is prevented by raising the temperature setting by 1°C after 1 hour and by 2°C after 2 hours of operation. The room temperature is thus regulated between the operation suppression zone and the set temperature. • Heating operation In the operation suppression zone, where capacity is kept to the minimum, overheating is prevented by lowering the temperature setting by 1°C after 1 hour and by 2°C after 2 hours of operation. The room temperature is thus regulated between the set temperature and the operation suppression zone. <div style="text-align: center;"> </div>	

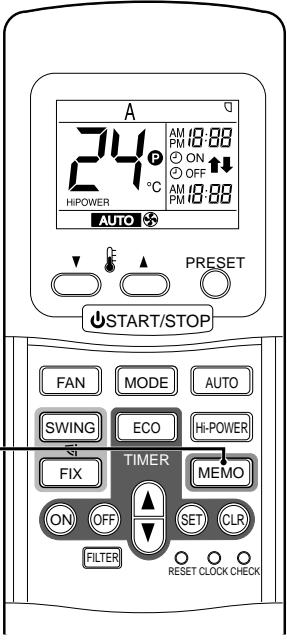
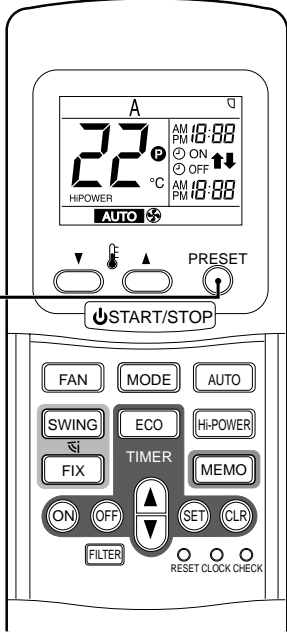
No.	Item	Outline of specifications	Remarks
18	MEMORY operation	<p>Start the air conditioner in the operation mode which you want the remote control to memorize.</p> <p>(1) Press this button briefly to standby memorizing the setting. All the icons currently displayed except for the clock display and mark flashes.</p> <p>(2) Press and hold the MEMO button for more than 3 seconds while the display flashes. The mark is indicated and the setting is memorized.</p> <ul style="list-style-type: none"> • If you do not press the MEMO button within 3 seconds or if you press another button, the MEMORY setting is cancelled. • Operation modes which can be memorized with the MEMO button are MODE, Temperature, FAN, TIMER and Hi POWER. 	 <p>(1) (2)</p>
19	PRESET operation	<p>To operate the air conditioner with the setting memorized by the MEMO button.</p> <p>(1) Press the PRESET button. The setting memorized with the MEMO button will be indicated and the air conditioner operates with regards to the setting.</p> <ul style="list-style-type: none"> • The lamp (green) on the display panel of the indoor unit goes on, and operation starts after approximately 3 minutes. • Initial setting: MODE : AUTO Temperature : 22 	 <p>(1)</p>

6. APPLIED CONTROL

6-1. Indoor Unit

6-1-1. Setup of Selecting Function in Indoor Unit (Be sure to Execute Setup by a Wired Remote Controller)

<Procedure> Execute the setup operation while the unit stops.

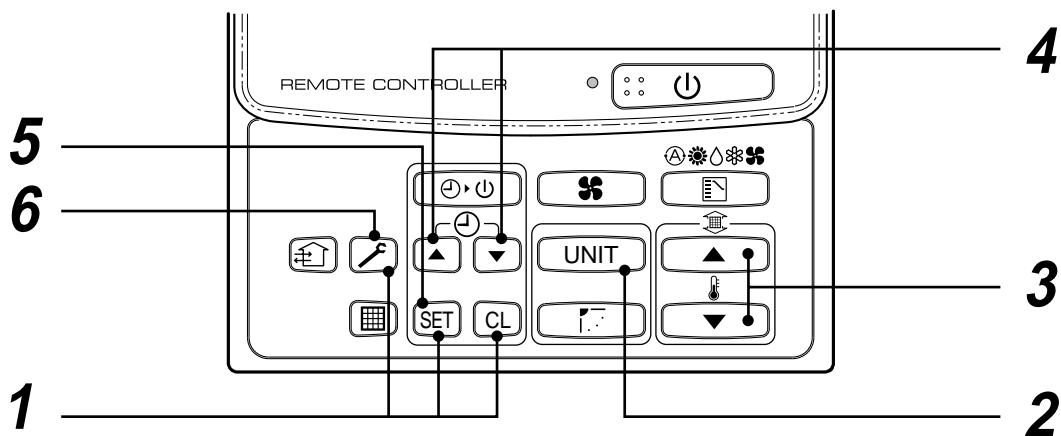

- 1** Push **SET**, **CL**, and **fan** buttons simultaneously for 4 seconds or more.
The firstly displayed unit No. indicates the header indoor unit address in the group control.
In this time, the fan of the selected indoor unit is turned on.
- 2** Every pushing **UNIT** button, the indoor unit numbers in the group control are successively displayed. In this time, the fan of the selected indoor unit only is turned on.
- 3** Specify the item code (DN) using the setup temperature **▲** and **▼** buttons.
- 4** Select the setup data using the timer time **▲** and **▼** buttons.
(When selecting the DN code to “33”, change the temperature indication of the unit from “°C” to “°F” on the remote controller.)
- 5** Push **SET** button. (OK if display goes on.)
 - To change the selected indoor unit, return to procedure **2**.
 - To change the item to be set up, return to procedure **3**.
- 6** Pushing **fan** button returns the status to normal stop status.

Table: Function selecting item numbers (DN)
(Items necessary to perform the applied control at the local site are described.)

DN	Item	Description	At shipment
01	Filter sign lighting time	0000 : None 0002 : 2500H 0004 : 10000H 0001 : 150H 0003 : 5000H	0001 : 150H
02	Dirty state of filter	0000 : Standard 0001 : High degree of dirt (Half of standard time)	0000 : Standard
03	Central control address	0001 : No.1 unit to 0064 : No.64 unit 0099 : Unfixed	0099 : Unfixed
04	Specific indoor unit priority	0000 : No priority 0001 : Priority	0000 : No priority
06	Heating temp shift	0000 : No shift 0002 : +2°C to 0001 : +1°C 0010 : +10°C (Up to +6 recommended)	0002 : +2°C
0d	Existence of automatic cool/heat mode	0000 : Provided 0001 : Not provided (Automatic selection from connected outdoor unit)	0001 : Not provided
0F	Cooling only	0000 : Heat pump 0001 : Cooling only (No display of [AUTO] [HEAT])	0000 : Heat pump
10	Type	0000 : (1-way air discharge cassette) 0001 : (4-way air discharge cassette) to 0037 0008 : High Wall	0008 : High Wall
11	Indoor unit capacity	0000 : Unfixed 0001 to 0034	According to capacity type
12	Line address	0001 : No.1 unit to 0030 : No.30 unit	0099 : Unfixed
13	Indoor unit address	0001 : No.1 unit to 0064 : No.64 unit	0099 : Unfixed
14	Group address	0000 : Individual 0001 : Header unit of group 0002 : Follower unit of group	0099 : Unfixed
1E	Temp difference of automatic cooling/heating mode selection COOL → HEAT, HEAT → COOL	0000 : 0 deg to 0010 : 10 deg (For setup temperature, reversal of COOL/HEAT by ± (Data value)/2)	0003 : 3 deg (Ts±1.5)
28	Automatic restart of power failure	0000 : None 0001 : Reset	0000 : None
2A	Selection of option/error input (CN80)	0000 : Filter input 0001 : Alarm input (Air washer, etc.) 0002 : Outside error input	0002 : Outside error input (Interlock)
2E	HA terminal (CN61) select	0000 : Usual 0001 : Leaving-ON prevention control	0000 : Usual (HA terminal)
32	TA sensor selection	0000 : Body TA sensor 0001 : Remote controller sensor	0000 : Body TA sensor
33	Temperature unit select	0000 : °C (at factory shipment) 0001 : °F	0000 : °C
60	Timer set (Wired remote controller)	0000 : Available (Operable) 0001 : Unavailable (Operation prohibited)	0000 : Available
69	Flap selection of cooling	0000 : Standard 0001 : Permission of blowing downward	0000 : Standard

TYPE

Item code [10]

Setup data	Type	Abbreviated Model name
0008	High Wall	MMK-AP XXX H

Indoor unit capacity

Item code [11]

Setup data	Model
0001	007
0003	009
0005	012

6-1-2. Applied Control in Indoor Unit

■ **Remote location ON/OFF control box (TCB-IFCB-4E)**

[Wiring and setup]

- Use the exclusive connector for connection with the indoor control P.C. board.
- In a group control, the system can operate when connecting with any indoor unit (Control P.C. board) in the group. However when taking out the operation/error signal from the other unit, it is necessary to take out from each unit individually.

(1) Control items

- 1) Start/Stop input signal : Operation start/stop in unit
- 2) Operation signal : Output during normal operation
- 3) Error signal : Output during alarm
(Serial communication error or indoor/outdoor protective device) operation

(2) Wiring diagram using remote control interface (TCB-IFCB-4E)

Input IFCB-4E : No voltage ON/OFF serial signal
 Output No voltage contact for operation, error display
 Contact capacity: Below Max. AC240V 0.5A

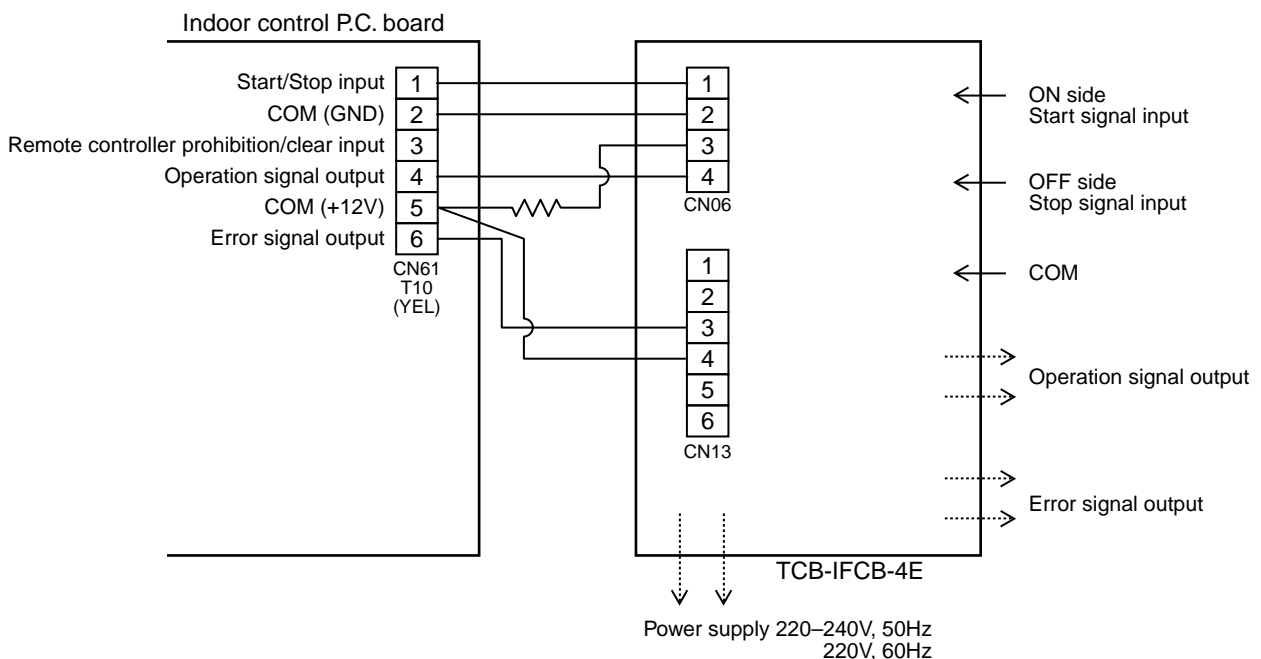

■ **Ventilating fan control from remote controller**

[Function]

- The start/stop operation can be operated from the wired remote controller when air to air heat exchanger or ventilating fan is installed in the system.
- The fan can be operated even if the indoor unit is not operating.
- Use a fan which can receive the no-voltage A contact as an outside input signal.
- In a group control, the units are collectively operated and they can not be individually operated.

(1) Operation

Handle a wired remote controller in the following procedure.

- * Use the wired remote controller during stop of the system.
- * Be sure to set up the wired remote controller to the header unit. (Same in group control)
- * In a group control, if the wired remote controller is set up to the header unit, both header and follower units are simultaneously operable.

1 Push concurrently [SET] + [CL] + [Fan] buttons for 4 seconds or more.

The unit No. displayed firstly indicates the header indoor unit address in the group control.

In this time, the fan of the selected indoor unit turns on.

2 Every pushing [UNIT] button, the indoor unit numbers in group control are displayed successively.

In this time, the fan of the selected indoor unit only turns on.

3 Using the setup temp [▲] or [▼] button, specify the item code 31.

4 Using the timer time [▲] or [▼] button, select the setup data. (At shipment: 0000)

The setup data are as follows:

Setup data	Handling of operation of air to air heat exchanger or ventilating fan
0000	Unavailable (At shipment)
0001	Available

5 Push [SET] button. (OK if display goes on.)

- To change the selected indoor unit, go to the procedure **2**).
- To change the item to be set up, go to the procedure **3**).

6 Pushing [Fan] returns the status to the usual stop status.

(2) Wiring

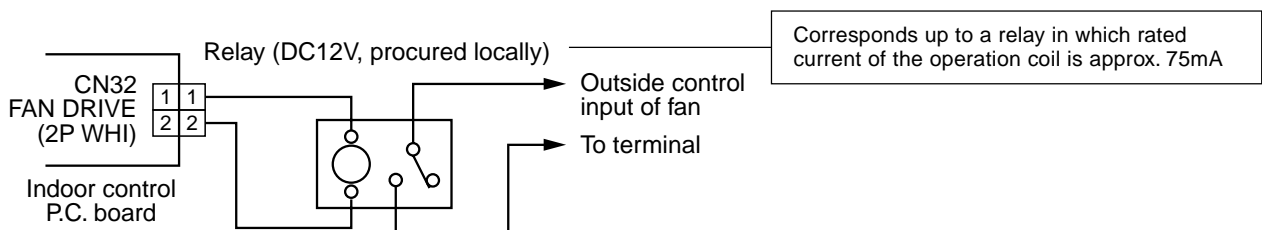

Note) Determine the cable length between the indoor control P.C. board and the relay within 2m.

■ Leaving-ON prevention control

[Function]

- This function controls the indoor units individually. It is connected with cable to the control P.C. board of the indoor unit.
- In a group control, it is connected with cable to the indoor unit (Control P.C. board), and the item code $\mathcal{Z}\mathcal{E}$ is set to the connected indoor unit.
- It is used when the start operation from outside if unnecessary but the stop operation is necessary.
- Using a card switch box, card lock, etc, the forgotten-OFF of the indoor unit can be protected.
 - When inserting a card, start/stop operation from the remote controller is allowed.
 - When taking out a card, the system stops if the indoor unit is operating and start/stop operation from the remote controller is forbidden.

(1) Control items

- 1) Outside contact ON : The start/stop operation from the remote controller is allowed.
(Status that card is inserted in the card switch box)
- 2) Outside contact OFF : If the indoor unit is operating, it is stopped forcedly.
(Start/Stop prohibited to remote controller)
(Status that card is taken out from the card switch box)

* When the card switch box does not perform the above contact operation, convert it using a relay with b contact.

(2) Operation

Handle the wired remote controller switch in the following procedure.

* Use the wired remote controller switch during stop of the system.

- 1 Push concurrently **SET** + **CL** + **⚡** buttons for 4 seconds or more.
- 2 Using the setup temp **▲** or **▼** button, specify the item code $\mathcal{Z}\mathcal{E}$.
- 3 Using the timer time **▲** or **▼** button, set 0001 to the setup data.
- 4 Push **SET** button.
- 5 Push **⚡** button. (The status returns to the usual stop status.)

(3) Wiring

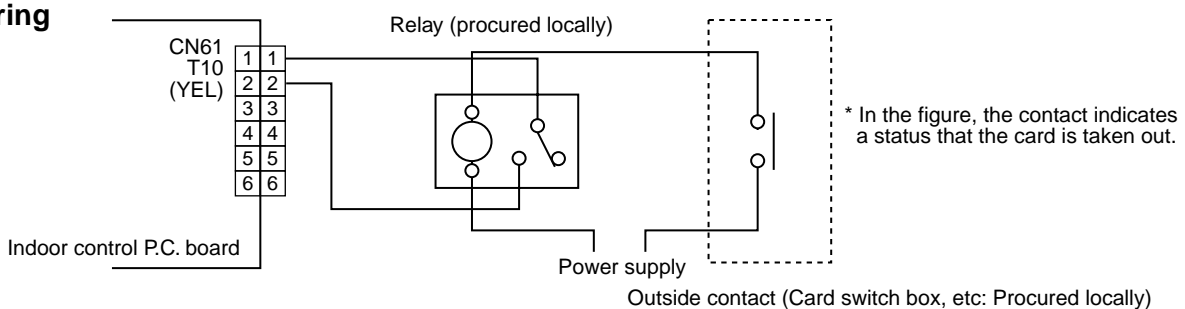

Note) Determine the cable length between the indoor control P.C. board and the relay within 2m.

■ Power peak-cut from indoor unit

When the relay is turned on, a forced thermostat-OFF operation starts.

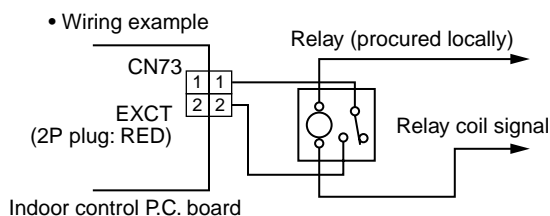

Note) Determine the cable length between the indoor or outdoor control P.C. board and the relay within 2m.

■ Indoor P.C. Board

MCC-1510

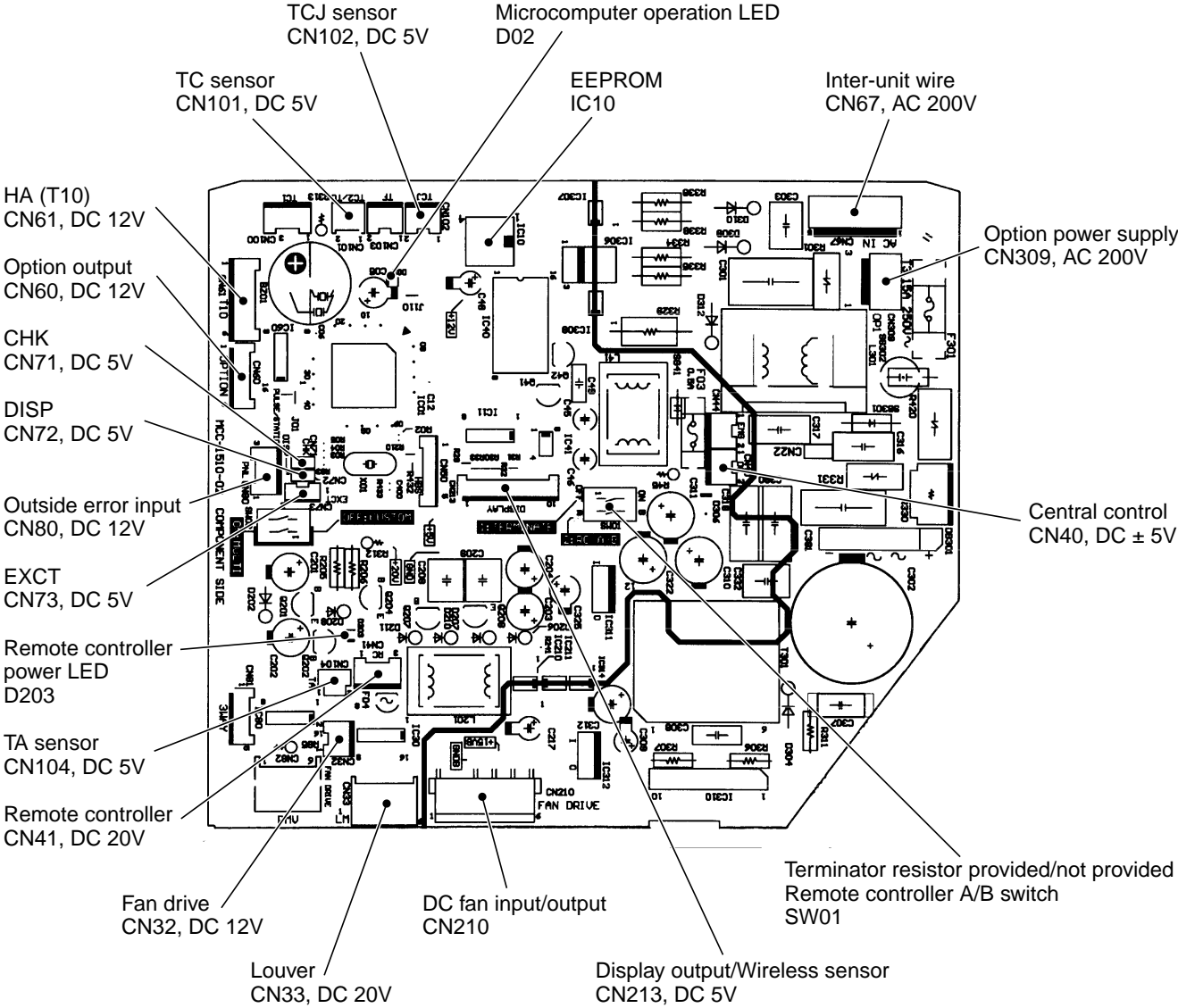

Wall-Type P.C. Board Optional Switch/Connector Specifications

Function	Connector No.	Pin No.	Specifications	Remarks
Terminator resistor provided/Not provided Remote controller A/B	SW01	Bit 1	OFF: No terminator resistor, ON: Terminator resistor provided	Setup at shipment OFF: No terminator resistor. Only 1 unit is ON during central control by custom only.
		Bit 2	OFF: Remote controller A ON: Remote controller B	Setup at shipment OFF: Remote controller A
Fan output	CN32	1	DC12V	Setup at shipment: Linked operation of ON with operation of indoor unit and OFF with stop
		2	Output	* The setup of single operation by FAN button on remote controller is executed from remote controller. (DN = 31)
HA	CN61	1	Start/Stop input	HA Start/Stop input (J01: Provided/Not provided = Pulse (At shipment from factory)/Static input switch)
		2	0V (COM)	
		3	Handy prohibition input	Operation stop of handy remote controller is permitted / prohibited by input.
		4	Operation output	ON during operation (Answer back of HA)
		5	DC12V (COM)	
		6	Alarm output	ON during output of alarm
Optional output	CN60	1	DC12V (COM)	
		2	Defrost output	ON during defrosting of outdoor unit
		3	Thermo-ON output	ON when Real thermo. ON (Comp. ON)
		4	Cooling output	ON when operation mode is cooling line (Cool, Dry, Cooling/Heating AUTO cooling)
		5	Heating output	ON when operation mode is heating line (Heat, Cooling/Heating AUTO heating)
		6	Fan output	ON when indoor fan is ON
Outside error input	CN80	1	DC12V (COM)	At shipment from factory, the error code "L30" generates and optional error input to stop operation forcedly (DN:2A = 1) is controlled (Display of protection for devices attached to outside) by setup of outside error input (DN:2A = 2) for 1 minute. * Optional error input control is set up on the remote controller.
		2	DC12V (COM)	
		3	Filter/Option/Outside error input	
CHK Operation check	CN71	1	Check mode input	This check is used for operation check of indoor unit. (The specified operation such as indoor fan "H", drain pump ON, etc. is executed without communication with outdoor unit or remote controller.)
		2	0V	
DISP Display mode	CN72	1	Display mode input	Display mode, communication is enabled by indoor unit and remote controller only. (When power supply is turned on.) Timer short (Usual)
		2	0V	
EXCT Demand	CN73	1	Demand input	Indoor unit forced thermo-OFF operation
		2	0V	

7. TROUBLESHOOTING

7-1. Troubleshooting Summary

1. Before troubleshooting

1) Applied models

All Super Module Multi-system type models

(Indoor unit: MMX-APXXX, Outdoor unit: MMY-MAPXXX)

2) Required tools / measuring devices

- Screwdrivers (Philips, Minus), spanner, radio pinchers, nipper, push pin for reset switch, etc.
- Tester, thermometer, pressure gauge, etc.

3) Confirmation before check (The following items are not troubles.)

No.	Operation	Check items
1	Compressor does not operate.	<ul style="list-style-type: none"> • Is not delayed for 3 minutes? (3 minutes after compressor-OFF) • Is not thermostat OFF? • Is not the fan operating or timer? • Is not the system initially communicating?
2	Indoor fan does not work.	<ul style="list-style-type: none"> • Is not the cold draft prevention being controlled in heating operation?
3	Outdoor fan does not rotate, or fan speed changes.	<ul style="list-style-type: none"> • Is not low cooling operation being controlled? • Is not a defrost operation being performed?
4	Indoor fan does not stop.	<ul style="list-style-type: none"> • Is not after-heat elimination operation being controlled after heating operation?
5	Start/stop operation on remote controller is unavailable.	<ul style="list-style-type: none"> • Is not auxiliary unit or remote control being operated?
6	—	<ul style="list-style-type: none"> • Is connecting wire of indoor unit or remote controller correct?

2. Troubleshooting procedure

When a trouble occurred, advance the check operation in the following procedure.

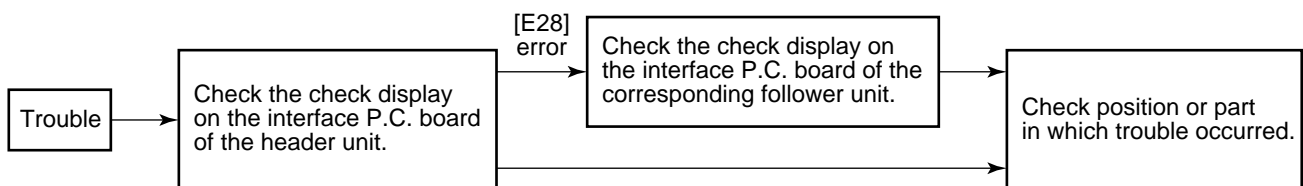

NOTE) While a check operation is performed, a malfunction of the microprocessor may be caused due to condition of the power supply or the external noise. If there is any noise source, change wires of the remote controller and signal wires to shield wires.

7-2. Check Method

On the remote controller (Main remote controller, Central control remote controller) and the interface P.C. board of the outdoor unit, a check display LCD (Remote controller) or 7-segment display (on the outdoor interface P.C. board) to display the operation is provided. Therefore the operation status can be known. Using this self-diagnosis function, a trouble or position with trouble of the air conditioner can be found as shown in the table below.

7-2-1. Check Code List

The following list shows each check code. Find the check contents from the list according to part to be checked.

- In case of check from indoor remote controller: See “Main remote controller display” in the list.
- In case of check from outdoor unit: See “Outdoor 7-segment display” in the list.
- In case of check from AI-NET central control remote controller: See “AI-NET central control display” in the list.
- However connection with AI-NET central control is disabled for the wall type (2 series).
- In case of check from indoor unit with wireless remote controller: See “Sensor block display of receiving unit” in the list.

IPDU: Intelligent Power Drive Unit

○ : Lighting, ☐ : Flashing, ● : Goes off

ALT.: Flashing is alternately when there are two flashing LED.

SIM: Simultaneous flashing when there are two flashing LED

Main remote controller display	Check code		AI-NET central control display	Wireless remote controller				Check code name	Judging device
	Outdoor 7-segment display			Sensor block display of receiving unit					
		Sub code		Ready ☐	Timer ⌚	Operation ⏻	Flash		
E01	—	—	—	●	●	☐		Communication error between indoor and remote controller (Detected at remote controller side)	Remote controller
E02	—	—	—	●	●	☐		Sending error of remote controller	Remote controller
E03	—	—	97	●	●	☐		Communication error between indoor and remote controller (Detected at indoor side)	Indoor
E04	—	—	04	☐	●	●		Communication circuit error between indoor and outdoor (Detected at indoor side)	Indoor
E06	E06	No. of indoor units in which sensor has been normally received	04	☐	●	●		Decrease of No. of indoor units	I/F
—	E07	—	—	☐	●	●		Communication circuit error of indoor and outdoor (Detected at outdoor side)	I/F
E08	E08	Duplicated indoor addresses	96	●	●	☐		Duplicated indoor addresses	Indoor / I/F
E09	—	—	99	●	●	☐		Duplicated master remote controllers	Remote controller
E12	E12	01: Indoor/Outdoor communication 02: Communication between outdoor units	42	●	●	☐		Automatic address start error	I/F
E15	E15	—	42	☐	●	●		No indoor automatic address	I/F
E16	E16	00: Capacity over 01: No. of connected units	89	☐	●	●		No. of connected indoor units / Capacity over	I/F
E18	—	—	97, 99	●	●	☐		Communication error between indoor header and follower units	Indoor
E19	E19	00: No header unit 02: Two or more header units	96	☐	●	●		Outdoor header units quantity error	I/F
E20	E20	01: Outdoor of other line connected 02: Indoor of other line connected	42	☐	●	●		Other line connected during automatic address	I/F
E23	E23	—	15	☐	●	●		Sending error in communication between outdoor units	I/F
E25	E25	—	15	☐	●	●		Duplicated follower outdoor addresses	I/F
E26	E26	No. of outdoor units which received signal normally	15	☐	●	●		Decrease of No. of connected outdoor units	I/F
E28	E28	Detected outdoor unit number	d2	☐	●	●		Follower outdoor error	I/F
E31	E31	01: IPDU1 error 02: IPDU2 error 03: IPDU1, 2 error 04: Fan IPDU error 05: IPDU + Fan IPDU error 06: IPDU2 + Fan IPDU error 07: All IPDU error	CF	☐	●	●		IPDU communication error	I/F

Main remote controller display	Check code			Wireless remote controller				Check code name	Judging device
	Outdoor 7-segment display		AI-NET central control display	Sensor block display of receiving unit					
		Sub code		Ready 	Timer 	Operation 	Flash		
F01	—	—	OF	●	☒	☒	ALT	Indoor TCJ sensor error	Indoor
F02	—	—	Od	●	☒	☒	ALT	Indoor TC2 sensor error	Indoor
F03	—	—	93	●	☒	☒	ALT	Indoor TC1 sensor error	Indoor
F04	F04	—	19	○	☒	☒	ALT	TD1 sensor error	I/F
F05	F05	—	A1	○	☒	☒	ALT	TD2 sensor error	I/F
F06	F06	—	18	○	☒	☒	ALT	TE1 sensor error	I/F
F07	F07	—	18	○	☒	☒	ALT	TL sensor error	I/F
F08	F08	—	1b	○	☒	☒	ALT	TO sensor error	I/F
F10	—	—	OC	●	☒	☒	ALT	Indoor TA sensor error	Indoor
F12	F12	—	A2	○	☒	☒	ALT	TS1 sensor error	I/F
F13	F13	01: Comp. 1 side 02: Comp. 2 side	43	○	☒	☒	ALT	TH sensor error	IPDU
F15	F15	—	18	○	☒	☒	ALT	Outdoor temp sensor misconnecting (TE, TL)	I/F
F16	F16	—	43	○	☒	☒	ALT	Outdoor pressure sensor misconnecting (Pd, Ps)	I/F
F23	F23	—	43	○	☒	☒	ALT	Ps sensor error	I/F
F24	F24	—	43	○	☒	☒	ALT	Pd sensor error	I/F
F29	—	—	12	●	☒	☒	SIM	Indoor other error	Indoor
F31	F31	—	1C	○	☒	☒	SIM	Outdoor EEPROM error	I/F
H01	H01	01: Comp. 1 side 02: Comp. 2 side	IF	●	☒	●		Compressor break down	IPDU
H02	H02	01: Comp. 1 side 02: Comp. 2 side	1d	●	☒	●		Magnet switch error Overcurrent relay operation Compressor error (lock)	MG-SW Overcurrent relay IPDU
H03	H03	01: Comp. 1 side 02: Comp. 2 side	17	●	☒	●		Current detect circuit system error	IPDU
H04	H04	—	44	●	☒	●		Comp 1 case thermo operation	I/F
H06	H06	—	20	●	☒	●		Low pressure protective operation	I/F
H07	H07	—	d7	●	☒	●		Oil level down detective protection	I/F
H08	H08	01: TK1 sensor error 02: TK2 sensor error 03: TK3 sensor error 04: TK4 sensor error	d4	●	☒	●		Oil level detective temp sensor error	I/F
H14	H14	—	44	●	☒	●		Comp 2 case thermo operation	I/F
H16	H16	01: TK1 oil circuit system error 02: TK2 oil circuit system error 03: TK3 oil circuit system error 04: TK4 oil circuit system error	d7	●	☒	●		Oil level detective circuit error Magnet switch error Overcurrent relay operation	I/F MG-SW Overcurrent relay
L03	L03	—	96	☒	●	☒	SIM	Duplicated indoor header units	Indoor
L04	L04	—	96	☒	○	☒	SIM	Duplicated outdoor line addresses	I/F
L05	L05	—	96	☒	●	☒	SIM	Duplicated indoor units with priority (Displayed on indoor unit with priority)	I/F
L06	L06	No. of indoor units with priority	96	☒	●	☒	SIM	Duplicated indoor units with priority (Displayed in unit other than indoor unit with priority)	I/F
L07	—	—	99	☒	●	☒	SIM	Group line in individual indoor unit	Indoor
L08	L08	—	99	☒	●	☒	SIM	Indoor group/Address unset	Indoor I/F
L09	—	—	46	☒	●	☒	SIM	Indoor capacity unset	Indoor
L10	L10	—	88	☒	○	☒	SIM	Outdoor capacity unset	I/F
L20	—	—	98	☒	○	☒	SIM	Duplicated central control addresses	AI-NET Indoor
L28	L28	—	46	☒	○	☒	SIM	Over No. of connected outdoor units	I/F
L29	L29	01: IPDU1 error 02: IPDU2 error 03: IPDU3 error 04: Fan IPDU error 05: IPDU1 + Fan IPDU error 06: IPDU2 + Fan IPDU error 07: All IPDU error	CF	☒	○	☒	SIM	No. of IPDU error	I/F
L30	L30	Detected indoor address	b6	☒	○	☒	SIM	Auxiliary interlock in indoor unit	Indoor
—	L31	—	—	—	—	—		IC error	I/F

Check code			Wireless remote controller				Check code name	Judging device	
Main remote controller display	Outdoor 7-segment display		AI-NET central control display	Sensor block display of receiving unit					
	Auxiliary code			Ready	Timer	Operation			Flash
P01	—	—	11	☒	☒	●	ALT	Indoor fan motor error	Indoor
P03	P03	—	1E	☒	●	☒	ALT	Discharge temp TD1 error	I/F
P04	P04	01: Comp. 1 side 02: Comp. 2 side	21	☒	●	☒	ALT	High-pressure SW detection error	IPDU
P05	P05	01: Phase-missing detection 02: Phase order error	AF	☒	●	☒	ALT	Phase-missing detection / Phase order error	I/F
P07	P07	01: Comp. 1 side 02: Comp. 2 side	1C	☒	●	☒	ALT	Heat sink overheat error	IPDU I/F
P12	—	—	11	☒	☒	●	ALT	Indoor fan motor error	Indoor
P13	P13	—	47	☒	☒	●	ALT	Outdoor liquid back detection error	I/F
P15	P15	01: TS condition 02: TD condition	AE	☒	●	☒	ALT	Gas leak detection	I/F
P17	P17	—	bb	☒	●	☒	ALT	Discharge temp TD2 error	I/F
P19	P19	Detected outdoor unit number	08	☒	●	☒	ALT	4-way valve inverse error	I/F
P20	P20	—	22	☒	●	☒	ALT	High-pressure protective operation	I/F
P22	P22	0 _ : IGBT short 1 _ : Fan motor position detective circuit error 3 _ : Fan motor trouble C _ : TH sensor temp. error (Heat sink overheat) D _ : TH sensor error E _ : Vdc output error	1A	☒	●	☒	ALT	Outdoor fan IPDU error	Fan IPDU
P26	P26	01: Comp. 1 side 02: Comp. 2 side	14	☒	●	☒	ALT	G-TR short protection error	IPDU
P29	P29	01: Comp. 1 side 02: Comp. 2 side	16	☒	●	☒	ALT	Comp position detective circuit system error	IPDU
P31	—	—	47	☒	●	☒	ALT	Other indoor unit error (Group follower unit error)	Indoor
—	—	—	b7	By alarm device			ALT	Error in indoor group	AI-NET
—	—	—	97	—			—	AI-NET communication system error	AI-NET
—	—	—	99	—			—	Duplicated network adaptors	AI-NET

Error detected by TCC-LINK central control device

Check code			Wireless remote controller				Check code name	Judging device	
Central control device indication	Outdoor 7-segment display		AI-NET central control display	Sensor block display of receiving unit					
	Auxiliary code			Ready	Timer	Operation			Flash
C05	—	—	—	—				Sending error in TCC-LINK central control device	TCC-LINK
C06	—	—	—	—				Receiving error in TCC-LINK central control device	TCC-LINK
C12	—	—	—	—				Batch alarm of general-purpose equipment control interface	HA control interface I/F
O30	Differs according to error contents of unit with occurrence of alarm						Group control follower unit error	TCC-LINK	
	—	—	(L20 is displayed.)			Duplicated central control addresses			

7-2-2. New Check Code

1. Difference between the TCC LINK and AI-NET check code

The displaying method of the check code changes in this model and after.

	AI-NET check code	TCC Link
Used characters	Hexadecimal notation, 2 digits	Alphabet + Decimal notation, 2 digits
Characteristics of code classification	Few classification of communication/incorrect setup system	Many classification of communication/incorrect setup system
Block display	Indoor P.C. board, Outdoor P.C. board, Cycle, Communication	Communication/Incorrect setup (4 ways), Indoor protection, Outdoor protection, Sensor, Compressor protection, etc.

< Display in wired remote controller >

- [△] goes on.
- [UNIT No.] + Check code + Operation lamp (Green) flash

<Display on sensor part in wireless remote controller>

- Block display of combination of [⏻] [⏪] [⏩] [⏹]

<Display on 7-segment in outdoor unit>

- Unit No. and check code are displayed.
- In a case of error with auxiliary code, the check code and the auxiliary code are displayed alternately.

Display	Classification
A	Unused
C	Central control system error
E	Communication system error
F	Each sensor error (Failure)
H	Compressor protective system error
J	Unused
L	Setup error, Other errors
P	Protective device operation

7-3. Troubleshooting by Check Display on Remote Controller

7-3-1. In Case of Main Remote Controller (RBC-AMT21E)

1. Confirmation and check

When a trouble occurred on the air conditioner, the check code and the indoor unit No. are displayed on the display section of the remote controller.

The check code is displayed while the air conditioner operates.

If the display disappeared, operate the air conditioner and check the error based upon the following "Confirmation of error history".

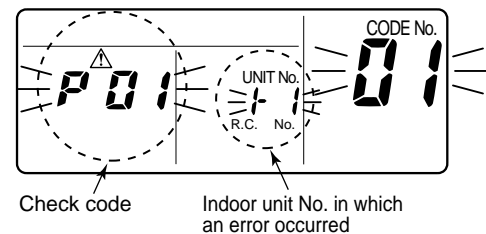

Check code Indoor unit No. in which an error occurred

2. Confirmation of error history

When a trouble occurred on the air conditioner, the error history can be confirmed with the following procedure. (Up to 4 error histories are stored in memory.)

This history can be confirmed from either operating status or stop status.

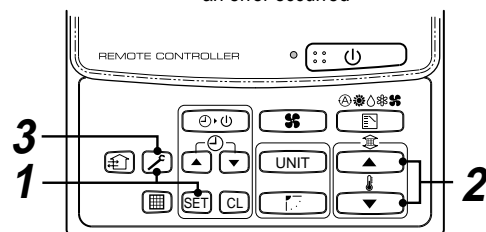

Procedure	Description
1	<p>When pushing [SET] and [⏻] buttons simultaneously for 4 seconds or more, the below display appears. If [Service Check] is displayed, the mode enters in the error history mode.</p> <ul style="list-style-type: none"> • [01: Error history order] is displayed in code number window. • [Check Code] is displayed in check code window. • [Indoor unit address with error] is displayed in UNIT No.
2	<p>Every pushing temp. set [▲] / [▼] buttons, the error histories stored in the memory are displayed in order. The numbers in item code indicates item code [01] (Latest) to [04] (Oldest).</p> <p>CAUTION Do not push [CL] button because all the error histories of the indoor unit will be deleted.</p>
3	<p>After confirmation, push [⏻] button to return to the usual display.</p>

7-3-2. In Case of TCC-LINK Central Control Remote Controller (TCB-SC642TLE)

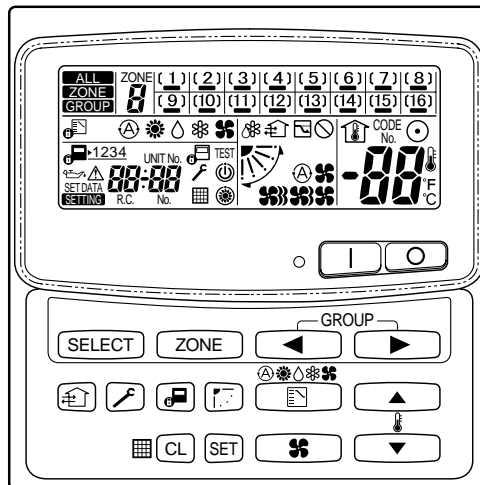

1. Confirmation and check

When a trouble occurred on the air conditioner, the check code and the indoor unit No. are displayed on the display section of the remote controller.

The check code is displayed while the air conditioner operates.

If the display disappeared, operate the air conditioner and check the error based upon the following "Confirmation of error history".

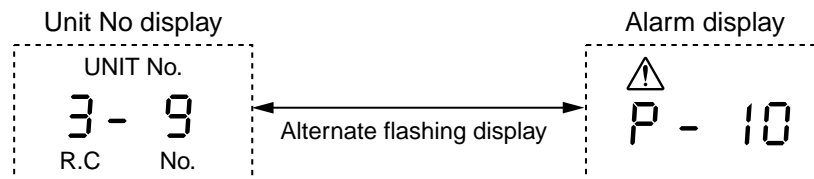

2. Confirmation of error history

When a trouble occurred on the air conditioner, the error history can be confirmed with the following procedure. (Up to 4 error histories are stored in memory.)

This history can be confirmed from either operating or stop.

- 1) Push and buttons in succession for 4 seconds or more.
- 2) SERVICE CHECK goes on and Item code 01 goes on.
- 3) When selecting (flash) the group number if there is the alarm history, the UNIT number and the latest alarm history are displayed alternately.
* In this time, the temperature cannot be set up.
- 4) To confirm the alarm history other than the latest one, push temp. set / to select Item code (01 to 04).
- 5) To confirm the alarm in the other group, push and / to select the group number
Do not push button because all the alarm histories of the currently selected group are deleted.
- 6) To finish the service check, push button.

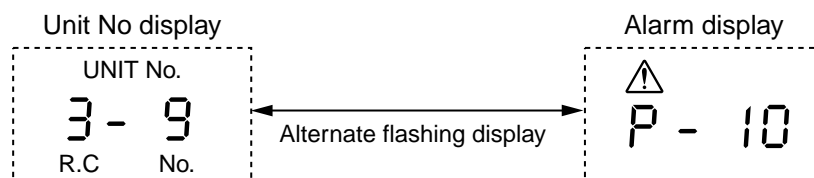

7-4. Check Code and Check Position Displayed on the Remote Controller and Outdoor Unit (7-Segment Display of Interface)

Main remote controller	Check code			Detected position	Check code name	Status	Error detection condition	Check item (position)
	Outdoor 7-segment display		AI-NET central control remote controller					
	Check code	Sub-code						
E01	—	—	—	Remote controller	Communication error between indoor and remote controller (Detected at remote controller side)	Corresponding unit only stops.	Communication interrupted between indoor P.C. board and remote controller.	<ul style="list-style-type: none"> Check remote controller inter-unit wire (A/B). Check disconnection, connector contact error. Check indoor power supply. Check indoor P.C. board error. Check remote controller address setup. (When two remote controllers operate) Check remote controller P.C. board.
E02	—	—	—	Remote controller	Remote controller sending error	Corresponding unit only stops.	Signal could not be sent from remote controller to indoor unit.	<ul style="list-style-type: none"> Check the communication wire of remote controller: Exchange remote controller.
E03	—	—	97	Indoor unit	Communication error between indoor and remote controller (Detected at indoor side)	Corresponding unit only stops.	No communication from remote controller (including wireless) and communication adaptor.	<ul style="list-style-type: none"> Check remote controller and communication adaptor wiring.
E04	—	—	4	Indoor unit	Indoor/outdoor communication circuit error (Detected at indoor side)	Corresponding unit only stops.	Indoor unit does not receive communication from outdoor unit.	<ul style="list-style-type: none"> Check power-ON order of indoor/outdoor. Check indoor address setup. Check inter-unit wiring between indoor and outdoor. Check outdoor end terminal resistance setup (SW30-2). Check SW02 setup on the wall type P.C. board. (Should be Bit 1: ON, Bit 2: OFF)
E06	E06	No. of indoor units which received signal normally	4	I/F	Decreased number of indoor units	All stop	When signal is not sent for a certain period from the indoor unit which has been used to send signals, [E06] is normally displayed.	<ul style="list-style-type: none"> Check the power supply of indoor unit. (Power-ON) Check connection of communication line between indoor and outdoor. Check connector connection for communication in indoor P.C. board. Check connector connection for communication in outdoor P.C. board. Check indoor P.C. board failure. Check outdoor P.C. board (I/F) failure.
—	E07	—	—	I/F	Indoor/outdoor communication circuit error (Detected at outdoor side)	All stop	Transmission from outdoor to indoor cannot continue for 30 seconds.	<ul style="list-style-type: none"> Check outdoor end terminal resistance setup (SW30-2). Check the communication connection between indoor and outdoor.
E08	E08	Duplicated indoor addresses	96	Indoor I/F	Duplicated indoor addresses	All stop	Multiple indoor unit address setup are duplicated.	<ul style="list-style-type: none"> Check indoor address. Check the change of remote controller connection (Group / Individual) after setup of indoor address. Check SW02 setup on the wall type P.C. board. (Should be Bit 1: ON, Bit 2: OFF)
E09	—	—	99	Remote controller	Duplicated master remote controllers	Corresponding unit only stops.	In 2-remote controller control (including wireless), both are setup as master (Header indoor unit stops and other indoor unit is operating.)	<ul style="list-style-type: none"> Check remote controller setup. Check remote controller P.C. board.

Main remote controller		Check code		Detected position	Check code name	Status	Error detection condition	Check item (position)
		Outdoor 7-segment display						
		Check code	Sub-code					
E12	E12	01: Indoor/outdoor communication 02: Between outdoors communication	—	I/F	Automatic address start error	All stop	<ul style="list-style-type: none"> When indoor automatic address started, other refrigerant circuit system was setting automatic address. When outdoor automatic address started, indoor automatic address was executed. 	<ul style="list-style-type: none"> Setup the address again after disconnecting communication connection with other refrigerant circuit system.
E15	E15	—	—	I/F	No corresponding indoor unit during automatic address	All stop	<ul style="list-style-type: none"> Indoor unit is not found when indoor automatic address start was set up. 	<ul style="list-style-type: none"> Check the communication line connection between indoor and outdoor. Check the electric power line error in indoor. Power failure Check indoor P.C. board error.
E16	E16	00: Capacity over 01 to: No. of connected units	—	I/F	No. of connected indoor units / Capacity over	All stop	<ul style="list-style-type: none"> Total capacity of indoor units exceeded 135% of total outdoor capacity. No. of connected indoor units are more than 48 units. <p>[Note] If this code appears after backup setup of outdoor unit trouble, set up "No capacity-over detection". <Setup method of "No capacity-over detection"> Turn on SW09/Bit 2 on I/F P.C. board of outdoor header unit.</p>	<ul style="list-style-type: none"> Check the connection capacity of indoor unit. Check the HP capacity of indoor unit. Check the indoor/outdoor capacity setup Check the No. of connected indoor units. Check the outdoor I/F P.C. board error
E18	—	—	—	Indoor unit	Communication error between indoor header and follower units	Corresponding unit only stops.	Regular communication between indoor header and follower units.	<ul style="list-style-type: none"> Check wire of the remote controller. Check power wiring of indoor. Check P.C. board of indoor. Check SW02 setup on the wall type P.C. board. (Should be Bit 1: ON, Bit 2: OFF)
E19	E19	00: No header unit 02: Two or more header units	—	I/F	Outdoor header unit quantity error	All stop	<ul style="list-style-type: none"> There are multiple outdoor header units in 1 line. There is none of outdoor header unit in 1 line. 	<ul style="list-style-type: none"> The outdoor unit connected with communication wire between indoor and outdoor (U1, U2) is the outdoor header unit. Check connection of communication line between indoor and outdoor. Check outdoor P.C. board(I/F) error.
E20	E20	01: Connection of outdoor of other line 02: Connection of indoor of other line	—	I/F	Other line unit connected during automatic address	All stop	Unit of other line was connected when indoor automatic address started.	<ul style="list-style-type: none"> Separate the wire between lines according to automatic address setup method in "Address setup".
E23	E23	—	—	I/F	Communication sending error between outdoor units	All stop	Transmission of other outdoor unit was unavailable for 30 seconds or more.	<ul style="list-style-type: none"> Check the power of outdoor unit. (Is the power turned on?) Check connection of communication wire or disconnection between outdoor units. Check the connector for communication on outdoor P.C. board. Check outdoor P.C. board (I/F) error. Check the end terminal resistance setup for communication between outdoor units.

Main remote controller	Check code		Detected position	Check code name	Status	Error detection condition	Check item (position)
	Outdoor 7-segment display	AI-NET central control remote controller					
	Check code	Sub-code					
E25	E25	—	15	Duplicated outdoor follower address setup	All stop	Outdoor addresses manually set up are duplicated. (Note) Do not set up the outdoor address manually.	
E26	E26	No. of normally received outdoor units	15	Decreased number of connected outdoor units	All stop	The signal was not returned for constant from the outdoor unit which was receiving signal. <ul style="list-style-type: none"> Outdoor is performing backup. Check the power of outdoor unit. (Is the power turned on?) Check connection of inter-unit wire or disconnection between outdoor units. Check the connector connection for communication on outdoor P.C. board. Check outdoor P.C. board (I/F) error. 	
E28	E28	No. of detected outdoor units	d2	Outdoor follower unit error	All stop	Outdoor header unit received error code from outdoor follower unit. <div style="border: 1px solid black; border-radius: 10px; padding: 5px; margin-top: 10px;"> <p><Convenient functions> When pushing SW04 for 1 second or more under condition that [E28] is displayed on 7-segment display of outdoor header unit, the fan of outdoor unit which stopped abnormally starts rotating. If pushing SW04 and SW05 simultaneously, the fan of normal outdoor unit operates. When pushing SW05 singly, the operation of fan is cleared.</p> </div>	
E31	E31	01: IPDU1 error 02: IPDU2 error 03: IPDU1, 2 errors 04: Fan IPDU error 05: IPDU1 + Fan IPDU error 06: IPDU2 + Fan IPDU error 07: All IPDU error or communication error between IPDU and I/F P.C. board or outdoor I/F P.C. board error	CF	IPDU communication error	All stop	Communication of each IPDU (P.C. board) in inverter box interrupted. <ul style="list-style-type: none"> Check connection of communication connector and disconnection between IPDU and I/F P.C. board. Check outdoor P.C. board (I/F, IPDU, Fan IPDU) error. Check external noise. Check power supply P.C. board for fan error. 	
F01	—	—	OF	Indoor TCJ sensor error	Corresponding unit only stops.	Resistance value of sensor is infinite or zero. (Open/Short)	<ul style="list-style-type: none"> Check connection/wiring of TCJ sensor connector. Check characteristics of TCJ sensor resistance value. Check indoor P.C. board error.
F02	—	—	Od	Indoor TC2 sensor error	Corresponding unit only stops.	Resistance value of sensor is infinite or zero (Open/Short).	<ul style="list-style-type: none"> Check connection/wiring of TC2 sensor connector. Check characteristics of TC2 sensor resistance value. Check indoor P.C. board error.
F03	—	—	93	Indoor TC1 sensor error	Corresponding unit only stops.	Resistance value of sensor is infinite or zero (Open/Short).	<ul style="list-style-type: none"> Check connection/wiring of TC1 sensor connector. Check characteristics of TC1 sensor resistance value. Check indoor P.C. board error.
F04	F04	—	19	TD1 sensor error	All stop	Resistance value of sensor is infinite or zero (Open/Short).	<ul style="list-style-type: none"> Check connection of TD1 sensor connector. Check characteristics of TD1 sensor resistance value. Check outdoor P.C. board (I/F) error.
F05	F05	—	A1	TD2 sensor error	All stop	Resistance value of sensor is infinite or zero (Open/Short).	<ul style="list-style-type: none"> Check connection of TD2 sensor connector. Check characteristics of TD2 sensor resistance value. Check outdoor P.C. board (I/F) error.
F06	F06	—	18	TE1 sensor error	All stop	Resistance value of sensor is infinite or zero (Open/Short).	<ul style="list-style-type: none"> Check connection of TE1 sensor connector. Check characteristics of TE1 sensor resistance value. Check outdoor P.C. board (I/F) error.

Main remote controller		Check code			Detected position	Check code name	Status	Error detection condition	Check item (position)
		Outdoor 7-segment display		AI-NET central control remote controller					
		Check code	Sub-code						
F07	F07	—	18	I/F	TL sensor error	All stop	<ul style="list-style-type: none"> Resistance value of sensor is infinite or zero (Open/Short). 	<ul style="list-style-type: none"> Check connection of TL sensor connector. Check characteristics of TL sensor resistance value. Check outdoor P.C. board (I/F) error. 	
F08	F08	—	1b	I/F	TO sensor error	All stop	<ul style="list-style-type: none"> Resistance value of sensor is infinite or zero (Open/Short). 	<ul style="list-style-type: none"> Check connection of TO sensor connector. Check characteristics of TO sensor resistance value. Check outdoor P.C. board (I/F) error. 	
F10	—	—	OC	Indoor	Indoor TA sensor error	Corresponding unit only stops.	<ul style="list-style-type: none"> Resistance value of sensor is infinite or zero (Open/Short). 	<ul style="list-style-type: none"> Check connection/wiring of TA sensor connector. Check characteristics of TA sensor resistance value. Check indoor P.C. board error. 	
F12	F12	—	A2	I/F	TS1 sensor error	All stop	<ul style="list-style-type: none"> Resistance value of sensor is infinite or zero (Open/Short). 	<ul style="list-style-type: none"> Check connection of TS1 sensor connector. Check characteristics of TS1 sensor resistance value. Check outdoor P.C. board (I/F) error. 	
F13	F13	01: Compressor 1 side 02: Compressor 2 side	43	IPDU	TH sensor error	All stop	<ul style="list-style-type: none"> Resistance value of sensor is infinite or zero (Open/Short). 	<ul style="list-style-type: none"> IGBT built-in temp sensor error → Exchange IPDU P.C. board. 	
F15	F15	—	18	I/F	Outdoor temp. sensor miscabling (TE1, TL)	All stop	<ul style="list-style-type: none"> During operation of compressor in HEAT mode, the TE1 detection temp was higher than that of TL by the specified value continued for 3 minutes or more. 	<ul style="list-style-type: none"> Check installation of TE1 sensor and TL sensor. Check characteristics of TE1 and TL sensor resistance value. Check outdoor P.C. board (I/F) error. 	
F16	F16	—	43	I/F	Outdoor pressure sensor miscabling (Pd, Ps)	All stop	<ul style="list-style-type: none"> High-pressure Pd sensor and low-pressure Ps sensor were exchanged, or output voltages of both sensors are zero. 	<ul style="list-style-type: none"> Check connection of high-pressure Pd sensor connector. Check connection of low-pressure Ps sensor connector. Check pressure sensors Pd and Ps error. Check outdoor P.C. board (I/F) error. Check compression error of compressor. 	
F23	F23	—	43	I/F	Ps sensor error	All stop	<ul style="list-style-type: none"> Output voltage of Ps sensor was zero. 	<ul style="list-style-type: none"> Misconnection of Ps sensor and Pd sensor connectors Check connection of Ps sensor connector. Check Ps sensor error. Check compression error of compressor. Check 4-way valve error. Check outdoor P.C. board (I/F) error. Check SV4 circuit error. 	
F24	F24	—	43	I/F	Pd sensor error	All stop	<ul style="list-style-type: none"> Output voltage of Pd sensor was zero. (Sensor Open) Pd > 4.15MPa during stop of compressor 	<ul style="list-style-type: none"> Check connection of Pd sensor connector. Check Pd sensor error. Check outdoor P.C. board (I/F) error. 	
F29	—	—	12	Indoor	Indoor other error	Corresponding unit only stops.	<ul style="list-style-type: none"> Indoor P.C. board did not operate normally. 	<ul style="list-style-type: none"> Check indoor P.C. board error (EEPROM error). 	
F31	F31	—	1C	I/F	Outdoor EEPROM error	All stop (*1)	<ul style="list-style-type: none"> Outdoor P.C. board (I/F) did not operate normally. 	<ul style="list-style-type: none"> Check power voltage. Check power noise. Check outdoor P.C. board (I/F) error. 	
H01	H01	01: Compressor 1 side 02: Compressor 2 side	1F	IPDU	Compressor breakdown	All stop	<ul style="list-style-type: none"> Inverter current detection circuit detected over-current and stopped. 	<ul style="list-style-type: none"> Check power voltage. (AC220-240V ± 10%). Check compressor error. Check cause of abnormal overload operation. Check outdoor P.C. board (IPDU) error. 	

(*1) All stop only in case of the header unit The follower unit continues operation.

Main remote controller	Check code			Detected position	Check code name	Status	Error detection condition	Check item (position)
	Outdoor 7-segment display		AI-NET central control remote controller					
	Check code	Sub-code						
H02	H02	01: Compressor 1 side 02: Compressor 2 side	1d	IPDU	Compressor error (lock) MG-SW error OCR operation	All stop	Over-current was detected several seconds after header compressor had started.	<ul style="list-style-type: none"> • Check compressor error. • Check power voltage. (AC380 –10%, 415V +10%). • Check cable of compressor and phase-missing. • Check connector/terminal connection on IPDU PC board. • Check conduction of case heater. • Check activation error due to liquid stagnation in compressor.) • Check outdoor PC board (IPDU) error. • Check outdoor MG-SW or OCR.
H03	H03	01: Compressor 1 side 02: Compressor 2 side	17	IPDU	Current detection circuit system error	All stop	While header compressor stopped, current flowed more than the specified current and was detected.	<ul style="list-style-type: none"> • Check wiring of current detection circuit system. • Check outdoor PC board (IPDU) error.
H04	H04	—	44	I/F	Compressor 1 case thermo operation	All stop	Compressor 1 case thermo-stat performed protective operation.	<ul style="list-style-type: none"> • Check compressor 1 case thermo circuit. (Connector, wire, PC board) • Check full opening of service valve. (Gas and liquid side) • Check outdoor PMV clogging. (PMV1, 2) • Check SV41 circuit leakage. • Check miscabling/misinstallation of SV41 and SV42. • Check valve open status of indoor PMV. • Check compressor error. • Check 4-way valve error. • Check refrigerant shortage.
H06	H06	—	20	I/F	Low-pressure protective operation	All stop	Low-pressure Ps detected operation lower than 0.02MPa.	<ul style="list-style-type: none"> • Check full opening of service valve. (Gas and liquid side) • Check outdoor PMV clogging. (PMV1, 2) • Check SV41 circuit and SV42 circuit error. • Check low-pressure Ps sensor error. • Check indoor air filter clogging. • Check valve open of indoor PMV. • Check refrigerant pipe clogging. • Check outdoor fan operation. (In heating mode) • Check refrigerant shortage.
H07	H07	—	d7	I/F	Protection for oil level drop detection	All stop	The operating compressor detected oil shortage continuously for 2 hours.	<p><Check all the outdoor units in the corresponding line.></p> <ul style="list-style-type: none"> • Check full opening of service valve of balance pipe. • Check connection and installation of TK1, TK2, TK3, and TK4 sensors. • Check characteristics of TK1, TK2, TK3, and TK4 resistance values. • Check gas leak and oil leak in the same line. • Check refrigerant stagnation in compressor. • Check error of SV3A, SV3B, SV3C, SV3D, and SV3E valves. • Check clogging of oil separator oil return circuit. • Check clogging of oil-equation circuit.

MG-SW : Magnet Switch
OCR : Over-current Relay

Main remote controller	Check code			Detected position	Check code name	Status	Error detection condition	Check item (position)
	Outdoor 7-segment display		AI-NET central control remote controller					
	Check code	Sub-code						
H08	H08	01: TK1 sensor error 02: TK2 sensor error 03: TK3 sensor error 04: TK4 sensor error	d4	I/F	Oil level detective temp sensor error	All stop	Resistance value of sensor is infinite or zero. (Open/Short)	<ul style="list-style-type: none"> Check connection of TK1 sensor connector. Check characteristics of TK1 sensor resistance value. Check outdoor P.C. board (I/F) error. Check connection of TK2 sensor connector. Check characteristics of TK2 sensor resistance value. Check outdoor P.C. board (I/F) error. Check connection of TK3 sensor connector. Check characteristics of TK3 sensor resistance value. Check outdoor P.C. board (I/F) error. Check connection of TK4 sensor connector. Check characteristics of TK4 sensor resistance value. Check outdoor P.C. board (I/F) error.
H14	H14	—	44	I/F	Compressor 2 case thermo operation	All stop	Compressor 2 case thermostat operated.	<ul style="list-style-type: none"> Check compressor 2 case thermo circuit. (Connector, wire, P.C. board) Check full opening of service valve. (Gas and liquid side) Check outdoor PMV clogging. (PMV1, 2) Check SV42 valve leak. Check miswiring/misinstallation of SV41 and SV42. Check valve opening of indoor PMV. Check 4-way valve error. Check refrigerant shortage. Check compressor error.
H16	H16	01: TK1 oil circuit system error 02: TK2 oil circuit system error 03: TK3 oil circuit system error 04: TK4 oil circuit system error	d7	I/F	Oil level detective circuit system error MG-SW error OCR operation	All stop	Temperature change of TK1 could not be detected though compressor 1 started the operation. Temperature change of TK2 could not be detected though compressor 2 started the operation. Temperature change of TK3 could not be detected though compressor started the operation.	<ul style="list-style-type: none"> Check TK1 sensor coming-off. Check characteristics of TK1 sensor resistance value. Check TK1, TK2, TK3, and TK4 misconnection. Check operation error of SV3E valve. Check capillary clogging of oil-equalization circuit and operation error of stop valve. Check refrigerant stagnation in compressor. Check MG-SW or OCR. Check TK2 sensor coming-off. Check characteristics of TK2 sensor resistance value. Check TK1, TK2, TK3, and TK4 misconnection. Check SV3E valve operation. Check capillary clogging of oil equalization circuit and check stop valve operation. Check refrigerant stagnation in compressor shell. Check MG-SW or OCR. Check TK3 sensor coming-off. Check characteristics of TK3 sensor resistance value. Check TK1, TK2, TK3, and TK4 misconnection. Check SV3E valve operation. Check capillary clogging of oil-equalization circuit and check valve operation. Check refrigerant stagnation in compressor shell. Check MG-SW or OCR. Check TK4 sensor coming-off. Check characteristics of TK4 sensor resistance value. Check TK1, TK2, TK3, and TK4 misconnection. Check SV3E valve operation. Check capillary clogging of oil-equalization circuit and check valve operation. Check refrigerant stagnation in compressor shell. Check MG-SW or OCR.
				MG-SW : Magnet Switch OCR : Over-current Relay				

Main remote controller	Check code		Detected position	Check code name	Status	Error detection condition	Check item (position)
	Outdoor 7-segment display						
	Check code	Sub-code					
L03	—	—	Indoor	Duplicated indoor center units	Corresponding unit only stops.	There are multiple center units in a group.	<ul style="list-style-type: none"> • Check indoor address. • Check the change of remote controller connection (Group/individual) after indoor address setup.
L04	L04	—	I/F	Duplicated outdoor line address	All stop	Line address setup is duplicated against the outdoor unit in different refrigerant pipe system.	<ul style="list-style-type: none"> • Check line address.
L05	—	—	I/F	Duplicated indoor units with priority (Displayed on indoor unit with priority)	All stop	Indoor units with priority were duplicated.	<ul style="list-style-type: none"> • Check display of indoor unit with priority.
L06	L06	No. of indoor units with priority	I/F	Duplicated indoor units with priority (Displayed on the unit other than indoor unit with priority)	All stop	Indoor units with priority were duplicated.	<ul style="list-style-type: none"> • Check display of indoor unit with priority and outdoor unit.
L07	—	—	Indoor	Group line in individual indoor unit.	Corresponding unit only stops.	At least one indoor unit connected to a group existed in the individual indoor units.	<ul style="list-style-type: none"> • Check indoor address.
L08	L08	—	Indoor	Indoor group / address unset	Corresponding unit only stops.	Address was not yet set up.	<ul style="list-style-type: none"> • Check indoor address. <p>Note) After installation, this code is displayed when the power is firstly turned on.</p>
L09	—	—	Indoor	Indoor capacity unset	Corresponding unit only stops.	Indoor unit capacity was unset.	Set up indoor capacity. (DN=11)
L10	L10	—	I/F	Outdoor capacity unset	All stop	On the I/F P.C. board for service, jumper line was not cut according to the model.	Check model setup on outdoor I/F P.C. board Assy for service.
L20	—	—	AI-NET, Indoor	Duplicated central control addresses	All stop	Duplicated central control addresses	<ul style="list-style-type: none"> • Check central control address. • Check network adaptor P.C. board. (In case of AI-NET)
L28	L28	—	I/F	Quantity over of connected outdoor units	All stop	There were more than four outdoor units.	<ul style="list-style-type: none"> • Check No. of connected outdoor units. (Max. 4 units per 1 system) • Check communication line between outdoor units. • Check outdoor P.C. board (I/F) error.
L29	L29	01: IPDU1 error 02: IPDU2 error 03: IPDU1, 2 errors 04: Fan IPDU error 05: IPDU1 + Fan IPDU error 06: IPDU2 + Fan IPDU error 07: All IPDU error or communication error between IPDU and I/F P.C. board, or outdoor I/F P.C. board error	I/F	IPDU quantity error	All stop	No. of IPDU units detected when power was turned on were less.	<ul style="list-style-type: none"> • Check model setup for outdoor I/F service P.C. board. • Check connection of UART communication connector. • Check IPDU, fan IPDU, and I/F P.C. board error. <p>Note) UART: Universal Asynchronous Receiver Transmitter</p>

Main remote controller	Check code			Detected position	Check code name	Status	Error detection condition	Check item (position)
	Outdoor 7-segment display		AI-NET central control remote controller					
	Check code	Sub-code						
L30	L30	Detected indoor address	b6	Indoor	Interlock in indoor unit from outside	Corresponding unit only stops.	<ul style="list-style-type: none"> Outside error input terminal Detected signal to (CN80) for more 1 minute 	<ul style="list-style-type: none"> Outside device is connected to connector (CN80): <ol style="list-style-type: none"> 1) Check outside device error. 2) Check indoor P.C. board error. Outside device is not connected to connector (CN80): <ol style="list-style-type: none"> 1) Check indoor P.C. board error.
—	L31	—	—	I/F	Extended IC (Integrated Circuit) error	Operation continues.	P.C. board (I/F) parts error	Check indoor (I/F) P.C. board.
P01	—	—	11	Indoor	Indoor fan motor error	Corresponding unit only stops.		<ul style="list-style-type: none"> Check the lock of fan motor (AC fan). Check wiring.
P03	P03	—	1E	I/F	Discharge temp TD1 error	All stop	Discharge temp (TD1) exceeded 115°C.	<ul style="list-style-type: none"> Check full opening of outdoor service valves (Gas side, Liquid side). Check clogging of outdoor PMV. (PMV1,2) Check characteristics of TD1 sensor resistance value. Check refrigerant shortage. Check 4-way valve error. Check leakage of SV41 circuit. Check SV4 circuit. Check SV4 circuit. (Miscabling and misinstallation of SV41 and SV42)
P04	P04	01: Compressor 1 side 02: Compressor 2 side	21	I/F	Actuation of high-pressure SW	All stop	High-pressure SW actuated.	<ul style="list-style-type: none"> Check Pd pressure sensor error. Check full opening of outdoor service valves (Gas side, Liquid side). Check outdoor fan error. Check outdoor fan motor error. Check clogging of outdoor PMV. (PMV1,2) Check clogging of indoor/outdoor heat exchangers. Check short-circuiting of outdoor suction/discharge air. Check clogging of SV2 circuit. Check outdoor P.C. board (I/F) error. Check indoor fan system error. Cause of air volume decrease Check opening of indoor PMV. Check miswiring of communication line between indoor and outdoor. Check operation error of check valve of discharge pipe. Check SV4 valve circuit. Check SV5 valve circuit. Check refrigerant overcharge.
P05	P05	01: Power supply open phase 02: Power supply negative phase	AF	I/F	Open phase negative phase	All stop	<ul style="list-style-type: none"> Open phase was detected when the power turned on. Negative phase was detected when the power turned on. 	<ul style="list-style-type: none"> Check outdoor power line. Check outdoor P.C. board (I/F) error.

Main remote controller	Check code			Detected position	Check code name	Status	Error detection condition	Check item (position)
	Outdoor 7-segment display		AI-NET central control remote controller					
	Check code	Sub-code						
P07	P07	01: Compressor 1 side 02: Compressor 2 side	1C	IPDU I/F	Heat sink overheat error	All stop	IGBT built-in temp sensor (TH) was overheated.	<ul style="list-style-type: none"> • Check power voltage. • Check outdoor fan system error. • Check clogging of heat sink cooling duct. • Check fixation between IGBT and heat sink. (Check screwing and contact.) • Check IPDU error.(IGBT built-in temp sensor (TH) error)
P12	—	—	11	Indoor	Indoor fan motor error	Corresponding unit only stops.	<ul style="list-style-type: none"> • The value of motor speed deviated from target value was detected for certain time. • Over-current protection operated. 	<ul style="list-style-type: none"> • Check connection of fan connector and wiring. • Check fan motor error. • Check indoor P.C. board error. • Check influence of outside air control. • Check indoor type code (DN=10) and the capacity code (DN=11).
P13	P13	—	47	I/F	Outdoor liquid back detection error	All stop	<p><In cooling> While the system is operating in COOL mode, a high pressure value was detected in follower unit in which compressor did not operate.</p> <p><In heating> While the system is operating in HEAT mode, outdoor PMV of which opening degree was 100p or less for a certain time.</p>	<ul style="list-style-type: none"> • Check full close operation of outdoor PMV (1, 2). • Check Pd and Ps sensor error. • Check clogging of SV2 circuit. • Check clogging of balance pipe. • Check clogging of SV3B circuit. • Check outdoor P.C. board (I/F) error. • Check capillary clogging of oil return circuit from oil separator. • Check leakage of check valve of the main discharge pipe.
P15	P15	01: TS condition	AE	I/F	Gas leak detection (TS1 condition)	All stop	<p>Suction temp exceeded the judgment standard temp for 10 minutes or more.</p> <p><TS error judgment standard temperature> In cooling operation: 60°C or higher In heating operation: 40°C or higher</p>	<ul style="list-style-type: none"> • Check refrigerant shortage. • Check full open of outdoor service valves (gas side, liquid side). • Check outdoor PMV clogging (PMV1, 2). • Check characteristics of TS1 sensor resistance value. • Check 4-way valve error. • Check leakage of SV4 circuit.
		02: TD condition	AE	I/F	Gas leak detection (TD condition)	All stop	Discharge temperature TD1 or TD2 was continuously 108°C or higher for 10 minutes.	<ul style="list-style-type: none"> • Check refrigerant shortage. • Check outdoor PMV clogging (PMV1, 2). • Check characteristics of TD1, TD2 sensor resistance value. • Check indoor air filter clogging. • Check pipe clogging. • Check SV4 circuit (Valve leakage, misinstallation)
P17	P17	—	bb	I/F	Discharge temp TD2 error	All stop	Discharge temperature (TD2) exceeded 115°C.	<ul style="list-style-type: none"> • Check full opening of outdoor service valves (gas side, liquid side). • Check clogging of outdoor PMV (PMV1, 2). • Check characteristics of TD2 sensor resistance value. • Check 4-way valve error. • Check leakage of SV42 circuit. • Check SV4 circuit. (Miscabling and misinstallation of SV41 and SV42)
P19	P19	Detected outdoor unit No.	8	I/F	4-way valve operation error	All stop	When abnormal refrigerating cycle data was detected in heating	<ul style="list-style-type: none"> • Error of 4-way valve error • Check coil error and connector connection of 4-way valve. • Check characteristics of TS1/TE1 sensor resistance value. • Check characteristics of Pd, Ps pressure sensor output voltage. • Check misconnection of TE1 and TL sensors.

Main remote controller	Check code		Detected position	Check code name	Status	Error detection condition	Check item (position)
	Outdoor 7-segment display						
	Check code	Sub-code					
P20	P20	—	I/F	High-pressure protective operation	All stop	Pd sensor detected 3.6MPa or more.	<ul style="list-style-type: none"> • Check Pd pressure sensor error. • Check full opening of service valves (Gas side, Liquid side). • Check outdoor fan error. • Check outdoor fan motor error. • Check clogging of outdoor PMV. (PMV1,2) • Check clogging of indoor/outdoor heat exchangers. • Check air short-circuiting in outdoor unit. • Check clogging of SV2 circuit. • Check outdoor P.C. board (I/F) error. • Check indoor fan system error. • (Cause of air volume decrease) • Check valve opening of indoor PMV. • Check miswiring of communication line between indoor and outdoor. • Check operation error of check valve of discharge pipe. • Check circuit of gas balance SV4 valve. • Check circuit of SV5 valve. • Check refrigerant overcharge.
P22	P22	—	FAN-IPDU	Outdoor fan IPDU error	All stop	<p>(Sub-code: 0)</p> <ul style="list-style-type: none"> • Short-circuit current was detected at start time. • Short-circuit current was detected when checking IGBT short-circuit before start time. <p>(Sub-code: 1)</p> <ul style="list-style-type: none"> • The standard value of detection circuit of fan IPDU current fluctuated at start time. <p>(Sub-code: 3)</p> <ul style="list-style-type: none"> • Abnormal current was detected within 30 seconds after start time. <p>(Sub-code: 4)</p> <ul style="list-style-type: none"> • Short-circuit current was detected when 2 seconds or more passed after start time. • Over-current was detected when 30 seconds or more passed after start time. <p>(Sub-code: C)</p> <ul style="list-style-type: none"> • Heat sink sensor (TH) of fan IPDU detected 95°C error. <p>(Sub-code: D)</p> <ul style="list-style-type: none"> • Heat sink sensor (TH) of fan IPDU detected short-circuiting or open. <p>(Sub-code: E)</p> <ul style="list-style-type: none"> • Input power supply voltage of the fan IPDU over the setup value was detected. • Input power supply terminal of the fan IPDU was unconnected. • Power supply P.C. board error of the fan IPDU 	<ul style="list-style-type: none"> • Check fan motor. (Interphase short-circuit) • Check fan IPDU error. <ul style="list-style-type: none"> • Check fan IPDU error. <ul style="list-style-type: none"> • Check fan motor. (Lock, phase missing) • Check cause of abnormal overload at start time. • Check connection of connector to fan motor. <ul style="list-style-type: none"> • Check power supply voltage. • Check fan IPDU error. <ul style="list-style-type: none"> • Check outdoor fan system. • Check fan IPDU error. • Check fixation between fan IPDU and heat sink. <ul style="list-style-type: none"> • Check fan IPDU error. <ul style="list-style-type: none"> • Check input power supply voltage of the fan IPDU • Check power supply P.C. board error of the fan IPDU. • Check error of external electrolytic condenser.

Main remote controller	Check code			Detected position	Check code name	Status	Error detection condition	Check item (position)
	Outdoor 7-segment display		AI-NET central control remote controller					
	Check code	Sub-code						
P26	P26	01: Compressor 1 side 02: Compressor 2 side	14	IPDU	G-Tr short-circuit protection error	All stop	Instantaneous over-current was detected when compressor started.	<ul style="list-style-type: none"> • Check connector connection and wiring on IPDU P.C. board. • Check compressor error and defect of compressor coil. • Check outdoor P.C. board (IPDU) error.
P29	P29	01: Compressor 1 side 02: Compressor 2 side	16	IPDU	Compressor position detection circuit error	All stop	Position was not normally detected.	<ul style="list-style-type: none"> • Check connector connection and wiring. • Check compressor error and defect of compressor coil. • Check P.C. board (IPDU) error.
P31	—	—	47	Indoor	Other indoor error (Group follower unit error)	Corresponding unit only stops.	E07/L07/L03/L08 was detected when other indoor unit in the group was defective.	<ul style="list-style-type: none"> • Check indoor P.C. board.

Error detected by TCC-LINK central control device

Display on central control device	Check code		Detected position	Check code name	Status	Error detection condition	Check item (position)
	Outdoor 7-segment display	AI-NET central remote controller					
	Sub-code						
C05	—	—	TCC-LINK	TCC-LINK central control device transmission error	Operation continued.	Signal is not transmit from central control device.	<ul style="list-style-type: none"> • Check central control device error. • Check communication line error of central control device. • Check setup of end terminal resistance.
C06	—	—		TCC-LINK central control device receiving error	Operation continued.	Signal is not received from central control device.	<ul style="list-style-type: none"> • Check central control device error. • Check communication line error of central control device. • Check setup of end terminal resistance. • Check the power of connecting destination connected device. • Check PC board error of the connected device.
C12	—	—	General-purpose device I/F	Interface batch alarm of general-purpose control devices	Operation continued.	Error was input in general-purpose control device control interface.	<ul style="list-style-type: none"> • Check error input.
P30	Differs according to error contents of the with alarm		TCC-LINK	Follower unit error of group control	Operation continued.	An error occurred in follower unit of the group control. ([P30] is displayed only on the central control remote controller.)	<ul style="list-style-type: none"> • Check the check code of the unit with alarm.
		(L20 is displayed.)		Duplicated central control address	Operation continued.	Central control addresses were duplicated.	<ul style="list-style-type: none"> • Check the address setup.

Error detected by AI-NET central control device

Main remote controller	Check code		Detected position	Check code name	Status	Error detection condition	Check item (position)
	Outdoor 7-segment display	AI-NET central remote controller					
	Check code	Sub-code					
—	—	—	AI-NET	AI-NET communication system error	Operation continued.	E07/L07/L03/L08 was detected when other indoor unit in the group was defective.	<ul style="list-style-type: none"> • Check multiple network adaptors. • Check wire and miswiring of remote controller. Only one network adaptor can be connected to communication line of remote controller.
—	—	—	AI-NET	Duplicated network adaptors	Operation continued.	Multiple network adaptors were connected to communication line of remote controller. (Detected at central controller side)	<ul style="list-style-type: none"> • Check communication line, miswiring, and power of indoor unit. • Check communication. (X, Y terminals) • Check network adaptor PC board. • Check the central controller (Central control remote controller, etc.)
—	—	—	AI-NET	Error in indoor group	Operation continued.	Error of follower unit in the group	<ul style="list-style-type: none"> • Check follower unit in the group.

* These errors are concerned to communication of remote controllers (A, B) and central system [AI-NET X, Y], and the main remote controller displays [E01], [E02], [E03], [E09], or [E18] in some cases and displays none in other cases according to the contents.

7-4-1. Cautions When Servicing for Compressor

1. Removing wires of both compressors check output of the inverter as described below.

7-4-2. How to Check Inverter Output

1. Turn off the power supply.
2. Remove the compressor lead cables from the compressors.
(Be sure to remove lead cables of both compressors.)
3. Turn on the power supply and start cooling or heating operation.
In this time, pay attention to touch the fasten receptacle terminal lug of the compressor leads so that they do not contact with other fasten receptacle terminal lug or other position (unit cabinet, etc.).
4. Check output voltage of compressor lead cable at inverter side.
When the output voltage does not satisfy the criteria in the following table, replace IPDU P.C. board.

No.	Measured position	Criteria
1	Between Red and White	400 V to 650 V
2	Between White and Black	400 V to 650 V
3	Between Black and Red	400 V to 650 V

- * After checking the output, when connecting the compressor lead again to the compressor terminal, check surely there is no distortion on the fasten terminal lug. If it is loosened, caulk it with pinchers, etc and then connect lead to the terminal.

7-4-3. How to Check Resistance of Compressor Winding

1. Turn off the power supply.
2. Remove the compressor lead cables from the compressors.
In each compressor, check the winding resistance between phases and resistance of the outdoor cabinet using a tester.
 - Is not it earthed?
→ Normal if 10MΩ or more are measured
 - Is not shorted between windings?
→ Normal if 0.7Ω to 0.9Ω are measured (Use a precise digital tester.)

7-4-4. How to Check the External Fan Motor

1. Turn off the power supply.
2. Take off three connectors (U.V.W) from the external fan IPDU P.C. board.
3. Turn the fan with hands. If the fan does not turn, it is a fan motor error (Lock). Replace the fan motor.
If the fan turns, measure the winding resistance between the phases of the connector (Motor winding) with a tester. If 13 to 33Ω are measured, it is normal. (Use a digital tester.)

7-5. Diagnosis Procedure for Each Check Code

Check code	Check code name	Cause of operation
[E01] / [-] (Current code / AI-NET)	Communication error between indoor and remote controller (Detected at remote controller side)	1. Remote controller inter-unit cable error 2. Indoor power error 3. Indoor P.C. board error 4. Remote controller address setup error 5. Remote controller P.C. board error

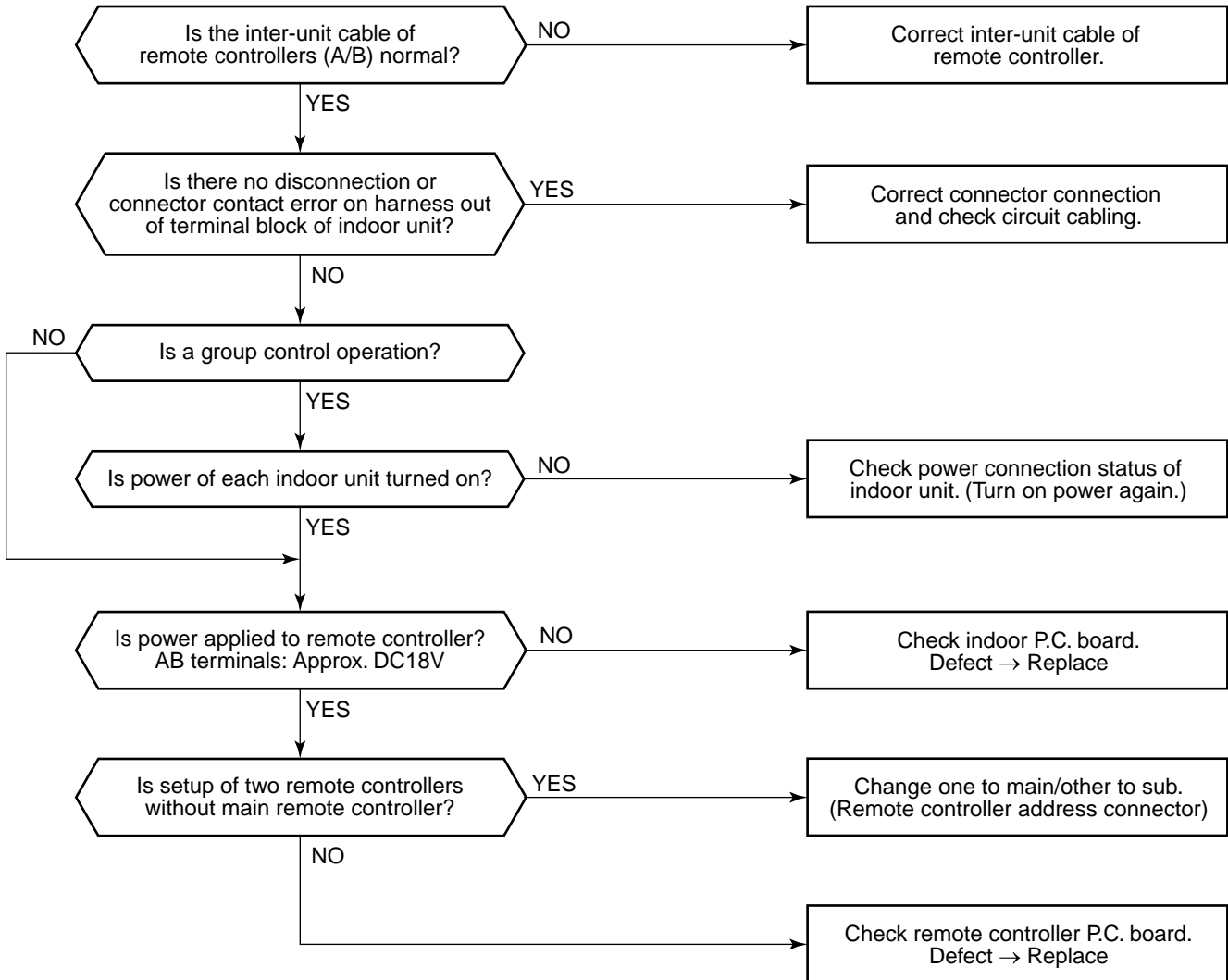

Check code	Check code name	Cause of operation
[E02] / [-] (Current code / AI-NET)	Remote controller sending error	Signal could not be sent to indoor unit. Check the communication wire of the remote controller.

* It is not displayed on 7-segment display of the central control controller.

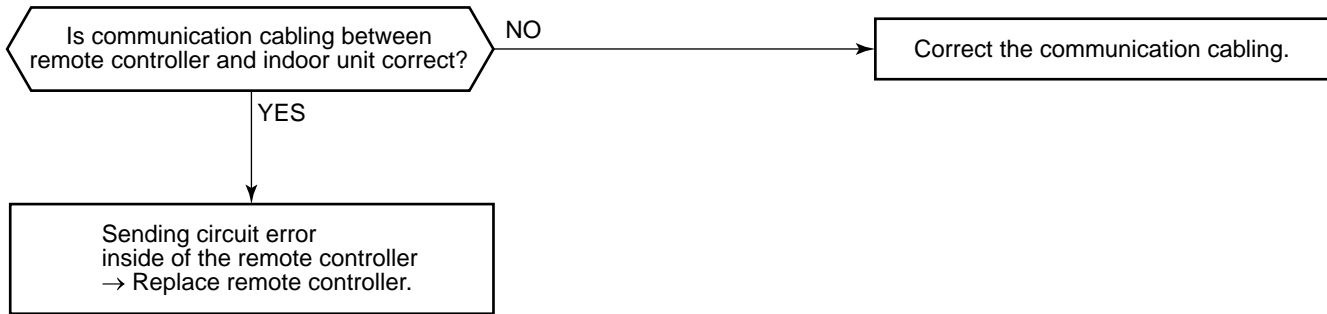

Check code	Check code name	Cause of operation
[E03] / [97] (Current code / AI-NET)	Communication error between indoor and remote controller (Detected at indoor side)	No communication from remote controller and communication adaptor

This error is detected when the indoor unit cannot receive a signal from the remote controller.
 Check communication cables of the remote controllers A and B.
 As communication is impossible, this check code [E03] is not displayed on the main remote controller.
 It is displayed on TCC-LINK central controller.

Check code	Check code name	Cause of operation
[E04] / [04] (Current code / AI-NET)	Indoor/Outdoor communication circuit error (Detected at indoor side)	1. Power of outdoor unit was firstly turned on. 2. Connection error of communication line between indoor and outdoor 3. End terminal resistance setup error on communication between indoor and outdoor 4. Address setup error 5. Switch setup error of wall type P.C. board

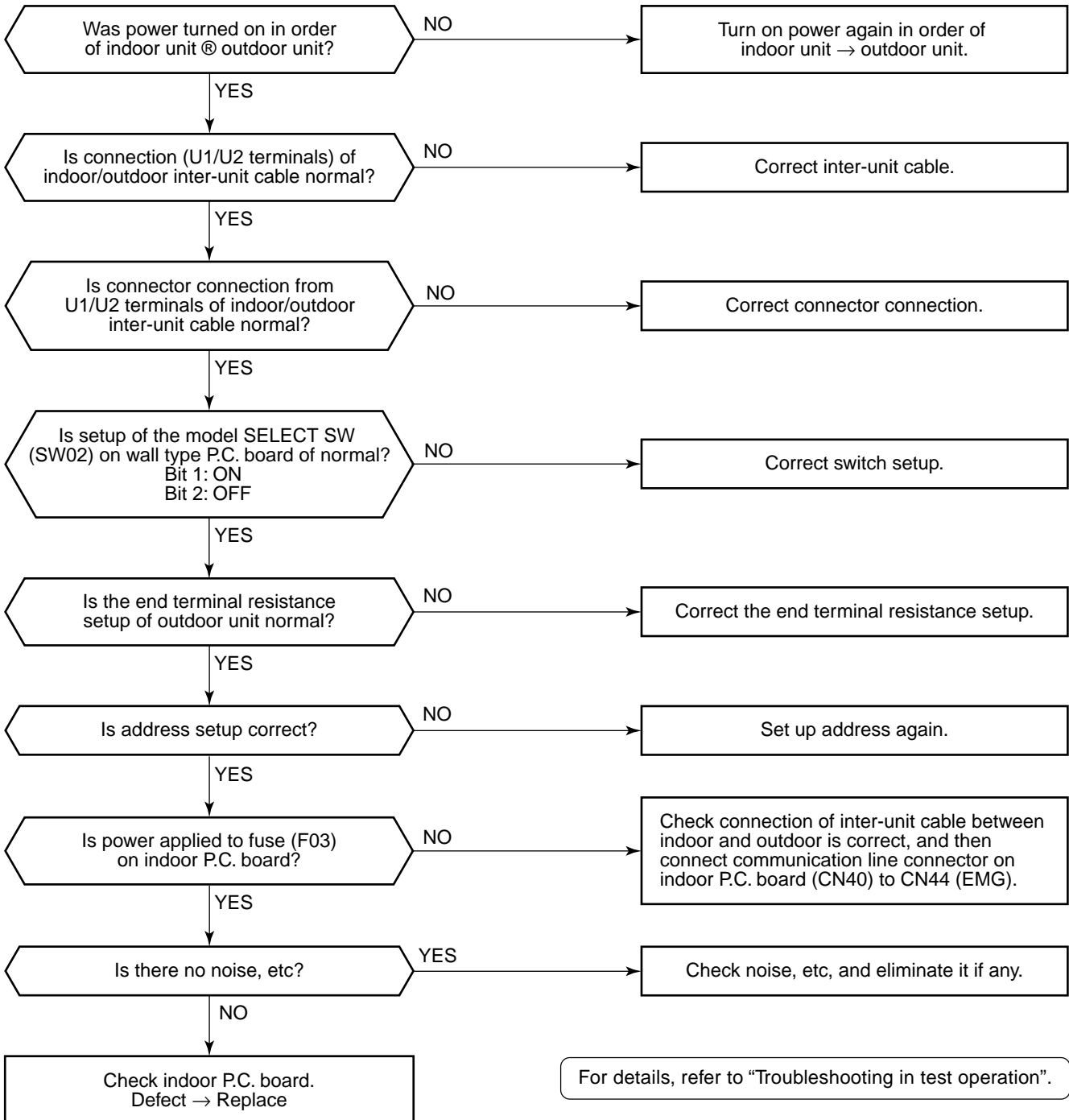

Check code	Check code name	Cause of operation
[E06] / [04] (Current code7 / AI-NET)	Decreased number of indoor units	1. Communication lines (U1, U2) connection error between indoor and outdoor 2. Connector connection error of communication for indoor P.C. board 3. Connector connection error of communication for outdoor I/F board 4. Power supply of indoor unit (Is power turned on?)

Sub-code: No. of indoor units which received signals normally

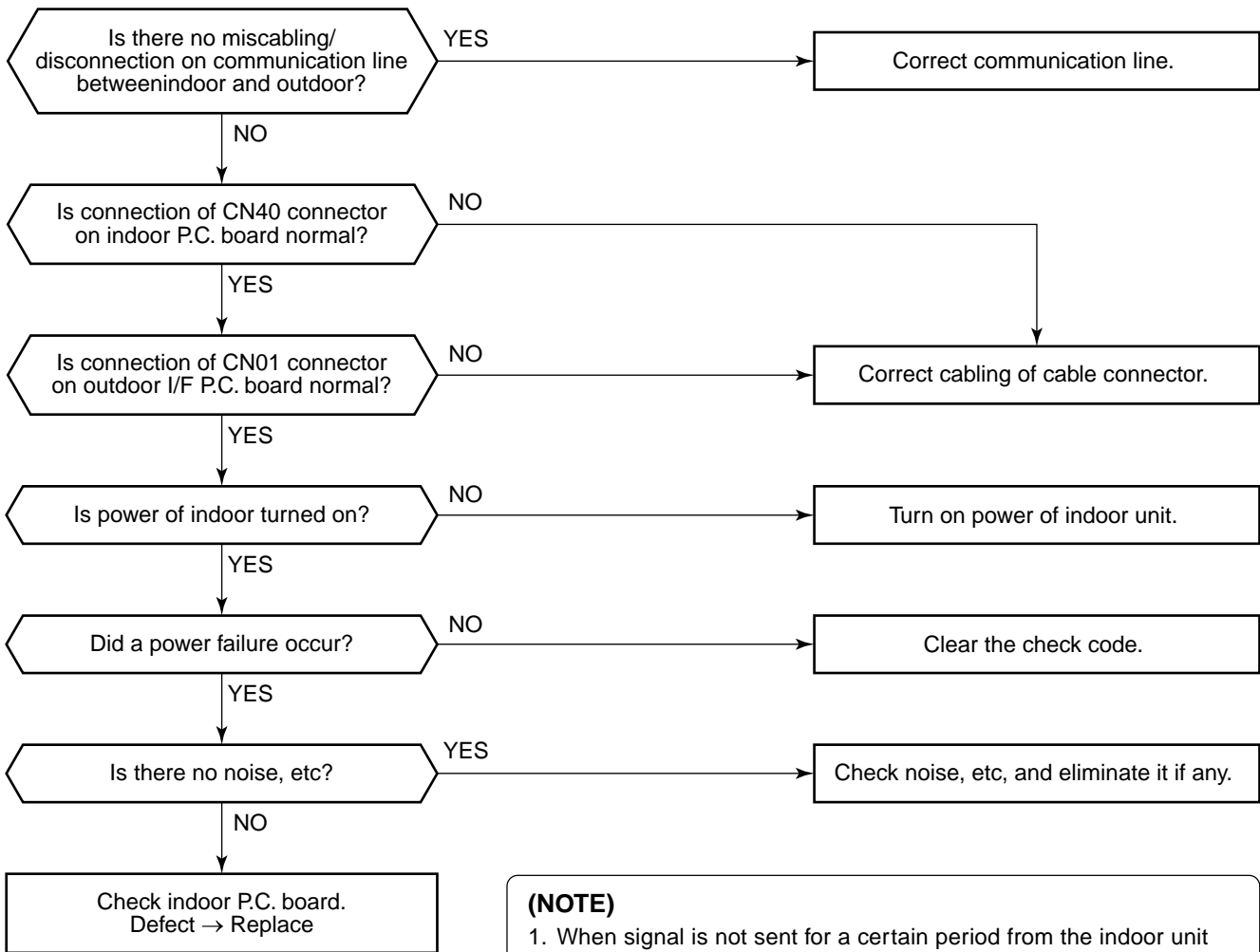

(NOTE)
 1. When signal is not sent for a certain period from the indoor unit which has used to send signals normally, [E06] is displayed.

Check code	Check code name	Cause of operation
[E07] / [-] (Current code / AI-NET)	Indoor/Outdoor communication circuit error (Detected at outdoor side)	1. Indoor/outdoor communication end terminal resistance setup error 2. Indoor/outdoor communication connection error

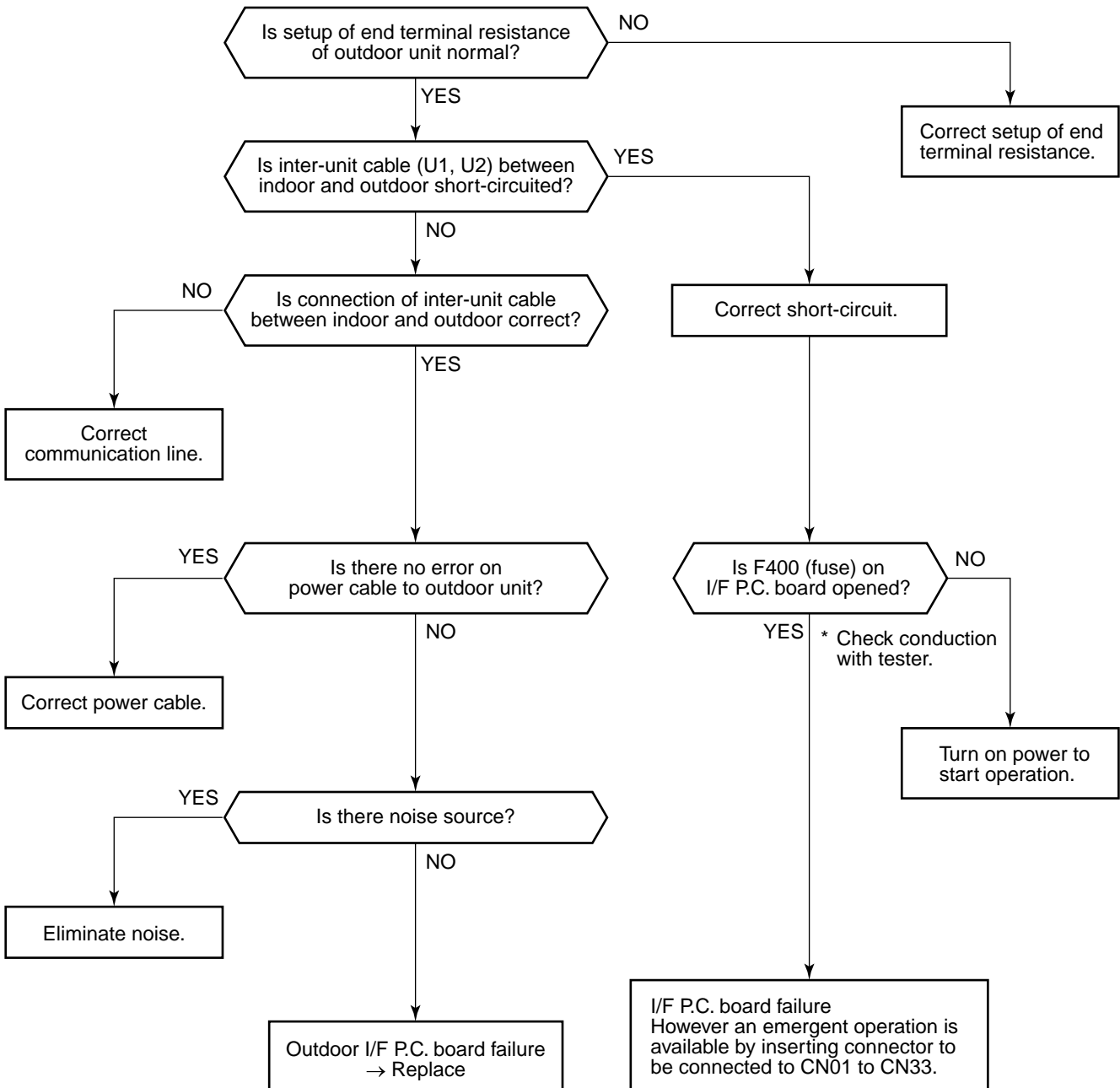

Check code	Check code name	Cause of operation
[E08] / [96] (Current code / AI-NET)	Duplicated indoor addresses	1. Indoor addresses are duplicated. 2. Switch setup error of wall type P.C. board

Sub-code: Duplicated indoor address

Using a main remote controller (RBC-AMT21E), check the setup item codes (DN code) 12, 13, and 14.
When there is no address duplication, check to the following flowchart.

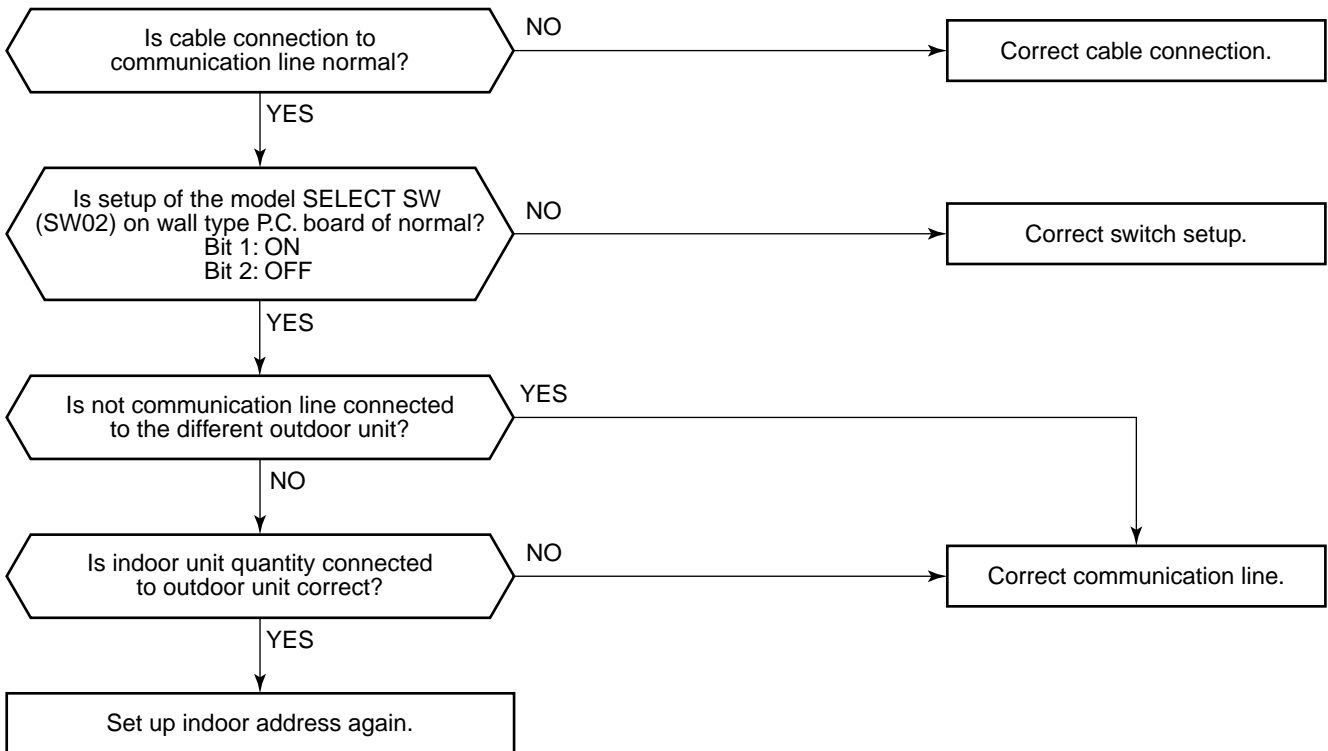

Check code	Check code name	Cause of operation
[E09] / [99] (Current code / AI-NET)	Duplicated master remote controller	Setup of master remote controller is duplicated.

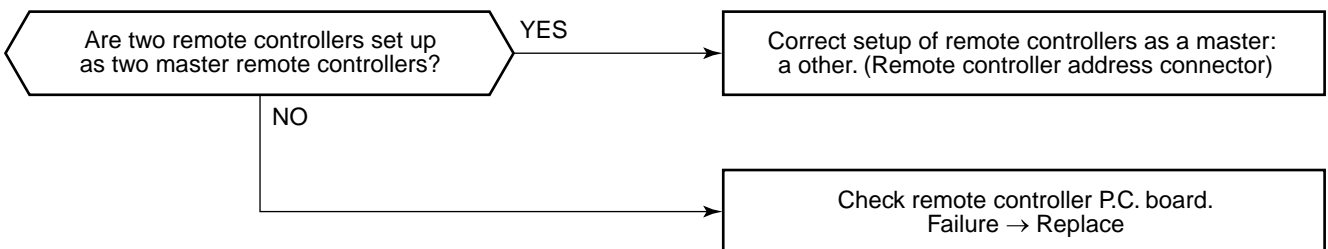

Check code	Check code name	Cause of operation
[E12] / [42] (Current code / AI-NET)	Automatic address start error	1. When indoor automatic address started, other refrigerant circuit system was setting automatic address. 2. When outdoor automatic address started, the indoor automatic address was being set. (Sub-code: 02)

Sub-code: 01: Communication between indoor and outdoor 02: Communication between outdoor units

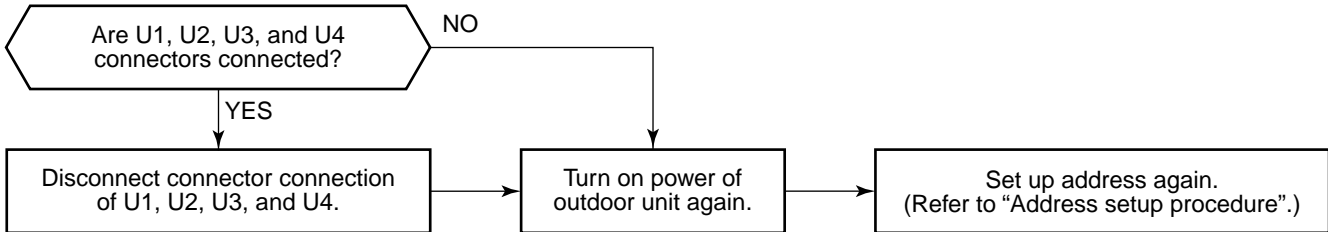

Check code	Check code name	Cause of operation
[E15] / [42] (Current code / AI-NET)	No corresponding indoor unit during automatic address	1. Communication line connection error between indoor and outdoor. 2. Indoor power system error 3. Noise from surrounding devices 4. Power failure 5. Indoor P.C. board error

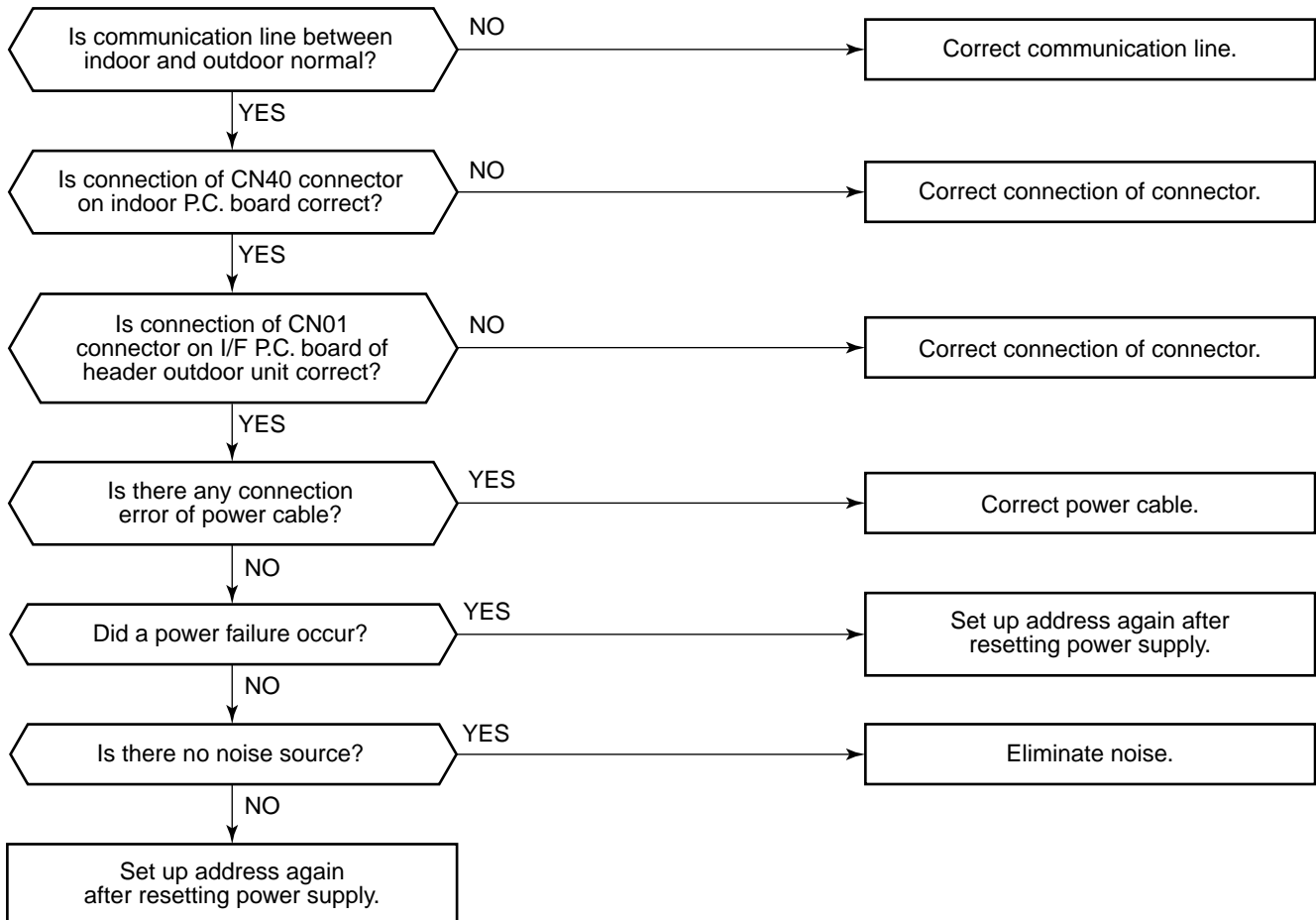

Check code	Check code name	Cause of operation
[E16] / [89] (Current code / AI-NET)	Connected indoor units capacity over	1. There are 48 or more connected indoor units. 2. Capacity over of total connected indoor units. 3. Incorrect setup of indoor/outdoor capacity

Sub-code: 00 : Capacity over 49 to 64 of connected units

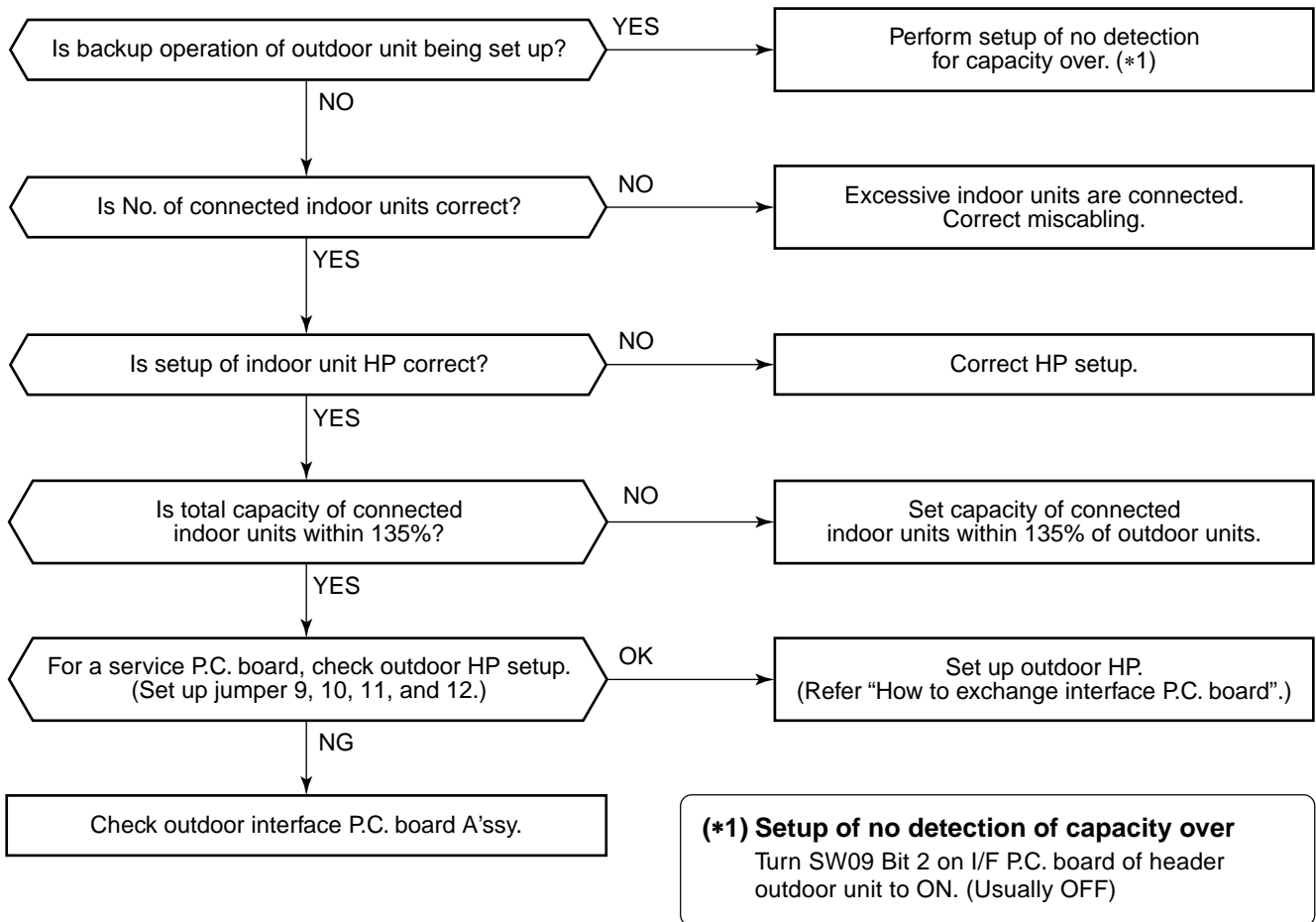

Check code	Check code name	Cause of operation
[E18] / [97/99] (Current code / AI-NET)	Communication error between indoor header and follower	1. Regular communication between indoor header and follower is unavailable. 2. Switch setup error of wall type P.C. board

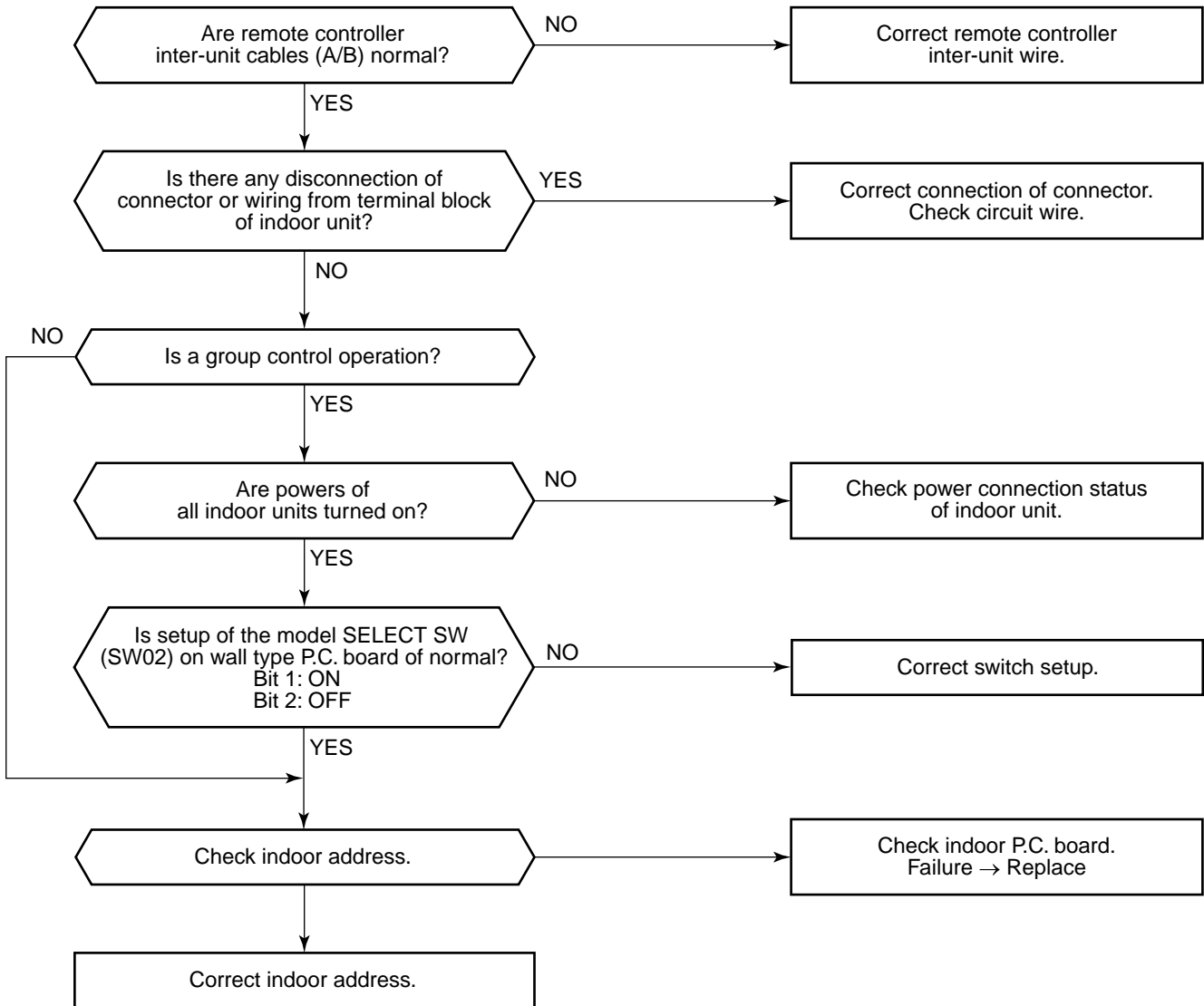

Check code	Check code name	Cause of operation
[E19] / [96] (Current code / AI-NET)	Header outdoor units quantity error	1. Misconnection of inter-unit cable between indoor and outdoor 2. Outdoor I/F P.C. board error

Sub-code: 00: No header unit 02: Two or more header units

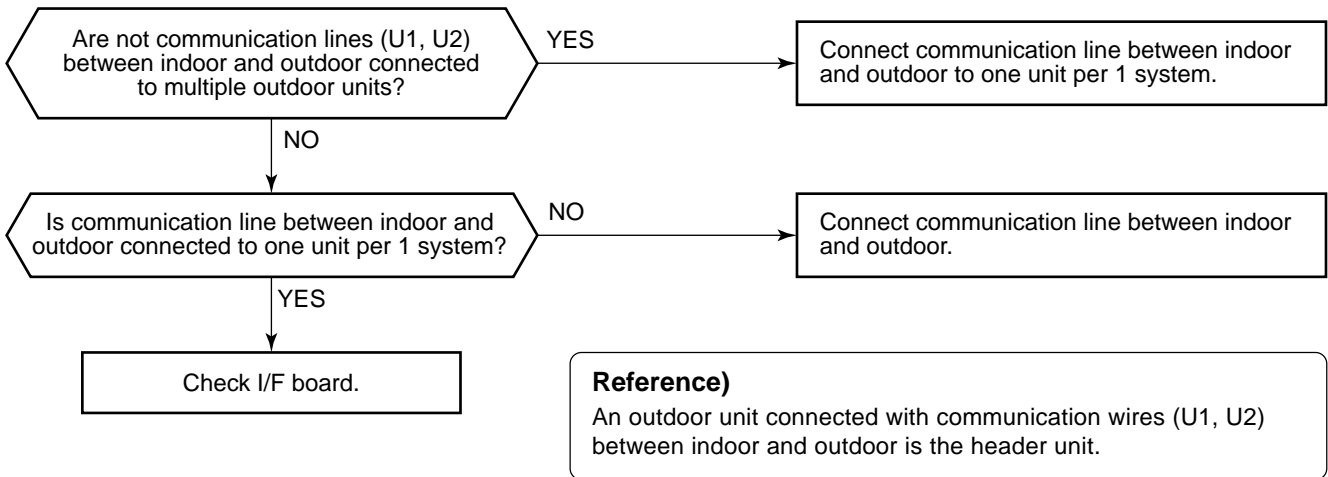

Check code	Check code name	Cause of operation
[E20] / [42] (Current code / AI-NET)	Unit connected to other line during automatic address	When starting automatic indoor address, a device in other line is connected.

Sub-code: 01: Connection of outdoor in other line 02: Connection of indoor unit in other line

Separate the wire between lines according to address setup method.

Check code	Check code name	Cause of operation
[E23] / [15] (Current code / AI-NET)	Communication sending error between outdoor units	1. Inter-unit cable connection error between outdoor units 2. Communication connector connection error between outdoor units, I/F P.C. board error 3. End terminal resistance setup error between outdoor units

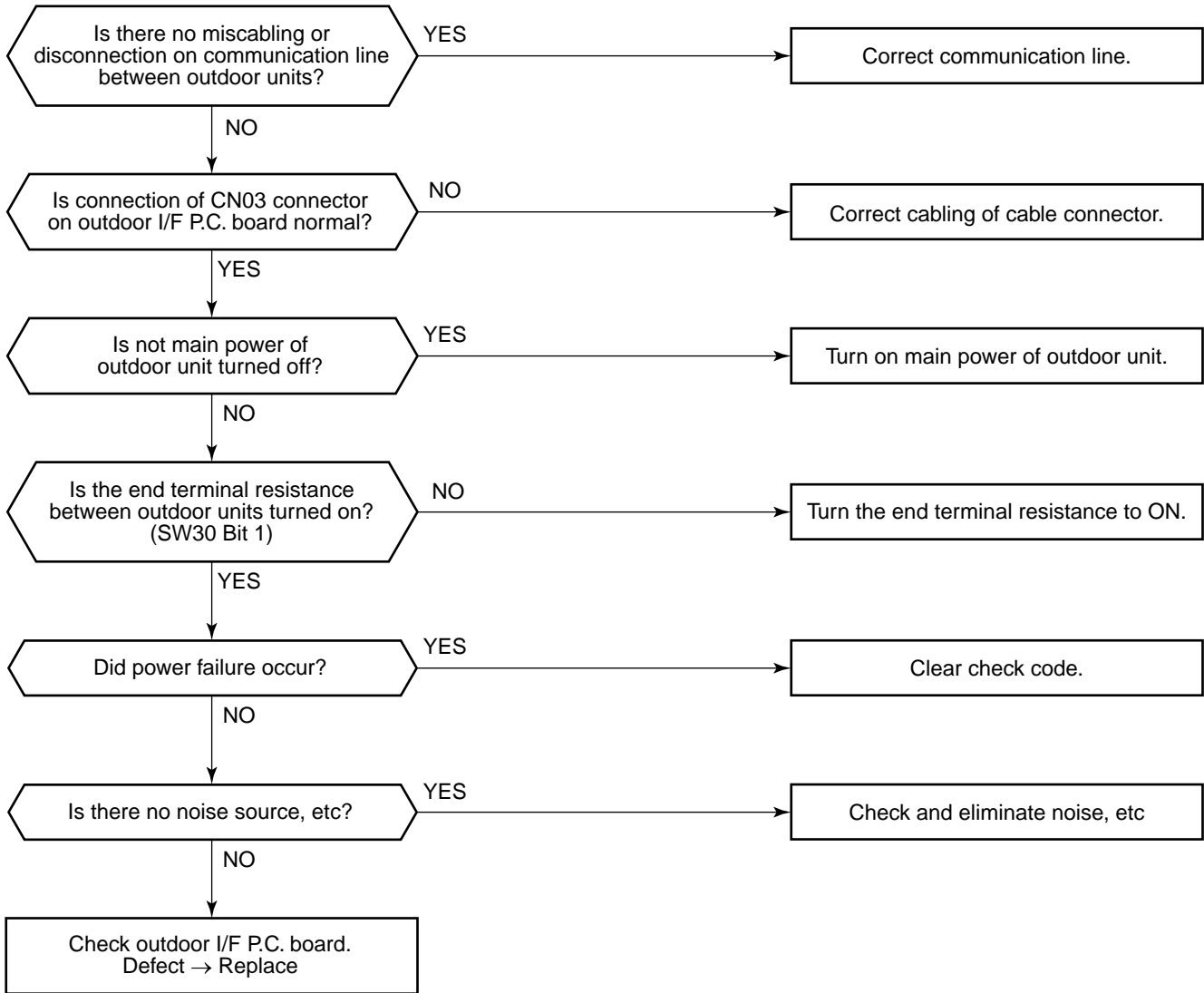

Check code	Check code name	Cause of operation
[E25] / [15] (Current code / AI-NET)	Duplicated follower outdoor address setup	Addresses are duplicated by manual setup of outdoor address

Do not set up outdoor address manually.

Check code	Check code name	Cause of operation
[E26] / [15] (Current code / AI-NET)	Decrease of connected outdoor units	<ol style="list-style-type: none"> 1. Outdoor unit backup setup 2. Outdoor power error 3. Communication line connection error between outdoor units 4. Connector connection error for communication 5. Outdoor I/F P.C. board error

Sub-code: No. of outdoor units which received signals normally

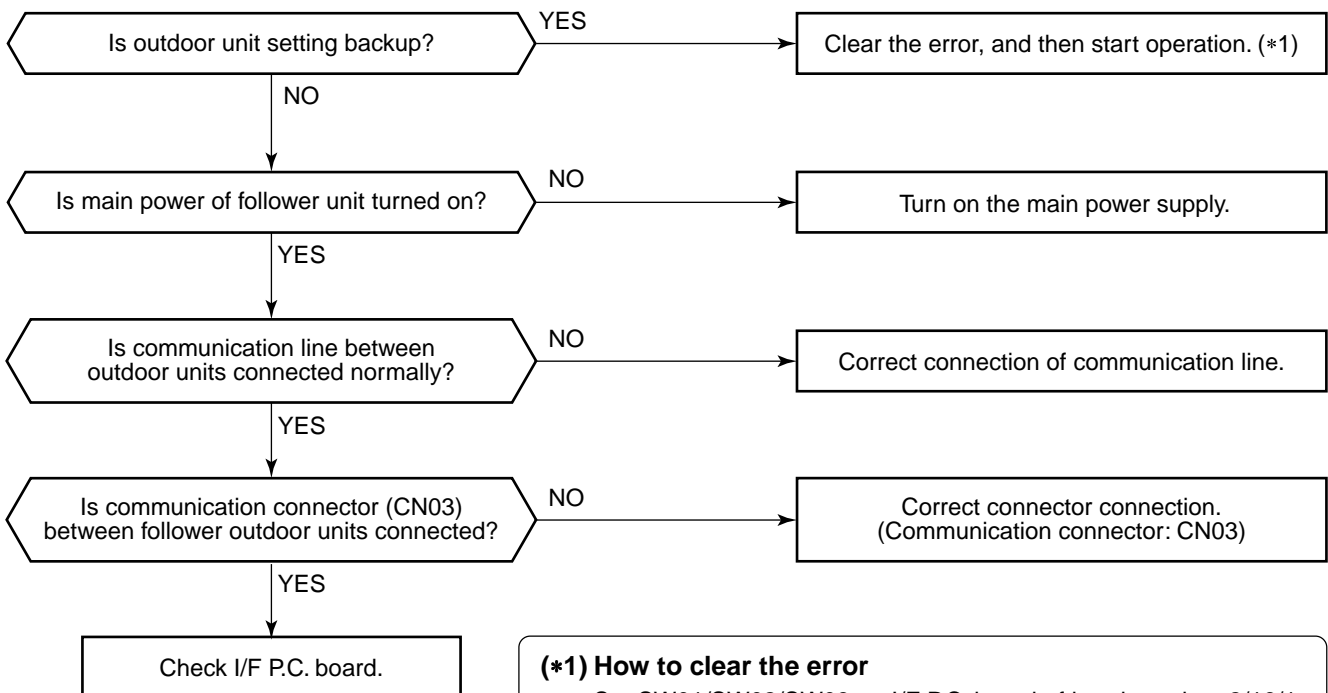

(*1) How to clear the error
 Set SW01/SW02/SW03 on I/F P.C. board of header unit to 2/16/1, and push SW04 for 5 seconds or more.
 (7-segment display: [Er.] [CL])

Check code	Check code name	Cause of operation
[F01] / [0F] (Current code / AI-NET)	Indoor TCJ sensor error	TCJ sensor Open/Short

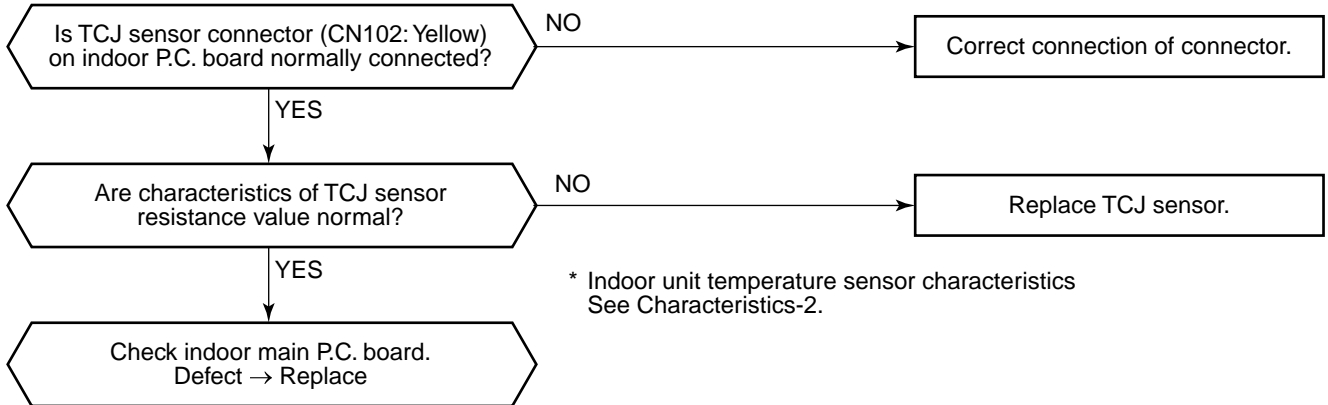

Check code	Check code name	Cause of operation
[F02] / [0d] (Current code / AI-NET)	Indoor TC2 sensor error	TC2 sensor Open/Short

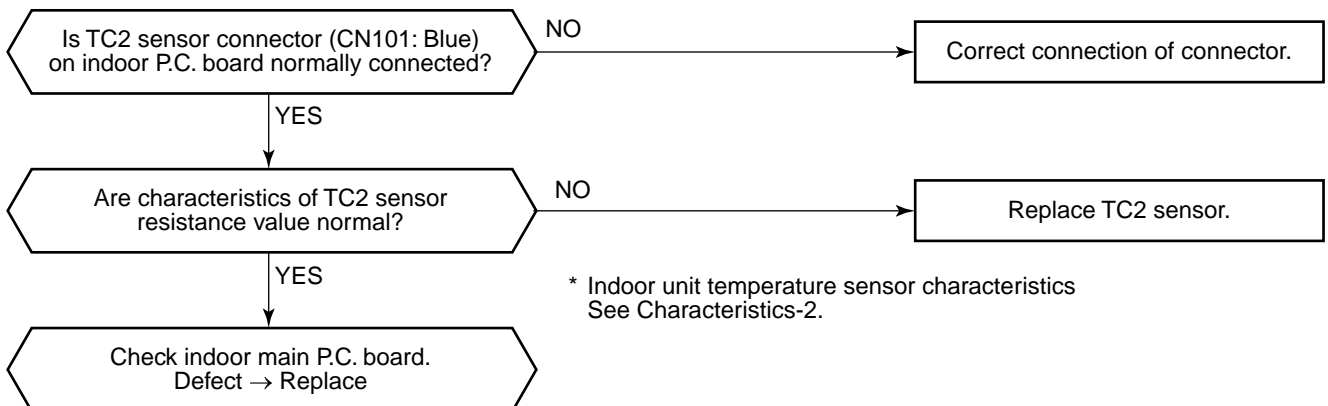

Check code	Check code name	Cause of operation
[F03] / [93] (Current code / AI-NET)	Indoor TC1 sensor error	TC1 sensor Open/Short

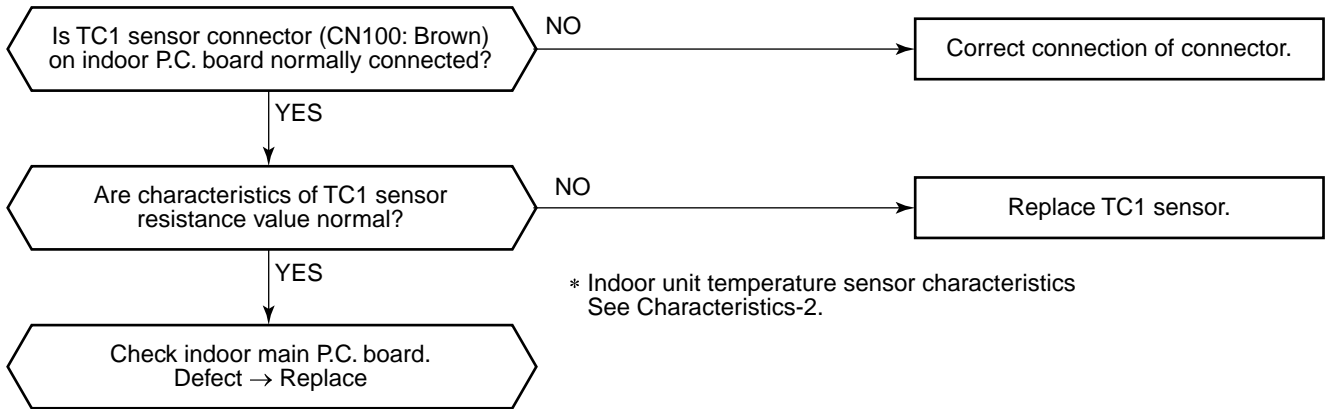

Check code	Check code name	Cause of operation
[F04] / [19] (Current code / AI-NET)	TD1 sensor error	TD1 sensor Open/Short

This error code means detection of Open/Short of TD1 sensor. Check disconnection of circuit for connection of connector (TD1 sensor: CN502, White) and characteristics of sensor resistance value. (Refer to Outdoor unit temperature sensor characteristics.)
If sensor is normal, replace outdoor I/F P.C. board.

Check code	Check code name	Cause of operation
[F05] / [A1] (Current code / AI-NET)	TD2 sensor error	TD2 sensor Open/Short

This error code means detection of Open/Short of TD2 sensor. Check disconnection of circuit for connection of connector (TD2 sensor: CN503, Pink) and characteristics of sensor resistance value. (Refer to Outdoor unit temperature sensor characteristics.)
If sensor is normal, replace outdoor I/F P.C. board.

Check code	Check code name	Cause of operation
[F06] / [18] (Current code / AI-NET)	TE1 sensor error	TE1 sensor Open/Short

This error code means detection of Open/Short of TE1 sensor. Check disconnection of circuit for connection of connector (TE1 sensor: CN505, Green) and characteristics of sensor resistance value. (Refer to Outdoor unit temperature sensor characteristics.)
If sensor is normal, replace outdoor I/F P.C. board.

Check code name	Check code name	Cause of operation
[F07] / [18] (Current code / AI-NET)	TL sensor error	TL sensor Open/Short

This error code means detection of Open/Short of TL sensor. Check disconnection of circuit for connection of connector (TL sensor: CN521, White) and characteristics of sensor resistance value. (Refer to Outdoor unit temperature sensor characteristics.)
If sensor is normal, replace outdoor I/F P.C. board.

Check code name	Check code name	Cause of operation
[F08] / [1b] (Current code / AI-NET)	TO sensor error	TO sensor Open/Short

This error code means detection of Open/Short of TO sensor. Check disconnection of circuit for connection of connector (TO sensor: CN507, Yellow) and characteristics of sensor resistance value. (Refer to Outdoor unit temperature sensor characteristics.)
If sensor is normal, replace outdoor I/F P.C. board.

Check code name	Check code name	Cause of operation
[F10] / [0C] (Current code / AI-NET)	Indoor TA sensor error	TA sensor Open/Short

This error code means detection of Open/Short of TA sensor. Check disconnection of circuit for connection of connector (TA sensor: CN104, White) and characteristics of sensor resistance value. (Refer to Outdoor unit temperature sensor characteristics.)
If sensor is normal, replace indoor P.C. board.

Check code name	Check code name	Cause of operation
[F12] / [A2] (Current code / AI-NET)	TS1 sensor error	TS1 sensor Open/Short

This error code means detection of Open/Short of TS1 sensor. Check disconnection of circuit for connection of connector (TS1 sensor: CN504, White) and characteristics of sensor resistance value. (Refer to Outdoor unit temperature sensor characteristics.)
If sensor is normal, replace outdoor I/F P.C. board.

Check code name	Check code name	Cause of operation
[F13] / [43] (Current code / AI-NET)	TH sensor error	IGBT built-in sensor error in A3-IPDU

Sub-code: 01: Compressor 1 side 02: Compressor 2 side

This error code means IGBT built-in temperature sensor error.
Check connection of connectors CN06 on IPDU P.C. board and CN600 on I/F P.C. board.
If sensor is normal, replace IPDU P.C. board.

Check code name	Check code name	Cause of operation
[F15] / [18] (Current code / AI-NET)	Outdoor temp sensor miscabling (TE1, TL)	<ol style="list-style-type: none"> Misinstallation and misconnection of TE1 sensor and TL sensor Resistance characteristics error of TE1 sensor and TL sensor Outdoor P.C. board (I/F) error

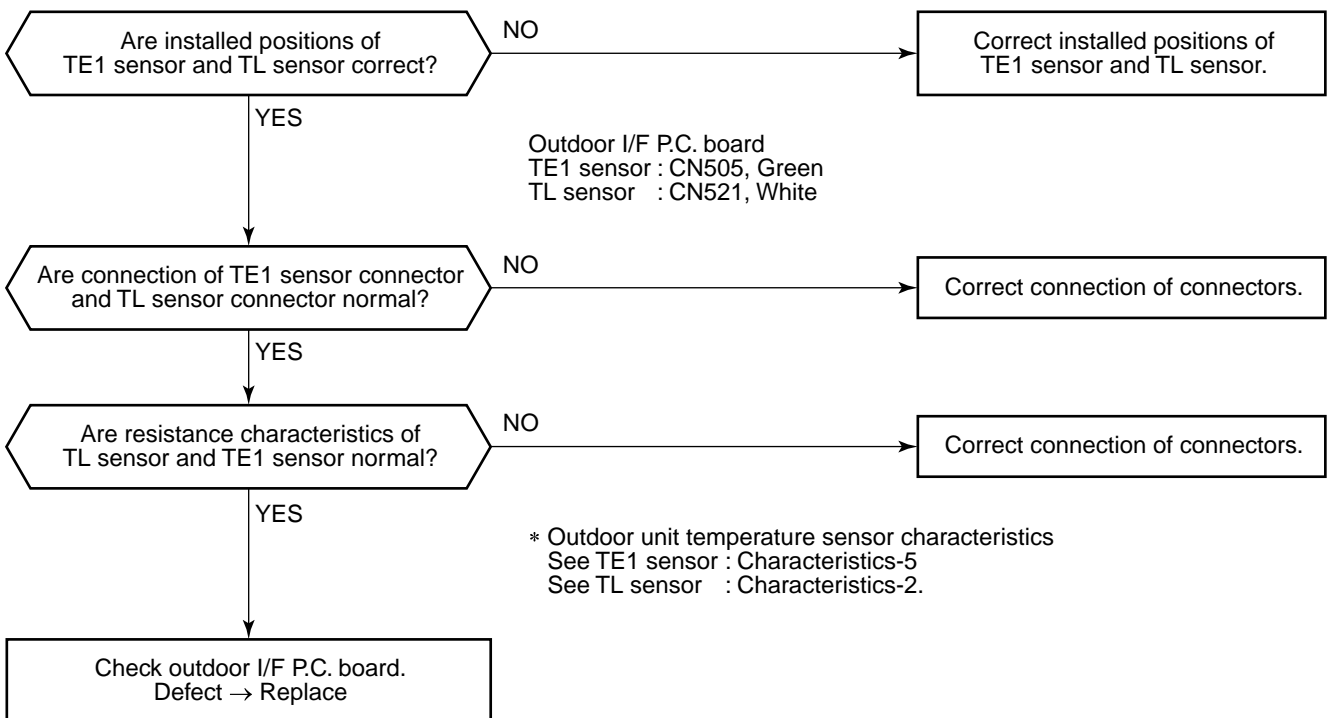

* TE1 sensor : Outdoor heat exchanger temp sensor
TL sensor : Temp sensor between liquid tanks of outdoor PMV1/2

Check code name	Check code name	Cause of operation
[F16] / [43] (Current code / AI-NET)	Outdoor pressure sensor miscabling (Pd, Ps)	1. High-pressure Pd sensor and low-pressure sensor Ps are exchanged. 2. Output voltage of each sensor is zero.

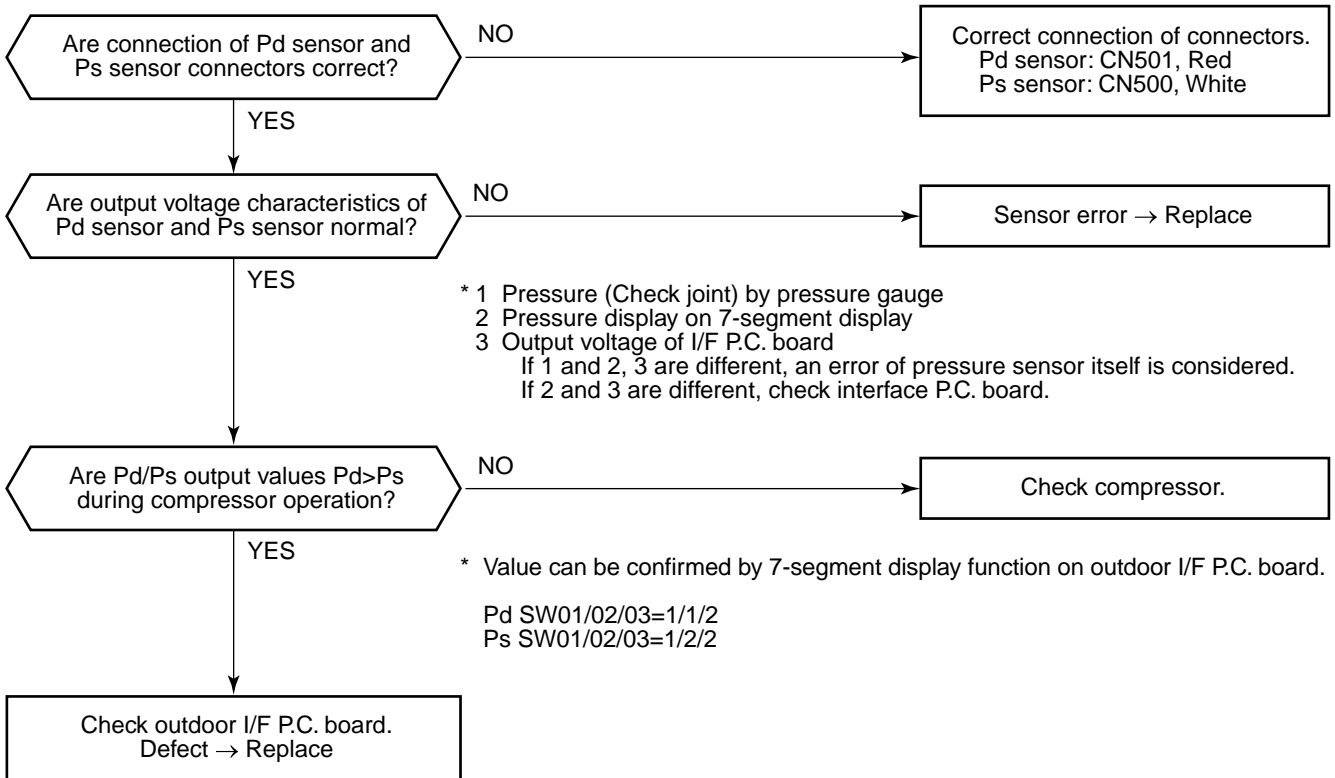

Check code name	Check code name	Cause of operation
[F23] / [43] (Current code / AI-NET)	Ps sensor error	Output voltage error of Ps sensor

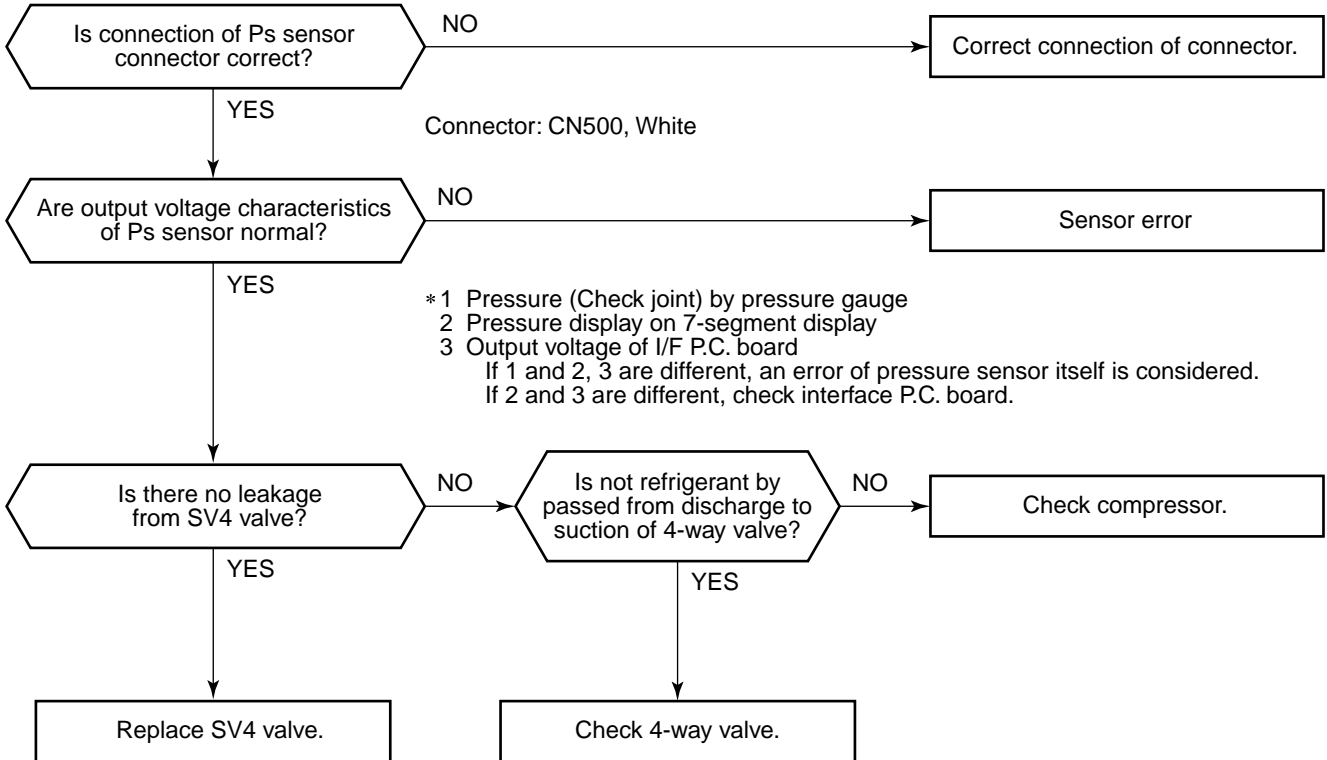

Check code name	Check code name	Cause of operation
[F24] / [43] (Current code / AI-NET)	Pd sensor error	Output voltage error of Pd sensor

It is output voltage error of Pd sensor. Check disconnection of connection of connector (Pd sensor: CN501) circuit and output voltage of sensor.
 If the sensor is normal, replace outdoor I/F P.C. board.

Check code name	Check code name	Cause of operation
[F29] / [12] (Current code / AI-NET)	Indoor other error	Indoor P.C. board error EEROM error

This error is detected during operation of air conditioner of IC10 non-volatile memory (EEPROM) on indoor unit P.C. board. Replace service P.C. board.

* If EEPROM was not inserted when power was turned on or it is absolutely impossible to read/write EEPROM data, the automatic address mode is repeated. In this case, [97 error] is displayed on AI-NET central controller.

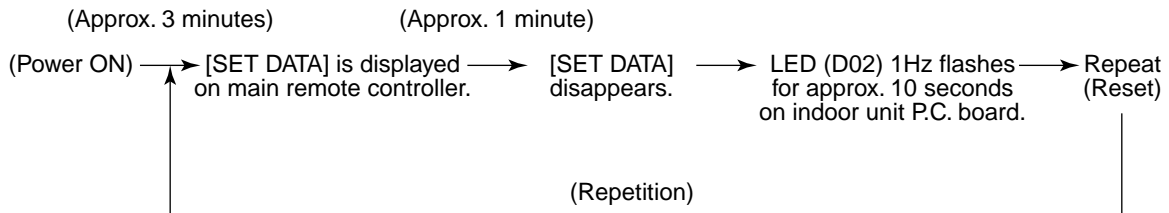

Check code name	Check code name	Cause of operation
[F31] / [1C] (Current code / AI-NET)	Outdoor EEPROM error	1. Outdoor unit power error (Voltage, noise, etc.) 2. Outdoor I/F P.C. board error



Check code name	Check code name	Cause of operation
[H01] / [1F] (Current code / AI-NET)	Compressor breakdown	1. Outdoor unit power line error 2. Compressor circuit system error 3. Compressor error 4. Cause of abnormal overload operation 5. IPDU P.C. board error

Sub-code: 01: Compressor 1 side 02: Compressor 2 side

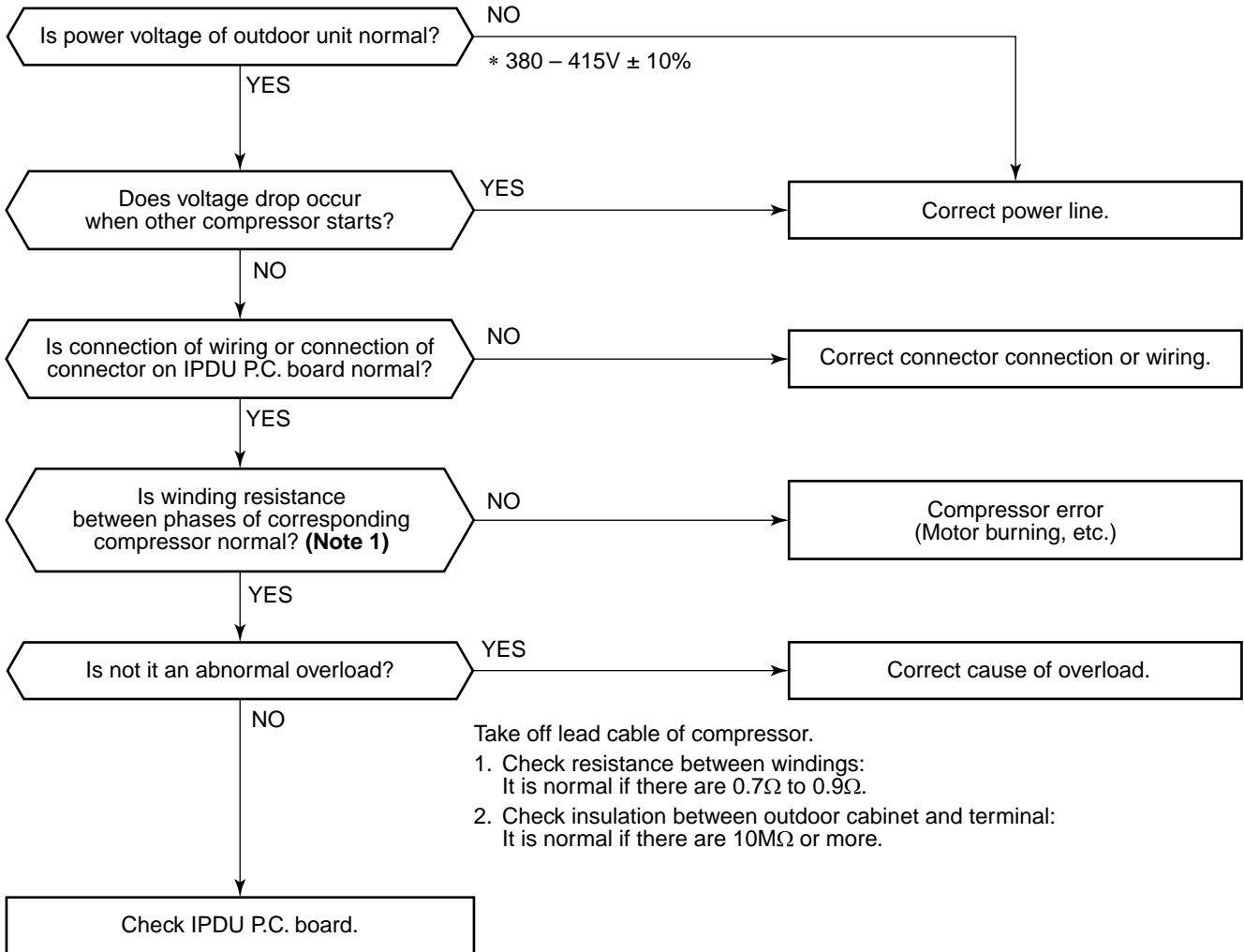

Note 1

* After checking the output, when connecting the compressor lead again to the compressor terminal, check surely there is no distortion on the Fasten receptacle terminal. If it is loosened, caulk it with pinchers, etc and then connect lead to the terminal firmly.

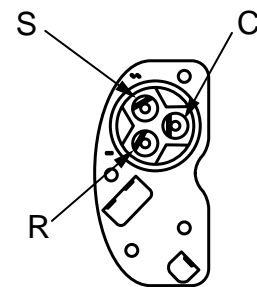

Details of compressor power connecting section

Check code name	Check code name	Cause of operation
[H02] / [1d] (Current code / AI-NET)	Compressor error (Lock)	1. Outdoor unit power line error 2. Compressor circuit system error 3. Compressor error 4. Refrigerant stagnation in compressor shell 5. IPDU P.C. board error

Sub-code: 01: Compressor 1 side 02: Compressor 2 side

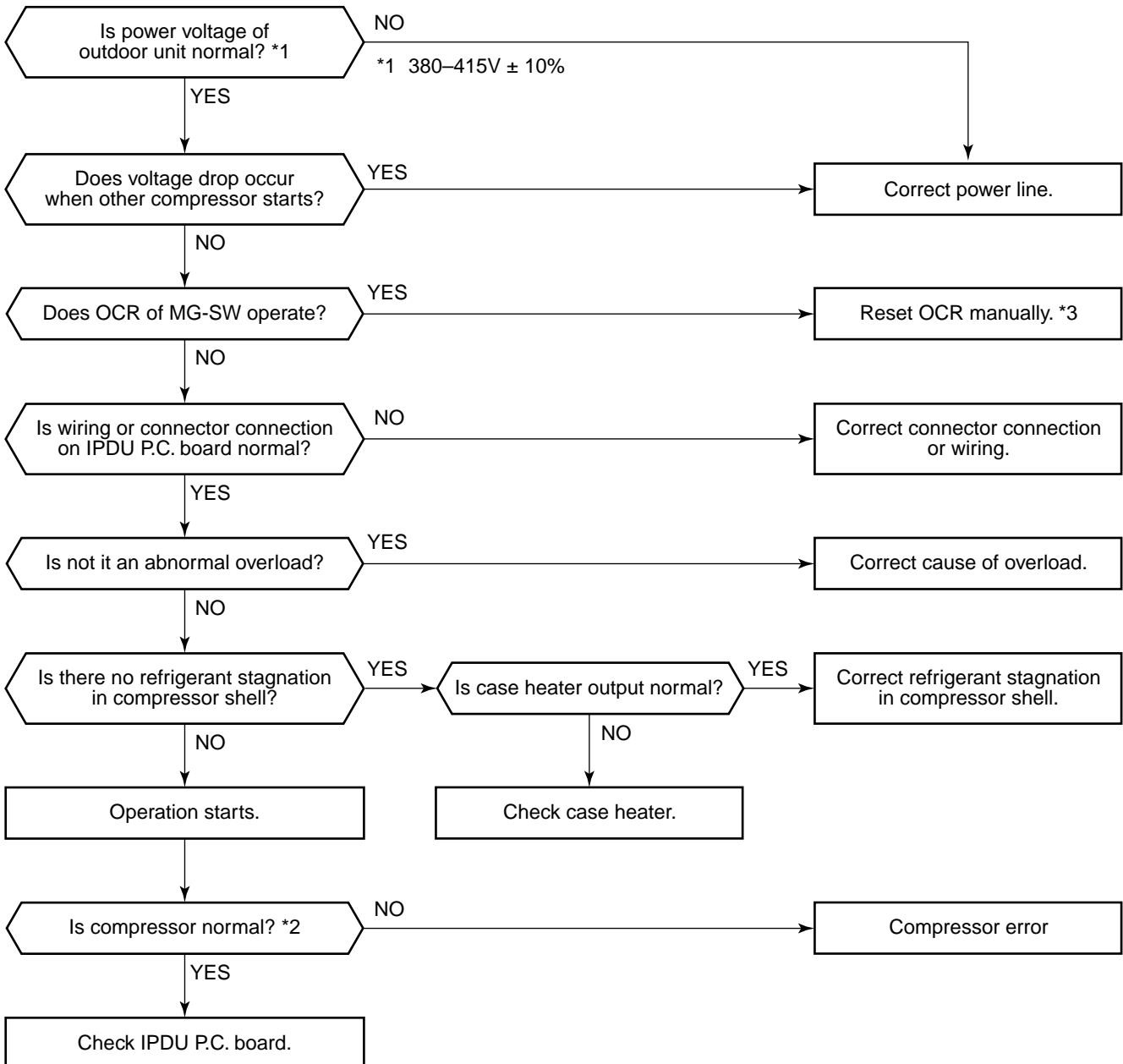

*2 Check the following items mainly.
 1. Existence of abnormal sound and abnormal vibration during operation or starting
 2. Abnormal overheat of case during operation or stop time (Never touch with hands.)
 3. Current of compressor lead during operation or starting time
 (No varied change of current) change

*3 If OCR operates even after manual reset of OCR, check whether the wiring to the current sensor (TO2) of Comp-IPDU is correct or not.

Check code name	Check code name	Cause of operation
[H03] / [17] (Current code / AI-NET)	Current detective circuit system error	1. Cabling or connector connection error on IPDU P.C. board 2. IPDU P.C. board error

Sub-code: 01: Compressor 1 side 02: Compressor 2 side



Check code name	Check code name	Cause of operation
[H04] / [44] (Current code / AI-NET)	Compressor 1 case thermo operation	1. Case thermo circuit error 2. I/F P.C. board error 3. Service valve closed 4. Outdoor PMV clogging 5. SV4 valve leak, Coil misinstallation 6. 4-way valve error 7. Compressor error 8. Refrigerant shortage
[H14] / [44] (Current code / AI-NET)	Compressor 2 case thermo operation	

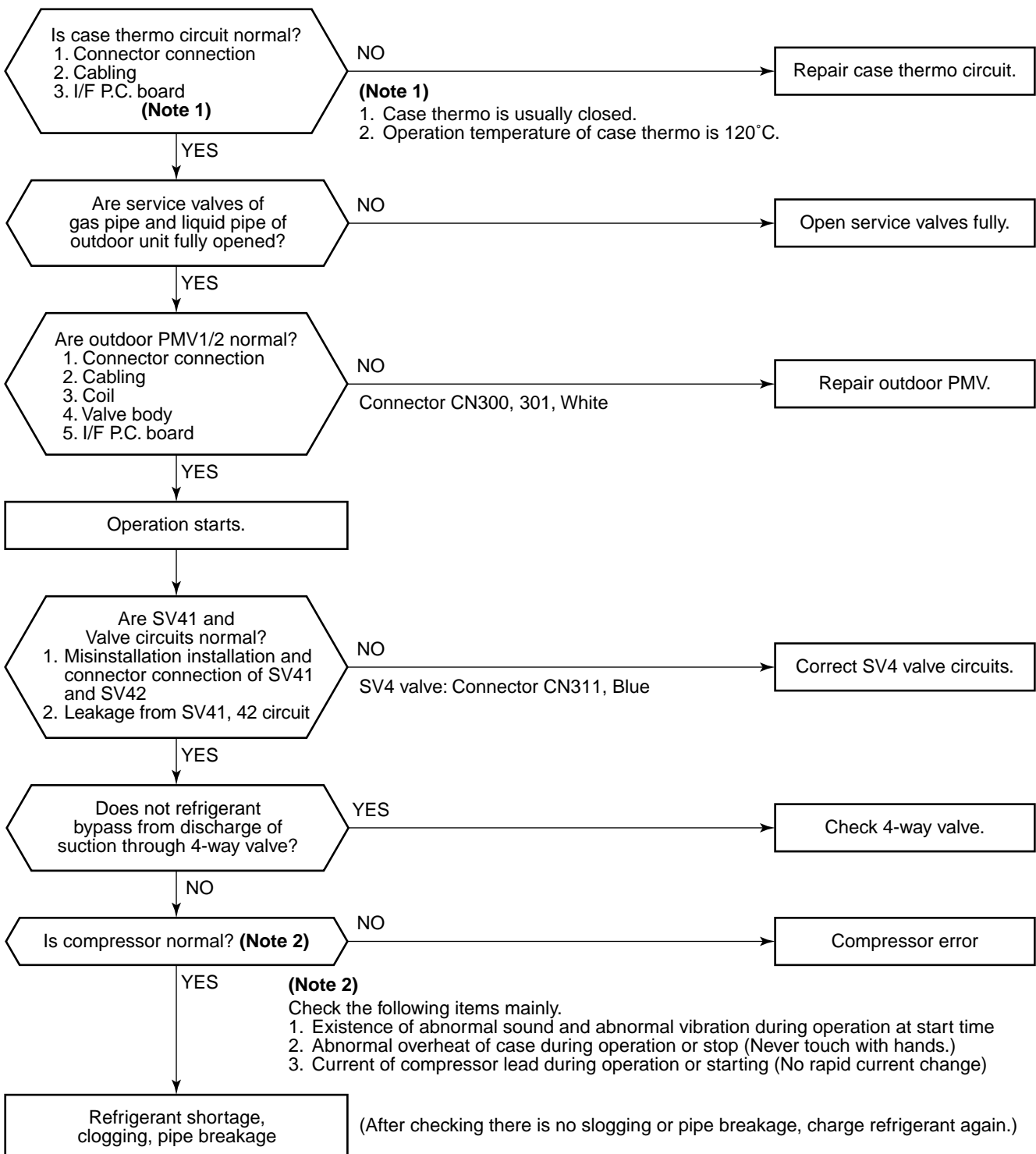

Check code name	Check code name	Cause of operation
[H06] / [20] (Current code / AI-NET)	Low-pressure protective operation	1. Service valve close 2. Ps sensor error 3. SV2, SV4 circuit error 4. Miscabling of communication between indoor and outdoor 5. Indoor/outdoor fan and condenser error 6. Indoor/outdoor PMV clogging 7. Indoor/outdoor heat exchanger clogging 8. Refrigerant shortage

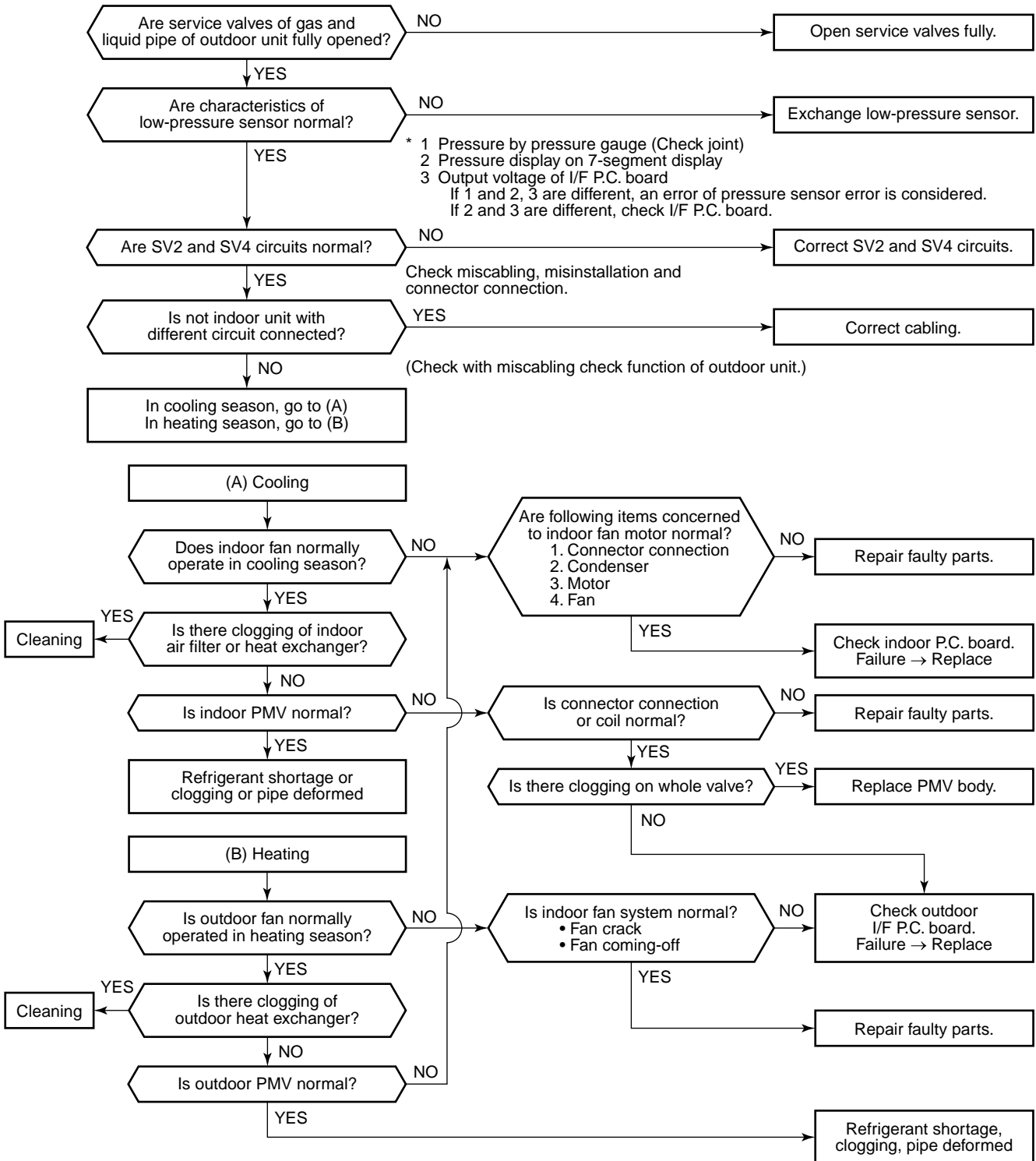

Check code name	Check code name	Cause of operation
[H07] / [d7] (Current code / AI-NET)	Oil level down detection protection	1. Valves of balance pipes closed. 2. Miscabling or misinstallation of TK1 to TK4 sensors 3. TK1 to TK4 sensor error 4. Gas leak or oil leak of all outdoor units 5. Refrigerant stagnation of compressor case 6. SV3A, 3B, 3D, 3C, 3E valve error 7. Clogging of oil return circuit from oil separator 8. Clogging of oil-equalization circuit system

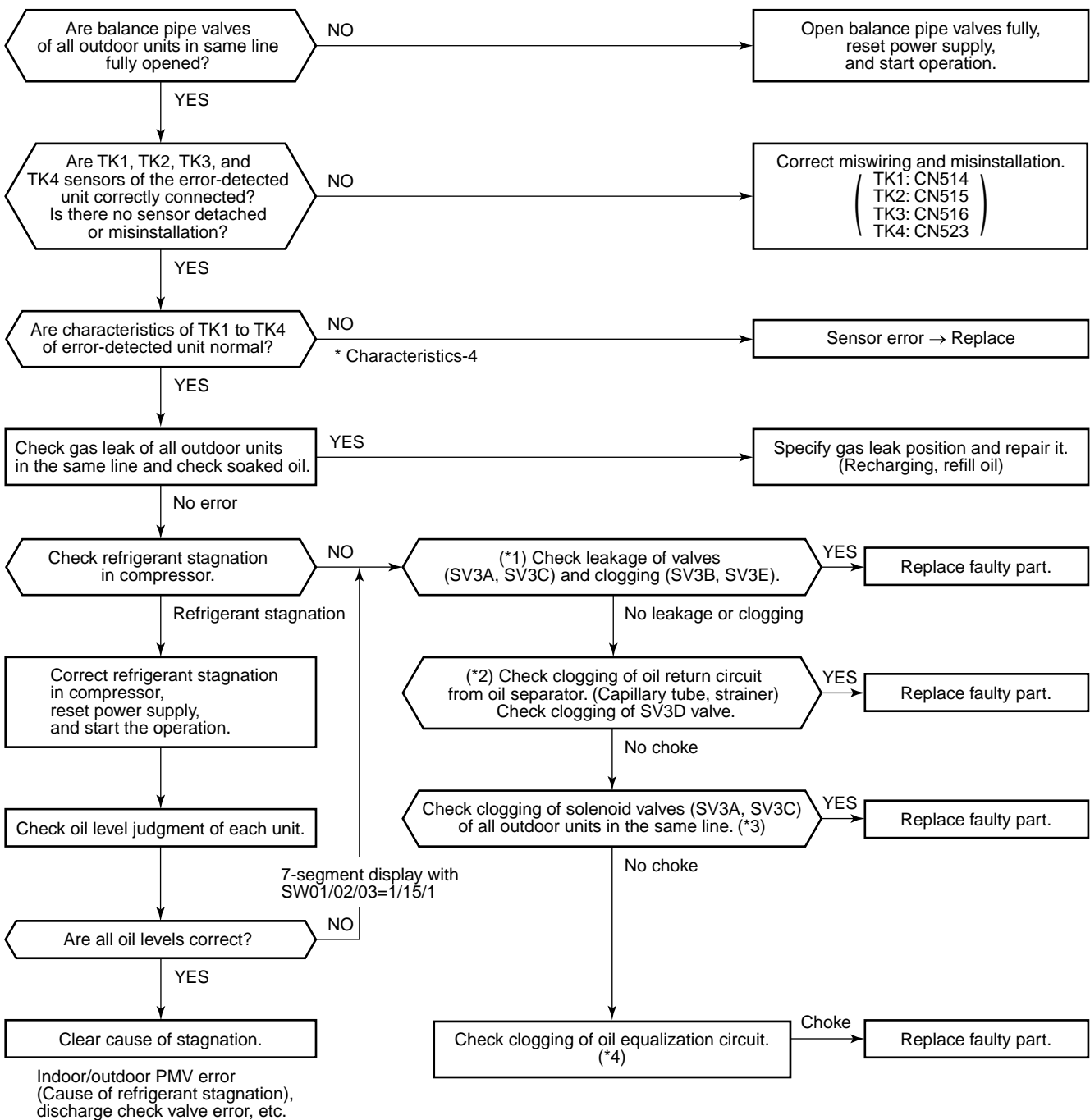

(Reference) When refrigerant stagnates in compressor shell, the oil level shortage may be judged.

In some cases, it may be difficult to check the leakage of clogging in the following condition of refrigerant stagnation in low ambient temperature condition.

In this case, take a longer operating time prior to check.

(Criterion: Discharge temperature of TD1 and TD2 are 60°C or higher)

(*1)

a) Leakage check for SV3A valve (For multiple outdoor unit system)

- Turn off the power supply, take off connector of SV3A valve, and then start a test operation after power-ON.
- Check the temperature change at secondary side of SV3A valve during operation . (① in the figure.)
→ If temperature is raised, it is a leakage of SV3A valve. Replace SV3A valve.

b) Leakage check for SV3C valve

- Turn off the power supply, take off connector of SV3C valve, and then start a test operation after power-ON.
- After operation for several minutes, check temperature at secondary side of SV3C valve. (② in the figure.)
→ If temperature is high (equivalent to discharge temperature TD), it is a leakage of SV3C valve. Replace SV3C valve.
(Even if there is leakage from SV3C valve does not occur, temperature of SV3C valve at secondary side rises during operation. When the checked temperature is equivalent to TD temperature, it is a leakage of SV3C valve. Replace SV3C valve.)

c) Clogging check for SV3B valve (For multiple outdoor unit system)

- While outdoor unit is operated, set up SW01/02/03 = [2] [1] [3] to 7-segment display [Hr] [2], and push SW04 for 2 seconds or more.
- Set up SW02 = [9], and turn on SV3A, SV3B, SV3C valves. (7-segment display [Hr] [3-])
- While outdoor unit is operating, check temperature change at secondary side of SV3B valve. (③ in the figure.)
→ If temperature does not rise (equivalent to suction temperature), it is a clogging of SV3B valve. Replace SV3B valve.

d) Clogging for SV3E valve

Reset the power supply.



Referring to “Valve forced open/close function” of the outdoor unit, check ON/OFF operation (Sound, coil surface temp up) of SV3E valve is performed.



Start test operation in COOL or HEAT mode.



After operation for several minutes, check the pipe temperature at the secondary side of SV3E valve whether temperature changes or not. If it is equivalent to outside temperature, clogging of SV3E is considered. (④ in the figure.)

(Reference)

If SV3E valve is clogged, temperature of all TK1, TK2, TK3, and TK4 do not change.

(*2) Clogging check for SV3D valve of oil return circuit from oil separator

a) Oil return circuit

- While outdoor unit is operating, check temperature (secondary side of capillary) on oil return circuit. (⑤ in the figure.)
→ If temperature is low equivalent to suction temperature), a clogging of strainer of oil return circuit or capillary is considered. Repair the clogged part.

b) Clogging check for SV3D valve

- While outdoor unit is operating, set up SW01/02/03 = [2] [1] [3] to 7-segment display [Hr] [2], and push SW04 for 2 seconds or more.
- Set up SW02 = [6], and turn on SV3D valve. (7-segment display [Hr] [3d])
- If temperature is low at secondary side of the valve or it does not change, clogging of valve, capillary, or strainer is considered. (⑥ in the figure.)

(*3) Check for solenoid valve of outdoor unit (For multiple outdoor unit system)

a) Clogging check for SV3A valve

- While outdoor unit is operating, set up SW01/02/03 = [2] [1] [3] to 7-segment display [Hr] [2], and push SW04 for 2 seconds or more.
- Set up SW02 = [4], and turn on SV3A valve. (7-segment display [Hr] [3A])
- If temperature is low at secondary side of the valve or it does not change, clogging of valve or check valve is considered. (① in the figure.)

b) Leakage check for SV3C valve

- While outdoor unit is operating, set up SW01/02/03 = [2] [1] [3] to 7-segment display [Hr] [2], and push SW04 for 2 seconds or more.
- Set up SW02 = [6], and turn on SV3C valve. (7-segment display [Hr] [3C])
- If temperature does not change (up), clogging of valve or strainer is considered. (② in the figure.)

(*4)

a) Clogging check for oil-equalization circuit

- Drive the outdoor unit. (Drive both compressors in the unit.)
- After driving for 10 minutes, check temperature of TK1 and TK2 sensors and temperature of oil-equalization circuit capillary (⑦ in the figure) were raised.

(Criterion)

TK1, TK2=TD1, TD2 temperature – Approx. 10 to 30°C

Oil-equalization capillary tubes should be higher sufficiently than outside air temperature and suction temperature.

- If temperature is low, a malfunction of capillary, strainer, or check valve is considered. Repair the defective parts.

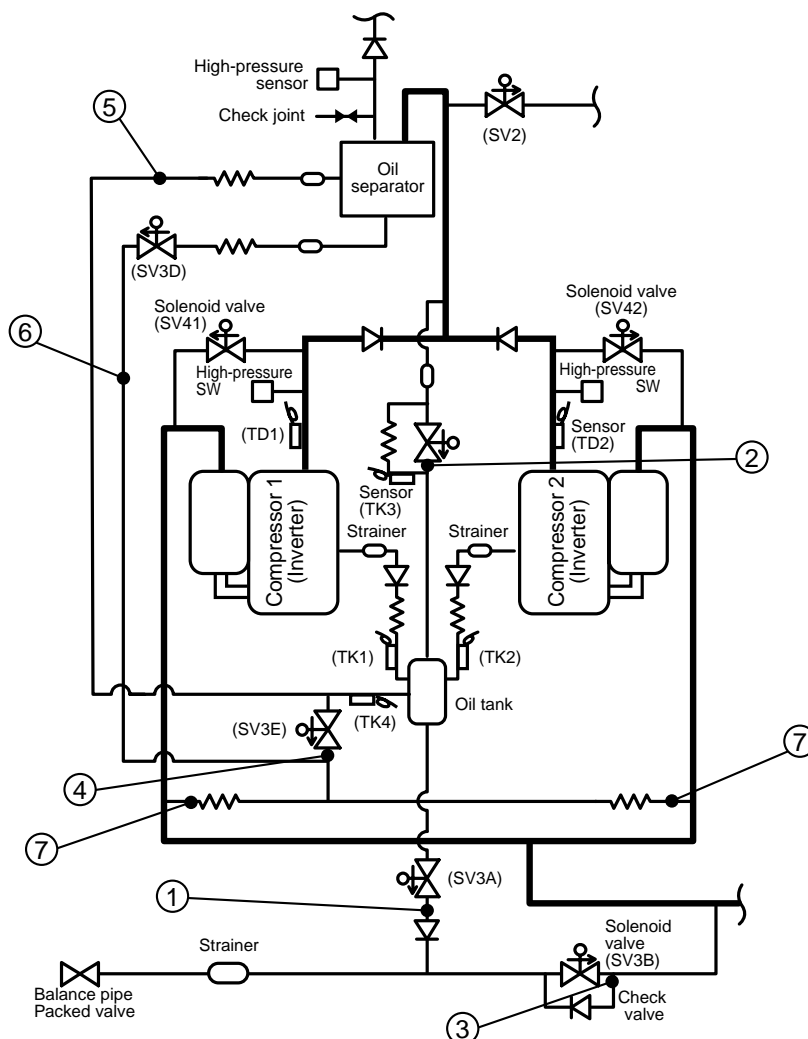

Check code name	Check code name	Cause of operation
[H08] / [d4] (Current code / AI-NET)	Oil level detective temperature sensor error	TK1 to TK4 sensor Open/Short

Sub-code: 01: TK1 sensor error 02: TK2 sensor error 03: TK3 sensor error 04: TK4 sensor error

The detected error is an oil level detective temperature sensor error. Check disconnection of the wiring and resistance value of the sensor. If the sensors are normal, replace the outdoor I/F P.C. board.

Circuit	Connector
TK1	CN514 (Black)
TK2	CN515 (Green)
TK3	CN516 (Red)
TK4	CN523 (Yellow)

Check code name	Check code name	Cause of operation
[H16] / [d7] (Current code / AI-NET)	TK1 temperature detective circuit error (Sub-code: 01)	<ol style="list-style-type: none"> Coming-off of TK1 sensor, miscabling, characteristics error of resistance value Oil-equalization circuit error (Check valve, capillary clogging, strainer clogging) Refrigerant stagnation in case of compressor shell

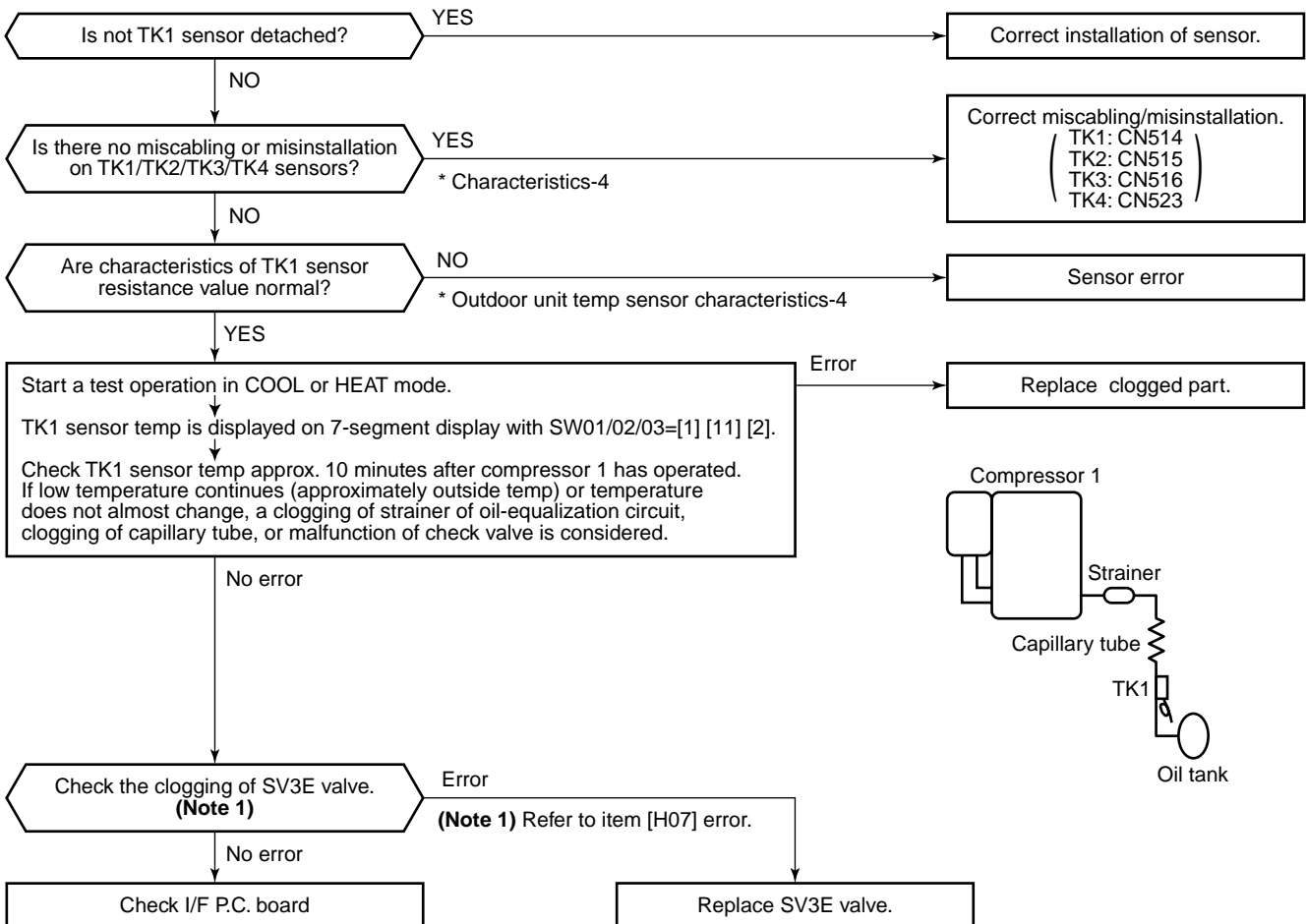

Check code name	Check code name	Cause of operation
[H16] / [d7] (Current code / AI-NET)	Oil level detective circuit system error (Sub-code: 02)	1. Detachment of TK2 sensor, miscabling, characteristics error of resistance value 2. Oil-equalization circuit error (Check valve, capillary clogging, strainer clogging) 3. Refrigerant stagnation in compressor shell

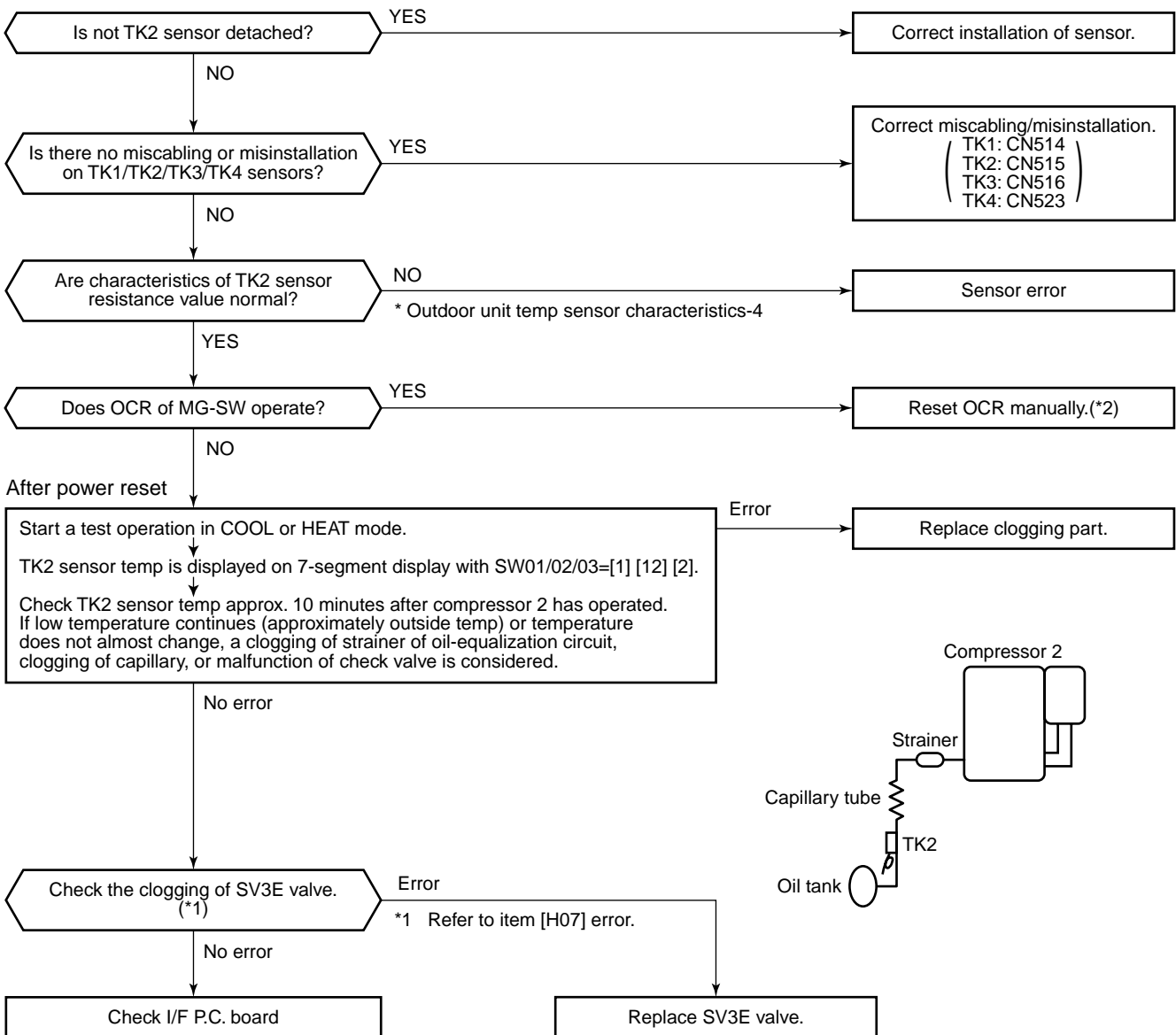

*2 If OCR operates even after manual reset of OCR, check whether the wiring to the current sensor (TO2) of Comp-IPDU is correct or not.

Check code name	Check code name	Cause of operation
[H16] / [d7] (Current code / AI-NET)	TK3 temperature detective circuit error (Sub-code: 03)	1. Detachment of TK3 sensor, miscabling, characteristics error of resistance value 2. Error of SV3C valve circuit periphery (Check capillary clogging, strainer clogging) 3. Refrigerant stagnation in compressor shell

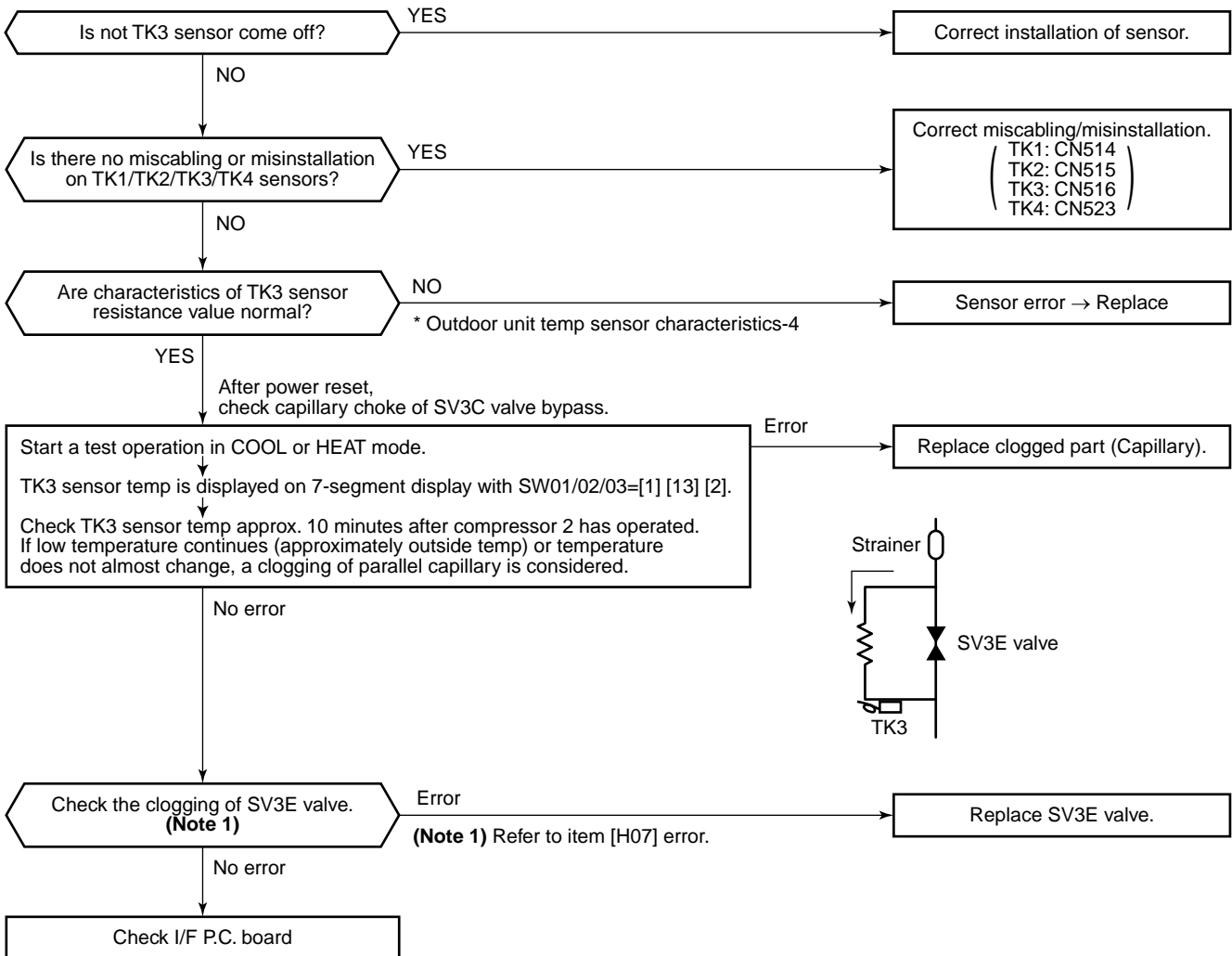

Check code name	Check code name	Cause of operation
[H16] / [d7] (Current code / AI-NET)	TK4 temperature detective circuit error (Sub-code: 04)	1. Detachment of TK4 sensor, miscabling, characteristics error of resistance value 2. Check clogging and malfunction of SV3E valve circuit. 3. Oil-equalization circuit error (Check capillary clogging, strainer clogging) 4. Refrigerant stagnation in compressor shell

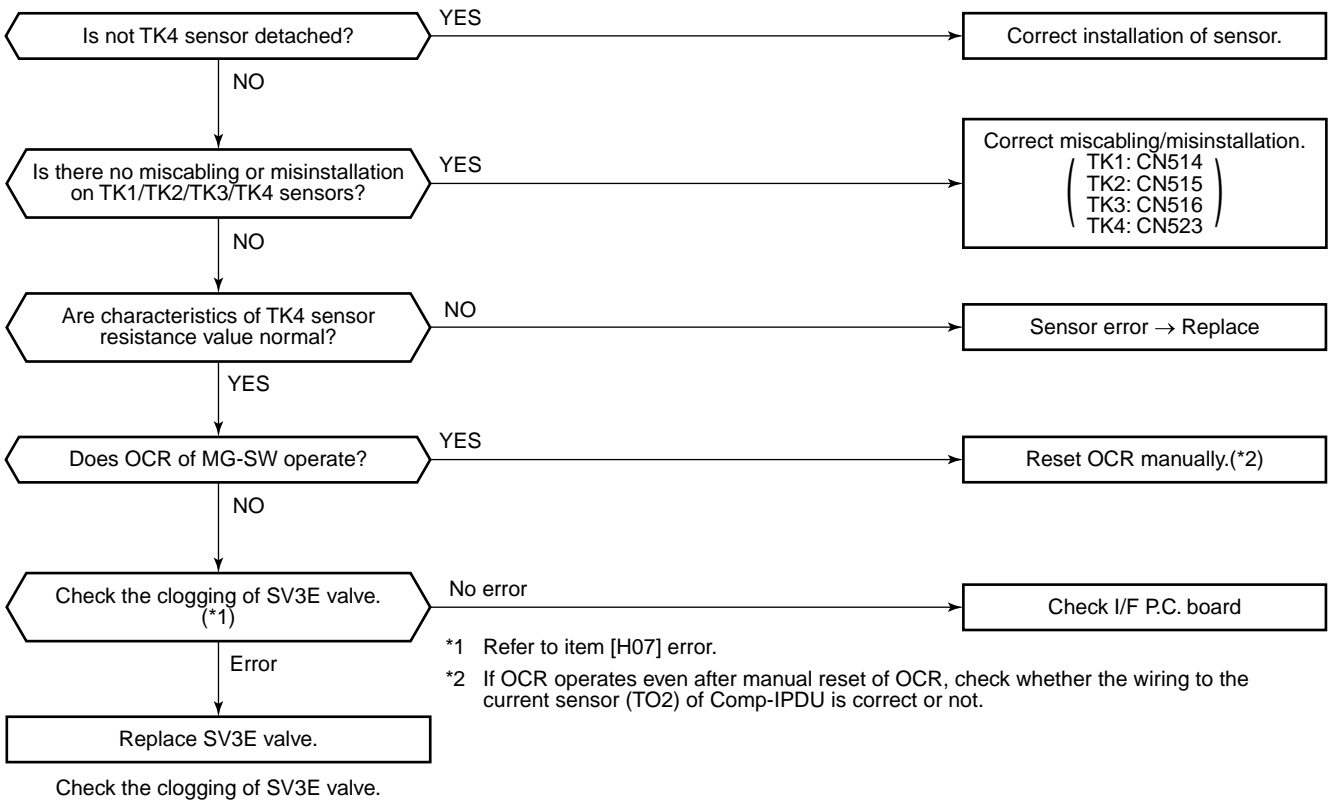

Check code name	Check code name	Cause of operation
[L03] / [96] (Current code / AI-NET)	Duplicated indoor header units	There were two or more indoor header units in some remote controller group control.

- 1) Check the connection changing of the remote controller after the connection has been changed.
 2) If the group configuration and address are normal when power has been turned on, the mode automatically shifts to address setup mode. (Re-setup of address) → Refer to “Address setup”.

Check code name	Check code name	Cause of operation
[L04] / [96] (Current code / AI-NET)	Duplicated setup of outdoor line address	Outdoor line addresses are duplicated.

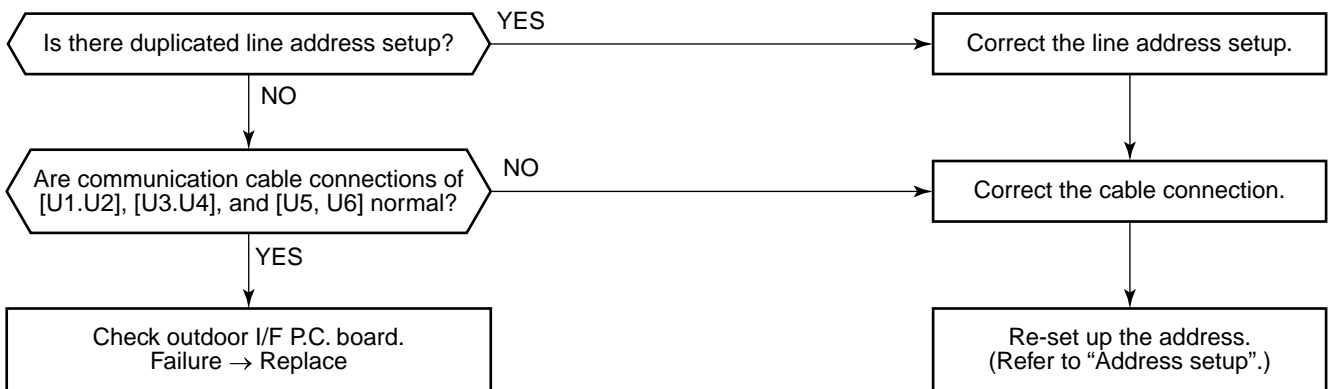

Check code name	Check code name	Cause of operation
[L05] / [96] (Current code / AI-NET)	Duplicated indoor units with priority (Displayed on indoor unit with priority)	1. Two or more prior indoor units exist.

- This check code is displayed on the set indoor unit when setup of indoor unit with priority is duplicated.
- Priority setup with two or more units is not available. Choose one prior unit in one refrigerant circuit system.

Check code name	Check code name	Cause of operation
[L06] / [96] (Current code / AI-NET)	Duplicated indoor units with priority (Displayed on the indoor unit other than one with priority and on the outdoor unit)	Two or more indoor units with priority are duplicated.

Sub-code: No. of indoor units with priority

When indoor unit with priority is duplicated, this check code is displayed on the unit other than the setup indoor unit and outdoor unit.

- As only one indoor unit with priority is valid, change the setup.

Check code name	Check code name	Cause of operation
[L07] / [99] (Current code / AI-NET)	Group line in individual indoor unit	The group line is connected in the individual indoor unit.

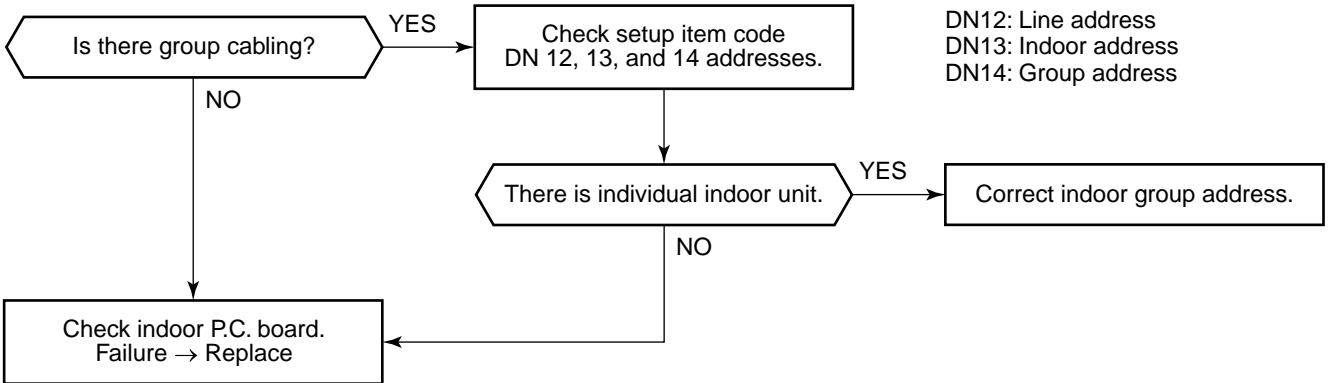

Check code name	Check code name	Cause of operation
[L08] / [99]* (Current code / AI-NET)	Indoor group / address unset	Indoor address unset

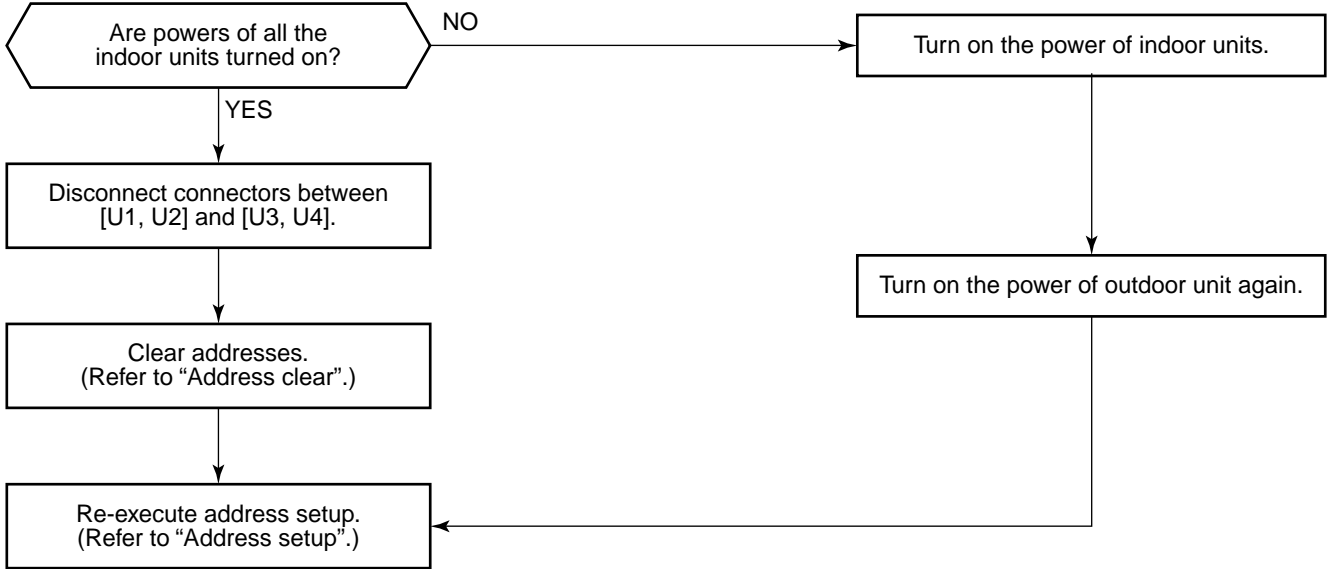

Note) This code is displayed when the power is turned on at the first time after installation. (Because the address is not yet set up)

Check code name	Check code name	Cause of operation
[L09] / [46] (Current code / AI-NET)	Indoor capacity unset	Indoor capacity unset

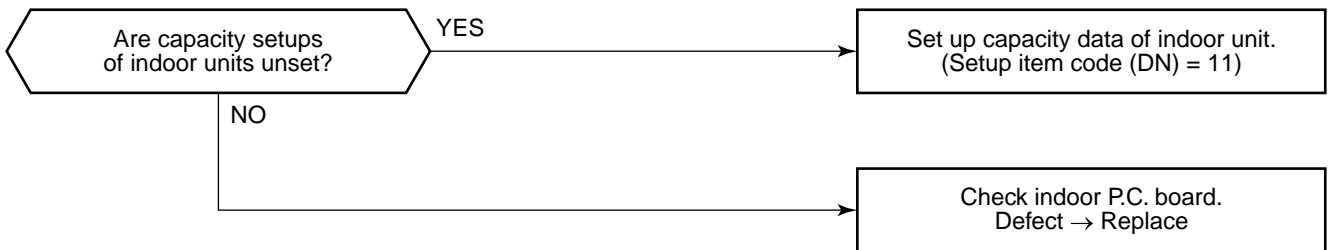

Check code name	Check code name	Cause of operation
[L10] / [88] (Current code / AI-NET)	Outdoor capacity unset	On the outdoor I/F P.C. board for service, the model selecting jumper has not been set up so as to match with the model.

I/F P.C. board A'ssy service for the outdoor unit is common to this series. A setup for model selection different from that for P.C. board with trouble is necessary. Set up a model based upon the P.C. board A'ssy exchange procedure.

Check code name	Check code name	Cause of operation
[L20] / [98] (Current code / AI-NET)	Duplicated central control addresses	Central control addresses are duplicated.



Check code name	Check code name	Cause of operation
[L28] / [46] (Current code / AI-NET)	Quantity over of connected outdoor units	<ol style="list-style-type: none"> Quantity over of connected outdoor units. Connection error of communication line between outdoor units Outdoor I/F P.C. board error

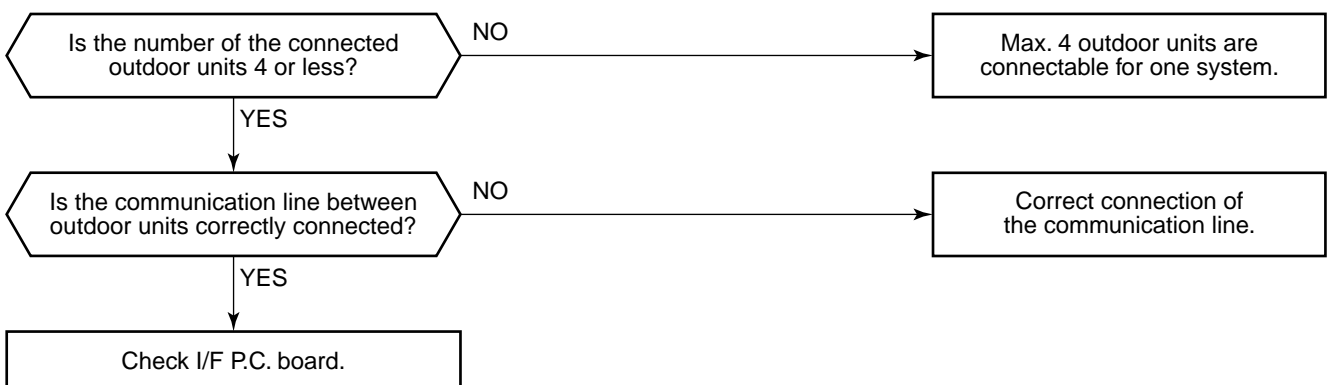

Check code name	Check code name	Cause of operation
[L30] / [b6] (Current code / AI-NET)	Interlock in indoor unit from outside	Outside error was input.

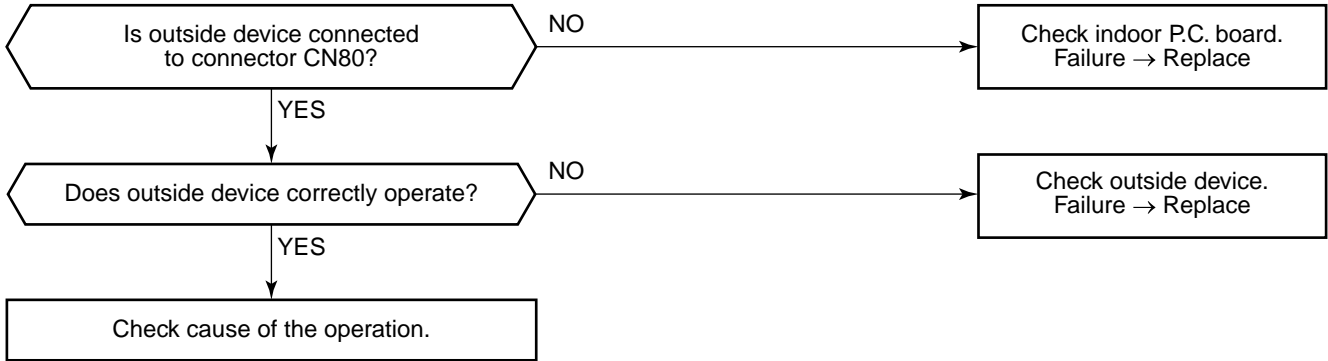

Check code name	Check code name	Cause of operation
[L31] / [-] (Current code / AI-NET)	Extended IC error	1. Outdoor unit power error 2. Outdoor I/F P.C. board error

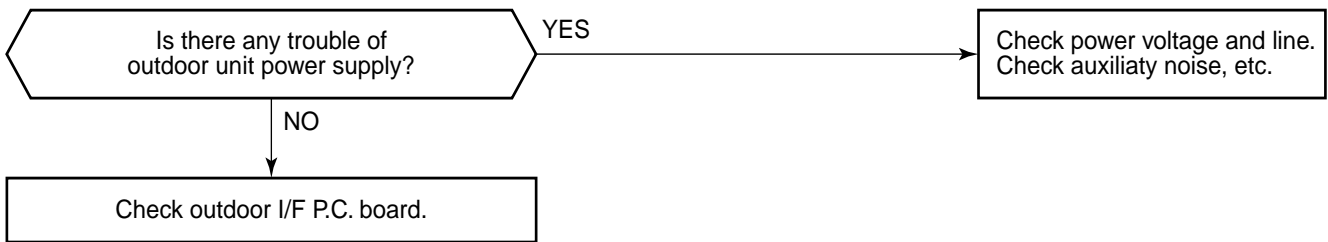

Check code name	Check code name	Cause of operation
[P03] / [1E] (Current code / AI-NET)	Discharge temp TD1 error	1. Service valve of outdoor unit closed 2. Outdoor PMV error 3. TD sensor error 4. Refrigerant shortage, clogging of refrigerant circuit system 5. 4-way valve error 6. SV4 circuit leakage, misinstallation

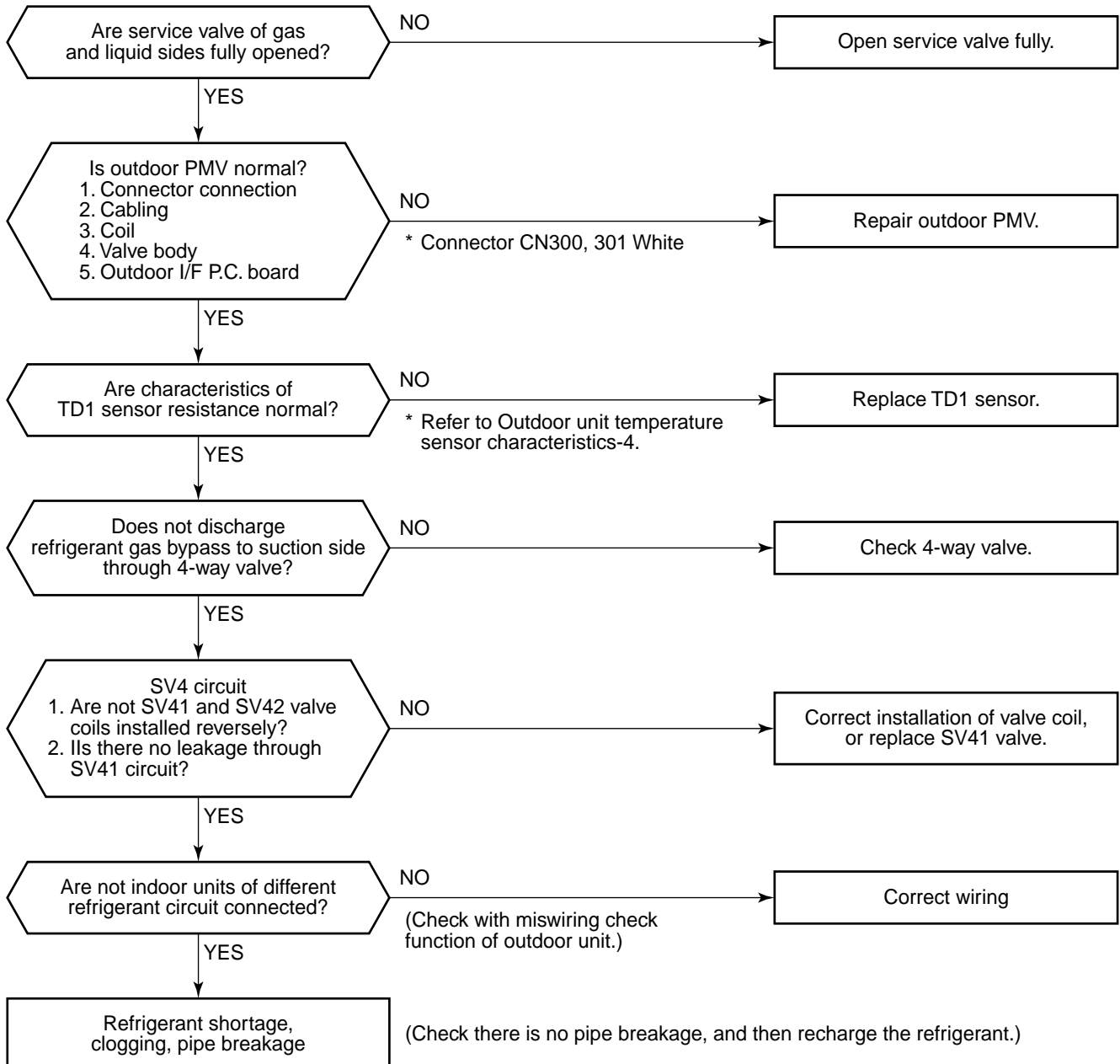

Check code name	Check code name	Cause of operation
[P04] / [21] (Current code / AI-NET)	Actuation of high-pressure SW	1. High-pressure SW error 2. Service valve closed 3. Pd sensor error 4. Indoor/outdoor fan error 5. Indoor/outdoor PMV choke 6. Indoor/outdoor heat exchanger clogging, air short circuit 7. SV2 circuit error 8. SV4 circuit error 9. SV5 circuit error 10. Discharge line check valve malfunction 11. Refrigerant overcharge

Sub-code: 01: Compressor 1 side 02: Compressor 2 side

Note) High-pressure SW is normally closed.
(B contact)

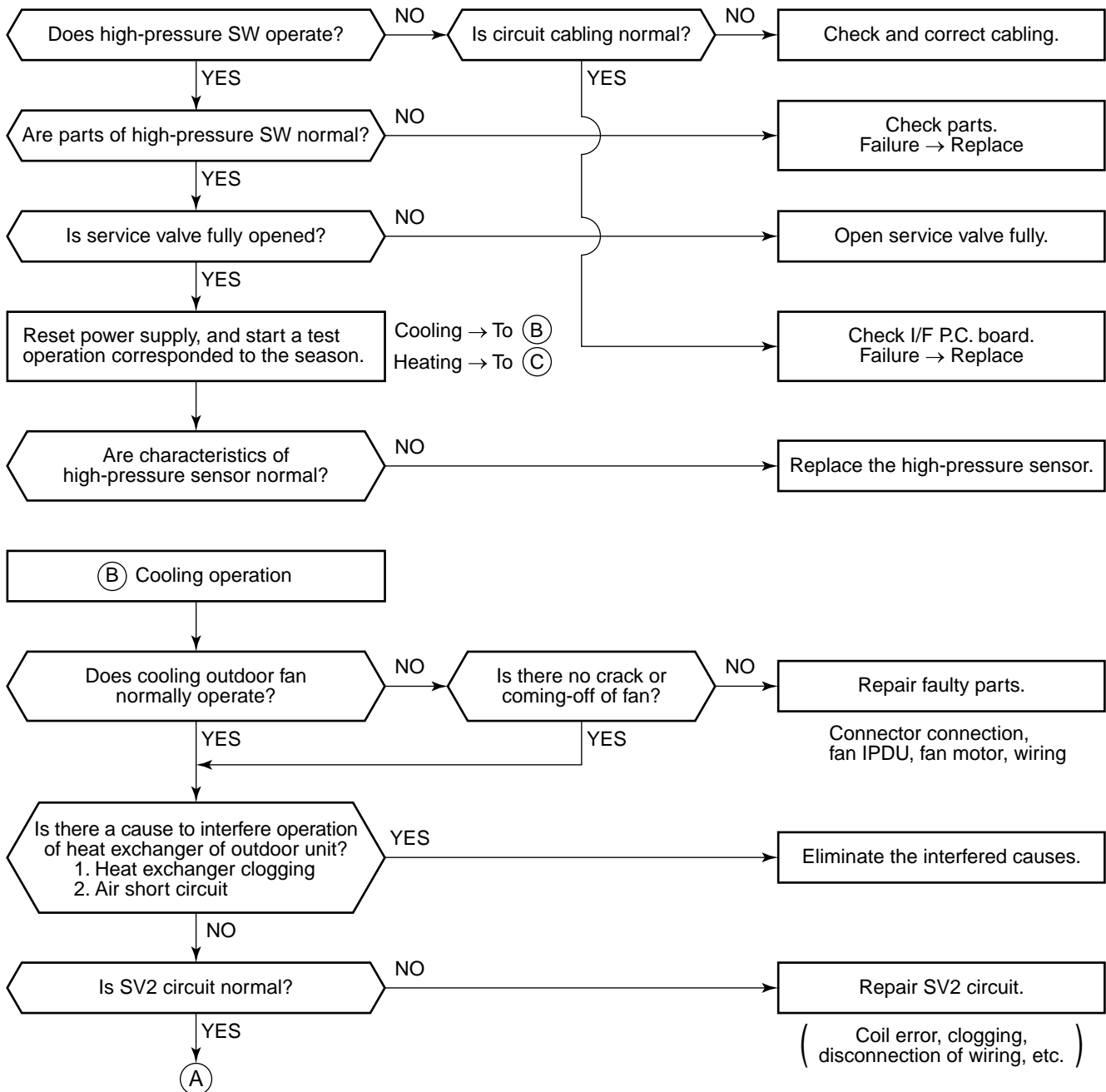

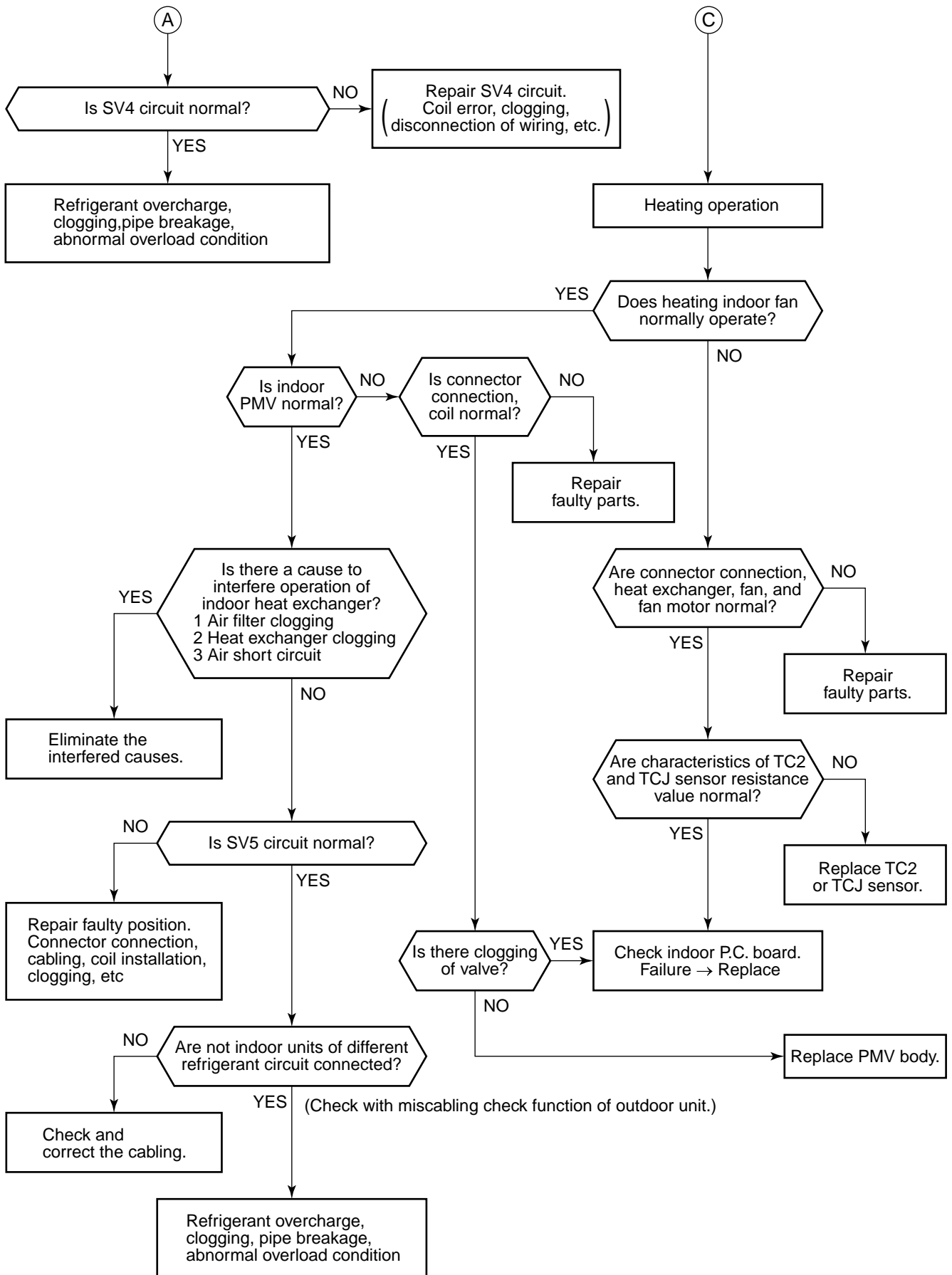

Check code name	Check code name	Cause of operation
[P05] / [AF] (Current code / AI-NET)	Open phase, negative phase	1. Power supply open phase 2. Power supply negative phase

- Check the phase power line of outdoor unit.
- Check error of outdoor I/F P.C. board.
- Check there is no looseness, etc of terminal.

Check code name	Check code name	Cause of operation
[P07] / [1C] (Current code / AI-NET)	Heat sink overheat error	1. Power voltage error 2. Outdoor fan system error 3. Heat sink installation error 4. Clogging of hear sink cooling duct 5. IPDU P.C. board error (TH sensor error)

Sub-code: 01: Compressor 1 side 02: Compressor 2 side

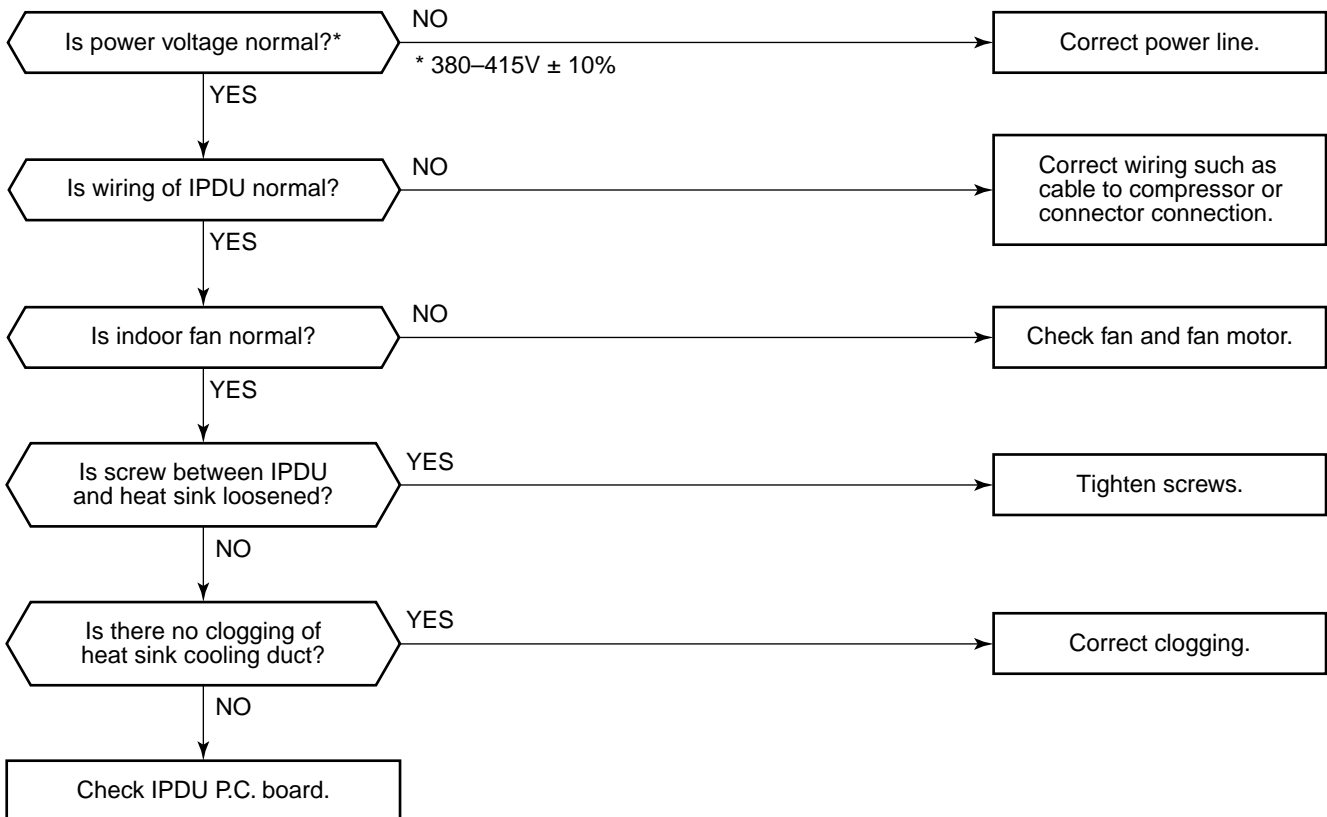

Check code name	Check code name	Cause of operation
[P12] / [11] (Current code / AI-NET)	Indoor fan motor error	1. Fan motor connector error 2. Fan motor error 3. Indoor P.C. board error 4. Cross-flow fan bearing error

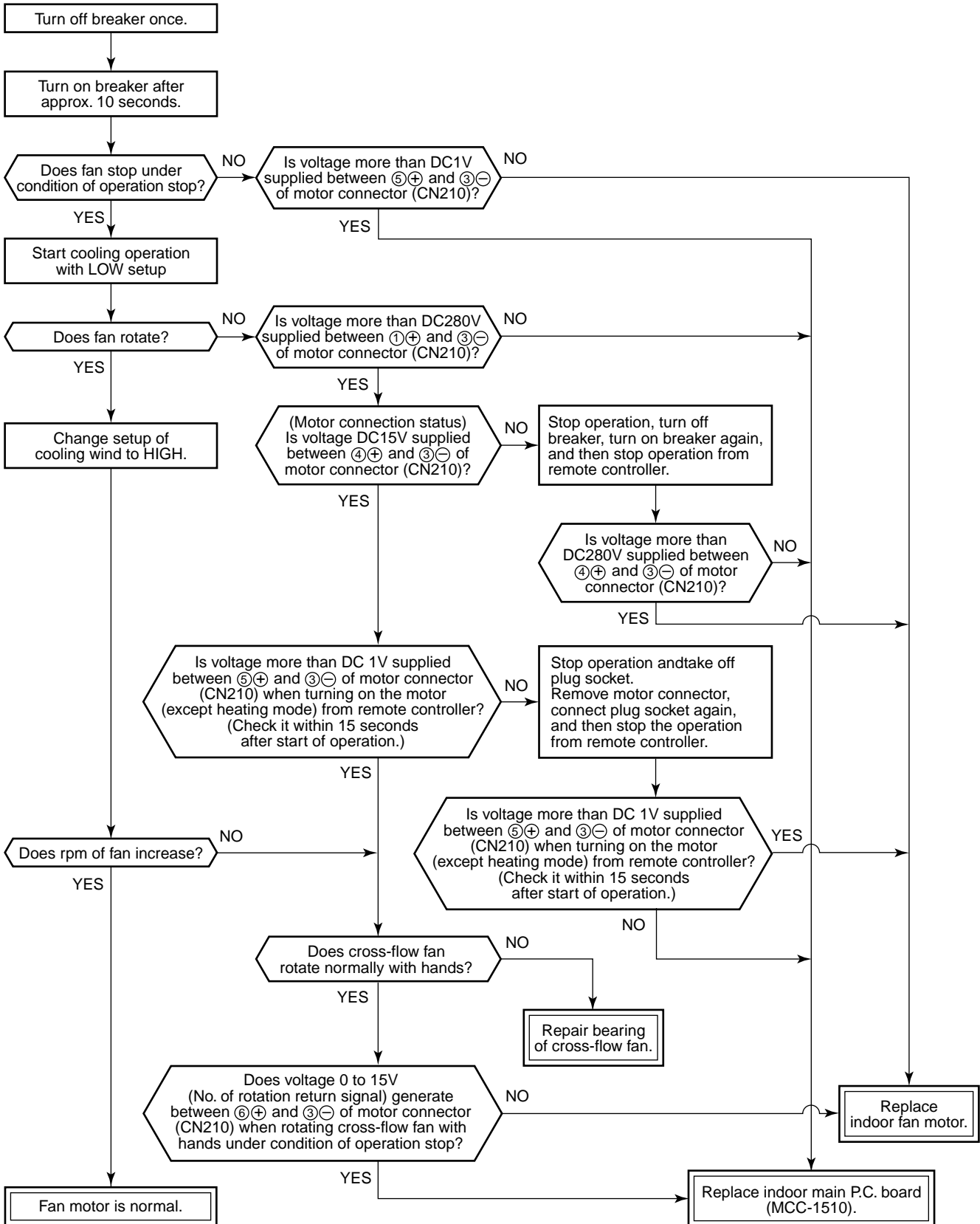

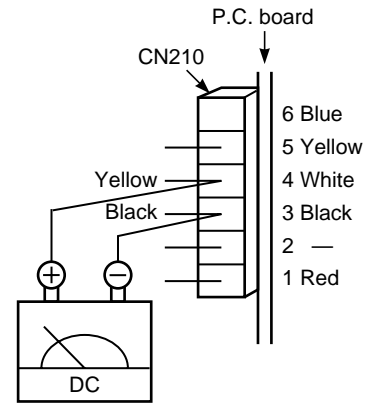
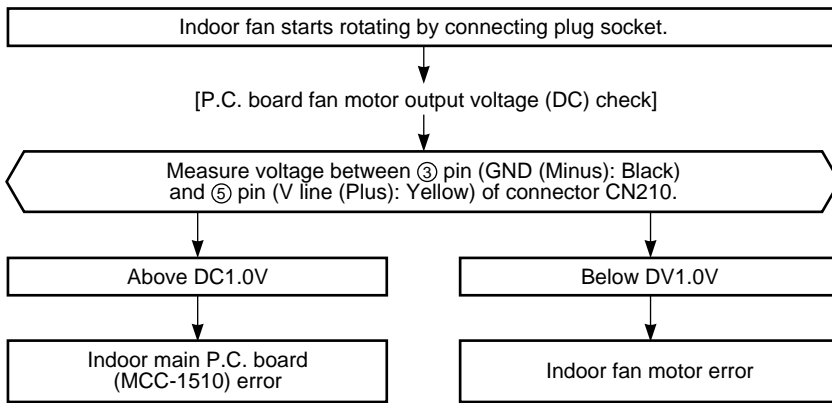

Check code name	Check code name	Cause of operation
[P13] / [47] (Current code / AI-NET)	Outdoor liquid back detection error	1. PMV1/PMV2 error 2. Pd sensor, Ps sensor error 3. Clogging of SV2 circuit 4. Clogging of SV3B circuit, balance pipe 5. Leakage of main discharge pipe 6. Outdoor I/F P.C. board error

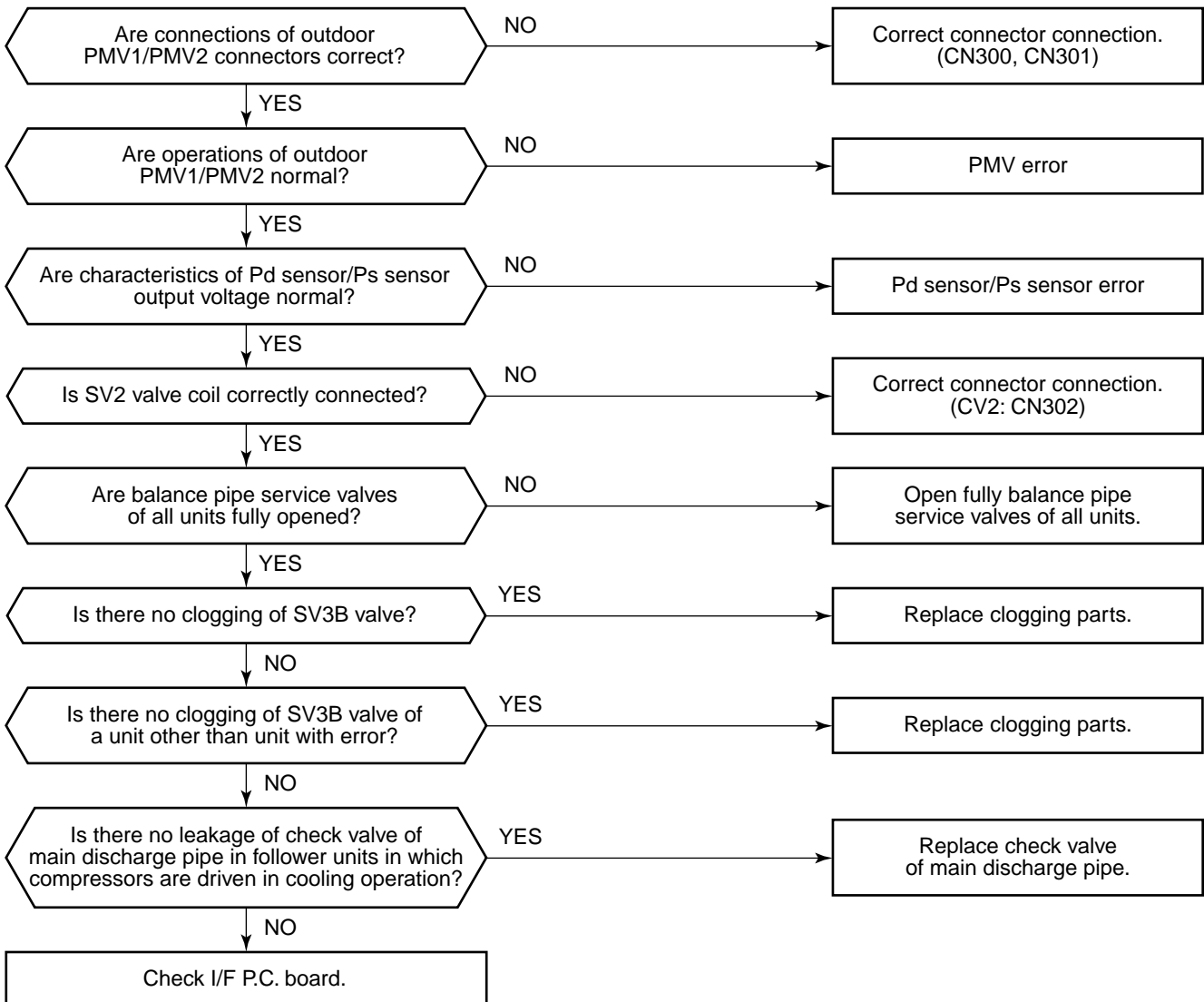

Check code name	Check code name	Cause of operation
[P15] / [AE] (Current code / AI-NET)	Gas leak detection TS condition (Sub-code: 01)	1. Outdoor unit service valve closed 2. Outdoor PMV error 3. TS1 sensor error 4. Refrigerant shortage, clogging refrigerant circuit 5. 4-way valve error 6. SV4 circuit error

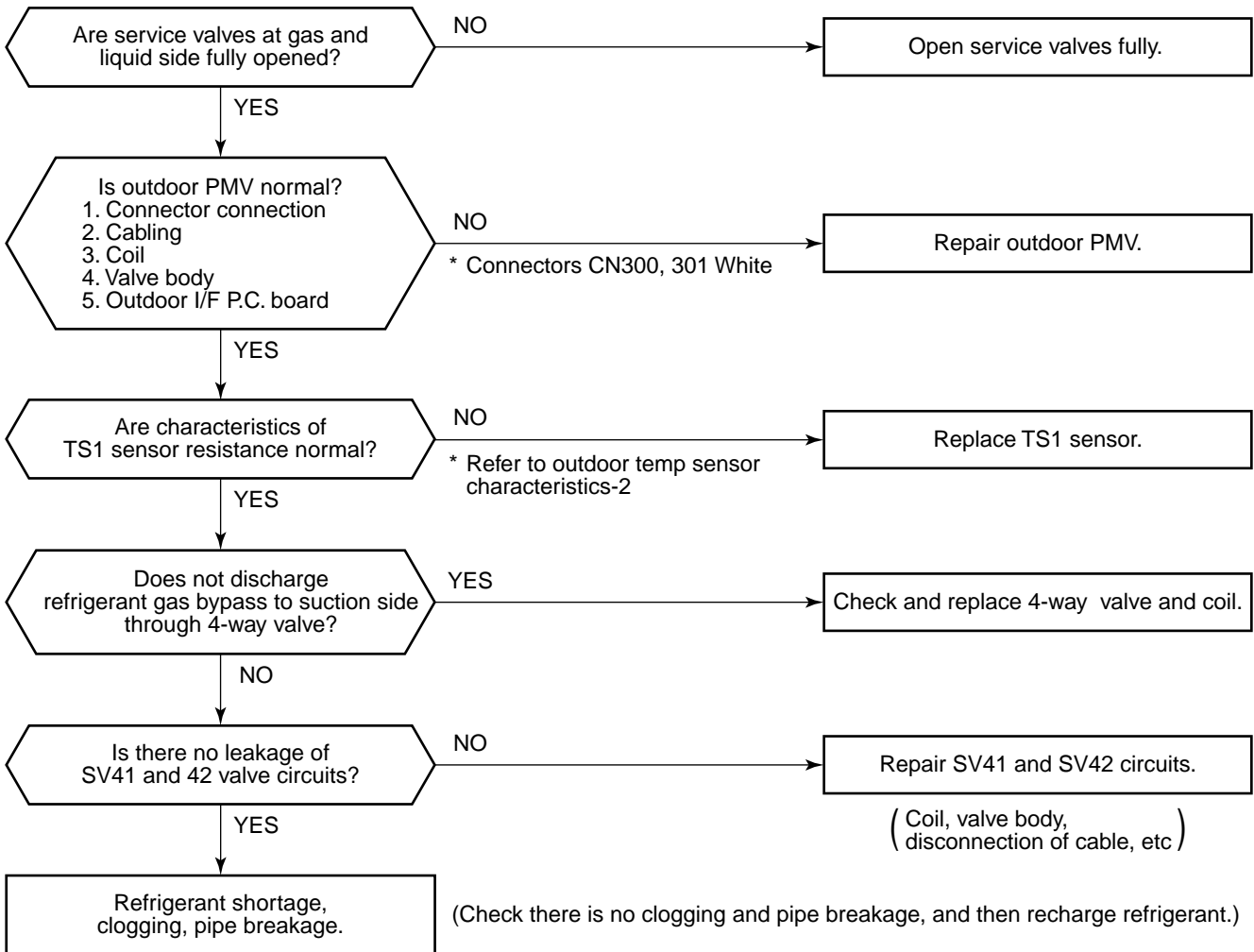

Check code name	Check code name	Cause of operation
[P15] / [AE] (Current code / AI-NET)	Gas leak detection TD condition (Sub-code: 02)	1. Outdoor unit service valve closed 2. Outdoor PMV error 3. TD sensor error 4. SV4 circuit error 5. Refrigerant shortage, clogging refrigerant circuit

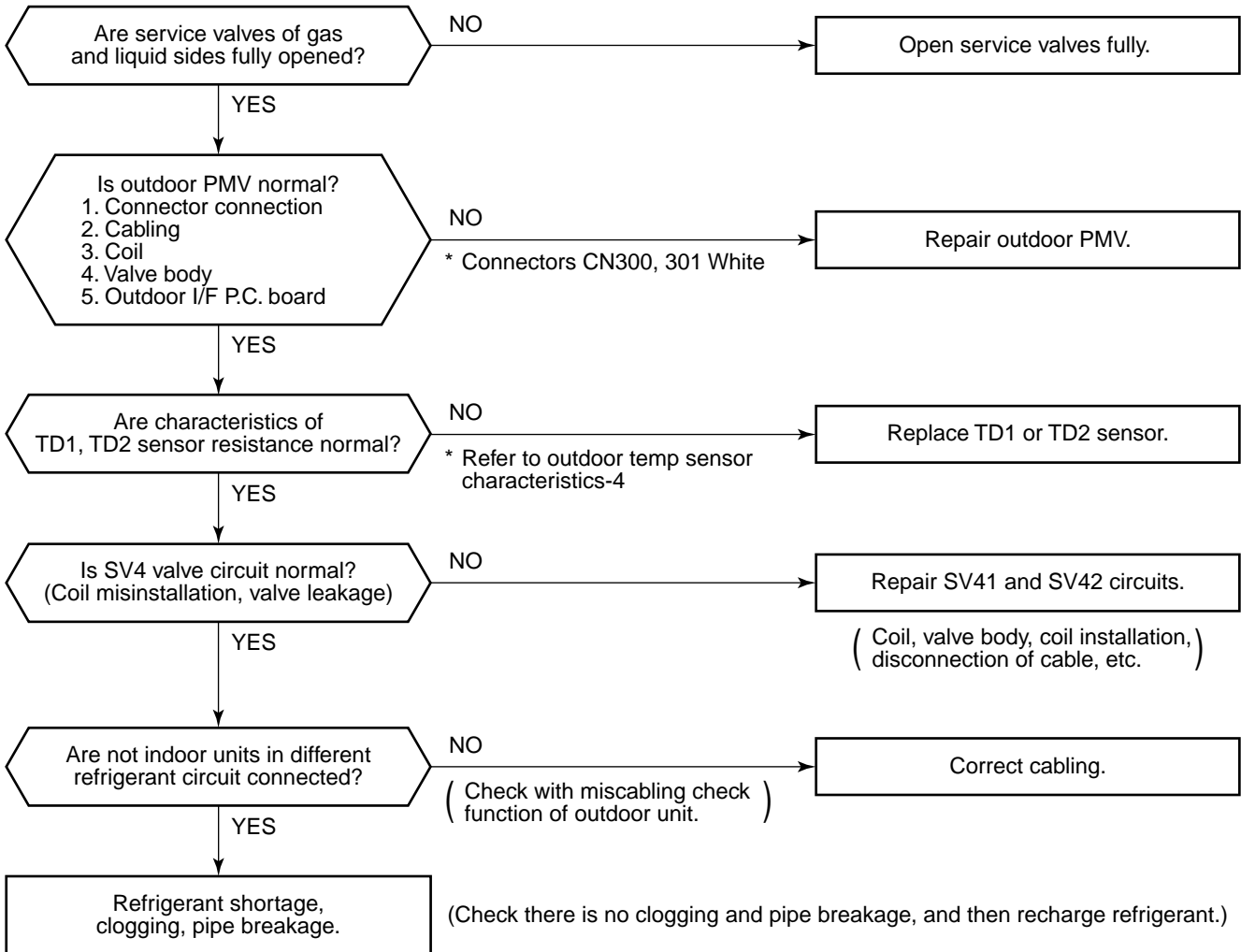

Check code name	Check code name	Cause of operation
[P17] / [bb] (Current code / AI-NET)	Discharge temp TD2 error	1. Outdoor unit service valve closed 2. Outdoor PMV error 3. TD sensor error 4. Refrigerant shortage, clogging of refrigerant circuit 5. 4-way valve error 6. SV4 circuit leakage, misinstallation

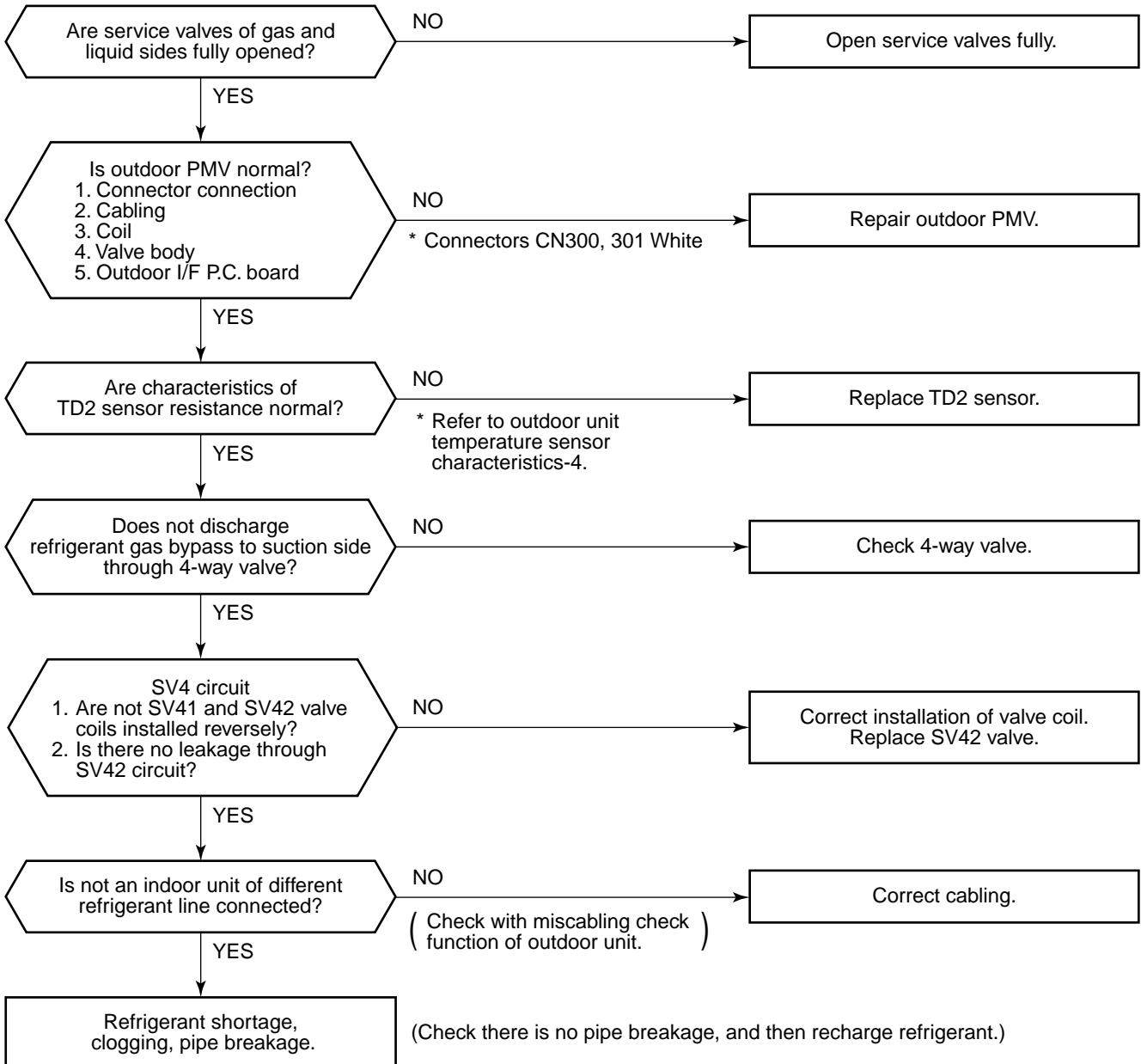

Check code name	Check code name	Cause of operation
[P19] / [08] (Current code / AI-NET)	4-way valve operation error	1. 4-way valve error 2. TS1 sensor/TE1 sensor error 3. Pd sensor/Ps sensor error 4. TE sensor/TL sensor misconnection

Sub-code: Detected outdoor unit No.

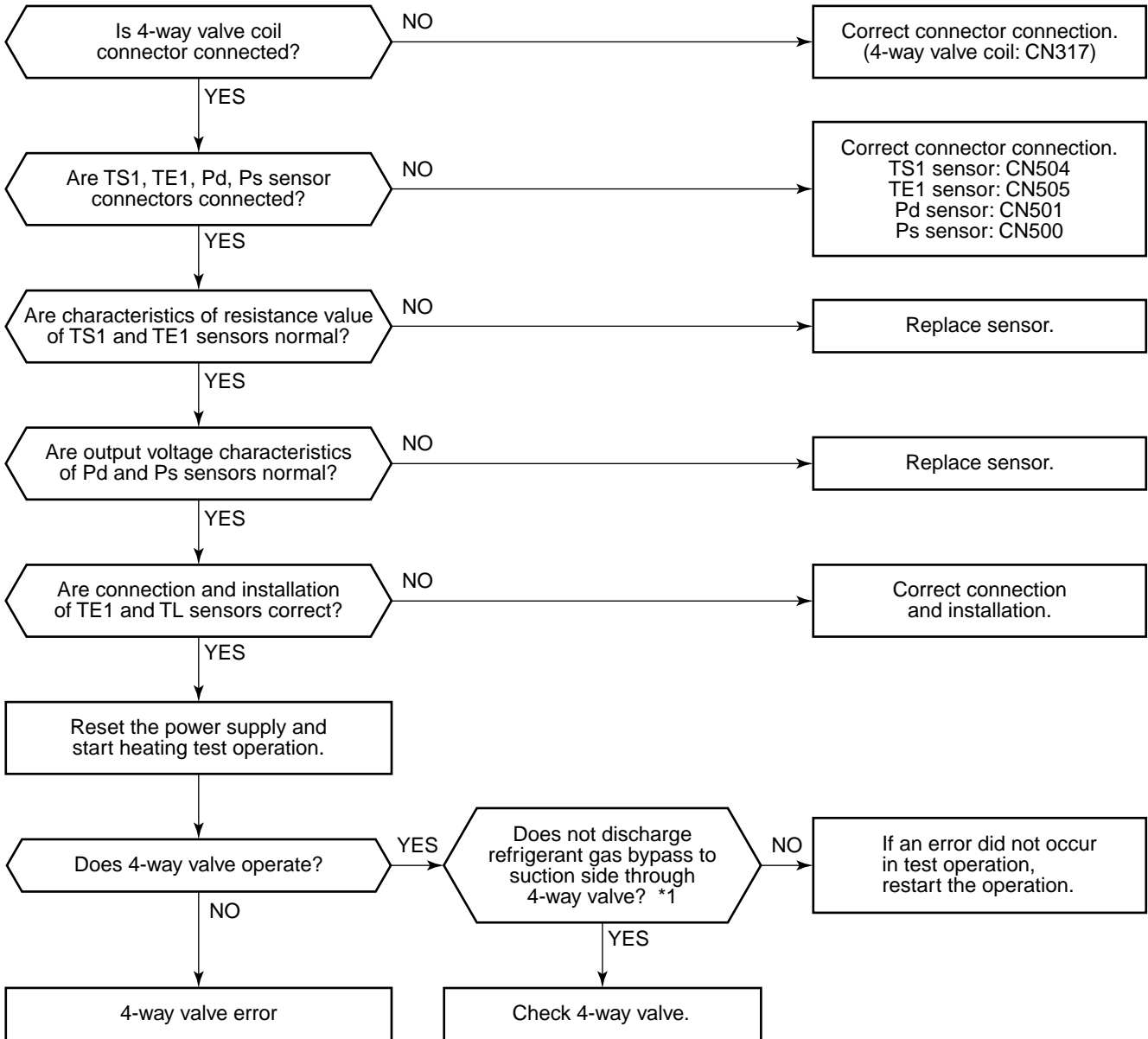

*1 Check TS and TE temperature of the outdoor unit which compressors is operated.
 (I/F) SW01=[1], SW02=[6], SW03=[2] → TS sensor temperature
 SW01=[1], SW02=[7], SW03=[2] → TE sensor temperature

<Judgment criteria>
 TE sensor: Normal if TE ≤ 20°C except summer season (Outside temp 20°C or lower)
 TS sensor: Normal if TS ≤ 40°C except summer season (Outside temp 20°C or lower)

Check code name	Check code name	Cause of operation
[P20] / [22] (Current code / AI-NET)	High-pressure protective operation	1. Pd sensor error 2. Service valve closed. 3. Indoor/outdoor fan error 4. Indoor/outdoor PMV clogging 5. Indoor/outdoor heat exchanger clogging 6. SV2 circuit error 7. SV4 circuit error 8. SV5 circuit error 9. Outdoor I/F P.C. board error 10. Operation error of check valve of main discharge pipe 11. Refrigerant overcharge

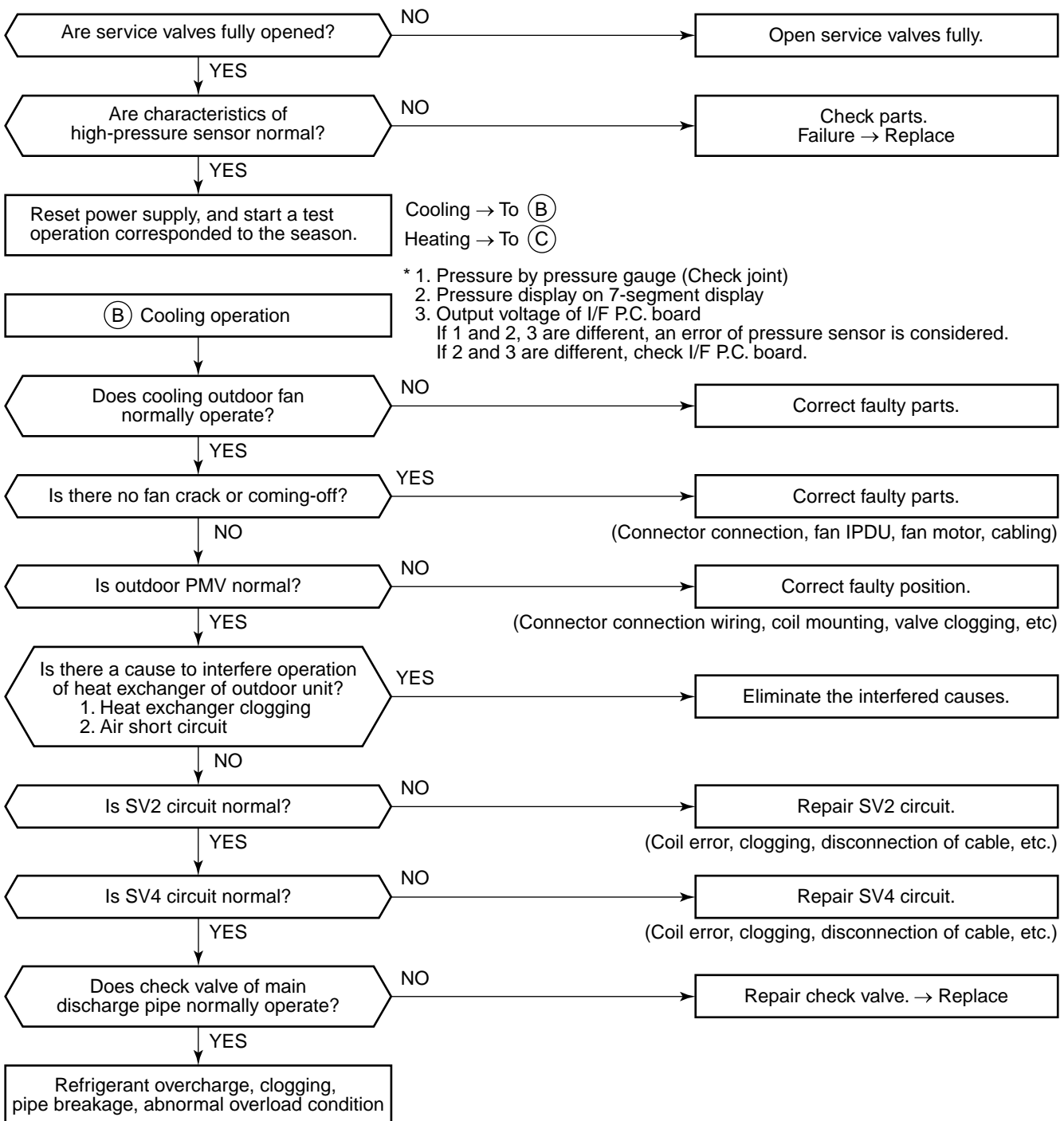

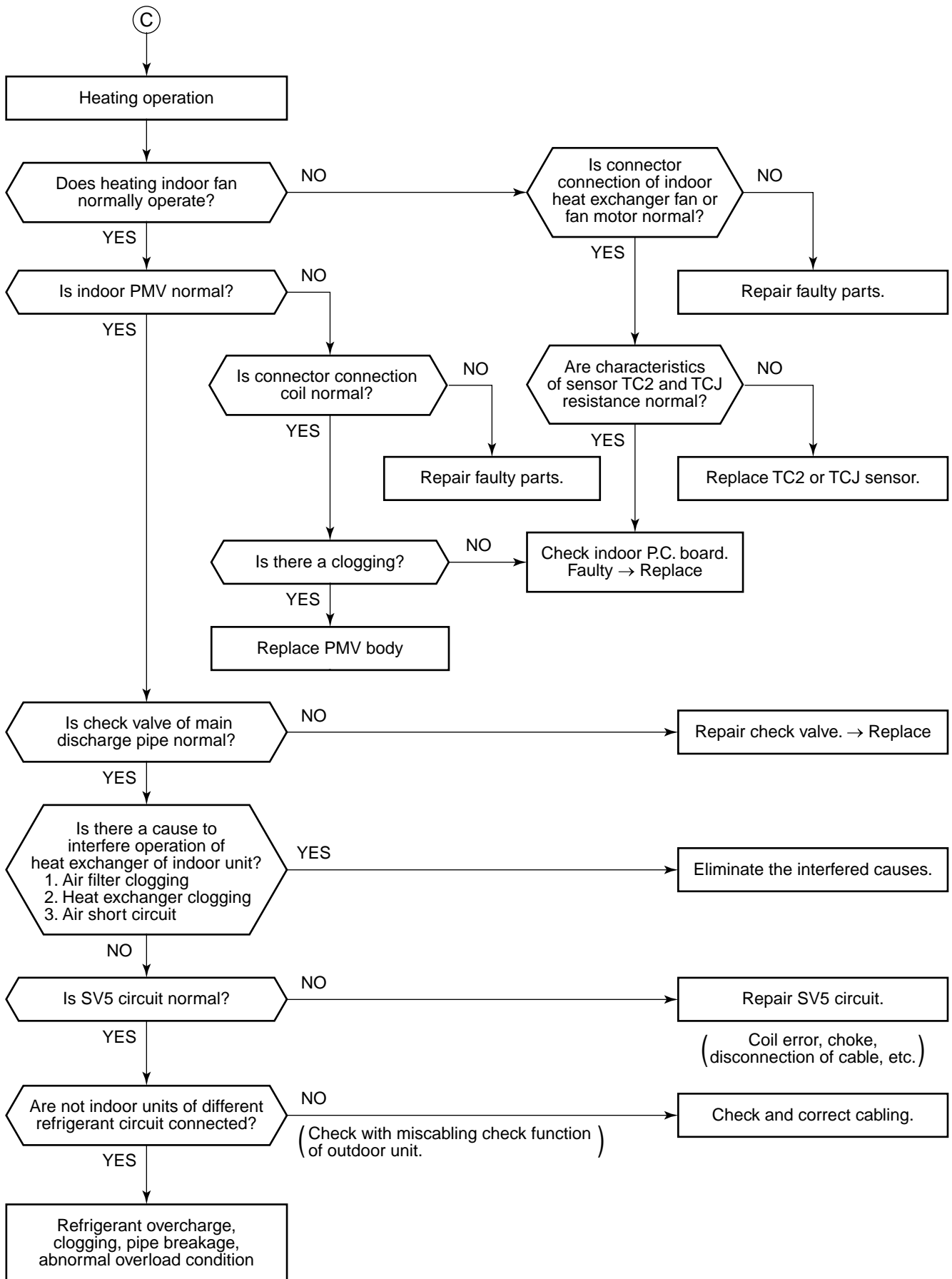

Check code name	Check code name	Cause of operation
[P26] / [14] (Current code / AI-NET)	G-Tr short-circuit protection error	1. Outdoor unit power error 2. IPDU error/Cable connection error 3. Compressor error 4. IPDU P.C. board error

Sub-code: 01: Compressor 1 side 02: Compressor 2 side

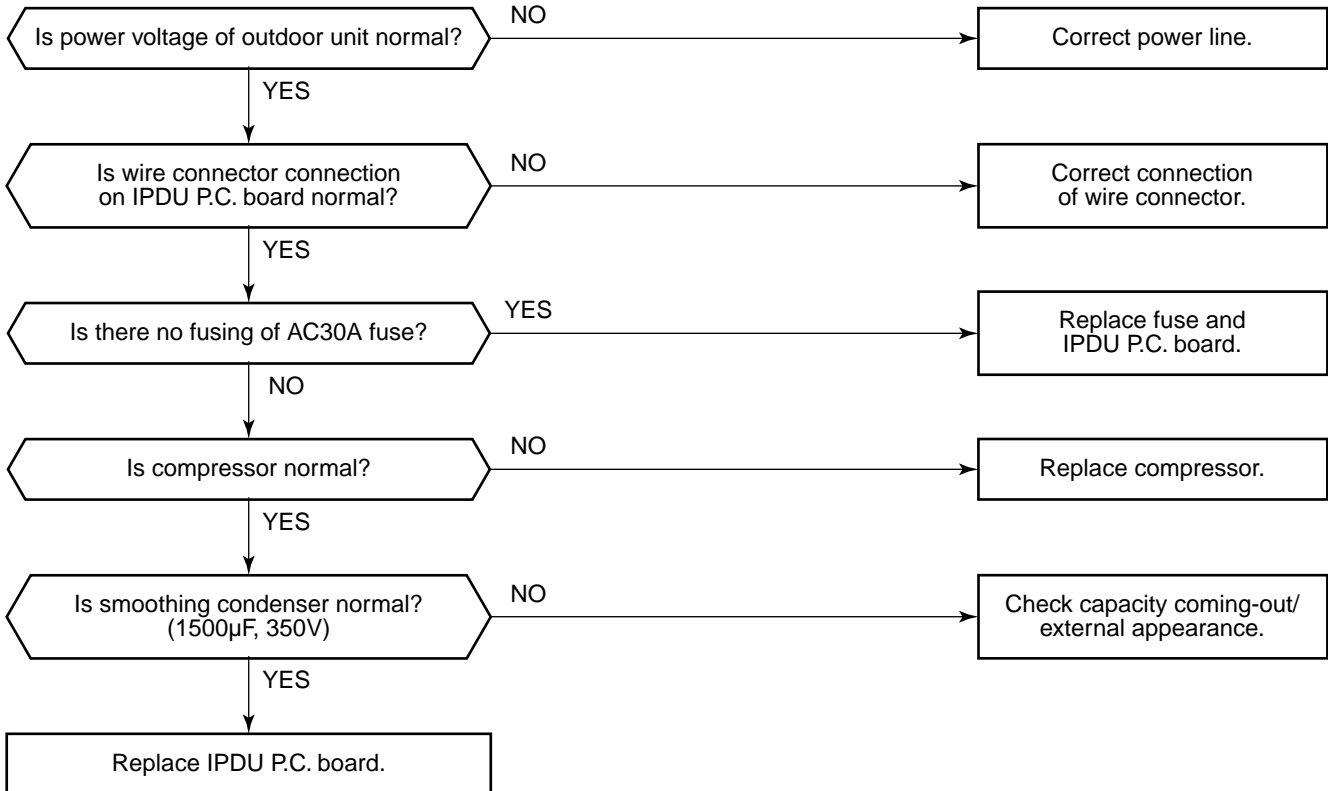

Check code name	Check code name	Cause of operation
[P29] / [16] (Current code / AI-NET)	Compressor position detective circuit error	1. Cable/connector connection error 2. Compressor error 3. IPDU P.C. board error

Sub-code: 01: Compressor 1 side 02: Compressor 2 side

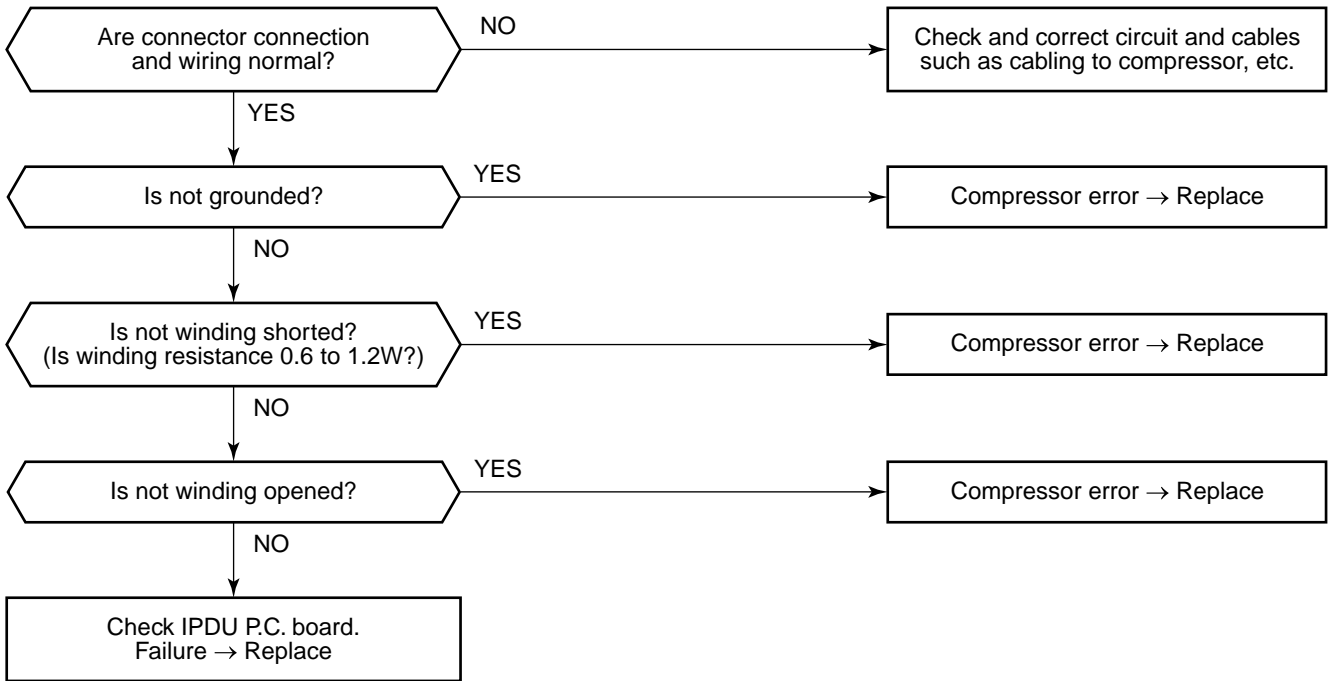

Check code name	Check code name	Cause of operation
[P31] / [47] (Current code / AI-NET)	Other indoor error (Group follower unit error)	Other indoor unit in the group is abnormal.

When the header unit of the group detected [E03, L03, L07, L08 error], the follower unit of the group displays [P31] error and stops. There are no check code display and alarm record of the main remote controller.

Check code name	Check code name	Cause of operation
[-] / [97] (Current code / AI-NET)	AI-NET communication line error	AI-NET communication line error

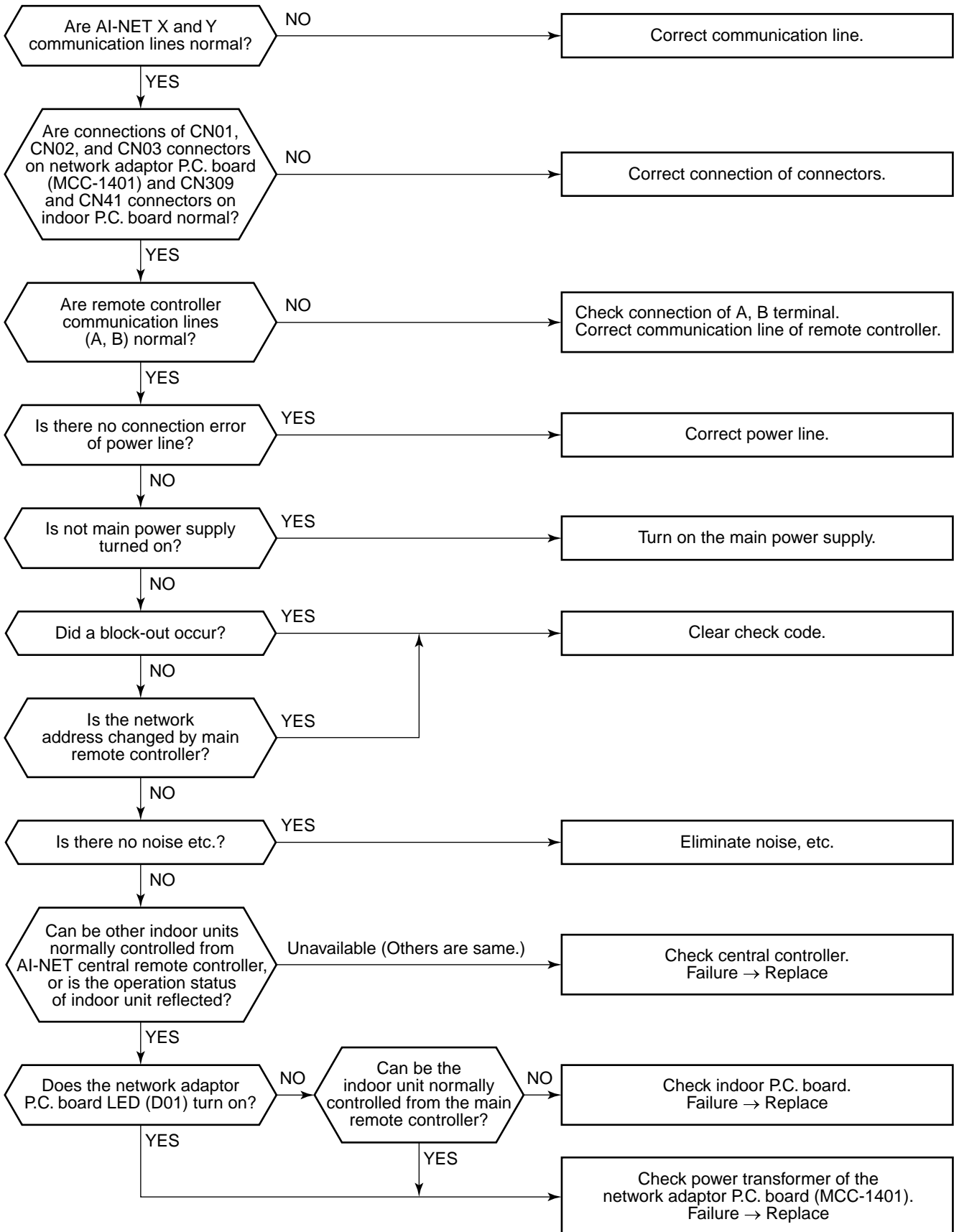

7-5-1. Indoor Unit

■ Temperature sensor characteristics

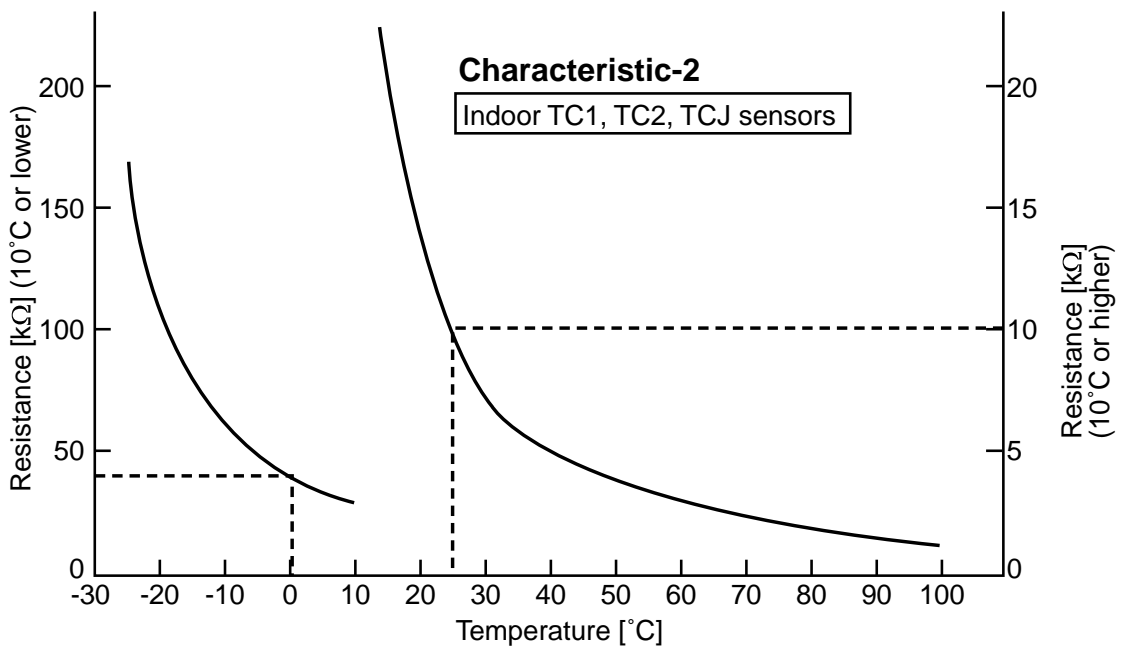
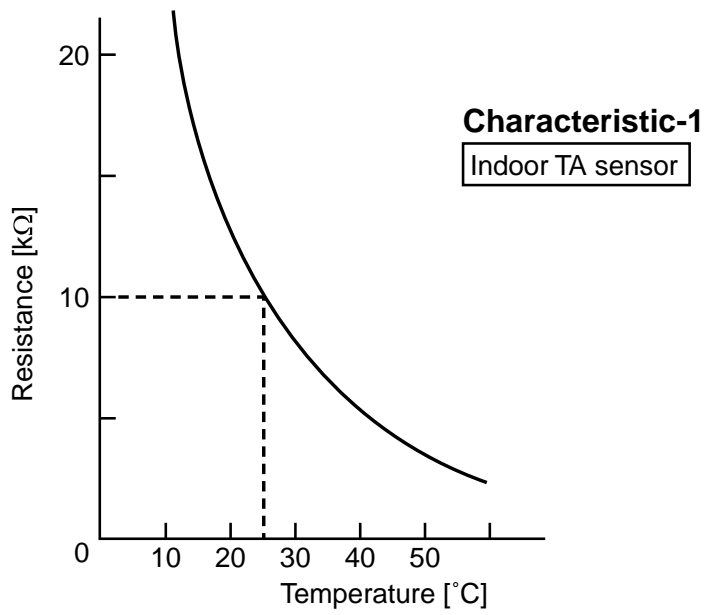

8. CONFIGURATION OF CONTROL CIRCUIT

8-1. Indoor Controller Block Diagram

8-1-1. Case of Main (Sub) Remote Controller Connected

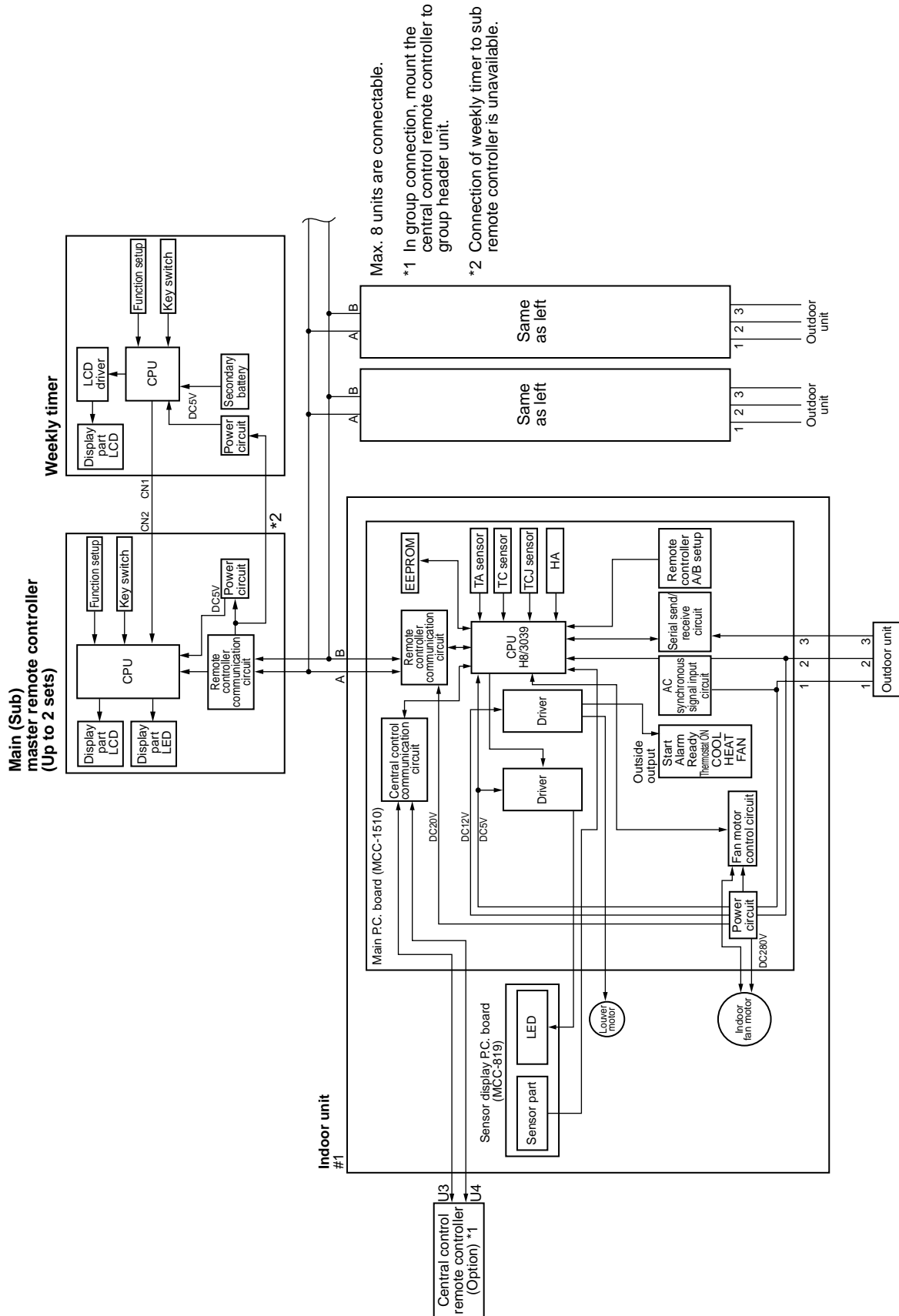

8-1-2. Case of Wireless Remote Controller Kit Connected

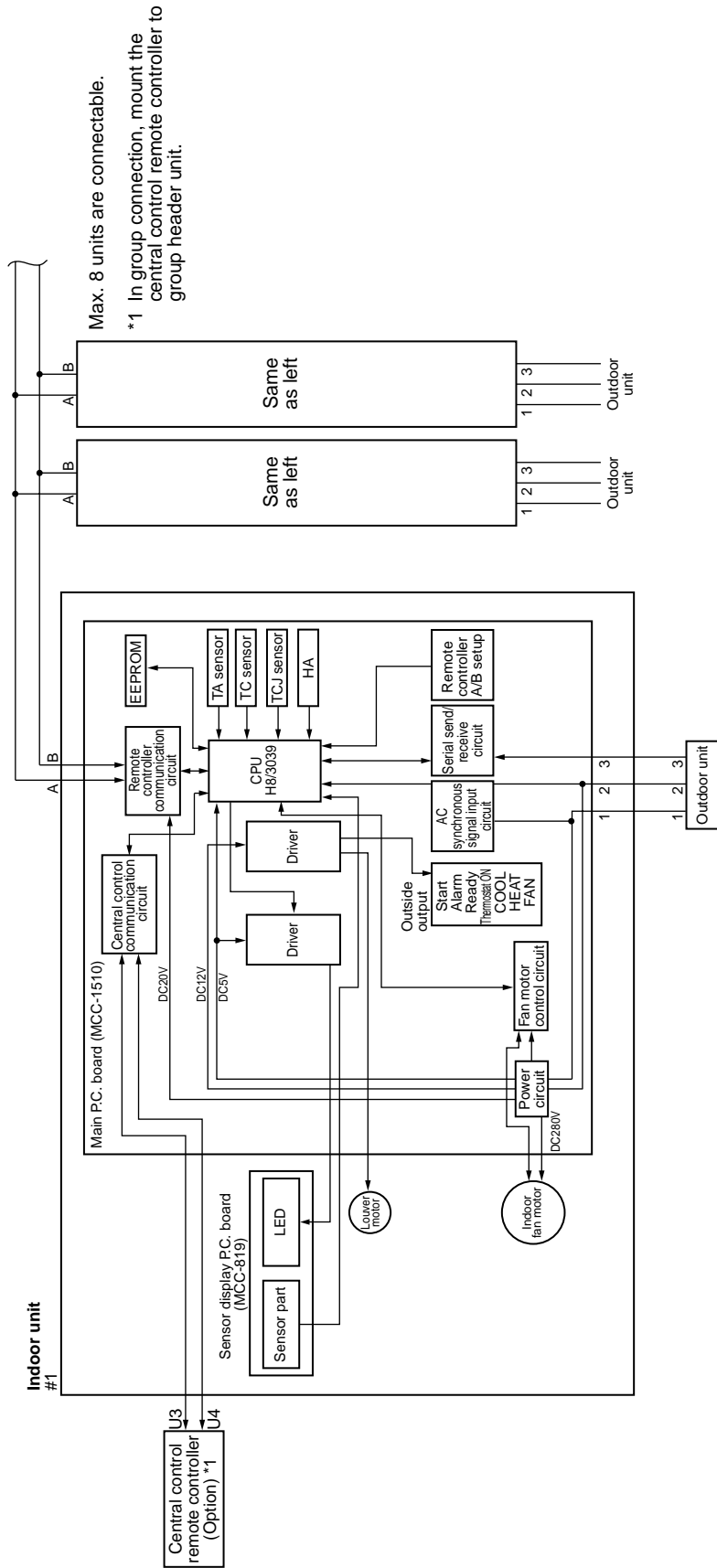

9. HOW TO REPLACE MAIN PARTS

9-1. Indoor Unit

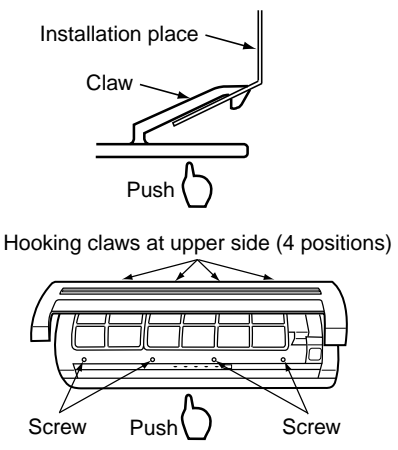
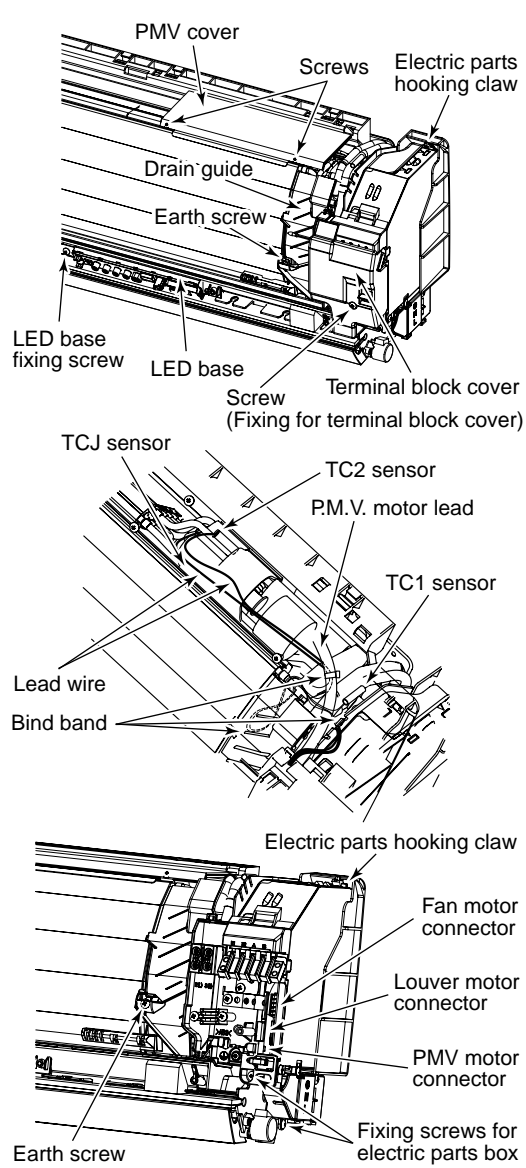
No.	Part name	Procedure	Remarks
①	Front panel	<p>1) Stop operation of the air conditioner, and then pull out the power supply plug from the plug socket.</p> <p>2) Open the suction grille, and then take off fixing screws of the front panel (4 pcs.).</p> <p>3) Push the electric parts box with right thumb while pulling the both sides of the front panel.</p> <p><Attachment of front panel></p> <p>1) Hang the hooking claws of the upper surface of the front panel (4 positions) to the rear plate, and then push a position at the center of the lower part of the discharge port.</p> <p>2) Tighten 4 screws.</p> <p>* When hooking or pushing is insufficient, dewdrop or abnormal sound may be caused.</p>	
②	Electric parts assembly	<p>1) Perform work of item ①.</p> <p>2) Take off fixing screws (2 pcs) of PMV cover, and then remove PMV cover.</p> <p>3) Remove binding band (2 positions) fixing the sensor lead wires. (When mounting electric parts, fix the sensor lead wires again with bundling band. Put bundling band on the positions as before and fasten wires.)</p> <p>4) Pull out TC1, TC2, TCJ sensors from sensor holder of heat exchanger. (Pay attention to mounting positions of each sensor when reassembling of electric parts. Be sure to apply marking, etc to TC2 and TCJ sensors before removing because their shapes are reassembled.)</p> <p>5) Take off LED base fixing screw (1 pc) and remove LED base.</p> <p>6) Remove terminal block cover, and then remove fan motor connector (5P), louver motor connector (5P), and PMV motor connector (6P) from microcomputer assembly.</p> <p>7) Take off fixing screws (2 pcs) of electric parts box, pull out slightly the electric parts box toward you, and then remove drain guide.</p> <p>8) Take off earth screws attached to end board of the heat exchanger.</p> <p>9) Pull off the electric parts box toward you.</p> <p><Caution in reassembling></p> <p>When mounting the electric parts box to the main unit, follow the reverse procedure of removing. Return sensors and lead wires to the original positions according to the diagram.</p>	

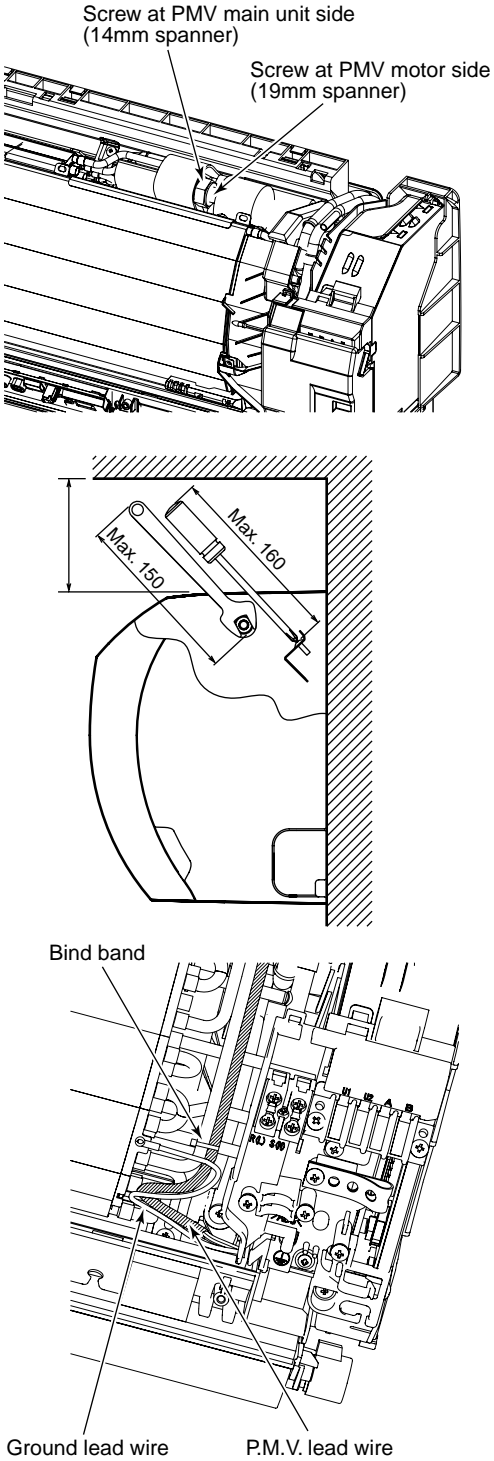
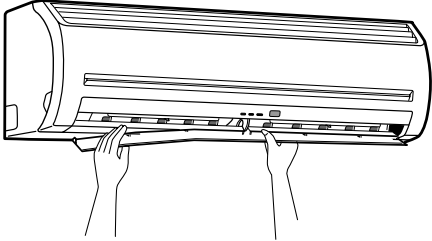
No.	Part name	Procedure	Remarks
③	PMV motor	<p><Caution in works> Use spanners to remove PMV motor. As the pipes are deformed, do not use monkey spanners. When there is 100 to the ceiling, use a spanner below mm.)</p> <ol style="list-style-type: none"> 1) Perform work of item ①. 2) Take off fixing screws (2 pcs) of PMV cover, and then remove PMV cover. 3) Remove connector (6P, Blue) for PMV motor from the electric parts box. 4) Take off bundling band of PMV motor lead wires. 5) Using a spanner, remove PMV motor. <p><Caution in reassembling> Draw out lead wires of PMV motor from positions same to original positions before removing.</p>	
④	Horizontal grille	<ol style="list-style-type: none"> 1) Remove shaft of the horizontal grille from the rear plate. (First remove the left shaft, and then remove the other shafts while sliding the horizontal grille leftward.) 	

No.	Part name	Procedure	Remarks
⑤	Heat exchanger	<ol style="list-style-type: none"> 1) Perform work of item ②. 2) Remove the pipe holder from the rear side of the main unit. 3) Take off fixing screws (2 pcs.) at the left side of the end plate of the heat exchanger. 4) Take off fixing screws (2 pcs.) at the right side of the heat exchanger. 	<p>Pipe holder</p> <p>Fixing screws</p> <p>Fixing screws</p>
⑥	Bearing	<ol style="list-style-type: none"> 1) Perform works of items ①, ⑧-4), and ⑧-5), and then remove bearing from the bearing base. <p><Caution to reassembly> In case of shooting-out of bearing part from the housing, push into the specified position and incorporate in the main unit.</p>	<p>Bearing base</p> <p>Bearing</p> <p>Drain pipe</p>

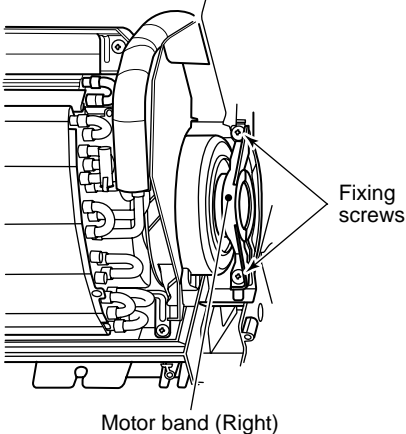
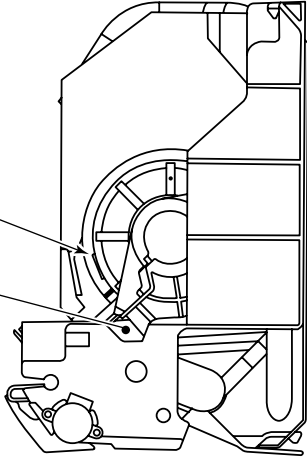
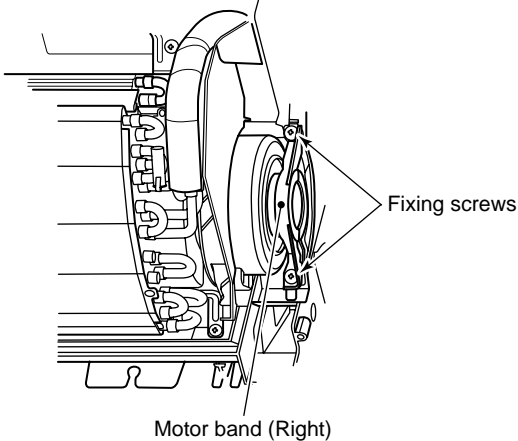
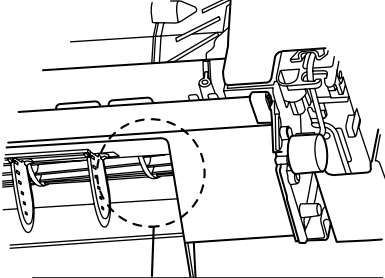
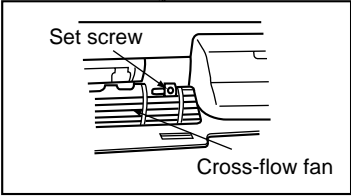
No.	Part name	Procedure	Remarks
⑦	Fan motor	<ol style="list-style-type: none"> 1) Perform work of item ②. 2) Perform work of item ④. 3) Loosen the set screw of the cross-flow fan from the discharge port. 4) Take off fixing screws (2 pcs) to remove the motor band (Right). 5) Pull out the fan motor outward. <p>Drawing port of fan motor lead wires should be this position. (Determine the lead drawing port position so that motor band (Right) does not come to contact with fan motor drawing port.)</p> <p>Draw out fan motor lead wire from here.</p>	<p>Assemble the fan motor as shown below.</p>  
⑧	Cross-flow fan	<ol style="list-style-type: none"> 1) Perform works of items ② and ④. 2) Take off fixing screws (2 pcs.) at the left side of the end plate of the heat exchanger, and then take off fixing screws (2 pcs.) of the bearing base. 3) Make the left side of the heat exchanger float slightly, and then remove the bearing base. 4) Loosen set screw of the cross-flow fan from the discharge port. 5) Take off fixing screws (2 pcs.) to remove the motor band (Right). 	  <p>* Remove set screw from gap of thermal insulator.</p>

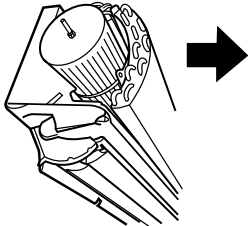
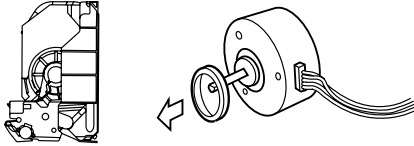
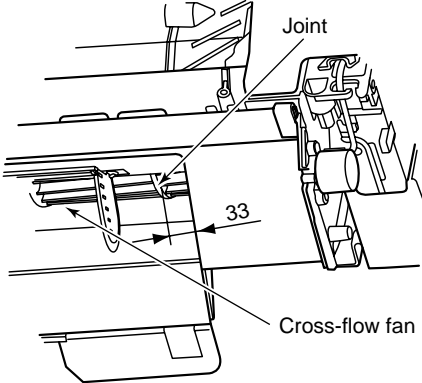
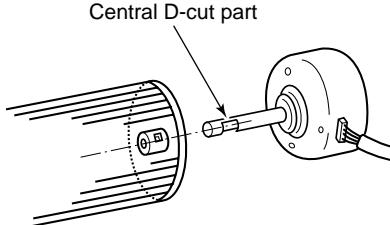
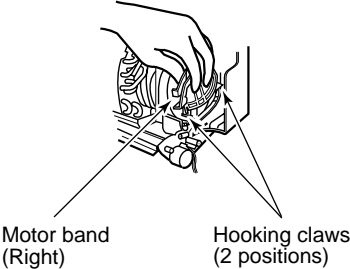
No.	Part name	Procedure	Remarks
⑧	Cross-flow fan	<p>6) Slide the fan motor rightward to remove it.</p> <p>7) Take off fixing screws (2 pcs.) from fixing support at right side of the heat exchanger.</p> <p>8) Lift up the left side of the heat exchanger toward you, and then remove the cross-flow fan.</p> <p><Caution to reassembling></p> <p>a) When assembling the bearing base, check the drain pipe is surely incorporated to the rear plate. (Otherwise water leak may be caused.)</p> <p>b) When assembling the fan motor, remove fan motor rubber (shaft center side), mount it in the position in the following figure, and then mount the fan motor.</p> <p>• Mount the cross-flow fan so that the right end of joint which is first one from right of the cross-flow fan is set at position 70.5mm apart from wall of the rear side of the main unit.</p> <p>• Mount the cross-flow fan so that D-cut part at the center comes to the mounting hole of set screw.</p> <p>• Determine the position of fan motor as shown in the figure for mounting. (Perform work of item ⑦.)</p> <p>c) When attaching motor band (Right), perform work of item b), set the hooking claws (2 positions) of the motor band (Right) in the main unit, and then perform reverse procedure of item 6).</p>	    

10. REPLACEMENT OF SERVICE INDOOR P.C. BOARD

Model type	P.C. board model	Label display on P.C. board
MMK-AP*** 2H series	MCC-1510	04DD M01

[Requirement when replacing the service indoor P.C. board assembly]

In the non-volatile memory (Hereinafter said EEPROM, IC10) installed on the indoor P.C. board before replacement, the type and capacity code exclusive to the corresponding model have been stored at shipment from the factory and the important setup data such as refrigerant line /indoor unit /group address in (AUTO/MANUAL) mode have been stored at installation. Replace the service indoor P.C. board assembly according to the following procedure.

After replacement, make sure that the indoor unit address is set correctly and also the refrigerant cycle is working correctly by test operation.

<Replacement procedure>

CASE 1

Before replacement, power of the indoor unit can be turned on and the setup data can be readout by the wired remote controller.

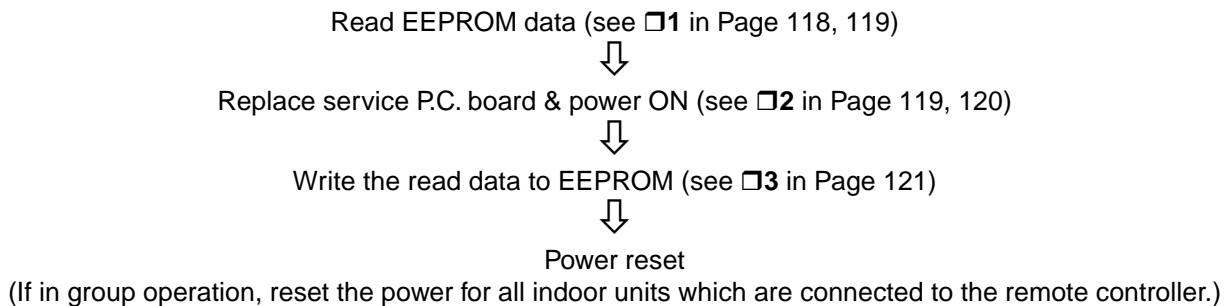

CASE 2

Before replacement, the setup data can not be read out by the wired remote controller.

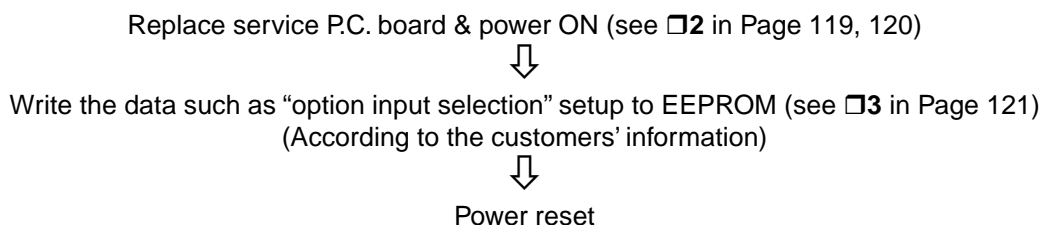

□1 Readout of the setup data from EEPROM

(Data in EEPROM contents, which have been changed at the local site, are read out together with data in EEPROM set at shipment from the factory.)

1. Push **SET**, **CL** and  buttons of the remote controller at the same time for 4 seconds or more. **1**
(Corresponded with No. in Remote controller as shown below picture)

* When group operation, the header indoor unit address is displayed at the first time. In this time, the item code (DN)  is displayed. The fan of the second indoor unit operates and the flap starts swinging if any.

2. Every pushing [UNIT] button, the indoor unit address in the group are displayed successively. **2**
Specify the indoor unit No. to be replaced.
3. Using the set temperature / buttons, the item code (DN) can be moved up and down one by one. **3**
4. First change the item code (DN) from *10* to *01*. (Setting of filter sign lighting time) Make a note of the set data displayed in this time.
5. Next change the item code (DN) using the set temperature / buttons. Also make a note of the set data.
6. Repeat item 5. and made a note of the important set data as shown in the below table.
* *01* to *AA* are provided in the item code (DN). On the way of operation, DN No. may skip.
7. After finishing making a note, push button to return to the usual stop status. **4**
(Approx. 1 minute is required to be able to use the remote controller.)

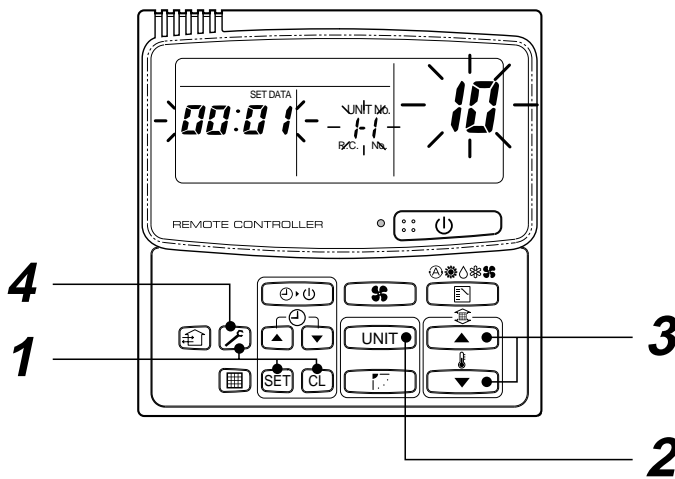

Minimum requirements for item code

DN	Contents
11	Indoor unit capacity
12	Refrigerant line address
13	Indoor unit address
14	Group address

Capacity of the indoor unit is necessary to set the revolutions of the fan.

□2 Replacement of service P.C. board

1. Replace the P.C. board with a service P.C. board.
In this time, setting of jumper line (cut) or setting of DIP switch on the former P.C. board should be reflected on the service P.C. board. Refer to the following table about DIP switch setting and drawing of P.C. board parts layout.
2. It is necessary to set Indoor unit to be exchanged : Remote controller = 1 : 1
Based upon the system configuration, turn on power of the indoor unit with one of the following items.
 - 1) Single (Individual) operation
Turn on power of the indoor units and proceed to □3.
 - 2) Group operation
 - A) In case that power of the exchanged indoor unit only can be turned on.
Turn on power of the exchanged indoor unit only and proceed to □3.
 - B) In case that power of the indoor units cannot be turned on individually. (**Case 1**)
 - a) Remove temporarily the group wire connected to the terminal blocks A and B of the exchanged indoor unit.
 - b) After connecting the remote controller wire only to the removed terminal block, turn on power of the indoor units and proceed to □3.
* When the above methods cannot be used, follow at the **Case 2** below.

C) In case that power of the indoor units cannot be turned in individually. (**Case 2**)

- a) Remove all CN41 connectors of the indoor units in the same group except those of the exchanged indoor unit.
 - b) Turn on power of the indoor units and proceed to **□3**.
- * After **□3** operation has finished, be sure to return the temporarily removed group wire or CN41 connector to the original connection.

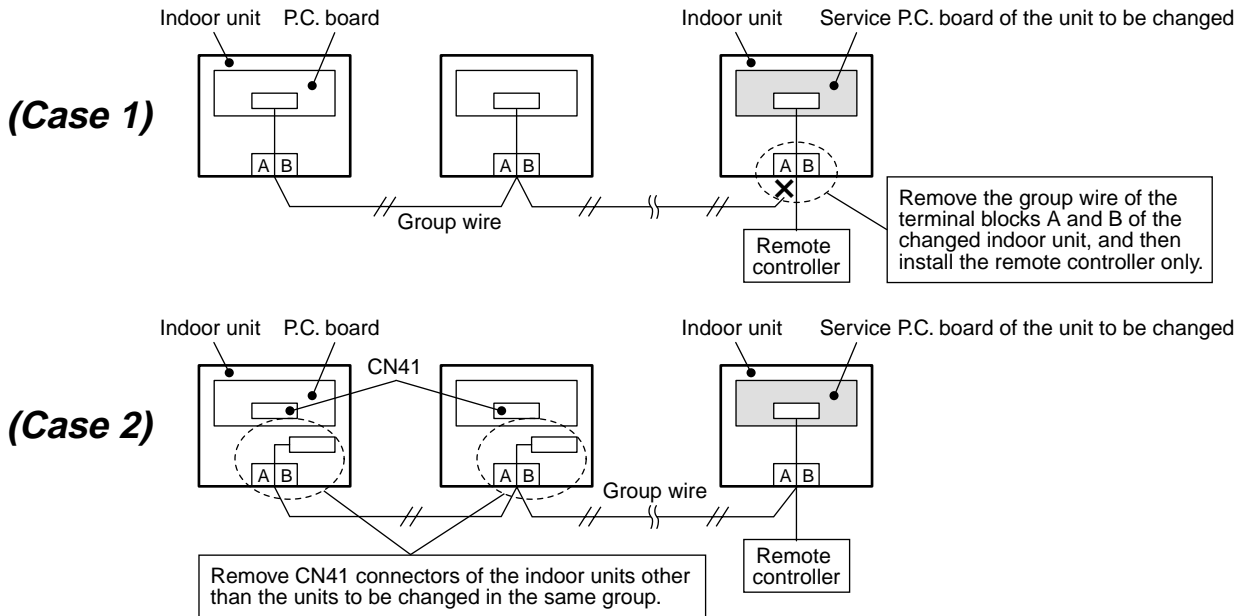

P.C. board parts layout drawing

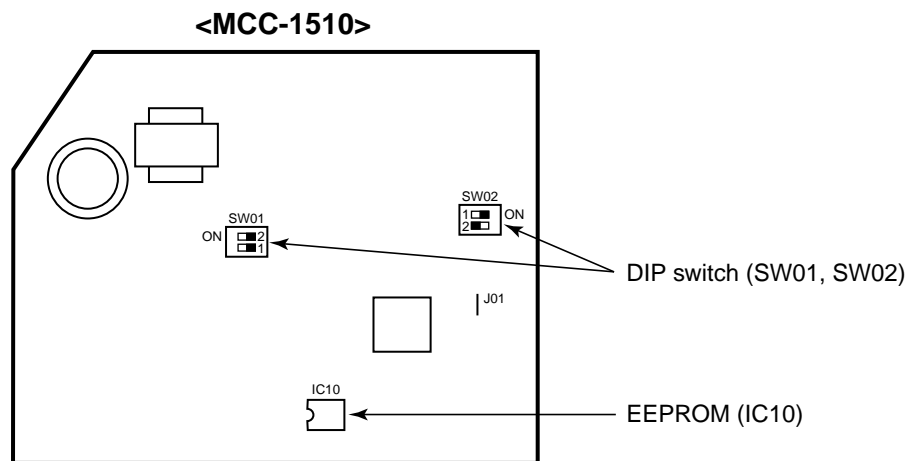

Method of DIP switch setting

		Selected content	MMK-AP***2H series	At shipment
SW01	Bit 1	Terminator resistor (for central control)	*1	OFF (Without terminator)
	Bit 2	Remote controller A/B selection	*1	OFF (A selection)
SW02	Bit 1	Custom / Multi model selection	ON	ON (Multi model)
	Bit 2	No use	OFF	OFF

*1 : Match to set up contents of P.C. board before replacement.

□3 3 Writing of the setup contents to EEPROM

(The contents of EEPROM installed on the service P.C. board have been set up at shipment from the factory.)

1. Push **SET**, **CL** and **↻** buttons of the remote controller at the same time for 4 seconds or more. **1**
(Corresponded with No. in Remote controller as shown below picture) (The UNIT No. *ALL* is displayed.)
In this time, the item code (DN) *10* is displayed. The fan of the indoor unit operates and the flap starts swinging if any.
2. Using the set temperature **▲** / **▼** buttons, the item code (DN) can be moved up and down one by one. **2**
3. First set the capacity of the indoor unit.
(Setting the capacity writes the data at shipment from the factory in EEPROM.)
 - 1) Using the set temperature **▲** / **▼** buttons, set *11* to the item code (DN). **2**
 - 2) Using the timer time **▲** / **▼** buttons, set the capacity. **3**
(For example, 0005 for MMK-AP0122H) Refer to the attached table.
 - 3) Push **SET** button. (OK when the display goes on.) **4**
 - 4) Push **↻** button to return to usual stop status. **5**
(Approx. 1 minute is required to start handling of the remote controller.)
4. Next write the contents that have been written at the installation such as the address data into EEPROM.
Repeat the above procedure 1.
5. Using the set temperature **▲** / **▼** buttons, set *01* to the item code (DN). **2**
(Setup of lighting time of filter sign)
6. The contents of the displayed setup data in this time should be agreed with the contents in the previous memorandum in □1.
 - 1) If data disagree, change the displayed setup data to that in the previous memorandum by the timer time **▲** / **▼** buttons, and then push **SET** button. (OK when the display goes on.)
 - 2) There is nothing to do when data agrees.
7. Using the set temperature **▲** / **▼** buttons, change the item code (DN).
As same as the above 6., check the contents of the setup data and then change them to data contents in the previous memorandum in □1.
8. Then repeat the procedure 6. and 7.
9. After completion of setup, push **↻** button to return the status to the usual stop status. **5**

In a group operation, turn off the power supply once, return the group wires between indoor units and CN41 connectors as before, and then turn on power of all the indoor units.

(Approx. 1 minute is required to be able to use of the remote controller.)

* *01* to *AA* are provided in the item code (DN).

On the way of operation, DN No. may skip.

When data has been changed by mistake and

SET button has been pushed, the data can be returned to the data before change by pushing

CL button if the item code (DN) was not yet changed.

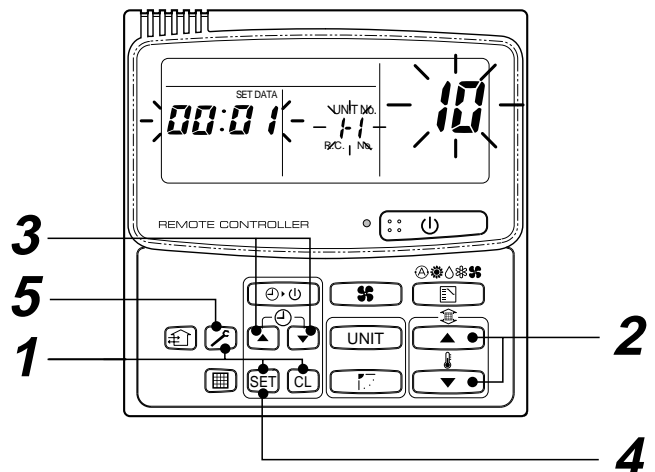

Item code table (Please record the objective unit data at field)

DN	Item	Memo	At shipment
01	Filter sign lighting time		0001: 150 hour
02	Dirty state of filter		0000: Standard
03	Central control address		0099: Unfixed
06	Heating suction temp shift		0002: +2°C
0C	PRE-DEF indication selection		0000: Standard
0d	Cooling auto mode existence		0001: No auto mode cooling/heating
0F	Cooling only		0000: Heat pump
10	Type	Be sure to set as 0008	0008: High wall type
11	Indoor unit capacity (See below table)		According to capacity type
12	Refrigerant line address		0099: Unfixed
13	Indoor unit address		0099: Unfixed
14	Group address		0099: Unfixed
1E	Temp difference of automatic cooling/heating selecting control points		0003: 3deg (Ts ± 1.5)
28	Automatic restart from power cut		0000: None
2A	Option input selection (CN80)		0002: External emergency input
2b	Thermo output selection (T10 ③)		0000: Thermo ON
2E	Input selection (T10 ①)		0000: Operation input
32	Sensor selection		0000: Available
60	Timer set (Wired remote controller)		0000: Available
69	Flap selection of cooling		0000: Standard

Indoor unit capacity (Item code [11])

Setup data	Model
0000*	Invalid
0001	MMK-AP0072H
0003	MMK-AP0092H
0005	MMK-AP0122H

* Initial value of EEPROM installed on the supplied service P.C. board

11. EXPLODED VIEWS AND PARTS LIST

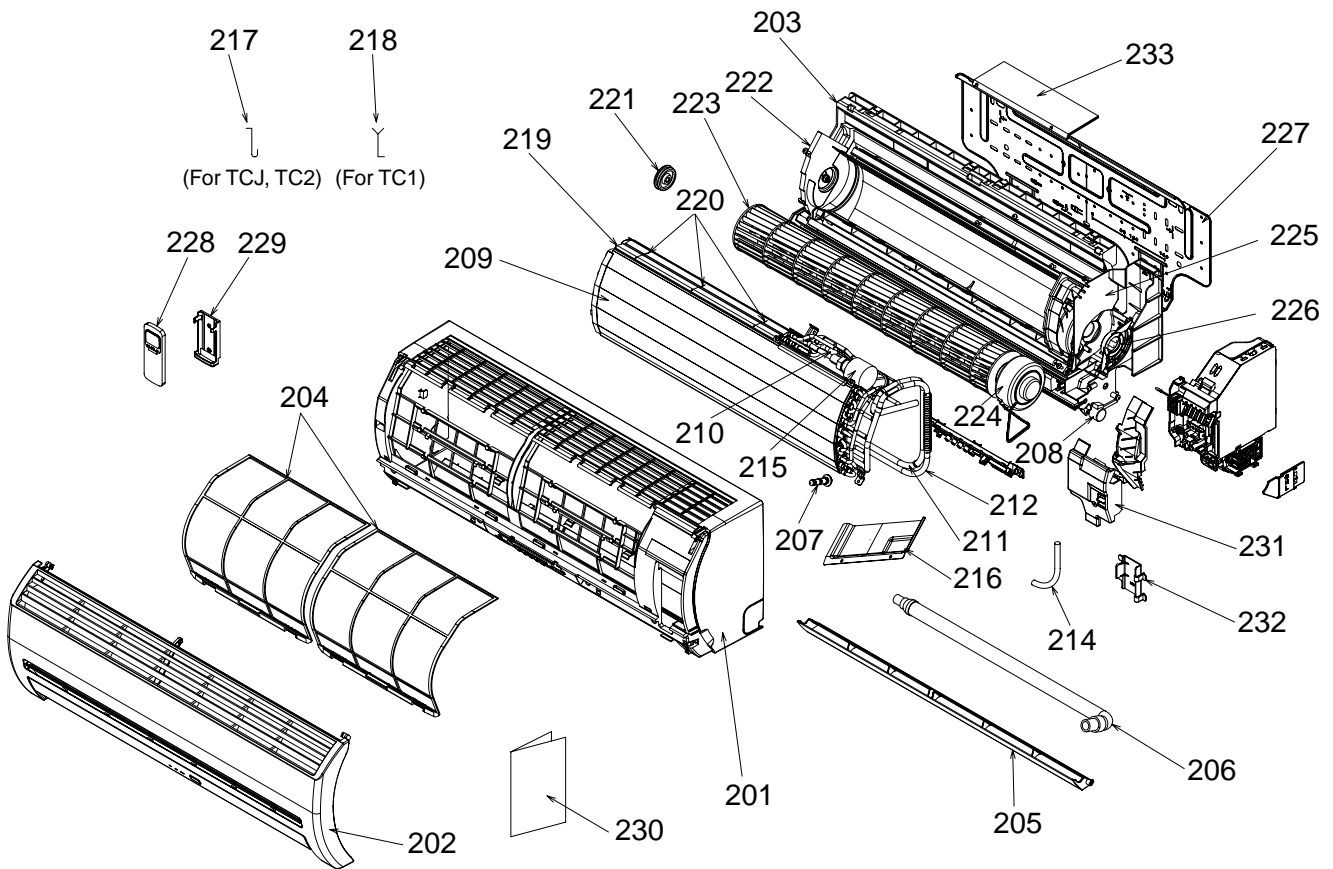

NOTE :

These service parts are supplied by TCTC.
TCTC: TOSHIBA CARRIER Thailand Co.

Location No.	Part	Description
201	43T00421	Front Panel Ass'y
202	43T09370	Suction Grille
203	43T03326	Back Body Ass'y
204	43T80301	Air Filter
205	43T09371	Horizontal Louver
206	43T70308	Drain Hose Ass'y
207	43T79301	Cap-Drain
208	43T21321	Motor, Stepping, MP24Z, DC12V
209	43T44370	Refrigeration Ass'y
210	43T44371	Distributor Ass'y
211	43T47340	Pipe Delivery
212	43T47341	Pipe Suction
214	43T11301	Pipe Shield
215	43T21354	Motor, P.M.V.
216	43T44370	Refrigeration Ass'y
217	43T19003	Fix-P-Sensor

Location No.	Part	Description
218	43T19321	Holder sensor
219	43T49317	Rubber Seal Evaporator
220	43T49006	Holder for Plate
221	43T22002	ASM-M-Bearing
222	43T39314	Base Bearing Ass'y
223	43T20302	Fan, Cross Flow
224	43T21344	Fan Motor, MF-340-30-1
225	43T39315	Band Motor, Left
226	43T39303	Band Motor, Right
227	43T82301	Plate, Installation
228	43T69309	Wireless Remote Controller, WH-H2UE
229	43T83003	Holder, Remote Controller
230	43T85497	Owner's Manual
231	43T62318	Terminal Cover
232	43T07303	Holder Pipe
233	43T62319	Cover, P.M.V. Ass'y

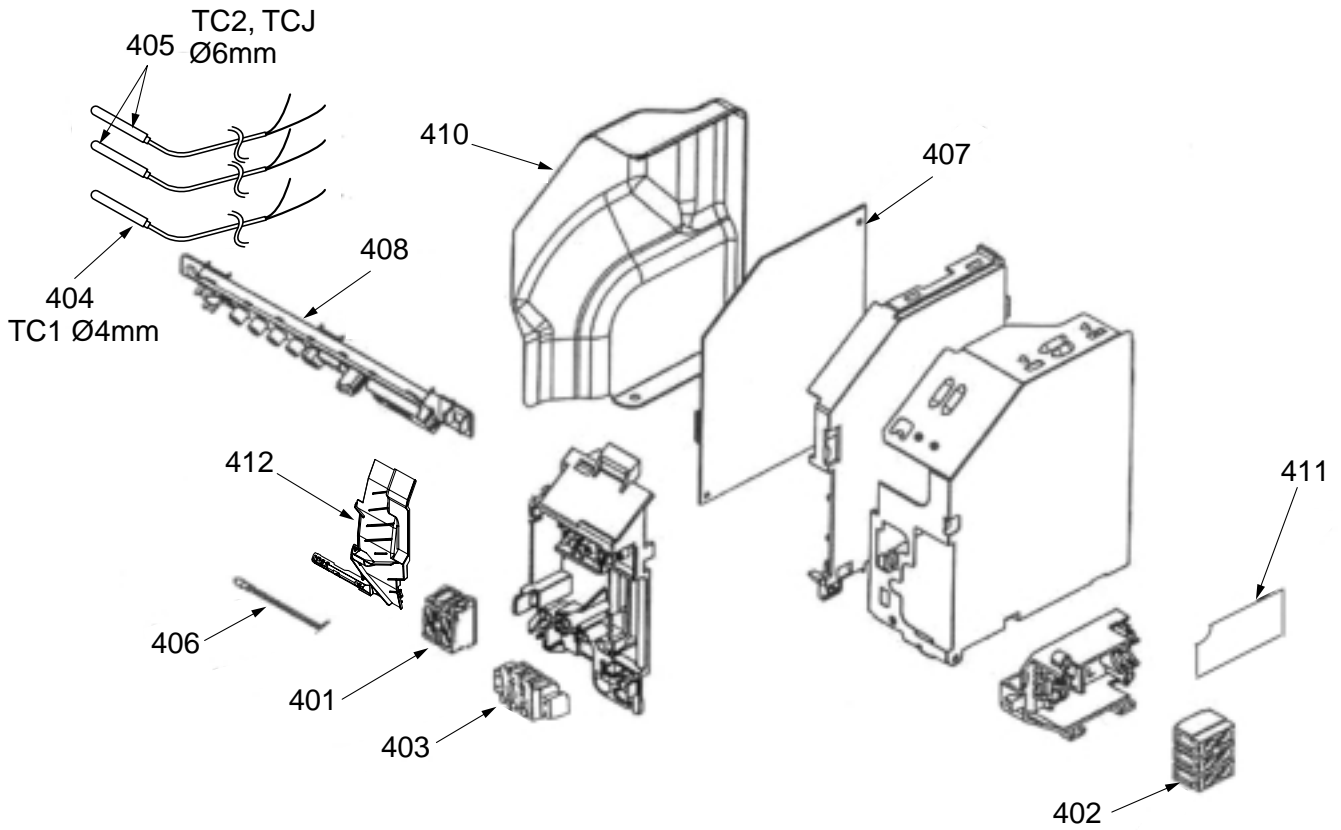

Location No.	Part	Description
401	43T60001	Terminal, 15A, 250V
402	43T60002	Terminal Block, 3P, 15A, 250V
403	43T60362	Terminal
404	43T50312	Sensor; Heat Exchanger
405	43T50303	Temperature sensor
406	43T50313	Sensor; Thermostat

Location No.	Part	Description
407	43T69428	P.C. Board
408	43T69429	Display Unit
409	43T62003	Cord Clamp
410	43T61301	Cover-Parts-E
411	43T62315	Cover-Connect-P
412	43T72307	Drain Guide

TOSHIBA CARRIER CORPORATION