

# TOSHIBA

FILE NO. A09-004  
Revised: Sep., 2009

## SERVICE MANUAL

# AIR-CONDITIONER SPLIT TYPE

### OUTDOOR UNIT

<DIGITAL INVERTER>

<b>RAV-SM2244AT8-E</b>	<b>RAV-SM2804AT8-E</b>
<b>RAV-SM2244AT8Z-E</b>	<b>RAV-SM2804AT8Z-E</b>
<b>RAV-SM2244AT8ZG-E</b>	<b>RAV-SM2804AT8ZG-E</b>
<b>RAV-SM2244AT7</b>	<b>RAV-SM2804AT7</b>
<b>RAV-SM2244AT7Z</b>	<b>RAV-SM2804AT7Z</b>
<b>RAV-SM2244AT7ZG</b>	<b>RAV-SM2804AT7ZG</b>



---

---

## Adoption of New Refrigerant

---

---

This Air Conditioner is a new type which adopts a new refrigerant HFC (R410A) instead of the conventional refrigerant R22 in order to prevent destruction of the ozone layer.

---

---

---

---

### WARNING

---

---

Cleaning of the air filter and other parts of the air filter involves dangerous work in high places, so be sure to have a service person do it. Do not attempt it yourself.

The cleaning diagram for the air filter is there for the service person, and not for the customer.

---

---

# CONTENTS



<b>SAFETY CAUTION .....</b>	<b>4</b>
<b>1. SPECIFICATIONS .....</b>	<b>11</b>
1-1. Indoor Unit.....	11
1-2. Outdoor Unit.....	24
1-3. Operation Characteristic Curve.....	25
<b>2. CONSTRUCTION VIEWS (EXTERNAL VIEWS).....</b>	<b>27</b>
2-1. Outdoor Unit.....	27
<b>3. OUTDOOR UNIT REFRIGERANTING CYCLE DIAGRAM .....</b>	<b>31</b>
<b>4. WIRING DIAGRAM .....</b>	<b>33</b>
4-1. Outdoor Unit.....	33
<b>5. SPECIFICATIONS OF ELECTRICAL PARTS .....</b>	<b>34</b>
5-1. Outdoor Unit .....	34
<b>6. REFRIGERANT R410A .....</b>	<b>35</b>
6-1. Safety During Installation/Serviceing .....	35
6-2. Refrigerant Piping Installation.....	35
6-3. Tools .....	39
6-4. Recharging of Refrigerant.....	39
6-5. Brazing of Pipes.....	40
6-6. Instructions for Re-use Piping of R22 or R407C .....	42

<b>7. CIRCUIT CONFIGURATION AND CONTROL SPECIFICATIONS .....</b>	<b>45</b>
7-1. Outdoor Unit Control .....	45
7-2. Outline of Main Controls .....	49
<b>8. TROUBLESHOOTING .....</b>	<b>55</b>
8-1. Summary of Troubleshooting.....	55
8-2. Troubleshooting .....	57
<b>9. SETUP AT LOCAL SITE AND OTHERS .....</b>	<b>80</b>
9-1. Calling of Error History .....	80
9-2. Group Control Operation .....	80
9-3. Outdoor Unit.....	82
<b>10. ADDRESS SETUP .....</b>	<b>89</b>
10-1. Address Setup Procedure .....	89
10-2. Address Setup & Group Control .....	90
10-3. Remote Controller Wiring .....	93
10-4. Address Setup (Manual setting from remote controller) .....	94
10-5. Confirmation of Indoor Unit No. Position .....	95
<b>11. INSTALLATION MANUAL .....</b>	<b>97</b>
<b>12. REPLACEMENT OF THE SERVICE P.C. BOARD (4316V392) MCC-1599 .....</b>	<b>110</b>
<b>13. HOW TO EXCHANGE COMPRESSOR .....</b>	<b>111</b>
13-1. Exchanging Procedure of Compressor (Outline).....	111
13-2. Exchange of Compressor .....	111
<b>14. DETACHMENTS .....</b>	<b>112</b>
14-1. Outdoor Unit.....	112
<b>15. EXPLODED VIEWS AND PARTS LIST .....</b>	<b>124</b>
15-1. Outdoor Unit.....	124
15-2. Inverter Assembly .....	126
15-3. Outdoor Unit.....	128
15-4. Inverter Assembly .....	130

# SAFETY CAUTION



The important contents concerned to the safety are described on the product itself and on this Service Manual. Please read this Service Manual after understanding the described items thoroughly in the following contents (Indications/Illustrated marks), and keep them.

## [Explanation of indications]

Indication	Explanation
 <b>DANGER</b>	Indicates contents assumed that an imminent danger causing a death or serious injury of the repair engineers and the third parties when an incorrect work has been executed.
 <b>WARNING</b>	Indicates possibilities assumed that a danger causing a death or serious injury of the repair engineers, the third parties, and the users due to troubles of the product after work when an incorrect work has been executed.
 <b>CAUTION</b>	Indicates contents assumed that an injury or property damage (*) may be caused on the repair engineers, the third parties, and the users due to troubles of the product after work when an incorrect work has been executed.

\* Property damage : Enlarged damage concerned to property, furniture, and domestic animal/pet





## [Explanation of illustrated marks]

Mark	Explanation
	Indicates prohibited items (Forbidden items to do) The sentences near an illustrated mark describe the concrete prohibited contents.
	Indicates mandatory items (Compulsory items to do) The sentences near an illustrated mark describe the concrete mandatory contents.
	Indicates cautions (Including danger/warning) The sentences or illustration near or in an illustrated mark describe the concrete cautious contents.









## [Confirmation of warning label on the main unit]







Confirm that labels are indicated on the specified positions (Refer to the Parts disassembly diagram (Outdoor unit).)



If removing the label during parts replace, stick it as the original.

 <b>DANGER</b>	
 Turn off breaker.	<p><b>Turn "OFF" the breaker before removing the front panel and cabinet, otherwise an electric shock is caused by high voltage resulted in a death or injury.</b></p> <p>During operation, a high voltage with 400V or higher of circuit (*) at secondary circuit of the high-voltage transformer is applied.</p> <p>If touching a high voltage with the naked hands or body, an electric shock is caused even if using an electric insulator.</p> <ul style="list-style-type: none"> <li>• Attach a plate indicating "WORKING" or others on the breaker so that you don't accidentally turn on the breaker during work.</li> </ul> <p>* : For details, refer to the electric wiring diagram.</p>
 Execute discharge between terminals.	<p><b>When removing the front panel or cabinet, execute short-circuit and discharge between high-voltage capacitor terminals.</b></p> <p>If discharge is not executed, an electric shock is caused by high voltage resulted in a death or injury. After turning off the breaker, high voltage also keeps to apply to the high-voltage capacitor.</p>
 Prohibition	<p><b>Do not turn on the breaker under condition that the front panel and cabinet are removed.</b></p> <p>An electric shock is caused by high voltage resulted in a death or injury.</p>

 **WARNING**

 Check earth wires.	<b>Before troubleshooting or repair work, check the earth wire is connected to the earth terminals of the main unit, otherwise an electric shock is caused when a leak occurs.</b> If the earth wire is not correctly connected, contact an electric engineer for rework.
 Prohibition of modification.	<b>Do not modify the products.</b> Do not also disassemble or modify the parts. It may cause a fire, electric shock or injury.
 Use specified parts.	<b>For spare parts, use those specified (*).</b> If unspecified parts are used, a fire or electric shock may be caused. *: For details, refer to the parts list.
 Do not bring a child close to the equipment.	<b>Before troubleshooting or repair work, do not bring a third party (a child, etc.) except the repair engineers close to the equipment.</b> It causes an injury with tools or disassembled parts. Please inform the users so that the third party (a child, etc.) does not approach the equipment.
 Insulating measures	<b>Connect the cut-off lead wires with crimp contact, etc, put the closed end side upward and then apply a water-cut method, otherwise a leak or production of fire is caused at the users' side.</b>
 No fire	<b>When repairing the refrigerating cycle, take the following measures.</b> 1) Be attentive to fire around the cycle. When using a gas stove, etc, be sure to put out fire before work; otherwise the oil mixed with refrigerant gas may catch fire. 2) Do not use a welder in the closed room. When using it without ventilation, carbon monoxide poisoning may be caused. 3) Do not bring inflammables close to the refrigerant cycle, otherwise fire of the welder may catch the inflammables.
 Refrigerant	<b>Check the used refrigerant name and use tools and materials of the parts which match with it.</b> For the products which use R410A refrigerant, the refrigerant name is indicated at a position on the outdoor unit where is easy to see. To prevent miss-charging, the route of the service port is changed from one of the former R22. <b>For an air conditioner which uses R410A, never use other refrigerant than R410A.</b> <b>For an air conditioner which uses other refrigerant (R22, etc.), never use R410A.</b> If different types of refrigerant are mixed, abnormal high pressure generates in the refrigerating cycle and an injury due to breakage may be caused. <b>Do not charge refrigerant additionally.</b> If charging refrigerant additionally when refrigerant gas leaks, the refrigerant composition in the refrigerating cycle changes resulted in change of air conditioner characteristics or refrigerant over the specified standard amount is charged and an abnormal high pressure is applied to the inside of the refrigerating cycle resulted in cause of breakage or injury. Therefore if the refrigerant gas leaks, recover the refrigerant in the air conditioner, execute vacuuming, and then newly recharge the specified amount of liquid refrigerant. In this time, never charge the refrigerant over the specified amount. <b>When recharging the refrigerant in the refrigerating cycle, do not mix the refrigerant or air other than R410A into the specified refrigerant.</b> If air or others is mixed with the refrigerant, abnormal high pressure generates in the refrigerating cycle resulted in cause of injury due to breakage. <b>After installation work, check the refrigerant gas does not leak.</b> If the refrigerant gas leaks in the room, poisonous gas generates when gas touches to fire such as fan heater, stove or cooking stove though the refrigerant gas itself is innocuous. <b>Never recover the refrigerant into the outdoor unit.</b> When the equipment is moved or repaired, be sure to recover the refrigerant with recovering device. The refrigerant cannot be recovered in the outdoor unit; otherwise a serious accident such as breakage or injury is caused.
 Assembly/Cabling	<b>After repair work, surely assemble the disassembled parts, and connect and lead the removed wires as before. Perform the work so that the cabinet or panel does not catch the inner wires.</b> If incorrect assembly or incorrect wire connection was done, a disaster such as a leak or fire is caused at user's side.

 <b>WARNING</b>	
 Insulator check	<p><b>After the work has finished, be sure to use an insulation tester set (500V Megger) to check the resistance is 2MΩ or more between the charge section and the non-charge metal section (Earth position).</b></p> <p>If the resistance value is low, a disaster such as a leak or electric shock is caused at user's side.</p>
 Ventilation	<p><b>When the refrigerant gas leaks during work, execute ventilation.</b></p> <p>If the refrigerant gas touches to a fire, poisonous gas generates. A case of leakage of the refrigerant and the closed room full with gas is dangerous because a shortage of oxygen occurs. Be sure to execute ventilation.</p>
 Be attentive to electric shock	<p><b>When checking the circuit inevitably under condition of the power-ON, use rubber gloves and others not to touch to the charging section.</b></p> <p>If touching to the charging section, an electric shock may be caused.</p>
 Compulsion	<p><b>When the refrigerant gas leaks, find up the leaked position and repair it surely.</b></p> <p>If the leaked position cannot be found up and the repair work is interrupted, pump-down and tighten the service valve, otherwise the refrigerant gas may leak into the room. The poisonous gas generates when gas touches to fire such as fan heater, stove or cooking stove though the refrigerant gas itself is innocuous.</p> <p><b>When installing equipment which includes a large amount of charged refrigerant such as a multi air conditioner in a sub-room, it is necessary that the density does not the limit even if the refrigerant leaks.</b></p> <p>If the refrigerant leaks and exceeds the limit density, an accident of shortage of oxygen is caused.</p> <p><b>For the installation/moving/reinstallation work, follow to the Installation Manual.</b></p> <p>If an incorrect installation is done, a trouble of the refrigerating cycle, water leak, electric shock or fire is caused.</p>
 Check after repair	<p><b>After repair work has finished, check there is no trouble.</b></p> <p>If check is not executed, a fire, electric shock or injury may be caused. For a check, turn off the power breaker.</p>
 Check after reinstallation	<p><b>After repair work (installation of front panel and cabinet) has finished, execute a test run to check there is no generation of smoke or abnormal sound.</b></p> <p>If check is not executed, a fire or an electric shock is caused. Before test run, install the front panel and cabinet.</p> <p><b>Check the following items after reinstallation.</b></p> <ol style="list-style-type: none"> <li>1) The earth wire is correctly connected.</li> <li>2) The power cord is not caught in the product.</li> <li>3) There is no inclination or unsteadiness and the installation is stable.</li> </ol> <p>If check is not executed, a fire, an electric shock or an injury is caused.</p>

 <b>CAUTION</b>	
 Put on gloves	<p><b>Be sure to put on the gloves (*) and a long sleeved shirt: otherwise an injury may be caused with the parts, etc.</b></p> <p>(*) Heavy gloves such as work gloves</p>
 Cooling check	<p><b>When the power was turned on, start to work after the equipment has been sufficiently cooled.</b></p> <p>As temperature of the compressor pipes and others became high due to cooling/heating operation, a burn may be caused.</p>

## • New Refrigerant (R410A)

This air conditioner adopts a new HFC type refrigerant (R410A) which does not deplete the ozone layer.

### 1. Safety Caution Concerned to New Refrigerant

The pressure of R410A is high 1.6 times of that of the former refrigerant (R22).

Accompanied with change of refrigerant, the refrigerating oil has been also changed.

Therefore, be sure that water, dust, the former refrigerant or the former refrigerating oil is not mixed into the refrigerating cycle of the air conditioner with new refrigerant during installation work or service work.

If an incorrect work or incorrect service is performed, there is a possibility to cause a serious accident.

Use the tools and materials exclusive to R410A to purpose a safe work.

### 2. Cautions on Installation/Service

1) Do not mix the other refrigerant or refrigerating oil.

For the tools exclusive to R410A, shapes of all the joints including the service port differ from those of the former refrigerant in order to prevent mixture of them.

2) As the use pressure of the new refrigerant is high, use material thickness of the pipe and tools which are specified for R410A.

3) In the installation time, use clean pipe materials and work with great attention so that water and others do not mix in because pipes are affected by impurities such as water, oxide scales, oil, etc.

Use the clean pipes.

Be sure to brazing with flowing nitrogen gas. (Never use gas other than nitrogen gas.)

4) For the earth protection, use a vacuum pump for air purge.

5) R410A refrigerant is azeotropic mixture type refrigerant.

Therefore use liquid type to charge the refrigerant. (If using gas for charging, composition of the refrigerant changes and then characteristics of the air conditioner change.)

### 3. Pipe Materials

For the refrigerant pipes, copper pipe and joints are mainly used.

It is necessary to select the most appropriate pipes to conform to the standard.

Use clean material in which impurities adhere inside of pipe or joint to a minimum.

#### 1) Copper pipe

---

#### <Piping>

The pipe thickness, flare finishing size, flare nut and others differ according to a refrigerant type.

When using a long copper pipe for R410A, it is recommended to select "Copper or copper-base pipe without seam" and one with bonded oil amount 40mg/10m or less.

Also do not use crushed, deformed, discolored (especially inside) pipes.

(Impurities cause clogging of expansion valves and capillary tubes.)

#### <Flare nut>

Use the flare nuts which are attached to the air conditioner unit.

---

#### 2) Joint

The flare joint and socket joint are used for joints of the copper pipe.

The joints are rarely used for installation of the air conditioner. However clear impurities when using them.

## 4. Tools

### 1. Required Tools for R410A

Mixing of different types of oil may cause a trouble such as generation of sludge, clogging of capillary, etc. Accordingly, the tools to be used are classified into the following three types.

- 1) Tools exclusive for R410A (Those which cannot be used for conventional refrigerant (R22))
- 2) Tools exclusive for R410A, but can be also used for conventional refrigerant (R22)
- 3) Tools commonly used for R410A and for conventional refrigerant (R22)

The table below shows the tools exclusive for R410A and their interchangeability.

#### Tools exclusive for R410A (The following tools for R410A are required.)

Tools whose specifications are changed for R410A and their interchangeability

No.	Used tool	Usage	R410A air conditioner installation		Conventional air conditioner installation
			Existence of new equipment for R410A	Whether conven- tional equipment can be used	Whether conventional equipment can be used
①	Flare tool	Pipe flaring	Yes	* (Note)	Yes
②	Copper pipe gauge for adjusting projection margin	Flaring by conventional flare tool	Yes	* (Note)	* (Note)
③	Torque wrench	Tightening of flare nut	Yes	No	No
④	Gauge manifold	Evacuating, refrigerant charge, run check, etc.	Yes	No	No
⑤	Charge hose				
⑥	Vacuum pump adapter	Vacuum evacuating	Yes	No	Yes
⑦	Electronic balance for refrigerant charging	Refrigerant charge	Yes	Yes	Yes
⑧	Refrigerant cylinder	Refrigerant charge	Yes	No	No
⑨	Leakage detector	Gas leakage check	Yes	No	Yes

**(Note)** When flaring is carried out for R410A using the conventional flare tools, adjustment of projection margin is necessary. For this adjustment, a copper pipe gauge, etc. are necessary.

#### General tools (Conventional tools can be used.)

In addition to the above exclusive tools, the following equipments which serve also for R22 are necessary as the general tools.

- 1) Vacuum pump. Use vacuum pump by attaching vacuum pump adapter.
- 2) Torque wrench
- 3) Pipe cutter
- 4) Reamer
- 5) Pipe bender
- 6) Level vial
- 7) Screwdriver (+, -)
- 8) Spanner or Monkey wrench
- 9) Hole core drill
- 10) Hexagon wrench (Opposite side 4mm)
- 11) Tape measure
- 12) Metal saw

Also prepare the following equipments for other installation method and run check.

- 1) Clamp meter
- 2) Thermometer
- 3) Insulation resistance tester (Megger)
- 4) Electroscop



## ■ Combination Pattern (Indoor Unit / Outdoor Unit)

### <RAV-SM2244AT series>

#### Simultaneous twin

4-way air discharge cassette type	Concealed duct type	Ceiling type
RAV-SM1104UT-E	RAV-SM1102BT-E	RAV-SM1102CT-E
RAV-SM1104UT-E	RAV-SM1102BT-E	RAV-SM1102CT-E

#### Simultaneous triple

4-way air discharge cassette type	Concealed duct type	Ceiling type	High wall type (2 series)
RAV-SM804UT-E	RAV-SM802BT-E	RAV-SM802CT-E	RAV-SM802KRT-E
RAV-SM804UT-E	RAV-SM802BT-E	RAV-SM802CT-E	RAV-SM802KRT-E
RAV-SM804UT-E	RAV-SM802BT-E	RAV-SM802CT-E	RAV-SM802KRT-E

#### Simultaneous double twin

4-way air discharge cassette type	Compact 4-way cassette (600×600) type	Slim duct type	Concealed duct type	Ceiling type	High wall type (2 series)
RAV-SM564UT-E	RAV-SM562MUT-E	RAV-SM564SDT-E	RAV-SM562BT-E	RAV-SM562CT-E	RAV-SM562KRT-E
RAV-SM564UT-E	RAV-SM562MUT-E	RAV-SM564SDT-E	RAV-SM562BT-E	RAV-SM562CT-E	RAV-SM562KRT-E
RAV-SM564UT-E	RAV-SM562MUT-E	RAV-SM564SDT-E	RAV-SM562BT-E	RAV-SM562CT-E	RAV-SM562KRT-E
RAV-SM564UT-E	RAV-SM562MUT-E	RAV-SM564SDT-E	RAV-SM562BT-E	RAV-SM562CT-E	RAV-SM562KRT-E

### <RAV-SM2804AT series>

#### Simultaneous twin

4-way air discharge cassette type	Concealed duct type	Ceiling type
RAV-SM1404UT-E	RAV-SM1402BT-E	RAV-SM1402CT-E
RAV-SM1404UT-E	RAV-SM1402BT-E	RAV-SM1402CT-E

#### Simultaneous triple

4-way air discharge cassette type	Concealed duct type	Ceiling type	High wall type (2 series)
RAV-SM804UT-E	RAV-SM802BT-E	RAV-SM802CT-E	RAV-SM802KRT-E
RAV-SM804UT-E	RAV-SM802BT-E	RAV-SM802CT-E	RAV-SM802KRT-E
RAV-SM804UT-E	RAV-SM802BT-E	RAV-SM802CT-E	RAV-SM802KRT-E

#### Simultaneous double twin

4-way air discharge cassette type	Concealed duct type	Ceiling type	High wall type (2 series)
RAV-SM804UT-E	RAV-SM802BT-E	RAV-SM802CT-E	RAV-SM802KRT-E
RAV-SM804UT-E	RAV-SM802BT-E	RAV-SM802CT-E	RAV-SM802KRT-E
RAV-SM804UT-E	RAV-SM802BT-E	RAV-SM802CT-E	RAV-SM802KRT-E
RAV-SM804UT-E	RAV-SM802BT-E	RAV-SM802CT-E	RAV-SM802KRT-E

	<b>RAV-SM2244AT series</b>	<b>Branch kit</b>
Simultaneous twin	SM110 — SM110	RBC-TWP101E
Simultaneous triple	SM80 — SM80 — SM80	RBC-TRP100E
Simultaneous double twin	SM56 — SM56 — SM56 — SM56	RBC-DTWP101E

	<b>RAV-SM2804AT series</b>	<b>Branch kit</b>
Simultaneous twin	SM140 — SM140	RBC-TWP101E
Simultaneous triple	SM80 — SM80 — SM80	RBC-TRP100E
Simultaneous double twin	SM80 — SM80 — SM80 — SM80	RBC-DTWP101E

# 1. SPECIFICATIONS

## 1-1. Indoor Unit

### 1-1-1. 4-Way Cassette Type

<Twin type>

Model	Indoor unit 1		RAV-SM	1104UT-E	1404UT-E	1104UT-E	1404UT-E	
	Indoor unit 2		RAV-SM	1104UT-E	1404UT-E	1104UT-E	1404UT-E	
	Outdoor unit		RAV-SM	2244AT8-E	2804AT8-E	2244AT7	2804AT7	
Cooling capacity			(kW)	20.0	23.0	20.0	23.0	
Heating capacity			(kW)	22.4	27.0	22.4	27.0	
Power supply				3 phase 380 – 415V 50Hz		3 phase 380V 60Hz		
<b>Indoor unit</b>								
Electrical characteristics	Cooling	Running current		(A)	10.09 – 9.24	13.24 – 12.12	10.09	13.24
		Power consumption		(kW)	6.24	8.19	6.24	8.19
		Power factor		(%)	94	94	94	94
		EER			3.21	2.81	3.21	2.81
		Energy efficiency class *			A	C	—	—
	Heating	Running current		(A)	9.41 – 8.61	12.09 – 11.07	9.41	12.09
		Power consumption		(kW)	5.82	7.48	5.82	7.48
		Power factor		(%)	94	94	94	94
		COP			3.85	3.61	3.85	3.61
		Energy efficiency class *			A	A	—	—
Maximum current			(A)	18	22	18	22	
Fan unit	Fan			Turbo fan	Turbo fan	Turbo fan	Turbo fan	
	Standard air flow	H/M/L	(m <sup>3</sup> /min.)	33.5/24.0/19.5	35.0/24.0/20.5	33.5/24.0/19.5	35.0/24.0/20.5	
	Motor			(W)	68	72	68	72
Sound pressure level			H/M/L	(dB•A)	43 / 38 / 33	44 / 38 / 34	43 / 38 / 33	44 / 38 / 34
Sound power level			H/M/L	(dB•A)	58 / 53 / 48	59 / 53 / 49	58 / 53 / 48	59 / 53 / 49
<b>Outdoor unit</b>								
Outer dimension	Max. total length			(m)	70	70	70	70
	Min. length			(m)	7.5	7.5	7.5	7.5
	Height difference	Outdoor lower		(m)	30	30	30	30
		Outdoor high		(m)	30	30	30	30
Fan unit	Fan			Propeller fan	Propeller fan	Propeller fan	Propeller fan	
	Standard air flow high			(m <sup>3</sup> /min.)	133	133	133	133
	Motor			(W)	100 + 100	100 + 100	100 + 100	100 + 100
Connecting pipe	Outdoor unit – Pipe branch		Gas side	(mm)	28.6	28.6	28.6	28.6
			Liquid side	(mm)	12.7	12.7	12.7	12.7
	Pipe branch – Indoor unit		Gas side	(mm)	15.9	15.9	15.9	15.9
			Liquid side	(mm)	9.5	9.5	9.5	9.5
Sound pressure level			Cooling / Heating	(dB•A)	56 / 57	57 / 58	56 / 57	57 / 58
Sound power level			Cooling / Heating	(dB•A)	72 / 74	74 / 75	72 / 74	74 / 75

\* : IEC standard

## 1-1-2. Duct Type

### <Twin type>

Model	Indoor unit 1		RAV-SM	1102BT-E	1402BT-E	1102BT-E	14002BT-E	
	Indoor unit 2		RAV-SM	1102BT-E	1402BT-E	1102BT-E	1402BT-E	
	Outdoor unit		RAV-SM	2244AT8-E	2804AT8-E	2244AT7	2804AT7	
Cooling capacity			(kW)	20.0	23.0	20.0	23.0	
Heating capacity			(kW)	22.4	27.0	22.4	27.0	
Power supply				3 phase 380 – 415V 50Hz		3 phase 380V 60Hz		
<b>Indoor unit</b>								
Electrical characteristics	Cooling	Running current		(A)	11.51 – 10.54	15.44 – 14.13	11.51	15.44
		Power consumption		(kW)	7.12	9.55	7.12	9.55
		Power factor		(%)	94	94	94	94
		EER			2.81	2.41	2.81	2.41
		Energy efficiency class *			C	E	—	—
	Heating	Running current		(A)	10.34 – 9.47	12.80 – 11.72	10.34	12.80
		Power consumption		(kW)	6.40	7.92	6.40	7.92
		Power factor		(%)	94	94	94	94
		COP			3.50	3.41	3.50	3.41
		Energy efficiency class *			B	B	—	—
Maximum current			(A)	18	22	18	22	
Fan unit	Fan			Centrifugal	Centrifugal	Centrifugal	Centrifugal	
	Standard air flow	H/M/L	(m <sup>3</sup> /min.)	27.0/23.0/18.9	33.0/28.0/23.1	27.0/23.0/18.9	33.0/28.0/23.1	
	Motor			(W)	120	120	120	120
Sound pressure level			H/M/L	(dB•A)	42 / 39 / 36	44 / 41 / 38	42 / 39 / 36	44 / 41 / 38
Sound power level			H/M/L	(dB•A)	57 / 54 / 51	59 / 56 / 53	57 / 54 / 51	59 / 56 / 53
<b>Outdoor unit</b>								
Outer dimension	Max. total length			(m)	70	70	70	70
	Min. length			(m)	7.5	7.5	7.5	7.5
	Height difference	Outdoor lower		(m)	30	30	30	30
		Outdoor high		(m)	30	30	30	30
Fan unit	Fan			Propeller fan	Propeller fan	Propeller fan	Propeller fan	
	Standard air flow high			(m <sup>3</sup> /min.)	133	133	133	133
	Motor			(W)	100 + 100	100 + 100	100 + 100	100 + 100
Connecting pipe	Outdoor unit – Pipe branch		Gas side	(mm)	28.6	28.6	28.6	28.6
			Liquid side	(mm)	12.7	12.7	12.7	12.7
	Pipe branch – Indoor unit		Gas side	(mm)	15.9	15.9	15.9	15.9
			Liquid side	(mm)	9.5	9.5	9.5	9.5
Sound pressure level			Cooling / Heating	(dB•A)	56 / 57	57 / 58	56 / 57	57 / 58
Sound power level			Cooling / Heating	(dB•A)	72 / 74	74 / 75	72 / 74	74 / 75

\* : IEC standard

### 1-1-3. Ceiling Type

#### <Twin type>

Model	Indoor unit 1		RAV-SM	1102CT-E	1402CT-E	1102CT-E	1402CT-E	
	Indoor unit 2		RAV-SM	1102CT-E	1402CT-E	1102CT-E	1402CT-E	
	Outdoor unit		RAV-SM	2244AT8-E	2804AT8-E	2244AT7	2804AT7	
Cooling capacity			(kW)	20.0	23.0	20.0	23.0	
Heating capacity			(kW)	22.4	27.0	22.4	27.0	
Power supply				3 phase 380 – 415V 50Hz		3 phase 380V 60Hz		
<b>Indoor unit</b>								
Electrical characteristics	Cooling	Running current		(A)	11.51 – 10.54	15.44 – 14.13	11.51	15.44
		Power consumption		(kW)	7.12	9.55	7.12	9.55
		Power factor		(%)	94	94	94	94
		EER			2.81	2.41	2.81	2.41
		Energy efficiency class *			C	E	—	—
	Heating	Running current		(A)	10.34 – 9.47	12.80 – 11.72	10.34	12.80
		Power consumption		(kW)	6.40	7.92	6.40	7.92
		Power factor		(%)	94	94	94	94
		COP			3.50	3.41	3.50	3.41
		Energy efficiency class *			B	B	—	—
Maximum current			(A)	18	22	18	22	
Fan unit	Fan			Centrifugal	Centrifugal	Centrifugal	Centrifugal	
	Standard air flow	H/M/L	(m <sup>3</sup> /min.)	27.5/24.0/21.2	30.0/26.0/23.1	27.5/24.0/21.2	30.0/26.0/23.1	
	Motor			(W)	120	120	120	120
Sound pressure level			H/M/L	(dB•A)	41 / 38 / 35	43 / 40 / 37	41 / 38 / 35	43 / 40 / 37
Sound power level			H/M/L	(dB•A)	56 / 53 / 50	58 / 55 / 52	56 / 53 / 50	58 / 55 / 52
<b>Outdoor unit</b>								
Outer dimension	Max. total length			(m)	70	70	70	70
	Min. length			(m)	7.5	7.5	7.5	7.5
	Height difference	Outdoor lower		(m)	30	30	30	30
		Outdoor high		(m)	30	30	30	30
Fan unit	Fan			Propeller fan	Propeller fan	Propeller fan	Propeller fan	
	Standard air flow high			(m <sup>3</sup> /min.)	133	133	133	133
	Motor			(W)	100 + 100	100 + 100	100 + 100	100 + 100
Connecting pipe	Outdoor unit – Pipe branch		Gas side	(mm)	28.6	28.6	28.6	28.6
			Liquid side	(mm)	12.7	12.7	12.7	12.7
	Pipe branch – Indoor unit		Gas side	(mm)	15.9	15.9	15.9	15.9
			Liquid side	(mm)	9.5	9.5	9.5	9.5
Sound pressure level			Cooling / Heating	(dB•A)	56 / 57	57 / 58	56 / 57	57 / 58
Sound power level			Cooling / Heating	(dB•A)	72 / 74	74 / 75	72 / 74	74 / 75

\* : IEC standard

### 1-1-4. 4-Way Cassette Type

#### <Triple type>

Model	Indoor unit 1		RAV-SM	804UT-E	804UT-E	804UT-E	804UT-E	
	Indoor unit 2		RAV-SM	804UT-E	804UT-E	804UT-E	804UT-E	
	Indoor unit 3		RAV-SM	804UT-E	804UT-E	804UT-E	804UT-E	
	Outdoor unit		RAV-SM	2244AT8-E	2804AT8-E	2244AT7	2804AT7	
Cooling capacity			(kW)	20.0	23.0	20.0	23.0	
Heating capacity			(kW)	22.4	27.0	22.4	27.0	
Power supply				3 phase 380 – 415V 50Hz		3 phase 380V 60Hz		
<b>Indoor unit</b>								
Electrical characteristics	Cooling	Running current		(A)	11.51 – 10.54	15.44 – 14.13	11.51	15.44
		Power consumption		(kW)	7.12	9.55	7.12	9.55
		Power factor		(%)	94	94	94	94
		EER			2.81	2.41	2.81	2.41
		Energy efficiency class *			C	E	—	—
	Heating	Running current		(A)	10.34 – 9.47	12.80 – 11.72	10.34	12.80
		Power consumption		(kW)	6.40	7.92	6.40	7.92
		Power factor		(%)	94	94	94	94
		COP			3.50	3.41	3.50	3.41
		Energy efficiency class *			B	B	—	—
Maximum current			(A)	18	22	18	22	
Fan unit	Fan			Turbo fan	Turbo fan	Turbo fan	Turbo fan	
	Standard air flow	H/M/L	(m <sup>3</sup> /min.)	20.5/16.0/13.5	20.5/16.0/13.5	20.5/16.0/13.5	20.5/16.0/13.5	
	Motor			(W)	20	20	20	20
Sound pressure level			H/M/L	(dB•A)	35 / 31 / 28	35 / 31 / 28	35 / 31 / 28	35 / 31 / 28
Sound power level			H/M/L	(dB•A)	50 / 46 / 43	50 / 46 / 43	50 / 46 / 43	50 / 46 / 43
<b>Outdoor unit</b>								
Outer dimension	Max. total length			(m)	70	70	70	70
	Min. length			(m)	7.5	7.5	7.5	7.5
	Height difference	Outdoor lower		(m)	30	30	30	30
		Outdoor high		(m)	30	30	30	30
Fan unit	Fan			Propeller fan	Propeller fan	Propeller fan	Propeller fan	
	Standard air flow high			(m <sup>3</sup> /min.)	133	133	133	133
	Motor			(W)	100 + 100	100 + 100	100 + 100	100 + 100
Connecting pipe	Outdoor unit – Pipe branch		Gas side	(mm)	28.6	28.6	28.6	28.6
			Liquid side	(mm)	12.7	12.7	12.7	12.7
	Pipe branch – Indoor unit		Gas side	(mm)	15.9	15.9	15.9	15.9
			Liquid side	(mm)	9.5	9.5	9.5	9.5
Sound pressure level			Cooling / Heating	(dB•A)	56 / 57	57 / 58	56 / 57	57 / 58
Sound power level			Cooling / Heating	(dB•A)	72 / 74	74 / 75	72 / 74	74 / 75

\* : IEC standard

## 1-1-5. Duct Type

### <Triple type>

Model	Indoor unit 1		RAV-SM	802BT-E	802BT-E	802BT-E	802BT-E	
	Indoor unit 2		RAV-SM	802BT-E	802BT-E	802BT-E	802BT-E	
	Indoor unit 3		RAV-SM	802BT-E	802BT-E	802BT-E	802BT-E	
	Outdoor unit		RAV-SM	2244AT8-E	2804AT8-E	2244AT7	2804AT7	
Cooling capacity			(kW)	20.0	23.0	20.0	23.0	
Heating capacity			(kW)	22.4	27.0	22.4	27.0	
Power supply				3 phase 380 – 415V 50Hz		3 phase 380V 60Hz		
<b>Indoor unit</b>								
Electrical characteristics	Cooling	Running current		(A)	11.51 – 10.54	15.44 – 14.13	11.51	15.44
		Power consumption		(kW)	7.12	9.55	7.12	9.55
		Power factor		(%)	94	94	94	94
		EER			2.81	2.41	2.81	2.41
		Energy efficiency class *			C	E	—	—
	Heating	Running current		(A)	10.34 – 9.47	12.80 – 11.72	10.34	12.80
		Power consumption		(kW)	6.40	7.92	6.40	7.92
		Power factor		(%)	94	94	94	94
		COP			3.50	3.41	3.50	3.41
		Energy efficiency class *			B	B	—	—
Maximum current			(A)	18	22	18	22	
Fan unit	Fan			Centrifugal	Centrifugal	Centrifugal	Centrifugal	
	Standard air flow	H/M/L	(m <sup>3</sup> /min.)	19.0/16.2/13.3	19.0/16.2/13.3	19.0/16.2/13.3	19.0/16.2/13.3	
	Motor			(W)	120	120	120	120
Sound pressure level			H/M/L	(dB•A)	40 / 37 / 34	40 / 37 / 34	40 / 37 / 34	40 / 37 / 34
Sound power level			H/M/L	(dB•A)	55 / 52 / 49	55 / 52 / 49	55 / 52 / 49	55 / 52 / 49
<b>Outdoor unit</b>								
Outer dimension	Max. total length			(m)	70	70	70	70
	Min. length			(m)	7.5	7.5	7.5	7.5
	Height difference	Outdoor lower		(m)	30	30	30	30
		Outdoor high		(m)	30	30	30	30
Fan unit	Fan			Propeller fan	Propeller fan	Propeller fan	Propeller fan	
	Standard air flow high			(m <sup>3</sup> /min.)	133	133	133	133
	Motor			(W)	100 + 100	100 + 100	100 + 100	100 + 100
Connecting pipe	Outdoor unit – Pipe branch		Gas side	(mm)	28.6	28.6	28.6	28.6
			Liquid side	(mm)	12.7	12.7	12.7	12.7
	Pipe branch – Indoor unit		Gas side	(mm)	15.9	15.9	15.9	15.9
			Liquid side	(mm)	9.5	9.5	9.5	9.5
Sound pressure level			Cooling / Heating	(dB•A)	56 / 57	57 / 58	56 / 57	57 / 58
Sound power level			Cooling / Heating	(dB•A)	72 / 74	74 / 75	72 / 74	74 / 75

\* : IEC standard

## 1-1-6. Ceiling Type

### <Triple type>

Model	Indoor unit 1		RAV-SM	802CT-E	802CT-E	802CT-E	802CT-E	
	Indoor unit 2		RAV-SM	802CT-E	802CT-E	802CT-E	802CT-E	
	Indoor unit 3		RAV-SM	802CT-E	802CT-E	802CT-E	802CT-E	
	Outdoor unit		RAV-SM	2244AT8-E	2804AT8-E	2244AT7	2804AT7	
Cooling capacity			(kW)	20.0	23.0	20.0	23.0	
Heating capacity			(kW)	22.4	27.0	22.4	27.0	
Power supply				3 phase 380 – 415V 50Hz		3 phase 380V 60Hz		
<b>Indoor unit</b>								
Electrical characteristics	Cooling	Running current		(A)	11.51 – 10.54	15.44 – 14.13	11.51	15.44
		Power consumption		(kW)	7.12	9.55	7.12	9.55
		Power factor		(%)	94	94	94	94
		EER			2.81	2.41	2.81	2.41
		Energy efficiency class *			C	E	—	—
	Heating	Running current		(A)	10.34 – 9.47	12.80 – 11.72	10.34	12.80
		Power consumption		(kW)	6.40	7.92	6.40	7.92
		Power factor		(%)	94	94	94	94
		COP			3.50	3.41	3.50	3.41
		Energy efficiency class *			B	B	—	—
Maximum current			(A)	18	22	18	22	
Fan unit	Fan				Centrifugal	Centrifugal	Centrifugal	Centrifugal
	Standard air flow	H/M/L	(m <sup>3</sup> /min.)	18.5/16.7/14.6	18.5/16.7/14.6	18.5/16.7/14.6	18.5/16.7/14.6	
	Motor			(W)	60	60	60	60
Sound pressure level			H/M/L	(dB•A)	38 / 36 / 33	38 / 36 / 33	38 / 36 / 33	38 / 36 / 33
Sound power level			H/M/L	(dB•A)	53 / 51 / 48	53 / 51 / 48	53 / 51 / 48	53 / 51 / 48
<b>Outdoor unit</b>								
Outer dimension	Max. total length			(m)	70	70	70	70
	Min. length			(m)	7.5	7.5	7.5	7.5
	Height difference	Outdoor lower		(m)	30	30	30	30
		Outdoor high		(m)	30	30	30	30
Fan unit	Fan				Propeller fan	Propeller fan	Propeller fan	Propeller fan
	Standard air flow high			(m <sup>3</sup> /min.)	133	133	133	133
	Motor			(W)	100 + 100	100 + 100	100 + 100	100 + 100
Connecting pipe	Outdoor unit – Pipe branch		Gas side	(mm)	28.6	28.6	28.6	28.6
			Liquid side	(mm)	12.7	12.7	12.7	12.7
	Pipe branch – Indoor unit		Gas side	(mm)	15.9	15.9	15.9	15.9
			Liquid side	(mm)	9.5	9.5	9.5	9.5
Sound pressure level			Cooling / Heating	(dB•A)	56 / 57	57 / 58	56 / 57	57 / 58
Sound power level			Cooling / Heating	(dB•A)	72 / 74	74 / 75	72 / 74	74 / 75

\* : IEC standard



## 1-1-7. High Wall Type

### <Triple type>

Model	Indoor unit 1		RAV-SM	802KRT-E	802KRT-E	802KRT-E	802KRT-E	
	Indoor unit 2		RAV-SM	802KRT-E	802KRT-E	802KRT-E	802KRT-E	
	Indoor unit 3		RAV-SM	802KRT-E	802KRT-E	802KRT-E	802KRT-E	
	Outdoor unit		RAV-SM	2244AT8-E	2804AT8-E	2244AT7	2804AT7	
Cooling capacity			(kW)	20.0	23.0	20.0	23.0	
Heating capacity			(kW)	22.4	27.0	22.4	27.0	
Power supply				3 phase 380 – 415V 50Hz		3 phase 380V 60Hz		
<b>Indoor unit</b>								
Electrical characteristics	Cooling	Running current		(A)	11.51 – 10.54	15.44 – 14.13	11.51	15.44
		Power consumption		(kW)	7.12	9.55	7.12	9.55
		Power factor		(%)	94	94	94	94
		EER			2.81	2.41	2.81	2.41
		Energy efficiency class *			C	E	—	—
	Heating	Running current		(A)	10.34 – 9.47	12.80 – 11.72	10.34	12.80
		Power consumption		(kW)	6.40	7.92	6.40	7.92
		Power factor		(%)	94	94	94	94
		COP			3.50	3.41	3.50	3.41
		Energy efficiency class *			B	B	—	—
Maximum current			(A)	18	22	18	22	
Fan unit	Fan			Cross flow fan	Cross flow fan	Cross flow fan	Cross flow fan	
	Standard air flow	H/M/L	(m <sup>3</sup> /min.)	18.5/14.6/12.2	18.5/14.6/12.2	18.5/14.6/12.2	18.5/14.6/12.2	
	Motor			(W)	30	30	30	
Sound pressure level			H/M/L	(dB•A)	45 / 41 / 36	45 / 41 / 36	45 / 41 / 36	
Sound power level			H/M/L	(dB•A)	60 / 56 / 51	60 / 56 / 51	60 / 56 / 51	
<b>Outdoor unit</b>								
Outer dimension	Max. total length			(m)	70	70	70	70
	Min. length			(m)	7.5	7.5	7.5	7.5
	Height difference	Outdoor lower		(m)	30	30	30	30
		Outdoor high		(m)	30	30	30	30
Fan unit	Fan			Propeller fan	Propeller fan	Propeller fan	Propeller fan	
	Standard air flow high			(m <sup>3</sup> /min.)	133	133	133	133
	Motor			(W)	100 + 100	100 + 100	100 + 100	100 + 100
Connecting pipe	Outdoor unit – Pipe branch		Gas side	(mm)	28.6	28.6	28.6	28.6
			Liquid side	(mm)	12.7	12.7	12.7	12.7
	Pipe branch – Indoor unit		Gas side	(mm)	15.9	15.9	15.9	15.9
			Liquid side	(mm)	9.5	9.5	9.5	9.5
Sound pressure level			Cooling / Heating	(dB•A)	56 / 57	57 / 58	56 / 57	57 / 58
Sound power level			Cooling / Heating	(dB•A)	72 / 74	74 / 75	72 / 74	74 / 75

\* : IEC standard

## 1-1-8. 4-Way Cassette Type

### <Double twin type>

Model	Indoor unit 1		RAV-SM	564UT-E	804UT-E	564UT-E	804UT-E	
	Indoor unit 2		RAV-SM	564UT-E	804UT-E	564UT-E	804UT-E	
	Indoor unit 3		RAV-SM	564UT-E	804UT-E	564UT-E	804UT-E	
	Indoor unit 4		RAV-SM	564UT-E	804UT-E	564UT-E	804UT-E	
	Outdoor unit		RAV-SM	2244AT8-E	2804AT8-E	2244AT7	2804AT7	
Cooling capacity			(kW)	20.0	23.0	20.0	23.0	
Heating capacity			(kW)	22.4	27.0	22.4	27.0	
Power supply				3 phase 380 – 415V 50Hz		3 phase 380V 60Hz		
<b>Indoor unit</b>								
Electrical characteristics	Cooling	Running current		(A)	11.51 – 10.54	15.44 – 14.13	11.51	15.44
		Power consumption		(kW)	7.12	9.55	7.12	9.55
		Power factor		(%)	94	94	94	94
		EER			2.81	2.41	2.81	2.41
		Energy efficiency class *			C	E	—	—
	Heating	Running current		(A)	10.34 – 9.47	12.80 – 11.72	10.34	12.80
		Power consumption		(kW)	6.40	7.92	6.40	7.92
		Power factor		(%)	94	94	94	94
		COP			3.50	3.41	3.50	3.41
		Energy efficiency class *			B	B	—	—
Maximum current		(A)	18	22	18	22		
Fan unit	Fan			Turbo fan	Turbo fan	Turbo fan	Turbo fan	
	Standard air flow	H/M/L	(m <sup>3</sup> /min.)	17.5/14.5/13.0	20.5/16.0/13.5	17.5/14.5/13.0	20.5/16.0/13.5	
	Motor		(W)	14	20	14	20	
Sound pressure level			H/M/L	(dB•A)	32 / 29 / 28	35 / 31 / 28	32 / 29 / 28	35 / 31 / 28
Sound power level			H/M/L	(dB•A)	47 / 44 / 43	50 / 46 / 43	47 / 44 / 43	50 / 46 / 43
<b>Outdoor unit</b>								
Outer dimension	Max. total length		(m)	70	70	70	70	
	Min. length		(m)	7.5	7.5	7.5	7.5	
	Height difference	Outdoor lower		(m)	30	30	30	30
		Outdoor high		(m)	30	30	30	30
Fan unit	Fan			Propeller fan	Propeller fan	Propeller fan	Propeller fan	
	Standard air flow high		(m <sup>3</sup> /min.)	133	133	133	133	
	Motor		(W)	100 + 100	100 + 100	100 + 100	100 + 100	
Connecting pipe	Outdoor unit – Pipe branch		Gas side	(mm)	28.6	28.6	28.6	28.6
			Liquid side	(mm)	12.7	12.7	12.7	12.7
	Pipe branch – Indoor unit		Gas side	(mm)	15.9	15.9	15.9	15.9
			Liquid side	(mm)	9.5	9.5	9.5	9.5
Sound pressure level			Cooling / Heating	(dB•A)	56 / 57	57 / 58	56 / 57	57 / 58
Sound power level			Cooling / Heating	(dB•A)	72 / 74	74 / 75	72 / 74	74 / 75

\* : IEC standard

### 1-1-9. Compact 4-Way Cassette (600 × 600) Type

#### <Double twin type>

Model	Indoor unit 1		RAV-SM562MUT-E	RAV-SM562MUT-E	
	Indoor unit 2		RAV-SM562MUT-E	RAV-SM562MUT-E	
	Indoor unit 3		RAV-SM562MUT-E	RAV-SM562MUT-E	
	Indoor unit 4		RAV-SM562MUT-E	RAV-SM562MUT-E	
	Outdoor unit		RAV-SM2244AT8-E	RAV-SM2244AT7	
Cooling capacity (kW)			20.0	20.0	
Heating capacity (kW)			22.4	22.4	
Power supply			3 phase 380 – 415V 50Hz	3 phase 380V 60Hz	
<b>Indoor unit</b>					
Electrical characteristics	Cooling	Running current (A)		11.51 – 10.54	11.51
		Power consumption (kW)		7.12	7.12
		Power factor (%)		94	94
		EER		2.81	2.81
		Energy efficiency class *		C	—
	Heating	Running current (A)		10.34 – 9.47	10.34
		Power consumption (kW)		6.40	6.40
		Power factor (%)		94	94
		COP		3.50	3.50
		Energy efficiency class *		B	—
Maximum current (A)		18	18		
Fan unit	Fan		Turbo fan	Turbo fan	
	Standard air flow	H/M/L (m <sup>3</sup> /min.)	13.3 / 11.2 / 9.1	13.3 / 11.2 / 9.1	
	Motor (W)		60	60	
Sound pressure level		H/M/L (dB•A)	43 / 39 / 34	43 / 39 / 34	
Sound power level		H/M/L (dB•A)	58 / 54 / 49	58 / 54 / 49	
<b>Outdoor unit</b>					
Outer dimension	Max. total length (m)		70	70	
	Min. length (m)		7.5	7.5	
	Height difference	Outdoor lower (m)	30	30	
		Outdoor high (m)	30	30	
Fan unit	Fan		Propeller fan	Propeller fan	
	Standard air flow high (m <sup>3</sup> /min.)		133	133	
	Motor (W)		100 + 100	100 + 100	
Connecting pipe	Outdoor unit – First pipe branch	Gas side (mm)	28.6	28.6	
		Liquid side (mm)	12.7	12.7	
	First pipe branch – Second pipe branch	Gas side (mm)	15.9	15.9	
		Liquid side (mm)	9.5	9.5	
	Second pipe branch – Indoor unit	Gas side (mm)	12.7	12.7	
		Liquid side (mm)	6.4	6.4	
Sound pressure level		Cooling / Heating (dB•A)	56 / 57	56 / 57	
Sound power level		Cooling / Heating (dB•A)	72 / 74	72 / 74	

\* : IEC standard

## 1-1-10. Slim Duct Type

### <Double twin type>

Model	Indoor unit 1		RAV-SM564SDT-E	RAV-SM564SDT-E	
	Indoor unit 2		RAV-SM564SDT-E	RAV-SM564SDT-E	
	Indoor unit 3		RAV-SM564SDT-E	RAV-SM564SDT-E	
	Indoor unit 4		RAV-SM564SDT-E	RAV-SM564SDT-E	
	Outdoor unit		RAV-SM2244AT8-E	RAV-SM2244AT7	
Cooling capacity (kW)			20.0	20.0	
Heating capacity (kW)			22.4	22.4	
Power supply			3 phase 380 – 415V 50Hz	3 phase 380V 60Hz	
<b>Indoor unit</b>					
Electrical characteristics	Cooling	Running current (A)		11.51 – 10.54	11.51
		Power consumption (kW)		7.12	7.12
		Power factor (%)		94	94
		EER		2.81	2.81
		Energy efficiency class *		C	—
	Heating	Running current (A)		10.34 – 9.47	10.34
		Power consumption (kW)		6.40	6.40
		Power factor (%)		94	94
		COP		3.50	3.50
		Energy efficiency class *		B	—
		Maximum current (A)	18	18	
Fan unit	Fan		Centrifugal fan	Centrifugal fan	
	Standard air flow	H/M/L (m <sup>3</sup> /min.)	13.0 / 11.3 / 9.7	13.0 / 11.3 / 9.7	
	Motor (W)		60	60	
	External static pressure	Standard (at shipment) (Pa)	10	10	
		Set up for tap exchange (Pa)	10 / 20 / 35 / 50	10 / 20 / 35 / 50	
Sound pressure level	Under air inlet	H/M/L (dB•A)	45 / 40 / 36	45 / 40 / 36	
	Back air inlet	H/M/L (dB•A)	33 / 31 / 28	33 / 31 / 28	
Sound power level	Under air inlet	H/M/L (dB•A)	60 / 55 / 51	60 / 55 / 51	
	Back air inlet	H/M/L (dB•A)	48 / 46 / 43	48 / 46 / 43	
<b>Outdoor unit</b>					
Outer dimension	Max. total length (m)		70	70	
	Min. length (m)		7.5	7.5	
	Height difference	Outdoor lower (m)	30	30	
		Outdoor high (m)	30	30	
Fan unit	Fan		Propeller fan	Propeller fan	
	Standard air flow high (m <sup>3</sup> /min.)		133	133	
	Motor (W)		100 + 100	100 + 100	
Connecting pipe	Outdoor unit – First pipe branch	Gas side (mm)	28.6	28.6	
		Liquid side (mm)	12.7	12.7	
	First pipe branch – Second pipe branch	Gas side (mm)	15.9	15.9	
		Liquid side (mm)	9.5	9.5	
	Second pipe branch – Indoor unit	Gas side (mm)	12.7	12.7	
		Liquid side (mm)	6.4	6.4	
Sound pressure level		Cooling / Heating (dB•A)	56 / 57	56 / 57	
Sound power level		Cooling / Heating (dB•A)	72 / 74	72 / 74	

\* : IEC standard

## 1-1-11. Duct Type

### <Double twin type>

Model	Indoor unit 1		RAV-SM	562BT-E	802BT-E	562BT-E	802BT-E	
	Indoor unit 2		RAV-SM	562BT-E	802BT-E	562BT-E	802BT-E	
	Indoor unit 3		RAV-SM	562BT-E	802BT-E	562BT-E	802BT-E	
	Indoor unit 4		RAV-SM	562BT-E	802BT-E	562BT-E	802BT-E	
	Outdoor unit		RAV-SM	2244AT8-E	2804AT8-E	2244AT7	2804AT7	
Cooling capacity			(kW)	20.0	23.0	20.0	23.0	
Heating capacity			(kW)	22.4	27.0	22.4	27.0	
Power supply				3 phase 380 – 415V 50Hz		3 phase 380V 60Hz		
<b>Indoor unit</b>								
Electrical characteristics	Cooling	Running current		(A)	11.51 – 10.54	15.44 – 14.13	11.51	15.44
		Power consumption		(kW)	7.12	9.55	7.12	9.55
		Power factor		(%)	94	94	94	94
		EER			2.81	2.41	2.81	2.41
		Energy efficiency class *			C	E	—	—
	Heating	Running current		(A)	10.34 – 9.47	12.80 – 11.72	10.34	12.80
		Power consumption		(kW)	6.40	7.92	6.40	7.92
		Power factor		(%)	94	94	94	94
		COP			3.50	3.41	3.50	3.41
		Energy efficiency class *			B	B	—	—
Maximum current				(A)	18	22	18	22
Fan unit	Fan			Centrifugal	Centrifugal	Centrifugal	Centrifugal	
	Standard air flow	H/M/L	(m <sup>3</sup> /min.)	13.0/11.9/9.8	19.0/16.2/13.3	13.0/11.9/9.8	19.0/16.2/13.3	
	Motor			(W)	120	120	120	120
Sound pressure level		H/M/L		(dB•A)	40 / 37 / 33	40 / 37 / 34	40 / 37 / 33	40 / 37 / 34
Sound power level		H/M/L		(dB•A)	55 / 52 / 48	55 / 52 / 49	55 / 52 / 48	55 / 52 / 49
<b>Outdoor unit</b>								
Outer dimension	Max. total length			(m)	70	70	70	70
	Min. length			(m)	7.5	7.5	7.5	7.5
	Height difference	Outdoor lower		(m)	30	30	30	30
		Outdoor high		(m)	30	30	30	30
Fan unit	Fan			Propeller fan	Propeller fan	Propeller fan	Propeller fan	
	Standard air flow high			(m <sup>3</sup> /min.)	133	133	133	133
	Motor			(W)	100 + 100	100 + 100	100 + 100	100 + 100
Connecting pipe	Outdoor unit – First pipe branch		Gas side	(mm)	28.6	28.6	28.6	28.6
			Liquid side	(mm)	12.7	12.7	12.7	12.7
	First pipe branch – Second pipe branch		Gas side	(mm)	15.9	15.9	15.9	15.9
			Liquid side	(mm)	9.5	9.5	9.5	9.5
	Second pipe branch – Indoor unit		Gas side	(mm)	12.7	15.9	12.7	15.9
			Liquid side	(mm)	6.4	9.5	6.4	9.5
Sound pressure level		Cooling / Heating		(dB•A)	56 / 57	57 / 58	56 / 57	57 / 58
Sound power level		Cooling / Heating		(dB•A)	72 / 74	74 / 75	72 / 74	74 / 75

\* : IEC standard

## 1-1-12. Ceiling Type

### <Double twin type>

Model	Indoor unit 1		RAV-SM	562CT-E	802CT-E	562CT-E	802CT-E	
	Indoor unit 2		RAV-SM	562CT-E	802CT-E	562CT-E	802CT-E	
	Indoor unit 3		RAV-SM	562CT-E	802CT-E	562CT-E	802CT-E	
	Indoor unit 4		RAV-SM	562CT-E	802CT-E	562CT-E	802CT-E	
	Outdoor unit		RAV-SM	2244AT8-E	2804AT8-E	2244AT7	2804AT7	
Cooling capacity			(kW)	20.0	23.0	20.0	23.0	
Heating capacity			(kW)	22.4	27.0	22.4	27.0	
Power supply				3 phase 380 – 415V 50Hz		3 phase 380V 60Hz		
<b>Indoor unit</b>								
Electrical characteristics	Cooling	Running current		(A)	11.51 – 10.54	15.44 – 14.13	11.51	15.44
		Power consumption		(kW)	7.12	9.55	7.12	9.55
		Power factor		(%)	94	94	94	94
		EER			2.81	2.41	2.81	2.41
		Energy efficiency class *			C	E	—	—
	Heating	Running current		(A)	10.34 – 9.47	12.80 – 11.72	10.34	12.80
		Power consumption		(kW)	6.40	7.92	6.40	7.92
		Power factor		(%)	94	94	94	94
		COP			3.50	3.41	3.50	3.41
		Energy efficiency class *			B	B	—	—
Maximum current				(A)	18	22	18	22
Fan unit	Fan			Centrifugal	Centrifugal	Centrifugal	Centrifugal	
	Standard air flow	H/M/L	(m <sup>3</sup> /min.)	13.0/11.2/10.0	18.5/16.7/14.6	13.0/11.2/10.0	18.5/16.7/14.6	
	Motor			(W)	60	60	60	60
Sound pressure level		H/M/L		(dB•A)	36 / 33 / 30	38 / 36 / 33	36 / 33 / 30	38 / 36 / 33
Sound power level		H/M/L		(dB•A)	51 / 48 / 45	53 / 51 / 48	51 / 48 / 45	53 / 51 / 48
<b>Outdoor unit</b>								
Outer dimension	Max. total length			(m)	70	70	70	70
	Min. length			(m)	7.5	7.5	7.5	7.5
	Height difference	Outdoor lower		(m)	30	30	30	30
		Outdoor high		(m)	30	30	30	30
Fan unit	Fan			Propeller fan	Propeller fan	Propeller fan	Propeller fan	
	Standard air flow high			(m <sup>3</sup> /min.)	133	133	133	133
	Motor			(W)	100 + 100	100 + 100	100 + 100	100 + 100
Connecting pipe	Outdoor unit – First pipe branch		Gas side	(mm)	28.6	28.6	28.6	28.6
			Liquid side	(mm)	12.7	12.7	12.7	12.7
	First pipe branch – Second pipe branch		Gas side	(mm)	15.9	15.9	15.9	15.9
			Liquid side	(mm)	9.5	9.5	9.5	9.5
	Second pipe branch – Indoor unit		Gas side	(mm)	12.7	15.9	12.7	15.9
			Liquid side	(mm)	6.4	9.5	6.4	9.5
Sound pressure level		Cooling / Heating		(dB•A)	56 / 57	57 / 58	56 / 57	57 / 58
Sound power level		Cooling / Heating		(dB•A)	72 / 74	74 / 75	72 / 74	74 / 75

\* : IEC standard

## 1-1-12. High Wall Type

### <Double twin type>

Model	Indoor unit 1		RAV-SM	562KRT-E	802KRT-E	562KRT-E	802KRT-E	
	Indoor unit 2		RAV-SM	562KRT-E	802KRT-E	562KRT-E	802KRT-E	
	Indoor unit 3		RAV-SM	562KRT-E	802KRT-E	562KRT-E	802KRT-E	
	Indoor unit 4		RAV-SM	562KRT-E	802KRT-E	562KRT-E	802KRT-E	
	Outdoor unit		RAV-SM	2244AT8-E	2804AT8-E	2244AT7	2804AT7	
Cooling capacity			(kW)	20.0	23.0	20.0	23.0	
Heating capacity			(kW)	22.4	27.0	22.4	27.0	
Power supply				3 phase 380 – 415V 50Hz		3 phase 380V 60Hz		
<b>Indoor unit</b>								
Electrical characteristics	Cooling	Running current		(A)	11.51 – 10.54	15.44 – 14.13	11.51	15.44
		Power consumption		(kW)	7.12	9.55	7.12	9.55
		Power factor		(%)	94	94	94	94
		EER			2.81	2.41	2.81	2.41
		Energy efficiency class *			C	E	—	—
	Heating	Running current		(A)	10.34 – 9.47	12.80 – 11.72	10.34	12.80
		Power consumption		(kW)	6.40	7.92	6.40	7.92
		Power factor		(%)	94	94	94	94
		COP			3.50	3.41	3.50	3.41
		Energy efficiency class *			B	B	—	—
Maximum current				(A)	18	22	18	22
Fan unit	Fan			Cross flow fan	Cross flow fan	Cross flow fan	Cross flow fan	
	Standard air flow	H/M/L	(m <sup>3</sup> /min.)	14.0/12.5/10.7	18.5/14.6/12.2	14.0/12.5/10.7	18.5/14.6/12.2	
	Motor			(W)	30	30	30	30
Sound pressure level		H/M/L		(dB•A)	39 / 36 / 33	45 / 41 / 36	39 / 36 / 33	45 / 41 / 36
Sound power level		H/M/L		(dB•A)	54 / 51 / 48	60 / 56 / 51	54 / 51 / 48	60 / 56 / 51
<b>Outdoor unit</b>								
Outer dimension	Max. total length			(m)	70	70	70	70
	Min. length			(m)	7.5	7.5	7.5	7.5
	Height difference	Outdoor lower		(m)	30	30	30	30
		Outdoor high		(m)	30	30	30	30
Fan unit	Fan			Propeller fan	Propeller fan	Propeller fan	Propeller fan	
	Standard air flow high			(m <sup>3</sup> /min.)	133	133	133	133
	Motor			(W)	100 + 100	100 + 100	100 + 100	100 + 100
Connecting pipe	Outdoor unit – First pipe branch		Gas side	(mm)	28.6	28.6	28.6	28.6
			Liquid side	(mm)	12.7	12.7	12.7	12.7
	First pipe branch – Second pipe branch		Gas side	(mm)	15.9	15.9	15.9	15.9
			Liquid side	(mm)	9.5	9.5	9.5	9.5
	Second pipe branch – Indoor unit		Gas side	(mm)	12.7	12.7	12.7	12.7
			Liquid side	(mm)	6.4	9.5	6.4	9.5
Sound pressure level		Cooling / Heating		(dB•A)	56 / 57	57 / 58	56 / 57	57 / 58
Sound power level		Cooling / Heating		(dB•A)	72 / 74	74 / 75	72 / 74	74 / 75

\* : IEC standard

## 1-2. Outdoor Unit

Model	Outdoor unit		RAV-SM	2244AT8-E	2804AT8-E	2244AT7	2804AT7
Power supply			3 phase 380–415V 50Hz		3 phase 380V 60Hz (Power exclusive to outdoor is required.)		
Compressor	Type		Hermetic compressor		Hermetic compressor		
	Motor	(kW)	3.75	3.75	3.75	3.75	
	Pole		4	4	4	4	
Refrigerant charged			(kg)	5.9	5.9	5.9	5.9
Refrigerant control			Pulse motor valve		Pulse motor valve		
Pipe	Max. total length		(m)	70	70	70	70
	Min. length		(m)	7.5	7.5	7.5	7.5
	Height difference	Outdoor lower	(m)	30	30	30	30
		Outdoor higher	(m)	30	30	30	30
Outer dimension	Height		(mm)	1540	1540	1540	1540
	Width		(mm)	900	900	900	900
	Depth		(mm)	320	320	320	320
Appearance			Silky shade (Muncel 1Y8.5/0.5)		Silky shade (Muncel 1Y8.5/0.5)		
Total weight			(kg)	134	134	134	134
Heat exchanger			Finned tube		Finned tube		
Fan unit	Fan		Propeller fan		Propeller fan		
	Standard air flow		(m <sup>3</sup> /min.)	133	133	133	133
	Motor		(W)	100 + 100	100 + 100	100 + 100	100 + 100
Connecting pipe (Outdoor unit side)		Gas side	(mm)	19.1	19.1	19.1	19.1
		Liquid side	(mm)	12.7	12.7	12.7	12.7
Sound pressure level		Cooling/Heating	(dB•A)	56 / 57	57 / 58	56 / 57	57 / 58
Sound power level		Cooling/Heating	(dB•A)	72 / 74	74 / 75	72 / 74	74 / 75
Outside air temperature, Cooling			(°C)	46 to –15°C		46 to –15°C	
Outside air temperature, Heating			(°C)	15 to –20°C		15 to –20°C	



### 1-3. Operation Characteristic Curve

• Operation characteristic curve <Digital Inverter>

RAV-SM2244AT8 (Z) (ZG) -E, RAV-SM2804AT8 (Z) (ZG) -E

<Cooling>

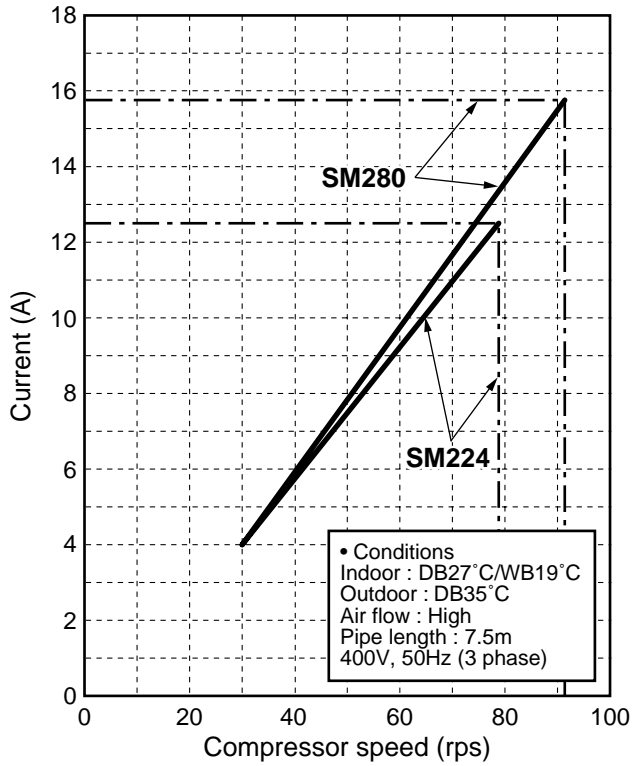

<Heating>

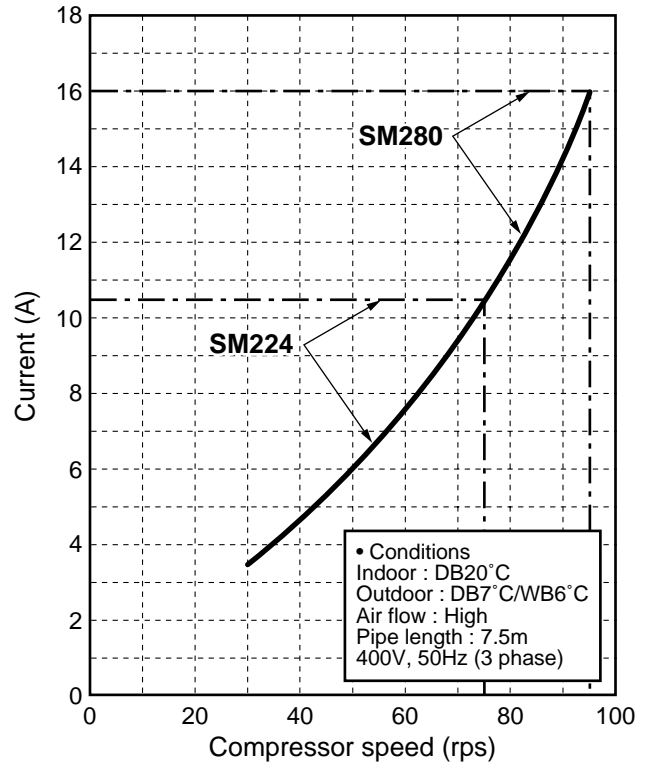

RAV-SM2244AT7 (Z) (ZG), RAV-SM2804AT7 (Z) (ZG)

<Cooling>

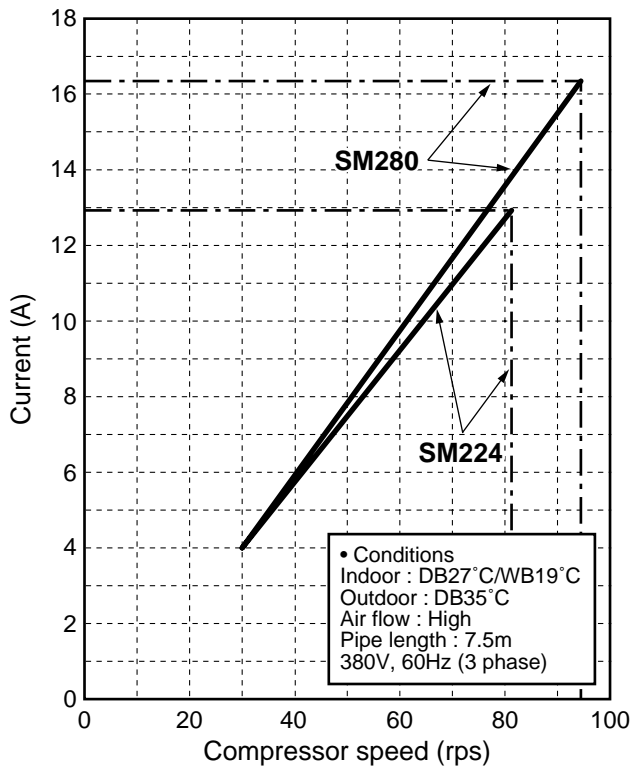

<Heating>

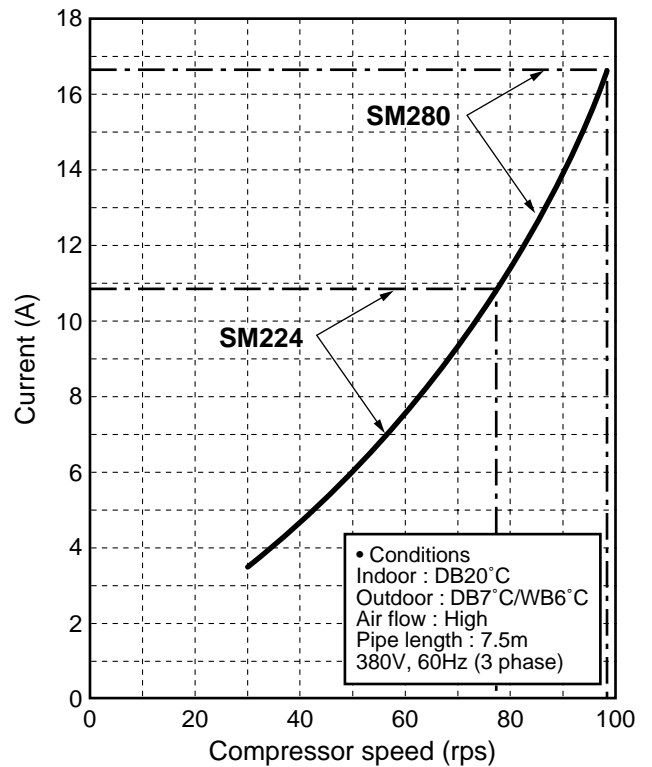

• Capacity variation ratio according to temperature

RAV-SM2244AT8 (Z) (ZG) -E, RAV-SM2804AT8 (Z) (ZG) -E

RAV-SM2244AT7 (Z) (ZG), RAV-SM2804AT7 (Z) (ZG)

<Cooling>

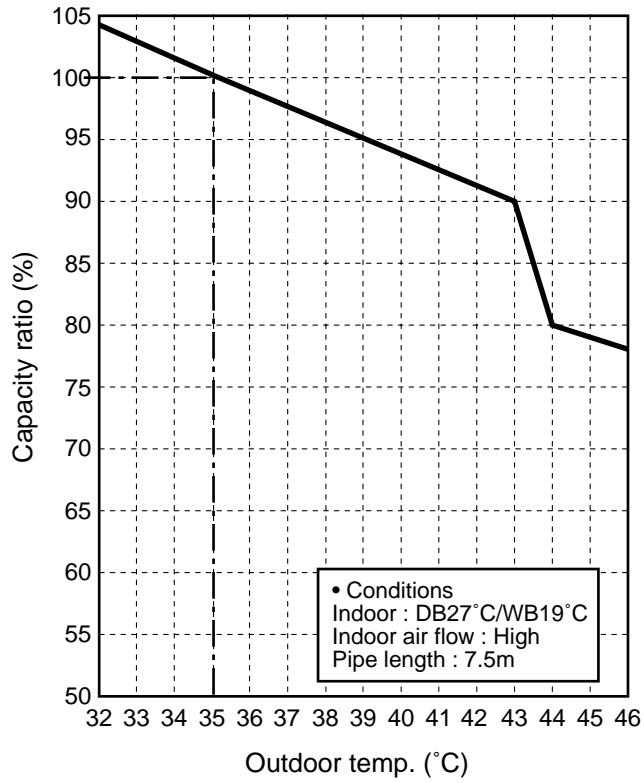

<Heating>

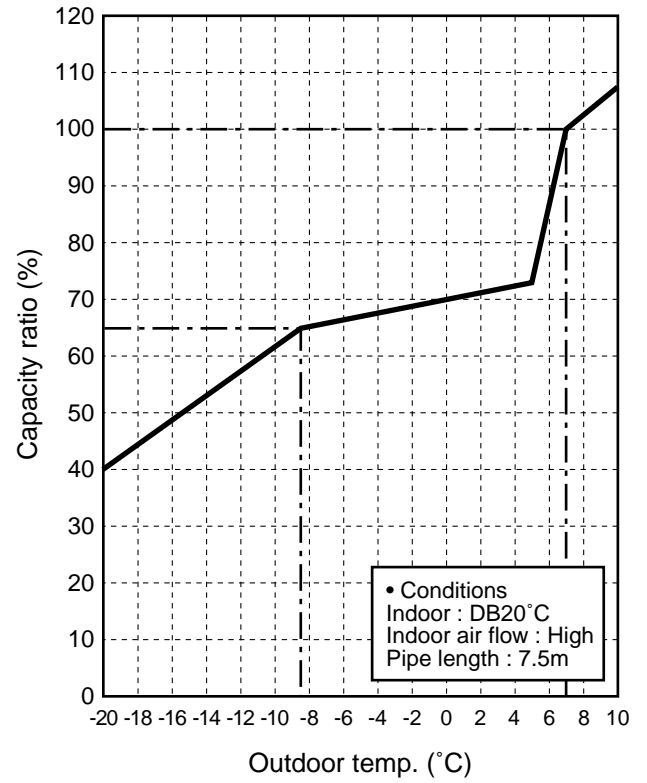

## 2. CONSTRUCTION VIEWS (EXTERNAL VIEWS)

### 2-1. Outdoor Unit

	Name	Note
①	Refrigerant piping hole Indoor/Outdoor Unit connecting wire inlet hole	—
②	Power supply inlet hole	φ38 Knockout hole

Diameter of pipe connecting port		Diameter of connecting pipe	
Liquid side	φ12.7	Liquid side	φ12.7
Gas side	φ19.1	Gas side	φ28.6

\* The diameter of ball valve connecting port on the outdoor unit is 19.1, and therefore please use the accessory joint for installation.

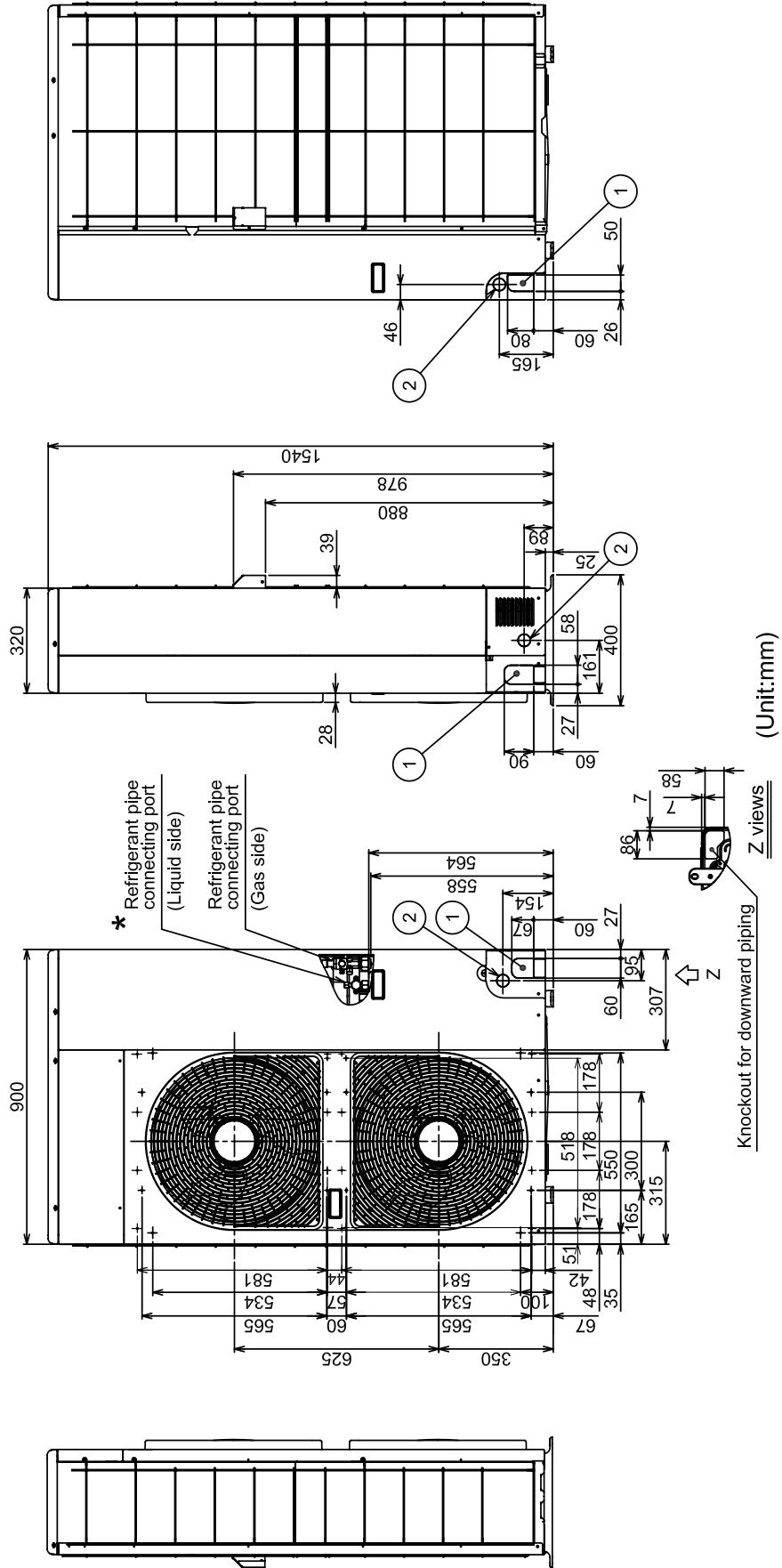
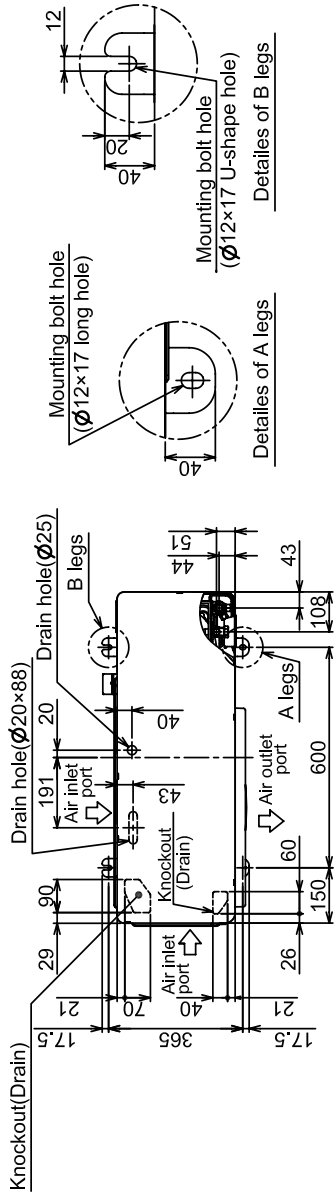

**RBC-DTWP101E (Simultaneous Double Twin)**

<Branch pipe>

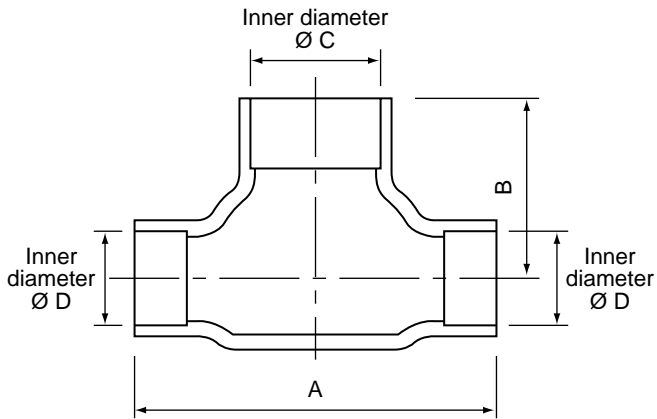

<Joint pipe>

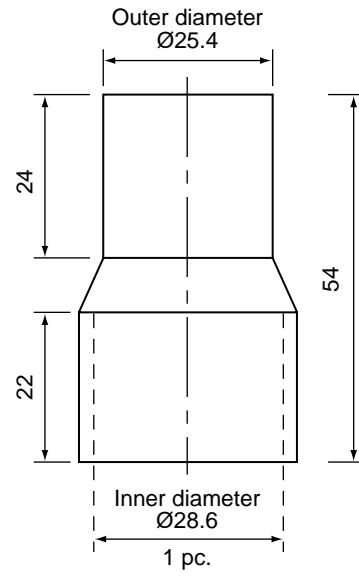

Model		A	B	C	D	Q'ty
RBC-DTWP101E	Gas side	74	37	25.4	15.9	1
		42	23	15.9	15.9	2
		43	23	15.9	12.7	2
	Liquid side	35	18	12.7	9.5	1
		34	14	9.5	9.5	2
		36	14	9.5	6.4	2

**RBC-TRP100E (Simultaneous Triple)**

**<Gas side>**

Header assembly

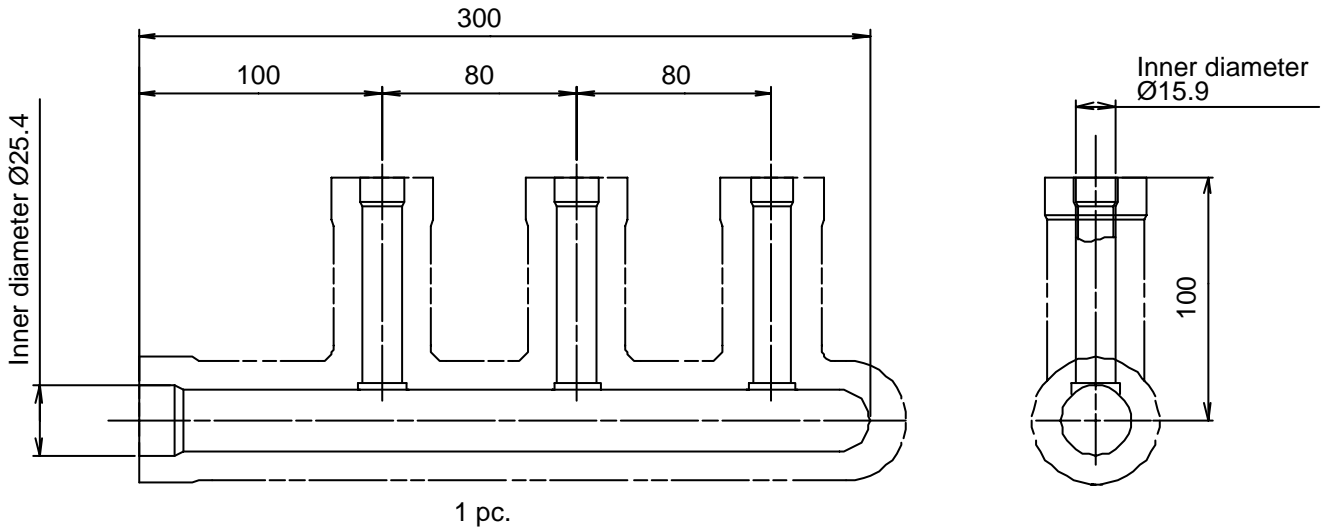

**<Liquid side>**

Branch pipe assembly

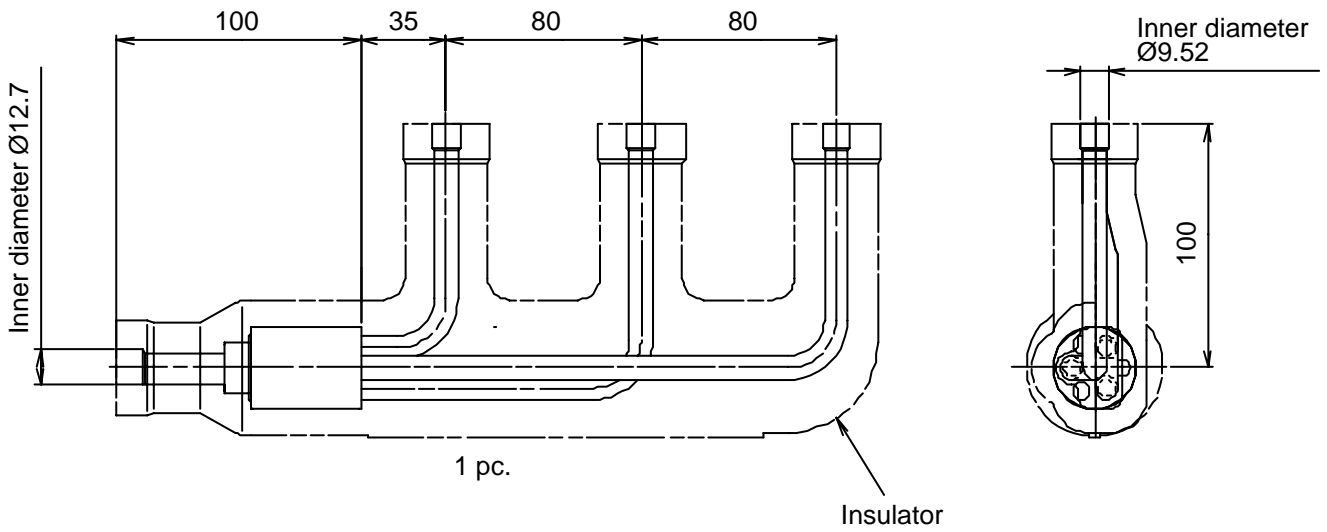

**Gas side socket**

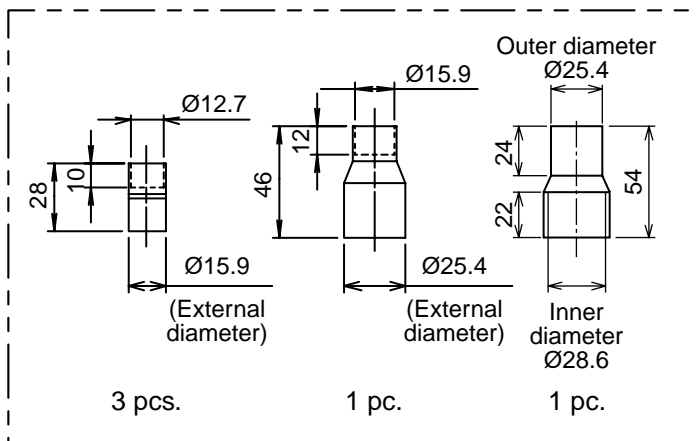

**Liquid side socket**

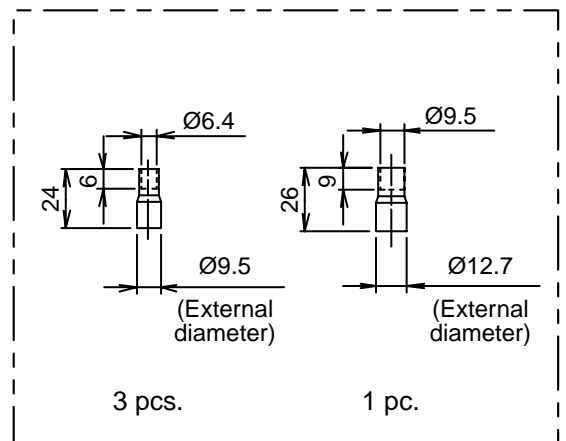

**RBC-TWP101E (Simultaneous Twin)**

<Branch pipe>

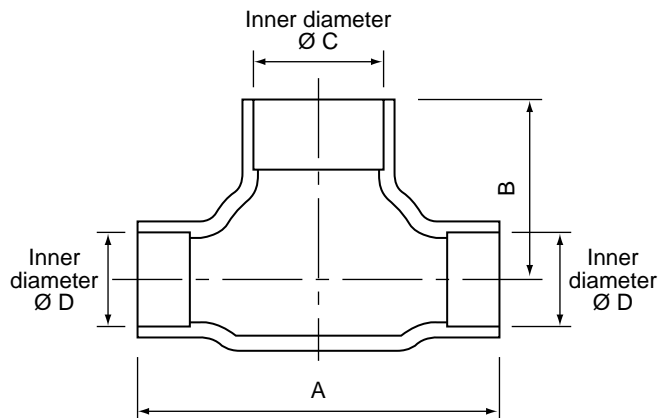

<Joint pipe>

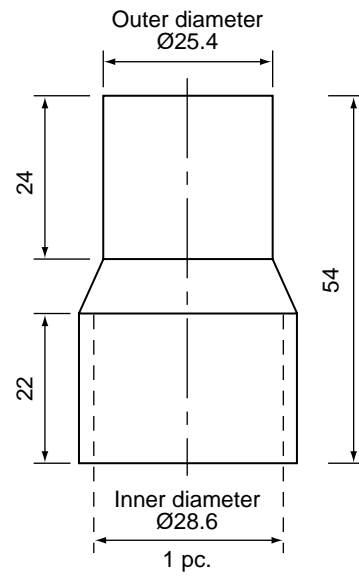

Model		A	B	C	D	Q'ty
RBC-TWP101E	Gas side	74	37	25.4	15.9	1
	Liquid side	35	18	12.7	9.5	1

### 3. OUTDOOR UNIT REFRIGERANTING CYCLE DIAGRAM

RAV-SM2244AT8 (Z) (ZG) -E, RAV-SM2804AT8 (Z) (ZG) -E  
 RAV-SM2244AT7 (Z) (ZG), RAV-SM2804AT7 (Z) (ZG)

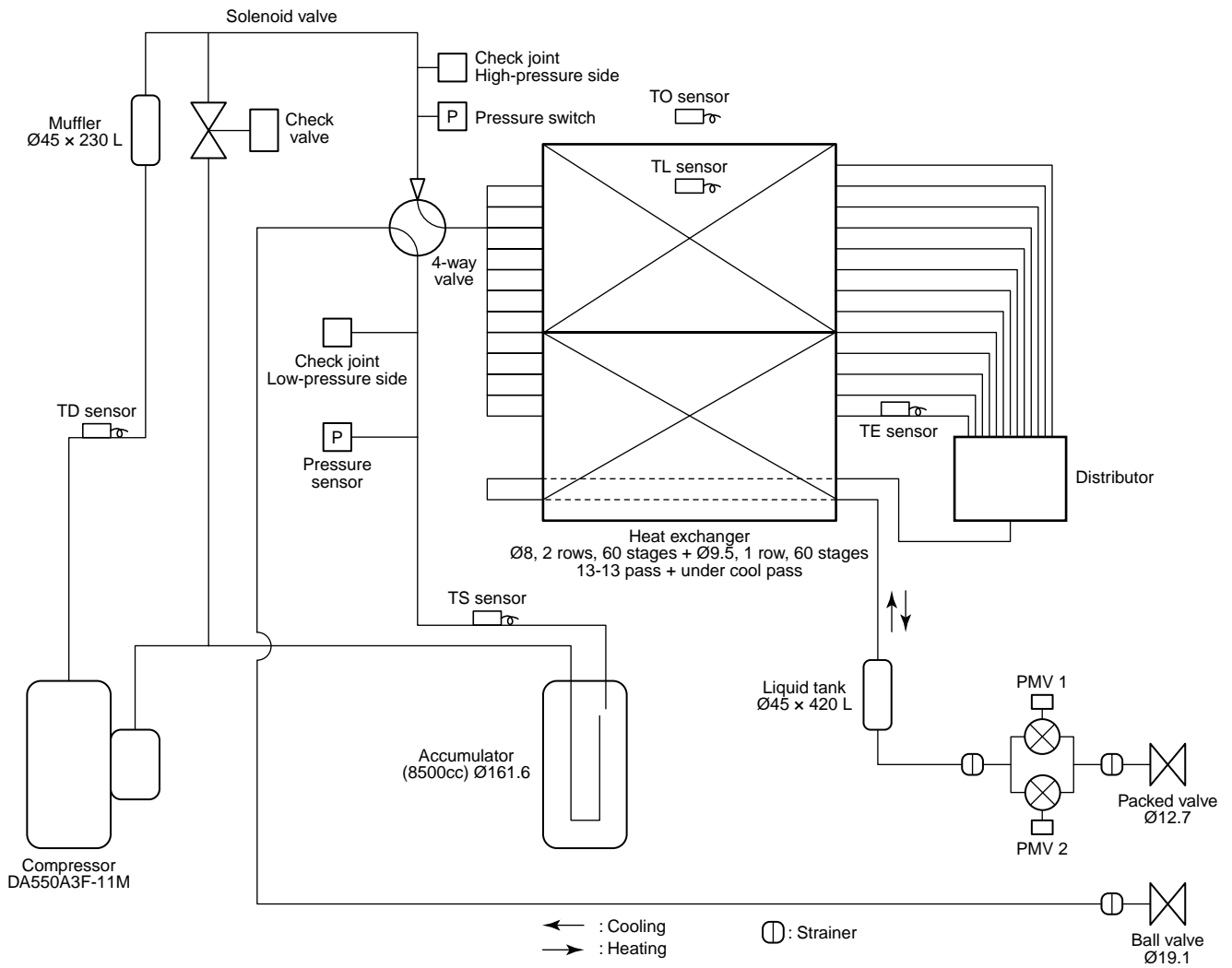

## Systematic diagram of refrigerating cycle

### RAV-SM2244 series

		Pressure				Pipe surface temperature (°C)				Compressor drive revolution frequency (rps) *	Indoor fan	Indoor/Outdoor temp. conditions (DB/WB) (°C)	
		(MPa)		(kg/cm <sup>2</sup> g)		Discharge	Suction	Indoor heat exchanger	Outdoor heat exchanger			Indoor	Outdoor
		Pd	Ps	Pd	Ps	(TD)	(TS)	(TC)	(TE)				
Cooling	Standard	3.14	0.88	32.0	9.0	84	14	10	37	64	HIGH	27/19	35/-
	Overload	3.54	1.14	36.1	11.6	88	17	16	46	62	HIGH	32/24	43/-
	Low load	1.65	0.65	16.8	6.6	41	7	5	0	36	LOW	18/15.5	-15/-
Heating	Standard	2.60	0.67	26.5	6.8	73	2	42	2	66	HIGH	20/-	7/6
	Overload	3.24	1.08	33.1	11.0	77	14	52	13	36	LOW	30/-	24/18
	Low load	2.05	0.31	20.9	3.2	76	-12	34	-11	75	HIGH	15/-	-10/(70%)

\* This compressor has a 4-pole motor.

The value when compressor frequency (Hz) is measured by a clamp meter is twice the compressor revolution number (rps).

\* This data is cycle data obtained by combining a four-way ceiling cassette simultaneous twin at a target pipe length. Data will change depending on the mounted pipe length or combination with the indoor unit.

### RAV-SM2804 series

		Pressure				Pipe surface temperature (°C)				Compressor drive revolution frequency (rps) *	Indoor fan	Indoor/Outdoor temp. conditions (DB/WB) (°C)	
		(MPa)		(kg/cm <sup>2</sup> g)		Discharge	Suction	Indoor heat exchanger	Outdoor heat exchanger			Indoor	Outdoor
		Pd	Ps	Pd	Ps	(TD)	(TS)	(TC)	(TE)				
Cooling	Standard	3.15	0.79	32.1	8.1	87	11	9	41	80	HIGH	27/19	35/-
	Overload	3.62	1.12	36.9	11.4	89	18	16	48	64	HIGH	32/24	43/-
	Low load	1.66	0.64	16.9	6.5	42	6	5	0	36	LOW	18/15.5	-15/-
Heating	Standard	2.85	0.63	29.1	6.4	80	1	47	2	80	HIGH	20/-	7/6
	Overload	3.26	1.06	33.3	10.8	78	14	53	12	36	LOW	30/-	24/18
	Low load	2.05	0.29	20.9	3.0	81	-13	33	-12	96	HIGH	15/-	-10/(70%)

\* This compressor has a 4-pole motor.

The value when compressor frequency (Hz) is measured by a clamp meter is twice the compressor revolution number (rps).

\* This data is cycle data obtained by combining a four-way ceiling cassette simultaneous twin at a target pipe length. Data will change depending on the mounted pipe length or combination with the indoor unit.



## 4. WIRING DIAGRAM

### 4-1. Outdoor Unit

RAV-SM2244AT8 (Z) (ZG) -E, RAV-SM2804AT8 (Z) (ZG) -E  
RAV-SM2244AT7 (Z) (ZG), RAV-SM2804AT7 (Z) (ZG)

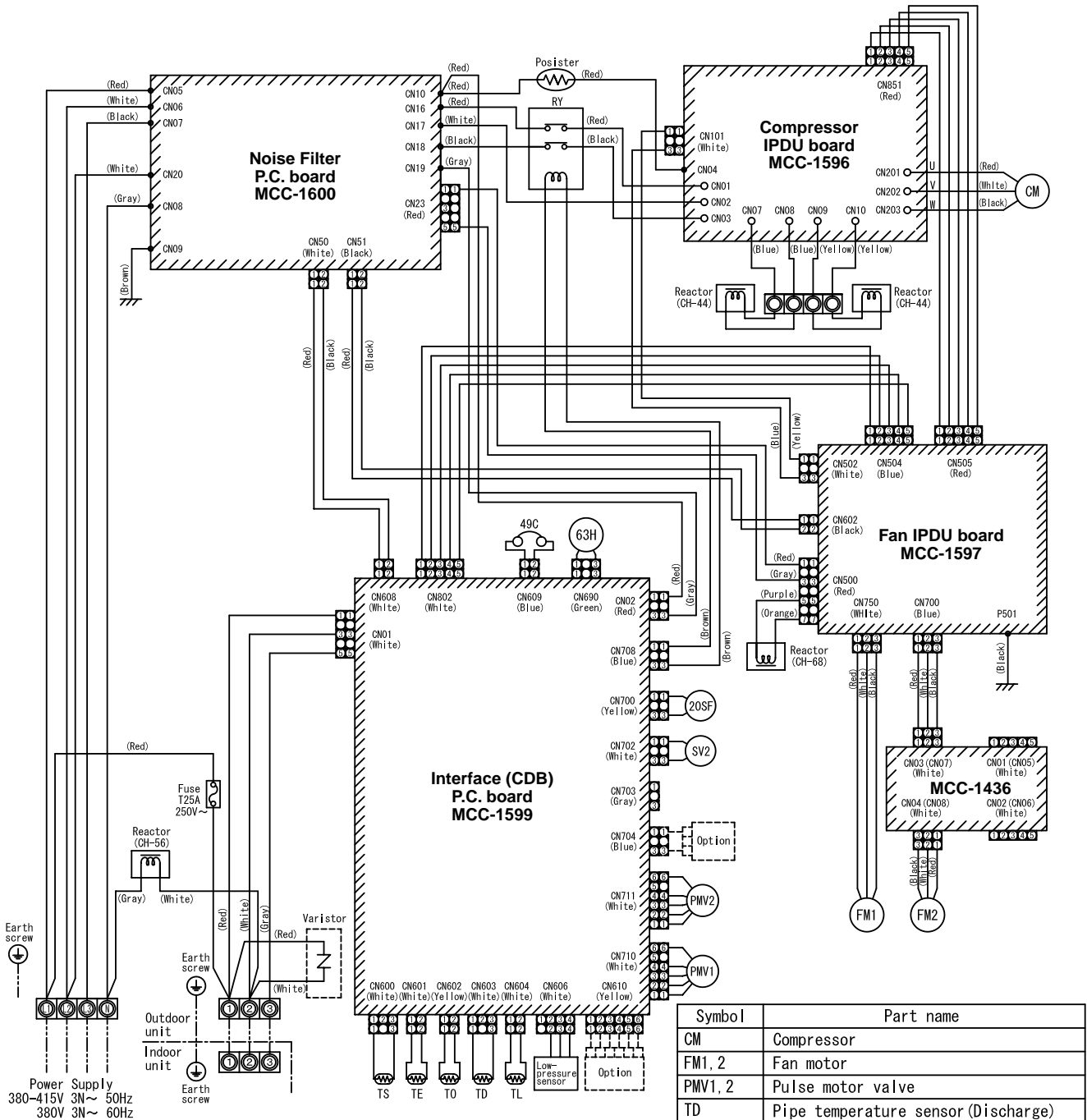

- ① indicates the terminal block. Alphanumeric characters in the cycle indicate the terminal No.
- The two-dot chain line indicates the wiring procured locally.
- ▨ indicates the P.C. board.
- For the indoor unit circuit, refer to the wiring diagram of the indoor unit.

Symbol	Part name
CM	Compressor
FM1, 2	Fan motor
PMV1, 2	Pulse motor valve
TD	Pipe temperature sensor (Discharge)
TS	Pipe temperature sensor (Suction)
TE	Heat exchanger sensor 1
TL	Heat exchanger sensor 2
TO	Outside temperature sensor
SV2	2-way valve coil
20SF	4-way valve coil
49C	Compressor case thermostat
63H	High-pressure switch
RY	Relay

## 5. SPECIFICATIONS OF ELECTRICAL PARTS

### 5-1. Outdoor Unit

RAV-SM2244AT8 (Z) (ZG) -E, RAV-SM2804AT8 (Z) (ZG) -E  
RAV-SM2244AT7 (Z) (ZG), RAV-SM2804AT7 (Z) (ZG)

No.	Parts name	Type	Specifications
1	Compressor	DA550A3F-11M	—
2	Outdoor fan motor	ICF-280-A100-1	DC 280 V, 100 W
3	4-way valve coil	STF-01AJ502E1	AC 220 – 240 V, 50 Hz
4	4-way valve coil (for AT7)	VHV-01AH553A1	AC 220 V, 60 Hz
5	2-way valve coil	VPV-MOAJ524C0	AC 220 – 240 V, 50 Hz
6	2-way valve coil (for AT7)	VPV-MOAH551B1	AC 220 V, 60 Hz
7	PMV coil	UKV-25D22	DC 12 V
8	High pressure switch	ACB-4UB83W	OFF : 4.15 MPa
9	Reactor	CH-44	1.4 mH, 25 A
10	Reactor	CH-68	18 mH, 5 A
11	Reactor	CH-56	5.8 mH, 18.5 A
12	P.C. board (Compressor drive)	MCC-1596	—
13	P.C. board (Fan motor drive)	MCC-1597	—
14	P.C. board (Control)	MCC-1599	—
15	P.C. board (Noise filter)	MCC-1600	—
16	P.C. board (Fan extention)	MCC-1436	—
17	Outdoor temp. sensor (TO sensor)	—	10 kΩ at 25°C
18	Discharge temp. sensor (TD sensor)	—	50 kΩ at 25°C
19	Suction temp. sensor (TS sensor)	—	10 kΩ at 25°C
20	Heat exchanger sensor (TE sensor)	—	10 kΩ at 25°C
21	Heat exchanger mid. temp. sensor (TL sensor)	—	10 kΩ at 25°C
22	Fuse	TLC 25A	25 A, 250 V
23	Fuse (Mounted on P.C. board, MCC-1596)	GAC1 31.5A	31.5 A, 500 V
24	Fuse (Mounted on P.C. board, MCC-1596)	SCT 31.5A	T3.15 A, AC 250 V
25	Fuse (Mounted on P.C. board, MCC-1597)	GDM 250V 15A	15 A, 250 V
26	Fuse (Mounted on P.C. board, MCC-1597)	SCT 31.5A	T3.15 A, AC 250 V
27	Fuse (Mounted on P.C. board, MCC-1599)	FJL 250V 31.5A	T3.15 A, AC 250 V
28	Fuse (Mounted on P.C. board, MCC-1600)	ET 6.3A	T6.3 A, AC 250 V
29	Relay	EL200/240A2-F(M)	Contact : AC 480 V, 20A
30	Posistor	ZPR0YCE 101A 500	100 Ω, 500 V
31	Compressor thermo.	US-622	OFF : 125 ± 4 °C, ON : 60 ± 5 °C

## 6. REFRIGERANT R410A

This air conditioner adopts the new refrigerant HFC (R410A) which does not damage the ozone layer.

The working pressure of the new refrigerant R410A is 1.6 times higher than conventional refrigerant (R22). The refrigerating oil is also changed in accordance with change of refrigerant, so be careful that water, dust, and existing refrigerant or refrigerating oil are not entered in the refrigerant cycle of the air conditioner using the new refrigerant during installation work or servicing time.

The next section describes the precautions for air conditioner using the new refrigerant.

Conforming to contents of the next section together with the general cautions included in this manual, perform the correct and safe work.

### 6-1. Safety During Installation/Serviceing

As R410A's pressure is about 1.6 times higher than that of R22, improper installation/servicing may cause a serious trouble. By using tools and materials exclusive for R410A, it is necessary to carry out installation/servicing safely while taking the following precautions into consideration.

1. Never use refrigerant other than R410A in an air conditioner which is designed to operate with R410A.

If other refrigerant than R410A is mixed, pressure in the refrigeration cycle becomes abnormally high, and it may cause personal injury, etc. by a rupture.

2. Confirm the used refrigerant name, and use tools and materials exclusive for the refrigerant R410A.

The refrigerant name R410A is indicated on the visible place of the outdoor unit of the air conditioner using R410A as refrigerant.

To prevent mischarging, the diameter of the service port differs from that of R22.

3. If a refrigeration gas leakage occurs during installation/servicing, be sure to ventilate fully.  
If the refrigerant gas comes into contact with fire, a poisonous gas may occur.
4. When installing or removing an air conditioner, do not allow air or moisture to remain in the refrigeration cycle.  
Otherwise, pressure in the refrigeration cycle may become abnormally high so that a rupture or personal injury may be caused.
5. After completion of installation work, check to make sure that there is no refrigeration gas leakage.

If the refrigerant gas leaks into the room, coming into contact with fire in the fan-driven heater, space heater, etc., a poisonous gas may occur.

6. When an air conditioning system charged with a large volume of refrigerant is installed in a small room, it is necessary to exercise care so that, even when refrigerant leaks, its concentration does not exceed the marginal level.

If the refrigerant gas leakage occurs and its concentration exceeds the marginal level, an oxygen starvation accident may result.

7. Be sure to carry out installation or removal according to the installation manual.  
Improper installation may cause refrigeration trouble, water leakage, electric shock, fire, etc.
8. Unauthorized modifications to the air conditioner may be dangerous. If a breakdown occurs please call a qualified air conditioner technician or electrician.  
Improper repair may result in water leakage, electric shock and fire, etc.

### 6-2. Refrigerant Piping Installation

#### 6-2-1. Piping Materials and Joints Used

For the refrigerant piping installation, copper pipes and joints are mainly used.

Copper pipes and joints suitable for the refrigerant must be chosen and installed.

Furthermore, it is necessary to use clean copper pipes and joints whose interior surfaces are less affected by contaminants.

#### 1. Copper Pipes

It is necessary to use seamless copper pipes which are made of either copper or copper alloy and it is desirable that the amount of residual oil is less than 40 mg/10 m.

Do not use copper pipes having a collapsed, deformed or discolored portion (especially on the interior surface).

Otherwise, the expansion valve or capillary tube may become blocked with contaminants.

As an air conditioner using R410A incurs pressure higher than when using R22, it is necessary to choose adequate materials.

Thicknesses of copper pipes used with R410A are as shown in Table 6-2-1. Never use copper pipes thinner than 0.8mm even when it is available on the market.

#### NOTE

---

Refer to the "6-6. Instructions for Re-use Piping of R22 or R407C".

---

**Table 6-2-1 Thicknesses of annealed copper pipes**

		Thickness (mm)	
Nominal diameter	Outer diameter (mm)	R410A	R22
1/4	6.4	0.80	0.80
3/8	9.5	0.80	0.80
1/2	12.7	0.80	0.80
5/8	15.9	1.00	1.00

**1. Joints**

For copper pipes, flare joints or socket joints are used. Prior to use, be sure to remove all contaminants.

## a) Flare Joints

Flare joints used to connect the copper pipes cannot be used for pipings whose outer diameter exceeds 20 mm. In such a case, socket joints can be used.

Sizes of flare pipe ends, flare joint ends and flare nuts are as shown in Tables 6-2-3 to 6-2-5 below.

## b) Socket Joints

Socket joints are such that they are brazed for connections, and used mainly for thick pipings whose diameter is larger than 20 mm. Thicknesses of socket joints are as shown in Table 6-2-2.

**Table 6-2-2 Minimum thicknesses of socket joints**

Nominal diameter	Reference outer diameter of copper pipe jointed (mm)	Minimum joint thickness (mm)
1/4	6.4	0.50
3/8	9.5	0.60
1/2	12.7	0.70
5/8	15.9	0.80

**6-2-2. Processing of Piping Materials**

When performing the refrigerant piping installation, care should be taken to ensure that water or dust does not enter the pipe interior, that no other oil other than lubricating oils used in the installed air conditioner is used, and that refrigerant does not leak.

When using lubricating oils in the piping processing, use such lubricating oils whose water content has been removed. When stored, be sure to seal the container with an airtight cap or any other cover.

**1. Flare Processing Procedures and Precautions**

## a) Cutting the Pipe

By means of a pipe cutter, slowly cut the pipe so that it is not deformed.

## b) Removing Burrs and Chips

If the flared section has chips or burrs, refrigerant leakage may occur.

Carefully remove all burrs and clean the cut surface before installation.

c) Insertion of Flare Nut

d) Flare Processing

Make certain that a clamp bar and copper pipe have been cleaned.

By means of the clamp bar, perform the flare processing correctly.

Use either a flare tool for R410A or conventional flare tool.

Flare processing dimensions differ according to the type of flare tool.

When using a conventional flare tool, be sure to secure "dimension A" by using a gauge for size adjustment.

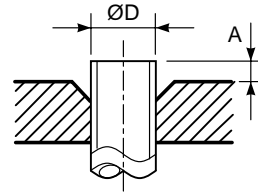

Fig. 6-2-1 Flare processing dimensions

Table 6-2-3 Dimensions related to flare processing for R410A / R22

Nominal diameter	Outer diameter (mm)	Thickness (mm)	A (mm)				
			Flare tool for R410A, R22 clutch type	Conventional flare tool (R410A)		Conventional flare tool (R22)	
				Clutch type	Wing nut type	Clutch type	Wing nut type
1/4	6.4	0.8	0 to 0.5	1.0 to 1.5	1.5 to 2.0	0.5 to 1.0	1.0 to 1.5
3/8	9.5	0.8	0 to 0.5	1.0 to 1.5	1.5 to 2.0	0.5 to 1.0	1.0 to 1.5
1/2	12.7	0.8	0 to 0.5	1.0 to 1.5	2.0 to 2.5	0.5 to 1.0	1.5 to 2.0
5/8	15.9	1.0	0 to 0.5	1.0 to 1.5	2.0 to 2.5	0.5 to 1.0	1.5 to 2.0
3/4	19.1	1.2	0 to 0.5	1.0 to 1.5	2.0 to 2.5	—	—

Table 6-2-4 Flare and flare nut dimensions for R410A

Nominal diameter	Outer diameter (mm)	Thickness (mm)	Dimension (mm)				Flare nut width (mm)
			A	B	C	D	
1/4	6.4	0.8	9.1	9.2	6.5	13	17
3/8	9.5	0.8	13.2	13.5	9.7	20	22
1/2	12.7	0.8	16.6	16.0	12.9	23	26
5/8	15.9	1.0	19.7	19.0	16.0	25	29
3/4	19.1	1.2	24.0	—	19.2	28	36

Table 6-2-5 Flare and flare nut dimensions for R22

Nominal diameter	Outer diameter (mm)	Thickness (mm)	Dimension (mm)				Flare nut width (mm)
			A	B	C	D	
1/4	6.4	0.8	9.1	9.2	6.5	13	17
3/8	9.5	0.8	13.0	13.5	9.7	20	22
1/2	12.7	0.8	16.2	16.0	12.9	20	24
5/8	15.9	1.0	19.4	19.0	16.0	23	27
3/4	19.1	1.0	23.3	24.0	19.2	34	36

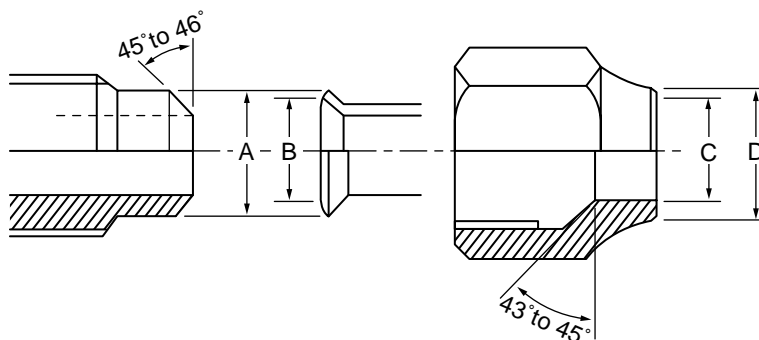

Fig. 6-2-2 Relations between flare nut and flare seal surface

## 2. Flare Connecting Procedures and Precautions

- Make sure that the flare and union portions do not have any scar or dust, etc.
- Correctly align the processed flare surface with the union axis.
- Tighten the flare with designated torque by means of a torque wrench.

The tightening torque for R410A is the same as that for conventional R22.

Incidentally, when the torque is weak, the gas leakage may occur.

When it is strong, the flare nut may crack and may be made non-removable.

When choosing the tightening torque, comply with values designated by manufacturers.

Table 6-2-6 shows reference values.

### NOTE

When applying oil to the flare surface, be sure to use oil designated by the manufacturer.

If any other oil is used, the lubricating oils may deteriorate and cause the compressor to burn out.

Table 6-2-6 Tightening torque of flare for R410A [Reference values]

Nominal diameter	Outer diameter (mm)	Tightening torque N•m (kgf•m)	Tightening torque of torque wrenches available on the market N•m (kgf•m)
1/4	6.4	14 to 18 (1.4 to 1.8)	16 (1.6), 18 (1.8)
3/8	9.5	33 to 42 (3.3 to 4.2)	42 (4.2)
1/2	12.7	50 to 62 (5.0 to 6.2)	55 (5.5)
5/8	15.9	63 to 77 (6.3 to 7.7)	65 (6.5)
3/4	19.1	100 to 120 (10.0 to 12.0)	—

### 6-3. Tools

#### 6-3-1. Required Tools

Refer to the “4. Tools” (Page 8)

### 6-4. Recharging of Refrigerant

When it is necessary to recharge refrigerant, charge the specified amount of new refrigerant according to the following steps.

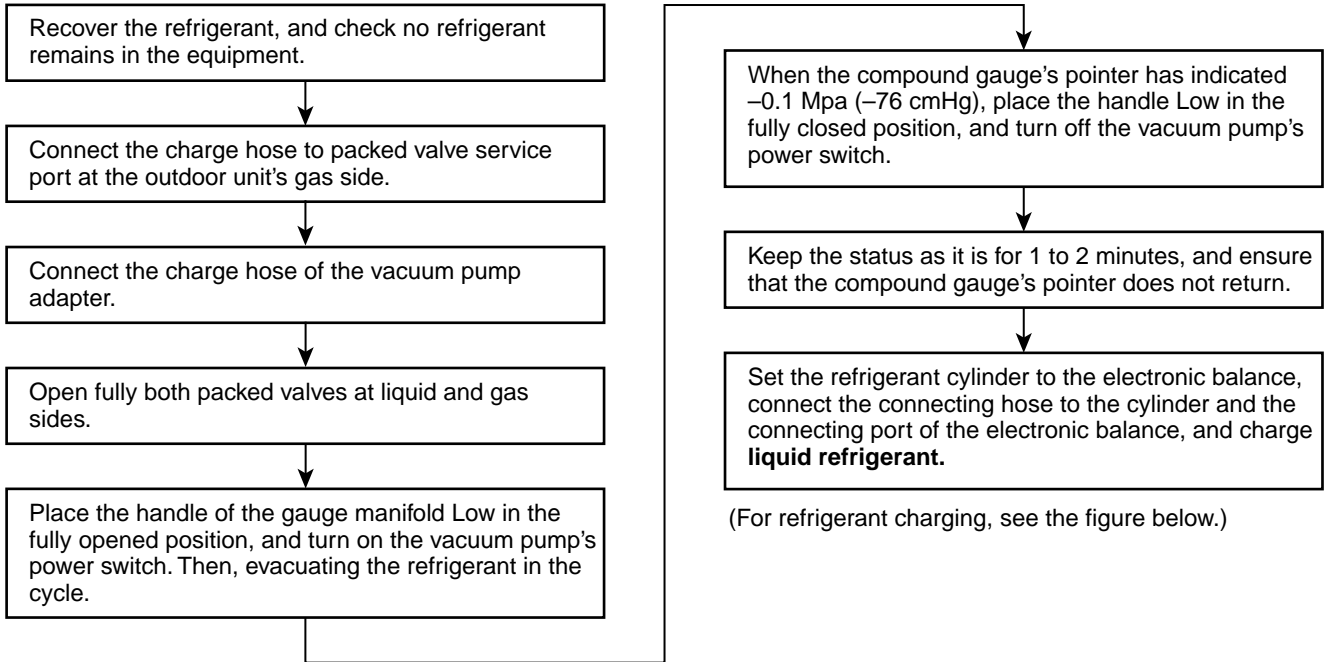

- 1) Never charge refrigerant exceeding the specified amount.
- 2) If the specified amount of refrigerant cannot be charged, charge refrigerant **bit by bit** in COOL mode.
- 3) Do not carry out additional charging.

When additional charging is carried out if refrigerant leaks, the refrigerant composition changes in the refrigeration cycle, that is characteristics of the air conditioner changes, refrigerant exceeding the specified amount is charged, and working pressure in the refrigeration cycle becomes abnormally high pressure, and may cause a rupture or personal injury.

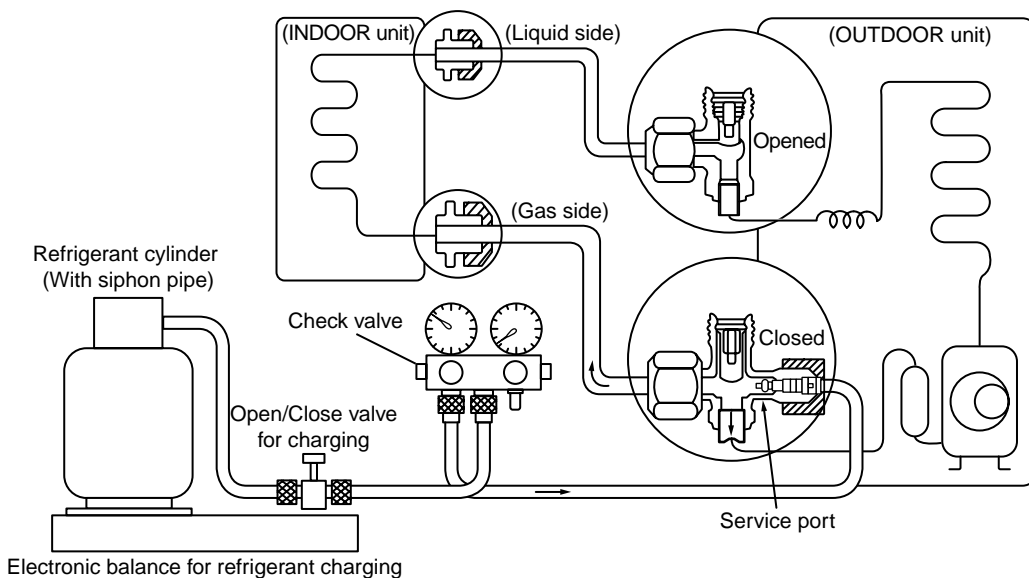

**Fig. 6-4-1 Configuration of refrigerant charging**

- 1) Be sure to make setting so that **liquid** can be charged.
- 2) When using a cylinder equipped with a siphon, liquid can be charged without turning it upside down.

It is necessary for charging refrigerant under condition of liquid because R410A is mixed type of refrigerant. Accordingly, when charging refrigerant from the refrigerant cylinder to the equipment, charge it turning the cylinder upside down if cylinder is not equipped with siphon.

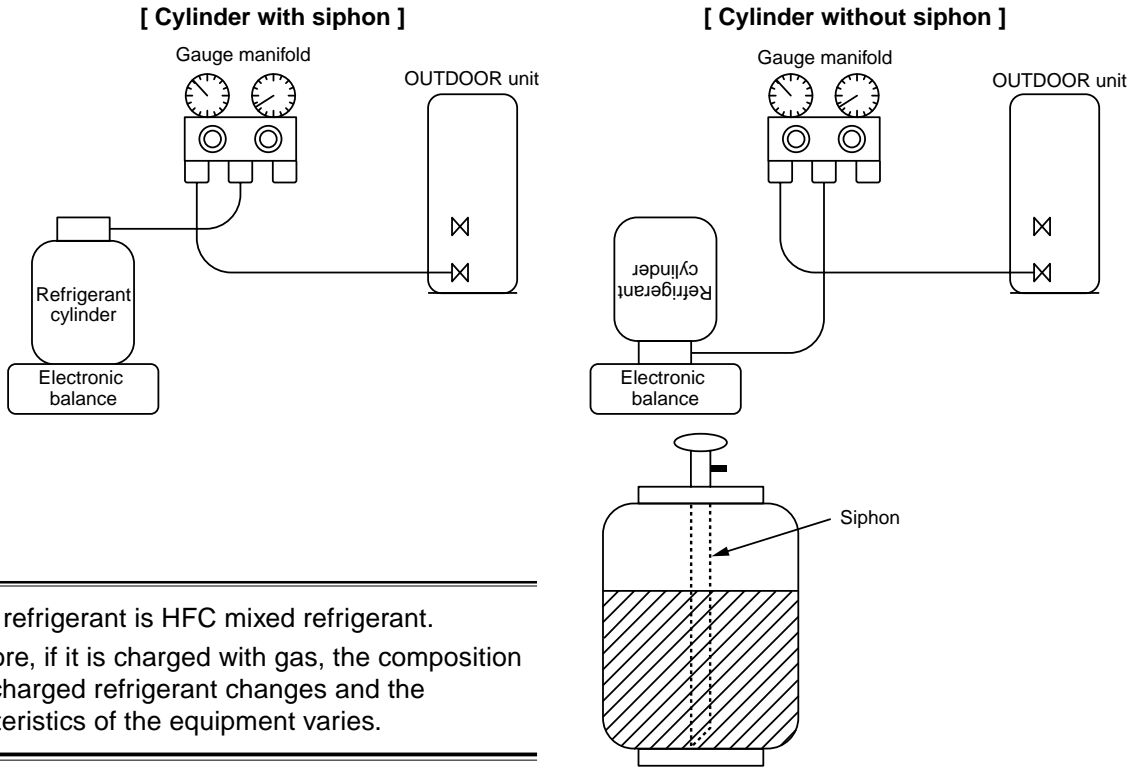

R410A refrigerant is HFC mixed refrigerant. Therefore, if it is charged with gas, the composition of the charged refrigerant changes and the characteristics of the equipment varies.

Fig. 6-4-2

## 6-5. Brazing of Pipes

### 6-5-1. Materials for Brazing

#### 1. Silver brazing filler

Silver brazing filler is an alloy mainly composed of silver and copper.

It is used to join iron, copper or copper alloy, and is relatively expensive though it excels in solderability.

#### 2. Phosphor bronze brazing filler

Phosphor bronze brazing filler is generally used to join copper or copper alloy.

#### 3. Low temperature brazing filler

Low temperature brazing filler is generally called solder, and is an alloy of tin and lead.

Since it is weak in adhesive strength, do not use it for refrigerant pipes.

- 1) Phosphor bronze brazing filler tends to react with sulfur and produce a fragile compound water solution, which may cause a gas leakage. Therefore, use any other type of brazing filler at a hot spring resort, etc., and coat the surface with a paint.
- 2) When performing brazing again at time of servicing, use the same type of brazing filler.

### 6-5-2. Flux

#### 1. Reason why flux is necessary

- By removing the oxide film and any foreign matter on the metal surface, it assists the flow of brazing filler.
- In the brazing process, it prevents the metal surface from being oxidized.
- By reducing the brazing filler's surface tension, the brazing filler adheres better to the treated metal.



## 2. Characteristics required for flux

- Activated temperature of flux coincides with the brazing temperature.
- Due to a wide effective temperature range, flux is hard to carbonize.
- It is easy to remove slag after brazing.
- The corrosive action to the treated metal and brazing filler is minimum.
- It excels in coating performance and is harmless to the human body.

As the flux works in a complicated manner as described above, it is necessary to select an adequate type of flux according to the type and shape of treated metal, type of brazing filler and brazing method, etc.

## 3. Types of flux

### • Noncorrosive flux

Generally, it is a compound of borax and boric acid.

It is effective in case where the brazing temperature is higher than 800°C.

### • Activated flux

Most of fluxes generally used for silver brazing are this type.

It features an increased oxide film removing capability due to the addition of compounds such as potassium fluoride, potassium chloride and sodium fluoride to the borax-boric acid compound.

## 4. Piping materials for brazing and used brazing filler/flux

Piping material	Used brazing filler	Used flux
Copper - Copper	Phosphor copper	Do not use
Copper - Iron	Silver	Paste flux
Iron - Iron	Silver	Vapor flux

- 1) Do not enter flux into the refrigeration cycle.
- 2) When chlorine contained in the flux remains within the pipe, the lubricating oil deteriorates. Therefore, use a flux which does not contain chlorine.
- 3) When adding water to the flux, use water which does not contain chlorine (e.g. distilled water or ion-exchange water).
- 4) Remove the flux after brazing.

## 6-5-3. Brazing

As brazing work requires sophisticated techniques, experiences based upon a theoretical knowledge, it must be performed by a person qualified.

In order to prevent the oxide film from occurring in the pipe interior during brazing, it is effective to proceed with brazing while letting dry Nitrogen gas flow.

**Never use gas other than Nitrogen gas.**

### 1. Brazing method to prevent oxidation

- 1) Attach a reducing valve and a flow-meter to the Nitrogen gas cylinder.
- 2) Use a copper pipe to direct the piping material, and attach a flow-meter to the cylinder.
- 3) Apply a seal onto the clearance between the piping material and inserted copper pipe for Nitrogen in order to prevent backflow of the Nitrogen gas.
- 4) When the Nitrogen gas is flowing, be sure to keep the piping end open.
- 5) Adjust the flow rate of Nitrogen gas so that it is lower than 0.05 m<sup>3</sup>/Hr or 0.02 MPa (0.2kgf/cm<sup>2</sup>) by means of the reducing valve.
- 6) After performing the steps above, keep the Nitrogen gas flowing until the pipe cools down to a certain extent (temperature at which pipes are touchable with hands).
- 7) Remove the flux completely after brazing.

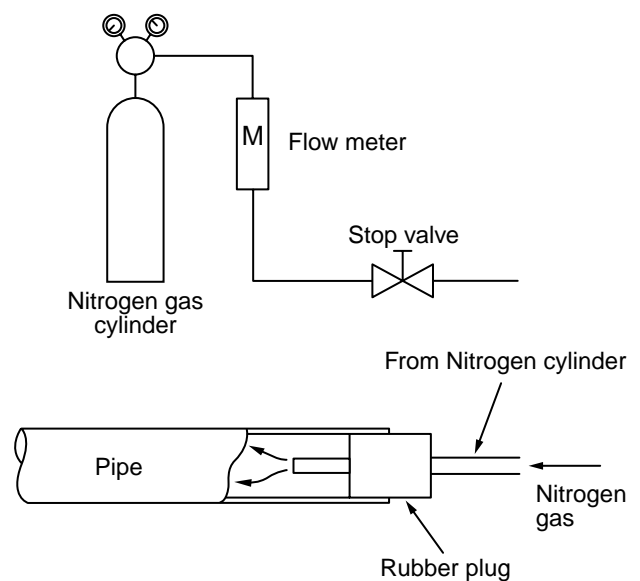

**Fig. 6-5-1 Prevention of oxidation during brazing**

## 6-6. Instructions for Re-use Piping of R22 or R407C

### Instruction of Works:

The existing R22 and R407C piping can be reused for our digital inverter R410A products installations.

### WARNING

Confirming the existence of scratches or dents on the existing pipes and confirming the reliability of the pipe strength are conventionally referred to the local site.

**If the definite conditions can be cleared, it is possible to update the existing R22 and R407C pipes to those for R410A models.**

#### 6-6-1. Basic Conditions Needed to Reuse the Existing Pipe

Check and observe three conditions of the refrigerant piping works.

1. Dry (There is no moisture inside of the pipes.)
2. Clean (There is no dust inside of the pipes.)
3. Tight (There is no refrigerant leak.)

#### 6-6-2. Restricted Items to Use the Existing Pipes

In the following cases, the existing pipes cannot be reused as they are. Clean the existing pipes or exchange them with new pipes.

1. When a scratch or dent is heavy, be sure to use the new pipes for the works.
2. When the thickness of the existing pipe is thinner than the specified "Pipe diameter and thickness" be sure to use the new pipes for the works.
  - The operating pressure of R410A is high (1.6 times of R22 and R407C). If there is a scratch or dent on the pipe or thinner pipe is used, the pressure strength is poor and may cause breakage of the pipe at the worst.

#### \* Pipe diameter and thickness (mm)

Reference outside diameter (mm)	Wall thickness (mm)	Material
6.4	0.8	—
9.5	0.8	—
12.7	0.8	—
15.9	1.0	—
19.1	1.2	—
22.2	1.0	Half hard
28.6	1.0	Half hard

- In case that the pipe diameter is  $\varnothing 12.7$  mm or less and the thickness is less than 0.7 mm, be sure to use the new pipes for works.
3. The pipes are left as coming out or gas leaks. (Poor refrigerant)
    - There is possibility that rain water or air including moisture enters in the pipe.
  4. Refrigerant recovery is impossible. (Refrigerant recovery by the pump-down operation on the existing air conditioner)
    - There is possibility that a large quantity of poor oil or moisture remains inside of the pipe.

5. A dryer on the market is attached to the existing pipes.
  - There is possibility that copper green rust generated.
6. Check the oil when the existing air conditioner was removed after refrigerant had been recovered. In this case, if the oil is judged as clearly different compared with normal oil
  - The refrigerator oil is copper rust green : There is possibility that moisture is mixed with the oil and rust generates inside of the pipe.
  - There is discolored oil, a large quantity of the remains, or bad smell.
  - A large quantity of sparkle remained wear-out powder is observed in the refrigerator oil.
7. The air conditioner which compressor was exchanged due to a faulty compressor. When the discolored oil, a large quantity of the remains, mixture of foreign matter, or a large quantity of sparkle remained wear-out powder is observed, the cause of trouble will occur.
8. Installation and removal of the air conditioner are repeated with temporary installation by lease and etc.
9. In case that type of the refrigerator oil of the existing air conditioner is other than the following oil (Mineral oil), Suniso, Freol-S, MS (Synthetic oil), alkyl benzene (HAB, Barrel-freeze), ester series, PVE only of ether series.
  - Winding-insulation of the compressor may become inferior.

#### NOTE

The above descriptions are results of confirmation by our company and they are views on our air conditioners, but they do not guarantee the use of the existing pipes of the air conditioner that adopted R410A in other companies.

#### 6-6-3. Branching Pipe for Simultaneous Operation System

- In the concurrent twin system, when TOSHIBA-specified branching pipe is used, it can be reused. Branching pipe model name: RBC-TWP30E-2, RBC-TWP50E-2, RBC-TRP100E. On the existing air conditioner for simultaneous operation system (twin system), there is a case of using branch pipe that has insufficient compressive strength. In this case please change it to the branch pipe for R410A.

#### 6-6-4. Curing of Pipes

When removing and opening the indoor unit or outdoor unit for a long time, cure the pipes as follows:

- Otherwise rust may generate when moisture or foreign matter due to dewing enters in the pipes.
- The rust cannot be removed by cleaning, and a new piping work is necessary.

Place position	Term	Curing manner
Outdoors	1 month or more	Pinching
	Less than 1 month	
Indoors	Every time	Pinching or taping

### 6-6-5. Final Installation Checks

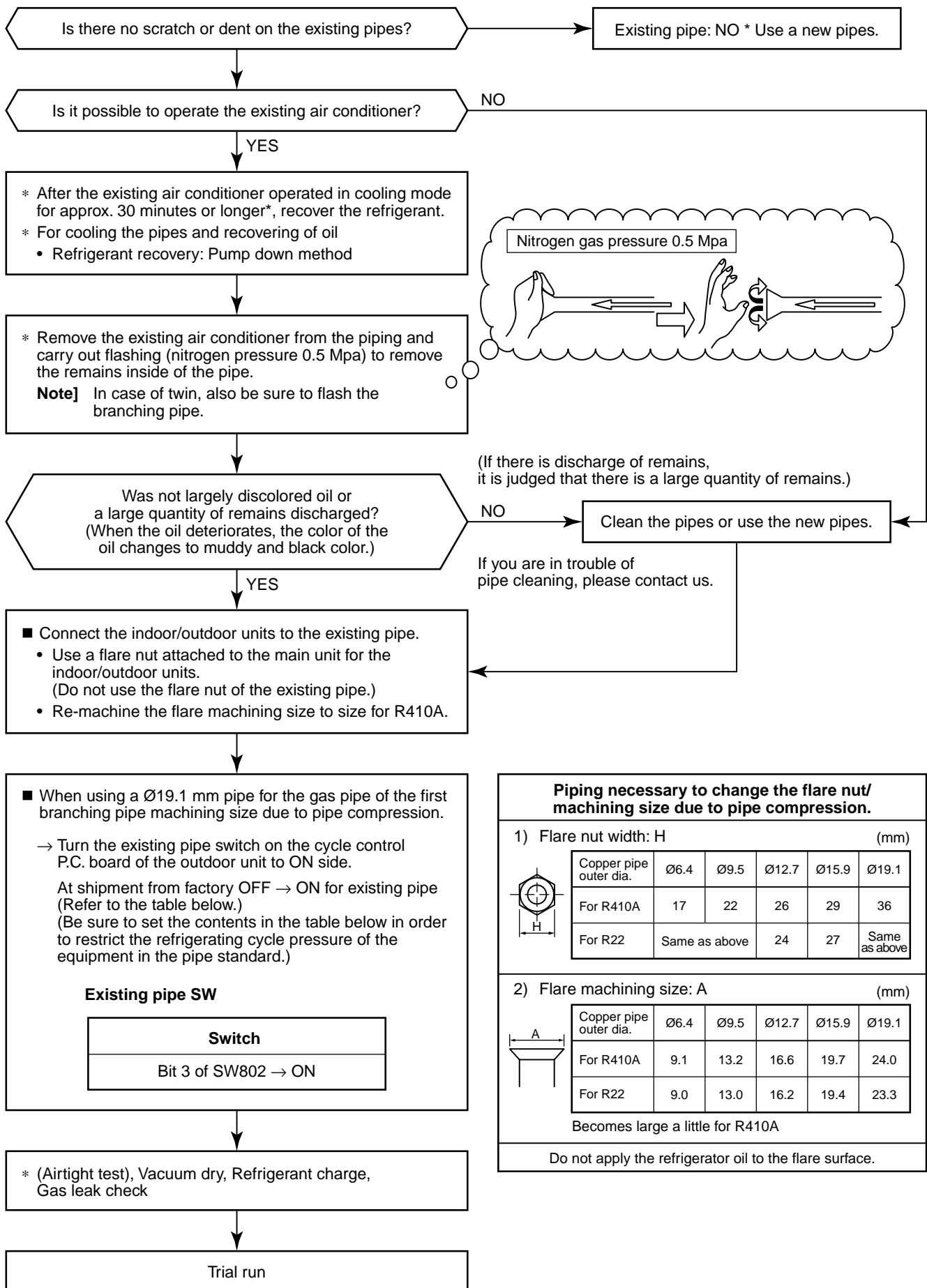

**Piping necessary to change the flare nut/ machining size due to pipe compression.**

1) Flare nut width: H (mm)

	Copper pipe outer dia.	Ø6.4	Ø9.5	Ø12.7	Ø15.9	Ø19.1
	For R410A	17	22	26	29	36
	For R22	Same as above		24	27	Same as above

2) Flare machining size: A (mm)

	Copper pipe outer dia.	Ø6.4	Ø9.5	Ø12.7	Ø15.9	Ø19.1
	For R410A	9.1	13.2	16.6	19.7	24.0
	For R22	9.0	13.0	16.2	19.4	23.3

Becomes large a little for R410A

Do not apply the refrigerator oil to the flare surface.

### 6-6-6. Handling of Existing Pipe

When using the existing pipe, carefully check it for the following:

- Wall thickness (within the specified range)
- Scratches and dents
- Water, oil, dirt, or dust in the pipe
- Flare looseness and leakage from welds
- Deterioration of copper pipe and heat insulator
- Before recovering the refrigerant in the existing system, perform a cooling operation for at least 30 minutes.

#### Cautions for using existing pipe

- Do not reuse a flare nut to prevent gas leaks. Replace it with the supplied flare nut and then process it to a flare.
- Blow nitrogen gas or use an appropriate means to keep the inside of the pipe clean. If discolored oil or much residue is discharged, wash the pipe.
- Check welds, if any, on the pipe for gas leaks.
- There may be a problem with the pressure resistance of the branching pipes of the existing piping. Replace them with branch pipes (sold separately).

When the pipe corresponds to any of the following, do not use it. Install a new pipe instead.

- The pipe has been opened (disconnected from indoor unit or outdoor unit) for a long period.
- The pipe has been connected to an outdoor unit that does not use refrigerant R22, R410A or R407C.
- The existing pipe must have a wall thickness equal to or larger than the following thicknesses.

Reference outside diameter (mm)	Wall thickness (mm)	Material
6.4	0.8	—
9.5	0.8	—
12.7	0.8	—
15.9	1.0	—
19.1	1.2	—
22.2	1.0	Half hard
28.6	1.0	Half hard

- Do not use any pipe with a wall thickness less than these thicknesses due to insufficient pressure capacity.

- When using a  $\varnothing 19.1$  mm gas pipe for the existing piping, set bit 3 of SW802 (switch for existing pipe) on the P.C. board of the outdoor unit to ON.

In this case, the heating performance may be reduced depending on the outside air temperature and room temperature.

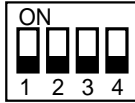
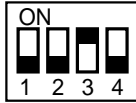
SW802	
When shipped from factory	When using existing pipe
	

### 6-6-7. Recovering Refrigerant

Use the refrigerant recovery equipment to recover the refrigerant.

## 7. CIRCUIT CONFIGURATION AND CONTROL SPECIFICATIONS

### 7-1. Outdoor Unit Control

#### 7-1-1. Print Circuit Board, MCC-1596 (Compressor IPDU)

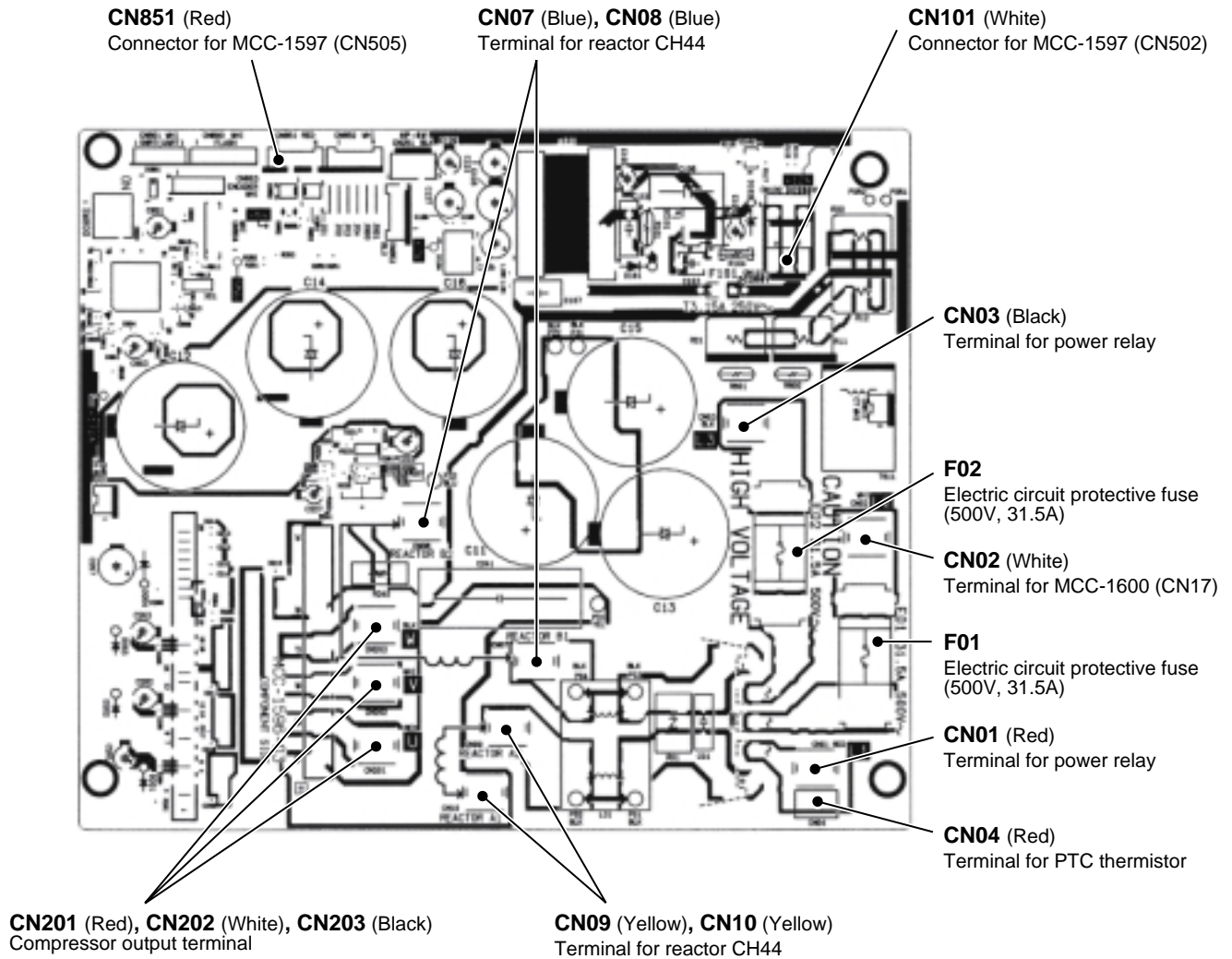

**7-1-2. Print Circuit Board, MCC-1597 (Fan Motor IPDU)**

**CN750 (White)**  
Fan motor output (Upper side)

**CN700 (Blue)**  
Connector for MCC-1436 (CN03 or CN07)

**CN500 (Red)**  
Connector for MCC-1600 (CN23)  
and reactor CH68

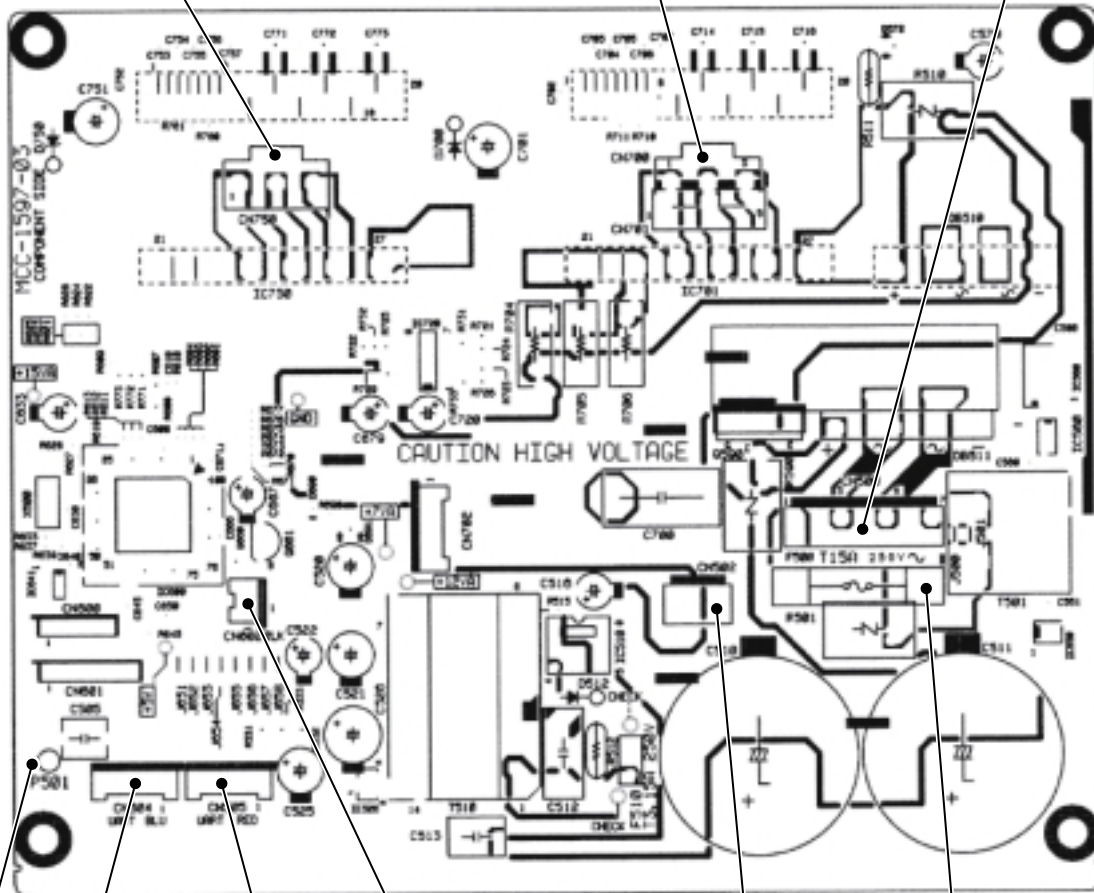

**CN504 (Blue)**  
Connector for MCC-1599  
(CN802)

**CN602 (Black)**  
Connector for MCC-1600 (CN51)

**F500**  
Electric circuit protective fuse  
(250V, 15A)

**P501 (Black)**  
Lead wire for grounding

**CN505 (Red)**  
Connector for MCC-1596 (CN851)

**CN502 (White)**  
Connector for MCC-1596 (CN101)

### 7-1-3. Print Circuit Board, MCC-1599 (Interface (CDB))

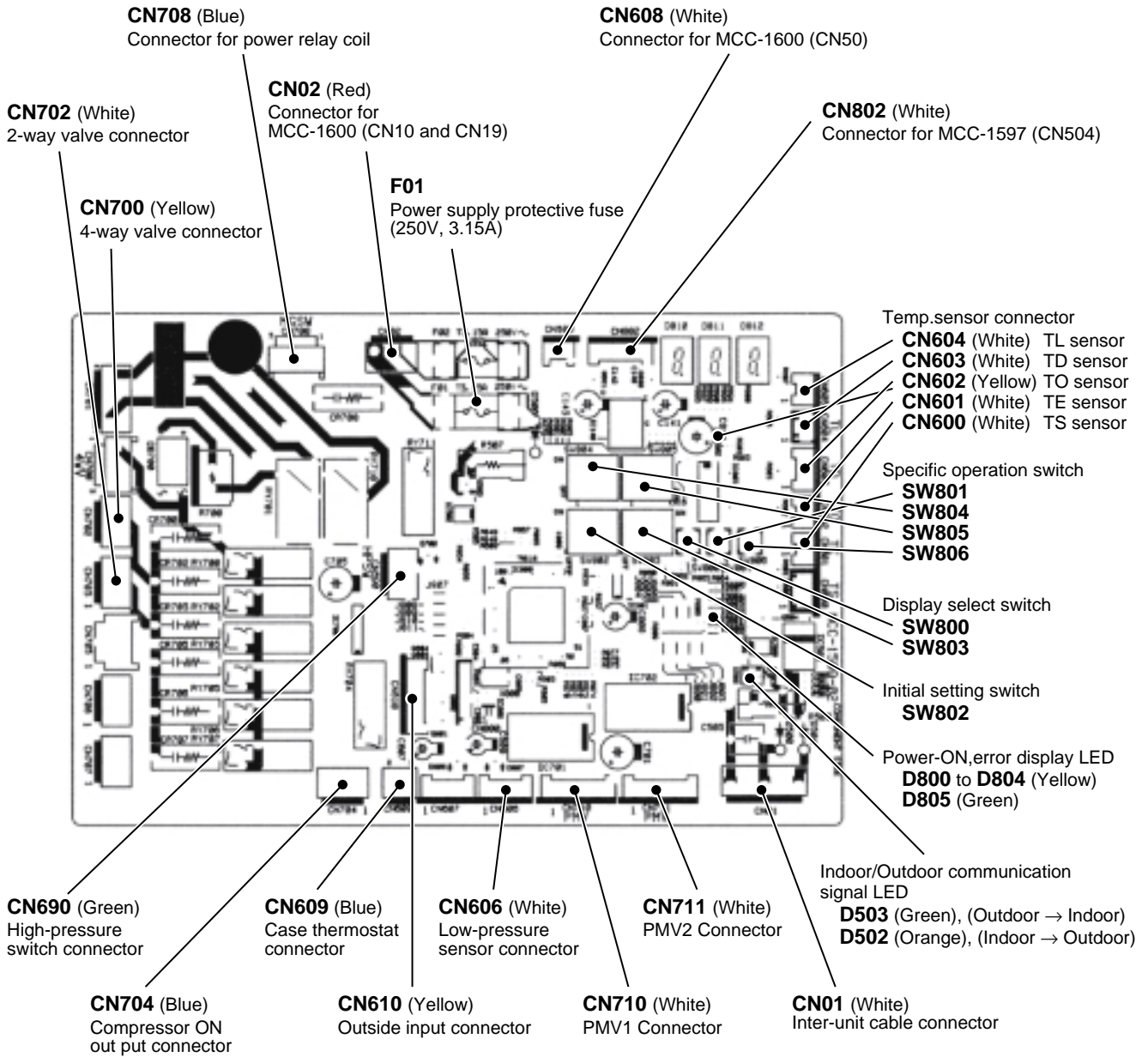

**7-1-4. Print Circuit Board, MCC-1600 (Noise Filter)**

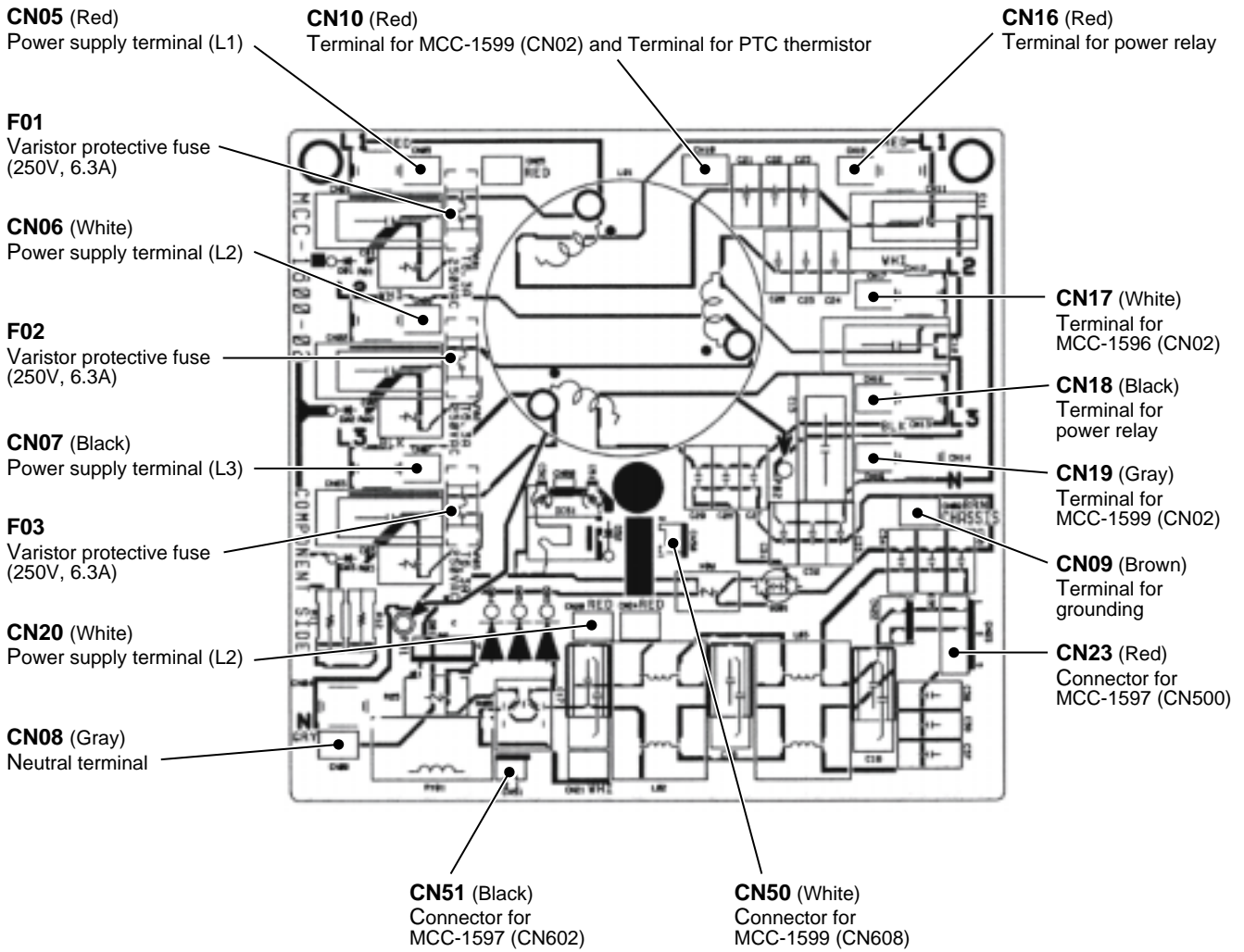



## 7-2. Outline of Main Controls

### 1. PMV (Pulse Motor Valve) control

- 1) The aperture of the PMV (1, 2) is controlled between 88 (44 + 44) to 1000 (500 + 500) pulses during operation.
- 2) During cooling and heating operations, the PMV aperture is controlled by the temperature difference between a detected temperature from a TS sensor and a saturation temperature equivalent value (TU temperature) from a Ps sensor. (SH control).
- 3) The temperature difference in 2) in both cooling and heating operations is usually controlled using a 5K target value.  
(However control may be performed within a range of 1 – 15K depending on operating conditions).
- 4) When the cycle overheats during both cooling and heating operations, the PMV aperture is controlled using a detection value from a TD sensor.

The normal target value is 96°C for cooling operations and 102°C for heating operations.

### CAUTION

Sensor malfunction may cause liquid back-flow or error overheating in the compressor resulting in dramatic reduction in the durable life of the compressor.

In the event of malfunction and repair of the compressor, restart operation after checking that there are no errors in the resistance values or the refrigerating cycle of each sensor.

### 2. Discharge temperature release control

- 1) This control lowers the revolution number of the compressor in the event that the discharge temperature is not reduced or in the event the discharge temperature increases rapidly during PMV control.

The cycle is stabilized by dividing compressor revolution number control into units up to 0.6 rps.

- 2) When the detected discharge temperature is in an error zone, compressor operation is stopped and then restarted after 2 minutes 30 seconds.

An error count is added on each occasion the error zone is detected and when the error is detected 4 times, a "P03" error is performed.

When normal operation continues for a period of 10 minutes, the error count is cleared.

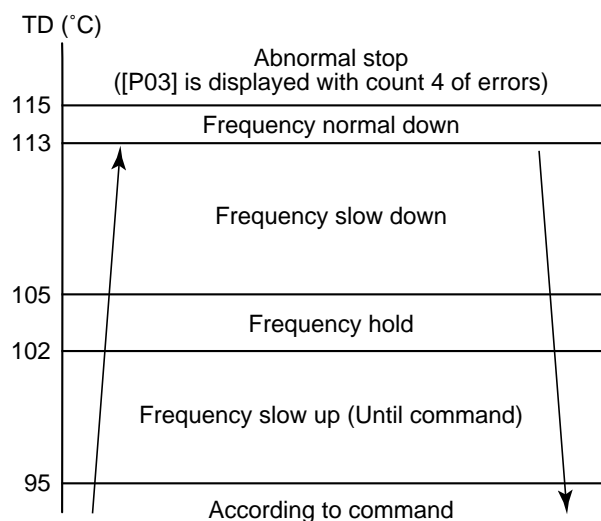

### 3. Outdoor fan revolution number control

Control of fan revolution number and the fan taps in this unit are shown below.

**Fan Taps Revolution number Allocation [rpm]**

		W1	W2	W3	W4	W5	W6	W7	W8	W9	WA	WB	WC	WD	WE	WF
SM224	Upper Fan	250	280	280	310	340	400	460	520	580	640	710	760	830	860	920
	Lower Fan	0	0	250	270	300	350	410	470	530	590	640	710	770	810	850
SM280	Upper Fan	250	280	280	340	400	460	520	580	640	710	760	830	860	920	940
	Lower Fan	0	0	250	300	350	410	470	530	590	640	710	770	810	850	920

#### 3-1. Cooling fan control

- 1) Cooling operations of the outdoor fan are controlled by a TL sensor, TO sensor and the compressor revolution number. Control is performed per 1 tap of DC fan control.

The outdoor fan is controlled by every 1 tap of DC fan control (14 taps).

During startup, operation is fixed for 60 seconds to a maximum fan tap corresponding to the zones shown in the table below. Thereafter fan tap is controlled by a temperature outputted from the TL sensor.

	Less than 45 rps		45 rps or more and less than 60 rps		60 rps or more	
	Min.	Max.	Min.	Max.	Min.	Max.
$38^{\circ}\text{C} \leq \text{TO}$	W6	WE	W8	WF	WA	WF
$29^{\circ}\text{C} \leq \text{TO} < 38^{\circ}\text{C}$	W5	WD	W7	WF	W9	WF
$15 \leq \text{TO} < 29^{\circ}\text{C}$	W3	WA	W5	WC	W7	WE
$5 \leq \text{TO} < 15^{\circ}\text{C}$	W2	W8	W4	WA	W6	WC
$0 \leq \text{TO} < 5^{\circ}\text{C}$	W1	W6	W3	W8	W4	WA
$-5 \leq \text{TO} < 0^{\circ}\text{C}$	W1	W5	W2	W7	W3	W8
$\text{TO} < -5^{\circ}\text{C}$	W1	W4	W3	W5	W3	W6
TO error	W1	WE	W3	WF	W3	WF

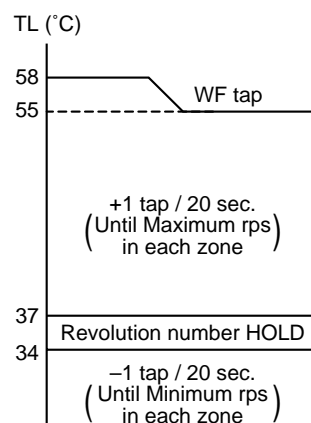

#### 3-2 Heating fan control

- 1) Heating operations of the outdoor fan are controlled by a TE sensor, TO sensor and the compressor revolution number.  
(Control from a minimum W1 to a maximum is performed according to the table below).
- 2) Operation is fixed for 3 minutes after start up by a maximum fan tap corresponding to the zones in the table below. Thereafter fan control is performed using the temperature from the TE sensor.
- 3) When  $\text{TE} \geq 24^{\circ}\text{C}$  continues for 5 minutes, the compressor is stopped. The compressor is placed in the same state as a normal thermostat OFF without an error display.

The compressor is restarted after approximately 2 minutes 30 seconds and such interrupted operation does not constitute an error. When the operation in 3) above is frequently performed, the filter of the intake section of the indoor unit may require cleaning.

Therefore restart operation after cleaning the filter.

		Less than 45 rps	45 rps or more and less than 60 rps	60 rps or more
Maximum	$10^{\circ}\text{C} \leq \text{TO}$	WA	WB	WC
	$5 \leq \text{TO} < 10^{\circ}\text{C}$	WC	WD	WF
	$-3 \leq \text{TO} < 5^{\circ}\text{C}$	WF	WF	WF
	$-10 \leq \text{TO} < -3^{\circ}\text{C}$	WF	WF	WF
	$\text{TO} < -10^{\circ}\text{C}$	WF	WF	WF
	TO error	WF	WF	WF

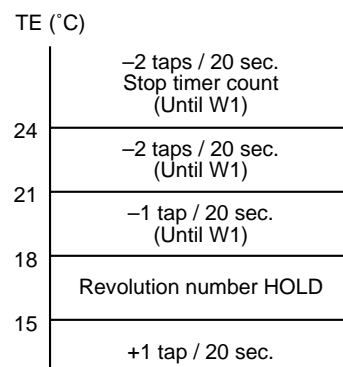

#### 4. Defrost control

- 1) During heating operations, defrost operations are performed when the temperature from the TE sensor satisfies any of the conditions in the A to D zones.
- 2) During defrosting operations, defrost will be terminated if the temperature from the TE sensor continues at 12°C or higher for 3 seconds or if the temperature is 7°C ≤ TE < 12°C for 1 minute. Furthermore the defrost operation will be terminated if defrosting operations have continued for 10 minutes even if TE sensor temperature is less than 7°C.
- 3) After defrost operations have been reset, the compressor restarts heating operations without stopping.

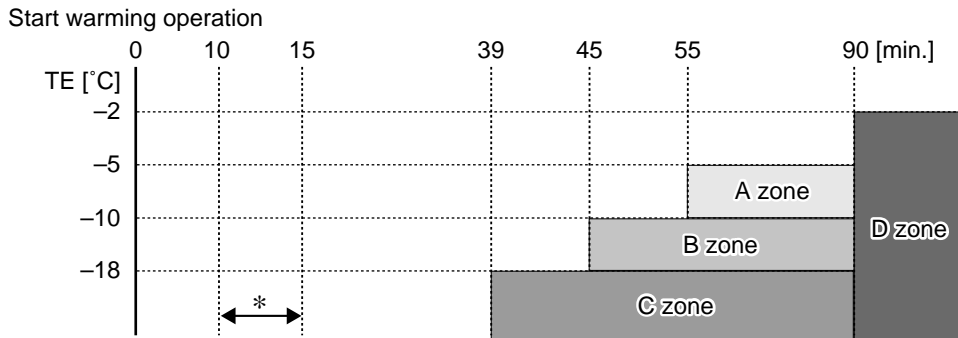

\* The minimum TE value during 10 and 15 minutes after starting heating operation is stored as TEO.

	When To is normal	When To is abnormal
A Zone	Status [(TEO-TE) - (ToO-To) ≥ 3°C] continues for 20 seconds	Status [TEO- TE ≥ 3°C] continues for 20 seconds
B Zone	Status [(TEO-TE) - (ToO-To) ≥ 2°C] continues for 20 seconds	Status [TEO-TE ≥ 2°C] continues for 20 seconds
C Zone	Status [TE ≤ 23°C] continues for 20 seconds	
D Zone	When compressor operation status TE < 2°C is calculated for d minutes	

- 4) The above time of d can be changed by selecting jumper [J805] or [J806].  
(Setting at shipment; 90 minutes)

J805	J806	d
○	○	150 minutes
○	✕	90 minutes (Setting at shipment)
✕	○	60 minutes
✕	✕	30 minutes

○ : Short-circuit, ✕ : Open

#### 5. Short interrupted operation preventive control

- 1) Even when a thermostat OFF signal is received from the indoor unit, the compressor may not stop during an 8 minute period after startup in order to protect the compressor. This operation is not an error condition.
- 2) When operation is terminated by using a remote controller, operation will not continue.

#### 6. Electrical current release control

An AC current detection value from T611 on the IPDU control board is used to suppress the revolution number of the compressor so that the input current of the inverter does not exceed a specified value.

A Zone	Normal operation.	
D Zone	Maintain frequency of current operation.	
B Zone	Reduce operating frequency.	
C Zone	Cease reduction of operating frequency and maintain frequency of current operation.	

	SM224 Type	SM280 Type
I1 value (A)	15.7	17.6

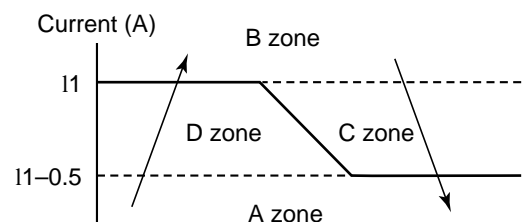

## 7. Heat sink temperature detection control

- 1) IGBT overheating prevention is protective control performed by a thermistor (TH sensor) in proximity to IGBT.
- 2) When a temperature of  $TH \geq 83^{\circ}\text{C}$  is detected, the fan tap is moved by 1 step up.  
Thereafter step-up is performed at a rate of +1 tap/5 seconds until a maximum fan tap is reached.
- 3) After 2) above, operation is returned to normal fan control at a temperature of  $TH < 78^{\circ}\text{C}$ .
- 4) Operation of the compressor is terminated at a temperature of  $TH \geq 100^{\circ}\text{C}$ .
- 5) Operation is restarted after 2 minutes and 30 seconds using [1] as the error count. However a count of [4] in the same operation confirms an error. The error display is "P07" (Restart will not be performed).

\* When error is confirmed, this may be an error caused by heat build-up or blower fan failure in the outdoor unit, or an error in the IPDU board.

## 8. Electrical current release value shift control

- 1) This control is for the purpose of preventing malfunction of the compressor or electronic components such as the IGBT of the inverter in the compressor drive system during cooling operations.
- 2) Select the current release control value (I1) by TO sensor value from the right table.

The correction is based on the table below:

Temp. range	SM224	SM280
$50^{\circ}\text{C} \leq \text{TO}$	9.0	9.0
$47^{\circ}\text{C} \leq \text{TO} < 50^{\circ}\text{C}$	11.0	11.0
$44^{\circ}\text{C} \leq \text{TO} < 47^{\circ}\text{C}$	14.0	14.0
$\text{TO} < 44^{\circ}\text{C}$	15.7	17.6
TO error	9.0	9.0

## 9. Over-current protective control

- 1) Operation of the compressor is stopped when the over-current protective circuit detects an error current.
- 2) The compressor restarts after 2 minutes 30 seconds using [1] as an error count.  
After restart, the error count is cleared when operation continues for 6 minutes or more.
- 3) An error is confirmed when the error count takes a value of [8].
- 4) For the indicated contents of error, confirm using the check code table.

## 10. High-pressure switch/Compressor case thermostat control

- 1) When the high-pressure switch or the compressor case thermostat operates, the operation of the compressor is terminated.
- 2) The compressor restarts after 2 minutes 30 seconds using [1] as an error count.  
After restart, the error count is cleared when operation continues for 10 minutes or more.
- 3) An error is confirmed with the error count [10].
- 4) For the indicated contents of error, confirm using the check code table.

## 11. High-pressure release control

- 1) The operation frequency is controlled to restrain abnormal rising of high pressure by TL sensor in cooling operation and TC sensor in heating operation.
- 2) When TL sensor in cooling operation or TC sensor in heating operation detects abnormal temperature of the stop zone, stop the compressor and the error count becomes +1.
- 3) When the compressor stopped with 2), the operation restarts from the point of the normal operation zone (e point or lower) where it returned after 2 minutes 30 seconds.
- 4) The error count when the compressor stopped with 2) is cleared after the operation continued for 10 minutes. If the error count becomes [10] without clearing, the error is determined and reactivation is not performed.
- 5) For the error display contents, confirm on the check code list.

HEAT TC / COOL TL

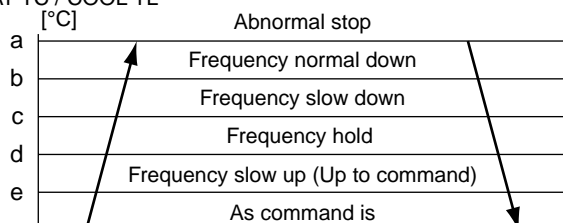

	HEAT	COOL
	TC	TL
a	62°C	63°C
b	57°C	62°C
c	55°C	60°C
d	53°C	58°C
e	49°C	54°C

## 12. SV2 valve control

The conditions for opening and closing the SV2 valve are shown in the table below.

		SV2 Valve "Open" Conditions	SV2 Valve "Close" Conditions
Non-operation	(1)	When operation stopped after operating	When operation started after operating or when 30 minutes elapsed after opening SV2 under conditions (1) (2)
	(2)	When power placed "ON"	
During Cooling Operations	(3)	When 30 second elapses after first startup operation when power ON at $TO \leq 5^{\circ}C$	When 8 minutes elapsed after starting operation.
	(4)	When $Ps \leq 0.23 MPa$	When $Ps \geq 0.27 MPa$
During Heating Operations	(5)	When 30 second elapses after first startup operation when power ON at $TC < 26^{\circ}C$	When 8 minutes elapsed after starting operation or when $TC \geq 26^{\circ}C$
	(6)	When $Ps \leq 0.14 MPa$	When $Ps \geq 0.19 MPa$
During Defrost Operation	(7)	When conditions for defrost satisfied.	When 4-way valve is OFF during defrost startup.
	(8)	When conditions for defrost satisfied.	When 2 minutes elapsed after four-way valve is ON after defrost completion

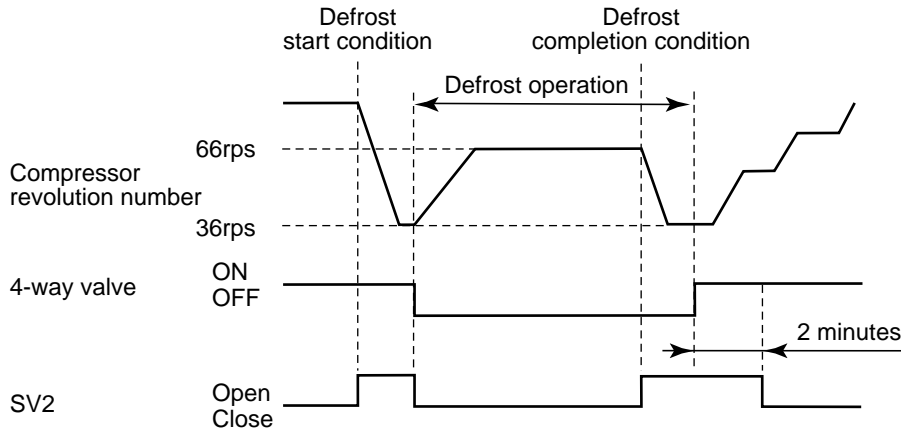

## 13. Oil recovery control

- 1) This control enables periodic recovery of oil accumulating in the indoor unit or in the exchange pipe.
- 2) After continuous operation for 240 minutes, the lower limit for the compressor revolution number is raised for 2 minutes and oil is recovered.

	Control Conditions	Control Details
During Cooling	Continuous cooling operation for 240 minutes	Lower limit for compressor revolution number placed to 56 rps per 2 minutes
During Heating	Continuous heating operation for 240 minutes	Lower limit for compressor revolution number placed to 70 rps per 2 minutes

3)

During startup of oil recovery control, the compressor revolution number during operation is lower than the revolution number of the lower limit for control details.	When low	The compressor rotation speed is raised to the lower limit during control.
	When high	Operate according to indoor commands without lowering the compressor rotation speed to the lower limit. (In this case, the timer counts 2 minutes.)

- 4) When the DOWN zone and the HOLD zone (UP prohibition) are superimposed for example during current release control or discharge temperature release control, DOWN zone and the HOLD zone have priority over oil recovery control.

## 14. Coil heating control

- 1) This control has the function of heating the compressor by applying a current to the compressor when not operating instead using a case heater.

This control is for the purpose of preventing stagnation of the refrigerant inside the compressor.

- 2) Malfunction in the compressor may result if a current is not applied for a specified time before a test run after installation as was previously the case.

Similarly, starting operation after turning the power OFF and not operating for a long time also requires application of a current before starting operation, in the same manner as the test run.

- 3) Application of current is determined by TD and TO sensors.

When the TO sensor is defective, a backup control is automatically performed by the TE sensor.

When TO sensor is defective, make a determination using the LED display of the outdoor interface board.

- 4) The power is turned off when TD is 30°C or more.

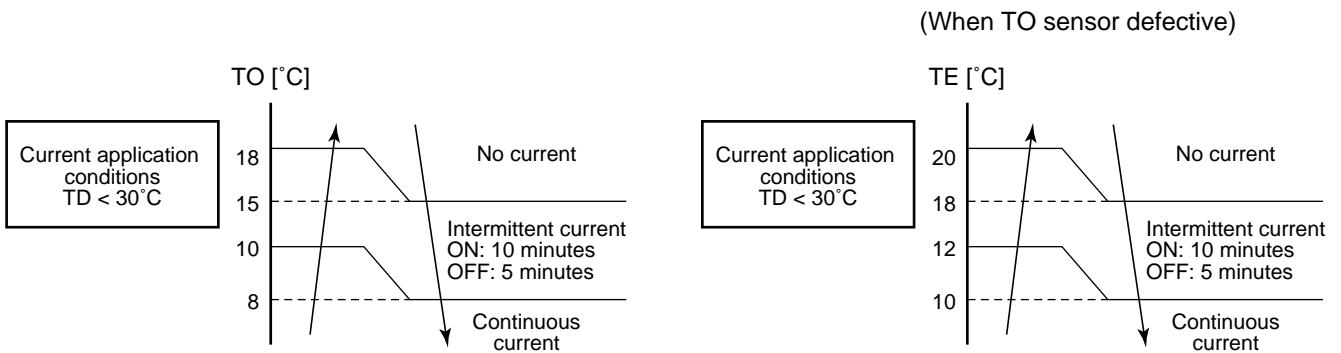

Intermittent current	Corresponding to 100w
Continuous current	Corresponding to 100w

(100W : Total power consumption of inverter and compressor)

### NOTE

---

While heating and electrifying the winding wire, electrifying sound may generate. It is nor abnormal.

---

## 8. TROUBLESHOOTING

### 8-1. Summary of Troubleshooting

<Wired remote controller type>

#### 1. Before troubleshooting

- 1) Required tools/instruments
  - ⊕ and ⊖ screwdrivers, spanners, radio cutting pliers, nippers, push pins for reset switch
  - Tester, thermometer, pressure gauge, etc.
- 2) Confirmation points before check
  - a) The following operations are normal.
    1. Compressor does not operate.
      - Is not 3-minutes delay (3 minutes after compressor OFF)?
      - Is not the outdoor unit in standby status though the remote controller reached the setup temperature?
      - Does not timer operate during fan operation?
      - Is not an overflow error detected on the indoor unit?
      - Is not outside high-temperature operation controlled in heating operation?
    2. Indoor fan does not rotate.
      - Does not cool air discharge preventive control work in heating operation?
    3. Outdoor fan does not rotate or air volume changes.
      - Does not high-temperature release operation control work in heating operation?
      - Does not outside low-temperature operation control work in cooling operation?
      - Is not defrost operation performed?
    4. ON/OFF operation cannot be performed from remote controller.
      - Is not the control operation performed from outside/remote side?
      - Is not automatic address being set up?  
(When the power is turned on at the first time or when indoor unit address setting is changed, the operation cannot be performed for maximum approx. 5 minutes after power-ON.)
      - Is not being carried out a test run by operation of the outdoor controller?
  - b) Did you return the cabling to the initial positions?
  - c) Are connecting cables of indoor unit and remote controller correct?

#### 2. Troubleshooting procedure

When a trouble occurred, check the parts along with the following procedure.



#### NOTE

---

---

For cause of a trouble, power conditions or malfunction/erroneous diagnosis of microcomputer due to outer noise is considered except the items to be checked. If there is any noise source, change the cables of the remote controller to shield cables.

---

---

## <Wireless remote controller type>

### 1. Before troubleshooting

- 1) Required tools/instruments
  - ⊕ and ⊖ screwdrivers, spanners, radio cutting pliers, nippers, etc.
  - Tester, thermometer, pressure gauge, etc.
- 2) Confirmation points before check
  - a) The following operations are normal.
    1. Compressor does not operate.
      - Is not 3-minutes delay (3 minutes after compressor OFF)?
      - Is not the outdoor unit in standby status though the remote controller reached the setup temperature?
      - Does not timer operate during fan operation?
      - Is not an overflow error detected on the indoor unit?
      - Is not outside high-temperature operation controlled in heating operation?
    2. Indoor fan does not rotate.
      - Does not cool air discharge preventive control work in heating operation?
- 3) Outdoor fan does not rotate or air volume changes.
  - Does not high-temperature release operation control work in heating operation?
  - Does not outside low-temperature operation control work in cooling operation?
  - Is not defrost operation performed?
- 4) ON/OFF operation cannot be performed from remote controller.
  - Is not forced operation performed?
  - Is not the control operation performed from outside/remote side?
  - Is not automatic address being set up?
  - Is not being carried out a test run by operation of the outdoor controller?
  - a) Did you return the cabling to the initial positions?
  - b) Are connecting cables between indoor unit and receiving unit correct?

### 2. Troubleshooting procedure

(When the power is turned on at the first time or when indoor unit address setting is changed, the operation cannot be performed for maximum approx. 5 minutes after power-ON.)

When a trouble occurred, check the parts along with the following procedure.

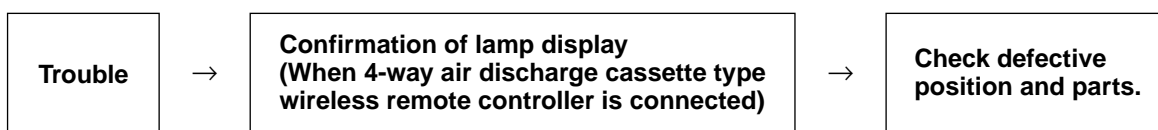

#### 1) Outline of judgment

The primary judgment to check where a trouble occurred in indoor unit or outdoor unit is performed with the following method.

---

### Method to judge the erroneous position by flashing indication on the display part of indoor unit (sensors of the receiving unit)

---

The indoor unit monitors operating status of the air conditioner, and the blocked contents of self-diagnosis are displayed restricted to the following cases if a protective circuit works.



## 8-2. Troubleshooting

### 8-2-1. Outline of judgment

The primary judgment to check whether a trouble occurred in the indoor unit or outdoor unit is carried out with the following method.

Method to judge the erroneous position by flashing indication on the display part of the indoor unit (sensors of the receiving part)

The indoor unit monitors the operating status of the air conditioner, and the blocked contents of self-diagnosis are displayed restricted to the following cases if a protective circuit works.

● : Go off, ○ : Go on, ☼ : Flash (0.5 sec.)

Lamp indication	Check code	Cause of trouble occurrence
Operation    Timer    Ready ●            ●            ● No indication at all	—	Power supply OFF or miswiring between receiving unit and indoor unit
Operation    Timer    Ready ☼            ●            ● Flash	E01	Receiving error } Receiving unit } Sending error } Communication stop } Miswiring or wire connection error between receiving unit and indoor unit
	E02	
	E03	
	E08	Duplicated indoor unit No. } Duplicated master units of remote controller } Setup error
	E09	
	E10	Communication error between CPUs on indoor unit P.C. board
E18	Wire connection error between indoor units, Indoor power OFF (Communication stop between indoor master and follower or between main and sub indoor twin)	
Operation    Timer    Ready ●            ●            ☼ Flash	E04	Miswiring between indoor unit and outdoor unit or connection error (Communication stop between indoor and outdoor units)
Operation    Timer    Ready ●            ☼            ☼ Alternate flash	P01	Overflow was detected. } Indoor DC fan error } Protective device of indoor unit worked.
	P10	
	P12	
Operation    Timer    Ready ☼            ●            ☼ Alternate flash	P03	Outdoor unit discharge temp. error } Outdoor high pressure system error } Protective device of outdoor unit worked.    *1
	P04	
	P05	Negative phase detection error } Heat sink overheat error } Gas leak detection error } Outdoor unit error
	P07	
	P15	
	P19	4-way valve system error (Indoor or outdoor unit judged.)
	P20	Outdoor unit high pressure protection
	P22	Outdoor unit: Outdoor unit error } Outdoor unit: Inverter Idc operation } Outdoor unit: Position detection error } Protective device of outdoor unit worked.    *1
	P26	
	P29	
P31	Stopped because of error of other indoor unit in a group (Check codes of E03/L03/L07/L08)	

\*1: These are representative examples and the check code differs according to the outdoor unit to be combined.

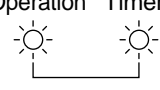
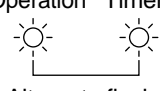
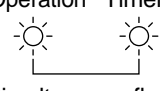
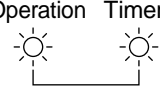
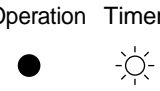
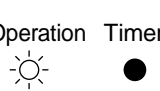
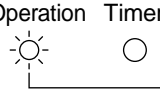
Lamp indication	Check code	Cause of trouble occurrence
Operation Timer Ready  Alternate flash	F01	Heat exchanger sensor (TCJ) error Heat exchanger sensor (TC) error Heat exchanger sensor (TA) error } Indoor unit sensor error
	F02	
	P10	
Operation Timer Ready  Alternate flash	F04	Discharge temp. sensor (TD) error Temp. sensor (TE) error Temp. sensor (TL) error Temp. sensor (TO) error Temp. sensor (TS) error Temp. sensor (TH) error Temp. Sensor miswiring (TE, TS) } Sensor error of outdoor unit *1
	F06	
	F07	
	F08	
	F12	
	F13	
	F15	
Operation Timer Ready  Simultaneous flash	F29	Indoor EEPROM error
Operation Timer Ready  Simultaneous flash	F31	Outdoor EEPROM error
Operation Timer Ready  Flash	H01	Compressor break down Compressor lock Current detection circuit error Case thermostat worked. PS pressure sensor error, low pressure protective operation } Outdoor compressor system error *1 } Power supply, outdoor P.C. board error } Compressor overheat, outdoor wiring error } Outdoor unit } low pressure system error
	H02	
	H03	
	H04	
	H06	
Operation Timer Ready  Simultaneous flash	L03	Duplicated master indoor units There is indoor unit of group connection in individual indoor unit. Unsetting of group address Missed setting (Unset indoor capacity) } → AUTO address * If group construction and address are not normal when power supply turned on, automatically goes to address setup mode.
	L07	
	L08	
	L09	
Operation Timer Ready  Simultaneous flash	L10	Unset model type (Service board)
	L20	Duplicated indoor central addresses
	L29	Outdoor unit and other error
	L30	Outside interlock error
	L31	Negative phase error

\*1: These are representative examples and the check code differs according to the outdoor unit to be combined.

### 8-2-2. Others (Other than Check Code)

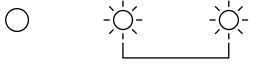
Lamp indication	Check code	Cause of trouble occurrence
Operation    Timer    Ready  Simultaneous flash	—	During test run
Operation    Timer    Ready  Alternate flash	—	Disagreement of cool/heat (Automatic cool/heat setting to automatic cool/heat prohibited model, or setting of heating to cooling-only model)

## 8-2-3. Monitor Function of Remote Controller Switch

### ■ Calling of sensor temperature display

#### <Contents>

Each data of the remote controller, indoor unit and outdoor unit can be understood by calling the service monitor mode from the remote controller.

#### <Procedure>

- 1 Push **TEST** + **CL** buttons simultaneously for 4 seconds to call the service monitor mode.

The service monitor goes on, the master indoor unit No. is displayed at first and then the temperature of item code **00** is displayed.



- 2 Push temperature set **TEMP.** buttons and then change the item code of data to be monitored.

The item code list is shown below.

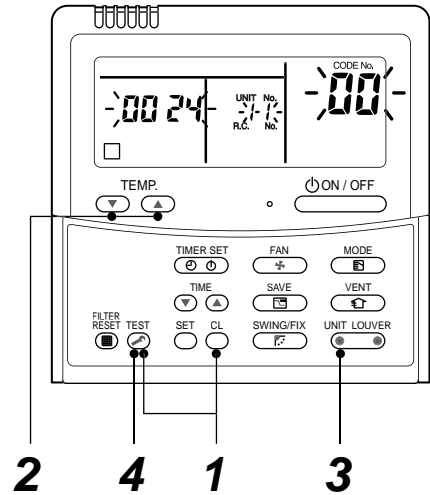

<Operation procedure>

**1 → 2 → 3 → 4**

Returned to usual display

	Item code	Data name	Unit
Indoor unit data	01	Room temperature (Remote controller)	°C
	02	Indoor suction temperature (TA)	°C
	03	Indoor heat exchanger (Coil) temperature (TCJ)	°C
	04	Indoor heat exchanger (Coil) temperature (TC)	°C
	* 07	Indoor fan revolution frequency	rpm
	* F2	Indoor fan calculated operation time	×100h
	F3	Filter sign time	×1h
	* F8	Indoor discharge temperature*1	°C

	Item code	Data name	Unit
Outdoor unit data	60	Outdoor heat exchanger (Coil) temperature (TE)	°C
	61	Outside temperature (TO)	°C
	62	Compressor discharge temperature (TD)	°C
	63	Compressor suction temperature (TS)	°C
	65	Heat sink temperature (THS)	°C
	6A	Operation current (× 1/10)	A
	* 6D	Outdoor heat exchanger (Coil) temperature (TL)	°C
	* 70	Compressor operation frequency	rps
	* 72	Outdoor fan revolution frequency (Lower)	rpm
	* 73	Outdoor fan revolution frequency (Upper)	rpm
	F1	Compressor calculated operation time	×100h

The item codes with \* marks in the above table are displayed only on the indoor units of 4 series models and after. (4 series indoor units mean RAV-SM1404UT-E for example.).



- 3 Push **UNIT LOUVER** button to select the indoor unit to be monitored. Each data of the indoor unit and its outdoor units can be monitored.



- 4 Pushing **TEST** button returns the status to the usual display.

\*1 The indoor discharge temperature of item code [F8] is the estimated value from TC or TCJ sensor.

Use this value to check discharge temperature at test run. (A discharge temperature sensor is not provided to this model.)

- The data value of each item is not the real time, but value delayed by a few seconds to ten-odd seconds.

## 8-2-4. Check Code List (Outdoor)

○ : Go on, ◎ : Flash, ● : Go off  
 ALT (Alternate): Alternate flashing when there are two flashing LED SIM (Simultaneous): Simultaneous flashing when there are two flashing LED

Remote controller indication	Sensor lamp part				Representative defective position	Detection	Explanation of error contents	Automatic reset	Operation continuation
	Block indication								
	Operation	Timer	Ready	Flash					
F04	◎	◎	○	ALT	Outdoor unit Discharge temp. sensor (TD) error	Outdoor	Open/Short of discharge temp. sensor was detected.	×	×
F06	◎	◎	○	ALT	Outdoor unit Temp. sensor (TE, TS, TL) error	Outdoor	Open/Short of heat exchanger temp. sensor was detected. Miswiring between TE sensor and TS sensor	×	×
F08	◎	◎	○	ALT	Outdoor unit Outside temp. sensor (TO) error	Outdoor	Open/Short of outside temp. sensor was detected.	○	○
F07	◎	◎	○	ALT	Outdoor unit Temp. sensor (TL) error	Outdoor	Open/Short of heat exchanger temp. sensor was detected.	×	×
F12	◎	◎	○	ALT	Outdoor unit Temp. sensor (TS) error	Outdoor	Open/Short of suction temp. sensor was detected.	×	×
F13	◎	◎	○	ALT	Outdoor unit Temp. sensor (TH) error	Outdoor	Open/Short of heat sink temp. sensor (Board installed) was detected.	×	×
F15	◎	◎	○	ALT	Outdoor unit Misconnection of temp. sensor (TE, TS)	Outdoor	Misconnection of outdoor heat exchanger temp. sensor and suction temp. sensor was detected.	×	×
F31	◎	◎	○	SIM	Outdoor unit EEPROM error	Outdoor	Outdoor P.C. board part (EEPROM) error was detected.	×	×
H01	●	◎	●		Outdoor unit Compressor break down	Outdoor	When reached min-Hz by current release control, short-circuited current (I <sub>dc</sub> ) after DC excitation was detected.	×	×
H02	●	◎	●		Outdoor unit Compressor lock	Outdoor	Compressor lock was detected.	×	×
H03	●	◎	●		Outdoor unit Current detection circuit error	Outdoor	Current detection circuit error	×	×
H04	●	◎	●		Outdoor unit Case thermostat operation	Outdoor	Case thermostat operation was detected.	×	×
H06	●	◎	●		Outdoor unit low pressure system error	Outdoor	Ps pressure sensor error, Low pressure protective operation	×	×
L10	◎	○	◎	SIM	Outdoor unit Setting error of service P.C. board type	Outdoor	When outdoor service P.C. board was used, model type select jumper setting was inappropriate.	×	×
L29	◎	○	◎	SIM	Outdoor unit Other outdoor unit error	Outdoor	1) Defective parts on outdoor P.C. board (MCU communication, EEPROM, TH sensor error) 2) When outdoor service P.C. board was used, model type selection was inappropriate. 3) Other error (Heat sink abnormal overheat, gas leak, 4-way valve inverse error) was detected.	×	×
P03	◎	●	◎	ALT	Outdoor unit Discharge temp. error	Outdoor	Error was detected by discharge temp. release control.	×	×
P04	◎	●	◎	ALT	Outdoor unit High pressure system error, Power supply voltage error	Outdoor	When case thermostat worked, error was detected by high release control from indoor/outdoor heat exchanger temp. sensor. Power supply voltage error	×	×
P05	◎	●	◎	ALT	Power supply error	Outdoor	Power supply voltage error	×	×
P07	◎	●	◎	ALT	Outdoor unit Heat sink overheat	Outdoor	Abnormal overheat was detected by outdoor heat sink temp. sensor.	×	×
P15	◎	●	◎	ALT	Gas leak detection	Outdoor	Abnormal overheat of discharge temp. or suction temp. was detected.	×	×
P20	◎	●	◎	ALT	Outdoor unit High pressure system error	Outdoor	Error was detected by high release control from indoor/outdoor heat exchanger temp. sensor.	×	×
P22	◎	●	◎	ALT	Outdoor unit Outdoor fan error	Outdoor	Error (Over-current, lock, etc.) was detected on outdoor fan drive circuit.	×	×
P26	◎	●	◎	ALT	Outdoor unit Inverter I <sub>dc</sub> operation	Outdoor	Short-circuited protective operation of compressor drive circuit element (G-Tr /IGBT) worked.	×	×
P29	◎	●	◎	ALT	Outdoor unit Position detection error	Outdoor	Position detection error of compressor motor was detected.	×	×
E01	◎	●	●		No remote controller master unit Remote controller communication error	Remote controller	Signal was not received from indoor unit. Main remote controller was not set. (including 2 remote controllers)	—	—
E02	◎	●	●		Remote controller send error	Remote controller	Signal cannot be sent to indoor unit.	—	—
E03	◎	●	●		Regular communication error between indoor and remote controller	Indoor	No communication from remote controller and network adapter	○	×
E04	●	●	◎		Indoor/Outdoor serial error	Indoor	Serial communication error between indoor and outdoor	○	×
E08	◎	●	●		Duplicated indoor addresses	Indoor	Same address as yours was detected.	○	
E09	◎	●	●		Duplicated main remote controllers	Remote controller	In 2-remote controller control, both were set as master. (Indoor master unit stops warning and follower unit continues operation.)	×	×
E10	◎	●	●		Communication error between CPU	Indoor	MCU communication error between main motor and micro computer	○	△
E18	◎	●	●		Regular communication error between master and follower indoor units	Indoor	Regular communication was impossible between master and follower indoor units. Communication between twin master (Main unit) and follower (sub unit) was impossible.	○	×
L03	◎	●	◎	SIM	Duplicated indoor master units	Indoor	There are multiple master units in a group.	×	×
L07	◎	●	◎	SIM	There is group cable in individual indoor unit.	Indoor	When even one group connection indoor unit exists in individual indoor unit	×	×
L08	◎	●	◎	SIM	Unset indoor group address	Indoor	Indoor address group was unset.	×	×
L09	◎	●	◎	SIM	Unset indoor capacity	Indoor	Capacity of indoor unit was unset.	×	×
L30	◎	○	◎	SIM	Outside error input to indoor unit (Interlock)	Indoor	Abnormal stop by CN80 outside error input	×	×
P19	◎	●	◎	ALT	4-way valve inverse error	Indoor Outdoor	In heating operation, error was detected by temp. down of indoor heat exchanger or temp. up of TE, TS.	○	×

◇ When this warning was detected before group construction/address check finish at power supply was turned on, the mode shifts automatically to AUTO address setup mode.

○ : Go on, ◎ : Flash, ● : Go off  
 ALT (Alternate): Alternate flashing when there are two flashing LED SIM (Simultaneous): Simultaneous flashing when there are two flashing LED

Remote controller indication	Sensor lamp part				Representative defective position	Detection	Explanation of error contents	Automatic reset	Operation continuation	
	Block indication									
	Operation	Timer	Ready	Flash						
F01	◎	◎	●	ALT	Indoor unit Heat exchanger sensor (TCJ) error	Indoor	Open/Short of heat exchanger (TCJ) was detected.	○	×	
F02	◎	◎	●	ALT	Indoor unit Heat exchanger sensor (TC) error	Indoor	Open/Short of heat exchanger (TC) was detected.	○	×	
F10	◎	◎	●	ALT	Indoor unit Room temp. sensor (TA) error	Indoor	Open/Short of room temp. (TA) was detected.	○	×	
F29	◎	◎	●	SIM	Indoor unit Other indoor P.C. board error	Indoor	EEPROM error (Other error may be detected. If no error, automatic address is repeated.)	×	×	
P01	●	◎	◎	ALT	Indoor unit Indoor fan error	Indoor	Indoor AC fan error was detected. (Fan thermal relay worked.)	×	×	
P10	●	◎	◎	ALT	Indoor unit Overflow detection	Indoor	Float switch worked.	×	×	
P12	●	◎	◎	ALT	Indoor unit Indoor fan error	Indoor	Indoor fan error (Over-current / Lock, etc.) was detected.	×	×	
P31	◎	●	◎	ALT	Other indoor unit error	Indoor	Other indoor under condition of warning in group. E03/L07/L03/L08 warning	○	×	
—	By unit with warning No.				ALT	Error in indoor group	Network adapter	Sub remote controller error in a group (Details of remote controller are displayed with unit No. Only central control side is displayed.)	—	—
—	—					LAN system communication error	Network adapter/Center	Communication error of central control system signal * Is not displayed on the remote controller	○	○
L20	◎	○	◎	SIM	LAN system communication error	Network adapter/Center	Duplicated indoor address of central control system communication	○	×	
—	—					There are multiple communication adapters.	Network adapter	There are multiple communication adapters on remote controller communication line.	○	○

## Error mode detected by indoor unit

Operation of diagnostic function				Judgment and measures
Check code	Cause of operation	Status of air conditioner	Condition	
E03	No communication from remote controller (including wireless) and communication adapter	Stop (Automatic reset)	Displayed when error is detected	1. Check cables of remote controller and communication adapters. • Remote controller LCD display OFF (Disconnection) • Central remote controller [97] check code
E04	The serial signal is not output from outdoor unit to indoor unit. • Miswiring of inter-unit wire • Defective serial sending circuit on outdoor P.C. board • Defective serial receiving circuit on indoor P.C. board	Stop (Automatic reset)	Displayed when error is detected	1. Outdoor unit does not completely operate. • Inter-unit wire check, correction of miswiring • Check outdoor P.C. board. Correct wiring of P.C. board. 2. When outdoor unit normally operates Check P.C. board (Indoor receiving / Outdoor sending).
E08	Duplicated indoor unit address	Stop	Displayed when error is detected	1. Check whether remote controller connection (Group/Individual) was changed or not after power supply turned on (Finish of group construction/Address check). * If group construction and address are not normal when the power has been turned on, the mode automatically shifts to address setup mode. (Resetting of address)
L03	Duplicated indoor master unit			
L07	There is group wire in individual indoor unit.			
L08	Unset indoor group address			
L09	Unset indoor capacity	Stop	Displayed when error is detected	1. Set indoor capacity (DN=11)
L30	Abnormal input of outside interlock	Stop	Displayed when error is detected	1. Check outside devices. 2. Check indoor P.C. board.
P10	Float switch operation • Float circuit, Disconnection, Coming-off, Float switch contact error	Stop	Displayed when error is detected	1. Trouble of drain pump 2. Clogging of drain pump 3. Check float switch. 4. Check indoor P.C. board.
P12	Indoor DC fan error	Stop	Displayed when error is detected	1. Position detection error 2. Over-current protective circuit of indoor fan driving unit operated. 3. Indoor fan locked. 4. Check indoor P.C. board.
P19	4-way valve system error • After heating operation has started, indoor heat exchangers temp. is down.	Stop (Automatic reset)	Displayed when error is detected	1. Check 4-way valve. 2. Check 2-way valve and check valve. 3. Check indoor heat exchanger (TC/TCJ). 4. Check indoor P.C. board.
P31	Own unit stops while warning is output to other indoor units.	Stop (Follower unit) (Automatic reset)	Displayed when error is detected	1. Judge follower unit while master unit is [E03], [L03], [L07] or [L08]. 2. Check indoor P.C. board.
F01	Coming-off, disconnection or short of indoor heat exchanger temp. sensor (TCJ)	Stop (Automatic reset)	Displayed when error is detected	1. Check indoor heat exchanger temp. sensor (TCJ). 2. Check indoor P.C. board.
F02	Coming-off, disconnection or short of indoor heat exchanger temp. sensor (TC)	Stop (Automatic reset)	Displayed when error is detected	1. Check indoor heat exchanger temp. sensor (TC). 2. Check indoor P.C. board.
F10	Coming-off, disconnection or short of indoor heat exchanger temp. sensor (TA)	Stop (Automatic reset)	Displayed when error is detected	1. Check indoor heat exchanger temp. sensor (TA). 2. Check indoor P.C. board.
F29	Indoor EEPROM error • EEPROM access error	Stop (Automatic reset)	Displayed when error is detected	1. Check indoor EEPROM. (including socket insertion) 2. Check indoor P.C. board.
E10	Communication error between indoor MCU • Communication error between fan driving MCU and main MCU	Stop (Automatic reset)	Displayed when error is detected	1. Check indoor P.C. board.
E18	Regular communication error between indoor master and follower units and between main and sub units	Stop (Automatic reset)	Displayed when error is detected	1. Check remote controller wiring. 2. Check indoor power supply wiring. 3. Check indoor P.C. board.

## Error mode detected by outdoor unit

The check code has been ramified from **4** series and after.

The ramified check code is displayed only when both the indoor unit and the outdoor unit are **4** series and after.  
(Ex. Combination of RAV-SM1404UT-E with RAV-SM2804AT8-E)

When the indoor unit is 3 series and before, the conventional check code is displayed.

(Ex. Combination of RAV-SM1402CT-E and RAV-SM2804AT8-E: Outdoor unit only is **4** series.)

Check code		Operation of diagnostic function			Judgment and measures
Indoor unit		Cause of operation	Status of air conditioner	Condition	
before 3 series	after 4 series				
F04	F04				
F06	F06	Disconnection, short of outdoor temp. sensor (TE)	Stop	Displayed when error is detected	1. Check temp. sensor (TE). 2. Check outdoor P.C. board (MCC-1599).
	F07	Disconnection, short of outdoor temp. sensor (TL)	Stop	Displayed when error is detected	1. Check temp. sensor (TL). 2. Check outdoor P.C. board (MCC-1599).
	F12	Disconnection, short of suction temp. sensor (TS)	Stop	Displayed when error is detected	1. Check suction temp. sensor (TS). 2. Check outdoor P.C. board (MCC-1599).
	F15	Miss-mounting of outdoor temp. sensor (TE, TS)	Stop	Displayed when error is detected	1. Check temp. sensor (TE, TS). 2. Check outdoor P.C. board (MCC-1599).
F08	F08	Disconnection, short of outside temp. sensor (TO)	Continue	Displayed when error is detected	1. Check outside temp. sensor (TO). 2. Check outdoor P.C. board (MCC-1599).
L29	F13	Disconnection, short of heat sink temp. sensor (TH)	Stop	Displayed when error is detected	1. Check outdoor P.C. board (MCC-1599). (Q201 is incorporated in TH sensor.)
	F31	Outdoor P.C. EEPROM error	Stop	Displayed when error is detected	1. Check outdoor P.C. board (MCC-1599).
	L10	Unset jumper of service P.C. board	Stop	Displayed when error is detected	1. Outdoor service P.C. board Check model type setting jumper wire.
	L29	Communication error between outdoor P.C. board MCU	Stop	Displayed when error is detected	1. Check outdoor P.C. board (MCC-1596, MCC-1597, MCC-1599). 2. Connection check between CN802 of MCC-1599 and CN504 of MCC-1597, and also connection check between CN505 of MCC-1597 and CN851 of MCC-1596.
	P07	Heat sink overheat error * Heat sink temp. sensor detected over specified temperature.	Stop	Displayed when error is detected	1. Check screw tightening between PC. Board and heat sink and check radiator grease (MCC-1596). 2. Check heat sink blast path.
	P15	Detection of gas leak * Discharge temp. sensor (TD), Suction temp. sensor (TS) detected temperature over specified temp.	Stop	Displayed when error is detected	1. Check gas leak, recharge 2. Check full open of service valve. 3. Check PMV (Pulse Motor Valve). 4. Check broken pipe. 5. Check discharge temp. sensor (TD), suction temp. sensor (TS).
	P19	4-way valve inverse error * After heating operation has started, indoor heat exchanger temp. lowers under the specified temp. * After heating operation has started, outdoor heat exchanger / suction temp. rises over the specified temp.	Stop	Displayed when error is detected	1. Check operation of 4-way valve. 2. Check outdoor heat exchanger (TE), suction temp. sensor (TS). 3. Check indoor heat exchanger sensor (TC). 4. Check 4-way valve coil. 5. Check PMV (Pulse Motor Valve).
H01	H01	Compressor break down * Although operation has started, operation frequency decreases and operation stops.	Stop	Displayed when error is detected	1. Check power supply voltage. (AC342 to 457V) 2. Overload operation of refrigerating cycle
H02	H02	Compressor lock * Over-current detection after compressor start-up	Stop	Displayed when error is detected	1. Trouble of compressor (Lock, etc.): Replace compressor. 2. Wiring error of compressor (Open phase)



Operation of diagnostic function					Judgment and measures
Check code		Cause of operation	Status of air conditioner	Condition	
Indoor unit					
before 3 series	after 4 series				
H03	H03	Current detection circuit error	Stop	Displayed when error is detected	1. Check outdoor P.C. board (MCC-1596). (AC current detection circuit)
	P05	Open phase of 3-phase power supply	Stop	Displayed when error is detected	1. Check open phase of 3-phase power supply. 2. Black lead wire to be connected to CN03 of MCC-1596 does not pass through T611.
H06	F23	Ps sensor error	Stop	Displayed when error is detected	1. Check connection of Ps sensor connector. 2. Check failure of Ps sensor. 3. Check compressing power error of compressor. 4. Check 4-way valve error. 5. Check outdoor P.C. board error.
	H06	Low pressure protective operation	Stop	Displayed when error is detected	1. Check service valves are fully opened. (Gas side, Liquid side) 2. Check clogging of outdoor PMV. (PMV1, 2) 3. Check SV2 circuit. 4. Check Ps sensor error. 5. Check clogging of indoor filter. 6. Check clogging of refrigerant pipe. 7. Check of outdoor fan operation. (In heating mode) 8. Check short of refrigerant.
P03	P03	Discharge temp. error * Discharge temp. (TD) over specified value was detected.	Stop	Displayed when error is detected	1. Check refrigerating cycle (Gas leak) 2. Trouble of electronic expansion valve 3. Check discharge temp. sensor (TD).
P04	H04	Case thermostat operation * Abnormal overheat of compressor	Stop	Displayed when error is detected	1. Check case thermostat and connector. 2. Check gas leak, recharge 3. Check full open of service valve. 4. Check PMV (Pulse Motor Valve). 5. Check broken pipe.
	P04	High pressure SW system error	Stop	Displayed when error is detected	1. Check service valves are fully opened. (Gas side, Liquid side) 2. Check of outdoor fan operation. 3. Check motor error of outdoor fan. 4. Check clogging of outdoor PMV. (PMV1, 2) 5. Check clogging of heat exchanger in indoor/outdoor units. 6. Short-circuit status of suction/discharge air in outdoor unit. 7. Check outdoor P.C. board error. 8. Check fan system error (Cause of air volume drop) at indoor side. 9. Check PMV opening status in indoor unit.
	P05	Power supply voltage error	Stop	Displayed when error is detected	1. Check power supply voltage. AC342 to 457V
	P20	High pressure protective operation • During cooling operation, outdoor temp. sensor (TL) detected temperature over specified temp. • During heating operation, indoor temp. sensor (TC, TCJ) detected temperature over specified temp.	Stop	Displayed when error is detected	1. Check outdoor heat exchanger sensor (TL). 2. Check indoor heat exchanger sensor (TC, TCJ). 3. Check full open of service valve. 4. Check indoor/outdoor fan. 5. Check PMV (Pulse Motor Valve). 6. Check clogging and short circuit of indoor/outdoor heat exchanger. 7. Overcharge of refrigerant. Recharge
P22	P22	Outdoor fan system error	Stop	Displayed when error is detected	1. Check lock of fan motor. 2. Check power supply voltage between L2 and N. AC198 to 264V 3. Check outdoor P.C. board.
P26	P26	Short-circuit error of compressor driving element	Stop	Displayed when error is detected	1. When performing operation while taking-off compressor wire, P26 error occurs. Check control P.C. board (MCC-1596). 2. When performing operation while taking-off compressor wire, an error does not occur. (Compressor rare short)
P29	P29	Position detection circuit error	Stop	Displayed when error is detected	1. Check control P.C. board (MCC-1596).

## Error mode detected by remote controller or central controller (TCC-LINK)

Operation of diagnostic function				Judgment and measures
Check code	Cause of operation	Status of air conditioner	Condition	
Not displayed at all (Operation on remote controller is impossible.)	No communication with master indoor unit <ul style="list-style-type: none"> <li>Remote controller wiring is not correct.</li> <li>Power of indoor unit is not turned on.</li> <li>Automatic address cannot be completed.</li> </ul>	Stop	—	Power supply error of remote controller, Indoor EEPROM error <ol style="list-style-type: none"> <li>Check remote controller inter-unit wiring.</li> <li>Check remote controller.</li> <li>Check indoor power wiring.</li> <li>Check indoor P.C. board.</li> <li>Check indoor EEPROM. (including socket insertion) → Automatic address repeating phenomenon generates.</li> </ol>
E01 *2	No communication with master indoor unit <ul style="list-style-type: none"> <li>Disconnection of inter-unit wire between remote controller and master indoor unit (Detected by remote controller side)</li> </ul>	Stop (Automatic reset) * If center exists, operation continues.	Displayed when error is detected	Receiving error from remote controller <ol style="list-style-type: none"> <li>Check remote controller inter-unit wiring.</li> <li>Check remote controller.</li> <li>Check indoor power wiring.</li> <li>Check indoor P.C. board.</li> </ol>
E02	Signal send error to indoor unit (Detected by remote controller side)	Stop (Automatic reset) * If center exists, operation continues.	Displayed when error is detected	Sending error of remote controller <ol style="list-style-type: none"> <li>Check sending circuit inside of remote controller. → Replace remote controller.</li> </ol>
E09	There are multiple main remote controllers. (Detected by remote controller side)	Stop (Sub unit continues operation.)	Displayed when error is detected	<ol style="list-style-type: none"> <li>In 2-remote controllers (including wireless), there are multiple main units. Check that there are 1 main remote controller and other sub remote controllers.</li> </ol>
L20 ----- Central controller L20	Duplicated indoor central addresses on communication of central control system (Detected by indoor/central controller side)	Stop (Automatic reset)	Displayed when error is detected	<ol style="list-style-type: none"> <li>Check setting of central control system network address. (Network adapter SW01)</li> <li>Check network adapter P.C. board.</li> </ol>
— *3 ----- Central controller (Send) C05 (Receive) C06	Communication circuit error of central control system (Detected by central controller side)	Continues (By remote controller)	Displayed when error is detected	<ol style="list-style-type: none"> <li>Check communication wire / miswiring</li> <li>Check communication (U3, U4 terminals)</li> <li>Check network adapter P.C. board.</li> <li>Check central controller (such as central control remote controller, etc.)</li> <li>Check terminal resistance. (TCC-LINK)</li> </ol>
— ----- Central controller P30	Indoor Gr sub unit error (Detected by central controller side)	Continuation/Stop (According to each case)	Displayed when error is detected	Check the check code of the corresponding unit from remote controller.

\*2 The check code cannot be displayed by the wired remote controller.  
(Usual operation of air conditioner becomes unavailable.)

For the wireless models, an error is notified with indication lamp.

\*3 This trouble is related to communication of remote controller (A, B), central system (TCC-LINK U3, U4), and [E01], [E02], [E03], [E09] or [E18] is displayed or no check display on the remote controller according to the contents.

### 8-2-5. Diagnostic Procedure for Each Check Code (Outdoor Unit)

- 1) This section describes the diagnostic method for each check code displayed on the remote controller.
- 2) In some cases, a check code indicates multiple symptoms.  
In this case, confirm LED display on the outdoor P.C. board to narrow the contents to be confirmed.
- 3) The check code on the remote controller is displayed only when the same error occurred continuously by multiple times while LED of the outdoor P.C. board displays even an error which occurred once.  
Therefore the display on the remote controller may differ from that of LED.

#### LED display on outdoor P.C. board

#### Dip switch setup

- When turning on 1) only of SW803, the latest error is displayed. As the memory is stored, it can be confirmed even if the power supply is turned off once. (excluding outside temp. sensor (TO) error)
- When the work finished or the outdoor temp. sensor (TO) error was found, turn off all of SW803. (The error which occurs at present is displayed.)

**<Latest error display>**  
Only 1) of SW803 is ON.



**<Error display, which occurs at present>**  
All SW803 are OFF. (Initial status)

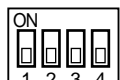

---

#### Display selection

<ul style="list-style-type: none"> <li>• When even a LED of D800 to D804 (Yellow) goes on, error occurrence is indicated. <b>&lt;Display 1&gt;</b></li> <li>• If pushing the button switch SW800 for 1 second under the above condition, the yellow LED is displayed with flashing. <b>&lt;Display 2&gt;</b></li> <li>• When pushing SW800 for 1 second again, the status returns to <b>&lt;Display 1&gt;</b>.</li> <li>• The error contents can be confirmed by combining <b>&lt;Display 1&gt;</b> and <b>&lt;Display 2&gt;</b>.</li> </ul>	<table border="0" style="width: 100%;"> <tr> <td style="width: 30%;"></td> <td style="text-align: center;"><b>&lt;Display 1&gt;</b></td> <td style="text-align: center;">↔</td> <td style="text-align: center;"><b>&lt;Display 2&gt;</b></td> </tr> <tr> <td></td> <td style="text-align: center;">(No error)</td> <td style="text-align: center;">(Error occurred)</td> <td style="text-align: center;">(Push SW800)</td> </tr> <tr> <td>D805 (Green)</td> <td style="text-align: center;">○</td> <td style="text-align: center;">○</td> <td style="text-align: center;">○</td> </tr> <tr> <td>D804 (Yellow)</td> <td style="text-align: center;">●</td> <td style="text-align: center;">○</td> <td style="text-align: center;">●</td> </tr> <tr> <td>D803 (Yellow)</td> <td style="text-align: center;">●</td> <td style="text-align: center;">●</td> <td style="text-align: center;">●</td> </tr> <tr> <td>D802 (Yellow)</td> <td style="text-align: center;">●</td> <td style="text-align: center;">●</td> <td style="text-align: center;">◎</td> </tr> <tr> <td>D801 (Yellow)</td> <td style="text-align: center;">●</td> <td style="text-align: center;">○</td> <td style="text-align: center;">●</td> </tr> <tr> <td>D800 (Yellow)</td> <td style="text-align: center;">●</td> <td style="text-align: center;">○</td> <td style="text-align: center;">●</td> </tr> </table> <p style="font-size: small;">(Example of discharge temp. sensor error) ● : Go off, ○ : Go on, ◎ : Flash</p>		<b>&lt;Display 1&gt;</b>	↔	<b>&lt;Display 2&gt;</b>		(No error)	(Error occurred)	(Push SW800)	D805 (Green)	○	○	○	D804 (Yellow)	●	○	●	D803 (Yellow)	●	●	●	D802 (Yellow)	●	●	◎	D801 (Yellow)	●	○	●	D800 (Yellow)	●	○	●
	<b>&lt;Display 1&gt;</b>	↔	<b>&lt;Display 2&gt;</b>																														
	(No error)	(Error occurred)	(Push SW800)																														
D805 (Green)	○	○	○																														
D804 (Yellow)	●	○	●																														
D803 (Yellow)	●	●	●																														
D802 (Yellow)	●	●	◎																														
D801 (Yellow)	●	○	●																														
D800 (Yellow)	●	○	●																														

Check code	Outdoor LED display	Check and troubleshooting (Item without special mention Indicates part of outdoor unit.)
[E04]	—	<p><b>[Indoor/Outdoor communication error]</b></p> <pre> graph TD     Q1{{Is setting of group address of remote controller correct?}} -- NO --&gt; A1[Check Item code [14].]     Q1 -- YES --&gt; Q2{{Are inner wiring and inter-unit cables (1, 2, 3) normal?}}     Q2 -- NO --&gt; A2[Correct wiring and inter-unit cable.]     Q2 -- YES --&gt; Q3{{Are connection of CN01 of MCC-1599 and wiring of terminal blocks (1, 2, 3) normal?}}     Q3 -- NO --&gt; A3[Correct wiring of connectors and terminal blocks.]     Q3 -- YES --&gt; Q4{{Does D502 (Orange LED) flash after power supply is turned on again?}}     Q4 -- NO --&gt; A4[Check indoor P.C. board. Defect → Replace]     Q4 -- YES --&gt; A5[Check outdoor P.C. board (MCC-1599). Defect → Replace]                     </pre>

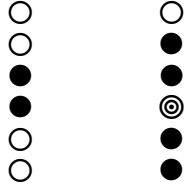
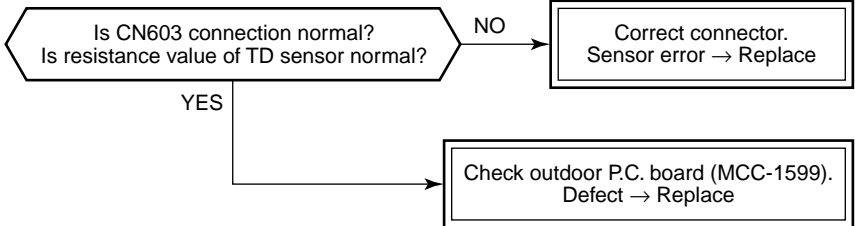
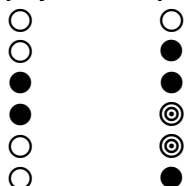
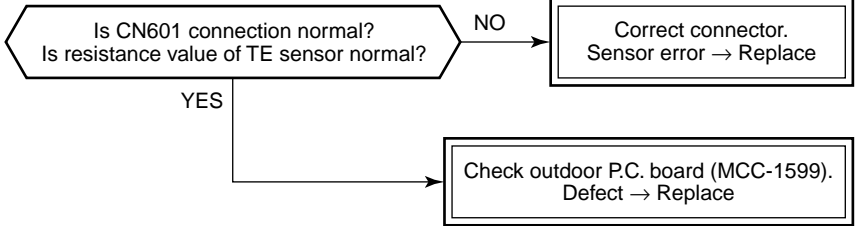
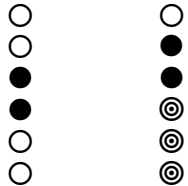
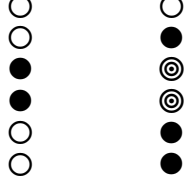
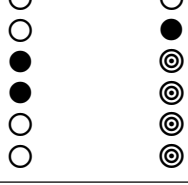
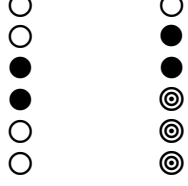
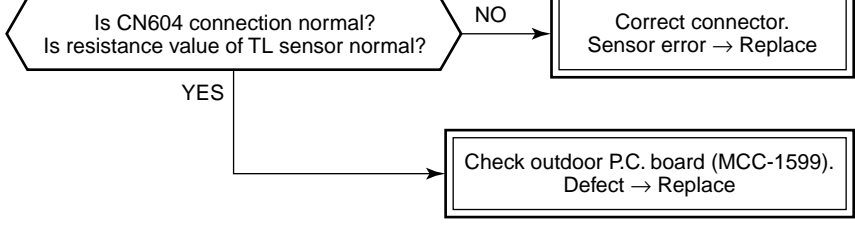
Check code	Outdoor LED display	Check and troubleshooting (Item without special mention Indicates part of outdoor unit.)
[F04]	<Display 1>   <Display 2> 	<b>[Discharge temp. sensor (TD) error]</b> 
[F06]	<Display 1>   <Display 2> 	<ul style="list-style-type: none"> <li>• There is a possibility that it is one of the following errors. Confirm LED on outdoor P.C. board to judge which error it is. Heat exchanger temp. sensor (TE) error, Heat exchanger temp. sensor (TL) error, Suction temp. sensor (TS) error, Miswiring of heat exchanger sensor (TE, TS)</li> </ul> <b>Heat exchanger temp. sensor (TE) error]</b>  <b>[Heat exchanger temp. sensor (TL) error] → Refer to [F07] column.</b>  <b>[Suction temp. sensor (TS) error] → Refer to [F12] column.</b>  <b>[Miswiring of heat exchanger sensor (TE, TS)] → Refer to [F15] column.</b> 
[F07]	<Display 1>   <Display 2> 	<b>[Heat exchanger temp. sensor (TL) error]</b> 

Check code	Outdoor LED display	Check and troubleshooting (Item without special mention Indicates part of outdoor unit.)
[F08]	<Display 1>   <Display 2> ○   ○ ○   ● ●   ◎ ●   ● ○   ● ○   ●	<b>[Outside air temp. sensor (TO) error]</b>  <pre> graph TD     Q1{{"Is CN602 connection normal? Is resistance value of TO sensor normal?"}}     Q1 -- NO --&gt; A1[Correct connector. Sensor error -&gt; Replace]     Q1 -- YES --&gt; A2[Check outdoor P.C. board (MCC-1599). Defect -&gt; Replace]           </pre>
[F12]	<Display 1>   <Display 2> ○   ○ ○   ● ●   ◎ ●   ◎ ○   ● ○   ●	<b>[Suction temp. sensor (TS) error]</b>  <pre> graph TD     Q2{{"Is CN600 connection normal? Is resistance value of TS sensor normal?"}}     Q2 -- NO --&gt; A3[Correct connector. Sensor error -&gt; Replace]     Q2 -- YES --&gt; A4[Check outdoor P.C. board (MCC-1599). Defect -&gt; Replace]           </pre>
[F13]	<Display 1>   <Display 2> ○   ○ ○   ● ●   ◎ ●   ◎ ○   ● ○   ◎	<b>[Heat sink temp. sensor (TH) error]</b>  <div style="border: 1px solid black; padding: 5px; width: fit-content; margin: 0 auto;">             Check outdoor P.C. board (MCC-1599). Defect → Replace           </div>
[F15]	<Display 1>   <Display 2> ○   ○ ○   ● ●   ◎ ●   ◎ ○   ◎ ○   ◎	<b>[Miswiring of heat exchanger sensor (TE, TS)]</b>  <pre> graph TD     Q3{{"Is mounting status of TE and TS sensors normal?"}}     Q3 -- NO --&gt; A5[Correct sensor mounting.]     Q3 -- YES --&gt; Q4{{"Is CN600 connection normal? Is resistance value of TS sensor normal?"}}     Q4 -- NO --&gt; A6[Correct connector. Sensor error -&gt; Replace]     Q4 -- YES --&gt; Q5{{"Is CN601 connection normal? Is resistance value of TE sensor normal?"}}     Q5 -- NO --&gt; A7[Correct connector. Sensor error -&gt; Replace]     Q5 -- YES --&gt; A8[Check outdoor P.C. board (MCC-1599). Defect -&gt; Replace]           </pre>

Check code	Outdoor LED display	Check and troubleshooting (Item without special mention Indicates part of outdoor unit.)
[F23]	<Display 1>   <Display 2> ○   ○ ○   ◎ ●   ● ●   ◎ ○   ◎ ○   ◎	<b>[PS sensor error]</b> <pre> graph TD     Q1{{Is connector of Ps sensor correctly connected?}} -- NO --&gt; A1[Correct connection of connector.]     Q1 -- YES --&gt; Q2{{Are the output current characteristics of Ps sensor normal?}}     Q2 -- NO --&gt; A2[Sensor error]     Q2 -- YES --&gt; Q3{{Does not refrigerant bypass from discharge port to suction port of 4-way valve?}}     Q3 -- NO --&gt; A3[Check compressor.]     Q3 -- YES --&gt; A4[Check 4-way valve.]           </pre> <p>Connector: CN606, White</p> <p>* ① Pressure by pressure gauge (Check joint)          ② Pressure display on LED display          ③ Output power of I/F (CDB) P.C. board          If ① and ②, ① and ③ are different, an error of the pressure sensor is considered.          If ② and ③ are different, check I/F P.C. board.</p>
[F31]	<Display 1>   <Display 2> ○   ○ ○   ◎ ●   ◎ ●   ◎ ○   ◎ ○   ◎	<b>[EEPROM error]</b> <div style="border: 1px solid black; padding: 5px; width: fit-content; margin: 0 auto;">             Check outdoor P.C. board (MCC-1599).              Defect → Replace           </div>
[H01]	<Display 1>   <Display 2> ○   ○ ○   ● ●   ● ○   ● ●   ● ●   ◎	<b>[Compressor break down]</b> <pre> graph TD     Q1{{Is power supply voltage normal? AC342 to 457V}} -- NO --&gt; A1[Correct power supply line.]     Q1 -- YES --&gt; Q2{{Is wire connection normal? Compressor lead (Board side, Compressor side), Reactor lead, Power supply lead}}     Q2 -- NO --&gt; A2[Check wire connection and correct it.]     Q2 -- YES --&gt; Q3{{Is it not abnormal overload?}}     Q3 -- YES --&gt; A3[Correct and clear the cause.]     Q3 -- NO --&gt; A4[Check outdoor P.C. board (MCC-1596). Defect → Replace]           </pre>

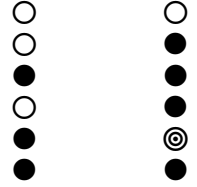
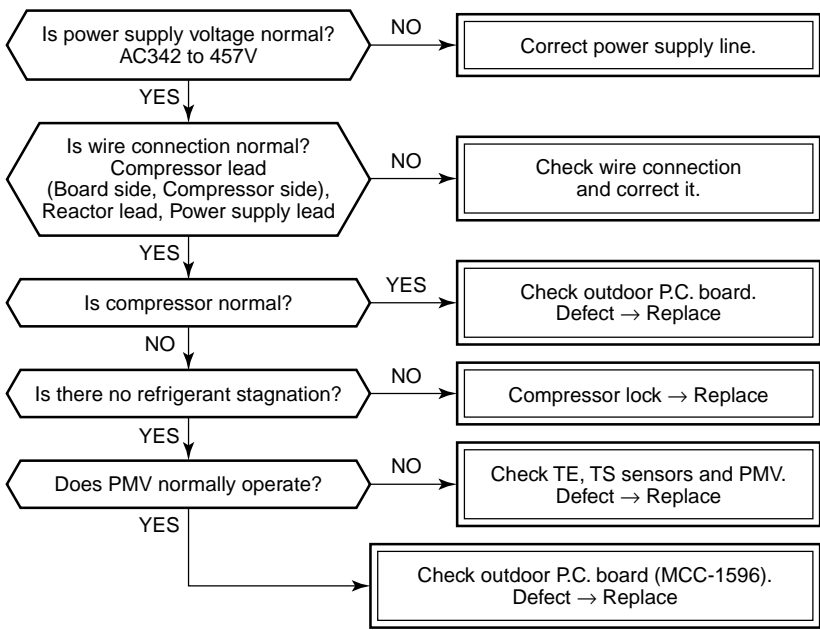
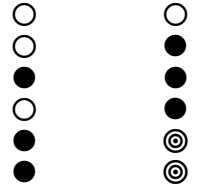
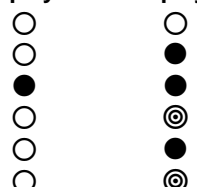
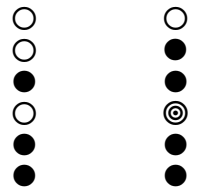
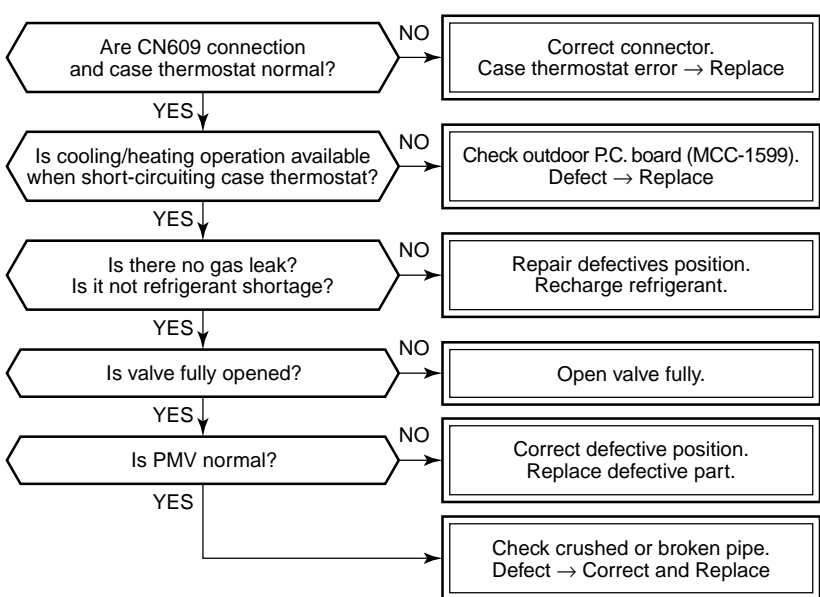
Check code	Outdoor LED display	Check and troubleshooting (Item without special mention Indicates part of outdoor unit.)
[H02]	<Display 1>   <Display 2> 	<b>[Compressor lock]</b> 
[H03]	<Display 1>   <Display 2>   <Display 1>   <Display 2> 	<b>[Current detection circuit error]</b> <div style="border: 1px solid black; padding: 5px; width: fit-content; margin: 10px auto;">       Check outdoor P.C. board (MCC-1596).        Defect → Replace     </div> <b>[Power supply error (Vdc)] → Refer to [P05] column.</b>
[H04]	<Display 1>   <Display 2> 	<b>[Case thermostat operation]</b> 

Check code	Outdoor LED display	Check and troubleshooting (Item without special mention Indicates part of outdoor unit.)
[H06]	<Display 1>   <Display 2> ○   ○ ○   ● ●   ● ○   ◎ ●   ◎ ●   ●	<p><b>[Low pressure protective operation]</b></p> <p><b>(A) Cooling</b></p> <p>Does cooling indoor fan normally operate?    YES → Is there clogging of indoor filter or heat exchanger?    YES → Cleaning    NO → Refrigerant shortage, clogging or pipe breakage is considered.</p> <p>Does cooling indoor fan normally operate?    NO → Are parts related to the indoor fan motor normal?    1. Connection of connector    2. Capacitor    3. Motor    4. Fan    YES → Check indoor P.C. board Defective → Replace    NO → Repair the defective position.</p> <p><b>(B) Heating</b></p> <p>Does heating outdoor fan normally operate?    YES → Is there clogging of outdoor heat exchanger?    YES → Cleaning    NO → Is outdoor PMV normal?    YES → Shortage of refrigerant/blocking/pipe breakage    NO → Are connection of connectors and coils normal?    YES → Is blocking found in entire valve?    YES → Replace PMV with new one.    NO → Is indoor fan system normal?    · Fan breakage    · Fan coming-off    YES → Check outdoor P.C. board Defective → Replace    NO → Repair the defective position.</p>
[L10]	<Display 1>   <Display 2> ○   ○ ○   ● ●   ◎ ○   ◎ ●   ●	<p><b>[Unset model type]:</b> Only when service P.C. board is used</p> <p>Cut jumper line according to the explanation sheet packaged with the service P.C. board.</p>



Check code	Outdoor LED display	Check and troubleshooting (Item without special mention Indicates part of outdoor unit.)
[L29]		<p>* There is a possibility that it is one of the following errors.            Confirm LED on outdoor P.C. board to judge which error it is.            Communication error between MCU, Heat sing temp. sensor (TH) error,            EEPROM error, Unset model type, Heat sink overhear error, Gas leak detection,            4-way valve inverse error</p>
	<p>&lt;Display 1&gt; &lt;Display 2&gt;</p> <p>○ ○            ○ ◎            ● ◎            ○ ◎            ○ ◎            ● ◎</p>	<p><b>[Communication error between MCU]</b></p> <p>1. Connection check between CN802 of MCC-1599 and CN504 of MCC-1597 and also connection check between CN505 of MCC-1597 and CN851 of MCC-1596.            2. Check outdoor P.C. board (MCC-1596, MCC-1597, MCC-1599).            Defect → Replace</p>
	<p>&lt;Display 1&gt; &lt;Display 2&gt;</p> <p>○ ○            ○ ●            ● ◎            ○ ◎            ○ ◎</p>	<p><b>[Heat sink temp. sensor (TH) error]</b> → Refer to [F13] column.</p>
	<p>&lt;Display 1&gt; &lt;Display 2&gt;</p> <p>○ ○            ○ ◎            ● ◎            ○ ◎            ○ ◎</p>	<p><b>[EEPROM error]</b> → Refer to [F31] column.</p>
	<p>&lt;Display 1&gt; &lt;Display 2&gt;</p> <p>○ ○            ○ ●            ○ ◎            ○ ◎            ● ◎</p>	<p><b>[Unset model type]</b> → Refer to [L10] column.</p>
	<p>&lt;Display 1&gt; &lt;Display 2&gt;</p> <p>○ ○            ○ ●            ○ ●            ○ ◎            ○ ◎            ○ ◎</p>	<p><b>[Heat sink overhear error]</b> → Refer to [P07] column.</p>
	<p>&lt;Display 1&gt; &lt;Display 2&gt;</p> <p>○ ○            ○ ●            ○ ◎            ○ ◎            ○ ◎            ○ ◎</p>	<p><b>[Gas leak detection]</b> → Refer to [P15] column.</p>
	<p>&lt;Display 1&gt; &lt;Display 2&gt;</p> <p>○ ○            ○ ◎            ● ◎            ○ ◎            ○ ◎            ○ ◎</p>	<p><b>[4-way valve inverse error]</b> → Refer to [P19] column.</p>

Check code	Outdoor LED display	Check and troubleshooting (Item without special mention Indicates part of outdoor unit.)
[P03]	<Display 1>   <Display 2> ○   ○ ○   ● ●   ● ○   ● ○   ◎ ○   ◎	<b>[Discharge temp. error]</b> 
[P04]	* There is a possibility that it is one of the following errors. Confirm LED on outdoor P.C. board to judge which error it is. (1) high-pressure SW system error, (2) power supply error (Vdc), (3) high-pressure protective operation, (4) case thermo operation.  <Display 1>   <Display 2> ○   ○ ○   ● ●   ● ○   ◎ ○   ● ○   ●	<b>[High pressure SW system error]</b> Power supply error (Vdc), High pressure protective operation, Case thermostat operation. 

Check code	Outdoor LED display	Check and troubleshooting (Item without special mention Indicates part of outdoor unit.)
[P04]		<pre> graph TD     Start((C)) --&gt; Heating[Heating operation]     Heating --&gt; Fan{Does the heating indoor fan normally operate?}     Fan -- YES --&gt; HeatEx[Is there any element which blocks indoor heat exchanger? ① Filter clogging ② Clogging of heat exchanger ③ Short circuit]     Fan -- NO --&gt; Conn{Are connections of connectors, capacitors and fan motor normal?}     HeatEx -- YES --&gt; Elim[Elimination of blocking element]     HeatEx -- NO --&gt; Clog[Clogging by refrigerant overcharge/Pipe breakage/Abnormal overload]     Conn -- YES --&gt; Sensor{Are characteristics of TC and TCJ sensor resistance value normal?}     Conn -- NO --&gt; Repair[Repair defective position.]     Sensor -- YES --&gt; PCB[Check indoor P.C. board Defective -&gt; Replace]     Sensor -- NO --&gt; Replace[Replace TC or TCJ sensor.]     Clog --&gt; Sensor   </pre>
	<p>&lt;Display 1&gt;   &lt;Display 2&gt;</p> <p>○   ○</p> <p>○   ●</p> <p>●   ●</p> <p>○   ⊙</p> <p>●   ●</p> <p>●   ●</p>	[Case thermostat operation] → Refer to [H04] column.
	<p>&lt;Display 1&gt;   &lt;Display 2&gt;</p> <p>○   ○</p> <p>○   ●</p> <p>●   ●</p> <p>○   ⊙</p> <p>○   ●</p> <p>○   ⊙</p>	[Power supply error (Vdc)] → Refer to [P05] column.
	<p>&lt;Display 1&gt;   &lt;Display 2&gt;</p> <p>○   ○</p> <p>●   ⊙</p> <p>○   ●</p> <p>○   ⊙</p> <p>○   ●</p> <p>○   ●</p>	[High pressure protective operation] → Refer to [P20] column.

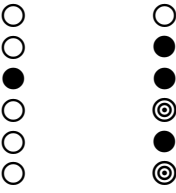
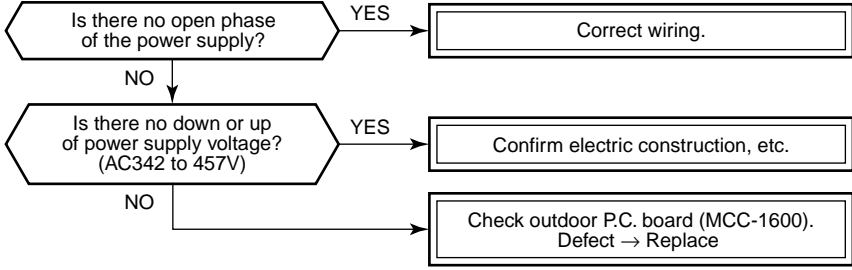
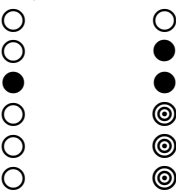
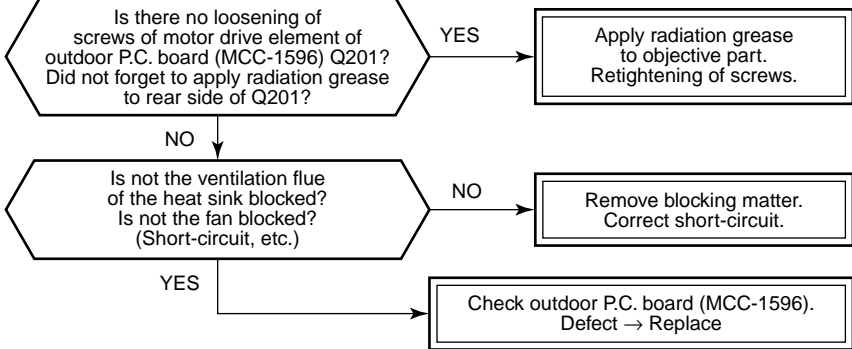
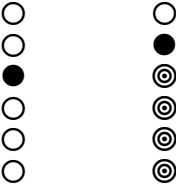
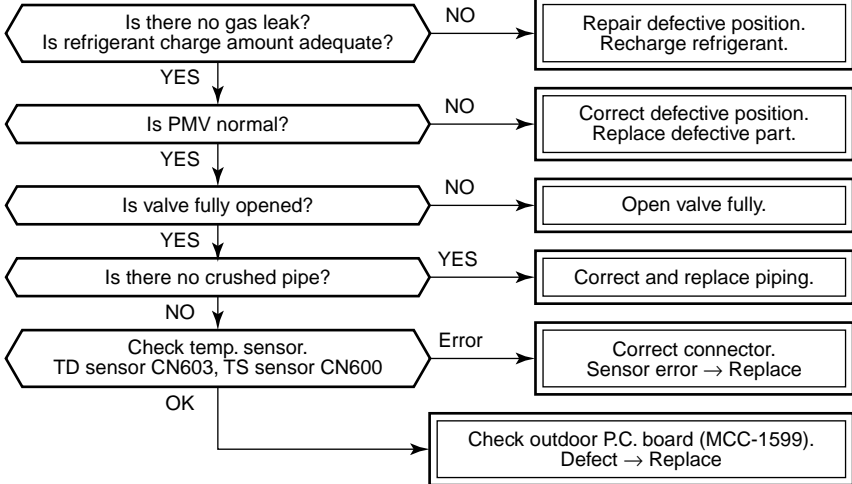
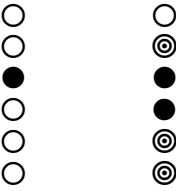
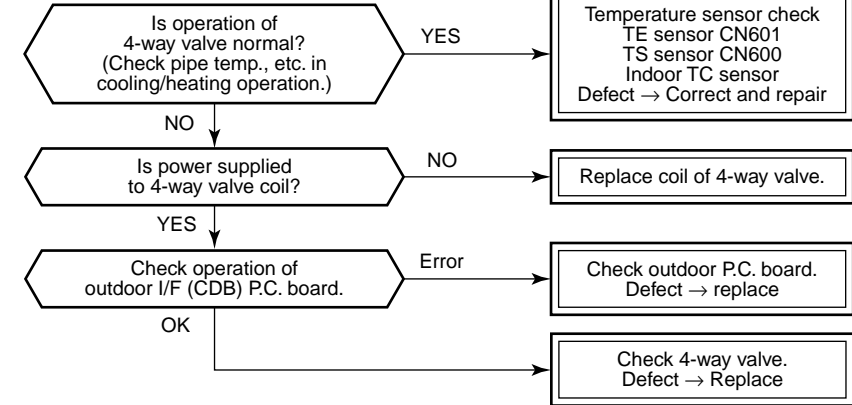
Check code	Outdoor LED display	Check and troubleshooting (Item without special mention Indicates part of outdoor unit.)
[P05]	<Display 1>   <Display 2> 	<b>[Power supply error (Voltage error)]</b> 
[P07]	<Display 1>   <Display 2> 	<b>[Heat sink overheat error]</b> 
[P15]	<Display 1>   <Display 2> 	<b>[Gas leak detection]</b> 
[P19]	<Display 1>   <Display 2> 	<b>[4-way valve inverse error]</b> 

Check code	Outdoor LED display	Check and troubleshooting (Item without special mention Indicates part of outdoor unit.)
[P20]	<Display 1>   <Display 2> ○   ○ ○   ◎ ●   ● ○   ◎ ○   ● ○   ●	<p><b>[High pressure protective operation]</b></p> <pre> graph TD     Q1{{Is valve fully opened?}} -- NO --&gt; A1[Open valve fully.]     Q1 -- YES --&gt; B1[Reset the power supply and then perform test run matching to the season.]     B1 --&gt; C1[Is there no problem on outdoor TL sensor? Measurement of resistance value]     C1 -- NO --&gt; A2[Replace sensor.]     C1 -- YES --&gt; Q2{{Is there no crack or loosening of outdoor fan?}}     Q2 -- NO --&gt; A3[Check outdoor fan. Defect -&gt; Replace, retightening]     Q2 -- YES --&gt; Q3{{Does not the outdoor fan perform abnormal operation?}}     Q3 -- NO --&gt; A4[Check the same items as [P22] error.]     Q3 -- YES --&gt; Q4{{Is there no element which interfere heat exchange of outdoor unit? Clogging of heat exchanger, Short circuit}}     Q4 -- YES --&gt; A5[Eliminate interfering element.]     Q4 -- NO --&gt; A6[Check overcharge of refrigerant, clogging of cycle, broken pipe, abnormal overload, etc. Defect -&gt; Correct defective position.]     B1 --&gt; Q5{{Does indoor fan normally operate?}}     Q5 -- NO --&gt; Q6{{Are indoor fan motor and connector normal?}}     Q6 -- NO --&gt; A7[Repair defective position.]     Q6 -- YES --&gt; Q7{{Are resistance values of indoor TC and TCJ sensors normal?}}     Q7 -- NO --&gt; A8[Replace sensor.]     Q7 -- YES --&gt; A9[Check indoor P.C. board. Defect -&gt; Replace]     Q5 -- YES --&gt; Q8{{Is there no element which interfere heat exchange of indoor unit? Clogging of filter, Clogging of heat exchanger, Short circuit}}     Q8 -- YES --&gt; A10[Eliminate interfering element.]     Q8 -- NO --&gt; A11[Check overcharge of refrigerant, clogging of cycle, broken pipe, abnormal overload, etc. Defect -&gt; Correct defective position.]   </pre>

Check code	Outdoor LED display	Check and troubleshooting (Item without special mention Indicates part of outdoor unit.)
[P22]	<Display 1>   <Display 2> ○   ○ ○   ◎ ●   ● ○   ◎ ○   ◎ ○   ●	<p><b>[Fan system error]</b></p> <pre> graph TD     Q1{Is there no problem on power supply voltage? (342 to 457V)} -- NO --&gt; A1[Check wiring construction. Ask repair of power supply.]     Q1 -- YES --&gt; Q2{Does the fan rotate without trouble when rotating shaft of fan motor with hands during power-OFF? Is there no problem on coil resistance of fan motor? Between red and white lead wire : 12 to 20Ω Between white and black lead wire : 12 to 20Ω Between black and red lead wire : 12 to 20Ω}     Q2 -- YES --&gt; A2[Check outdoor P.C. board (MCC-1597). Defect → Replace]     Q2 -- NO --&gt; A3[Replace fan motor.]           </pre> <p><b>Single operation check for outdoor fan</b></p> <ol style="list-style-type: none"> <li>Set SW804 of Dip switch as the following figure and then push SW801 for approx. 1 second to check single operation of outdoor fan. Use this method to check which fan, upper or lower fan, has a trouble.             <ul style="list-style-type: none"> <li>When pushing SW801 for 1 second again or 2 minutes passed, the fan stops.</li> </ul> </li> <li>After check, turn off all Dip switch SW804.</li> </ol> <div style="border: 1px solid black; padding: 5px; width: fit-content; margin: 10px auto;"> <p style="text-align: center;"><b>Outdoor fan single operation</b></p> <div style="display: flex; justify-content: space-around; align-items: center;"> <div style="text-align: center;"> <p>SW804</p> <p>1 2 3 4</p> </div> <div style="text-align: center;"> <p>SW801</p> <p>Push</p> </div> </div> </div>
[P26]	<Display 1>   <Display 2> ○   ○ ○   ◎ ●   ◎ ○   ◎ ○   ● ○   ◎	<p><b>[Short-circuit of compressor drive element]</b></p> <pre> graph TD     Q1{Is there no problem on connection of compressor lead or reactor? (Check referring to Wiring diagram.)} -- NO --&gt; A1[Correct wiring.]     Q1 -- YES --&gt; Q2{The same error does not occur in operation without compressor lead.}     Q2 -- YES --&gt; A2[Check compressor. (Rear short, etc.) Defect → Replace]     Q2 -- NO --&gt; A3[Replace outdoor P.C. board.]           </pre>
[P29]	<Display 1>   <Display 2> ○   ○ ○   ◎ ●   ◎ ○   ◎ ○   ● ○   ◎	<p><b>[Position detection circuit error]</b></p> <div style="border: 1px solid black; padding: 5px; width: fit-content; margin: 10px auto;"> <p style="text-align: center;">Check outdoor P.C. board (MCC-1596). Defect → Replace</p> </div>
— No code	<Display 1>   <Display 2> ○   ○ ○   ◎ ●   ◎ ○   ◎ ○   ◎ ●   ◎	<p><b>[Other error]</b> Compressor disorder due to sudden change of load, etc.</p> <ul style="list-style-type: none"> <li>* Although the display of outdoor LED outputs, the unit automatically restarts and error is not determined.</li> <li>* LED display also may output due to negative phase of compressor or wire coming-off.</li> </ul>

**Temperature sensor**

**Temperature – Resistance value characteristic table**

**TA, TC, TCJ, TE, TS, TO sensors**

**TD, TL sensors**

**Representative value**

**Representative value**

Temperature (°C)	Resistance value (kΩ)		
	(Minimum value)	(Standard value)	(Maximum value)
0	32.33	33.80	35.30
10	19.63	20.35	21.09
20	12.23	12.59	12.95
25	9.75	10.00	10.25
30	7.764	7.990	8.218
40	5.013	5.192	5.375
50	3.312	3.451	3.594
60	2.236	2.343	2.454
70	1.540	1.623	1.709
80	1.082	1.146	1.213
90	0.7740	0.8237	0.8761
100	0.5634	0.6023	0.6434

Temperature (°C)	Resistance value (kΩ)		
	(Minimum value)	(Standard value)	(Maximum value)
0	150.5	161.3	172.7
10	92.76	99.05	105.6
20	58.61	62.36	66.26
25	47.01	49.93	52.97
30	37.93	40.22	42.59
40	25.12	26.55	28.03
50	17.00	17.92	18.86
60	11.74	12.34	12.95
70	8.269	8.668	9.074
80	5.925	6.195	6.470
90	4.321	4.507	4.696
100	3.205	3.336	3.468

**TA, TC, TCJ, TE, TS, TO sensors**

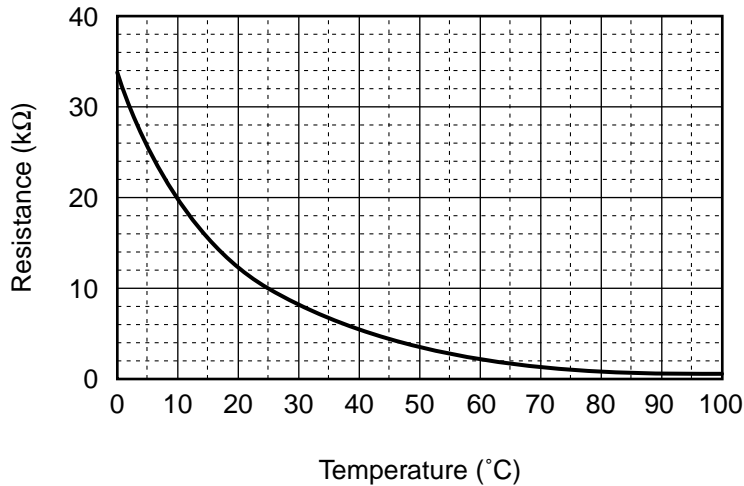

**Low pressure sensor**

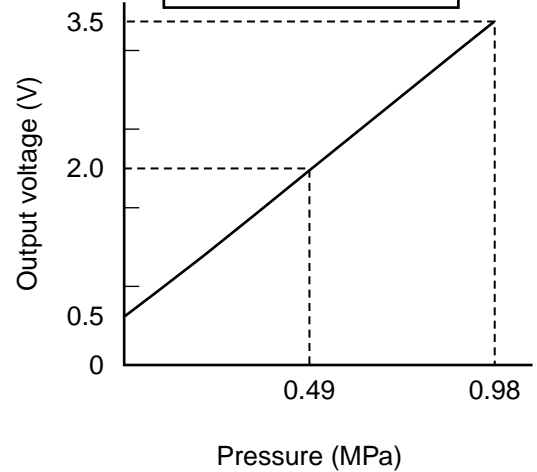

**TD, TL sensors**

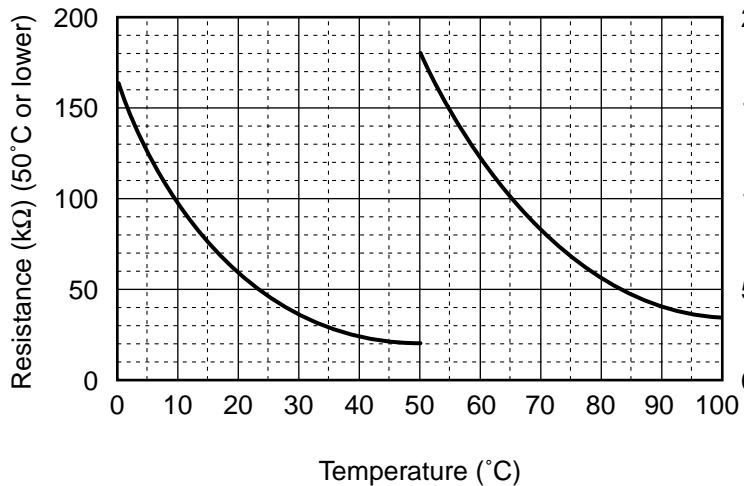

**Pressure sensor I/O wire connecting table**

Pin No.	Input/output name	Lead wire
1	—	—
2	OUTPUT	White
3	GND	Black
4	DC5V	Red

\* As TH sensor (Outdoor unit heat sink temp. sensor) is incorporated in the outdoor control P.C. board, the resistance value cannot be measured.

## 9. SETUP AT LOCAL SITE AND OTHERS

### 9-1. Calling of Error History

#### <Contents>

The error contents in the past can be called.

#### <Procedure>

- 1 Push **SET** + **TEST** buttons simultaneously for 4 seconds or more to call the service check mode.

Service Check goes on, the **CODE No. 01** is displayed, and then the content of the latest alarm is displayed. The number and error contents of the indoor unit in which an error occurred are displayed.

- 2 In order to monitor another error history, push the set temperature **▼** / **▲** buttons to change the error history No. (CODE No.).

CODE No. **01** (Latest) → CODE No. **04**(Old)

NOTE : 4 error histories are stored in memory.

- 3 Pushing **TEST** button returns the display to usual display.

#### REQUIREMENT

Do not push **CL** button, otherwise all the error histories of the indoor unit are deleted.

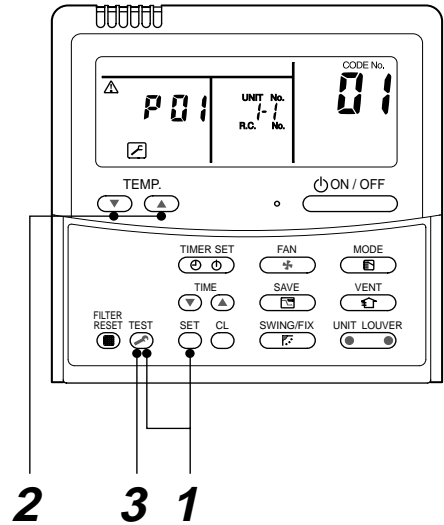

<Operation procedure>

1 → 2 → 3

Returned to usual display

### 9-2. Group Control Operation

In a group control, operation of maximum 8 indoor units can be controlled by a remote controller. The indoor unit connected with outdoor unit (Individual/Master of twin) controls room temperature according to setting on the remote controller.

#### <System example>

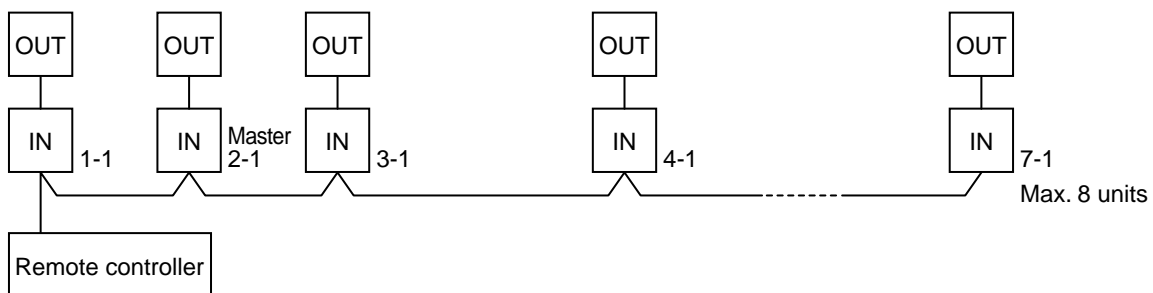

1. Display range on remote controller  
The setup range (Operation mode/Air volume select/Setup temp) of the indoor unit which was set to the master unit is reflected on the remote controller.
2. Address setup  
Turn on power of the indoor unit to be controlled in a group within 3 minutes after setting of automatic address. If power of the indoor unit is not turned on within 3 minutes (completion of automatic address setting), the system is rebooted and the automatic address setting will be judged again.
  - 1) Connect 3 In/Out cables surely.
  - 2) Check line address/indoor address/group address of the unit one by one.
  - 3) The unit No. (line/indoor gout address) which have been set once keep the present status as a rule if the unit No. is not duplicated with one of another unit.



## ■ Indoor unit power-ON sequence

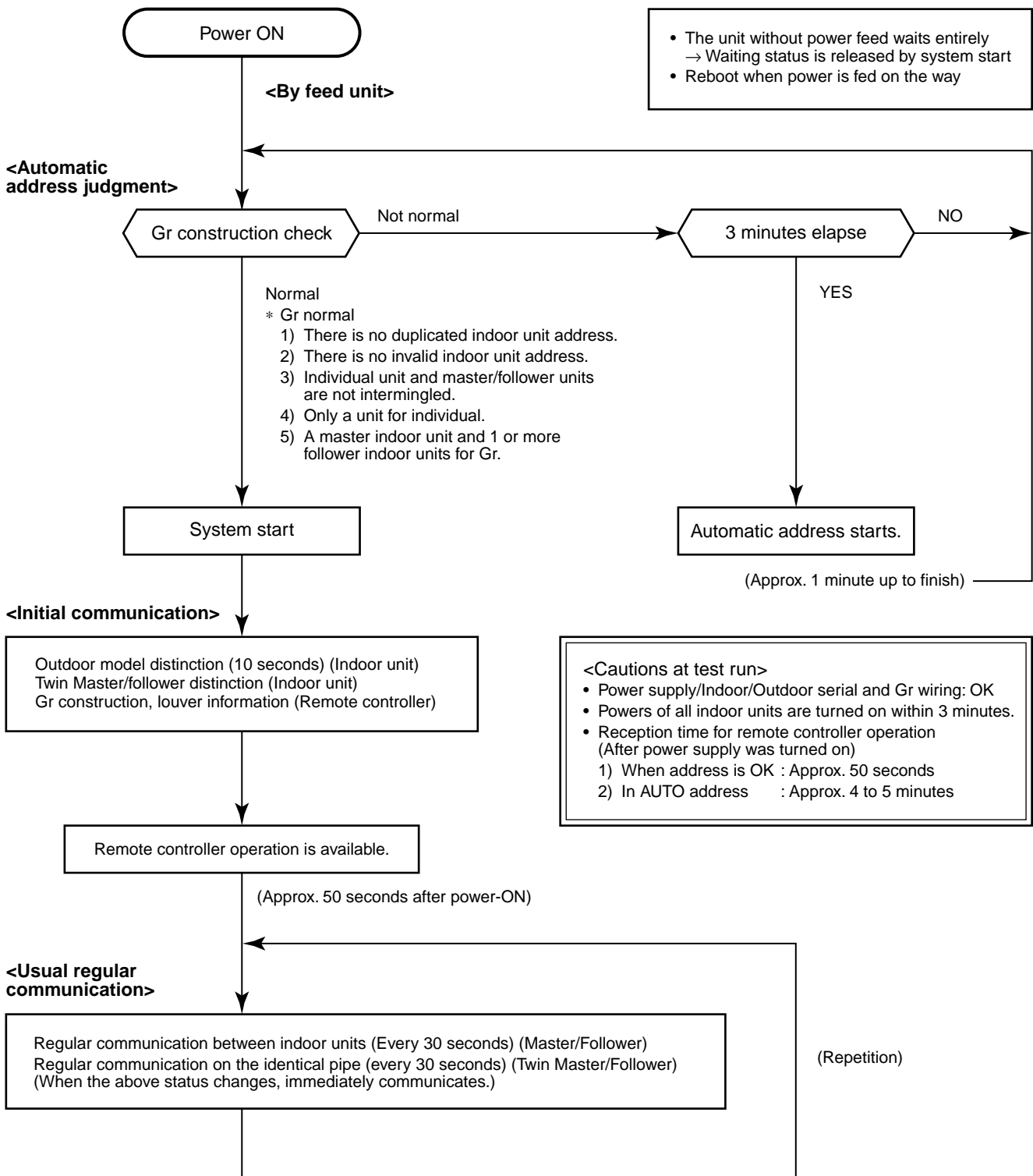

- In a group operation, if the indoor unit which was fed power after judgment of automatic address cannot receive regular communication from the master unit and regular communication on identical pipe within 120 seconds after power was turned on, it reboots (system reset).  
→ The operation starts from judgment of automatic address (Gr construction check) again.  
(If the address of the master unit was determined in the previous time, the power fed to the master unit and reboot works, the master unit may change though the indoor unit line address is not changed.)

### 9-3. Outdoor Unit

#### 9-3-1. Various Setting on Outdoor Unit (Existing piping, Power save, Cooling-only, etc.)

The following settings are available by DIP switch setup and jumper line setup.

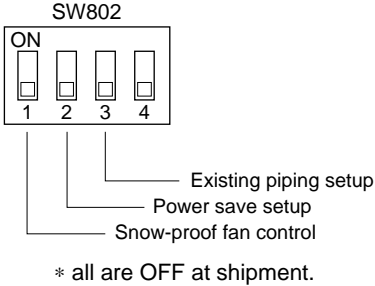
Function	Set position	Control contents																			
Existing piping setup	 <p>SW802</p> <p>ON</p> <p>1 2 3 4</p> <p>Existing piping setup</p> <p>Power save setup</p> <p>Snow-proof fan control</p> <p>* all are OFF at shipment.</p>	Turn the switch to ON when Ø19.1 is used for the existing pipe. In this case, the heating capacity may lower according to outside temp. and indoor temp. in heating operation.																			
Power save setup		Turn the switch to ON when using the power save function. The control to lower the compressor frequency (Approx. -10%) is performed by indoor heat exchanger temp. in heating operation.																			
Snow-proof fan control		When snow enters from clearance of the fan guard or heat exchanger into blast path and it is accumulated, the control to prevent generation of motor lock is validated. When outside temp. is below 0°C though the compressor stops, the outdoor fan operates with W5.																			
Defrost time change	J805, J806	The defrost interval is cut to shorten it than the standard status. For contents of control and cutting method, refer to Section 7-4. <b>Defrost control.</b>																			
Max. frequency change	J807	When it is needed to lower the maximum value of the compressor frequency, cut the jumper line. Max. frequency at cooling/heating is lowered. In this case the Max. capacity decreases. <b>Max. frequency of compressor</b>																			
		<table border="1"> <thead> <tr> <th rowspan="2">Model</th> <th colspan="2">RAV-SM224</th> <th colspan="2">RAV-SM280</th> </tr> <tr> <th>COOL</th> <th>HEAT</th> <th>COOL</th> <th>HEAT</th> </tr> </thead> <tbody> <tr> <td>Standard status</td> <td>78.0</td> <td>74.4</td> <td>91.2</td> <td>96.0</td> </tr> <tr> <td>When J807 is cut</td> <td>66.6</td> <td>66.6</td> <td>76.8</td> <td>76.8</td> </tr> </tbody> </table>	Model	RAV-SM224		RAV-SM280		COOL	HEAT	COOL	HEAT	Standard status	78.0	74.4	91.2	96.0	When J807 is cut	66.6	66.6	76.8	76.8
Model	RAV-SM224			RAV-SM280																	
	COOL	HEAT	COOL	HEAT																	
Standard status	78.0	74.4	91.2	96.0																	
When J807 is cut	66.6	66.6	76.8	76.8																	
Cooling-only setup	J808	When using the air conditioner as a cooling-only conditioner, cut the jumper line. (An air conditioner can be changed to cooling-only conditioner by "0F" of DN code on the remote controller.)																			

### 9-3-2. Service Support Function (LED Display, Switch Operation)

#### 1. Outline

A various setup and operation check can be performed by DIP switches at 3 positions (SW802, SW803, SW804) and the pushdown button switches (SW800, SW801) at 2 positions.

#### Operation part

Part No.	Specifications	Operation contents
SW800	Pushdown button switch	Exchanges the displayed contents of LED (D800 to D804) on the outdoor control P.C. board.
SW803	DIP switch	
SW801	Pushdown button switch	Performs the specific operation to check maintenance.
SW804	DIP switch	
SW802	DIP switch	Performs various initial settings. (Refer to 9-3-1.)

#### Display part

Part No.	Specifications	Operation contents
D502	Orange LED	Indoor/Outdoor communication (Serial communication) signal display (Receive signal from indoor signal)
D503	Green LED	Indoor/Outdoor communication (Serial communication) signal display (Send signal from outdoor signal)
D800 to D804	Yellow LED	Error display When all SW803 are OFF, or when any of D800 to D804 goes on, LED displays that the outdoor controller detects an error. When status of SW803 is other than OFF, various indications are displayed.
D805	Green LED	Power-ON display When the power of the outdoor unit is turned on, LED goes on. When SW801 and SW804 operate the specific operation, LED flashes.

\* All LED are colorless when it goes off.

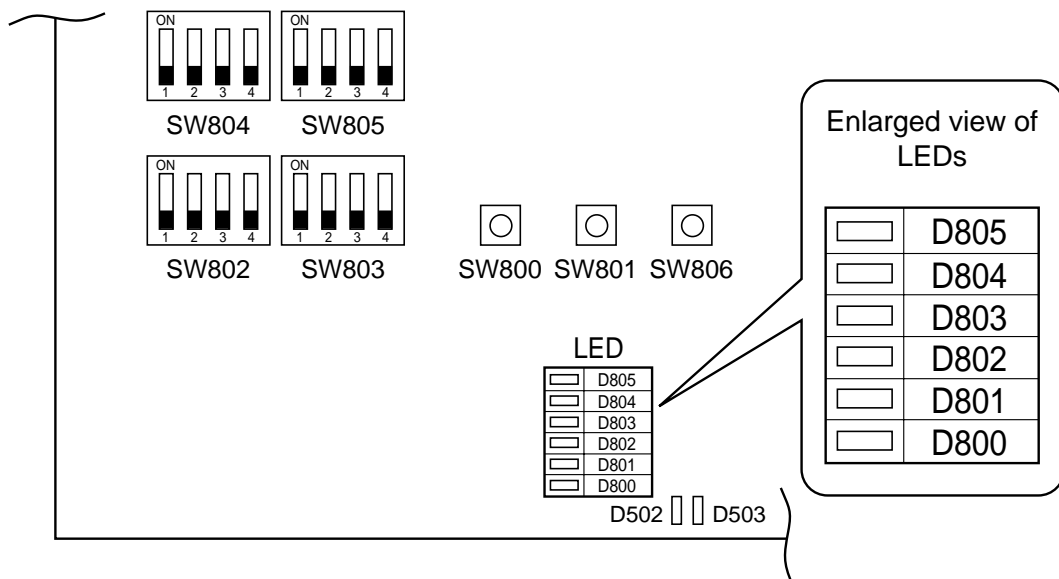





### 9-3-3. Others

#### 1. Selection of LED display (SW800, SW803 operation)

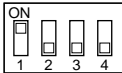
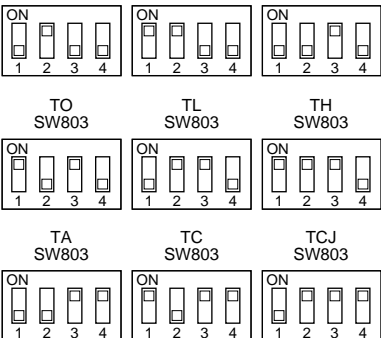
##### 1) Display selection list

The displayed contents of LED D800 to D804 on the outdoor control P.C. board can be exchanged by operation of SW803.

Switch	Function / Contents	Refer
<p>SW803</p> 	<p>Error display (Error generating at present)            Error generating at present is displayed.            This switch goes off when an error does not generate.</p>	Refer to 2)
<p>SW803</p> 	<p>Error display (The latest error: Latest error including present)            After error status was cleared, the error which generated before can be confirmed by this setting. (Reconfirmation is available even if power supply was turned off once.)</p> <ul style="list-style-type: none"> <li>• If an error generates at present, the same contents as those of error which is generating at present are displayed.</li> <li>• Only error of TO sensor is not displayed by this setting. (Confirm it by setting of error which is generating at present.)</li> </ul>	Refer to 2)
<p>TD SW803    TE SW803    TS SW803</p>  <p>TO SW803    TL SW803    TH SW803</p> <p>TA SW803    TC SW803    TCJ SW803</p>	<p>Temperature sensor display            The detected value of temperature sensor is displayed.</p>	Refer to 3)
<p>SW803</p> 	<p>Current display            The current value which flows in the outdoor unit is displayed.</p>	Refer to 3)
<p>SW803</p> 	<p>Compressor operation frequency display            The operation frequency of the compressor is displayed.</p>	Refer to 3)
<p>SW803</p> 	<p>PMV opening display            The opening of PMV (Pulse Motor Valve) is displayed.</p>	Refer to 3)
<p>SW803</p> 	<p>Ps sensor display            Detected Ps sensor is displayed.</p>	Refer to 3)

## 2) Error display

The error which is generating at present and the latest error (Latest error information including present) can be confirmed by lighting LED D800 to D804 on the outdoor control P.C. board.

- When all DIP switch SW803 are OFF, the status of error which is generating at present is displayed.
- <1> only of DIP switch SW803 is turned on, the error which generated before (Latest error information including present) is displayed.a)
- If there is an error, any of LED D800 to D804 goes on. (Display 1)
- When pushing the pushdown button switch SW800 for approx. 1 second, the display is exchanged. (Display 2)
- When pushing SW800 again or after 2 minutes, the status returns to that of Display ①.

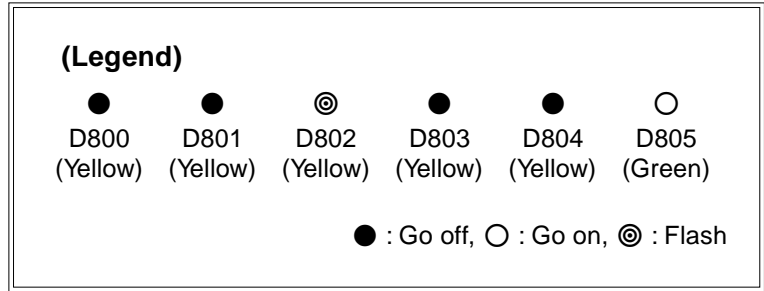
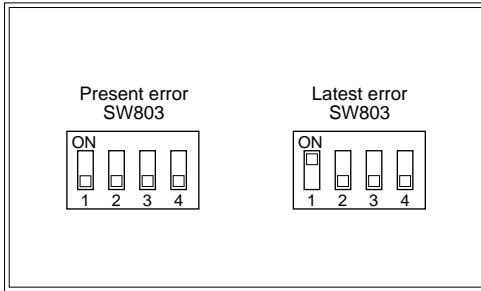

Display 1) (Initial display)	Display 2) (SW800 operation)	Error contents	Wired remote controller Error code
●●●●●○	●●●●●○	Normal	—
○○●●○○	●●⊙●●○	Discharge temp. sensor (TD) error	F04
	●⊙⊙●●○	Heat exchanger temp. sensor (TE) error	F06
	⊙⊙⊙●●○	Heat exchanger temp. sensor (TL) error	F06, F07
	●●●⊙●○	Outside temp. sensor (TO) error	F08
	●●⊙⊙●○	Suction temp. sensor (TS) error	F06, F12
	⊙●⊙⊙●○	Heat sink temp. sensor (TH) error	F13, L29
	⊙⊙⊙⊙●○	Heat exchanger sensor (TE, TS) miswiring	F06, F15
	⊙⊙⊙●⊙○	Ps sensor error	F23, H06
	⊙⊙⊙⊙⊙○	EEPROM error	F31, L29
●●○○●○○	⊙●●●●○	Compressor break down	H01
	●⊙●●●○	Compressor lock	H02
	⊙⊙●●●○	Current detection circuit error	H03
	●●⊙●●○	Case thermostat operation	H04, P04
	●⊙⊙●●○	Low pressure protective operation	H06
●○○●○○	●⊙⊙●●○	Model unset	L10, L29
	⊙●⊙⊙⊙○	Communication error between MCU	L29
	⊙⊙⊙⊙⊙○	Other error (Compressor disorder, etc.)	Error is not determined.
○○○●○○	⊙⊙●●●○	Discharge temp. error	P03
	●●⊙●●○	High pressure SW system error	P04
	⊙●⊙●●○	Power supply error	P04, P05
	⊙⊙⊙●●○	Heat sink overheat error	P07, L29
	⊙⊙⊙⊙●○	Gas leak detection	P15, L29
	⊙⊙●●⊙○	4-way valve reverse error	P19, L29
	●●⊙●⊙○	High pressure protective operation	P04, P20
	●⊙⊙●⊙○	Fan system error	P22
	●⊙●⊙⊙○	Driving element short-circuit	P26
	⊙●⊙⊙⊙○	Position detection circuit erro	P29

\* As the error code displayed on the wired remote controller may differ according to type of indoor model, multiple codes are described.

### 3) Sensor, current, compressor operation frequency, PMV opening display

The values detected by the controller, such as temperature sensor or current value are simply confirmed.

(Legend)					
●	●	⊙	●	●	○
D800 (Yellow)	D801 (Yellow)	D802 (Yellow)	D803 (Yellow)	D804 (Yellow)	D805 (Green)
					● : Go off, ○ : Go on

Item setup  LED display	Temperature sensor (°C)			Current (A)	Compressor operation frequency (rpm)	PMV opening (Pulse)	Pressure (kg/cm <sup>2</sup> G)
	TD SW803	TE SW803	TS SW803	SW803	SW803	SW803	SW803
●●●●●○	Below -25			0 to 0.9	0 to 4	0 to 19	-2 ~
○●●●●○	-25 to -21			1 to 1.9	5 to 9	20 to 39	-1 ~
●○●●●○	-20 to -16			2 to 2.9	10 to 14	40 to 59	0 ~
○○●●●○	-15 to -11			3 to 3.9	15 to 19	60 to 79	1 ~
●●○●●○	-10 to -5			4 to 4.9	20 to 24	80 to 99	2 ~
○●○●●○	-5 to -1			5 to 5.9	25 to 29	100 to 119	3 ~
●○○●●○	0 to 4			6 to 6.9	30 to 34	120 to 139	4 ~
○○○●●○	5 to 9			7 to 7.9	35 to 39	140 to 159	5 ~
●●●○●○	10 to 14			8 to 8.9	40 to 44	160 to 179	6 ~
○●●○●○	15 to 19			9 to 9.9	45 to 49	180 to 199	7 ~
●○●○●○	20 to 24			10 to 10.9	50 to 54	200 to 219	8 ~
○○●○●○	25 to 29			11 to 11.9	55 to 59	220 to 239	9 ~
●●○○●○	30 to 34			12 to 12.9	60 to 64	240 to 259	10 ~
○●○○●○	35 to 39			13 to 13.9	65 to 69	260 to 279	11 ~
●○○○●○	40 to 44			14 to 14.9	70 to 74	280 to 299	12 ~
○○○○●○	45 to 49			15 to 15.9	75 to 79	300 to 319	13 ~
●●●●○	50 to 54			16 to 16.9	80 to 84	320 to 339	14 ~
○●●●○	55 to 59			17 to 17.9	85 to 89	340 to 359	15 ~
●○●●○	60 to 64			18 to 18.9	80 to 84	360 to 379	16 ~
○○●●○	65 to 69			19 to 19.9	95 to 99	380 to 399	17 ~
●●○●○	70 to 74			20 to 20.9	100 to 104	400 to 419	18 ~
○●○●○	75 to 79			21 to 21.9	105 to 109	420 to 439	19 ~
●○○●○	80 to 84			22 to 22.9	110 to 114	440 to 459	20 ~
○○○●○	85 to 89			23 to 23.9	115 to 119	460 to 479	21 ~
●●●○○	90 to 94			24 to 24.9	120 to 124	480 to 499	22 ~
○●●○○	95 to 99			25 to 25.9	125 to 129	500	23 ~
●○●○○	100 to 104			26 to 26.9	130 to 134	—	24 ~
○○●○○	105 to 109			27 to 27.9	135 to 139	—	25 ~
●●○○○	110 to 114			28 to 28.9	140 to 144	—	26 ~
○●○○○	115 to 119			29 to 29.9	145 to 149	—	27 ~
●○○○○	Over 120			30 to 30.9	150 to 154	—	28 ~
○○○○○	Sensor error, unconnected			Over 31	Over 155	—	29 or more

\* As TD, TL and TH are sensors for high temperature, there is error at normal temperature or below position.

\* For current value, the current for the outdoor unit only is displayed.

#### 4) Specific operation for maintenance check (SW801, SW804)

The following specific operations for the maintenance check are performed by operation of SW801 or SW804.

- Select DIP switch SW804. (See table below)
- Push the pushdown button switch SW801 for approx. 1 second.
- The following functions start. While each function starts, LED D805 (Green) flashes.
- When pushing the pushdown button switch SW801 again for approx. 1 second, when selecting DIP switch SW804 or when the specified time of each function elapsed, each function stops and LED D805 (Green) returns to the continuous lighting.

#### <Specific operation>

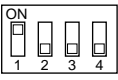
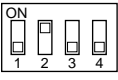
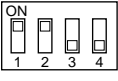
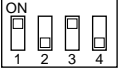
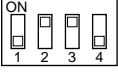
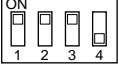
SW804	Operation when pushdown button switch SW801 is pushed	
	Refrigerant recovery operation The outdoor unit performs cooling operation. The indoor unit does not work by this operation alone. Therefore operate the fan beforehand.	
	Indoor cooling test run demand The cooling test run is performed. (→ <b>Note 1</b> )	
	Indoor heating test run demand The heating test run is performed. (→ <b>Note 1</b> )	
	Fan motor forced operation Drive the fan motor forcedly. When pushing SW801 again or when 2 minutes elapsed, the operation returns to the normal control.	<b>[NOTE]</b> Although these operations can be performed even during operation, basically perform operation while the unit stops.  If performing this operation during driving the unit, it is dangerous because the pressure may change suddenly.
	PMV full open operation Open PMV (Pulse Motor Valve) fully. When pushing SW801 again or when 2 minutes elapsed, the operation returns to the normal control.	
	PMV full close operation Close PMV (Pulse Motor Valve) fully. When pushing SW801 again or when 2 minutes elapsed, the operation returns to the normal control.	
	PMV middle opening operation Set PMV (Pulse Motor Valve) to middle opening. When pushing SW801 again or when 2 minutes elapsed, the operation returns to the normal control.	

**Note 1)** Indoor cooling test run demand / Indoor heating test run demand  
 Only when combining with the following indoor unit, cooling/heating operation can be performed from the outdoor unit.

Test run is available: Indoor unit of 4 series and after (RAV-SM\*\*\*4UT-E etc.)

Test run is unavailable: Indoor units other than the above-mentioned indoor units, or indoor units other than above-mentioned indoor units are included in the twin, triple, double twin connection.

**Note 2)** The forced test run by this setting cannot be cleared on the indoor remote controller.  
 Be sure to clear the test run by operation of the outdoor unit. (Push SW801 again for 1 second.)

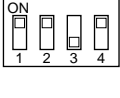
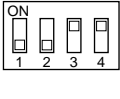
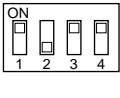
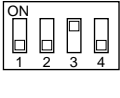
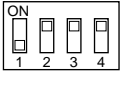
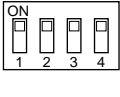
SW804	Operation when pushdown button switch SW801 is pushed	
	<p>4-way valve relay operation (For RY700, CN70 check) Turn on 4-way valve power relay (RY700). When pushing SW801 again or when 2 minutes elapsed, the operation returns to the normal control.</p>	<p><b>[CAUTION]</b> Although these operations can be performed even during operation, basically perform operation while the unit stops. If performing this operation during driving the unit, it is dangerous because the pressure may change suddenly.</p>
	<p>SV valve relay operation (For RY702, CN702 check) Turn on SV valve relay (RY702). When pushing SW801 again or when 2 minutes elapsed, the operation returns to the normal control.</p>	
	<p>Heater output relay operation (For check RY703, CN703 check) Turn on relay for option heater (RY703). When pushing SW801 again or when 2 minutes elapsed, the operation returns to the normal control.</p>	
	<p>Outside output relay operation (RY704, CN704) Turn on relay for outside output (RY704). When pushing SW801 again or when 2 minutes elapsed, the operation returns to the normal control.</p>	
	<p>Forced start command The indoor unit connected to the system is forcedly started. (The indoor unit starts operation by setting of the operation mode on the remote controller.)</p>	
	<p>Forced stop command The indoor unit connected to the system is forcedly stopped.</p>	
	<p>Relay operation change for outside output <b>[CAUTION]</b> Do not use this setting.</p>	



## 10. ADDRESS SETUP

### 10-1. Address Setup Procedure

When an outdoor unit and an indoor unit are connected, or when an outdoor unit is connected to each indoor unit respectively in the group operation even if multiple refrigerant lines are provided, the automatic address setup completes with power-ON of the outdoor unit. The operation of the remote controller is not accepted while automatic address works. (Approx. 4 to 5 minutes)

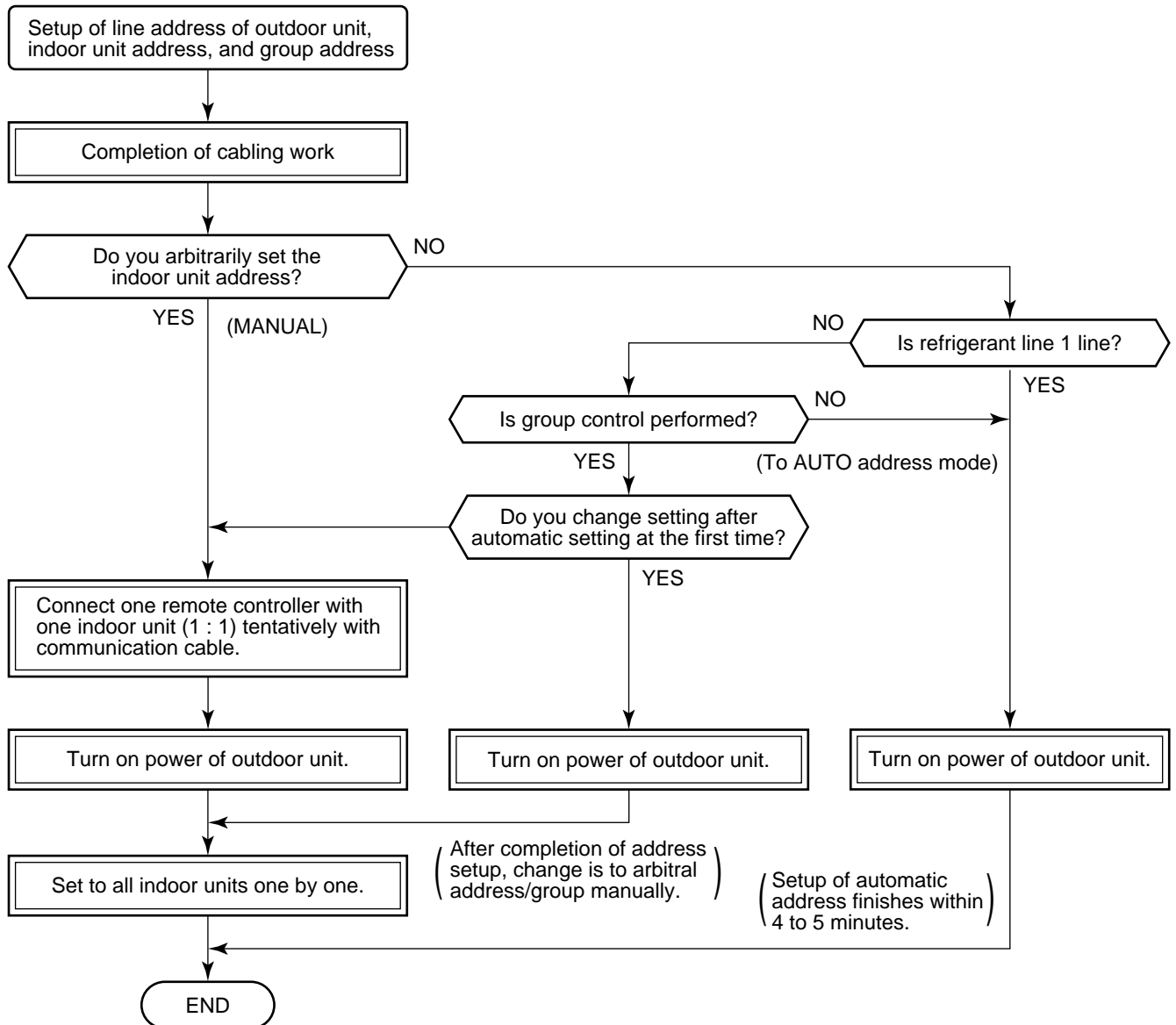

- When the following addresses are not stored in the neutral memory (IC503) on the indoor P.C. board, a test run operation cannot be performed. (Unfixed data at shipment from factory)

	Item code	Data at shipment	Setup data range
Line address	12	0099	0001 (No. 1 unit) to 0064 (No. 64 unit)
Indoor unit address	13	0099	0001 (No. 1 unit) to 0064 (No. 64 unit) Max. value of indoor units in the identical refrigerant line
Group address	14	0099	0000 : Individual (Indoor units which are not controlled in a group) 0001 : Master unit (1 indoor unit in group control) 0002 : Sub unit (Indoor units other than master unit in group control)

## 10-2. Address Setup & Group Control

### <Terminology>

Indoor unit No. :  $N - n =$  Outdoor unit line address  $N$  (Max. 30) - Indoor unit address  $n$  (Max. 64)

Group address : 0 = Single (Not group control)  
 1 = Master unit in group control  
 2 = Sub unit in group control

Master unit (= 1) : The representative of multiple indoor units in group operation sends/receives signals to/from the remote controllers and sub indoor units.  
 (\* It has no relation with an indoor unit which communicates serially with the outdoor units.)  
 The operation mode and setup temperature range are displayed on the remote controller LCD.  
 (Except air direction adjustment of louver)

Sub unit (= 2) : Indoor units other than master unit in group operation  
 Basically, sub units do not send/receive signals to/from the remote controllers.  
 (Except errors and response to demand of service data)

Header unit (Representative unit) (Master Twin)

: This unit communicates with the indoor unit (follower) which serial-communicates with the outdoor units and sends/receives signal (Command from compressor) to/from the outdoor units as the representative of the cycle control in the indoor units of the identical line address within the minimum unit which configures one of the refrigerating cycles of Twin.

Follower unit (Subordinate unit) (Sub Twin)

: Indoor units excluding the header unit in Twin

This unit communicates with (Header) indoor unit in the identical line address and performs control synchronized with (Header) indoor unit.

This unit does not perform the signal send/receive operation with the outdoor units. :  
 No judgment for serial signal error.

### 10-2-1. System Configuration

#### 1. Single

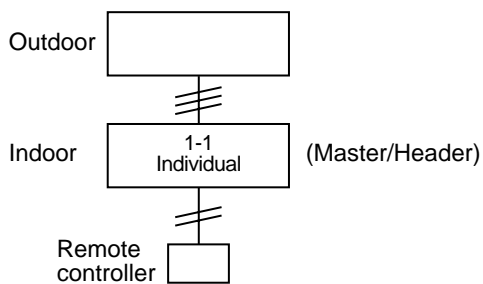

#### 2. Twin

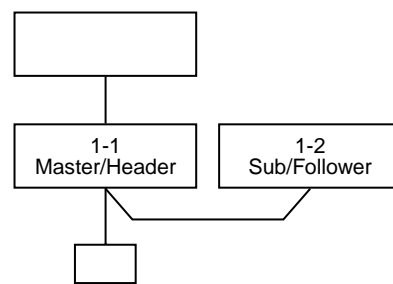

#### 3. Single group operation

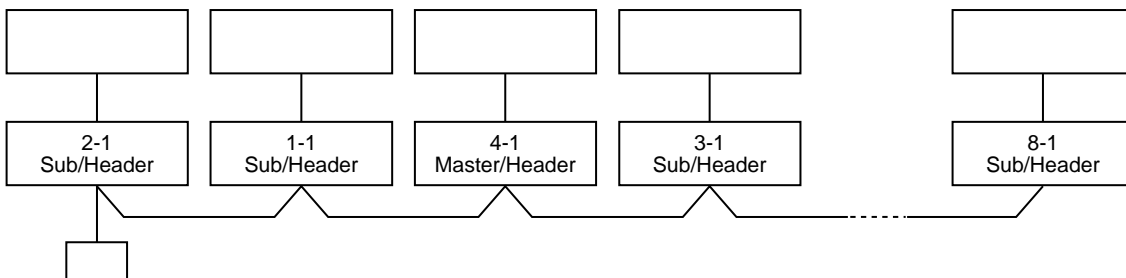

## 10-2-2. Automatic Address Example from Unset Address (No miswiring)

### 1. Standard (One outdoor unit)

#### 1) Single

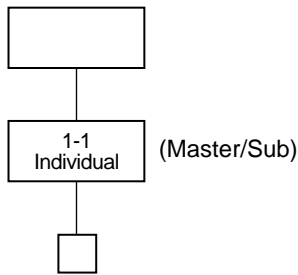

#### 2) Group operation (Twin, Triple operation)

(Multiple outdoor units = Multiple indoor units only with serial communication)

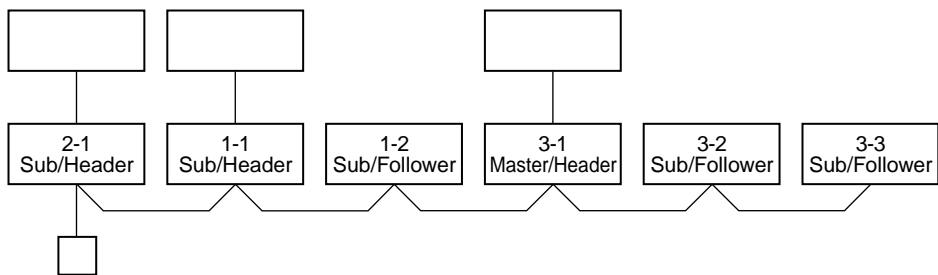

### Only turning on source power supply (Automatic completion)

- Header unit: The header unit receives the indoor unit data (thermo status) of the follower (Without identical line address & indoor/outdoor serial) and then finally controls the outdoor compressor matching with its own thermo status.  
The header unit sends this command information to the follower unit.
- Follower unit: The follower unit receives the indoor unit data from the header (With identical line address & indoor/outdoor serial) and then performs the thermo operation synchronized with the header unit.  
The follower unit sends own thermo ON/OFF demand to the header unit.

#### **(Example)**

No. 1-1 header unit sends/receives signal to/from No. 1-2 and No. 1-3 follower units.  
(It is not influenced by the line 2 or 3 address indoor unit.)

**10-2-3. Automatic Address Example from Unset Address (No miswiring)**

1. Standard (One outdoor unit)

1) Single

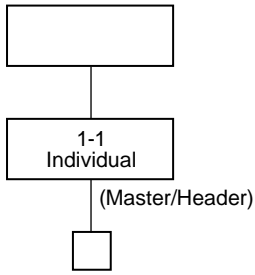

2) Twin

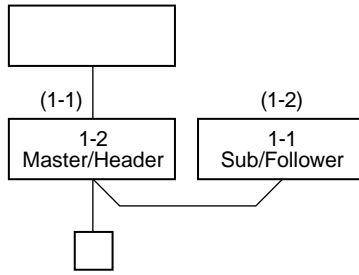

3) Triple

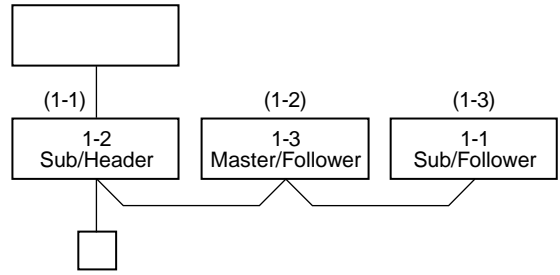

**Only turning on source power supply (Automatic completion)**

2. Group operation

(Multiple outdoor units = Multiple indoor units with serial communication only, without twin)

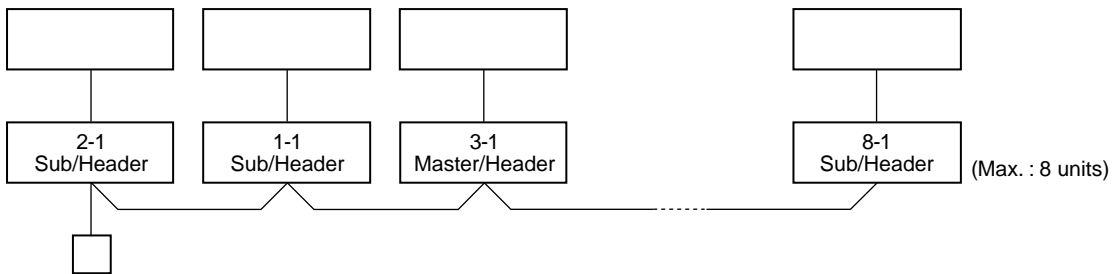

**Only turning on source power supply (Automatic completion)**

3. Multiple groups operation

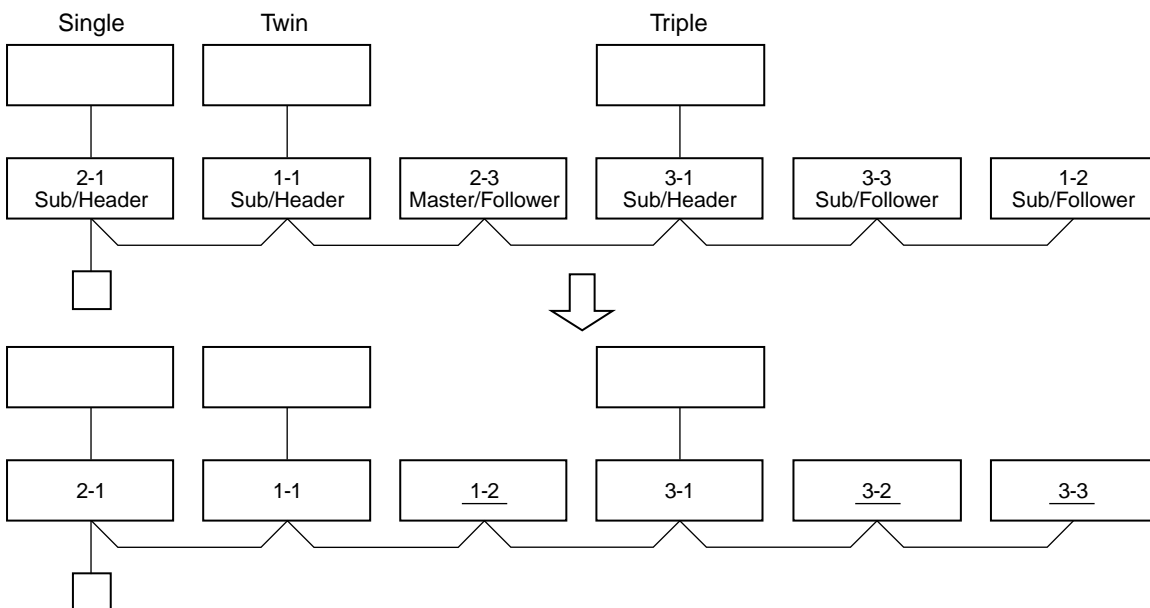

**Change is necessary**

**Manually change addresses of the multiple follower units simultaneously from the remote controller.**

### 10-3. Remote Controller Wiring

- Strip off approx. 9 mm the wire to be connected.
- For single system, use non polarity, 2 core wire is used for wiring of the remote controller. (0.5 mm<sup>2</sup> to 2.0 mm<sup>2</sup> wires)
- For the synchronous twin, triple system, use 2-core shield wire (Vinyl cord for microphone 0.5 to 2.0 mm<sup>2</sup>) to conform to the EMC standard.

#### Wiring diagram

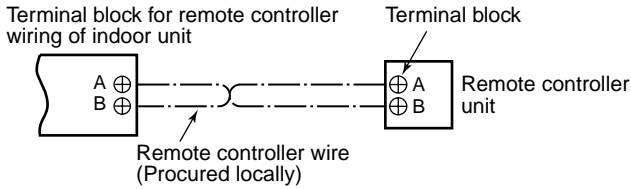

- \* For details of wiring/installation of the remote controller, refer to the Installation Manual enclosed with the remote controller.

#### Simultaneous twin system

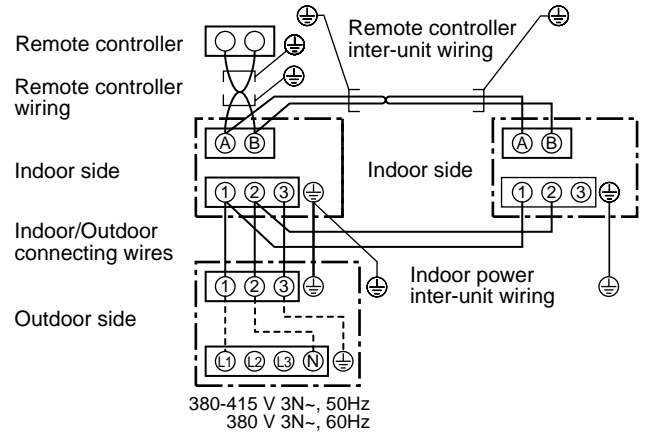

#### Simultaneous triple and double twin system

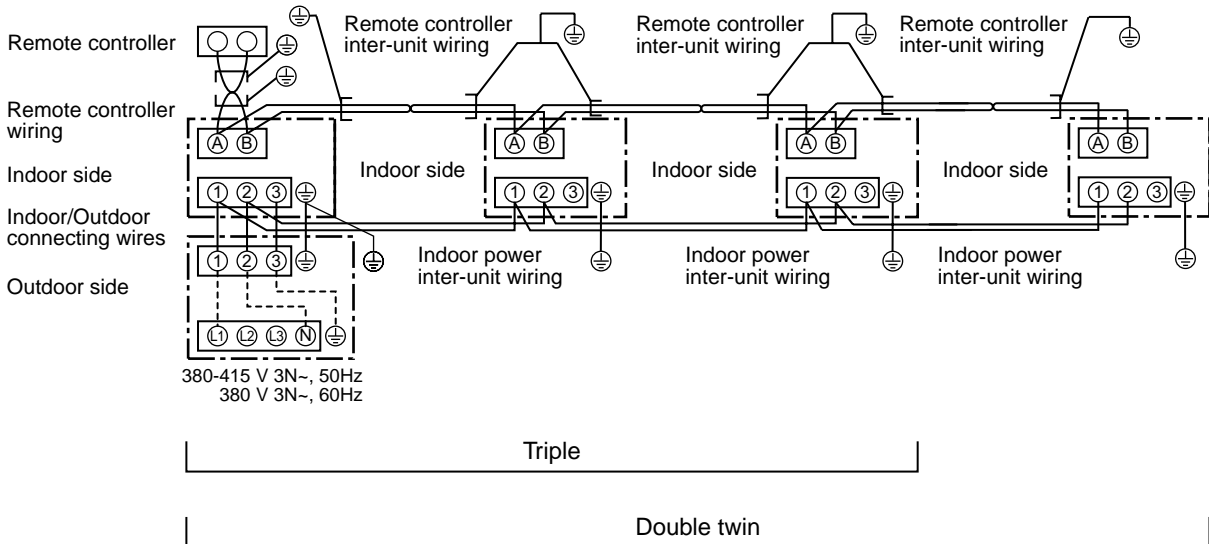

- \* Use 2-core shield wire (MVVS 0.5 to 2.0 mm<sup>2</sup> or more) for the remote controller wiring in the simultaneous twin, simultaneous triple and simultaneous double twin systems to prevent noise problems. Be sure to connect both ends of the shield wire to earth leads.
- \* Connect earth wires for each indoor unit in the simultaneous twin, simultaneous triple and simultaneous double twin systems.

### 10-4. Address Setup (Manual setting from remote controller)

In case that addresses of the indoor units will be determined prior to piping work after cabling work

- Set an indoor unit per a remote controller.
- Turn on power supply.

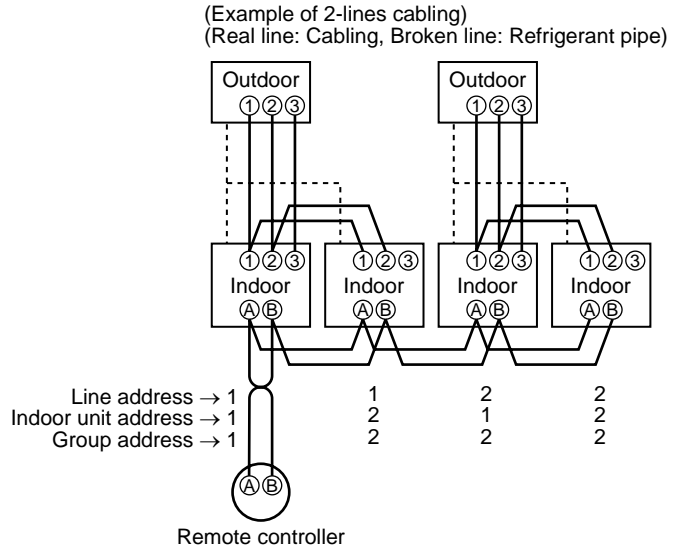

For the above example, perform setting by connecting singly the wired remote controller without remote controller inter-unit cable.

Group address  
 Individual : 0000  
 Master unit : 0001  
 Sub unit : 0002 } In case of group control

- 1 Push **SET** + **CL** + **TEST** buttons simultaneously for 4 seconds or more.
- 2 (← Line address)  
Using the temperature setup **▼** / **▲** buttons, set **12** to the CODE No.
- 3 Using timer time **▼** / **▲** buttons, set the line address.
- 4 Push **SET** button. (OK when display goes on.)
- 5 (← Indoor unit address)  
Using the temperature setup **▼** / **▲** buttons, set **13** to the CODE No.
- 6 Using timer time **▼** / **▲** buttons, set 1 to the line address.
- 7 Push **SET** button. (OK when display goes on.)
- 8 (← Group address)  
Using the temperature setup **▼** / **▲** buttons, set **14** to the CODE No.
- 9 Using timer time **▼** / **▲** buttons, set **0000** to Individual, **0001** to Master unit, and **0002** to sub unit.
- 10 Push **SET** button. (OK when display goes on.)
- 11 Push **TEST** button.  
Setup completes. (The status returns to the usual stop status.)

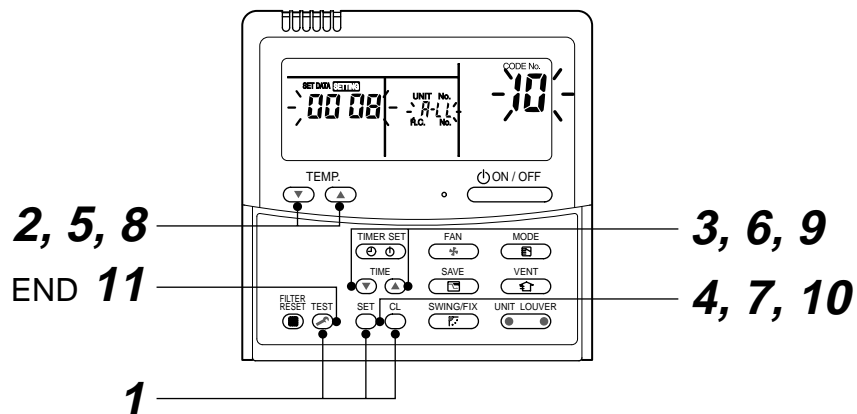

<Operation procedure>

**1 → 2 → 3 → 4 → 5 → 6 → 7 → 8 → 9 → 10 → 11** END

## 10-5. Confirmation of Indoor Unit No. Position

### 1. To know the indoor unit addresses though position of the indoor unit body is recognized

- In case of individual operation (Wired remote controller : indoor unit = 1 : 1)  
(Follow to the procedure during operation)

#### <Procedure>

**1** Push  button if the unit stops.

**2** Push  button.

Unit No. *1-1* is displayed on LCD.

(It disappears after several seconds.)

The displayed unit No. indicate line address and indoor unit address.

(When other indoor units are connected to the identical remote controller (Group control unit), other unit numbers are also displayed every pushing

 button.

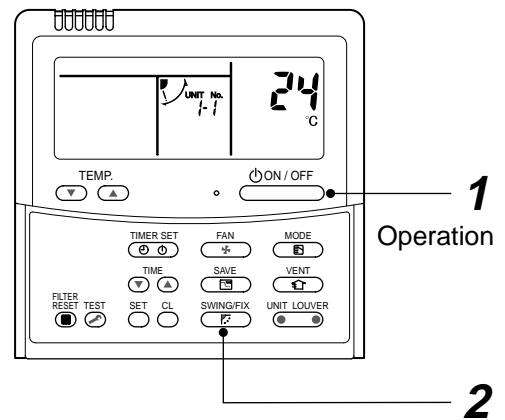

<Operation procedure>



**1 → 2** END

### 2. To know the position of indoor unit body by address

- To confirm the unit No. in the group control  
(Follow to the procedure during operation) (in this procedure, the indoor units in group control stop.)

#### <Procedure>

The indoor unit numbers in the group control are successively displayed, and fan, louver, and drain pump of the corresponding indoor unit are turned on.  
(Follow to the procedure during operation)

**1** Push  and  buttons simultaneously for 4 seconds or more.

- Unit No. *ALL* is displayed.
- Fans and louvers of all the indoor units in the group control operate.

**2** Every pushing  button, the unit numbers in the group control are successively displayed.

- The unit No. displayed at the first time indicates the master unit address.
- Fan and louver of the selected indoor unit only operate.

**3** Push  button to finish the procedure.  
All the indoor units in the group control stop.

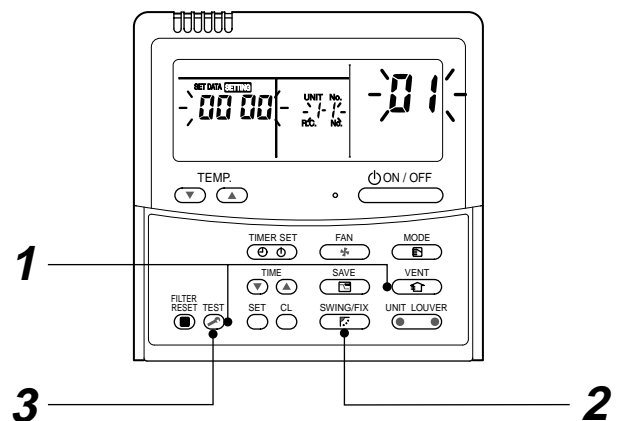

<Operation procedure>

**1 → 2 → 3** END

## <Maintenance/Check list>

Aiming in environmental preservation, it is strictly recommended to clean and maintain the indoor/outdoor units of the operating air conditioning system regularly to secure effective operation of the air conditioner.

It is also recommended to maintain the units once a year regularly when operating the air conditioner for a long time.

Check periodically signs of rust or scratches, etc. on coating of the outdoor units.

Repair the defective position or apply the rust resisting paint if necessary.

If an indoor unit operates for approx. 8 hours or more per day, usually it is necessary to clean the indoor/outdoor units once three months at least.

These cleaning and maintenance should be carried out by a qualified dealer.

Although the customer has to pay the charge for the maintenance, the life of the unit can be prolonged.

Failure to clean the indoor/outdoor units regularly will cause shortage of capacity, freezing, water leakage or trouble on the compressor.

Part name	Object		Contents of check	Contents of maintenance
	Indoor	Outdoor		
Heat exchanger	○	○	• Blocking with dust, damage check	• Clean it when blocking is found.
Fan motor	○	○	• Audibility for sound	• When abnormal sound is heard
Filter	○	—	• Visual check for dirt and breakage	• Clean with water if dirty • Replace if any breakage
Fan	○	○	• Visual check for swing and balance • Check adhesion of dust and external appearance.	• Replace fan when swinging or balance is remarkably poor. • If a large dust adheres, clean it with brush or water.
Suction/ Discharge grille	○	—	• Visual check for dirt and scratch	• Repair or replace it if deformation or damage is found.
Drain pan	○	—	• Check blocking by dust and dirt of drain water.	• Clean drain pan, Inclination check
Face panel, Louver	○	—	• Check dirt and scratch.	• Cleaning/Coating with repair painting
External appearance	—	○	• Check rust and peeling of insulator • Check peeling and floating of coating film	• Coating with repair painting



## 11. INSTALLATION MANUAL

Please read this Installation Manual carefully before installing the Air Conditioner.

- This Manual describes the installation method of the outdoor unit.
- For installation of the indoor unit, follow the Installation Manual attached to the indoor unit.

### ADOPTION OF NEW REFRIGERANT

This Air Conditioner is a new type that has adopted a new refrigerant HFC (R410A) instead of the conventional refrigerant R22 in order to prevent destruction of the ozone layer.

This equipment complies with IEC 61000-3-12 provided that the short-circuit power Ssc is greater than or equal to Ssc (\*1) at the interface point between the user's supply and the public system. It is the responsibility of the installer or user of the equipment to ensure, by consultation with the distribution network operator if necessary, that the equipment is connected only to a supply with a short-circuit power Ssc greater than or equal to Ssc (\*1).

#### Ssc (\*1)

Model	Ssc (MVA)
RAV-SM2244AT8(Z)(ZG)-E	1.41
RAV-SM2804AT8(Z)(ZG)-E	1.72

## Contents

<b>1</b>	<b>ACCESSORY PARTS</b>	<b>2</b>
<b>2</b>	<b>SAFETY PRECAUTIONS</b>	<b>3</b>
<b>3</b>	<b>INSTALLATION OF NEW REFRIGERANT AIR CONDITIONER</b>	<b>4</b>
<b>4</b>	<b>INSTALLATION CONDITIONS</b>	<b>6</b>
<b>5</b>	<b>REFRIGERANT PIPING</b>	<b>10</b>
<b>6</b>	<b>AIR PURGING</b>	<b>14</b>
<b>7</b>	<b>ELECTRICAL WORK</b>	<b>17</b>
<b>8</b>	<b>EARTHING</b>	<b>19</b>
<b>9</b>	<b>FINISHING</b>	<b>20</b>
<b>10</b>	<b>TEST RUN</b>	<b>20</b>
<b>11</b>	<b>ANNUAL MAINTENANCE</b>	<b>20</b>
<b>12</b>	<b>AIR CONDITIONER OPERATING CONDITIONS</b>	<b>20</b>
<b>13</b>	<b>FUNCTIONS TO BE IMPLEMENTED LOCALLY</b>	<b>21</b>
<b>14</b>	<b>TROUBLESHOOTING</b>	<b>22</b>
<b>15</b>	<b>APPENDIX</b>	<b>24</b>

## 1 ACCESSORY PARTS

### ■ Accessory Parts

Part name	Q'ty	Shape	Usage
Installation manual	1		(Hand this directly to the customer.)
Drain nipple	1		
Waterproof rubber cap	1		
Protective bush	1		For protecting wires (pipe cover)
Guard material for passage part	1		For protecting passage part (pipe cover)
Clamp filter	1		For conforming to EMC standards (Used for power wire)
Ø19.1 mm pipe	1		For the pipe inside the outdoor unit
Joint (Ø19.1 – Ø25.4 mm)	1		For connecting the pipe
Joint (Ø25.4 – Ø28.6 mm)	1		For connecting the pipe
Elbow	1		For connecting the pipe

### INFORMATION

- The main pipe on the gas side of this outdoor unit has a diameter of Ø28.6 mm, but a Ø19.1 mm flare connection is used where the valve is connected. Be sure to use the Ø19.1 mm pipe and joint provided as accessories for the pipe connection.
- Before installing the unit, check that the unit has the correct model name to prevent the wrong unit from being installed in the wrong place.
- Before proceeding to weld the refrigerant pipe, be sure to pass nitrogen through the pipe.
- Before installing the indoor units, read the instructions in the installation manual provided with the indoor units.
- Before installing a branch pipe, read the instructions in the installation manual provided with the branch pipe kit.
- In the case of a simultaneous double twin system, use indoor unit with the same capacity for all four indoor units.

	Branch pipe kit	Combination indoor unit
RAV-SM2244	RBC-DTWP101E	SM56 × 4 units
RAV-SM2804	RBC-DTWP101E	SM80 × 4 units

- P.C. board settings are required for some of the indoor units if they are to be used in a twin, triple or double twin system. Refer to the instructions in the installation manual of the branch pipe kit, and ensure that the settings are selected correctly.
- Combination with the indoor units  
Combination with the indoor units is possible only when units with the same type are combined. Combinations of units with different types cannot be used.

## 2 SAFETY PRECAUTIONS

- Ensure that all Local, National and International regulations are satisfied.
- Read these "SAFETY PRECAUTIONS" carefully before installation.
- The precautions described below include important items regarding safety. Observe them without fail.
- After the installation work, perform a trial operation to check for any problem. Follow the Owner's Manual to explain to the customer how to use and maintain the unit.
- Ask the customer to keep the Installation Manual together with the Owner's Manual.

### WARNING

- **Ask an authorized dealer or qualified installation professional to install/maintain the air conditioner. Perform installation work properly according to the Installation Manual.** Inappropriate installation may result in water leakage, electric shock or fire.
- **Be sure to connect earth wire (grounding work).** Incomplete grounding cause an electric shock. Do not connect ground wires to gas pipes, water pipes, lightning rods or ground wires for telephone wires.
- **Turn off the main power supply switch or breaker before attempting any electrical work and maintenance.** Make sure all power switches are off. Failure to do so may cause electric shock. Use an exclusive power circuit for the air conditioner. Use the rated voltage.
- **Connect the connecting wire correctly.** If the connecting wire is incorrect, electric parts may be damaged.
- **When moving the air conditioner for installation to another place, be very careful not to allow the specified refrigerant (R410A) to become mixed with any other gaseous body into the refrigeration cycle.** If air or any other gas mixes with the refrigerant, the gas pressure in the refrigeration cycle will become abnormally high and it may result in the pipe bursting or personal injuries.
- **Do not modify this unit by removing any of the safety guards or by by-passing any of the safety interlock switches.**
- **Do not touch the intake or aluminum fins of the outdoor unit.** Doing so may result in injury.
- **Tighten the flare nut with a torque wrench in the specified manner.** Excessive tightening of the flare nut may cause a crack in the flare nut after a long period, which may result in refrigerant leakage.
- **Install the air conditioner securely in a location where the base can sustain the weight of the unit adequately.**
- **Perform the specified installation work to guard against an earthquake.** If the air conditioner is not installed appropriately, accidents may occur due to the unit falling.
- **If refrigerant gas has leaked during the installation work, ventilate the room immediately.** If the leaked refrigerant gas comes in contact with fire, noxious gas may be generated.
- **After the installation work, confirm that refrigerant gas does not leak.** If refrigerant gas leaks into the room and flows near a fire source, such as a cooking range, noxious gas may be generated.
- **Electrical work must be performed by a qualified electrician in accordance with the Installation Manual. Make sure the air conditioner uses an exclusive power supply.** An insufficient power supply capacity or inappropriate installation may cause fire.
- **Use only the specified wiring during the unit installation. Ensure that all terminals are securely fixed, so preventing any external forces having a negative effect on the terminals.**
- **When the air conditioner cannot cool or heat a room well, contact the dealer from whom you purchased the air conditioner as refrigerant leakage is considered as the cause.** In the case of repair that requires refill of refrigerant, ask service personnel about details of the repair. The refrigerant used in the air conditioner is harmless. Generally, the refrigerant does not leak. However, if the refrigerant leaks in a room and a heater or stove burner in the room catches fire, it may generate toxic gas. When you ask service personnel for repairing refrigerant leakage, confirm that the leakage portion has been completely repaired.
- **Conform to the regulations of the local electric company when wiring the power supply.** Inappropriate grounding may cause electric shock.
- **Do not install the air conditioner in a location that may be subjected to a risk of exposure to a combustible gas.** If a combustible gas leaks and becomes concentrated around the unit, a fire may occur.

- **Install the refrigerant pipe securely during the installation work before operating the air conditioner.** If the compressor is operated with the valve open and without the refrigerant pipe, the compressor sucks air and the refrigeration cycle is overpressurized, which may cause a burst or injury.
- **When carrying out the pump-down work, shut down the compressor before disconnecting the refrigerant pipe.** Disconnecting the refrigerant pipe with the service valve left open and with the compressor still operating will cause air, etc. to be sucked in, raising the pressure inside the refrigeration cycle to an abnormally high level, and possibly resulting in rupturing, injury, etc.

### CAUTION

- **Do not climb onto or place objects on top of the outdoor unit.** You may fall or the objects may fall off of the outdoor unit and result in injury.
- **Wear heavy gloves during the installation work to avoid injury.**

#### To Disconnect the Appliance from the Main Power Supply

- This appliance must be connected to the main power supply by means of a switch with a contact separation of at least 3 mm.
- A 25 A installation fuse (all fuse types can be used) must be used for the power supply line of this conditioner.

## 3 INSTALLATION OF NEW REFRIGERANT AIR CONDITIONER

### CAUTION

#### New Refrigerant Air Conditioner Installation

- **THIS AIR CONDITIONER ADOPTS THE NEW HFC REFRIGERANT (R410A) WHICH DOES NOT DESTROY OZONE LAYER.**

R410A refrigerant is apt to be affected by impurities such as water, oxidizing membrane, and oils because the working pressure of R410A refrigerant is approx. 1.6 times as that of refrigerant R22. Accompanied with the adoption of the new refrigerant, the refrigerant oil has also been changed. Therefore, during installation work, be sure that water, dust, former refrigerant, or refrigerant oil does not enter the new type refrigerant R410A air conditioner cycle.

To prevent mixing of refrigerant or refrigerant oil, the sizes of connecting sections of charging port on main unit and installation tools are different from those of the conventional refrigerant units. Accordingly, special tools are required for the new refrigerant (R410A) units. For connecting pipes, use new and clean piping materials with high pressure fittings made for R410A only, so that water and/or dust does not enter.

■ **Required Tools/Equipment and Precautions for Use**

Prepare the tools and equipment listed in the following table before starting the installation work. Newly prepared tools and equipment must be used exclusively.

**Legend**

△ : Prepared newly (Use for R410A only. Do not use for refrigerant R22 or R407C etc.)

⊙ : Conventional tools/equipment are available

Tools/equipment	Use	How to use tools/equipment
Gauge manifold	Vacuuming/charging refrigerant and operation check	△ Prepared newly for R410A only
Charging hose		△ Prepared newly for R410A only
Charging cylinder	Can not be used	Unusable (Use the refrigerant charging measure instead.)
Gas leak detector	Gas leak check	△ Prepared newly
Vacuum pump	Vacuum drying	Unusable
Vacuum pump with backflow prevention function	Vacuum drying	⊙ R22 (Conventional tools)
Flare tool	Flare machining of pipes	⊙ Usable if dimensions are adjusted.
Bender	Bending pipes	⊙ R22 (Conventional tools)
Refrigerant recovery equipment	Refrigerant recovery	△ For R410A only
Torque wrench	Tightening flare nuts	△ Exclusive for Ø12.7 mm and Ø19.1 mm
Pipe cutter	Cutting pipes	⊙ R22 (Conventional tools)
Welding machine and nitrogen cylinder	Welding pipes	⊙ R22 (Conventional tools)
Refrigerant charging measure	Charging refrigerant	⊙ R22 (Conventional tools)

■ **Refrigerant Piping**

**New refrigerant (R410A)**

**When using the conventional piping**

- When using the conventional piping with no indication of applicable refrigerant types, be sure to use it with a wall thickness of 0.8 mm for Ø6.4 mm, Ø9.5 mm, and Ø12.7 mm, with a wall thickness of 1.0 mm for Ø15.9 mm, with a wall thickness of 1.2 mm for Ø19.1 mm, and with a wall thickness of 1.0 mm for Ø28.6 mm (half hard). Do not use the conventional piping with a wall thickness less than these thicknesses due to insufficient pressure capacity.

**When using general copper pipes**

- Use general copper pipes with a wall thickness of 0.8 mm for Ø6.4 mm, Ø9.5 mm, and Ø12.7 mm, with a wall thickness of 1.0 mm for Ø15.9 mm, with a wall thickness of 1.2 mm for Ø19.1 mm, and with a wall thickness of 1.0 mm for Ø28.6 mm (half hard). Do not use any copper pipes with a wall thickness less than these thicknesses.

**Flare nuts and flare machining**

- The flare nuts and flare machining are different from those for the conventional refrigerant. Use the flare nuts supplied with the air conditioner or those for R410A.
- Before performing flare machining, carefully read "REFRIGERANT PIPING".

**4 INSTALLATION CONDITIONS**

■ **Before installation**

Be sure to prepare to the following items before installation.

**Length of refrigerant pipe**

Length of refrigerant pipe connected to indoor/outdoor unit	Item
7.5 to 30 m	Addition of refrigerant is unnecessary at the local site.
*31 to 70 m	If the total length of the refrigerant pipe exceeds 30 m, add refrigerant in the amount given in the "Adding additional refrigerant".

- Do not connect a refrigerant pipe that is shorter than 7.5 m. This may cause a malfunction of the compressor or other devices.

**Airtight test**

- Before starting an airtight test, further tighten the spindle valves on the gas and liquid sides.
- Pressurize the pipe with nitrogen gas charged from the service port to the design pressure (4.15 MPa) to conduct an airtight test.
- After the airtight test is completed, evacuate the nitrogen gas.

**Air purge**

- To purge air, use a vacuum pump.
- Do not use refrigerant charged in the outdoor unit to purge air. (The air purge refrigerant is not contained in the outdoor unit.)

**Electrical wiring**

- Be sure to fix the power wires and indoor/outdoor connecting wires with clamps so that they do not come into contact with the cabinet, etc.

**Earthing**



**Make sure that proper earthing is provided.**

Improper earthing may cause an electric shock. For details on how to check earthing, contact the dealer who installed the air conditioner or a professional installation company.

- Proper earthing can prevent charging of electricity on the outdoor unit surface due to the presence of a high frequency in the frequency converter (inverter) of the outdoor unit, as well as prevent electric shock. If the outdoor unit is not properly earthed, you may be exposed to an electric shock.
- Be sure to connect the earth wire (grounding work).** Incomplete grounding can cause an electric shock. Do not connect ground wires to gas pipes, water pipes, lightning rods or ground wires for telephone wires.

**Test Run**

Turn on the leakage breaker at least 12 hours before starting a test run to protect the compressor during startup.



Incorrect installation work may result in a malfunction or complaints from customers.

■ Installation Location

**WARNING**

Install the outdoor unit properly in a location that is durable enough to support the weight of the outdoor unit.

Insufficient durability may cause the outdoor unit to fall, which may result in injury. This outdoor unit has a weight of about 135 kg. Pay special attention when installing the unit onto a wall surface.

**CAUTION**

Do not install the outdoor unit in a location that is subject to combustible gas leaks.

Accumulation of combustible gas around the outdoor unit may cause a fire.

Install the outdoor unit in a location that meets the following conditions after the customer's consent is obtained.

- A well-ventilated location free from obstacles near the air inlets and air outlet
- A location that is not exposed to rain or direct sunlight
- A location that does not increase the operating noise or vibration of the outdoor unit
- A location that does not produce any drainage problems from discharged water

Do not install the outdoor unit in the following locations.

- A location with a saline atmosphere (coastal area) or one that is full of sulfide gas (hot-spring area) (Special maintenance is required.)
- A location subject to oil, vapor, oily smoke, or corrosive gases
- A location in which organic solvent is used
- A location where high-frequency equipment (including inverter equipment, private power generator, medical equipment, and communication equipment) is used (Installation in such a location may cause malfunction of the air conditioner, abnormal control or problems due to noise from such equipment.)
- A location in which the discharged air of the outdoor unit blows against the window of a neighboring house
- A location where the operating noise of the outdoor unit is transmitted
- When the outdoor unit is installed in an elevated position, be sure to secure its feet.
- A location in which drain water poses any problems.

**CAUTION**

1. Install the outdoor unit in a location where the discharge air is not blocked.
2. When an outdoor unit is installed in a location that is always exposed to strong winds like a coast or on the high stories of a building, secure normal fan operation by using a duct or wind shield.
3. When installing the outdoor unit in a location that is constantly exposed to strong winds such as on the upper stairs or rooftop of a building, apply the windproofing measures referred to in the following examples.
  - 1) Install the unit so that its discharge port faces the wall of the building. Keep a distance 500 mm or more between the unit and wall surface.

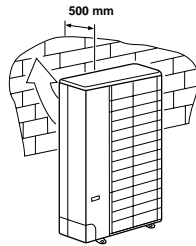

- 2) Consider the wind direction during the operational season of the air conditioner, and install the unit so that the discharge port is set at a right angle relative to the wind direction.

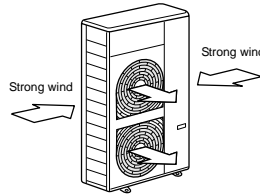

- When using an air conditioner under low outside temperature conditions (Outside temp: -5 °C or lower) in COOL mode, prepare a duct or wind shield so that it is not affected by the wind.

<Example>

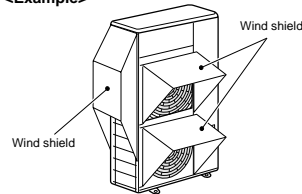

■ Necessary Space for Installation (Unit: mm)

Obstacle at rear side

Upper side is free

1. Single unit installation

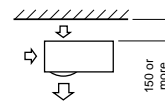

2. Obstacles on both right and left sides

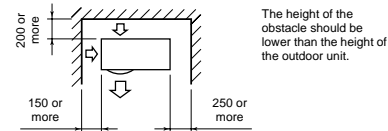

3. Serial installation of two or more units

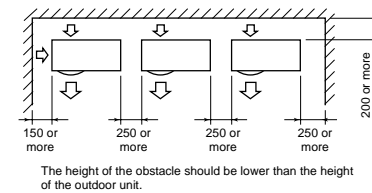

Obstacle also above unit

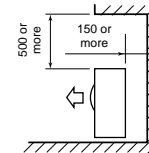

Obstacle in front

Above unit is free

1. Single unit installation

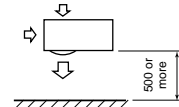

2. Serial installation of two or more units

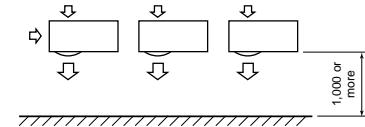

Obstacle also at the above unit

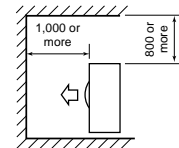

Obstacles in both front and rear of unit

Open above and to the right and left of the unit. The height of an obstacle in both the front and rear of the unit, should be lower than the height of the outdoor unit.

Standard installation

1. Single unit installation

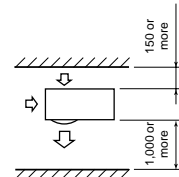

2. Serial installation of two or more units

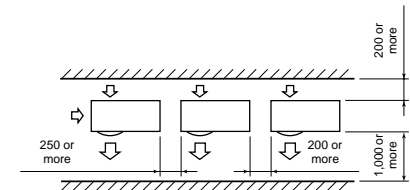

**Serial installation in front and rear**

Open above and to the right and left of the unit. The height of an obstacle in both the front and rear of the unit should be lower than the height of the outdoor unit.

**Standard installation**

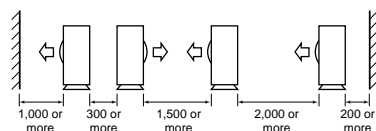

**Installation of Outdoor Unit**

- Before installation, check the strength and horizontalness of the base so that abnormal sounds do not emanate.
- According to the following base diagram, fix the base firmly with the anchor bolts. (Anchor bolt, nut: M10 x 4 pairs)

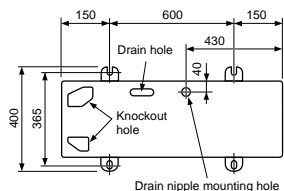

- As shown in the figure below, install the foundation and vibration-proof rubber pads to directly support the bottom surface of the fixing leg that is in contact with and underneath the bottom plate of the outdoor unit.
- When installing the foundation for an outdoor unit with downward piping, consider the piping work.

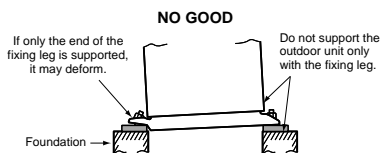
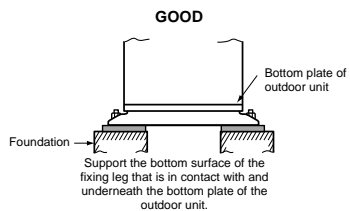
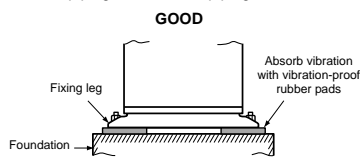

Set the out margin of the anchor bolt to 15 mm or less.

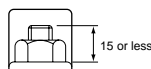

- When water is to be drained through the drain hose, attach the following drain nipple and waterproof rubber cap, and use the drain hose (Inner diam: 16 mm) sold on the market. Also seal the knockout hole and screws securely with silicone material, etc., to prevent water from leaking.
- Some conditions may cause dewing or dripping of water.
- When collectively draining discharged water completely, use a drain pan.

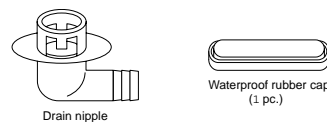

- Please pay attention to the drain in region with snowfall and cold temperature, as it may be frozen and cause drainage problems. Punch the knockout holes on the base plate to improve drainability. Use a screwdriver and take off the knockout part outward.

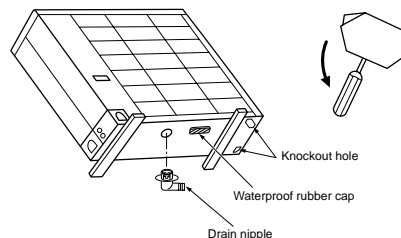

**For Reference**

If a heating operation is to be continuously performed for a long time under the condition that the outdoor temperature is 0 °C or lower, draining defrosted water may be difficult due to the bottom plate freezing, resulting in trouble with the cabinet or fan. It is recommended to procure an anti-freeze heater locally in order to safely install the air conditioner. For details, contact the dealer.

**5 REFRIGERANT PIPING**

**Knockout of Pipe Cover**

**Knockout procedure**

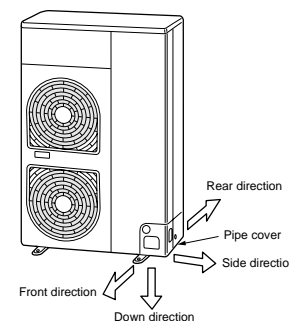

- The indoor/outdoor connecting pipes can be connected in 4 directions. Take off the knockout part of the pipe cover through which pipes or wires will pass through the base plate.
- Detach the pipe cover and tap on the knockout section a few times with the shank of a screwdriver. A knockout hole can easily be punched.
- As shown in the figure below, it is easier to punch out the knockout hole when the pipe cover is left in place rather than when the cover is removed from the unit. In knocking out the hole, the knockout section can easily be removed by hand once the bottom of the three locations where the section is joined along the guide lines is broken using a screwdriver.
- After punching out the knockout hole, remove burrs from the hole, and install the protective bush and guard material around the passage hole provided as accessories in order to protect the wires and pipes. Also be sure to attach the pipe covers after connecting the pipes. The pipe covers can be easily attached by cutting off the slits at the lower part of the covers.

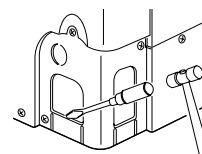

- \* Be sure to wear heavy work gloves while working.

**Optional Installation Parts (Locally procured)**

	Parts name	Q'ty
A	Refrigerant piping Liquid side: Ø12.7 mm Gas side: Ø19.1 mm (Approx. 800 mm) Ø28.6 mm	One each
B	Pipe insulating material (polyethylene foam, 10 mm thick)	1
C	Putty, PVC tape	One each

**REQUIREMENT**

Follow the instructions in the installation manual provided with the branch pipe kit and the instructions in the installation manual of the indoor unit to connect the refrigerant pipe between the branch pipe and indoor unit.

**Refrigerant Piping Connection**

**CAUTION**

**TAKE NOTE OF THESE 4 IMPORTANT POINTS BELOW FOR PIPING WORK**

1. Keep dust and moisture away from inside the connecting pipes.
2. Tightly connect the connection between pipes and the unit.
3. Evacuate the air in the connecting pipes using a VACUUM PUMP.
4. Check for gas leaks at connection points.

**Piping connection**

Liquid side	
Outer diameter	Thickness
Ø12.7 mm	0.8 mm

Gas side	
Outer diameter	Thickness
Ø19.1 mm	1.2 mm
Ø28.6 mm	1.0 mm (half hard)

**REQUIREMENT**

On the gas side, be sure to use the Ø19.1 mm pipe provided with the outdoor unit.

**Flaring**

1. Cut the pipe with a pipe cutter.  
Be sure to remove burrs that may cause a gas leak.
2. Insert a flare nut into the pipe, and then flare the pipe.  
Use the flare nuts supplied with the air conditioner or those for R410A.  
Insert a flare nut into the pipe, and flare the pipe.  
As the flaring sizes of R410A differ from those of refrigerant R22, the flare tools newly manufactured for R410A are recommended.  
However, the conventional tools can be used by adjusting the projection margin of the copper pipe.

**Projection margin in flaring: B (Unit: mm)**

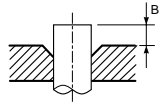

Rigid (Clutch type)

Outer diam. of copper pipe	R410A tool used	Conventional tool used
	R410A	
9.5	0 to 0.5	1.0 to 1.5
12.7		
15.9		
19.1		

**Flaring diameter size: A (Unit: mm)**



Outer diam. of copper pipe	A <sup>+0.4</sup>
9.5	13.2
12.7	16.6
15.9	19.7
19.1	24.0

\* In case of flaring for R410A with the conventional flare tool, pull the tool out approx. 0.5 mm more than that for R22 to adjust it to the specified flare size.  
The copper pipe gauge is useful for adjusting the projection margin size.

**Connecting the Gas Side Pipe**

**REQUIREMENT**

- Be sure to use the Ø19.1 mm pipe and joint provided as accessories of the outdoor unit to connect the gas side Ø19.1 mm pipe and Ø28.6 mm pipe.
- When leading out the pipes toward the front, to one of the sides or toward the rear, use the Ø19.1 mm pipe and elbow provided as accessories of the outdoor unit, and adjust the bending direction. Cut the Ø19.1 mm pipe to the required length before using it.

1. Align the provided Ø19.1 mm pipe with the pipe lead-out direction, and shape it so that its end comes out from the outdoor unit.
2. On the outside of the outdoor unit, use the provided joints, and braze the Ø19.1 mm pipe and Ø28.6 mm pipe.

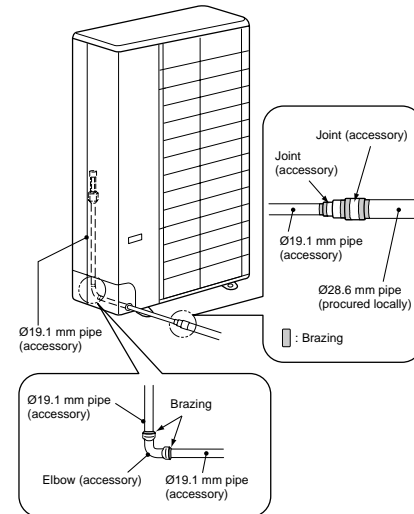

**REQUIREMENT**

- Before proceeding to weld the refrigerant pipe, be sure to pass nitrogen through the pipe to prevent oxidation inside it. If nitrogen is not passed through the pipe, the refrigerating cycle may become clogged by oxidized scales.
- The Ø28.6 mm pipe cannot be passed through the pipe cover and knockout hole in the base plate so be sure to connect the Ø19.1 mm pipe and Ø28.6 mm pipe outside the outdoor unit.

**Tightening of Connecting Part**

1. Align the centers of the connecting pipes and fully tighten the flare nut with your fingers. Then fix the nut with a wrench as shown in the figure and tighten it with a torque wrench.

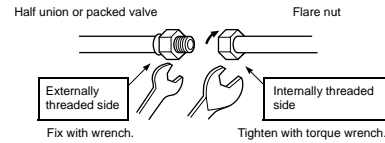

2. As shown in the figure, be sure to use two wrenches to loosen or tighten the flare nut of the valve on the gas side. If you use a single crescent, the flare nut cannot be tightened to the required tightening torque. On the other hand, use a single crescent to loosen or tighten the flare nut of the valve on the liquid side.

(Unit: N•m)

Outer dia. of copper pipe	Tightening torque
9.5 mm (diam.)	33 to 42 (3.3 to 4.2 kgf•m)
12.7 mm (diam.)	50 to 62 (5.0 to 6.2 kgf•m)
15.9 mm (diam.)	68 to 82 (6.8 to 8.2 kgf•m)
19.1 mm (diam.)	100 to 120 (10.0 to 12 kgf•m)

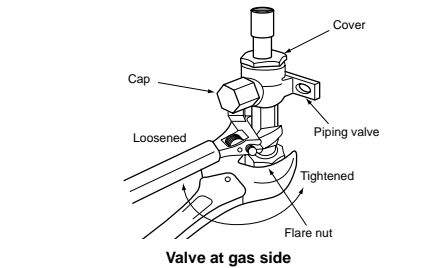

**CAUTION**

1. Do not put the crescent wrench on the cap or cover. The valve may break.
2. If applying excessive torque, the nut may break according to some installation conditions.

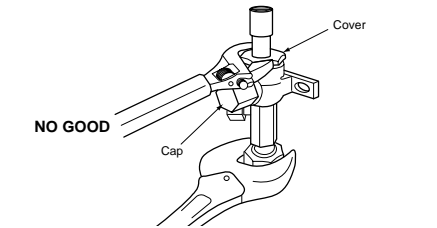

- After the installation work, be sure to check for gas leaks of the pipe connections with nitrogen.
- Pressure of R410A is higher than that of R22 (Approx. 1.6 times).  
Therefore, using a torque wrench, tighten the flare pipe connecting sections that connect the indoor/outdoor units at the specified tightening torque.  
Incomplete connections may cause not only a gas leak, but also trouble with the refrigeration cycle.

**Do not apply refrigerant oil to the flared surface.**

**Branch Pipe**

Carry out the refrigerant piping work using the branch pipe kit which is purchased separately.

**Branch pipe installation**

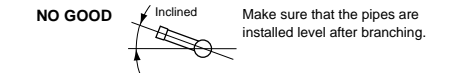
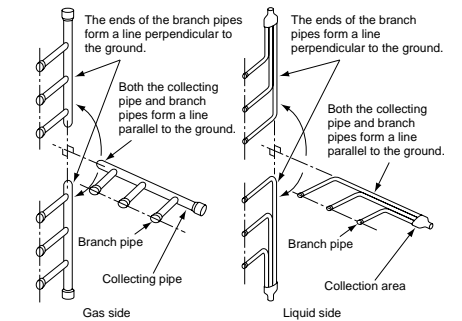

**Length of straight sections on main pipe side of branch pipe**

Provide a straight section with a length of at least 500 mm on the main pipe side of the branch pipe. (Same for both liquid side and gas side)

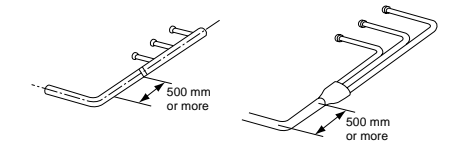

■ Refrigerant Pipe Length

Simultaneous twin, triple

Outdoor unit	Allowable pipe length (m)			Height difference (m)		
	Total length • $l_1 + l_2$ • $l_1 + l_3$ • $l_1 + l_4$ Maximum	Branch piping • $l_2$ • $l_3$ • $l_4$ Maximum	Branch piping • $l_3 - l_2$ • $l_4 - l_2$ • $l_4 - l_3$ Maximum	Indoor-outdoor H		Indoor-indoor ( $\Delta h$ )
		Indoor unit: Upper	Outdoor unit: Upper			
SM2244	70	20	10	30	30	0.5
SM2804	70	20	10	30	30	0.5

Outdoor unit	Pipe diameter (mm)				Number of bent portions
	Main pipe		Branch piping		
	Gas side	Liquid side	Gas side	Liquid side	
SM2244	$\varnothing 28.6$	$\varnothing 12.7$	$\varnothing 15.9$	$\varnothing 9.5$	10 or less
SM2804	$\varnothing 28.6$	$\varnothing 12.7$	$\varnothing 15.9$	$\varnothing 9.5$	10 or less

Figure of Simultaneous twin

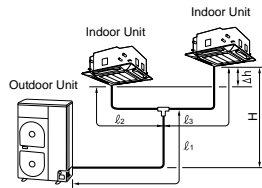
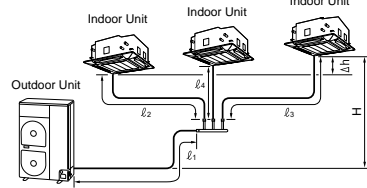

Figure of Simultaneous triple



Simultaneous double twin

Outdoor unit	Allowable pipe length (m)				Height difference (m)		
	Total length • $l_1 + l_2 + l_4$ • $l_1 + l_2 + l_5$ • $l_1 + l_3 + l_6$ • $l_1 + l_3 + l_7$ Maximum	Branch piping • $l_4$ • $l_5$ • $l_6$ • $l_7$ Maximum	Branch piping • $l_4 + l_2$ • $l_5 + l_2$ • $l_6 + l_3$ • $l_7 + l_3$ Maximum	Branch piping • $(l_4 + l_2) - (l_5 + l_2)$ • $(l_4 + l_2) - (l_6 + l_3)$ • $(l_4 + l_2) - (l_7 + l_3)$ • $(l_5 + l_2) - (l_6 + l_3)$ • $(l_5 + l_2) - (l_7 + l_3)$ • $(l_6 + l_3) - (l_7 + l_3)$ Maximum	Indoor-outdoor H		Indoor-indoor ( $\Delta h$ )
		Indoor unit: Upper	Outdoor unit: Upper				
SM2244	70	15	20	6	30	30	0.5
SM2804	70	15	20	6	30	30	0.5

Outdoor unit	Pipe diameter (mm)				Number of bent portions
	Main pipe		Branch piping		
	Gas side	Liquid side	Gas side	Liquid side	
SM2244	$\varnothing 28.6$	$\varnothing 12.7$	$l_2, l_3: \varnothing 15.9$ $l_4, l_5, l_6, l_7: \varnothing 12.7$	$l_2, l_3: \varnothing 9.5$ $l_4, l_5, l_6, l_7: \varnothing 6.4$	10 or less
SM2804	$\varnothing 28.6$	$\varnothing 12.7$	$l_2$ to $l_7: \varnothing 15.9$	$l_2$ to $l_7: \varnothing 9.5$	10 or less

Figure of Simultaneous double twin

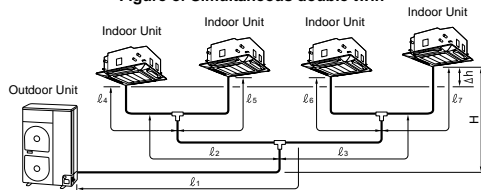

# 6 AIR PURGING

■ Airtight Test

Before starting an airtight test, further tighten the spindle valves on the gas side and liquid side. Pressurize the pipe with nitrogen gas charged from the service port to the design pressure (4.15 MPa) to conduct the airtight test. After the airtight test is completed, evacuate the nitrogen gas.

■ Air Purge

With respect to the preservation of the terrestrial environment, adopt "Vacuum pump" to purge air (Evacuate air in the connecting pipes) when installing the unit.

- Do not discharge the refrigerant gas to the atmosphere to preserve the terrestrial environment.
- Use a vacuum pump to discharge the air (nitrogen, etc.) that remains in the set. If air remains, the capacity may decrease.

For the vacuum pump, be sure to use one with a backflow preventer so that the oil in the pump does not backflow into the pipe of the air conditioner when the pump stops. (If oil in the vacuum pump is put in an air conditioner including R410A, it may cause trouble with the refrigeration cycle.)

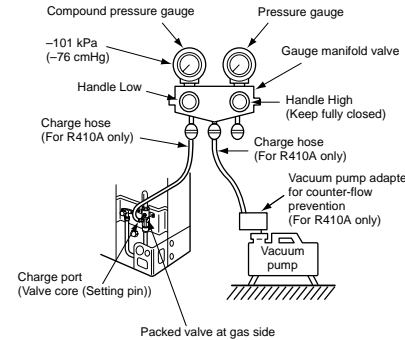

Vacuum pump

- As shown in the figure, connect the charge hose after the manifold valve is closed completely.
- ↓
- Attach the connecting part of the charge hose with a projection to push the valve core (setting pin) to the charge port of the set.
- ↓
- Open Handle Low fully.
- ↓
- Turn ON the vacuum pump. (\*1)
- ↓
- Loosen the flare nut of the packed valve (Gas side) a little to check that the air passes through. (\*2)
- ↓
- Retighten the flare nut.
- ↓
- Execute vacuuming until the compound pressure gauge indicates -101 kPa (-76 cmHg). (\*1)
- ↓
- Close Handle Low completely.
- ↓
- Turn OFF the vacuum pump.
- ↓
- Leave the vacuum pump as it is for 1 or 2 minutes, and check that the indicator of the compound pressure gauge does not return.
- ↓
- Open the valve stem or valve handle fully. (First, at liquid side, then gas side)
- ↓
- Disconnect the charge hose from the charge port.
- ↓
- Tighten the valve and caps of the charge port securely.

\*1 Use the vacuum pump, vacuum pump adapter, and gauge manifold correctly referring to the manuals supplied with each tool before using them. Check that the vacuum pump oil is filled up to the specified level of the oil gauge.

\*2 When air is not charged, check again whether the connecting part of the discharge hose, which has a projection to push the valve core, is firmly connected to the charge port.

### How to Open the Valve

Open or close the valve.

#### Liquid side

Open the valve with a 4 mm hexagon wrench.

#### Gas side

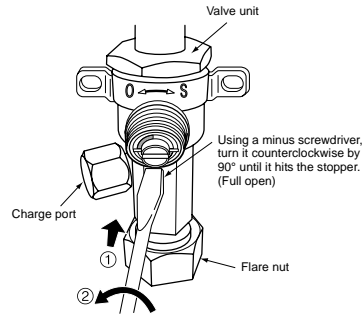

Handle position

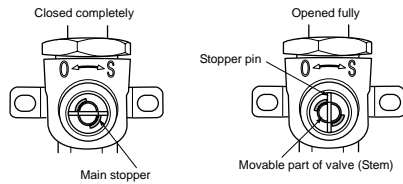

- While the valve is fully opened, after the screwdriver has reached the stopper, do not apply torque exceeding 5 N•m. Applying excessive torque may damage the valve.

#### Valve handling precautions

- Open the valve stem until it strikes the stopper. It is unnecessary to apply further force.
- Securely tighten the cap with a torque wrench.

#### Cap tightening torque

Valve size	Ø12.7 mm	50 to 62 N•m (5.0 to 6.2 kgf•m)
	Ø19.1 mm	20 to 25 N•m (2.0 to 2.5 kgf•m)
Charge port		14 to 18 N•m (1.4 to 1.8 kgf•m)

### Insulating the Pipes

- The temperatures at both the liquid side and gas side will be low during cooling so in order to prevent condensation, be sure to insulate the pipes at both of these sides.
- Insulate the pipes separately for the liquid side and gas side.
- Insulate the branch pipes by following the instructions in the installation manual provided with the branch pipe kit.
- Use the insulating material provided as an accessory to insulate the Ø19.1 mm pipe at the gas side.
- Seal the area where the Ø19.1 mm pipe and Ø22.2 to Ø28.6 mm pipe are connected so that no gaps are left.

#### REQUIREMENT

Be sure to use an insulating material which can withstand temperatures above 120°C for the gas side pipe since this pipe will become very hot during heating operations.

### Replenishing Refrigerant

This model is a 30 m chargeless type that does not need to have its refrigerant replenished for refrigerant pipes up to 30 m. When a refrigerant pipe longer than 30 m is used, add the specified amount of refrigerant.

#### Refrigerant replenishing procedure

- After vacuuming the refrigerant pipe, close the valves and then charge the refrigerant while the air conditioner is not working.
- When the refrigerant cannot be charged to the specified amount, charge the required amount of refrigerant from the charge port of the valve on the gas side during cooling.

#### Requirement for replenishing refrigerant

Replenish liquid refrigerant. When gaseous refrigerant is replenished, the refrigerant composition varies, which disables normal operation.

### Adding additional refrigerant

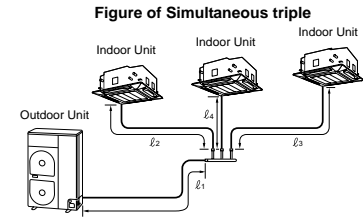
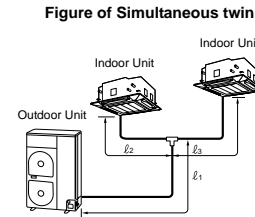
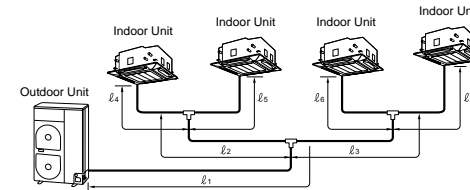

Figure of Simultaneous double twin



#### Formula for calculating the amount of additional refrigerant

(Formula will differ depending on the diameter of the liquid connecting side pipe.)

\* l1 to l7 are the lengths of the pipes shown in the figures above (unit: m).

#### Simultaneous twin

Diameter of connecting pipe (liquid side)			Amount of additional refrigerant per meter (g/m)		Amount of additional refrigerant (g) = Amount of refrigerant added for main pipe + amount of refrigerant added for branch piping
l1	l2	l3	α	β	
Ø12.7	Ø9.5	Ø9.5	80	40	$\alpha \times (l1 - 28) + \beta \times (l2 + l3 - 4)$

#### Simultaneous triple

Diameter of connecting pipe (liquid side)				Amount of additional refrigerant per meter (g/m)		Amount of additional refrigerant (g) = Amount of refrigerant added for main pipe + amount of refrigerant added for first branch piping + amount of refrigerant added for second branch piping
l1	l2	l3	l4	α	β	
Ø12.7	Ø9.5	Ø9.5	Ø9.5	80	40	$\alpha \times (l1 - 28) + \beta \times (l2 + l3 + l4 - 6)$

#### Simultaneous double twin

Outdoor unit	Diameter of connecting pipe (liquid side)			Amount of additional refrigerant per meter (g/m)			Amount of additional refrigerant (g) = Amount of refrigerant added for main pipe + amount of refrigerant added for first branch piping + amount of refrigerant added for second branch piping
	l1	l2, l3	l4 to l7	α	β	γ	
SM2244	Ø12.7	Ø9.5	Ø6.4	80	40	20	$\alpha \times (l1 - 28) + \beta \times (l2 + l3 - 4) + \gamma \times (l4 + l5 + l6 + l7)$
SM2804	Ø12.7	Ø9.5	Ø9.5	80	40	40	$\alpha \times (l1 - 28) + \beta \times (l2 + l3 - 4) + \gamma \times (l4 + l5 + l6 + l7)$



# 7 ELECTRICAL WORK

## ⚠ WARNING

- Using the specified wires, ensure that the wires are connected, and fix wires securely so that the external tension to the wires does not affect the connecting part of the terminals.  
Incomplete connection or fixation may cause a fire, etc.
- Be sure to connect the earth wire (grounding work). Incomplete grounding may lead to electric shock. Do not connect ground wires to gas pipes, water pipes, lightning rods or ground wires for telephone wires.
- The appliance shall be installed in accordance with national wiring regulations.  
Capacity shortages of the power circuit or an incomplete installation may cause an electric shock or fire.

## ⚠ CAUTION

- Wrong wiring may cause a burn-out of some electrical parts.
  - Be sure to use the cord clamps attached to the product.
  - Do not damage or scratch the conductive core or inner insulator of the power and inter-connecting wires when peeling them.
  - Use the power and Inter-connecting wires with specified thicknesses, specified types and protective devices required.
- Remove the panel, and you can see electric parts on the front side.
  - A metal pipe can be installed through the hole for wiring. If the hole size does not fit the wiring pipe to be used, drill the hole again to an appropriate size.

Furthermore, be sure to secure these wires with the pipe valve fixing plate and cord clamps stored in the electric parts box.

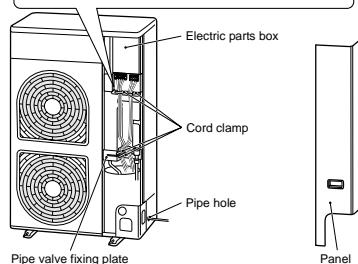
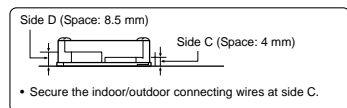

- When the outdoor air temperature drops, power is supplied to the compressor with the purpose of preheating the compressor in order to protect it. Therefore, leave the main power switch at the "on" setting during the periods when the air conditioner is being used.

## ■ Wiring between Indoor Unit and Outdoor Unit

- Figure below shows the wiring connections between the standard indoor and outdoor units and between the indoor units and remote controller. The wires indicated by the broken lines or dot-and-dash lines are provided at the installation place.
- Refer to the wiring diagrams of the models concerned for the internal wiring connections of the outdoor unit and indoor units.
- There is no need to perform the P.C. board settings for the indoor units.

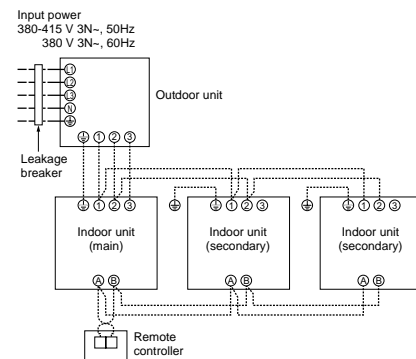

## ■ Power and Wiring Specifications

Model (RAV-SM Type)	224AT8	280AT8	224AT7	280AT7
Power supply	380-415 V 3N- 50 Hz		380 V 3N- 60 Hz	
Maximum running current	18.0 A	22.0 A	18.0 A	22.0 A
Installation fuse rating	25 A	25 A	25 A	25 A
Power wire*	5 × 2.5 mm <sup>2</sup> or more (H07 RN-F or 60245 IEC 66)			
Indoor/outdoor connecting wires*	4 × 1.5 mm <sup>2</sup> or more (H07 RN-F or 60245 IEC 66)			

\* Number of wire × wire size

## How to wire

- Connect the connecting wire to the terminal as identified with their respective numbers on the terminal block of the indoor and outdoor units.  
H07 RN-F or 60245 IEC 66 (1.5 mm<sup>2</sup> or more)
- When connecting the connecting wire to the outdoor unit terminal, prevent water from coming into the outdoor unit.
- Secure the power supply wire and indoor/outdoor connecting wires using the cord clamp of the outdoor unit.
- For interconnecting wires, do not use a wire joined to another on the way.  
Use wires long enough to cover the entire length.
- Wiring connections differ in conformance to EMC standards, depending whether the system is twin, triple or double twin. Connect wires according to respective instructions.

## ⚠ CAUTION

- An installation fuse must be used for the power supply line of this air conditioner.
- Incorrect/incomplete wiring may lead to an electrical fire or smoke.
- Prepare an exclusive power supply for the air conditioner.
- This product can be connected to the mains power.  
Fixed wire connections:  
A switch that disconnects all poles and has a contact separation of at least 3 mm must be incorporated in the fixed wiring.

## Wiring diagram

- For details on the remote controller wiring/installation, refer to the Installation Manual enclosed with the remote controller.

### Simultaneous twin system

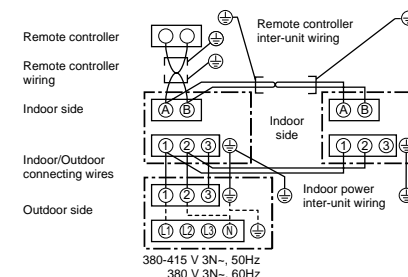

### Simultaneous triple and double twin system

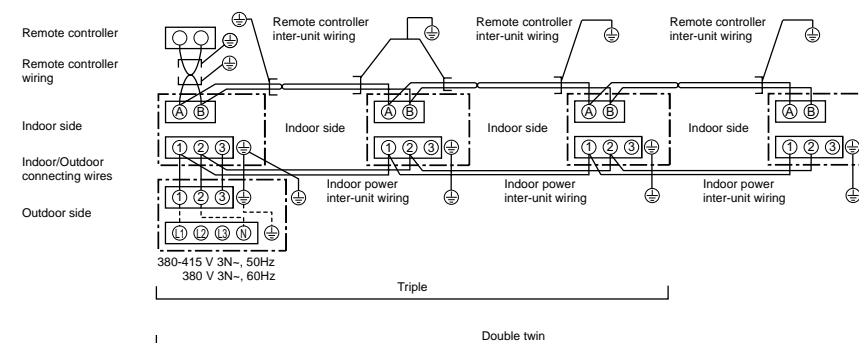

- Use 2-core shield wire (MVVS 0.5 to 2.0 mm<sup>2</sup> or more) for the remote controller wiring in the simultaneous twin, simultaneous triple and simultaneous double twin systems to prevent noise problems. Be sure to connect both ends of the shield wire to earth leads.
- Connect earth wires for each indoor unit in the simultaneous twin, simultaneous triple and simultaneous double twin systems.

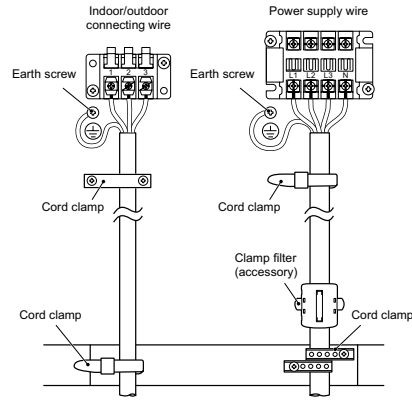

**⚠ WARNING**

Be sure to attach the provided clamp filter to the power supply wire in order to conform to EMC standards.

## 8 EARTHING

**⚠ WARNING**

- **Be sure to connect the earth wire. (grounding work)**  
Incomplete grounding may cause an electric shock.

Connect the earth line properly following applicable technical standards. Connecting the earth line is essential to preventing electric shock and to reducing noise and electrical charges on the outdoor unit surface due to the high-frequency wave generated by the frequency converter (inverter) in the outdoor unit. If you touch the charged outdoor unit without an earth line, you may experience an electric shock.

### Stripping length power cord and connecting wire

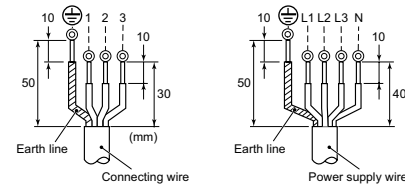

## 9 FINISHING

After the refrigerant pipe, inter-unit wires, and drain pipe have been connected, cover them with finishing tape and clamp them to the wall with off-the-shelf support brackets or their equivalent. Keep the power wires and indoor/outdoor connecting wires off the valve on the gas side or pipes that have no heat insulator.

## 10 TEST RUN

- **Turn on the leakage breaker at least 12 hours before starting a test run to protect the compressor during startup.**  
To protect the compressor, power is supplied from the 380-415 VAC input to the unit to preheat the compressor.
- **Check the following before starting a test run:**
  - **That all pipes are connected securely without leaks.**
  - **That the valve is open.**  
If the compressor is operated with the valve closed, the outdoor unit will become overpressurized, which may damage the compressor or other components.  
If there is a leak at a connection, air can be sucked in and the internal pressure further increases, which may cause a burst or injury.
- Operate the air conditioner in the correct procedure as specified in the Owner's Manual.

## 11 ANNUAL MAINTENANCE

- For an air conditioning system that is operated on a regular basis, cleaning and maintenance of the indoor/outdoor units are strongly recommended.  
As a general rule, if an indoor unit is operated for about 8 hours daily, the indoor/outdoor units will need to be cleaned at least once every 3 months. This cleaning and maintenance should be carried out by a qualified service person. Failure to clean the indoor/outdoor units regularly will result in poor performance, icing, water leaking and even compressor failure.

## 12 AIR CONDITIONER OPERATING CONDITIONS

For proper performance, operate the air conditioner under the following temperature conditions:

Cooling operation	Dry valve temp.	-15°C to 46°C
Heating operation	Wet valve temp.	-20°C to 15°C

If air conditioner is used outside of the above conditions, safety protection may work.

## 13 FUNCTIONS TO BE IMPLEMENTED LOCALLY

### ■ Handling Existing Pipe

When using the existing pipe, carefully check for the following:

- Wall thickness (within the specified range)
- Scratches and dents
- Water, oil, dirt, or dust in the pipe
- Flare looseness and leakage from welds
- Deterioration of copper pipe and heat insulator
- Before recovering the refrigerant in the existing system, perform a cooling operation for at least 30 minutes.

### Cautions for using existing pipe

- Do not reuse a flare nut to prevent gas leaks. Replace it with the supplied flare nut and then process it to a flare.
- Blow nitrogen gas or use an appropriate means to keep the inside of the pipe clean. If discolored oil or much residue is discharged, wash the pipe.
- Check welds, if any, on the pipe for gas leaks.
- There may be a problem with the pressure resistance of the branching pipes of the existing piping. Replace them with branch pipes (sold separately).

When the pipe corresponds to any of the following, do not use it. Install a new pipe instead.

- The pipe has been opened (disconnected from indoor unit or outdoor unit) for a long period.
- The pipe has been connected to an outdoor unit that does not use refrigerant R22, R410A or R407C.
- The existing pipe must have a wall thickness equal to or larger than the following thicknesses.

Reference outside diameter (mm)	Wall thickness (mm)	Material
6.4	0.8	—
9.5	0.8	—
12.7	0.8	—
15.9	1.0	—
19.1	1.2	—
22.2	1.0	Half hard
28.6	1.0	Half hard

- Do not use any pipe with a wall thickness less than these thicknesses due to insufficient pressure capacity.

- When using a  $\varnothing 19.1$  mm gas pipe for the existing piping, set bit 3 of SW802 (switch for existing pipe) on the P.C. board of the outdoor unit to ON. In this case, the heating performance may be reduced depending on the outside air temperature and room temperature.

SW802	
When shipped from factory	When using existing pipe

### ■ Recovering Refrigerant

Use the refrigerant recovery equipment to recover the refrigerant.

## 14 TROUBLESHOOTING

You can perform fault diagnosis of the outdoor unit with the LEDs on the P.C. board of the outdoor unit in addition to using the check codes displayed on the wired remote controller of the indoor unit.

Use the LEDs and check codes for various checks. Details of the check codes displayed on the wired remote controller of the indoor unit are described in the Installation Manual of the indoor unit.

### Verifying current abnormal status

1. Check that DIP switch SW803 is set to OFF.
2. Jot down the states of LED800 to LED804. (Display mode 1)
3. Press SW800 for at least 1 second. The LED status changes to display mode 2.
4. Check the code whose display mode 1 equals the LED states jotted down and display mode 2 equals the current flashing status of LED800 to LED804 from the following table to identify the cause.

### Verifying an abnormal state in the past although the abnormal state no longer occurs

1. Set bit 1 of DIP switch SW803 to ON.
2. Jot down the states of LED800 to LED804. (Display mode 1)
3. Press SW800 for at least 1 second. The LED status changes to display mode 2.
4. Find an error whose display mode 1 equals the LED states jotted down and display mode 2 equals the current flashing states of LED800 to LED804 from the following table to identify the error.
  - An outside air temperature (TO) sensor error can be checked only while it occurs.

No.	Cause	Display mode 1					Display mode 2				
		D800	D801	D802	D803	D804	D800	D801	D802	D803	D804
1	Normal	●	●	●	●	●	●	●	●	●	●
2	Discharge (TD) sensor error	○	○	●	●	○	●	●	○	●	●
3	Heat exchanger (TE) sensor error	○	○	●	●	○	●	○	○	●	●
4	Heat exchanger (TL) sensor error	○	○	●	●	○	○	○	○	●	●
5	Outside air temperature (TO) sensor error	○	○	●	●	○	●	●	○	○	●
6	Suction (TS) sensor error	○	○	●	●	○	●	●	○	○	●
7	Heat sink (TH) sensor error	○	○	●	●	○	○	○	○	○	●
8	Outdoor temperature sensor (TE/TS) connection error	○	○	●	●	○	○	○	○	○	●
9	Outdoor EEPROM error	○	○	●	●	○	○	○	○	○	○
10	Compressor lock	●	●	○	●	○	○	●	●	●	●
11	Compressor lock	●	●	○	●	○	○	○	●	●	●
12	Current detection circuit error	●	●	○	●	○	○	○	●	●	●
13	Thermostat for compressor activated	●	●	○	●	○	●	○	○	●	●
14	Model data not set (on the service P.C. board)	●	○	○	●	○	○	○	○	○	●
15	MCU-MCU communication error	●	○	○	●	○	○	○	○	○	○
16	Discharge temperature error	○	○	○	●	○	○	○	●	●	●
17	Abnormal power (open phase detected or abnormal voltage)	○	○	○	●	○	○	○	○	○	●
18	Heat sink overheat	○	○	○	●	○	○	○	○	○	●
19	Gas leak detected	○	○	○	●	○	○	○	○	○	○
20	4-way valve reverse error	○	○	○	●	○	○	○	○	○	○
21	High pressure release operation	○	○	○	●	○	○	○	○	○	○
22	Outdoor fan motor error	○	○	○	●	○	○	○	○	○	○
23	Compressor driver short-circuit protection	○	○	○	●	○	○	○	○	○	○
24	Position detection circuit error in one-line display	○	○	○	●	○	○	○	○	○	○
25	Ps sensor error	○	○	○	●	○	○	○	○	○	○
26	Ps drop down error	●	●	○	●	○	○	○	○	○	●

(●: OFF ○: ON ○: Flashing)

\* The LEDs and DIP switches are located on the lower left of the P.C. board of the outdoor unit.

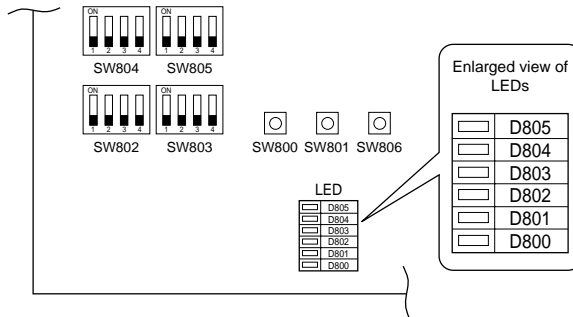

# 15 APPENDIX

## Work instructions

The existing R22 and R407C piping can be reused for our digital inverter R410A product installations.

### ⚠ WARNING

Confirming the existence of scratches or dents on the existing pipes and confirming the reliability of the pipe strength are conventionally referred to the local site.

### Basic conditions needed to reuse existing pipes

Check and observe the presence of three conditions in the refrigerant piping works.

1. **Dry** (There is no moisture inside of the pipes.)
2. **Clean** (There is no dust inside of the pipes.)
3. **Tight** (There are no refrigerant leaks.)

### Restrictions for use of existing pipes

In the following cases, the existing pipes should not be reused as they are. Clean the existing pipes or exchange them with new pipes.

1. When a scratch or dent is heavy, be sure to use new pipes for the refrigerant piping works.
2. When the existing pipe thickness is thinner than the specified "Pipe diameter and thickness," be sure to use new pipes for the refrigerant piping works.
  - The operating pressure of R410A is high (1.6 times that of R22 and R407C). If there is a scratch or dent on the pipe or a thinner pipe is used, the pressure strength may be inadequate, which may cause the pipe to break in the worst case.

### \* Pipe diameter and thickness (mm)

Reference outside diameter (mm)	Wall thickness (mm)	Material
6.4	0.8	—
9.5	0.8	—
12.7	0.8	—
15.9	1.0	—
19.1	1.2	—
22.2	1.0	Half hard
28.6	1.0	Half hard

3. When the outdoor unit was left with the pipes disconnected, or the gas leaked from the pipes and the pipes were not repaired and refilled.
  - There is the possibility of rain water or air, including moisture, entering the pipe.
4. When refrigerant cannot be recovered
  - There is the possibility that a large quantity of dirty oil or moisture remains inside the pipes.
5. When a commercially available dryer is attached to the existing pipes
  - There is the possibility that copper green rust has been generated.

6. When the existing air conditioner is removed after refrigerant has been recovered. Check if the oil is judged to be clearly different from normal oil.
  - The refrigerator oil is copper rust green in color: There is the possibility that moisture has mixed with the oil and rust has been generated inside the pipe.
  - There is discolored oil, a large quantity of residue, or a bad smell.
  - A large quantity of shiny metal dust or other wear residue can be seen in the refrigerant oil.
7. When the air conditioner has a history of the compressor failing and being replaced.
  - When discolored oil, a large quantity of residue, shiny metal dust, or other wear residue or mixture of foreign matter is observed, trouble will occur.
8. When temporary installation and removal of the air conditioner are repeated such as when leased etc.
9. If the type of refrigerant oil of the existing air conditioner is other than the following oil (Mineral oil, Suniso, Freol-S, MS (Synthetic oil), alkyl benzene (HAB, Barrel-freeze), ester series, PVE only of ether series.
  - The winding-insulation of the compressor may deteriorate.

### NOTE

The above descriptions are results have been confirmed by our company and represent our views on our air conditioners, but do not guarantee the use of the existing pipes of air conditioners that have adopted R410A in other companies.

### Branching pipe for simultaneous operation system

- In the concurrent twin system, when TOSHIBA has specified that branching pipe is to be used, it can be reused.  
Branching pipe model name: RBC-TWP30E2, RBC-TWP50E2, RBC-TRP100E  
On the existing air conditioner for simultaneous operation system (twin, triple, double twin system), there are cases of branch pipes being used that have insufficient compressive strength.  
In such case, please change the piping to a branch pipe for R410A.

### Curing of pipes

When removing and opening the indoor or outdoor unit for a long time, cure the pipes as follows:

- Otherwise rust may be generated when moisture or foreign matter due to condensation enters the pipes.
- The rust cannot be removed by cleaning, and new pipes are necessary.

Placement location	Term	Curing manner
Outdoors	1 month or more	Pinching
	Less than 1 month	
Indoors	Every time	Pinching or taping

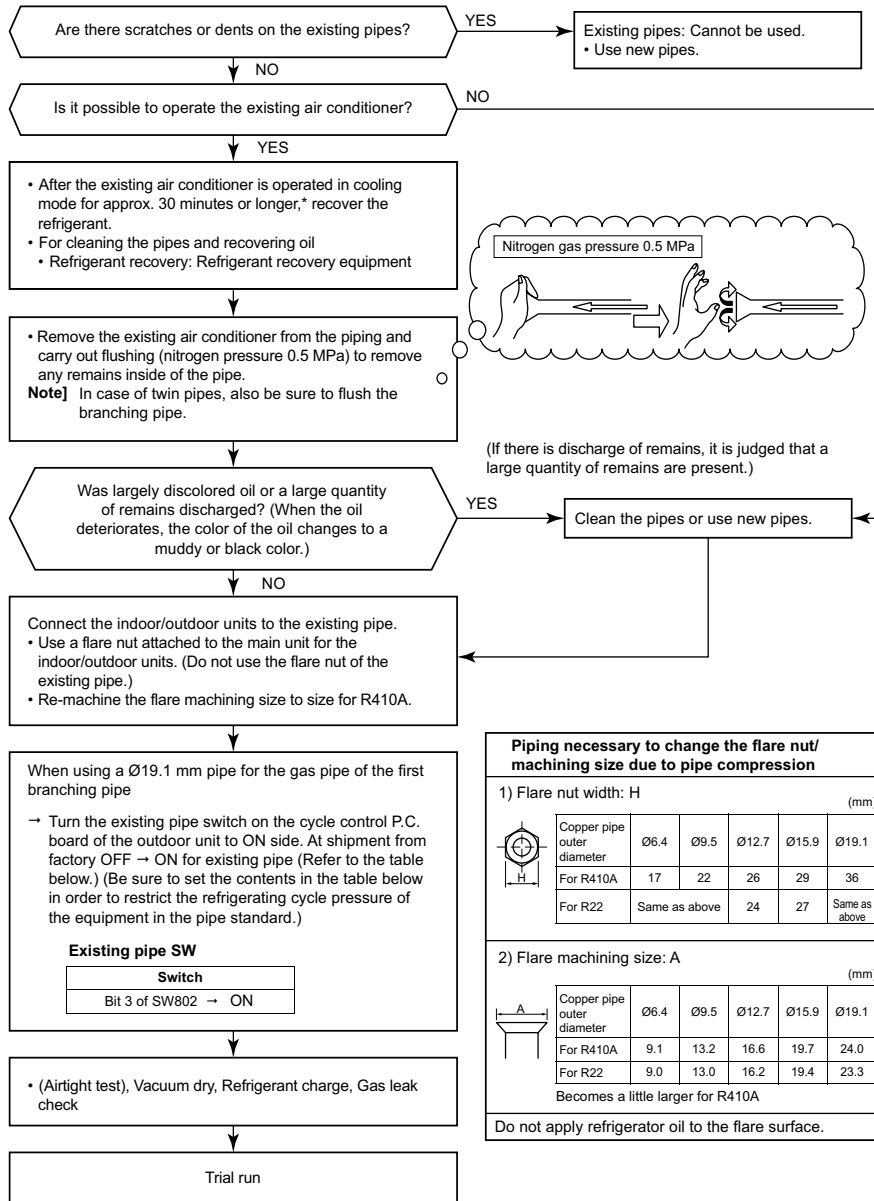

**Piping necessary to change the flare nut/ machining size due to pipe compression**

1) Flare nut width: H (mm)

	Copper pipe outer diameter	Ø6.4	Ø9.5	Ø12.7	Ø15.9	Ø19.1
	For R410A	17	22	26	29	36
	For R22	Same as above	24	27	Same as above	

2) Flare machining size: A (mm)

	Copper pipe outer diameter	Ø6.4	Ø9.5	Ø12.7	Ø15.9	Ø19.1
	For R410A	9.1	13.2	16.6	19.7	24.0
	For R22	9.0	13.0	16.2	19.4	23.3

Becomes a little larger for R410A

Do not apply refrigerator oil to the flare surface.

## 12. REPLACEMENT OF THE SERVICE P.C. BOARD (4316V392) MCC-1599

### 1. Setting the jumper wires and DIP switches

Part name		Function	Setting
Jumper wire	J800 to J803	Model switching	Cut these jumper wires according to the following table.
	J804 to J811	Settings	Set these jumper wires to the settings of the P.C. board before replacement
DIP switch	SW802	Settings	Set SW802 to the setting of the P.C. board before replacement
	SW803	LED indication switching	Set SW803 to all OFF.
	SW804	Special operations for service	Set SW804 to all OFF
	SW805	Special operations for service	Set SW805 to all OFF

### Model switching (J800 to J803)

Since this service P.C. board is available for several models, cut the jumper wires according to the following table.

If they are not cut correctly, an error code "L10" or "L29" appears on the remote controller and the operation of the air conditioner is disabled.

Model name	J 800	J 801	J 802	J 803
Factory setting (default)	○	○	○	○
RAV-SM2244AT8*-E	×	○	○	○
RAV-SM2804AT8*-E	○	×	○	○
* : Characters that indicate the following No. character : Standard models Z : For salt-affected areas ZG : For heavily salt-affected areas	○ : Connected, × : Cut			

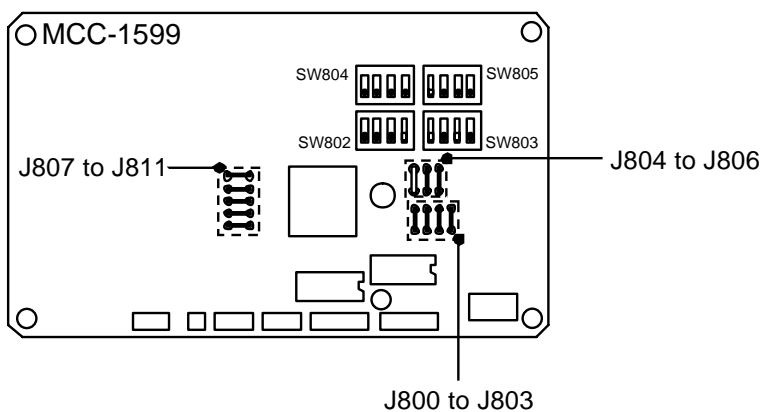

## 13. HOW TO EXCHANGE COMPRESSOR

### 13-1. Exchanging Procedure of Compressor (Outline)

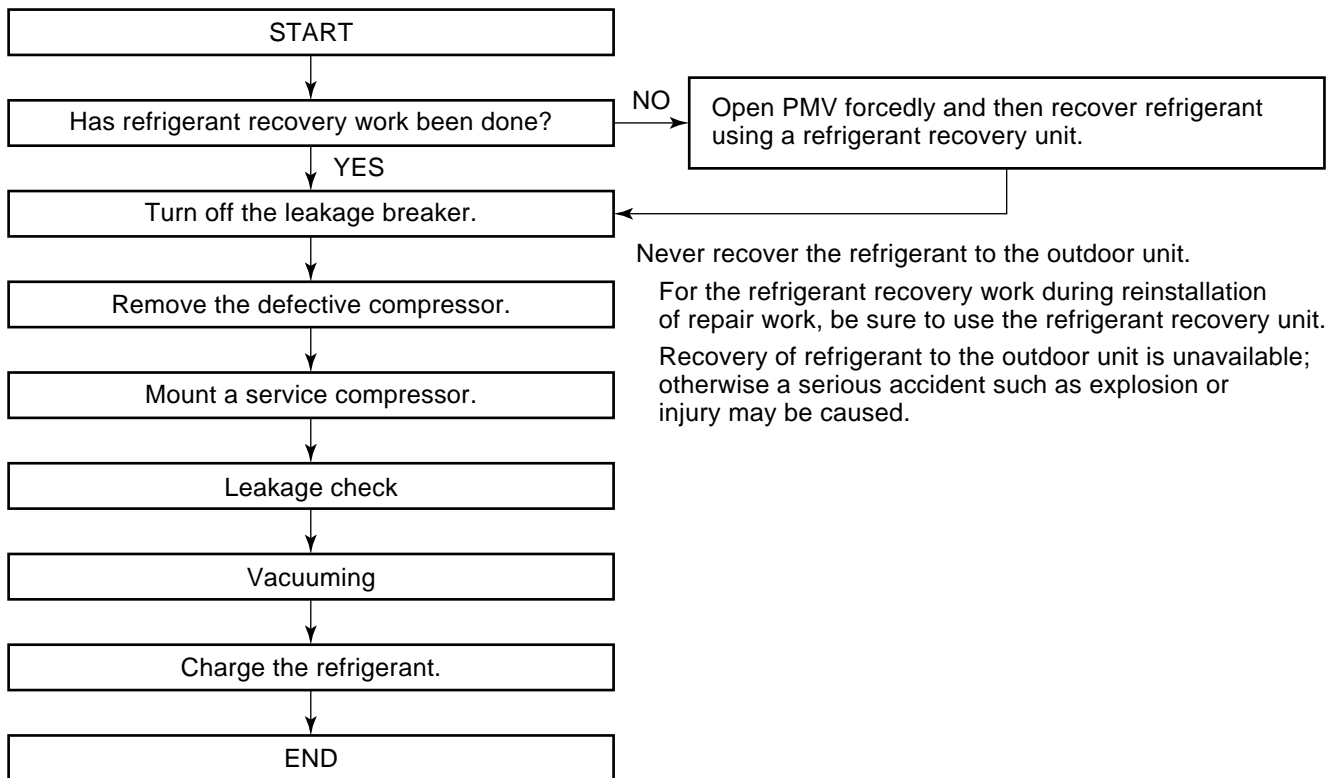

### 13-2. Exchange of Compressor

For exchange of compressors, refer to (11) Compressor in Section 14. **Detachments.**

## 14. DETACHMENTS

### 14-1. Outdoor Unit

#### RAV-SM224, RAV-SM280 series



No.	Part name	Procedure	Remarks
①	Common procedure	<p style="text-align: center;"><b>⚠ WARNING</b></p> <p>Stop operation of the air conditioner and turn off breaker switch.</p> <hr/> <p style="text-align: center;"><b>⚠ CAUTION</b></p> <p>Ensure wearing of gloves when performing any work in order to avoid injury from parts, etc.</p> <hr/> <p><b>1. Detachment</b></p> <ol style="list-style-type: none"> <li>1) Remove the service panel. (Hexagonal screws <math>\text{Ø}4 \times 10</math>, 3 pcs.) <ul style="list-style-type: none"> <li>• Remove the screws and then pull service panel downward to remove.</li> </ul> </li> <li>2) Remove the power supply cable and the indoor/outdoor connecting wire from the cord clamp and the terminal.</li> <li>3) Remove the top plate. (Hexagonal screws <math>\text{Ø}4 \times 10</math>, 6 pcs.)</li> </ol> <p><b>2. Attachment</b></p> <ol style="list-style-type: none"> <li>1) Attach the top plate. (Hexagonal screws <math>\text{Ø}4 \times 10</math>, 6 pcs.)</li> <li>2) Connect the power supply cable and the indoor/outdoor connecting wire to the terminal and then fix with the cord clamp.</li> </ol> <hr/> <p style="text-align: center;"><b>⚠ CAUTION</b></p> <p>The power supply cable and the indoor/outdoor connecting wire must be affixed along the crossover pipe using a commercially available bundling band so that they do not make contact with the compressor, gas valve, gas pipe and discharge pipe.</p> <hr/> <ol style="list-style-type: none"> <li>3) Attach the front panel. (Hexagonal screws <math>\text{Ø}4 \times 10</math>, 3 pcs.)</li> </ol>	<p>Service panel</p> <p>Top plate</p>
②	Discharge port cabinet (upper)	<p><b>1. Detachment</b></p> <ol style="list-style-type: none"> <li>1) Carry out the operation in 1. of ① above.</li> <li>2) Remove screws for the discharge port cabinet and the inverter assembly. (ST1T <math>\text{Ø}4 \times 8</math>, 2 pcs.)</li> <li>3) Remove screws for the discharge port cabinet and the discharge cabinet. (Hexagonal screw <math>\text{Ø}4 \times 10</math>, 2 pcs.)</li> <li>4) Remove screw for the discharge cabinet and heat exchanger. (ST1T <math>\text{Ø}4 \times 8</math>, 1 pc.)</li> <li>5) Remove screw for the discharge port cabinet and the fin guard. (Hexagonal screw <math>\text{Ø}4 \times 10</math>, 1 pc.)</li> </ol> <p><b>2. Attachment</b></p> <ol style="list-style-type: none"> <li>1) Place upper left side of discharge cabinet on upper side of end board of heat exchanger and fix with a screw. (ST1T <math>\text{Ø}4 \times 8</math>, 1 pc.)</li> <li>2) Mount other removed screws into original positions.</li> </ol>	<p>Setting moment</p> <p>Upper end plate of heat exchanger</p> <p>Discharge port cabinet (upper)</p> <p>Fin guard</p> <p>Inverter Ass'y</p> <p>Discharge port cabinet</p> <p>Heat exchanger</p>

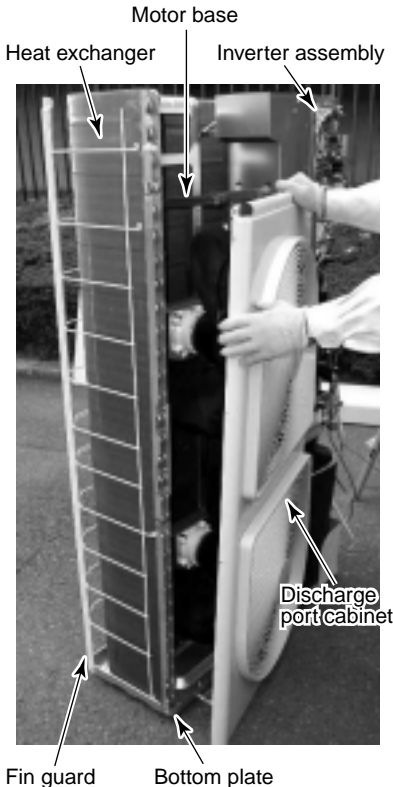
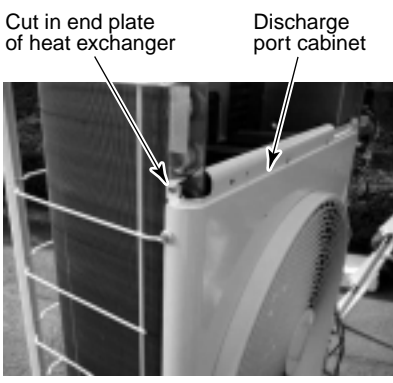

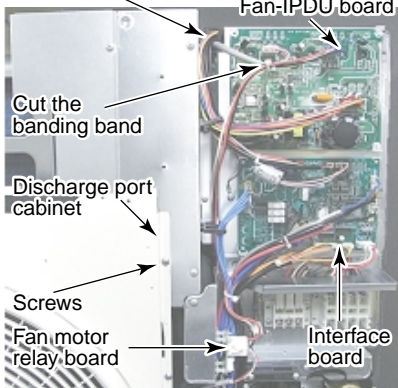
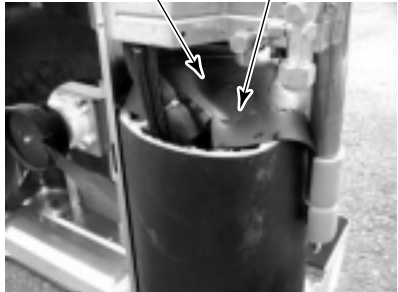
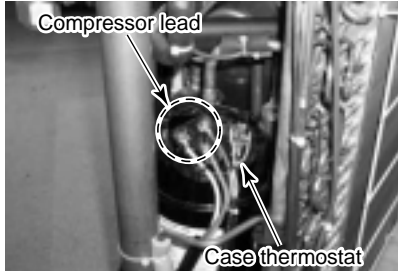
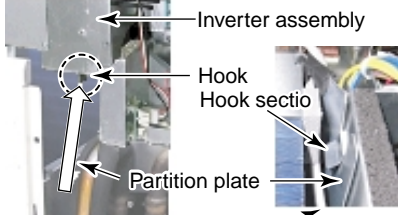
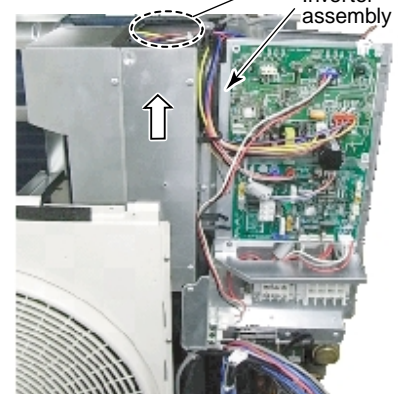

No.	Part name	Procedure	Remarks
③	Discharge port cabinet	<p><b>1. Detachment</b></p> <ol style="list-style-type: none"> <li>1) Carry out the operation in 1. of ① and 1. of ② above.</li> <li>2) Remove the screws fixing the inverter assembly, the discharge port cabinet and the partition board. (ST1T Ø4 × 8, 4 pcs.)</li> <li>3) Remove the screws for the discharge port cabinet and the bottom plate. (Hexagonal screw Ø4 × 10, 2 pcs.)</li> <li>4) Remove screw for the discharge port cabinet and heat exchanger. (ST1T Ø4 × 8, 1 pc.)</li> <li>5) Remove screw for the discharge port cabinet and the motor base. (ST1T Ø4 × 8, 2 pcs.)</li> <li>6) Remove screws for the discharge port cabinet and the fin guard. (Hexagonal screw Ø4 × 10, 2 pcs.)</li> </ol> <p><b>2. Attachment</b></p> <ol style="list-style-type: none"> <li>1) Place upper left side of discharge cabinet in cut on upper side of end board of heat exchanger and fix with a screw. (ST1T Ø4 × 8, 1 pc.)</li> <li>2) Mount other removed screws into original positions.</li> </ol>	 

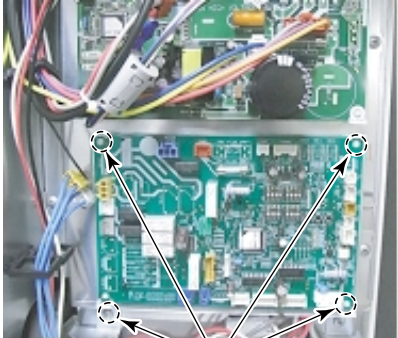
No.	Part name	Procedure	Remarks
④	Side cabinet	<p><b>1. Detachment</b></p> <ol style="list-style-type: none"> <li>1) Carry out the operation in 1. of ① and 1. of ② above.</li> <li>2) Remove the screws fixing the inverter assembly and the side cabinet. (ST1T Ø4 × 10, 3 pcs.)</li> <li>3) Remove the screws for the side cabinet and the valve fixing plate. (ST1T Ø4 × 10, 2 pcs.)</li> <li>4) Remove screw for the side cabinet and piping panel (rear). (Hexagonal screw Ø4 × 10, 1 pc.)</li> <li>5) Remove screw for the side cabinet and the bottom plate. (Hexagonal screw Ø4 × 10, 1 pc.)</li> <li>6) Remove screws for the side cabinet, heat exchanger and the fin guard. (Hexagonal screw Ø4 × 10, 4 pcs.)</li> <li>7) Remove the screw of the holder fixing plate and the side cabinet (C type Ø4 × 8, 1 pc)</li> </ol> <p><b>2. Attachment</b></p> <ol style="list-style-type: none"> <li>1) Temporarily suspend the side cabinet on the inverter assembly using the hook.</li> <li>2) Mount the removed screws in the opposite procedure to that during detachment.</li> </ol>	<p>The diagram illustrates the process of removing and reattaching the side cabinet. In the upper section, the side cabinet is shown being detached from the main unit. Labels indicate the 'Side cabinet', 'C Type screw (seriation)', 'Holder fixing plate', 'Fin grad', 'Heat exchanger', 'Bottom plate', 'Piping panel (rear)', and 'Inverter Ass'y'. In the lower section, the side cabinet is shown being attached to the inverter assembly using a 'Hook'. Labels include 'Inverter Ass'y', 'Hook', and 'Valve fixing plate'.</p>

No.	Part name	Procedure	Remarks
⑤	Inverter assembly	<p><b>1. Detachment</b></p> <ol style="list-style-type: none"> <li>1) Carry out the operation in 1. of ①, 1. of ② and 1. of ④ above.</li> <li>2) Remove the connectors connected to the fan motor relay board and the Fan IPDU board, the connector connected to other components from the control board (Interface board).            CN600: TS sensor (3P: White, tube: Gray)            CN601: TE sensor (2P: White, tube: Blue)            CN602: TO sensor (2P: Orange, tube: Black)            CN603: TD sensor (3P: White, tube: Red)            CN604: TL sensor (2P: White, tube: White)            CN606: Pressure sensor (4P: White)            CN609: Case thermo. (2P: Blue)            CN690: High pressure switch (3P: Green)            CN700: 4-way coil (2P: Yellow)            CN702: 2-way valve coil (3P: White)            CN710: PMV coil 1 (6P: White)            CN711: PMV coil 2 (6P: White)</li> <li>• Fan IPDU board            CN750: Outdoors fan motor (3P: White)            Cut the banding band and remove connector connected from fan motor to fan motor relay board.</li> <li>• Fan motor relay board            CN08 : Outdoors fan motor (3P: White)            * Remove connectors after unlocking housing section</li> <li>3) Remove the screw (1 position) fixing the discharge port cabinet.</li> <li>4) Cut bundling band fixing various lead lines to inverter assembly.</li> <li>5) Remove water-proof sheet (rubber sheet) and sound-insulation plate (upper).</li> <li>6) Remove terminal cover of compressor and remove compressor lead.</li> <li>7) Pull up the inverter assembly at upper side to remove hook of partition plate (rear left part).</li> </ol> <p><b>2. Attachment</b></p> <ol style="list-style-type: none"> <li>1) Mount the inverter assembly on the partition plate.</li> </ol> <hr/> <p style="text-align: center;"><b>⚠ CAUTION</b></p> <p>When mounting the inverter assembly on the partitioning plate, ensure proper mounting of the hook (rear left part) with partitioning plate.</p> <hr/> <ol style="list-style-type: none"> <li>2) Mount the individual components in the opposite procedure to that during detachment.</li> </ol>	<p>Remove the fan motor lead wire from the cord clamp.</p>  <p>Water-proof sheet (rubber sheet)    Sound-insulation board (upper)</p>  <p>Compressor lead    Case thermostat</p>  <p>Inverter assembly    Hook    Hook section    Partition plate</p>  <p>Inverter assembly</p> 

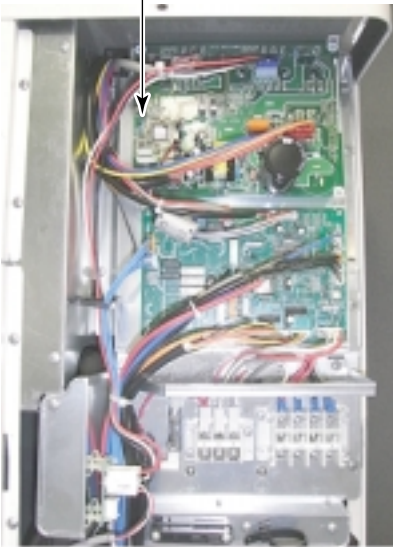
No.	Part name	Procedure	Remarks
⑥	Interface board (Control board) MCC-1599	<p><b>1. Detachment</b></p> <p>1) Carry out the operation in 1. of ①, 1. of ② and 1. of ④ above.</p> <p>2) Remove lead wires and connectors to other components from the interface board (control board).</p> <p>CN603: TD sensor (3P: White, tube: Red)            CN602: TO sensor (2P: Orange, tube: Black)            CN601: TE sensor (2P: Green, tube: Blue)            CN600: TS sensor (3P: White, tube: Gray)            CN604: TL sensor (2P: White, tube: White)            CN700: 4-way coil (2P: Yellow)            CN710: PMV coil 1 (6P: White)            CN711: PMV coil 2 (6P: White)            CN702: 2-way coil (3P: White)            CN606: Pressure sensor (4P: White)            CN690: High pressure switch (3P: Green)            CN802: Connection with Fan IPDU board (5P: white)            CN609: Case thermo.(2P :Blue)            CN708: Magnet switch (2P: Blue)            CN608: Connection with noise filter board (2P: White)            CN01 : Indoor/Outdoor connection terminal (5P: White)            CN02 : Power relay (3P: Red)</p> <p>* Remove connectors after unlocking housing section</p> <p>3) Remove the claws of the supports (4 positions) fixing the board and remove the interface board (Control board).</p> <p><b>2. Attachment</b></p> <p>1) Mount the interface board (Control board).</p> <p>2) Mount the individual components in the opposite procedure to that during detachment.</p>	 <p>Interface board (Control board)</p>  <p>Support (4 positions)</p>  <p>State of control board when removed</p>

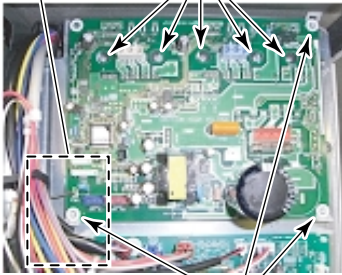
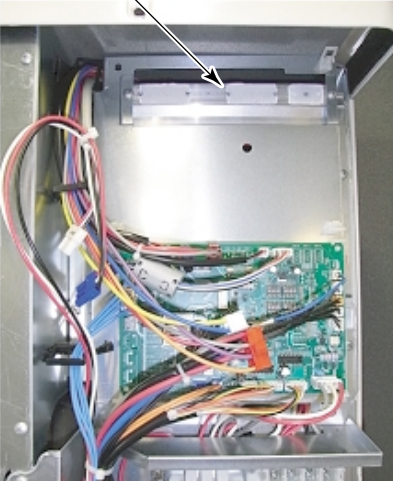
No.	Part name	Procedure	Remarks
⑦	Fan-IPDU board MCC-1597	<p><b>1. Detachment</b></p> <ol style="list-style-type: none"> <li>1) Carry out the operation in 1. of ①, 1. of ② and 1. of ④ above.</li> <li>2) Remove lead wires and connectors to other components from the Fan-IPDU board.            CN700: Relay connector (3P, Blue)            CN750: Outdoor fan motor (3P, White)            CN500: Connection between reactor and noise filter board (7P, Red)            CN502: Compressor IPDU board (3P, White)            CN602: Noise filter board (2P, White)            CN504: Interface board (5P, Blue)            CN505: Compressor IPDU board (5P, Red)</li> </ol> <p>* Connectors should be removed after unlocking the housing section.</p> <ol style="list-style-type: none"> <li>3) Remove screw fixing the earth wire.</li> <li>4) Remove the claw of the support (3 positions) fixing the board and the screw (5 positions) fixing the heat sink and then remove the Fan-IPDU board.</li> </ol> <p><b>2. Attachment</b></p> <ol style="list-style-type: none"> <li>1) Mount Fan-IPDU board</li> <li>2) Mount components in the opposite method to that when removing.</li> </ol>	<p>FAN-IPDU board</p>  <p>Earth wire</p>  <p>Screw</p> <p>Screw (5 positions)</p>  <p>Support (3 positions)</p> <p>Heat sink</p>  <p>State of Fan-IPDU board when removed</p>

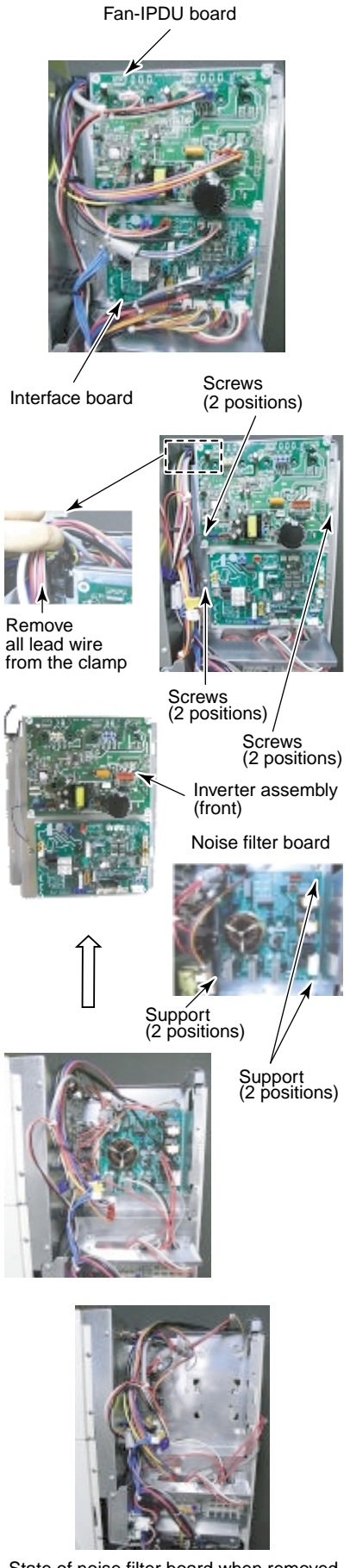
No.	Part name	Procedure	Remarks
⑧	Noise filter board MCC-1600	<p><b>1. Detachment</b></p> <ol style="list-style-type: none"> <li>1) Perform the operation in 1. of ①, 1. of ②, 1. of ④, 1.-2 of ⑥ and 1.-2 of ⑦.</li> <li>2) Remove the screws (4 positions) fixing the inverter assembly (front) to remove the lead wires from the upper left clamp. Then slide the inverter assembly (front) upwardly and remove.</li> <li>3) Remove the lead wires connector to other components from the noise filter board.</li> </ol> <p>CN05: Power supply terminal block (red)            CN06: Power supply terminal block (White)            CN07: Power supply terminal block (Black)            CN24: Power supply terminal block (White)            CN08: Power supply terminal block (Gray)            CN09: Connection to earth (Brown)            CN50: Interface board (2P, White)            CN51: Fan-IPDU board (2P, Back)            CN10: Posister (Red)            CN16: Relay (Red)            CN17: Compressor IPDU board (White)            CN18: Relay (Black)            CN19: Relay (Gray)            CN23: Fan-IPDU board (5P, Red)</p> <p>* Connectors should be removed after unlocking the housing section.</p> <ol style="list-style-type: none"> <li>4) Remove the claw of the support (2 positions) and the screw (2 positions) fixing the base and then remove the noise filter base.</li> </ol> <p><b>2. Attachment</b></p> <ol style="list-style-type: none"> <li>1) Mount noise filter board.</li> <li>2) Mount components in the opposite method to that when removing.</li> </ol>	 <p>Fan-IPDU board</p> <p>Interface board</p> <p>Screws (2 positions)</p> <p>Remove all lead wire from the clamp</p> <p>Screws (2 positions)</p> <p>Screws (2 positions)</p> <p>Inverter assembly (front)</p> <p>Noise filter board</p> <p>Support (2 positions)</p> <p>Support (2 positions)</p> <p>State of noise filter board when removed</p> <p><b>Temporary Suspended State of Inverter Assembly (front)</b></p> <p>Using the hook, it is possible to temporarily suspend the inverter assembly (front).</p> <p>Using the hook</p>

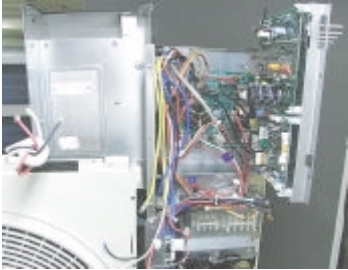
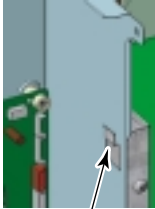
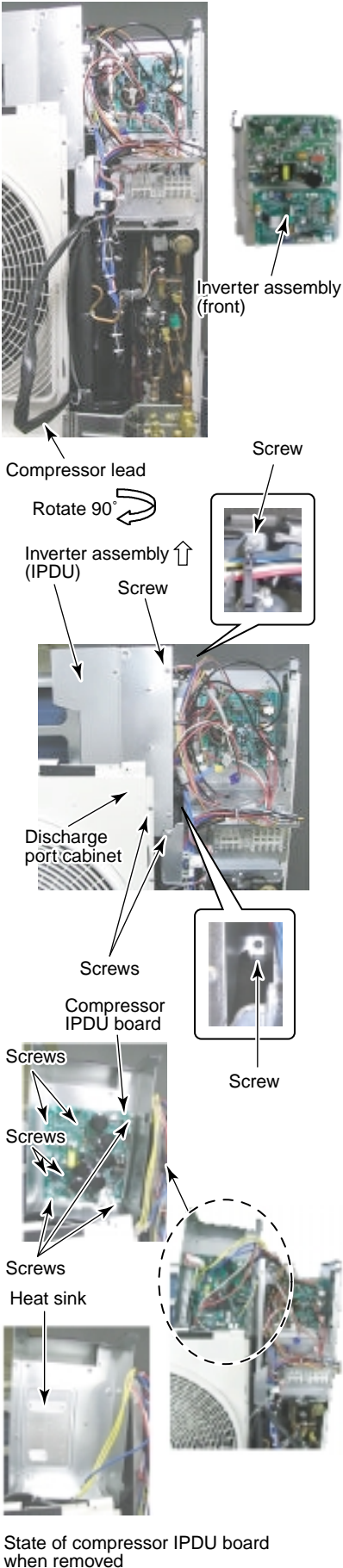
No.	Part name	Procedure	Remarks
⑨	Compressor IPDU board MCC-1596	<p><b>1. Detachment</b></p> <ol style="list-style-type: none"> <li>1) Carry out the operation in 1. of ①, 1. of ②, 1. of ④, 1. of ⑥, 1. of ⑦ and 1. of ⑧.</li> <li>2) Pull the compressor lead from the space in the partition plate.</li> <li>3) Remove the screw (1 position) fixing the discharge port cabinet and the screws (4r positions) fixing the inverter assembly (IPDU) and then remove the lead wire from the top clamp.</li> <li>4) Slide and remove the inverter assembly (IPDU), rotate through 90 degrees and place the base facing the front surface.</li> <li>5) Remove the lead wire and connector to other components from the compressor IPDU board.</li> </ol> <p>CN01: Relay (Red)  CN02: Noise filter board (White)  CN03: Relay (Black)  CN04: Posister (Red)  CN07: Power supply terminal block (Blue)  CN08: Power supply terminal block (Blue)  CN09: Power supply terminal block (Yellow)  CN10: Power supply terminal block (Yellow)  CN201: Compressor (Red)  CN202: Compressor (White)  CN203: Compressor (Black)  CN851: FAN-IPDU board (5P, Red)  CN101: FAN-IPDU board (3P, White)</p> <p>* Connectors should be removed after unlocking the housing section.</p> <ol style="list-style-type: none"> <li>6) Remove the screws (4 positions) fixing the heat sink and the screws (3 positions) fixing the compressor IPDU board and then remove the compressor IPDU board.</li> </ol> <p><b>2. Attachment</b></p> <ol style="list-style-type: none"> <li>1) Mount compressor IPDU board.</li> <li>2) Mount components in the opposite method to that when removing.</li> </ol> <div style="border: 1px dashed black; padding: 10px; margin-top: 20px;"> <p style="text-align: center;"><b>Temporary suspended state of Inverter Assembly (IPDU)</b></p> <div style="display: flex; justify-content: space-around;">   </div> <p>Using the hook, it is possible to temporarily suspend the inverter assembly (IPDU).      Using the hook</p> </div>	 <p style="text-align: center;">State of compressor IPDU board when removed</p>

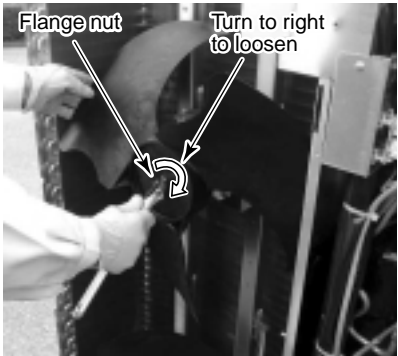
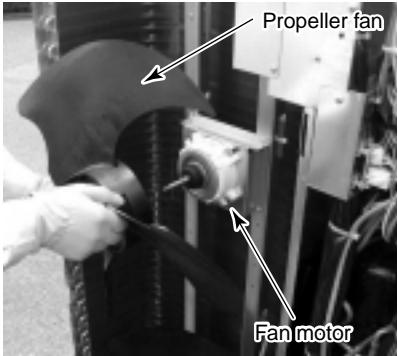
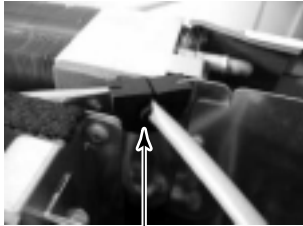
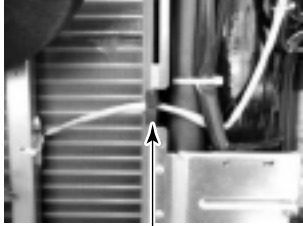
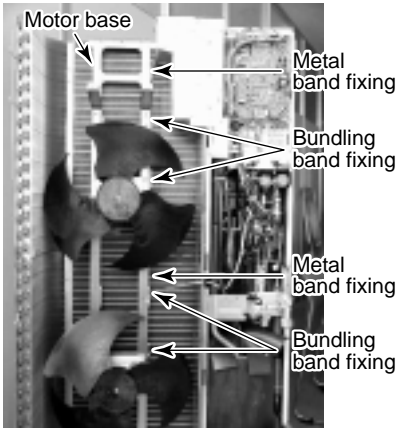
No.	Part name	Procedure	Remarks
⑩	Fan motor	<p><b>1. Detachment</b></p> <ol style="list-style-type: none"> <li>1) Carry out the operation in 1. of ① , 1. of ② and 1. of ③ above.</li> <li>2) Remove the flange nut fixing the fan motor and the propeller fan. <ul style="list-style-type: none"> <li>• The flange nut is loosened by turning to the right. (When tightening, turn it to the left)</li> </ul> </li> <li>3) Remove the propeller fan.</li> <li>4) Remove the connector for the fan motor from the inverter.</li> <li>5) Remove the fan motor lead from the fan motor lead fixing rubber member of the through section of the partitioning board.</li> <li>6) Remove the fixing screws (4 pieces) while supporting the fan motor so that it does not fall.</li> </ol> <p><b>2. Attachment</b></p> <ol style="list-style-type: none"> <li>1) Mount the fan motor.</li> <li>2) Mount the individual components in the opposite procedure to that during detachment <ul style="list-style-type: none"> <li>* Points to note when assembling fan motor <ul style="list-style-type: none"> <li>• Tighten the flange nut with <math>4.9\text{N}\cdot\text{m}</math> (<math>50\text{kgf}\cdot\text{cm}</math>).</li> <li>• Adjust length of the fan motor lead at the fan motor lead fixing rubber member so that the fan motor lead is not slack in order to avoid contact of the fan motor lead with the propeller fan.</li> </ul> </li> </ul> </li> </ol> <p>Attach the motor lead fixing rubber member to the partition board so that the projection is on the refrigerating cycle side.</p> <ul style="list-style-type: none"> <li>• Ensure that the heat exchanger does not come into contact with the fan motor lead.</li> </ul> <hr/> <p style="text-align: center;"><b>⚠ CAUTION</b></p> <p>Ensure affixation of the fan motor lead to the motor base using a metal band of the motor base and a commercially available bundling band so that the fan motor lead does not come to contact with the propeller fan.</p> <hr/>	   <p>Fan motor lead fixing rubber (upper) (mount so that the projection abuts with this side)</p>  <p>Fan motor lead fixing rubber (lower) (mount so that the projection abuts with this side)</p> 

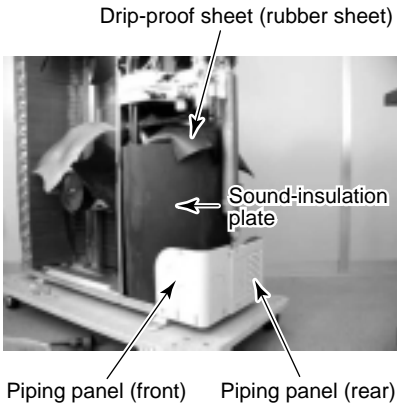
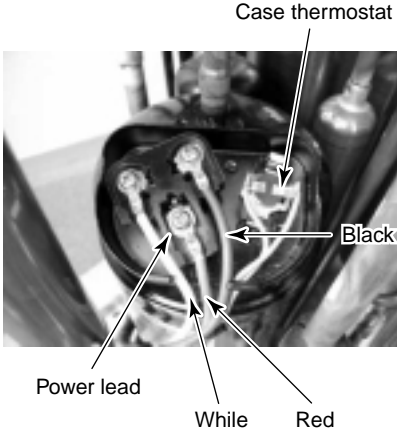
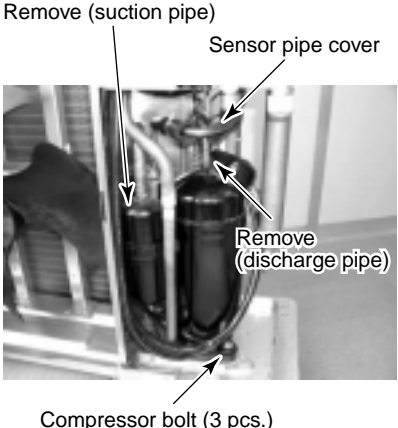

No.	Part name	Procedure	Remarks
⑪	Compressor	<p><b>1. Detachment</b></p> <ol style="list-style-type: none"> <li>1) Recover the refrigerant gas.</li> <li>2) Carry out the operation in 1. of ① and ④ above.</li> <li>3) Remove the piping panel (front). Remove the piping panel (front) and screws of the bottom plate. (Hexagonal screw Ø4 × 10, 2 pcs.) Remove screw of the piping panel (front) and the piping panel (rear). (Hexagonal screw Ø4 × 10, 1 pc.)</li> <li>4) Remove the piping panel (rear). Remove the piping panel (rear) and screws of the bottom plate. (Hexagonal screw Ø4 × 10, 2 pcs.)</li> <li>5) Remove the drip-proof sheet. (Rubber sheet)</li> <li>6) Remove the sound-insulation plate (upper, inner, outer).</li> <li>7) Remove the terminal cover of the compressor and then remove the compressor lead and the case thermostat.</li> </ol> <hr/> <p style="text-align: center;"><b>⚠ CAUTION</b></p> <ul style="list-style-type: none"> <li>• Ensure that the removed wiring terminals are always insulated with insulation tape.</li> <li>• The only wiring removed is the wiring for performing exchange of the compressor.</li> <li>• The power lead connection section of the compressor is a round terminal connection.</li> </ul> <hr/> <ol style="list-style-type: none"> <li>8) Remove the sensor pipe cover fixed to the discharge pipe.</li> <li>9) Using a burner, remove the discharge pipe and the suction pipe connected to the compressor.</li> </ol> <hr/> <p style="text-align: center;"><b>⚠ WARNING</b></p> <p>When removing the piping by broiling the welded part with a burner, ensure that there is no oil in the pipe in order to avoid the risk of fire with the melted wax.</p> <hr/> <ol style="list-style-type: none"> <li>10) Disengage the discharge pipe and the suction pipe of the refrigerating cycle upwardly.</li> <li>11) Remove the compressor nuts which fix the compressor to the bottom plate. (3 pcs.)</li> <li>12) Pull out the compressor toward you.</li> </ol> <hr/> <p style="text-align: center;"><b>⚠ CAUTION</b></p> <p>As the weight of the compressor is 20kg or more, it should be handled by 2 workers. When there is no oil in the compressor, the mass of the compressor is 22 kg.</p> <hr/>	 <p style="text-align: center;"><b>&lt;Compressor terminal&gt;</b></p>  

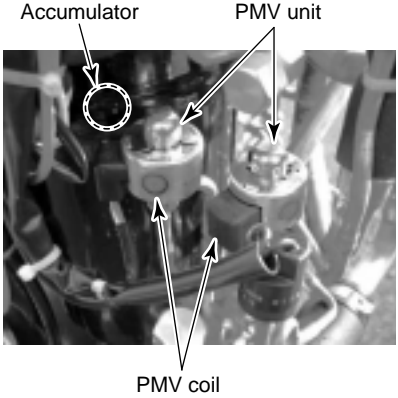
No.	Part name	Procedure	Remarks
⑪	Compressor (continued)	<p><b>2. Attachment</b></p> <p>1) Mount the compressor by reversing the procedure for removal.</p> <hr/> <p style="text-align: center;"><b>⚠ CAUTION</b></p> <p>The fixing torque for the hexagonal bolts fixing the compressor is 19.6N•m (200kgf•cm).</p> <hr/> <p><b>3. Vacuuming</b></p> <p>1) Connect the vacuum pump to the charge port and the high-pressure check joint of the liquid pipe and the gas pipe valve and then operate the vacuum pump.</p> <p>2) Carry out vacuuming until the vacuum low pressure gauge indicates 1 (mmHg).</p> <hr/> <p style="text-align: center;"><b>⚠ CAUTION</b></p> <p>Before vacuuming, open the pulse motor valve fully. If the pulse motor valve is closed, vacuuming may be impossible of the heat exchanger in the outdoor unit.</p> <hr/> <p><b>Forcible fully-opened method for the pulse motor valve</b></p> <ul style="list-style-type: none"> <li>• Turn on the breaker switch.</li> <li>• Short circuit CN300 on the interface board of the outdoor unit.</li> <li>• Turn off the breaker switch.</li> </ul> <p><b>4. Refrigerant charge</b></p> <p>1) Add a refrigerant amount determined by the pipe length from the charge port of the valve.</p> <hr/> <p style="text-align: center;"><b>⚠ CAUTION</b></p> <p>The water-proof sheet (rubber sheet) should be mounted so that water drops from the accumulator or the pipes do not come into contact with the terminal section of the compressor.</p> <hr/>	
⑫	Pulse motor valve (PMV) coil	<p><b>1. Detachment</b></p> <p>1) Carry out work of item 1. of ① and ④ above.</p> <p>2) Rotate the coil while pulling upwardly and then remove the coil from the pulse motor valve coil main unit.</p> <p><b>2. Attachment</b></p> <p>1) Surely match the positioning projection of the coil with the concave part of PMV main unit and then fix it.</p> <hr/> <p style="text-align: center;"><b>⚠ CAUTION</b></p> <p>Mount the coils or the coil carefully so that they do not make contact with the accumulator.</p> <hr/>	

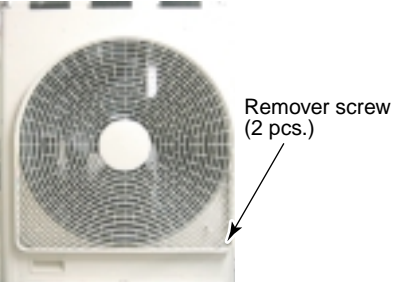
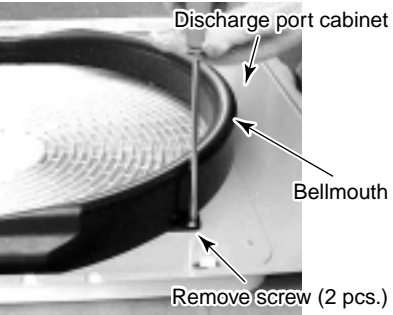
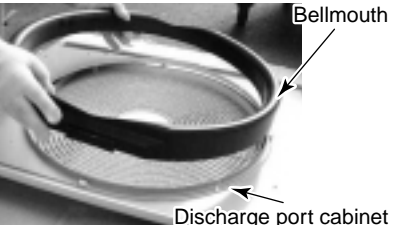
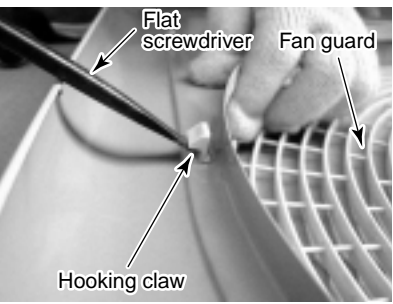
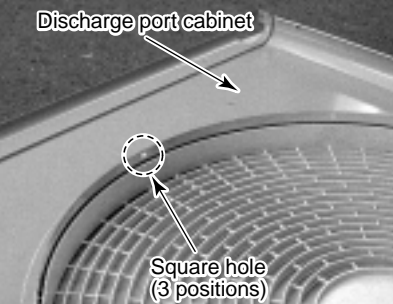
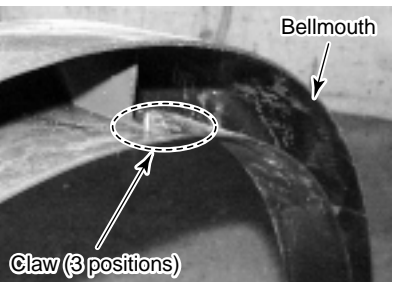
No.	Part name	Procedure	Remarks
⑬	Fan guard	<p><b>1. Detachment</b></p> <p>1) Carry out work of item 1. of ① and 1. of ③ above.</p> <hr/> <p style="text-align: center;"><b>⚠ CAUTION</b></p> <p>To prevent scratches to the product, carry out the work on cardboard, cloth, etc.</p> <hr/> <p>2) Remove the discharge port cabinet and place the fan guard side facing upwards.</p> <p>3) Remove the fixing screws for the fan guard. (Hexagonal screws Ø4 x 10, 2 pcs.)</p> <p>4) Remove the discharge port cabinet and then put on it so that the fan guard side faces downward.</p> <p>5) Remove the screws fixing the bellmouth. (ST1T Ø4 x 8, 2 pcs.)</p> <p>6) Remove bellmouth.</p> <p>7) Press and remove hooking claw of fan guard with a flat screwdriver.</p> <p><b>2. Attachment</b></p> <p>1) Press the projection on the upper side of the fan guard into the hole of the discharge cabinet and then push in the hooking claws. Fix the claws by using your hands to press the hooking claws (5 positions).</p> <hr/> <p style="text-align: center;"><b>⚠ CAUTION</b></p> <p>Check that all the hooking claws are fixed at the specified positions.</p> <hr/> <p>2) After mounting, fix the fan guard with screws. (Hexagonal screws Ø4 x 10, 2 pcs.)</p> <p>3) Attach and mount the claws (3 positions) on the upper side of the bellmouth in the square hole of the discharge cabinet.</p> <p>4) After mounting, fix with a screw. (ST1T Ø4 x 8, 2 pcs.)</p>	     

### 15. EXPLODED VIEWS AND PARTS LIST

#### 15-1. Outdoor Unit

RAV-SM2244AT8 (Z) (ZG) -E, RAV-SM2804AT8 (Z) (ZG) -E

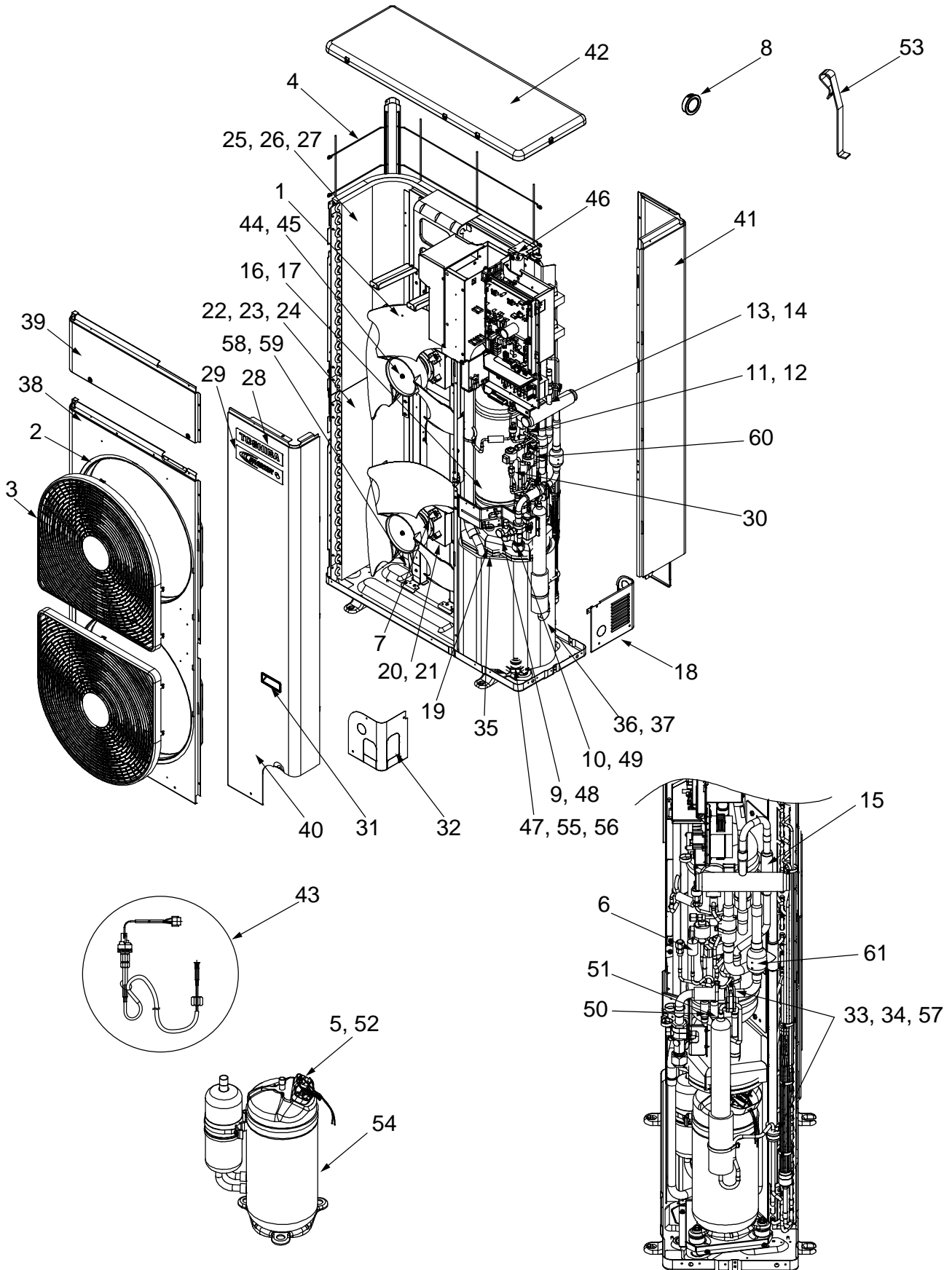

Location No.	Part No.	Description	Model name					
			RAV-SM2244			RAV-SM2804		
			AT8-E	AT8Z-E	AT8ZG-E	AT8-E	AT8Z-E	AT8ZG-E
1	43120224	Fan, Propeller, PE492	2	2	2	2	2	2
2	43122065	Bell Mouth	2	2	2	2	2	2
3	43191651	Guard, Fan	2	2	2	2	2	2
4	43100323	Guard, Fin	1	1	1	1	1	1
5	43050407	Thermostat, Bimetal	1	1	1	1	1	1
6	43151301	Switch, Pressure	1	1	1	1	1	1
7	4312C037	Motor, Fan, ICF-280-A100-1	2	2	2	2	2	2
8	4316V135	Bush	1	1	1	1	1	1
9	43146680	Valve, Packed, 12.7	1	1	1	1	1	1
10	43146725	Valve, Ball, SBV-JA6GTC-1	1	1	1	1	1	1
11	43146700	Valve, 2-way, VPV-603D	1	1	1	1	1	1
12	37546847	Coil, Solenoid, 2-way, AC220-240V	1	1	1	1	1	1
13	43146722	Coil, Solenoid, STF-01AJ502E1	1	1	1	1	1	1
14	43146698	Valve, 4-way, STF-0731G	1	1	1	1	1	1
15	43146734	Valve, Check, ZGV-S55B-A	1	1	1	1	1	1
16	43148208	Accumulator	1	1		1	1	
17	43148209	Accumulator			1			1
18	43100345	Panel, Back, Piping	1	1	1	1	1	1
19	43111337	Rubber	1	1	1	1	1	1
20	43122095	Base Ass'y, Motor	1			1		
21	43122105	Base Ass'y, Motor		1	1		1	1
22	4314G187	Condenser Ass'y, Lower	1			1		
23	4314G188	Condenser Ass'y, Lower		1			1	
24	4314G189	Condenser Ass'y, Lower			1			1
25	4314G191	Condenser Ass'y, Up	1			1		
26	4314G192	Condenser Ass'y, Up		1			1	
27	4314G193	Condenser Ass'y, Up			1			1
28	4301P703	Mark, TOSHIBA	1	1	1	1	1	1
29	4301P729	Mark, Inverter	1	1	1	1	1	1
30	43146676	Joint, Check	2	2	2	2	2	2
31	43119390	Hanger	3	3	3	3	3	3
32	43100347	Panel, Front, Piping	1	1	1	1	1	1
33	43149318	Rubber, Supporter, Pipe, DIA 19.0	2	2	2	2	2	2
34	43149320	Rubber, Supporter, Pipe, DIA 8.0	2	2	2	2	2	2
35	43111334	Insulator, Sound, Up	1	1	1	1	1	1
36	43111335	Insulator, Sound, In	1	1	1	1	1	1
37	43111336	Insulator, Sound, Out	1	1	1	1	1	1
38	43100329	Cabinet Ass'y, Out	1	1	1	1	1	1
39	43100332	Cabinet Ass'y, Up	1	1	1	1	1	1
40	43100335	Cabinet Ass'y, Front	1	1	1	1	1	1
41	43100338	Panel Ass'y, Side	1	1	1	1	1	1
42	43100341	Cabinet Ass'y, Top	1	1	1	1	1	1
43	43150321	Sensor Ass'y, Low Pressure, NSK-BC010F-067	1	1	1	1	1	1
44	43197164	Nut, Flange		2	2		2	2
45	43047669	Nut, Flange	2			2		
46	43196113	Bushing	2	2	2	2	2	2
47	43149324	Rubber, Cushion	3	3	3	3	3	3
48	43047692	Bonnet	1	1	1	1	1	1
49	43147451	Bonnet, 3/4 IN	1	1	1	1	1	1
50	43147649	Strainer	1	1	1	1	1	1
51	4314Q008	Strainer	1	1	1	1	1	1
52	43063317	Holder, Thermostat	1	1	1	1	1	1
53	43019904	Holder, Sensor	3	3	3	3	3	3
54	43141513	Compressor, DA550A3F-11M	1	1	1	1	1	1
55	43197183	Bolt, Compressor, M6	3			3		
56	43197184	Bolt, Compressor, M6		3	3		3	3
57	43149325	Band, Fix	2	2	2	2	2	2
58	43119477	Plate, Fix, Condenser	2			2		
59	43119478	Plate, Fix, Condenser		2	2		2	2
60	43046494	Coil, PMV Ass'y, UKV-A040	2	2	2	2	2	2
61	4314Q004	Strainer	1	1	1	1	1	1

## 15-2. Inverter Assembly

RAV-SM2244AT8 (Z) (ZG) -E, RAV-SM2804AT8 (Z) (ZG) -E

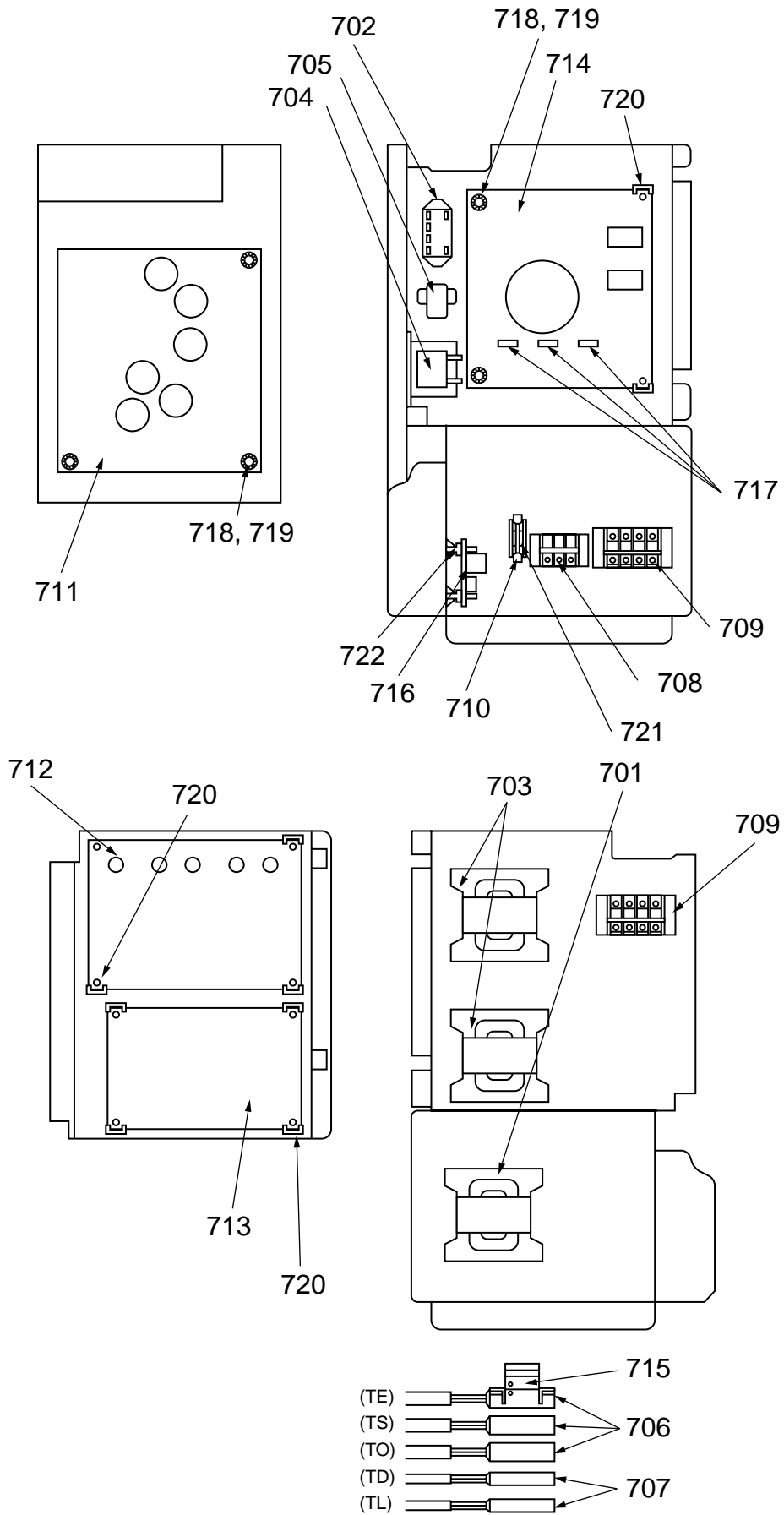

Location No.	Part No.	Description	Model name RAV-SM		
			2244AT8-E 2804AT8-E	2244AT8Z-E 2804AT8Z-E	2244AT8ZG-E 2804AT8ZG-E
701	43058288	Reactor, CH-56-4Z	1	1	1
702	43154177	Relay, 480V, 20A (Contact)	1	1	1
703	43158199	Reactor, CH-44-FCZ-2	2	2	2
704	43158207	Reactor, CH-68	1	1	1
705	43153006	PTC-Thermistor, ZPROYCE101A500	1	1	1
706	43050425	Sensor Ass'y, Service, TC (F6)	3	3	3
707	43150319	Sensor Ass'y, Service, TD (F4)	2	2	2
708	43160565	Terminal Block, 3P, 20A, AC250V	1	1	1
709	43160579	Terminal, 4P, 30A	2	2	2
710	43060859	Fuse Block, 30A, 250V, FH153-PB	1	1	1
711	4316V390	P.C. Board Ass'y, MCC-1596, Comp-IPDU	1	1	1
712	4316V391	P.C. Board Ass'y, MCC-1597, Fan-IPDU	1	1	1
713	4316V392	P.C. Board Ass'y, MCC-1599, CDB	1	1	1
714	4316V398	P.C. Board Ass'y, MCC-1600, N/F	1	1	1
715	43063325	Holder, Sensor, 6-6.35, 8	1	1	1
716	4316V393	P.C. Board Ass'y, MCC-1436	1	1	1
717	43160590	Fuse, 6.3A, AC250V	3	3	3
718	43282001	Bushing	5	5	5
719	43183020	Collar	5	5	5
720	43063248	Supporter Ass'y	2	2	2
721	43060639	Fuse, 25A, 250V	1	1	1
722	43163015	Supporter	4	4	4

### 15-3. Outdoor Unit

RAV-SM2244AT7 (Z) (ZG), RAV-SM2804AT7 (Z) (ZG)

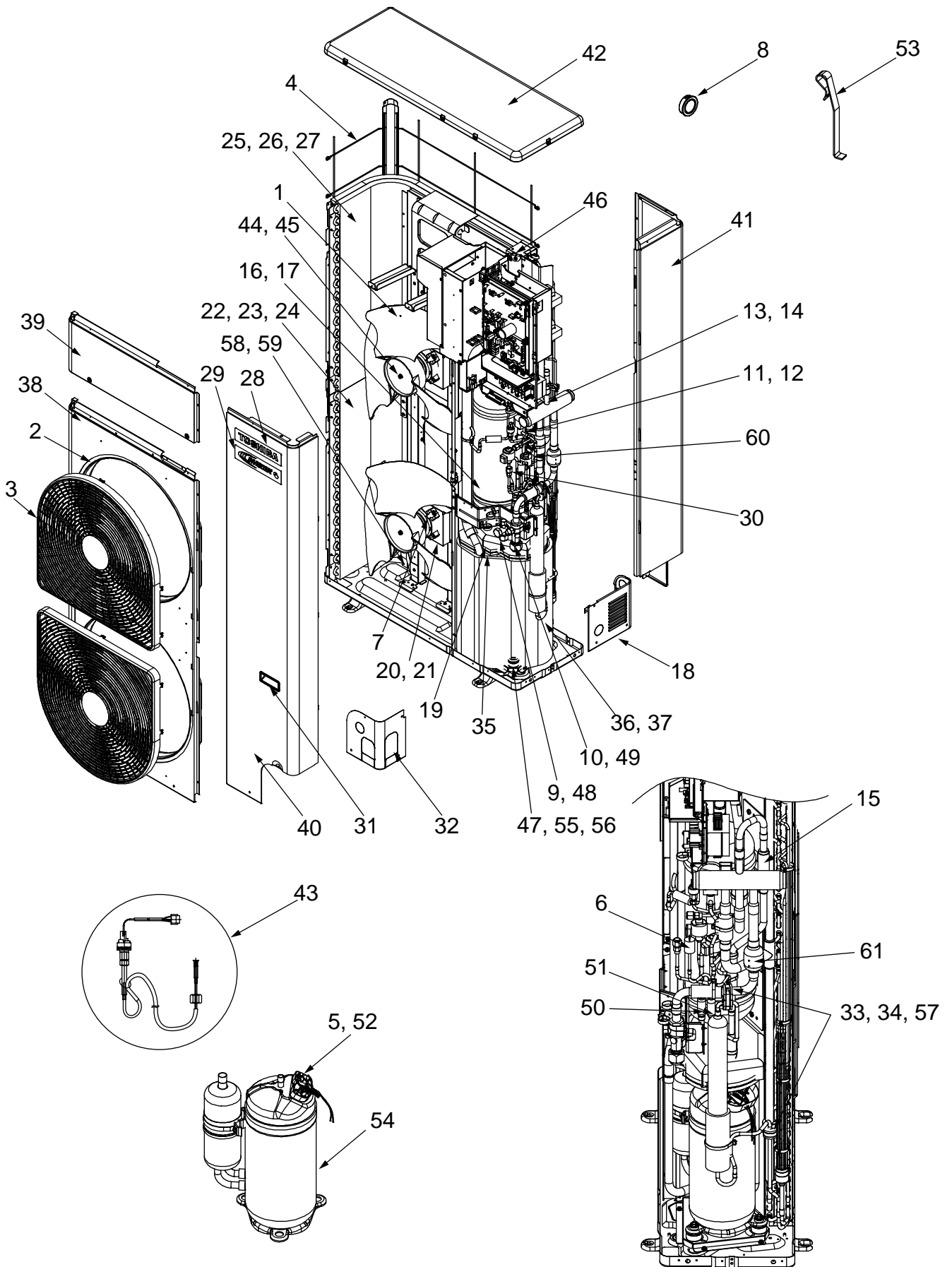



Location No.	Part No.	Description	Model name					
			RAV-SM2244			RAV-SM2804		
			AT7	AT7Z	AT7ZG	AT7	AT7Z	AT7ZG
1	43120224	Fan, Propeller, PE492	2	2	2	2	2	2
2	43122065	Bell Mouth	2	2	2	2	2	2
3	43191651	Guard, Fan	2	2	2	2	2	2
4	43100323	Guard, Fin	1	1	1	1	1	1
5	43050407	Thermostat, Bimetal	1	1	1	1	1	1
6	43151301	Switch, Pressure	1	1	1	1	1	1
7	4312C037	Motor, Fan, ICF-280-A100-1	2	2	2	2	2	2
8	4316V135	Bush	1	1	1	1	1	1
9	43146680	Valve, Packed, 12.7	1	1	1	1	1	1
10	43146725	Valve, Ball, SBV-JA6GTC-1	1	1	1	1	1	1
11	43146700	Valve, 2-way, VPV-603D	1	1	1	1	1	1
12	43146716	Coil, Solenoid, 2-way, AC220V, 60Hz	1	1	1	1	1	1
13	43146706	Coil, Solenoid, VHV-01AJ502E1	1	1	1	1	1	1
14	43146698	Valve, 4-way, STF-0731G	1	1	1	1	1	1
15	43146734	Valve, Check, ZGV-S55B-A	1	1	1	1	1	1
16	43148208	Accumulator	1	1		1	1	
17	43148209	Accumulator			1			1
18	43100345	Panel, Back, Piping	1	1	1	1	1	1
19	43111337	Rubber	1	1	1	1	1	1
20	43122095	Base Ass'y, Motor	1			1		
21	43122105	Base Ass'y, Motor		1	1		1	1
22	4314G187	Condenser Ass'y, Lower	1			1		
23	4314G188	Condenser Ass'y, Lower		1			1	
24	4314G189	Condenser Ass'y, Lower			1			1
25	4314G191	Condenser Ass'y, Up	1			1		
26	4314G192	Condenser Ass'y, Up		1			1	
27	4314G193	Condenser Ass'y, Up			1			1
28	4301P703	Mark, TOSHIBA	1	1	1	1	1	1
29	4301P729	Mark, Inverter	1	1	1	1	1	1
30	43146676	Joint, Check	2	2	2	2	2	2
31	43119390	Hanger	3	3	3	3	3	3
32	43100347	Panel, Front, Piping	1	1	1	1	1	1
33	43149318	Rubber, Supporter, Pipe, DIA 19.0	2	2	2	2	2	2
34	43149320	Rubber, Supporter, Pipe, DIA 8.0	2	2	2	2	2	2
35	43111334	Insulator, Sound, Up	1	1	1	1	1	1
36	43111335	Insulator, Sound, In	1	1	1	1	1	1
37	43111336	Insulator, Sound, Out	1	1	1	1	1	1
38	43100329	Cabinet Ass'y, Out	1	1	1	1	1	1
39	43100332	Cabinet Ass'y, Up	1	1	1	1	1	1
40	43100335	Cabinet Ass'y, Front	1	1	1	1	1	1
41	43100338	Panel Ass'y, Side	1	1	1	1	1	1
42	43100341	Cabinet Ass'y, Top	1	1	1	1	1	1
43	43150321	Sensor Ass'y, Low Pressure, NSK-BC010F-067	1	1	1	1	1	1
44	43197164	Nut, Flange		2	2		2	2
45	43047669	Nut, Flange	2			2		
46	43196113	Bushing	2	2	2	2	2	2
47	43149324	Rubber, Cushion	3	3	3	3	3	3
48	43047692	Bonnet	1	1	1	1	1	1
49	43147451	Bonnet, 3/4 IN	1	1	1	1	1	1
50	43147649	Strainer	1	1	1	1	1	1
51	4314Q008	Strainer	1	1	1	1	1	1
52	43063317	Holder, Thermostat	1	1	1	1	1	1
53	43019904	Holder, Sensor	3	3	3	3	3	3
54	43141513	Compressor, DA550A3F-11M	1	1	1	1	1	1
55	43197183	Bolt, Compressor, M6	3			3		
56	43197184	Bolt, Compressor, M6		3	3		3	3
57	43149325	Band, Fix	2	2	2	2	2	2
58	43119477	Plate, Fix, Condenser	2			2		
59	43119478	Plate, Fix, Condenser		2	2		2	2
60	43046494	Coil, PMV Ass'y, UKV-A040	2	2	2	2	2	2
61	4314Q004	Strainer	1	1	1	1	1	1

# 15-4. Inverter Assembly

RAV-SM2244AT7 (Z) (ZG), RAV-SM2804AT7 (Z) (ZG)

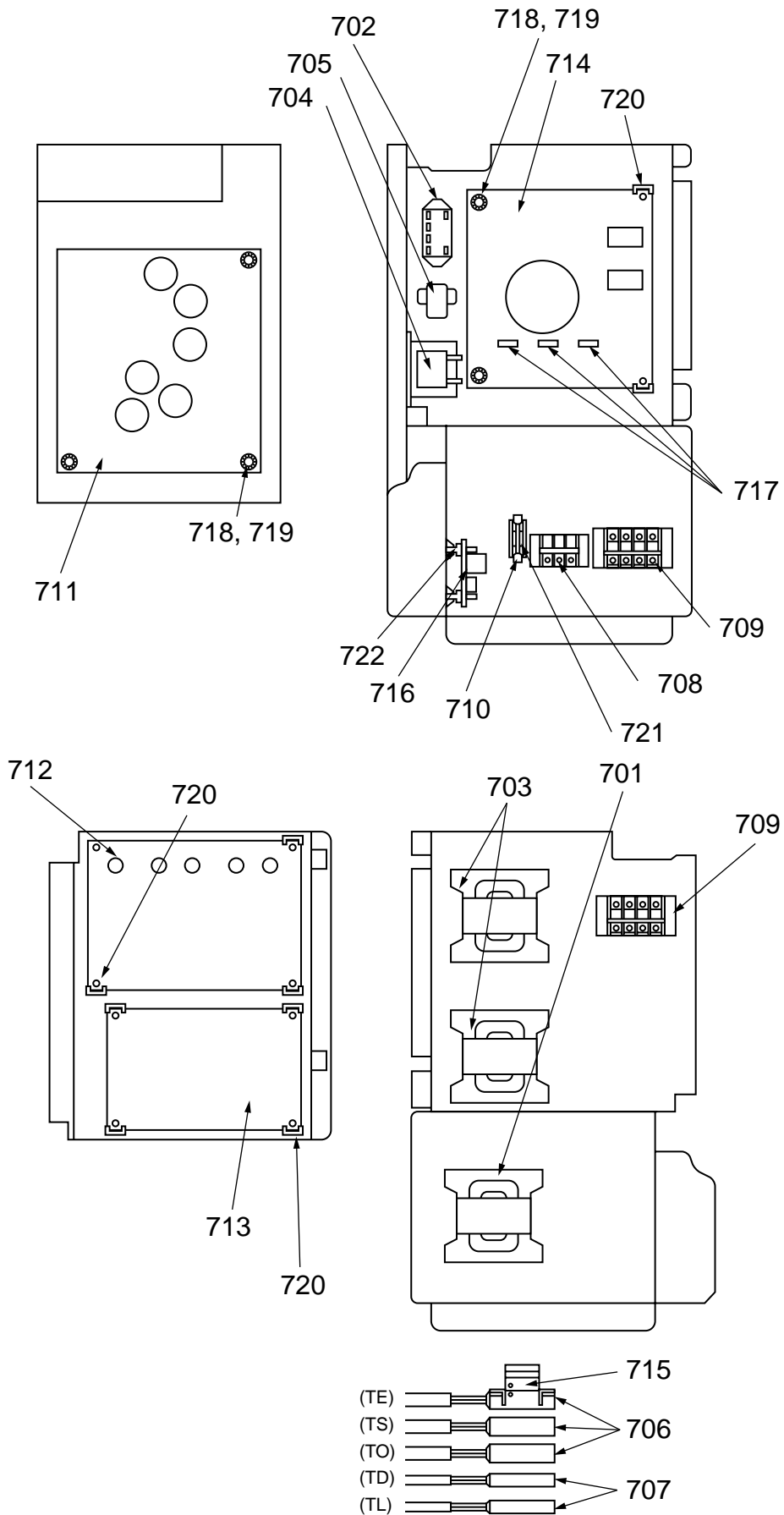

Location No.	Part No.	Description	Model name RAV-SM		
			2244AT7 2804AT7	2244AT7Z 2804AT7Z	2244AT7ZG 2804AT7ZG
701	43058288	Reactor, CH-56-4Z	1	1	1
702	43154177	Relay, 480V, 20A (Contact)	1	1	1
703	43158199	Reactor, CH-44-FCZ-2	2	2	2
704	43158207	Reactor, CH-68	1	1	1
705	43153006	PTC-Thermistor, ZPROYCE101A500	1	1	1
706	43050425	Sensor Ass'y, Service, TC (F6)	3	3	3
707	43150319	Sensor Ass'y, Service, TD (F4)	2	2	2
708	43160565	Terminal Block, 3P, 20A, AC250V	1	1	1
709	43160579	Terminal, 4P, 30A	2	2	2
710	43060859	Fuse Block, 30A, 250V, FH153-PB	1	1	1
711	4316V390	P.C. Board Ass'y, MCC-1596, Comp-IPDU	1	1	1
712	4316V391	P.C. Board Ass'y, MCC-1597, Fan-IPDU	1	1	1
713	4316V392	P.C. Board Ass'y, MCC-1599, CDB	1	1	1
714	4316V398	P.C. Board Ass'y, MCC-1600, N/F	1	1	1
715	43063325	Holder, Sensor, 6-6.35, 8	1	1	1
716	4316V393	P.C. Board Ass'y, MCC-1436	1	1	1
717	43160590	Fuse, 6.3A, AC250V	3	3	3
718	43282001	Bushing	5	5	5
719	43183020	Collar	5	5	5
720	43063248	Supporter Ass'y	2	2	2
721	43060639	Fuse, 25A, 250V	1	1	1
722	43163015	Supporter	4	4	4

# WARNINGS ON REFRIGERANT LEAKAGE

## Important

### Check of Concentration Limit

The room in which the air conditioner is to be installed requires a design that in the event of refrigerant gas leaking out, its concentration will not exceed a set limit.

The refrigerant R410A which is used in the air conditioner is safe, without the toxicity or combustibility of ammonia, and is not restricted by laws to be imposed which protect the ozone layer. However, since it contains more than air, it poses the risk of suffocation if its concentration should rise excessively. Suffocation from leakage of R410A is almost non-existent. With the recent increase in the number of high concentration buildings, however, the installation of multi air conditioner systems is on the increase because of the need for effective use of floor space, individual control, energy conservation by curtailing heat and carrying power etc.

Most importantly, the multi air conditioner system is able to replenish a large amount of refrigerant compared with conventional individual air conditioners. If a single unit of the multi conditioner system is to be installed in a small room, select a suitable model and installation procedure so that if the refrigerant accidentally leaks out, its concentration does not reach the limit (and in the event of an emergency, measures can be made before injury can occur).

In a room where the concentration may exceed the limit, create an opening with adjacent rooms, or install mechanical ventilation combined with a gas leak detection device.

The concentration is as given below.

$$\frac{\text{Total amount of refrigerant (kg)}}{\text{Min. volume of the indoor unit installed (m}^3\text{)}} \leq \text{Concentration limit (kg/m}^3\text{)}$$

The concentration limit of R410A which is used in multi air conditioners is 0.3kg/m<sup>3</sup>.

#### NOTE 1 :

If there are 2 or more refrigerating systems in a single refrigerating device, the amounts of refrigerant should be as charged in each independent device.

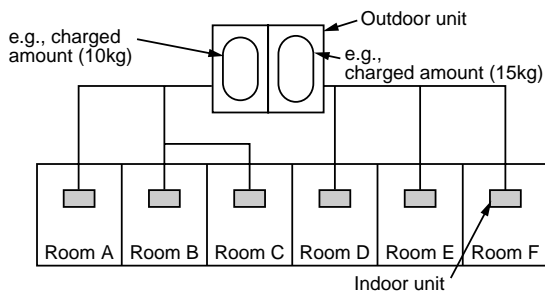

For the amount of charge in this example:

The possible amount of leaked refrigerant gas in rooms A, B and C is 10kg.

The possible amount of leaked refrigerant gas in rooms D, E and F is 15kg.

#### NOTE 2 :

The standards for minimum room volume are as follows.

- 1) No partition (shaded portion)

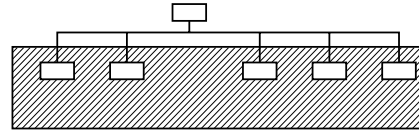

- 2) When there is an effective opening with the adjacent room for ventilation of leaking refrigerant gas (opening without a door, or an opening 0.15% or larger than the respective floor spaces at the top or bottom of the door).

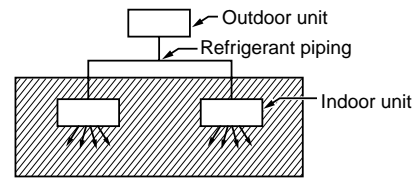

- 3) If an indoor unit is installed in each partitioned room and the refrigerant piping is interconnected, the smallest room of course becomes the object. But when a mechanical ventilation is installed interlocked with a gas leakage detector in the smallest room where the density limit is exceeded, the volume of the next smallest room becomes the object.

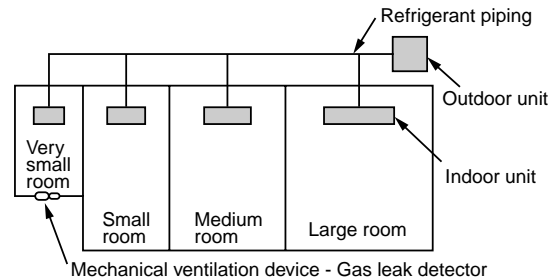

#### NOTE 3 :

The minimum indoor floor area compared with the amount of refrigerant is roughly as follows: (When the ceiling is 2.7m high)

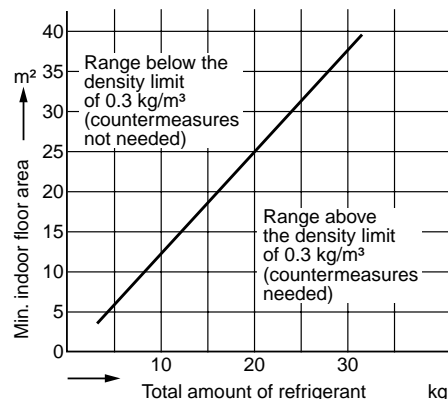

# **TOSHIBA CARRIER CORPORATION**

23-17, TAKANAWA 3 CHOME, MINATOKU, TOKYO, 108-8580, JAPAN

Copyright © 1999 to 2009 TOSHIBA CARRIER CORPORATION, ALL Rights Reserved.