

# CAV/VAV conversion kit

Installation instructions

GB

Document in original language | 211528 · A002



© Copyright Systemair UAB  
All rights reserved  
E&OE

Systemair UAB reserves the rights to change their products without notice.  
This also applies to products already ordered, as long as it does not affect the previously agreed specifications.  
Systemair is not liable or bound by the warranty if these instructions are not adhered to during installation or service.

# Contents

1	General information .....	1
2	Warnings .....	1
3	Transmitter installation .....	1
3.1	DIP-switches .....	1
4	VAV control .....	3
4.1	Installation and Wiring .....	3
4.2	Configuration .....	4
5	CAV control .....	5
5.1	Installation and Wiring .....	5
5.2	Configuration .....	6



## 1 General information

The CAV/VAV duct pressure control kit is used for CAV/VAV control of SAVE residential units with touch screen control panel. The kit includes: differential pressure transmitter (PDT12S25), installation instructions, cable set, tubes and labels.

### Important

To use CAV control, IRIS damper or a similar device with a known K-Factor have to be purchased separately. It is not included in this package.

## 2 Warnings



### Danger

- Make sure that the Mains supply to the unit is disconnected before performing any maintenance or electrical work!
- All electrical connections must be carried out by an authorized installer and in accordance with local rules and regulations.
- Beware of sharp edges during mounting.

## 3 Transmitter installation

1. Mount the transmitter horizontally or vertically on a stable, vibration-free surface. If the transmitter is installed in a humid environment, install it vertically with the cable gland edge of the transmitter pointing down to allow moisture to escape. Take extra care when connecting the hoses to the inlet ports, as the thin inner connections of the inlets are very sensitive. The lid should be kept closed while performing the connections, or the thin tubing might detach from the sensor.
2. Refer to the sections below for VAV and CAV wiring. Use the leftmost cable gland for supply voltage and use the rightmost gland for output signals in order to minimise crosstalk between supply wires and signal wires.
3. Set the DIP-switches to the desired operational mode and parameters.
4. Power up the transmitter.
5. Let the transmitter warm up for 10 minutes, then perform a zero-set calibration by pressing the push-button.



### Note:

Zeroing usually takes a few seconds. The yellow LED will light up while the zeroing operation is in progress. If the yellow LED starts blinking during the zeroing procedure, the unit has failed to zero-set properly. If so, ensure that the pressure ports are open and unobstructed and then power-cycle the unit and try again

6. Connect plastic tubes from the ventilation duct to the pressure inlets.

### 3.1 DIP-switches

The transmitter features two groups of DIP-switches for setting up suitable pressure range, output function and damping time factor. If the DIP-switch settings are changed, all changes will take place immediately. If a factory reset is performed, the pressure sensors will be reset to the factory calibration.

The leftmost DIP-switch controls sensor 1 and the rightmost DIP-switch controls sensor 2.

DIP-switich	Parameter	Key pattern	Parameter setting
1	Output function	OFF	0...10 V
		ON	4...20 mA
2, 3, 4	Pressure range	2 = OFF, 3 = OFF, 4 = OFF	Range 1
		2 = ON, 3 = OFF, 4 = OFF	Range 2
		2 = OFF, 3 = ON, 4 = OFF	Range 3
		2 = ON, 3 = ON, 4 = OFF	Range 4
		2 = OFF, 3 = OFF, 4 = ON	Range 5
		2 = ON, 3 = OFF, 4 = ON	Range 6
		2 = ON, 3 = ON, 4 = ON	Range 7
5, 6	Damping time factor	5 = OFF, 6 = OFF	1 s
		5 = ON, 6 = OFF	2 s
		5 = OFF, 6 = ON	3 s
		5 = ON, 6 = ON	4 s

DIP-switches 2, 3 and 4 are used to select the current pressure range of the transmitter.

PDT12S25-2 transmitter contains two sensors with different maximum pressure ranges. Sensor 1 maximum pressure range is 1250 Pa, Sensor 2 maximum pressure range is 2500 Pa.

**Table 1 Pressure ranges**

	Pressure range	S1 – 1250 Pa sensor	S2 – 2500 Pa sensor
<b>Output (Pa)</b>	Range 1	0...50	0...100
	Range 2	0...100	0...300
	Range 3	0...300	0...500
	Range 4	0...500	0...1000
	Range 5	0...700	0...1500
	Range 6	0...1000	0...2000
	Range 7	0...1250	0...2500

#### Terminals

- 1. G (+)
- 2. G0 (-)
- 3. AO1 +
- 4. AO1 GND
- 5. AO2 +
- 6. AO2 GND

## 4 VAV control

### 4.1 Installation and Wiring

The pressure transmitters need to be mounted in the supply and extract air ducts and connected according to Fig. 1 *VAV Installation and Wiring*.



**Note:**

For optimal measuring results, measuring points with turbulent air flow should be avoided. Preferably, measuring should be performed at a distance of 2 duct diameters before bends and branching and at 6 duct diameters after bends and branching.

- Supply duct, connect the tube from the supply duct to +.
- Extract duct, connect the tube from the extract duct to -.

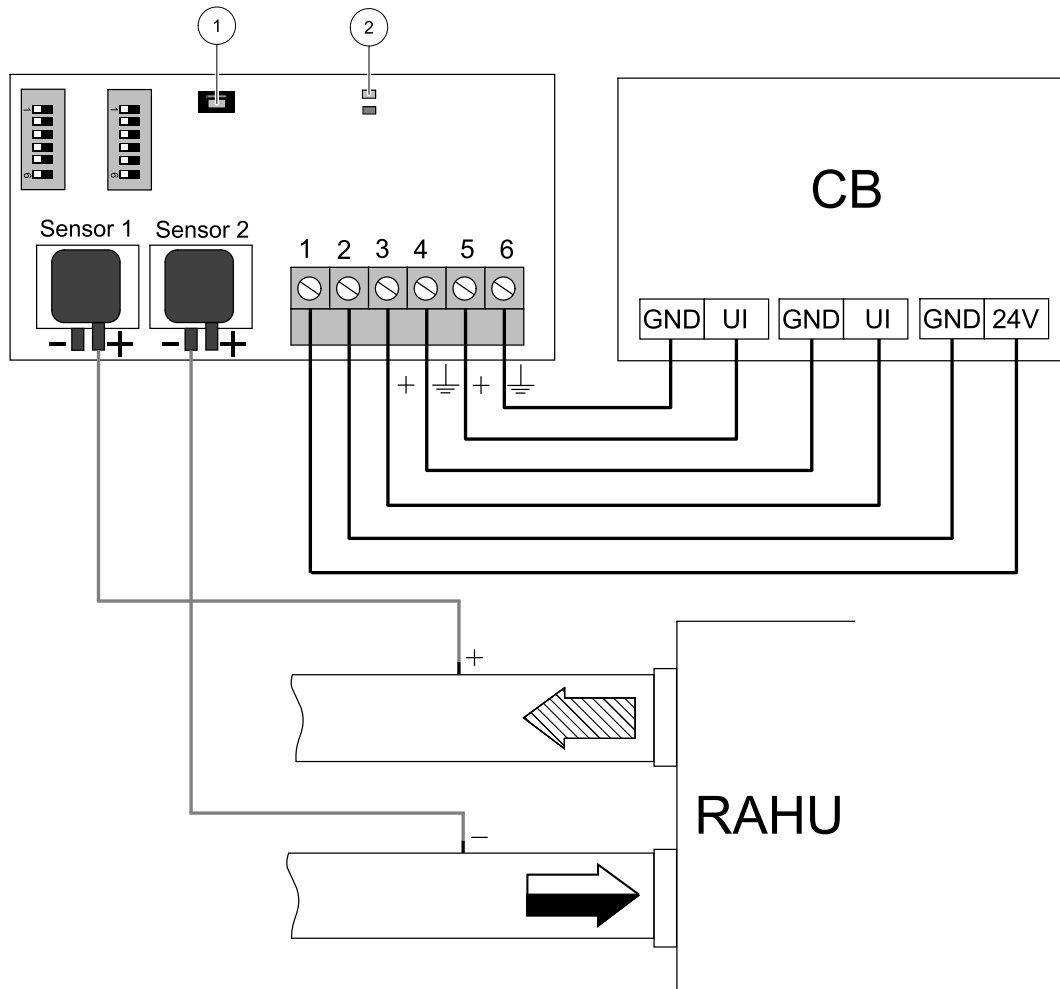

Fig. 1 VAV Installation and Wiring

Table 2 Symbol description

Symbol	Description
	Supply air
	Extract air
CB	Connection board on the unit
RAHU	SAVE residential air handling unit
1	Push-button
2	Status LEDs

## 4.2 Configuration

### Input signal configuration

1. Go to `Service` menu
2. Enter password (default 1111)
3. Configure supply air transmitter input. Go to `Input` menu. Select `UNIVERSAL` tab. Select the analog input to which supply air VAV/CAV transmitter is connected. Example if it is connected to UI2 on the connection board, then select `UNIVERSAL INPUT 2`. Select signal type as `Analog input` and select `Supply Air Fan Control (SAFC)` from the input type list.
4. Configure extract air transmitter input. Go to `Input` menu. Select `UNIVERSAL` tab. Select the analog input to which extract air VAV/CAV transmitter is connected. Example if it is connected to UI3 on the connection board, then select `UNIVERSAL INPUT 3`. Select signal type as `Analog input` and select `Extract Air Fan Control (EAFC)` from the input type list.

### Fan control configuration

- Go to `Service` menu, enter `Control Regulation` menu and then `Fan Control`. In this menu, set `Airflow Type` as `Pressure`.

#### Important

Changing the airflow type does not change P-band value automatically. P-band value have to be changed manually after changing the airflow type.

### Transmitter configuration

Set adjusted working range for the added VAV pressure transmitter.

1. Go to `Service` menu then enter `Control Regulation` and select `Fan Control`. In this menu enter `Pressure sensors`.
2. Configure pressure at 0 V, pressure at 10 V and alarm pressure for both `SUPPLY AIR FAN CONTROL` and `EXTRACT AIR FAN CONTROL` settings.  
For example, if pressure transmitter measuring range is 0-500 Pa, then set: 0 V = 0 Pa; 10 V = 500 Pa. Measuring range can be changed with DIP-switches on the transmitter.

### Configure Airflow Level Settings

1. Go to `Service` menu then enter `Control Regulation` and select `Fan Control`. Change measurement units if necessary.
2. Enter `Airflow Level Settings` menu.
3. Set `Supply Airflow` and `Extract Airflow` for all levels: `MAXIMUM LEVEL`, `HIGH LEVEL`, `NORMAL LEVEL`, `LOW LEVEL`, `MINIMUM LEVEL`.



## 5 CAV control

### 5.1 Installation and Wiring

The pressure transmitters need to be mounted in the supply and extract air ducts and connected according to Fig. 2 *CAV installation and wiring*.



#### Note:

For optimal measuring results, measuring points with turbulent air flow should be avoided. Preferably, measuring should be performed at a distance of 2 duct diameters before bends and branching and at 6 duct diameters after bends and branching.

#### Supply air duct

1. Install IRIS damper or similar device with known K-factor into the supply air duct.
2. Connect tube from the IRIS damper or similar device to +.
3. Connect the tube from supply air duct after IRIS damper to -.

#### Extract air duct

1. Install IRIS damper or similar device with known K-factor into the extract air duct.
2. Connect tube from the IRIS damper or similar device to +.
3. Connect the tube from extract air duct after IRIS damper to -.

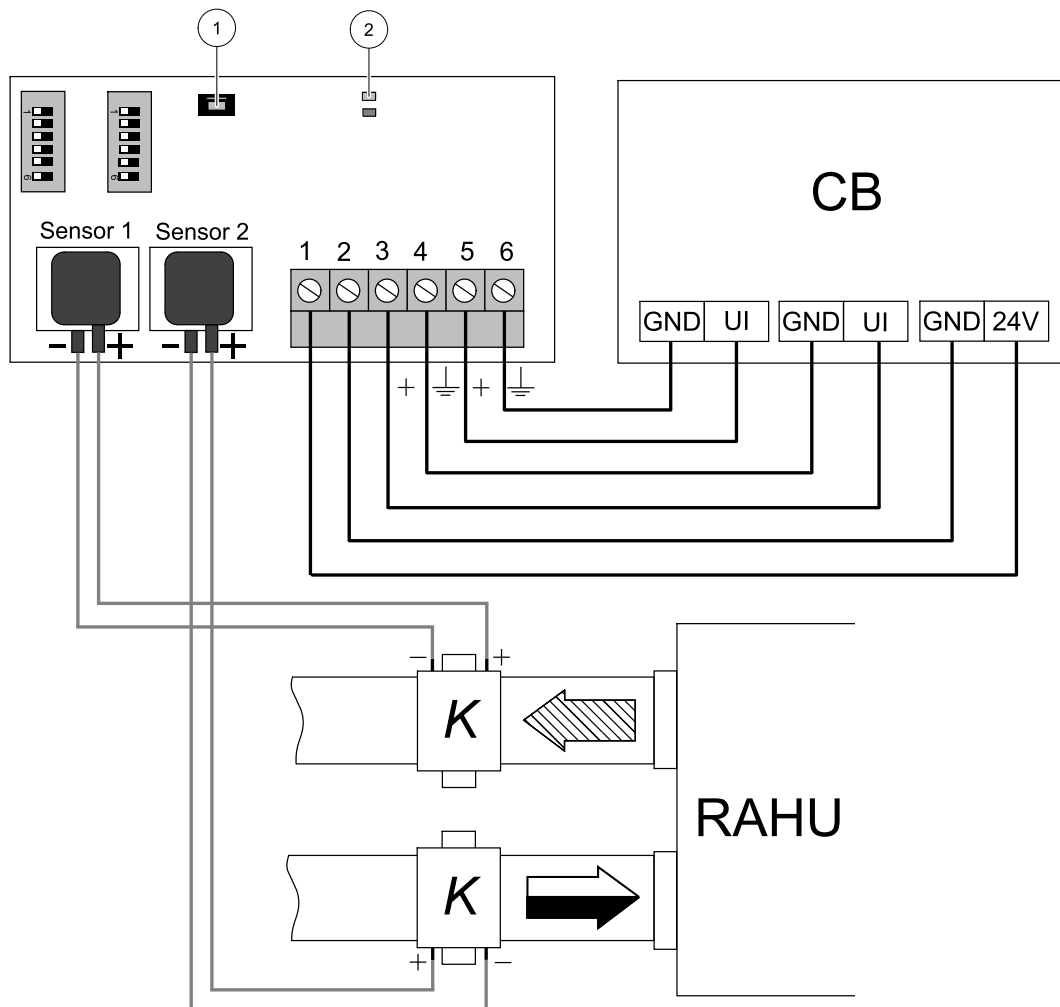



Fig. 2 CAV installation and wiring

**Table 3 Symbol description**

Symbol	Description
	Supply air
	Extract air
CB	Connection board on the unit
RAHU	SAVE residential air handling unit
<b>K</b>	Iris damper or a similar device with known K-factor
1	Push-button
2	Status LEDs

## 5.2 Configuration

### Input signal configuration

1. Go to `Service` menu
2. Enter password (default 1111)
3. Configure supply air transmitter input. Go to `Input` menu. Select `UNIVERSAL` tab. Select the analog input to which supply air VAV/CAV transmitter is connected. Example if it is connected to UI2 on the connection board, then select `UNIVERSAL INPUT 2`. Select signal type as `Analog input` and select `Supply Air Fan Control (SAFC)` from the input type list.
4. Configure extract air transmitter input. Go to `Input` menu. Select `UNIVERSAL` tab. Select the analog input to which extract air VAV/CAV transmitter is connected. Example if it is connected to UI3 on the connection board, then select `UNIVERSAL INPUT 3`. Select signal type as `Analog input` and select `Extract Air Fan Control (EAFK)` from the input type list.

### Fan control configuration

- Go to `Service` menu, enter `Control Regulation` menu and then `Fan Control`. In this menu, set `Airflow Type` as `Flow`.

#### Important

Changing the airflow type does not change P-band value automatically. P-band value have to be changed manually after changing the airflow type.

### Transmitter configuration

Set adjusted working range for the added CAV pressure transmitter.

1. Go to `Service` menu then enter `Control Regulation` and select `Fan Control`. In this menu enter `Pressure sensors`.
2. Configure pressure at 0 V, pressure at 10 V and alarm pressure for both `SUPPLY AIR FAN CONTROL` and `EXTRACT AIR FAN CONTROL` settings.

For example, if pressure transmitter measuring range is 0-500 Pa, then set: 0 V = 0 Pa; 10 V = 500 Pa. Measuring range can be changed with DIP-switches on the transmitter.

### Set K-Factor values

Enter correct K-factor values for each Iris damper in menu.

1. Go to `Service` menu then enter `Control Regulation` and select `Fan Control`.
2. In this menu select `SAF K-Factor` setting and enter **K factor** value found on the label of supply air duct Iris damper.
3. Then select `EAF K-Factor` setting and enter **K factor** value found on the label of extract air duct Iris damper.



#### Note:

K-Factor can be found on Iris damper label.

**Configure Airflow Level Settings**

1. Go to Service menu then enter Control Regulation and select Fan Control. Change measurement units if necessary.
2. Enter Airflow Level Settings menu.
3. Set Supply Airflow and Extract Airflow for all levels: MAXIMUM LEVEL, HIGH LEVEL, NORMAL LEVEL, LOW LEVEL, MINIMUM LEVEL.



Systemair UAB  
Ling st. 101  
LT-20174 Ukmergė, LITHUANIA

Phone +370 340 60165  
Fax +370 340 60166

[www.systemair.com](http://www.systemair.com)