

Monitoring and control devices



	Price groups PG 41B, 41E, 41F, 41H, 41L, 42F, 42J		<u>SIRIUS 3UG45, 3UG46 monitoring relays for stand-alone installation</u>
10/2	Introduction	10/71	General data
	SIMOCODE 3UF motor management and control devices <u>SIMOCODE pro 3UF7 motor management and control devices</u>	10/73	Line monitoring
10/5	General data	10/78	Voltage monitoring
10/16	Basic units	10/81	Current monitoring
10/19	Expansion modules	10/83	Power factor and active current monitoring
10/21	Fail-safe expansion modules		Residual-current monitoring
10/22	Accessories	10/86	- Residual-current monitoring relays
	<u>3UF18 current transformers for overload protection</u>	10/88	- 3UL23 residual-current transformers
10/25	Basic units and accessories	10/89	Insulation monitoring <i>NEW</i>
		10/93	Level monitoring
		10/96	Speed monitoring
		10/99	Accessories
10/26	LOGO! logic modules		<u>SIRIUS 3UG48 monitoring relays for stand-alone installation for IO-Link</u>
	Relays	10/100	General data
	<u>Timing relays</u>	10/103	Line monitoring
10/27	General data	10/106	Voltage monitoring
10/28	SIRIUS 3RP25 timing relays, 17.5 mm and 22.5 mm <i>NEW</i>	10/109	Current monitoring
10/40	SIRIUS 3RP20 timing relays, 45 mm	10/112	Power factor and active current monitoring
10/46	7PV15 timing relays, 17.5 mm		Residual-current monitoring
3/104	SIRIUS 3RA28 solid-state time-delay auxiliary switch blocks for mounting onto 3RT2 contactors and 3RH2 contactor relays	10/116	- Residual-current monitoring relays
3/109	SIRIUS 3RA28 function modules for mounting on 3RT2 contactors and 3RH2 contactor relays	10/88	- 3UL23 residual-current transformers
3/105	SIRIUS 3RT19 timing relays for mounting on 3RT1 contactors	10/119	Speed monitoring
	<u>SIRIUS 3RR21, 3RR22 monitoring relays for mounting on 3RT2 contactors</u>	10/122	Accessories
10/51	Current and active current monitoring		<u>SIRIUS 3RS2 temperature monitoring relays</u>
	<u>SIRIUS 3RR24 monitoring relays for mounting on 3RT2 contactors for IO-Link</u>	10/123	General data
10/59	Current and active current monitoring	10/131	Basic units
	<u>SIRIUS 3UG5 monitoring relays for stand-alone installation</u>	10/132	Accessories
10/66	DC load monitoring		<u>SIRIUS 3RN2 thermistor motor protection</u>
		10/133	General data
		10/140	Basic units
		10/141	Accessories
			<u>Coupling relays and signal converters</u>
		5/24	Coupling relays
		3/147	3TG10 power relays/miniature contactors
		10/142	SIRIUS 3RS70 signal converters

NEW

Click on this video symbol in the catalog PDF for further product information.



Monitoring and control devices

Introduction

Overview

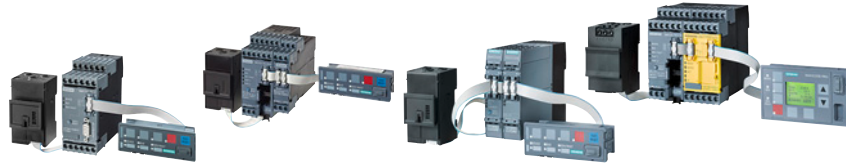

Type	SIMOCODE pro C	SIMOCODE pro V PROFINET General Performance	SIMOCODE pro S General Performance	SIMOCODE pro V High Performance PROFIBUS/PROFINET Modbus RTU/EtherNet/IP	Page
SIMOCODE pro 3UF7 motor management and control devices					
Basic units	✓	✓	✓	✓	10/16
Current measuring modules	✓	✓	✓	✓	10/17
Current/voltage measuring modules	--	--	--	✓	10/17
Operator panels	✓	✓	✓	✓	10/18
Operator panels with display	--	--	--	✓	10/18
Expansion modules	--	✓	✓	✓	10/19
Fail-safe expansion modules	--	--	--	✓	10/21
Current transformers	✓	✓	✓	✓	10/25
SIMOCODE ES (TIA Portal)	✓	✓	✓	✓	14/12
SIMOCODE pro block library for SIMATIC PCS 7	✓	✓	✓	✓	14/15
SIRIUS Asset Monitor	✓	✓	✓	✓	14/26

✓ Available

-- Not available



Type	3RP25	3RP20	7PV15
Timing relays			
Enclosures:			
• 17.5 mm industry and household equipment installation	✓	--	✓
• 22.5 mm industry	✓	--	--
• 45 mm industry	--	✓	--
Monofunction	✓	✓	✓
Multifunction	✓	✓	✓
Combination voltage	✓	✓	✓
Wide voltage range	✓	✓	✓
Application:			
• Control systems and mechanical engineering	✓	✓	✓
• Infrastructure	--	--	✓
Page	10/28	10/40	10/46

✓ Corresponds to or available

-- Does not correspond to or not available



Type	3UG546	3UG451., 3UG461.	3UG463.	3RR21, 3RR22, 3UG4621, 3UG4622	3UG4641	3UG4625 with 3UL23	3UG458.	3UG4501	3UG4651	Page
Monitoring relays										
DC load monitoring	✓	--	--	--	--	--	--	--	--	10/66
Line monitoring	--	✓	--	--	--	--	--	--	--	10/73
Voltage monitoring	--	--	✓	--	--	--	--	--	--	10/78
Current monitoring	--	--	--	✓	--	--	--	--	--	10/51, 10/81
Active current monitoring	--	--	--	3RR22 ✓	✓	--	--	--	--	10/51, 10/83
Power factor monitoring	--	--	--	--	✓	--	--	--	--	10/83
Residual-current monitoring	--	--	--	--	--	✓	--	--	--	10/86
Insulation monitoring	--	--	--	--	--	--	✓	--	--	10/89
Level monitoring	--	--	--	--	--	--	--	✓	--	10/93
Speed monitoring	--	--	--	--	--	--	--	--	✓	10/96

✓ Available
-- Not available

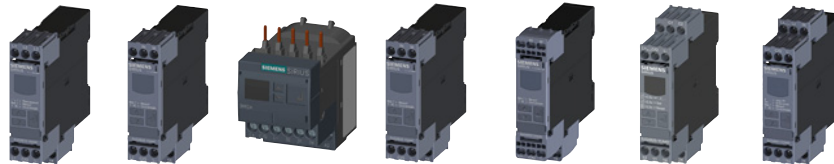

Type	3UG481.	3UG4832	3RR24	3UG4822	3UG4841	3UG4825 with 3UL23	3UG4851	Page
Monitoring relays for IO-Link								
Line monitoring	✓	--	--	--	--	--	--	10/103
Voltage monitoring	--	✓	--	--	--	--	--	10/106
Current monitoring	--	--	✓	✓	--	--	--	10/59, 10/109
Power factor and active current monitoring	--	--	✓	--	✓	--	--	10/59, 10/112
Residual-current monitoring	--	--	--	--	--	✓	--	10/116
Speed monitoring	--	--	--	--	--	--	✓	10/119

✓ Available
-- Not available



Type	3RS2	3RN2	3RS70	Page
Temperature monitoring relays				
Temperature monitoring	✓	--	--	10/123
Temperature monitoring relays for IO-Link				
Temperature monitoring for IO-Link	✓	--	--	10/123
Thermistor motor protection				
Thermistor motor protection	--	✓	--	10/133
Signal converters				
Single-range converters	--	--	✓	10/142
Multi-range converters	--	--	✓	10/142
Universal converters	--	--	✓	10/142

✓ Available
-- Not available

Monitoring and control devices

Introduction

Connection methods

The monitoring and control devices are available with screw or spring-loaded terminals.

SIRIUS 3RP25 timing relays, 3UG458 insulation monitoring relays, SIRIUS 3RS2 temperature monitoring relays, SIRIUS 3RN2 thermistor motor protection and SIRIUS 3RS70 signal converters are available with screw terminals or spring-loaded terminals (push-in).



Screw terminals



Spring-loaded terminals, spring-loaded terminals (push-in)

The terminals are indicated in the corresponding tables by the symbols shown on orange backgrounds.

"Increased safety" type of protection EEx e/d according to ATEX directive 2014/34/EU

The communication-capable, modularly designed SIMOCODE pro motor management system (SIRIUS Motor Management and Control Devices) protects motors of types of protection EEx e and EEx d in hazardous areas.

The SIRIUS 3RN2 thermistor motor protection relay protects motors with types of protection EEx e and EEx d in hazardous areas.

ATEX approval for operation in hazardous areas

The SIRIUS SIMOCODE pro 3UF7 motor management system is certified for the protection of motors in hazardous areas according to

- ATEX Ex I (M2); equipment group I, category M2 (mining)
- ATEX Ex II (2) GD; equipment group II, category 2 in area GD

The SIRIUS 3RN2011, 3RN2012-...30, 3RN2013 and 3RN2023 thermistor motor protection relays for PTC sensors are certified according to ATEX Ex II (2) G and D for environments with explosive gas or dust loads.

Monitoring and control devices

SIMOCODE 3UF motor management and control devices

SIMOCODE pro 3UF7 motor management and control devices

General data

Overview

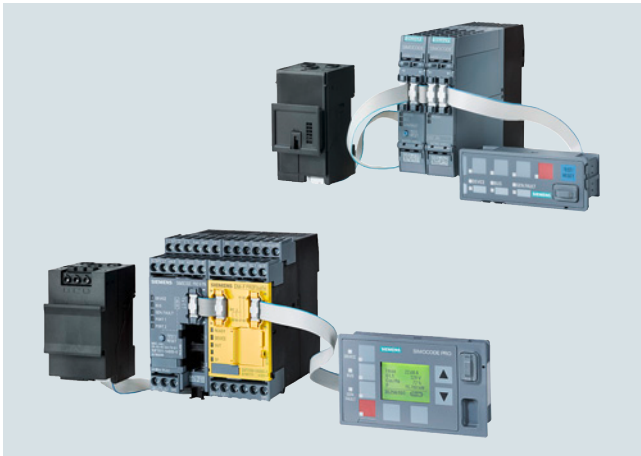

SIMOCODE pro S and SIMOCODE pro V

More information

Homepage, see www.siemens.com/sirius-simocode
 Industry Mall, see www.siemens.com/product?3UF7
 TIA Selection Tool Cloud (TST Cloud)
 • For SIMOCODE pro S, see www.siemens.com/tstcloud/?node=SimocodeProS
 • For SIMOCODE pro V, see www.siemens.com/tstcloud/?node=SimocodeProV

SIMOCODE pro is a flexible, modular motor management system for motors with constant speeds in the low-voltage performance range. It optimizes the connection between I&C and motor feeder, increases plant availability and allows significant savings to be made for installation, commissioning, operation and maintenance of a system.

SIMOCODE pro offers, for example:

- Multifunctional, solid-state full motor protection that is independent of the automation system
- Integrated control functions instead of hardware for the motor control
- Detailed operating, service and diagnostics data
- Open communication via PROFIBUS DP, PROFINET/OPC UA, Modbus RTU or EtherNet/IP
- Safety relay function for the fail-safe disconnection of motors up to SIL 3 according to IEC 61508, IEC 62061 or PL e according to ISO 13849-1
- SIMOCODE ES is the software package for SIMOCODE pro parameterization, startup and diagnostics, see page 14/12.
- The MindSphere app SIRIUS Asset Monitor enables access to the SIMOCODE pro motor management system anytime and anywhere. It provides the user with detailed information on the device status as well as fault messages and warnings in a clearly arranged form, see page 14/26.

Device series

Basic Performance with SIMOCODE pro C



The compact system for direct-on-line starters and reversing starters or for controlling a motor starter protector.

General Performance with SIMOCODE pro S or SIMOCODE pro V PN GP

The smart system for direct-on-line, reversing, and wye-delta starters or for controlling a motor starter protector or soft starter. Its expandability with an expansion module/multifunction module provides comprehensive input/output project data volume, precise ground-fault detection via the 3UL23 residual-current transformers and temperature measurement.

High Performance with SIMOCODE pro V

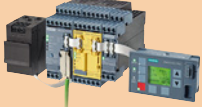
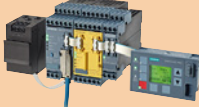
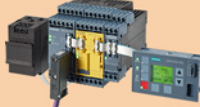
The variable system with all control functions and with the possibility of expanding the inputs, outputs and functions of the system at will using expansion modules.

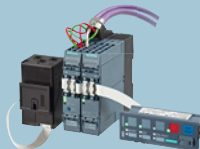
	PROFINET IO / OPC UA	ETHERNET / IP	PROFIBUS	MODBUS RTU	
Current/voltage measuring module	 SIMOCODE pro V PN	 SIMOCODE pro V EIP	 SIMOCODE pro V PB	 SIMOCODE pro V MR	High Performance
Operator panel with display					
Max. 5/7 expansion modules					
Safety					
Extended control functions (e.g. positioner, pole-changing starter)					
Current measuring module	 SIMOCODE pro V PN GP	 SIMOCODE pro S		General Performance	
Operator panel					
1 expansion module					
Basic control functions (e.g. direct-on-line/reversing start)					

IC01_005488

Device series

Monitoring and control devices

SIMOCODE 3UF motor management and control devices

SIMOCODE pro 3UF7 motor management and control devices

General data

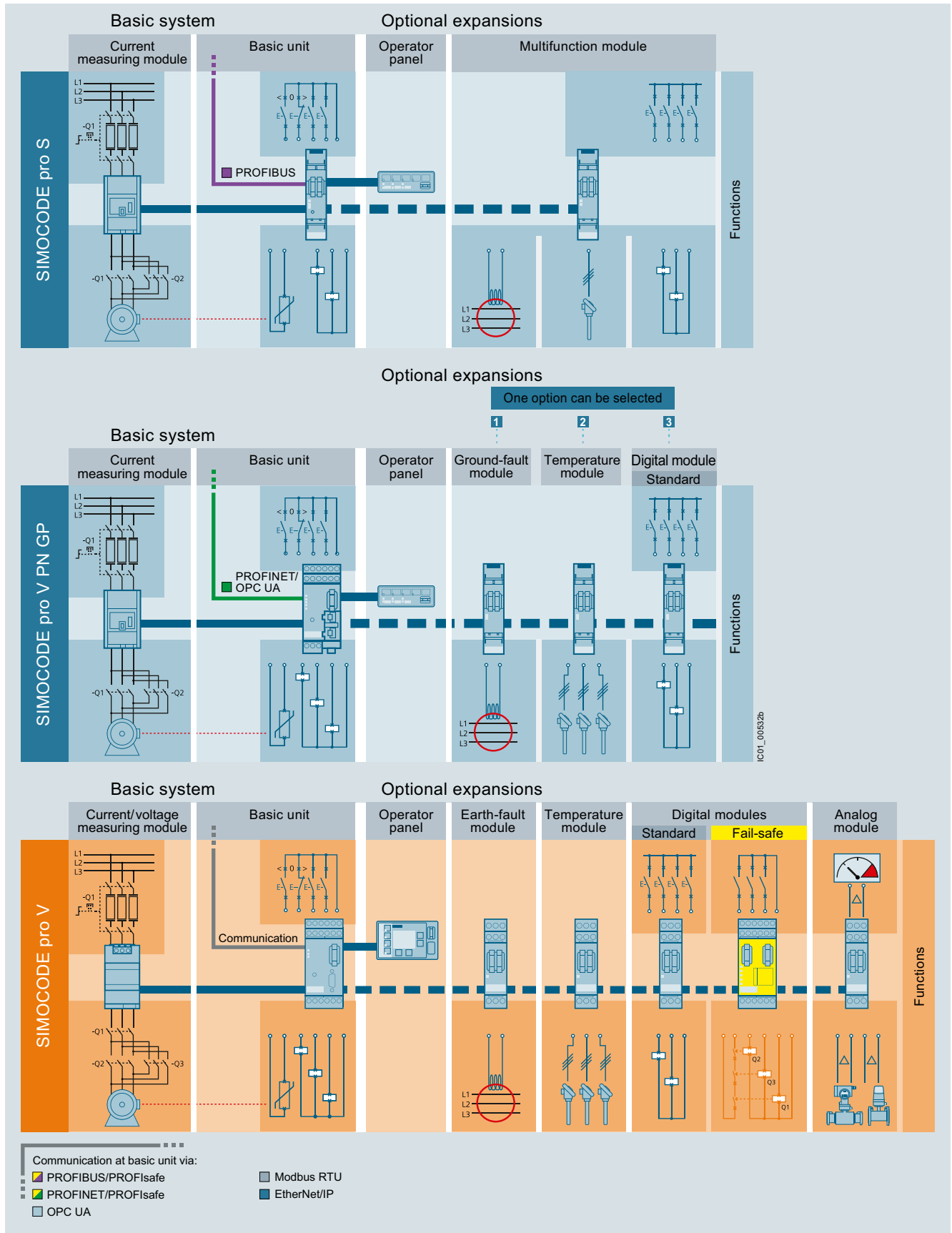

System structure

Monitoring and control devices

SIMOCODE 3UF motor management and control devices

SIMOCODE pro 3UF7 motor management and control devices

General data

Expansion possibilities	SIMOCODE pro C	SIMOCODE pro S	SIMOCODE pro V	SIMOCODE pro V	
	Basic Performance PROFIBUS	General Performance PROFIBUS	General Performance PROFINET GP	High Performance PROFIBUS/ Modbus RTU	PROFINET/ EtherNet/IP
Operator panels	✓	✓	✓	✓	✓
Operator panels with display	--	--	--	✓	✓
Current measuring modules	✓	✓	✓	✓	✓
Current/voltage measuring modules	--	--	--	✓	✓
Expansion modules:					
• Digital modules	--	--	1 ²⁾	2	2
• Fail-safe digital modules ¹⁾	--	--	--	1	1
• Analog modules	--	--	--	1	2
• Ground-fault modules	--	--	1	1	1
• Temperature modules	--	--	1	1	2
• Multifunction modules	--	1	--	--	--

✓ Available
-- Not available

¹⁾ The fail-safe digital module can be used instead of one of the two digital modules.
²⁾ Only monostable version can be used.

Per feeder each system always comprises one basic unit and one separate current measuring module. The two modules are connected together electrically through the system interface with a connecting cable and can be mounted mechanically connected as a unit (one behind the other) or separately (side by side). The motor current to be monitored is decisive only for the choice of the current measuring module.

An operator panel for mounting in the control cabinet door is optionally connectable through a second system interface on the basic unit. Both the current measuring module and the operator panel are electrically supplied by the basic unit through the connecting cable. More inputs, outputs and functions can be added to the SIMOCODE pro V and SIMOCODE pro S by

means of optional expansion modules, thus supplementing the inputs and outputs already existing on the basic unit. With the DM-F Local and DM-F PROFIsafe fail-safe digital modules it is also possible to integrate the fail-safe disconnection of motors in the SIMOCODE pro V motor management system.

All modules are connected by connecting cables. The connecting cables are available in various lengths. The maximum distance between modules (e.g. between the basic unit and the current measuring module) must not exceed 2.5 m. The total length of all the connecting cables per system interface of the basic unit may be up to 3 m.

Article No. scheme

Product versions		Article number								
SIMOCODE pro motor management system		3UF7	<input type="checkbox"/>	<input type="checkbox"/>	<input type="checkbox"/>	- 1	<input type="checkbox"/>	<input type="checkbox"/>	<input type="checkbox"/>	- 0
Type of unit/module	e.g. 0 = basic unit		<input type="checkbox"/>							
Functional version of the module	e.g. 20 = SIMOCODE pro S		<input type="checkbox"/>	<input type="checkbox"/>						
Connection type of the current transformer	e.g. A = through-hole technology					<input type="checkbox"/>				
Voltage version	e.g. B = 24 V DC						<input type="checkbox"/>			
Enclosure color	e.g. 1 = titanium gray								<input type="checkbox"/>	
Example		3UF7	0	2	0	- 1	A	B	0	1 - 0

Note:

The Article No. scheme shows an overview of product versions for better understanding of the logic behind the article numbers.

For your orders, please use the article numbers quoted in the selection and ordering data.

Monitoring and control devices

SIMOCODE 3UF motor management and control devices

SIMOCODE pro 3UF7 motor management and control devices

General data

Benefits

General customer benefits

- Integrating the whole motor feeder into the process control by means of PROFIBUS DP, PROFINET/OPC UA, Modbus RTU or EtherNet/IP significantly reduces the wiring between the motor feeder and the PLC
- Decentralization of the automated processes by means of configurable control and monitoring functions in the feeder saves resources in the automation system and ensures full functionality and protection of the feeder even if the I&C or bus system fails
- The acquisition and monitoring of operating, service and diagnostics data in the feeder and process control system increases plant availability as well as maintenance and service-friendliness
- The high degree of modularity allows users to perfectly implement their plant-specific requirements for each motor feeder
- The SIMOCODE pro system offers functionally graded and space-saving solutions for each customer application
- The replacement of the control circuit hardware with integrated control functions decreases the number of hardware components and wiring required and in this way limits stock keeping costs and potential wiring errors
- The use of electronic full motor protection permits better utilization of the motors and ensures long-term stability of the tripping characteristic and reliable tripping even after years of service
- Thanks to the precision of the current, voltage, power and energy measurements (especially those acquired by the 2nd-generation current/voltage measuring modules), costs can be internally allocated with a high degree of accuracy

Multifunctional, electronic full motor protection for rated motor currents up to 820 A

SIMOCODE pro offers comprehensive protection of the motor feeder by means of a combination of different, multi-step and delayable protection and monitoring functions:

- Inverse-time delayed solid-state overload protection (CLASS 5E to 40E)
- Thermistor motor protection
- Phase failure/asymmetry protection
- Stall protection
- Monitoring of adjustable limit values for the motor current
- Voltage and power monitoring
- Monitoring of the power factor (motor idling/load shedding)
- Ground-fault monitoring
- Temperature monitoring, e.g. via Pt100/Pt1000
- Monitoring of operating hours, downtime and number of starts, etc.

Recording of measuring curves

SIMOCODE pro can record measuring curves and therefore is able, for example, to present the progression of motor current during motor startup.

Flexible motor control implemented with integrated control functions (instead of comprehensive hardware interlocks)

Many predefined motor control functions have already been integrated into SIMOCODE pro, including all necessary logic operations and interlocks:

- Overload relays
- Direct-on-line and reversing starters
- Wye/delta starters (also with direction reversal)
- Two speeds, motors with separate windings (pole-changing starter); also with direction reversal
- Two speeds, motors with separate Dahlander windings (also with direction reversal)
- Positioner actuation
- Solenoid valve actuation
- Actuation of a motor starter protector
- Soft starter actuation (also with direction reversal)

These control functions are predefined in SIMOCODE pro and can be freely assigned to the inputs and outputs of the device (including the PROFIBUS/PROFINET process image).

These predefined control functions can also be flexibly adapted to each customized configuration of a motor feeder by means of freely configurable logic modules (truth tables, counters, timers, edge evaluation, etc.) and with the help of standard functions (power failure monitoring, emergency start, external faults, etc.), without additional auxiliary relays being necessary in the control circuit.

SIMOCODE pro makes a lot of additional hardware and wiring in the control circuit unnecessary, which results in a high level of standardization of the motor feeder in terms of its design and circuit diagrams.

Monitoring and control devices

SIMOCODE 3UF motor management and control devices

SIMOCODE pro 3UF7 motor management and control devices

General data

Detailed operating, service and diagnostics data

SIMOCODE pro makes different operating, service and diagnostics data available and helps to detect potential faults in time and to prevent them by means of preventive measures. In the event of a malfunction, a fault can be diagnosed, localized and rectified very quickly – there are no or very short downtimes.

Operating data

- Motor switching state derived from the current flow in the main circuit
- All phase currents
- All phase voltages and phase-to-phase voltages
- Active power, apparent power and power factor
- Phase asymmetry and phase sequence
- Ground-fault current
- Frequency
- Time to trip
- Motor temperature
- Remaining cooling time etc.

Service data

- Motor operating hours
- Motor stop times
- Number of motor starts
- Number of overload trips
- Interval for compulsory testing of the enabling circuits
- Energy consumed
- Internal comments stored in the device etc.

Diagnostics data

- Numerous detailed early warning and fault messages
- Internal device fault logging with time stamp
- Time stamping of freely selectable status, alarm or fault messages, etc.

Easy operation and diagnostics

Operator panel

The operator panel is used to control the motor feeder and can replace all conventional pushbuttons and indicator lights to save space. It makes SIMOCODE pro or the feeder directly operable in the control cabinet. It features all the status LEDs available on the basic unit and externalizes the system interface for example for simple parameterization or diagnostics on a PC/PG.

Operator panel with display

As an alternative to the 3UF720 standard operator panel for SIMOCODE pro V, a 3UF721 operator panel with display is also available. This can additionally indicate current measured values, operating and diagnostics data or status information of the motor feeder at the control cabinet. The pushbuttons of the operator panel can be used to control the motor. Furthermore, it is possible to set parameters such as rated motor current, limit values, etc. directly via the operator panel with display (with SIMOCODE pro V PROFIBUS as of E15, SIMOCODE pro V Modbus RTU as of E03 and with all SIMOCODE pro V PROFINET and EtherNet/IP).

Communication

SIMOCODE pro has either an integrated PROFIBUS DP or Modbus RTU interface (SUB-D or terminal connection) or a PROFINET or EtherNet/IP interface (2 x RJ45).

Fail-safe disconnection through PROFIBUS or PROFINET with the PROFIsafe profile is also possible in conjunction with a fail-safe controller (F-CPU) and the DM-F PROFIsafe fail-safe digital module.

SIMOCODE pro PROFIBUS

SIMOCODE pro PROFIBUS supports, for example:

- Cyclic services (DPV0) and acyclic services (DPV1)
- Extensive diagnostics and hardware interrupts
- Time stamp with high timing precision (SIMATIC S7) for SIMOCODE pro V
- DPV1 communication after the Y-Link

SIMOCODE pro PROFINET

SIMOCODE pro PROFINET supports, for example:

- Line and ring bus topology (for 2-port devices with an integrated switch)
- Media redundancy via MRP protocol (for 2-port devices with an integrated switch)
- Operating, service and diagnostics data via standard web browser
- OPC UA server for open communication with visualization and I&C system
- NTP-synchronized time
- Interval function and measured values for power management via PROFenergy
- Module exchange without PC/memory module through proximity detection
- Extensive diagnostics and maintenance alarms

System redundancy with SIMOCODE pro PROFINET

All SIMOCODE PROFINET devices support the system redundancy mechanisms of PROFINET IO and therefore can be operated directly on fault-tolerant systems such as SIMATIC S7-400 H. As such, SIMOCODE pro can provide decisive added value also for the field level of plants in which plant availability and control system redundancy are priorities.

SIMOCODE pro Modbus RTU

SIMOCODE pro Modbus RTU supports, for example:

- Communication at 1 200/2 400/4 800/9 600/19 200 or 57 600 baud
- Access to freely parameterizable process image via Modbus RTU
- Access to all operating, service and diagnostics data via Modbus RTU

SIMOCODE pro EtherNet/IP

SIMOCODE pro EtherNet/IP supports, for example:

- Line and ring bus topology thanks to an integrated switch
- Ring structures via Device Level Ring (DLR) protocol
- Operating, service and diagnostics data via standard web browser
- NTP-synchronized time
- Parameter assignment via SIMOCODE ES V14 or higher – via local device interface and Ethernet

Monitoring and control devices

SIMOCODE 3UF motor management and control devices

SIMOCODE pro 3UF7 motor management and control devices

General data

Notes on security

In order to protect plants, systems, machines and networks against cyber threats, it is necessary to implement – and continuously maintain – a holistic, state-of-the-art industrial security concept. Siemens products and solutions represent only one component of such a concept.

For more information about the subject of Industrial Security, see www.siemens.com/industrialsecurity.

Autonomous operation

An essential feature of SIMOCODE pro is the autonomous execution of all protection and control functions, even when communication to the I&C system is interrupted. This means that even in the event of bus system or automation system failure, full functionality of the feeder is ensured or a specific behavior can be parameterized in case of such a fault, e.g. targeted shutdown of the feeder or execution of particular parameterized control mechanisms (such as reversal of the direction of rotation).

Advantages from integrated energy management

siemens.com/
energysuite

Ready for
SIMATIC
Energy Suite

As an integrated option for the TIA Portal, the SIMATIC Energy Suite couples energy management with automation efficiently, making energy consumption at your production facility transparent.

Thanks to the simplified configuration of energy-measuring components, e.g. SIMOCODE pro V, configuration effort is also clearly reduced.

Thanks to end-to-end connection with higher-level energy management systems or cloud-based services, you can seamlessly expand the recorded energy data to create a cross-site energy management system.

The advantages at a glance:

- Automatic generation of energy management data
- Integration into TIA Portal and into automation
- Simple configuration

For more information, see page 1/3 or www.siemens.com/energysuite.

Application

SIMOCODE pro is often used for automated processes where plant downtimes are very expensive (e.g. chemical, oil/gas, water/wastewater, steel or cement industries) and where it is important to prevent plant downtimes through detailed operating, service and diagnostics data or to localize faults very quickly when they occur.

SIMOCODE pro is modular and space-saving and suited especially for operation in motor control centers (MCCs) in the process industry and for power plant technology.

- Protection and control of motors in hazardous areas for types of protection EEx e/d according to ATEX directive 2014/34/EU
 - With heavy starting (paper, cement, metal and water industries)
 - In high-availability plants (chemical, oil, raw material processing industries, power plants)
- Dry-running protection of centrifugal pumps based on active power monitoring for type of protection Ex b

Use of SIMOCODE pro 3UF7 with IE3/IE4 motors

Note:

When using the SIMOCODE pro 3UF7 in conjunction with highly energy-efficient IE3/IE4 motors, please observe the information on dimensioning and configuring, see [Application Manual](#).

For more information, see [page 1/8](#).

Safety technology for SIMOCODE pro

The safe disconnection of motors in the process industry is becoming increasingly important as the result of new and revised standards and requirements in the safety technology field.

With the DM-F Local and DM-F PROFIsafe fail-safe expansion modules it is easy to integrate functions for fail-safe disconnection into the SIMOCODE pro V motor management system while retaining service-proven concepts. The strict separation of safety functions and operational functions proves particularly advantageous for planning, configuring and construction. Seamless integration into the motor management system leads to greater transparency for diagnostics and during operation of the system.

Suitable components for this purpose are the DM-F Local and DM-F PROFIsafe fail-safe expansion modules, depending on the requirements:

- The DM-F Local fail-safe digital module for when direct assignment between a fail-safe hardware shutdown signal and a motor feeder is required, or
- The DM-F PROFIsafe fail-safe digital module for when a fail-safe controller (F-CPU) creates the signal for disconnection and transmits it in a fail-safe manner through PROFIBUS/PROFIsafe or PROFINET/PROFIsafe to the motor management system

Monitoring and control devices

SIMOCODE 3UF motor management and control devices

SIMOCODE pro 3UF7 motor management and control devices

General data

Dry-running protection of centrifugal pumps with SIMOCODE pro in hazardous areas



Video: Dry-running protection redefined with SIMOCODE pro

With special versions of the current/voltage measuring modules, SIMOCODE pro enables dry-running protection of centrifugal pumps through active power monitoring and motor switch-off. This applies to centrifugal pumps with progressive flow characteristics, which are also suitable for pumping flammable media and are also installed in hazardous areas. If the active power, and thus the flow rate, falls below a minimum value, the motor – and thus the centrifugal pump – is switched off. When determining the limit values to be monitored, the user is supported by a menu-guided teach-in process in the engineering software.

Technical specifications

More information		
Technical specifications, see https://support.industry.siemens.com/cs/ww/en/ps/16337/td		Application Manual for controls with IE3/IE4 motors, see https://support.industry.siemens.com/cs/ww/en/view/94770820
Manual Collection "SIMOCODE pro", see https://support.industry.siemens.com/cs/ww/en/view/109743951		Configuration Manual for load feeders, see https://support.industry.siemens.com/cs/ww/en/view/39714188
Manual for SIMOCODE pro fail-safe digital modules, see https://support.industry.siemens.com/cs/ww/en/view/50564852		
General data		
Type		3UF7
Permissible ambient temperature		
• During operation	°C	-25 ... +60; 3UF721: 0 ... +60
• During storage and transport	°C	-40 ... +80; 3UF721: -20 ... +70
Degree of protection (acc. to IEC 60529)		
• Measurement modules with busbar connection		IP00
• Operator panel (front) and door adapter (front) with cover		IP54
• Other components		IP20
Shock resistance (sine pulse)	g/ms	15/11
Mounting position		Any
Frequency	Hz	50/60 ± 5%
EMC interference immunity (according to IEC 60947-1)		Corresponds to degree of severity 3
• Conducted interference, burst acc. to IEC 61000-4-4	kV	2 (power ports)
	kV	1 (signal port)
	V	10
• Conducted interference, high frequency acc. to IEC 61000-4-6	kV	2 (line to ground); 3UF7320-1AB, 3UF7330-1AB: 1 (line to ground)
• Conducted interference, surge acc. to IEC 61000-4-5	kV	1 (line to line); 3UF7320-1AB, 3UF7330-1AB: 0.5 (line to line)
• Electrostatic discharge, ESD acc. to IEC 61000-4-2	kV	8 (air discharge); 3UF7020: Operator input during operation only on the front
	kV	6 (contact discharge); 3UF721: 4 (contact discharge)
• Field-related interference acc. to IEC 61000-4-3	V/m	10
EMC emitted interference (according to IEC 60947-1)		
• Conducted and radiated interference emission		EN 55011/EN 55022 (CISPR 11/CISPR 22) (corresponds to degree of severity A)
Protective separation (acc. to IEC 60947-1)		All circuits in SIMOCODE pro are safely separated from each other according to IEC 60947-1, i.e. they are designed with doubled creepage distances and clearances. The instructions in the test report "Protective separation" No. A0258 must be observed.

Monitoring and control devices

SIMOCODE 3UF motor management and control devices

SIMOCODE pro 3UF7 motor management and control devices

General data

Basic units						
Type		3UF7000-1AU00-0, 3UF7010-1AU00-0, 3UF7000-1AB00-0, 3UF7010-1AB00-0, 3UF7011-1AU00-0, 3UF7020-1AU01-0, 3UF7011-1AB00-0, 3UF7020-0AB01-0, 3UF7012-1AU00-0, 3UF7013-1AU00-0, 3UF7012-1AB00-0, 3UF7013-1AB00-0				
Control circuit						
Rated control supply voltage U_s (acc. to IEC 61131-2)		110 ... 240 V AC/DC; 50/60 Hz	24 V DC			
Operating range						
<ul style="list-style-type: none"> SIMOCODE pro C (3UF7000), SIMOCODE pro V PROFIBUS (3UF7010) and SIMOCODE pro V Modbus RTU (3UF7012) SIMOCODE pro V PROFINET (3UF7011), SIMOCODE pro V EtherNet/IP (3UF7013) and SIMOCODE pro S (3UF7020) - Operation - Startup 		0.85 ... 1.1 × U_s	0.80 ... 1.2 × U_s			
		0.85 ... 1.1 × U_s	0.80 ... 1.2 × U_s			
		0.85 ... 1.1 × U_s	0.85 ... 1.2 × U_s			
Power consumption¹⁾						
<ul style="list-style-type: none"> SIMOCODE pro C (3UF7000) and SIMOCODE pro S (3UF7020) SIMOCODE pro S (3UF7020) SIMOCODE pro V PROFIBUS (3UF7010) and SIMOCODE pro V Modbus RTU (3UF7012) SIMOCODE pro V PROFINET (3UF7011) and SIMOCODE pro V EtherNet/IP (3UF7013) 		5.3 VA/2.9 W	2.3 W			
		4.7 VA/2.5 W	2.1 W			
		8.3 VA/3.6 W	2.6 W			
		8.3 VA/4.8 W	3.9 W			
Rated insulation voltage U_i	V	300 (for pollution degree 3)				
Rated impulse withstand voltage U_{imp}	kV	4				
Relay outputs						
<ul style="list-style-type: none"> Number - SIMOCODE pro C, SIMOCODE pro V (incl. SIMOCODE pro V PN GP) - SIMOCODE pro S Specified short-circuit protection for auxiliary contacts (relay outputs) - Fuse links - Miniature circuit breakers Rated uninterrupted current Rated switching capacity - AC-15 - DC-13 		3 monostable relay outputs	2 monostable relay outputs			
	A	6 A operational class gG; 10 A quick-response (IEC 60947-5-1) 1.6 A, C characteristic (IEC 60947-5-1); 6 A, C characteristic ($I_k < 500$ A) 6				
		6 A/24 V AC; 6 A/120 V AC; 3 A/230 V AC 2 A/24 V DC; 0.55 A/60 V DC; 0.25 A/125 V DC				
Inputs (binary)		4 inputs supplied internally by the device electronics (with 24 V DC) and connected to a common potential				
Thermistor motor protection (binary PTC)						
<ul style="list-style-type: none"> Summation cold resistance Response value Return value 	kΩ	≤ 1.5				
	kΩ	3.4 ... 3.8				
	kΩ	1.5 ... 1.65				
2 nd -generation current/voltage measuring modules						
Type		3UF7..0-1AA01-0	3UF7..1-1AA01-0	3UF7..2-1AA01-0	3UF7..3-1.A01-0	3UF7..4-1BA01-0
Main circuit						
Current setting I_e	A	0.3 ... 4	3 ... 40	10 ... 115	20 ... 200	63 ... 630
Rated insulation voltage U_i	V	690				
Rated operational voltage U_e	V	690				
Rated impulse withstand voltage U_{imp}	kV	6				
Rated frequency	Hz	50/60				
Type of current		Three-phase current				
Short circuit		Additional short-circuit protection is required in the main circuit				
Typical voltage measuring range						
<ul style="list-style-type: none"> Phase-to-phase voltage/line-to-line voltage (e.g. U_{L1L2}) Phase voltage (e.g. U_{L1N}) 	V	110 ... 690				
	V	65 ... 400				
Accuracy at 25 °C, 50/60 Hz						
Valid for voltage range						
Valid for current range						
	A	0.25 ... 8/	2.25 ... 80/	7.5 ... 230/	15 ... 400/	47 ... 1 260/
		8 ... 32	80 ... 320	230 ... 920	400 ... 1 600	1 260 ... 5 040
<ul style="list-style-type: none"> Voltage measurement Current measurement Temperature drift of current measurement - 3UF7110-1AA01-0 - 3UF7111-1AA01-0, 3UF7112-1AA01-0, 3UF7113-1AA01-0, 3UF7113-1BA01-0, 3UF7114-1BA01-0 Power factor measurement (p.f. ≥ 0.5) Apparent power measurement (p.f. ≥ 0.5) Active power measurement (p.f. ≥ 0.5) Energy measurement (p.f. ≥ 0.5) Frequency measurement (p.f. ≥ 0.5) 	%	± 1.5				
	%	± 1.5/3 (typical)				
	%	± 0.02 K				
	%	± 0.01 K				
	%	± 1.5/5 (typical)				
	%	± 3/5 (typical)				
	%	± 5/10 (typical)				
	%	± 5/10 (typical)				
	%	± 1.5				
Notes on voltage measurement						
<ul style="list-style-type: none"> Supply lines for voltage measurement 		In the supply lines from the main circuit for voltage measurement of SIMOCODE pro it may be necessary to provide additional line protection!				

¹⁾ Measurement conditions: Room temperature; active thermistor and 2 active inputs and outputs; bus transmission rate for PROFIBUS 1.5 Mbaud, for PROFINET 100 bps;

for pro C/pro S: 1 current measuring module and one operator panel with 2 active LEDs;
for pro V: 1 current/voltage measuring module and one operator panel with display with 2 active LEDs.

Monitoring and control devices

SIMOCODE 3UF motor management and control devices

SIMOCODE pro 3UF7 motor management and control devices

General data

Current measuring modules						
Type		3UF7100-1AA00-0	3UF7101-1AA00-0	3UF7102-1AA00-0	3UF7103-1.A00-0	3UF7104-1BA00-0
Main circuit						
Current setting I_e	A	0.3 ... 3	2.4 ... 25	10 ... 100	20 ... 200	63 ... 630
Rated insulation voltage U_i	V	690; 3UF7103 and 3UF7104: 1 000 (at pollution degree 3)				
Rated operational voltage U_e	V	690				
Rated impulse withstand voltage U_{imp}	kV	6; 3UF7103 and 3UF7104: 8				
Rated frequency	Hz	50/60				
Type of current		Three-phase current				
Short circuit		Additional short-circuit protection is required in the main circuit				
Accuracy of current measurement (in the range of 1 x minimum current setting I_u to 8 x max. current setting I_o)	%	± 3 (typical)				
Digital modules or multifunction modules						
Type		3UF7300, 3UF7310, 3UF7600				
Control circuit						
Rated insulation voltage U_i	V	300 (at pollution degree 3)				
Rated impulse withstand voltage U_{imp}	kV	4				
Relay outputs		2 monostable or bistable relay outputs (depending on the version)				
<ul style="list-style-type: none"> • Number • Specified short-circuit protection for auxiliary contacts (relay outputs) <ul style="list-style-type: none"> - Fuse links - Miniature circuit breakers • Rated uninterrupted current • Rated switching capacity <ul style="list-style-type: none"> - AC-15 - DC-13 	A	6 A operational class gG; 10 A quick-response (IEC 60947-5-1) 1.6 A, C characteristic (IEC 60947-5-1); 6 A, C characteristic ($I_k < 500$ A) 6 6 A/24 V AC; 6 A/120 V AC; 3 A/230 V AC 2 A/24 V DC; 0.55 A/60 V DC; 0.25 A/125 V DC				
Inputs (binary)		4 inputs, electrically separated, supplied externally with 24 V DC or 110 ... 240 V AC/DC depending on the version, connected to a common potential				
Ground-fault modules or multifunction modules						
Type		3UF7510, 3UF7600				
Control circuit						
Connectable residual-current transformer		3UL23				
Type of current for monitoring		Type A (AC and pulsating DC residual currents)				
Adjustable response value		30 mA ... 40 A				
Relative measurement error	%	7.5				
Temperature modules or multifunction modules						
Type		3UF7600, 3UF7700				
Sensor circuit						
Number of temperature sensors		<ul style="list-style-type: none"> • 3UF7700 • 3UF7600 3 temperature sensors 1 temperature sensor				
Typical sensor current		<ul style="list-style-type: none"> • Pt100 • Pt1000/KTY83/KTY84/NTC mA 1 0.2				
Open-circuit/short-circuit detection		<ul style="list-style-type: none"> • Sensor type <ul style="list-style-type: none"> - Open circuit - Short circuit - Measuring range 				
	°C	Pt100/Pt1000	KTY83-110	KTY84	NTC	
		✓	✓	✓	--	
		✓	✓	✓	✓	
		-50 ... +500	-50 ... +175	-40 ... +300	80 ... 160	
Measuring accuracy at 20 °C ambient temperature (T20)	K	< ± 2				
Deviations due to ambient temperature	%	0.05 per K deviation from T20				
In % of measuring range						
Conversion time	ms	500				
Connection type		Two- or three-wire connection				

- ✓ Detection possible
 -- Detection not possible

Monitoring and control devices

SIMOCODE 3UF motor management and control devices

SIMOCODE pro 3UF7 motor management and control devices

General data

Analog module								
Type	3UF74							
Control circuit								
Inputs								
• Channels		2 (passive)						
• Parameterizable measuring ranges	mA	0/4 ... 20						
• Shielding		Up to 30 m shield recommended, from 30 m shield required						
• Max. input current (destruction limit)	mA	40						
• Accuracy	%	±1						
• Input resistance	Ω	50						
• Conversion time	ms	150						
• Resolution	bit	12						
• Open-circuit detection		With measuring range 4 ... 20 mA						
Outputs								
• Channels		1						
• Parameterizable output range	mA	0/4 ... 20						
• Shielding		Up to 30 m shield recommended, from 30 m shield required						
• Max. voltage at output	V DC	30						
• Accuracy	%	±1						
• Max. output load	Ω	500						
• Conversion time	ms	25						
• Resolution	bit	12						
• Short-circuit-proof		Yes						
Connection type	Two-wire connection							
Electrical separation of inputs/output to the device electronics	No							
Fail-safe digital modules								
Type	3UF7320-1AB00-0		3UF7320-1AU00-0		3UF7330-1AB00-0		3UF7330-1AU00-0	
Control circuit								
Rated control supply voltage U_s	V	24 DC	110 ... 240 AC/DC; 50/60 Hz	24 DC	110 ... 240 AC/DC; 50/60 Hz			
Power consumption		3 W	9.5 VA/4.5 W	4 W	11 VA/5.5 W			
Rated insulation voltage	V	300						
Rated impulse withstand voltage U_{imp}	kV	4						
Relay outputs								
• Number	2 relay enabling circuits, 2 relay outputs							
Version of the fuse link For short-circuit protection of the relay enabling circuit	A	4, operational class gG						
Rated uninterrupted current	A	5						
Rated switching capacity								
• AC-15	3 A/24 V AC; 3 A/120 V AC; 1.5 A/230 V AC							
• DC-13	4 A/24 V DC; 0.55 A/60 V DC; 0.22 A/125 V DC							
Inputs (binary)	5 (with internal power supply from the device electronics)							
Cable length								
• At terminals Y22/Y34/Y12/Y33	m	1 500	1 500	--	--			
• At terminals IN1/IN2/IN3/FBC	m	--	--	300	300			
Safety data¹⁾								
SIL level max. according to IEC 61508/IEC 62061	3 for 2-channel sensor evaluation							
Achievable performance level PL according to ISO 13849-1	e for 2-channel sensor evaluation							
Achievable category according to ISO 13849-1	4 for 2-channel sensor evaluation							
Stop category according to EN 60204-1	0							
Probability of a dangerous failure for SIL 3 applications								
• Per hour (PFH _d) at a high demand rate according to IEC 62061	1/h	1.0 × 10 ⁻⁸			1.0 × 10 ⁻⁸			
• Per hour (PFD _{avg}) at a low demand rate according to IEC 61508		2.0 × 10 ⁻⁵			2.0 × 10 ⁻⁵			
T1 value for proof test interval or service duration according to IEC 61508	a	20						

¹⁾ For more safety data, see System Manual "SIMOCODE pro Safety Fail-Safe Digital Modules".

More information

Configuration instructions

When using an operator panel with display, please note that the type and number of expansion modules that can be connected are limited for the use of a SIMOCODE pro V PROFIBUS basic unit (with product version lower than E15) or SIMOCODE pro V Modbus RTU (with product version lower than E03), [see](#)

- [TIA Selection Tool](#)
- [SIMOCODE pro - Manual Collection](#)

Protective separation

All circuits in SIMOCODE pro are safely isolated from each other in accordance with IEC 60947-1. That is, they are designed with doubled creepage distances and clearances. In the event of a fault, therefore, no parasitic voltages can be formed in neighboring circuits. The notes of the test report No. A0258 must be complied with.

Types of protection EEx e and EEx d

The overload protection and the thermistor motor protection of the SIMOCODE pro system comply with the requirements for overload protection of explosion-proof motors to the type of protection:

- EEx d "Flameproof enclosure" e.g. according to IEC 60079-1
- EEx e "Increased safety" e.g. according to IEC 60079-7

When using SIMOCODE pro devices with a 24 V DC control voltage, electrical separation must be ensured using a battery or a safety transformer according to IEC 61558-2-6.

EC type test certificate: BVS 06 ATEX F 001

Test report: BVS PP 05.2029 EC.

Type of protection Ex b

The function for dry-running protection of centrifugal pumps in hazardous areas complies with the requirements of the following type of protection:

- Ex b "Control of ignition source", ignition protection system b1, e.g. according to EN 80079-37

SIMOCODE pro is registered for the dry-running protection of centrifugal pumps by means of active power monitoring according to both ATEX and IEC Ex.





Monitoring and control devices

SIMOCODE 3UF motor management and control devices

SIMOCODE pro 3UF7 motor management and control devices

Basic units **IE3/IE4 ready**

Selection and ordering data





Version	SD	Screw terminals	⊕	PU (UNIT, SET, M)	PS*	PG
	d	Article No.		Price per PU		
SIMOCODE pro PROFIBUS						
	SIMOCODE pro C PROFIBUS DP interface, 12 Mbps, RS 485, 4 I/3 O freely configurable, input for thermistor connection, monostable relay outputs Rated control supply voltage U_s : • 24 V DC • 110 ... 240 V AC/DC					
3UF7000-1AB00-0		▶ 3UF7000-1AB00-0		1	1 unit	42J
		▶ 3UF7000-1AU00-0		1	1 unit	42J
	SIMOCODE pro S PROFIBUS DP interface, 1.5 Mbps, RS 485, 4 I/2 O freely configurable, input for thermistor connection, monostable relay outputs, can be expanded by a multifunction module Note: The connecting cable to the current measuring module must be at least 15 cm. Rated control supply voltage U_s : • 24 V DC • 110 ... 240 V AC/DC					
3UF7020-1AU01-0		▶ 3UF7020-1AB01-0		1	1 unit	42J
		▶ 3UF7020-1AU01-0		1	1 unit	42J
	SIMOCODE pro V PROFIBUS DP interface, 12 Mbps, RS 485, 4 I/3 O freely configurable, input for thermistor connection, monostable relay outputs, can be expanded by expansion modules Rated control supply voltage U_s : • 24 V DC • 110 ... 240 V AC/DC					
3UF7010-1AB00-0		▶ 3UF7010-1AB00-0		1	1 unit	42J
		▶ 3UF7010-1AU00-0		1	1 unit	42J
SIMOCODE pro PROFINET						
	SIMOCODE pro V PROFINET GP ETHERNET/PROFINET IO, OPC UA server and web server, 100 Mbps, PROFINET system redundancy, 4 I/3 O freely configurable, input for thermistor connection, monostable relay outputs, can be expanded by expansion module, web server in German/English/Chinese/Russian <u>2 x connection to bus through RJ45</u> Media Redundancy Protocol Rated control supply voltage U_s : • 24 V DC • 110 ... 240 V AC/DC <u>1 x connection to bus through RJ45</u> Rated control supply voltage U_s : • 24 V DC • 110 ... 240 V AC/DC					
3UF7011-1AB00-1		▶ 3UF7011-1AB00-1		1	1 unit	42J
		▶ 3UF7011-1AU00-1		1	1 unit	42J
		▶ 3UF7011-1AB00-2		1	1 unit	42J
		▶ 3UF7011-1AU00-2		1	1 unit	42J
	SIMOCODE pro V PROFINET ETHERNET/PROFINET IO, OPC UA server and web server, 100 Mbps, 2 x connection to bus through RJ45, PROFINET system redundancy, Media Redundancy Protocol, 4 I/3 O freely configurable, input for thermistor connection, monostable relay outputs, can be expanded by expansion modules, web server in German/English/Chinese/Russian Rated control supply voltage U_s : • 24 V DC • 110 ... 240 V AC/DC					
3UF7011-1AB00-0		▶ 3UF7011-1AB00-0		1	1 unit	42J
		▶ 3UF7011-1AU00-0		1	1 unit	42J

Monitoring and control devices

SIMOCODE 3UF motor management and control devices

SIMOCODE pro 3UF7 motor management and control devices

IE3/IE4 ready **Basic units**

Version	Current setting	Width	SD	Screw terminals	⊕	PU (UNIT, SET, M)	PS*	PG					
	A	mm	d	Article No.	Price per PU								
SIMOCODE pro Modbus RTU													
	SIMOCODE pro V Modbus RTU												
	Modbus RTU interface, 57.6 Kbps, RS 485, 4 I/3 O freely configurable, input for thermistor connection, monostable relay outputs, can be expanded by expansion modules Rated control supply voltage U_s : <ul style="list-style-type: none"> • 24 V DC • 110 ... 240 V AC/DC 												
3UF7012-1A.00-0				▶	3UF7012-1AB00-0	1	1 unit	42J					
				▶	3UF7012-1AU00-0	1	1 unit	42J					
SIMOCODE pro EtherNet/IP													
	SIMOCODE pro V EtherNet/IP												
	EtherNet/IP interface, web server, 100 Mbps, 2 x connection to bus through RJ45, DLR media redundancy, 4 I/3 O freely configurable, input for thermistor connection, monostable relay outputs, can be expanded by expansion modules, web server in German/English/Chinese/Russian Rated control supply voltage U_s : <ul style="list-style-type: none"> • 24 V DC • 110 ... 240 V AC/DC 												
3UF7013-1AB00-0				▶	3UF7013-1AB00-0	1	1 unit	42J					
				▶	3UF7013-1AU00-0	1	1 unit	42J					
SIMOCODE pro current or current/voltage measuring modules													
	Current measuring modules												
	• Straight-through transformers	0.3 ... 3	45						▶	3UF7100-1AA00-0	1	1 unit	42J
		2.4 ... 25	45						▶	3UF7101-1AA00-0	1	1 unit	42J
		10 ... 100	55						▶	3UF7102-1AA00-0	1	1 unit	42J
		20 ... 200	120						▶	3UF7103-1AA00-0	1	1 unit	42J
	• Busbar connection ¹⁾	20 ... 200	120						▶	3UF7103-1BA00-0	1	1 unit	42J
	63 ... 630	145	▶	3UF7104-1BA00-0	1	1 unit	42J						
3UF7103-1AA00-0													
	2nd generation current/voltage measuring modules for SIMOCODE pro V²⁾												
	Voltage measuring up to 690 V, measured values with increased accuracy, power, power factor and frequency monitoring												
	• Straight-through transformers	0.3 ... 4	45						▶	3UF7110-1AA01-0	1	1 unit	42J
		3 ... 40	45						▶	3UF7111-1AA01-0	1	1 unit	42J
		10 ... 115	55						▶	3UF7112-1AA01-0	1	1 unit	42J
		20 ... 200	120						▶	3UF7113-1AA01-0	1	1 unit	42J
• Busbar connection ¹⁾	20 ... 200	120	▶	3UF7113-1BA01-0	1	1 unit	42J						
	63 ... 630	145	▶	3UF7114-1BA01-0	1	1 unit	42J						
3UF7110-1AA01-0													
	Current/voltage measuring modules for dry-running protection of centrifugal pumps in hazardous areas²⁾³⁾⁴⁾												
	• Straight-through transformers	0.3 ... 4	45						▶	3UF7120-1AA01-0	1	1 unit	42J
		3 ... 40	45						▶	3UF7121-1AA01-0	1	1 unit	42J
		10 ... 115	55						▶	3UF7122-1AA01-0	1	1 unit	42J
		20 ... 200	120						▶	3UF7123-1AA01-0	1	1 unit	42J
	• Busbar connection ¹⁾	20 ... 200	120						▶	3UF7123-1BA01-0	1	1 unit	42J
	63 ... 630	145	▶	3UF7124-1BA01-0	1	1 unit	42J						
3UF7123-1AA01-0													

¹⁾ One terminal parts kit 3RT1955-4PA00 or 3RT1966-4PA00 (see page 10/24) is included in the scope of supply for connection to a contactor.

²⁾ When installing the basic unit on a current/voltage measuring module, the connecting cable must be at least 15 cm long.

³⁾ The current/voltage measuring modules for dry-running protection require SIMOCODE pro V PROFIBUS basic units as of product version E16, SIMOCODE pro V PROFINET as of product version E13 or SIMOCODE pro V EtherNet/IP as of product version E04.

⁴⁾ When using an operator panel with display with the current/voltage measuring modules for dry-running protection, an operator panel with display as of product version E03 is required.

Note:



SIMOCODE pro V basic unit in a hardened version via SIPLUS extreme upon request.

Monitoring and control devices

SIMOCODE 3UF motor management and control devices

SIMOCODE pro 3UF7 motor management and control devices

Basic units **IE3/IE4 ready**

Version	SD	Screw terminals	⊕	PU (UNIT, SET, M)	PS*	PG
	d	Article No.	Price per PU			
SIMOCODE pro operator panels						
Operator panels						
		Installation in control cabinet door or front plate, for plugging into all SIMOCODE pro basic units, ten LEDs for status indication and user-assignable buttons for controlling the motor, titanium gray	▶	3UF7200-1AA01-0	1	1 unit 42J
3UF7200-1AA01-0						
Operator panels with display for SIMOCODE pro V						
		Installation in control cabinet door or front plate, for plugging into SIMOCODE pro V, seven LEDs for status indication and user-assignable buttons for controlling the motor, multilingual display, e.g. for indication of measured values, status information or fault messages, titanium gray				
		• English/German/French/Spanish/Portuguese/Italian/Polish/Finnish	▶	3UF7210-1AA01-0	1	1 unit 42J
3UF7210-1.A01-0		• English/Chinese/Russian/Korean	▶	3UF7210-1BA01-0	1	1 unit 42J

Monitoring and control devices

SIMOCODE 3UF motor management and control devices

SIMOCODE pro 3UF7 motor management and control devices

Expansion modules

Selection and ordering data

Version	SD	Screw terminals	PU (UNIT, SET, M)	PS*	PG
	d	Article No.	Price per PU		

Expansion modules for SIMOCODE pro V

With SIMOCODE pro V, it is possible to expand the type and number of inputs and outputs in steps. Each expansion module has two system interfaces on the front. Through the one system interface the expansion module is connected to the system interface of the SIMOCODE pro V using a connecting cable; through the second system interface, further expansion modules or the operator panel can be connected. The power supply for the expansion modules is provided by the connecting cable through the basic unit.

Notes:

The SIMOCODE pro V PN GP basic unit can be used with the 3UF7300-1A.00-0 monostable digital module, the 3UF7510-1AA00-0 ground-fault module, or the 3UF7700-1AA0-0 temperature module.

Please order connecting cable separately, [see page 10/22](#).

Digital modules

Up to two digital modules can be used to add additional binary inputs and relay outputs to the basic unit. The input circuits of the digital modules are supplied from an external power supply.

Four binary inputs and two relay outputs, up to two digital modules can be connected

Relay outputs	Input voltage				
Monostable	24 V DC	▶	3UF7300-1AB00-0	1	1 unit 42J
	110 ... 240 V AC/DC	▶	3UF7300-1AU00-0	1	1 unit 42J
Bistable	24 V DC	▶	3UF7310-1AB00-0	1	1 unit 42J
	110 ... 240 V AC/DC	▶	3UF7310-1AU00-0	1	1 unit 42J



3UF7300-1AB00-0

Analog modules

By means of the analog module, the basic unit can be optionally expanded by analog inputs and outputs (0/4 ... 20 mA).

Two inputs (passive) for input and one output for output of 0/4 ... 20 mA signals, max. one analog module can be connected per pro V PB/MB RTU basic unit and max. two analog modules per pro V PN/EIP basic unit

▶	3UF7400-1AA00-0	1	1 unit	42J
---	------------------------	---	--------	-----



3UF7400-1AA00-0

Ground-fault modules

Ground-fault monitoring using 3UL23 residual-current transformers and ground-fault modules is used in cases where precise detection of the ground-fault current is required or power systems with high impedance are grounded.

With the ground-fault module, it is possible to determine the precise fault current as a measured value, and to define freely selectable warning and trip limits in a wide range from 30 mA ... 40 A.

One input for connecting a 3UL23 residual-current transformer, up to one ground-fault module can be connected

Note:

For corresponding residual-current transformers, [see page 10/88](#).

▶	3UF7510-1AA00-0	1	1 unit	42J
---	------------------------	---	--------	-----



3UF7510-1AA00-0

Temperature modules

Irrespective of the thermistor motor protection of the basic units, up to an additional three analog temperature sensors can be evaluated using a temperature module.

Sensor types: Pt100/Pt1000, KTY83/KTY84 or NTC

Three inputs for connecting up to three analog temperature sensors, up to one temperature module can be connected per pro V PB/MB RTU basic unit and up to two temperature modules per pro V PN/EIP basic unit

▶	3UF7700-1AA00-0	1	1 unit	42J
---	------------------------	---	--------	-----



3UF7700-1AA00-0

Monitoring and control devices

SIMOCODE 3UF motor management and control devices

SIMOCODE pro 3UF7 motor management and control devices

Expansion modules

Version	SD	Screw terminals 	PU (UNIT, SET, M)	PS*	PG
	d	Article No.	Price per PU		

Expansion modules for SIMOCODE pro S

With SIMOCODE pro S, it is possible to expand the type and number of inputs and outputs. The expansion module has two system interfaces on the front. Through the one system interface the expansion module is connected to the system interface of the SIMOCODE pro S using a connecting cable; through the second system interface, the operator panel can be connected. The power supply for the expansion module is provided by the connecting cable through the basic unit.

Note:

Please order connecting cable separately, see page 10/22.

Multifunction modules

The multifunction module is the expansion module of the SIMOCODE pro S device series with the following functions:

- Digital module function with four digital inputs and two monostable relay outputs
- Ground-fault module function with an input for the connection of a 3UL23 residual-current transformer with freely selectable warning and trip limits in a wide zone of 30 mA ... 40 A
- Temperature module function with an input for connecting an analog temperature sensor Pt100, Pt1000, KTY83, KTY84, or NTC

Max. one multifunction module can be connected per pro S basic unit

Input voltage of the digital inputs:

- 24 V DC
- 110 ... 240 V AC/DC



3UF7600-1AU01-0

▶	3UF7600-1AB01-0	1	1 unit	42J
▶	3UF7600-1AU01-0	1	1 unit	42J

Monitoring and control devices

SIMOCODE 3UF motor management and control devices

SIMOCODE pro 3UF7 motor management and control devices

Fail-safe expansion modules

Selection and ordering data

Version	SD	Screw terminals		PU (UNIT, SET, M)	PS*	PG
	d	Article No.	Price per PU			

Fail-safe expansion modules for SIMOCODE pro V

Thanks to the fail-safe expansion modules, SIMOCODE pro V can be expanded with the function of a safety relay for the fail-safe disconnection of motors. A maximum of one fail-safe digital module can be connected; it can be used instead of a digital module.

The fail-safe expansion modules are equipped likewise with two system interfaces at the front for making the connection to other system components. Unlike other expansion modules, power is supplied to the modules through a separate terminal connection.

Note:

Please order connecting cable separately, see page 10/22.

DM-F Local fail-safe digital modules

For fail-safe disconnection using a hardware signal
Two relay enabling circuits, joint switching; two relay outputs, common potential disconnected fail-safe; inputs for sensor circuit, start signal, cascading and feedback circuit, safety function adjustable using DIP switches

Rated control supply voltage U_s :

- 24 V DC
- 110 ... 240 V AC/DC

▶ 3UF7320-1AB00-0	1	1 unit	42J
▶ 3UF7320-1AU00-0	1	1 unit	42J

DM-F PROFIsafe fail-safe digital modules¹⁾

For fail-safe disconnection using PROFIBUS/PROFIsafe or PROFINET/PROFIsafe

Two relay enabling circuits, joint switching; two relay outputs, common potential disconnected fail-safe; one input for feedback circuit; three binary standard inputs

Rated control supply voltage U_s :

- 24 V DC
- 110 ... 240 V AC/DC

▶ 3UF7330-1AB00-0	1	1 unit	42J
▶ 3UF7330-1AU00-0	1	1 unit	42J



3UF7320-1AB00-0



3UF7330-1AB00-0

¹⁾ Cannot be used in conjunction with SIMOCODE pro V for Modbus RTU or EtherNet/IP communication.





Monitoring and control devices

SIMOCODE 3UF motor management and control devices

SIMOCODE pro 3UF7 motor management and control devices

Accessories

Selection and ordering data





Version	SD	Article No.	Price per PU	PU (UNIT, SET, M)	PS*	PG																																																									
Connecting cables (essential accessory)																																																															
 <p>In different lengths for connecting basic unit, current measuring module, current/voltage measuring module, operator panel or expansion modules</p>																																																															
<table border="1"> <thead> <tr> <th>Version</th> <th>Length</th> <th></th> <th></th> <th></th> <th></th> <th></th> </tr> </thead> <tbody> <tr> <td rowspan="5">Flat</td> <td>0.025 m</td> <td>▶</td> <td>3UF7930-0AA00-0</td> <td>1</td> <td>1 unit</td> <td>42J</td> </tr> <tr> <td>0.1 m</td> <td>▶</td> <td>3UF7931-0AA00-0</td> <td>1</td> <td>1 unit</td> <td>42J</td> </tr> <tr> <td>0.15 m</td> <td>▶</td> <td>3UF7934-0AA00-0</td> <td>1</td> <td>1 unit</td> <td>42J</td> </tr> <tr> <td>0.3 m</td> <td>▶</td> <td>3UF7935-0AA00-0</td> <td>1</td> <td>1 unit</td> <td>42J</td> </tr> <tr> <td>0.5 m</td> <td>▶</td> <td>3UF7932-0AA00-0</td> <td>1</td> <td>1 unit</td> <td>42J</td> </tr> <tr> <td rowspan="3">Round</td> <td>0.5 m</td> <td>▶</td> <td>3UF7932-0BA00-0</td> <td>1</td> <td>1 unit</td> <td>42J</td> </tr> <tr> <td>1.0 m</td> <td>▶</td> <td>3UF7937-0BA00-0</td> <td>1</td> <td>1 unit</td> <td>42J</td> </tr> <tr> <td>2.5 m</td> <td>▶</td> <td>3UF7933-0BA00-0</td> <td>1</td> <td>1 unit</td> <td>42J</td> </tr> </tbody> </table>							Version	Length						Flat	0.025 m	▶	3UF7930-0AA00-0	1	1 unit	42J	0.1 m	▶	3UF7931-0AA00-0	1	1 unit	42J	0.15 m	▶	3UF7934-0AA00-0	1	1 unit	42J	0.3 m	▶	3UF7935-0AA00-0	1	1 unit	42J	0.5 m	▶	3UF7932-0AA00-0	1	1 unit	42J	Round	0.5 m	▶	3UF7932-0BA00-0	1	1 unit	42J	1.0 m	▶	3UF7937-0BA00-0	1	1 unit	42J	2.5 m	▶	3UF7933-0BA00-0	1	1 unit	42J
Version	Length																																																														
Flat	0.025 m	▶	3UF7930-0AA00-0	1	1 unit	42J																																																									
	0.1 m	▶	3UF7931-0AA00-0	1	1 unit	42J																																																									
	0.15 m	▶	3UF7934-0AA00-0	1	1 unit	42J																																																									
	0.3 m	▶	3UF7935-0AA00-0	1	1 unit	42J																																																									
	0.5 m	▶	3UF7932-0AA00-0	1	1 unit	42J																																																									
Round	0.5 m	▶	3UF7932-0BA00-0	1	1 unit	42J																																																									
	1.0 m	▶	3UF7937-0BA00-0	1	1 unit	42J																																																									
	2.5 m	▶	3UF7933-0BA00-0	1	1 unit	42J																																																									
PC cables and adapters																																																															
 <p>USB PC cables ▶ 3UF7941-0AA00-0 1 1 unit 42J</p> <p>For connecting to the USB interface of a PC/PG, for communication with SIMOCODE pro through the system interface</p>																																																															
<p>USB/serial adapters 2 3UF7946-0AA00-0 1 1 unit 42J</p> <p>For connecting an RS 232 PC cable to the USB interface of a PC</p>																																																															
Memory modules																																																															
 <p>Enable transmission to a new system, e.g. when a device is replaced, without the need for additional aids or detailed knowledge of the device</p>																																																															
<p>Memory modules for SIMOCODE pro C ▶ 3UF7900-0AA01-0 1 1 unit 42J</p> <p>For saving the complete parameterization of a SIMOCODE pro C system, titanium gray</p>																																																															
<p>Memory modules for SIMOCODE pro S and pro V ▶ 3UF7901-0AA01-0 1 1 unit 42J</p> <p>For saving the complete parameterization of a SIMOCODE pro system, titanium gray</p>																																																															
Interface covers																																																															
 <p>For system interface, titanium gray 10 3RA6936-0B 1 5 units 42F</p>																																																															
Addressing plugs																																																															
 <p>For assigning the PROFIBUS or Modbus RTU address without using a PC/PG to SIMOCODE pro through the system interface ▶ 3UF7910-0AA00-0 1 1 unit 42J</p>																																																															

Monitoring and control devices

SIMOCODE 3UF motor management and control devices

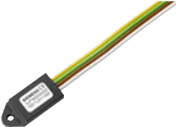
SIMOCODE pro 3UF7 motor management and control devices

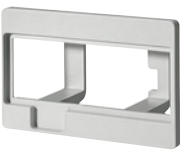
Accessories







Version	SD	Article No.	Price per PU	PU (UNIT, SET, M)	PS*	PG																								
Accessories for motor control centers																														
 3UF7902-0AA00-0		<p>With the draw-out technology often used in motor control centers it is possible to integrate a SIMOCODE pro initialization module in the switchboard on a permanent basis. Feeder-related parameter and address data can then be permanently assigned to this feeder.</p> <p>Initialization modules</p> <p>▶ 3UF7902-0AA00-0</p> <p>For automatic parameterization of SIMOCODE pro S and SIMOCODE pro V basic units (pro V PROFIBUS basic units from product version E09)</p> <p>Y connecting cables</p> <p>For use in conjunction with the initialization module; connects the basic unit, current measuring module or current/voltage measuring module, and initialization module</p> <table border="1" style="width: 100%; border-collapse: collapse;"> <tr> <th style="width: 50%;">System interface length</th> <th style="width: 50%;">Open cable end</th> <th style="width: 5%;"></th> <th style="width: 15%;"></th> <th style="width: 10%;"></th> <th style="width: 10%;"></th> </tr> <tr> <td>0.1 m</td> <td>1.0 m</td> <td>▶</td> <td>3UF7931-0CA00-0</td> <td>1</td> <td>1 unit 42J</td> </tr> <tr> <td>0.5 m</td> <td>1.0 m</td> <td>▶</td> <td>3UF7932-0CA00-0</td> <td>1</td> <td>1 unit 42J</td> </tr> <tr> <td>1.0 m</td> <td>1.0 m</td> <td>▶</td> <td>3UF7937-0CA00-0</td> <td>1</td> <td>1 unit 42J</td> </tr> </table>	System interface length	Open cable end					0.1 m	1.0 m	▶	3UF7931-0CA00-0	1	1 unit 42J	0.5 m	1.0 m	▶	3UF7932-0CA00-0	1	1 unit 42J	1.0 m	1.0 m	▶	3UF7937-0CA00-0	1	1 unit 42J				
	System interface length	Open cable end																												
	0.1 m	1.0 m	▶	3UF7931-0CA00-0	1	1 unit 42J																								
	0.5 m	1.0 m	▶	3UF7932-0CA00-0	1	1 unit 42J																								
1.0 m	1.0 m	▶	3UF7937-0CA00-0	1	1 unit 42J																									
Bus connection terminals																														
 3UF7960-0AA00-0		<p>For shield support and strain relief of the PROFIBUS cable ▶</p> <p>▶ 3UF7960-0AA00-0</p>		1	1 unit	42J																								
	Door adapters																													
 3UF7920-0AA00-0		<p>For external connection of the system interface, e.g. outside a control cabinet ▶</p> <p>▶ 3UF7920-0AA00-0</p>		1	1 unit	42J																								
	Adapters for operator panel																													
 3UF7922-0AA00-0		<p>The adapter enables the smaller 3UF7200 operator panel from SIMOCODE pro to be used in a front panel cutout in which previously, e.g. after a change of system, a larger 3UF52 operator panel from SIMOCODE-DP had been used, degree of protection IP54 ▶</p> <p>▶ 3UF7922-0AA00-0</p>		1	1 unit	42J																								
	Labeling strips																													
 3UF7925-0AA02-0		<p>• For pushbuttons of the 3UF720 operator panel ▶</p> <p>▶ 3UF7925-0AA00-0</p>		100	400 units	42J																								
		<p>• For pushbuttons of the 3UF721 operator panel with display ▶</p> <p>▶ 3UF7925-0AA01-0</p>		100	600 units	42J																								
		<p>• For LEDs of the 3UF720 operator panel ▶</p> <p>▶ 3UF7925-0AA02-0</p>		100	1200 units	42J																								
Push-in lugs																														
 3RV2928-0B		<p>For screw fixing, e.g. on mounting plate, 2 units required per device</p> <p>• Can be used for 3UF71.0, 3UF71.1 and 3UF71.2 2</p> <p>• Can be used for 3UF700, 3UF701, 3UF73, 3UF74, 3UF75 5 and 3UF77</p> <p>• Can be used for 3UF7020, 3UF7600 2</p>		100	10 units	41E																								
			▶ 3RV2928-0B																											
			▶ 3RP1903		1	10 units	41H																							
						▶ 3ZY1311-0AA00		1	10 units	41L																				

Monitoring and control devices

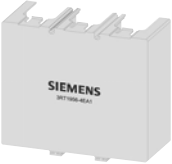
SIMOCODE 3UF motor management and control devices

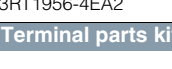
SIMOCODE pro 3UF7 motor management and control devices

Accessories

Version	SD	Article No.	Price per PU	PU (UNIT, SET, M)	PS*	PG	
Terminal covers							
 3RT1956-4EA1	Covers for cable lugs and busbar connections						
	<ul style="list-style-type: none"> Length 100 mm, can be used for 3UF71.3-1BA0.-0 Length 120 mm, can be used for 3UF71.4-1BA0.-0 	1 5	3RT1956-4EA1 3RT1966-4EA1		1 1	1 unit 1 unit	41B 41B
 3RT1956-4EA2	Covers for box terminals						
	<ul style="list-style-type: none"> Length 25 mm, can be used for 3UF71.3-1BA0.-0 Length 30 mm, can be used for 3UF71.4-1BA0.-0 	1 5	3RT1956-4EA2 3RT1966-4EA2		1 1	1 unit 1 unit	41B 41B
 3RT1956-4EA2	Covers for screw terminals						
	Between contactor and current measuring module or current/voltage measuring module for direct mounting <ul style="list-style-type: none"> Can be used for 3UF71.3-1BA0.-0 Can be used for 3UF71.4-1BA0.-0 	1 5	3RT1956-4EA3 3RT1966-4EA3		1 1	1 unit 1 unit	41B 41B
Terminal parts kit							
	Can be used for current and/or current/voltage measuring modules with standard mounting rail connection, complete for one contactor						
	<ul style="list-style-type: none"> M 8 x 25 M 10 x 30 	5 5	3RT1955-4PA00 3RT1966-4PA00		1 1	1 unit 1 unit	41B 41B
Box terminal blocks							
 3RT195.-4G	For round and ribbon cables						
	<ul style="list-style-type: none"> Up to 70 mm², can be used for 3UF71.3-1BA0.-0 Up to 120 mm², can be used for 3UF71.3-1BA0.-0 Up to 240 mm², can be used for 3UF71.4-1BA0.-0 	1 1 1	3RT1955-4G 3RT1956-4G 3RT1966-4G		1 1 1	1 unit 1 unit 1 unit	41B 41B 41B
Bus termination modules							
 3UF1900-1KA00	With separate control supply voltage for bus termination following the last unit on the bus line						
	Supply voltage: <ul style="list-style-type: none"> 115/230 V AC 24 V DC 	5 5	3UF1900-1KA00 3UF1900-1KB00		1 1	1 unit 1 unit	42J 42J
Software							
 3ZS1322...	SIMOCODE ES (TIA Portal)						
	Software for configuring, commissioning, operating and diagnosing SIMOCODE pro based on the TIA Portal, see page 14/12.						
 3ZS1632-1XE04-0YA0	SIMOCODE pro block library for SIMATIC PCS 7						
	The PCS 7 block library can be used for simple and easy integration of SIMOCODE pro into the SIMATIC PCS 7 process control system, see page 14/15.						
SIRIUS Asset Monitor							
The MindSphere app enables access to the SIMOCODE pro motor management system anytime and anywhere and provides detailed information about the device status as well as fault messages and warnings, see page 14/26.							

Monitoring and control devices

SIMOCODE 3UF motor management and control devices

3UF18 current transformers for overload protection

Basic units and accessories

Overview



More information

Homepage, see www.siemens.com/sirius

Industry Mall, see www.siemens.com/product?3UF18

The 3UF18 current transformers are protection transformers and are used for actuating overload relays. Protection transformers are designed to ensure proportional current transfer up to a multiple of the primary rated current. The 3UF18 current transformers convert the maximum current of the corresponding operating range into the standard value of 1 A secondary.

Selection and ordering data

Type of mounting	Operating range	SD	Screw terminals 	PU (UNIT, SET, M)	PS*	PG
	A	d	Article No.	Price per PU		
For mounting on contactors and stand-alone installation						
 3UF1868	Screw fixing	205 ... 820	X	3UF1868-3GA00	1	1 unit 42J

Accessories

For contactor type	SD	Article No.	Price per PU	PU (UNIT, SET, M)	PS*	PG
	d					
Terminal covers						
For transformer/contactor combinations and stand-alone installation for 3UF1868-3GA00 transformer <u>Note:</u> One cover required per connection side.	2	3TX7696-0A		1	1 unit	41B

Monitoring and control devices

LOGO! logic modules

Overview



More information

Homepage, see www.siemens.com/LOGO

Industry Mall, see www.siemens.com/product?logo

LOGO!, see Catalog ST 70

- The compact, user-friendly, and low-cost solution for simple control tasks
- Compact, user-friendly, can be used universally without accessories
- All in one: The display and operator panel are integrated
- 36 different functions can be linked at a press of a button or with PC software; up to 130 times in total
- LOGO! 8: 38/43 different functions can be linked at a press of a button or with PC software; up to 200/400 times in total
- Functions can be changed simply with the press of a button. No complicated rewiring

LOGO! logic modules

LOGO! basic modules with display



The space-saving basic versions

LOGO! basic modules without display



The cost-optimized basic versions

LOGO! expansion modules



Digital and analog inputs/outputs for connection to LOGO!

LOGO! CMK2000 communications module



For integration of LOGO! 8 in KNX installations

LOGO! CSM unmanaged



For connecting to Industrial Ethernet in line, tree or star topologies

LOGO! CMR (wireless communication)



For configuring a low-cost remote signaling system

LOGO!Power



The flat power supply for distribution boards

LOGO!Contact switching module



For switching resistive loads and motors directly

LOGO! software



The user-friendly software for switching program generation

Application

The LOGO! logic module is the user-friendly, low-cost solution for simple control tasks.

LOGO! is universally applicable, e.g.:

- Building installation and wiring (lighting, shutters, awnings, doors, access control, barriers, ventilation systems, etc.)
- Control cabinet installation
- Machine and device construction (pumps, small presses, compressors, hydraulic lifts, conveyors, etc.)

- Special controls for conservatories and greenhouses
- Signal preprocessing for other controllers

LOGO! Modular logic modules can be expanded easily for each application.

Marine approvals:

American Bureau of Shipping, Bureau Veritas, Det Norske Veritas, Germanischer Lloyd, Lloyd's Register of Shipping, Polski Rejestr Statków, etc.

Overview



7PV15, SIRIUS 3RP25 and SIRIUS 3RP20 timing relays

More information

Homepage, see www.siemens.com/sirius-timing-relays

Industry Mall, see www.siemens.com/product?3RP

Electronic timing relays are used in control, starting, and protective circuits for all switching operations involving time delays.

Their fully developed concept and space-saving, compact design make the SIRIUS 3RP timing relays ideal timer modules for control cabinet, switchgear and control manufacturers in the industry.

With their narrow design, the 7PV15 timing relays are ideal in particular for use in heating, ventilation and air-conditioning systems and in compressors. All 7PV15 timing relays in this enclosure version are suitable for snap-on mounting on TH 35 standard mounting rails according to IEC 60175. The enclosure complies with DIN 43880.

The SIRIUS 3RA28 function modules enable the assembly of starters and contactor assemblies for direct-on-line and wye-delta starting. They include the key control functions required for the particular feeder, e.g. timing and electrical interlocking. The function modules that function as timing relays are mounted quickly and simply on SIRIUS contactors – without any great wiring effort.

The SIRIUS 3RA28 solid-state time-delay auxiliary switches which can be mounted on contactors are designed for contactor coil voltages in the range from 24 to 240 V AC/DC (wide voltage range). Auxiliary switches for control and alarm signals are used specially for switching the smallest signals for electronics applications. They are used, for example, for allowing a pump or fan to run on, or for the delayed activation of a gate drive.

Simply by being plugged in place, the SIRIUS 3RT19 timing relays enable different functionalities required for the assembly of starters to be realized in the feeder. At the same time the timing relays for mounting on contactors reduce the wiring work required within the feeder and save space in the control cabinet.

Device series

SIRIUS timing relays for standard rail mounting

- SIRIUS 3RP25 timing relays, 17.5 mm and 22.5 mm, see page 10/28
- SIRIUS 3RP20 timing relays, 45 mm, see page 10/40
- 7PV15 timing relays, 17.5 mm, see page 10/46

SIRIUS timing relays for mounting on contactors

- SIRIUS 3RA28 solid-state time-delay auxiliary switches for mounting on 3RT2 contactors and 3RH2 contactor relays, see page 3/104
- SIRIUS 3RA28 function modules for mounting on 3RT2 contactors and 3RH2 contactor relays, see page 3/109
- SIRIUS 3RT19 timing relays for mounting on 3RT1 contactors, see page 3/105

Benefits

- The right design for every application
- Clear-cut basic range with five basic units in the case of the 7PV15 timing relays, and up to seven basic units in the case of the 3RP timing relays
- Considerable logistical advantages thanks to versions with wide voltage and wide time setting range
- No tools required for assembly or disassembly on standard mounting rails
- Cadmium-free relay contacts
- Recyclable, halogen-free enclosure
- Optimum price/performance ratio
- Versions with logical separation
- Low variance: One design for distribution boards and for control cabinets
- Compliance with EMC requirements for buildings
- Environmentally friendly laser inscription instead of printing containing solvents
- Versions as snap-on modules for reducing wiring and saving space in the control cabinet
- Versions with coated printed circuit board
- Versions with screw terminals or alternatively with spring-loaded terminals

Application

Timing relays with ON-delay

- Interference pulse suppression (gating of interference pulses)
- Gradual startup of motors so as not to overload the power supply

Timing relays with OFF-delay

- Generation of overtravel functions following removal of voltage
- Gradual, delayed shutdown, e.g. of motors or fans, to allow a plant to be shut down selectively

Clock-pulse relay

- Flashing, asymmetrical

Wye-delta timing relays

- Switching over motors from wye to delta with a dead interval of 50 ms to prevent phase-to-phase short circuits

Multifunctional timing relays

- Maximum flexibility, with a device for every application
- Available with relay and semiconductor output
- Versions for railway applications for more exacting requirements (e.g. temperature range, vibration/shock resistance and EMC)

Watchdog function

- Monitoring of cyclic events

Monitoring and control devices

Relays

Timing relays

SIRIUS 3RP25 timing relays, 17.5 mm and 22.5 mm

Overview

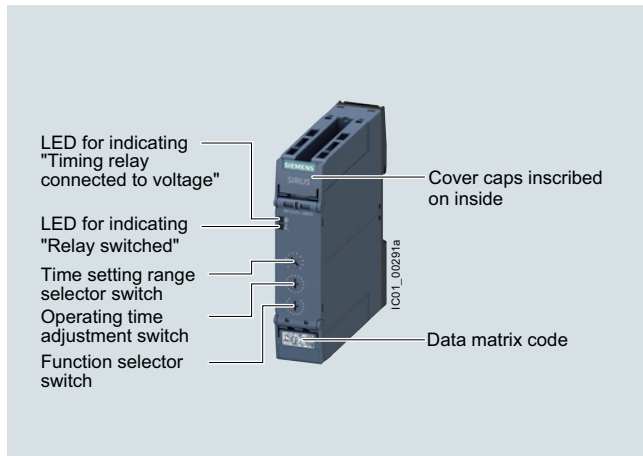

SIRIUS 3RP25 timing relay

More information

Homepage, see www.siemens.com/sirius-timing-relays

Industry Mall, see www.siemens.com/product?3RP25

Conversion tool, see www.siemens.com/conversion-tool

Simulator, see <https://support.industry.siemens.com/cs/ww/en/view/103556391>

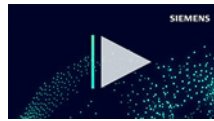

Video: [What are the benefits of SIRIUS 3RP25 timing relay?](#)

Electronic timing relays for general use in control systems and mechanical engineering with:

- 1 or 2 CO, 1 NO (semiconductor) or 3 NO
- Monofunction or multifunction
- Combination voltage or wide voltage range
- Single or selectable time setting ranges
- Switch position indication and voltage indication by LED
- Versions with coated printed circuit board

Article No. scheme

Product versions		Article number								
Timing relays		3RP25	□	□	□	□	□			
Product function/ time setting ranges	Multifunction	0	5					7 time ranges 0.05 s ... 100 h		
	ON-delay	1	1					1 time range 0.5 ... 10 s		
		1	2					1 time range 1 ... 3 s		
		1	3					1 time range 5 ... 100 s		
		2	5					7 time ranges 0.05 s ... 100 h		
		2	7					4 time ranges 0.05 s ... 240 s		
		3	5					7 time ranges 0.05 s ... 100 h		
		4	0					7 time ranges 0.05 s ... 600 s		
	OFF-delay with control signal	3	5					7 time ranges 0.05 s ... 100 h		
	OFF-delay without control signal, non-volatile, passing make contact	4	0					7 time ranges 0.05 s ... 600 s		
Clock-pulse relay, flashing, asymmetrical	5	5					7 time ranges 0.05 s ... 100 h			
Wye-delta function with coasting function (idling)	6	0					Wye-delta 1 ... 20 s, coasting time (idling) 600 s			
Wye-delta function	7	4					1 time range 1 ... 20 s			
		7	6				1 time range 3 ... 60 s			
Connection type	Screw terminals					1				
	Spring-loaded terminals (push-in)					2				
Contacts	1 CO						A			
	2 CO						B			
	Semiconductors (transistor NPN)						C			
	Semiconductors (thyristor), two-wire						E			
	1 NO + 1 NO (SD)						N			
	2 CO force-guided						R			
	3 NO						S			
Control supply voltage	24 V AC/DC						B	3		
	200 ... 240 V/380 ... 440 V AC						M	2		
	400 ... 440 V AC						T	2		
	12 ... 240 V AC/DC or 24 ... 240 V AC/DC (3RP2505-.RW30)						W	3		
Special versions	With coated printed circuit board							0 A X 0		
Example		3RP25	0	5	-	1	A	B	3	0

Note:

The Article No. scheme shows an overview of product versions for better understanding of the logic behind the article numbers.

For your orders, please use the article numbers quoted in the selection and ordering data.

3RP2505 multifunctional timing relays**Two setting options for implementing the multifunctions (A-M):**

- ① Determination of 13 functions by the setting A to M, with 1 CO, 1 NO, 2 CO that switch in parallel.
- ② Extended function variance by selecting the time range and determining, whether 2 CO switch in parallel or whether 1 CO switches with delay + 1 CO switches immediately (1 CO + 1 CO)

Setting the functions on the device

The functions of the 3RP2505 multifunctional timing relays can be set by means of the function selector switch. Whether both CO contacts are switched in parallel or one CO contact with a delay and one instantaneously and the choice of time setting range are set by means of the time setting range selector switch. The exact operating time can be adjusted with the operating time switch.

Overview of functions

Identifica- tion letter	13 functions	27 functions
	1 CO contact (1 CO), 1 NO contact (1 NO) semiconductor, 2 CO contacts switched in parallel (2 CO) or 2 CO contacts force-guided and switched in parallel with delay (2 CO)	13 functions (A - M) 2 CO contacts switched in parallel (2 CO) + 13 functions (A - M) 1 delayed CO contact + 1 instantaneous CO contact (1 CO + 1 CO) and wye-delta function
A	ON-delay	ON-delay and instantaneous contact
B	OFF-delay with control signal	OFF-delay with control signal and instantaneous contact
C	ON-delay/OFF-delay with control signal	ON-delay/OFF-delay with control signal and instantaneous contact
D	Flashing, symmetrical, starting with interval	Flashing, symmetrical, starting with interval and instantaneous contact
E	Passing make contact, interval relay	Passing make contact, interval relay and instantaneous contact
F	Retriggerable interval relay with deactivated control signal (passing break contact with control signal)	Retriggerable interval relay with deactivated control signal (passing break contact with control signal) and instantaneous contact
G	Passing make contact, with control signal, not retriggerable (pulse-forming with control signal)	Passing make contact, with control signal, not retriggerable, (pulse-forming with control signal) and instantaneous contact
H	Additive ON-delay, instantaneous OFF with control signal	Additive ON-delay, instantaneous OFF with control signal and instantaneous contact
I	Additive ON-delay with control signal	Additive ON-delay with control signal and instantaneous contact
J	Flashing, symmetrical, starting with pulse	Flashing, symmetrical, starting with pulse and instantaneous contact
K	Pulse-delayed (fixed pulse (at 1 s) and settable pulse delay)	Pulse-delayed (fixed pulse (at 1 s) and settable pulse delay) and instantaneous contact
L	Pulse-delayed with control signal (fixed pulse (at 1 s) and settable pulse delay)	Pulse-delayed with control signal (fixed pulse (at 1 s) and settable pulse delay) and instantaneous contact
M	Retriggerable interval relay with activated control signal (watchdog)	Retriggerable interval relay with activated control signal and instantaneous contact (watchdog)
--	--	Wye-delta function

With a set of foil labels the timing relay can be legibly marked with the functions which can be selected on the timing relay. This is supplied together with the multifunctional timing relay.

The same potential must be applied to terminals A. and B.

Note:

The activation of loads parallel to the start input is permissible when using AC/DC control voltage.

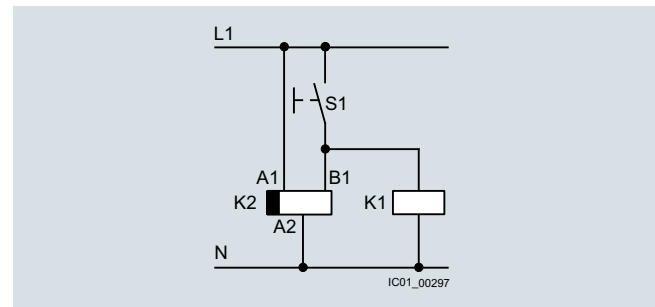

Diagram

Monitoring and control devices

Relays

Timing relays

SIRIUS 3RP25 timing relays, 17.5 mm and 22.5 mm

Simulator

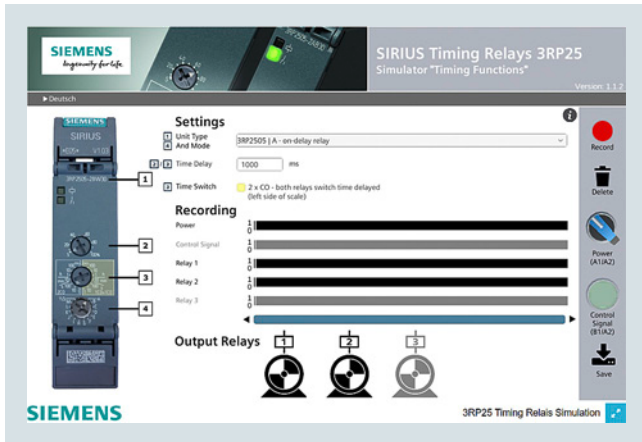

3RP25 simulator

The 3RP25 simulator visualizes different time functions in the 3RP25 timing relay. Any fault scenario can be simulated.

The tool is available free of charge, see <https://support.industry.siemens.com/cs/ww/en/view/103556391>.

Benefits

- Easy stock keeping and logistics thanks to low variance of devices
- Reduced space requirement in the control cabinet thanks to variants in width 17.5 mm and 22 mm
- Consistent for all functions thanks to wide voltage range from 12 to 240 V AC/DC
- Up to 27 functions according to IEC 61812 in the multifunctional timing relay with wide voltage range
- Multifunctional timing relay with semiconductor output for high switching frequencies, bounce-free and wear-free switching

Standards and approvals

- IEC 60721-3-3 "Classification of environmental conditions"
- IEC 61812-1/DIN VDE 0435 Part 2021 "Specified time relays for industrial use"
- IEC 61000-6-2, IEC 61000-6-3 and IEC 61000-6-4 "Electromagnetic compatibility"
- IEC 60947-5-1 "Low-voltage switchgear and controlgear – Electromechanical control circuit devices"

Application

Timing relays are used in control, starting, and protective circuits for all switching operations involving time delays. They guarantee a high level of functionality and a high repeat accuracy of timer settings.

Use in environments exposed to dust, condensation, rapid temperature changes and corrosion is possible thanks to the standard coating of the printed circuit board according to IPC-610. Suitable for applications in rail, agriculture, mining, woodworking, etc.

Enclosure version

All timing relays are suitable for snap-on mounting on TH 35 standard mounting rails according to IEC 60715 or for screw fixing.

Technical specifications

More information

Technical specifications, see
<https://support.industry.siemens.com/cs/ww/en/ps/16354/td>
 Equipment Manual, see
<https://support.industry.siemens.com/cs/ww/en/view/103532830>

Internal circuit diagrams, see [CAx Download Manager](#)
<https://support.industry.siemens.com/my/ww/en/CAxOnline#CAxOnline>
 FAQs, see <https://support.industry.siemens.com/cs/ww/en/ps/16354/faq>

Article number	3RP2505-.A, 3RP2505-.C, 3RP251., 3RP2525-.A, 3RP2527, 3RP253., 3RP255.	3RP2505-.B, 3RP2505-.R, 3RP2525-.B, 3RP254., 3RP256., 3RP257.
Dimensions (W x H x D)	mm 17.5 x 100 x 90	22.5 x 100 x 90

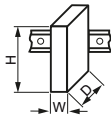

Article number	3RP25...-AB30, 3RP25...-AW30, 3RP25...-AW30-0AX0 3RP25...-BB30, 3RP25...-BW30, 3RP25...-BW30-0AX0 3RP25...-NW30, 3RP25...-SW30	3RP25...-BT20, 3RP25...-NM20	3RP25...-CW30	3RP25...-EW30	3RP25...-RW30 3RP25...-2RW30-0AX0
----------------	---	---	----------------------	----------------------	--

General technical specifications:

Insulation voltage for overvoltage category III acc. to IEC 60664 for pollution degree 3, rated value	V AC	300	500	300	--	300
Ambient temperature						
• During operation	°C	-25 ... +60				
• During storage	°C	-40 ... +85				
Operating range factor of the control supply voltage, rated value						
• At AC						
- At 50 Hz		0.85 ... 1.1	0.85 ... 1.1	0.8 ... 1.1	0.85 ... 1.1	0.7 ... 1.1
- At 60 Hz		0.85 ... 1.1	0.85 ... 1.1	0.8 ... 1.1	0.85 ... 1.1	0.7 ... 1.1
• At DC		0.85 ... 1.1	--	0.8 ... 1.1	0.85 ... 1.1	0.7 ... 1.1
Switching capacity current with inductive load	A	0.01 ... 3	0.01 ... 3	0.01 ... 1	0.01 ... 0.6	0.01 ... 3
Operational current of the auxiliary contacts						
• At AC-15						
- At 24 V	A	3	3	1	--	3
- At 250 V	A	3	3	1	--	3
- At 400 V	A	--	3	--	--	--
• At DC-12						
- At 24 V	A	--	--	1	--	--
- At 125 V	A	--	--	1	--	--
- At 250 V	A	--	--	1	--	--
• At DC-13						
- At 24 V	A	1	1	--	--	1
- At 125 V	A	0.2	0.2	--	--	0.2
- At 250 V	A	0.1	0.1	--	--	0.1
Thermal current	A	5	5	1	0.6	5
Mechanical service life (operating cycles)		10 000 000				
Electrical endurance (operating cycles) for AC-15 at 230 V		100 000		300 000	100 000	

Article number	3RP25...-1...0	3RP25...-2...0
Type of electrical connection for auxiliary and control circuits	Screw terminals	Spring-loaded terminals (push-in)
Design of thread of connection screw	M3	--
Tightening torque	Nm 0.6 ... 0.8	--
Type of connectable conductor cross-sections		
• Solid	1 x (0.5 ... 4 mm ²), 2 x (0.5 ... 2.5 mm ²)	1 x (0.5 ... 4 mm ²)
• Finely stranded with end sleeve	1 x (0.5 ... 4 mm ²), 2 x (0.5 ... 1.5 mm ²)	1 x (0.5 ... 2.5 mm ²)
• For AWG cables		
- Solid	1 x (20 ... 12), 2 x (20 ... 14)	1 x (20 ... 12)
- Stranded	1 x (20 ... 12), 2 x (20 ... 14)	1 x (20 ... 12)

Monitoring and control devices

Relays

Timing relays

SIRIUS 3RP25 timing relays, 17.5 mm and 22.5 mm

3RP25 function diagrams

Multifunction 3RP2505-.A, 1 CO, 13 functions and 3RP2505-.C, 1 NO (semiconductor), 13 functions

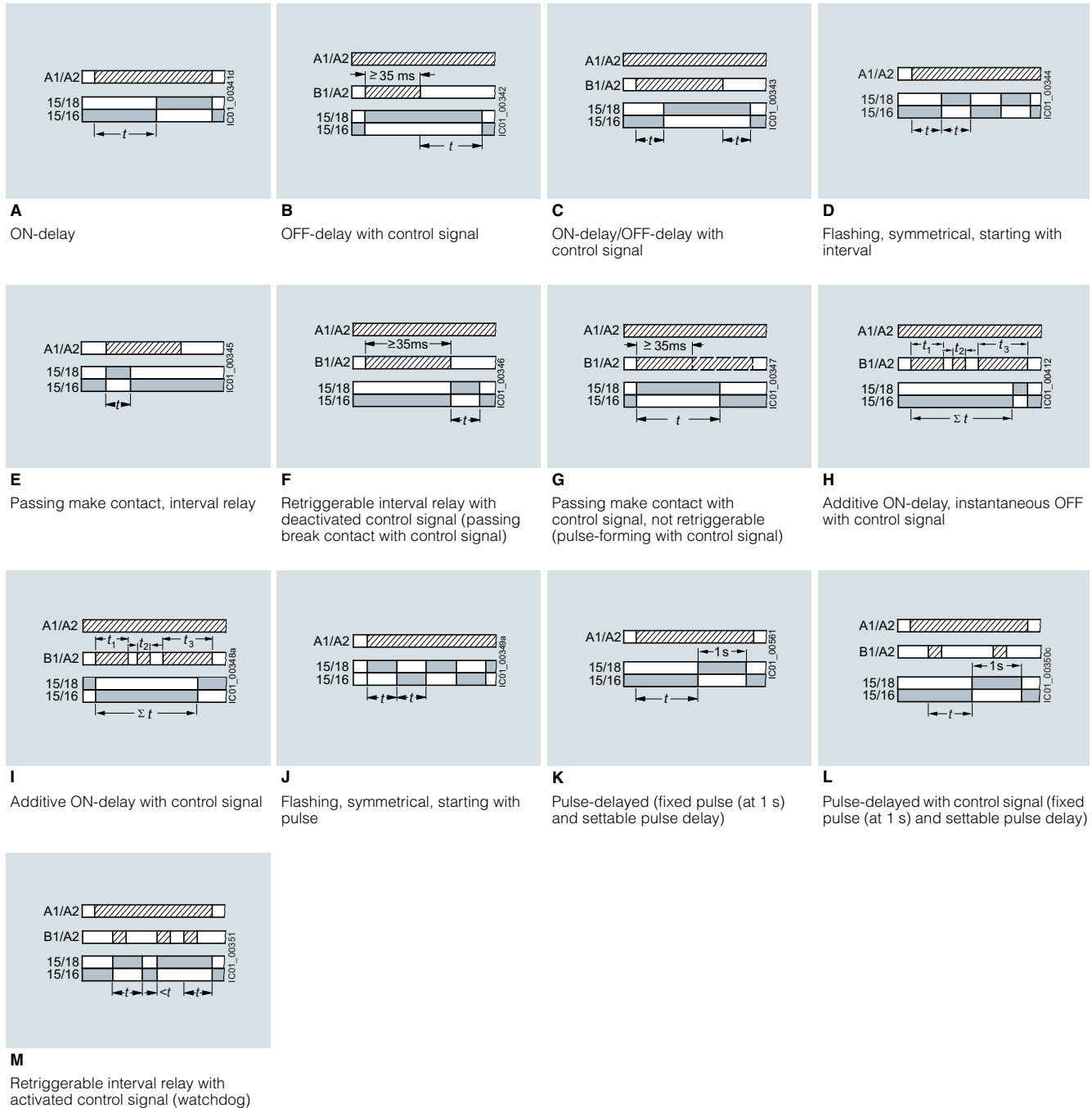

Legend

- A ... M** Identification letters
- Timing relay energized
- Contact closed
- Contact open

SIRIUS 3RP25 timing relays, 17.5 mm and 22.5 mm

Multifunction 3RP2505-.R, 13 functions, 2 CO force-guided and switched in parallel with delay

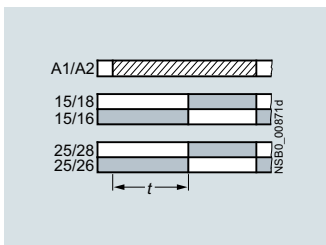

A
ON-delay

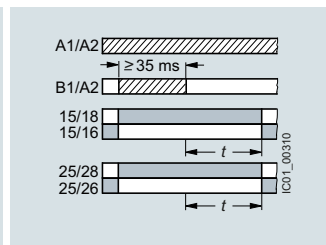

B
OFF-delay with control signal

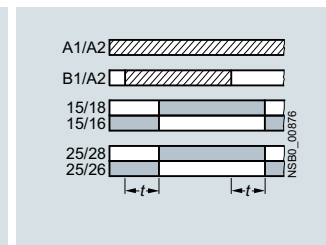

C
ON-delay/OFF-delay with control signal

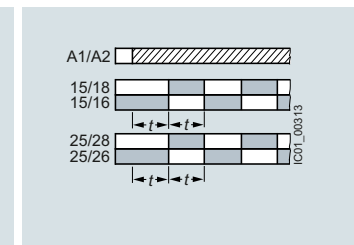

D
Flashing, symmetrical, starting with interval

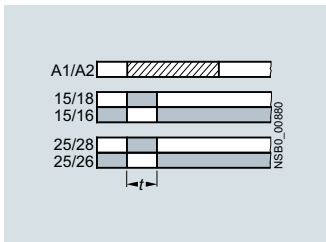

E
Passing make contact, interval relay

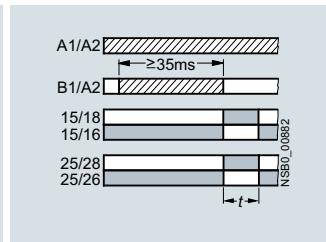

F
Retriggerable interval relay with deactivated control signal (passing break contact with control signal)

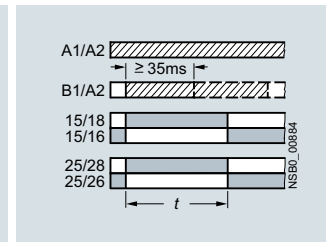

G
Passing make contact with control signal, not retriggerable (pulse-forming with control signal)

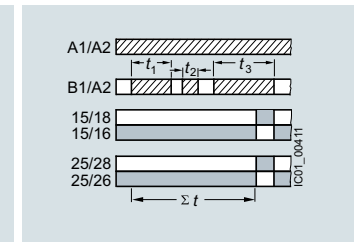

H
Additive ON-delay, instantaneous OFF with control signal

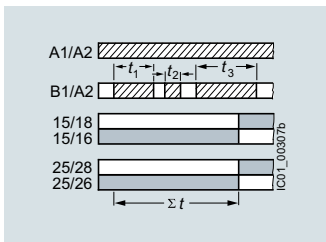

I
Additive ON-delay with control signal

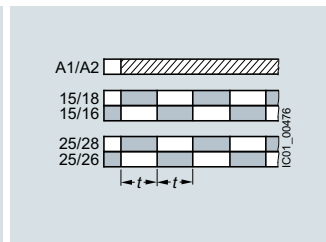

J
Flashing, symmetrical, starting with pulse

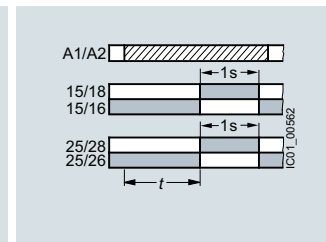

K
Pulse-delayed (fixed pulse at 1 s and settable pulse delay)

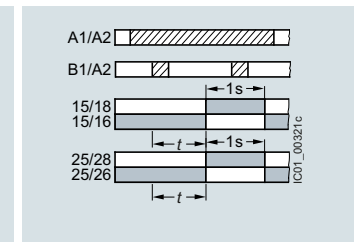

L
Pulse-delayed with control signal (fixed pulse at 1 s and settable pulse delay)

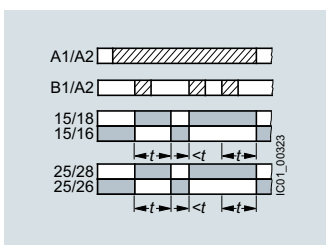

M
Retriggerable interval relay with activated control signal (watchdog)

Legend

- A ... M** Identification letters
- Timing relay energized
- Contact closed
- Contact open

Monitoring and control devices

Relays

Timing relays

SIRIUS 3RP25 timing relays, 17.5 mm and 22.5 mm

Multifunction 3RP2505--B, 27 functions, 2 CO

<p>A</p> <p>2 CO switched in parallel</p> <p>ON-delay</p>	<p>1 delayed CO contact + 1 instantaneous CO contact</p> <p>ON-delay and instantaneous contact</p>	<p>B</p> <p>2 CO switched in parallel</p> <p>OFF-delay with control signal</p>	<p>1 delayed CO contact + 1 instantaneous CO contact</p> <p>OFF-delay with control signal and instantaneous contact</p>
<p>C</p> <p>2 CO switched in parallel</p> <p>ON-delay/OFF-delay with control signal</p>	<p>1 delayed CO contact + 1 instantaneous CO contact</p> <p>ON-delay/OFF-delay with control signal and instantaneous contact</p>	<p>D</p> <p>2 CO switched in parallel</p> <p>Flashing, symmetrical, starting with interval</p>	<p>1 delayed CO contact + 1 instantaneous CO contact</p> <p>Flashing, symmetrical, starting with interval and instantaneous contact</p>
<p>E</p> <p>2 CO switched in parallel</p> <p>Passing make contact, interval relay</p>	<p>1 delayed CO contact + 1 instantaneous CO contact</p> <p>Passing make contact, interval relay and instantaneous contact</p>	<p>F</p> <p>2 CO switched in parallel</p> <p>Retriggerable interval relay with deactivated control signal (passing break contact with control signal)</p>	<p>1 delayed CO contact + 1 instantaneous CO contact</p> <p>Retriggerable interval relay with deactivated control signal (passing break contact with control signal) and instantaneous contact</p>
<p>G</p> <p>2 CO switched in parallel</p> <p>Passing make contact with control signal, not retriggerable (pulse-forming with control signal)</p>	<p>1 delayed CO contact + 1 instantaneous CO contact</p> <p>Passing make contact with control signal, not retriggerable (pulse-forming with control signal) and instantaneous contact</p>	<p>H</p> <p>2 CO switched in parallel</p> <p>Additive ON-delay, instantaneous OFF with control signal</p>	<p>1 delayed CO contact + 1 instantaneous CO contact</p> <p>Additive ON-delay, instantaneous OFF with control signal and instantaneous contact</p>

Legend

- A ... H** Identification letters
- Timing relay energized
- Contact closed
- Contact open

Multifunction 3RP2505-.B, 27 functions, 2 CO (continued)

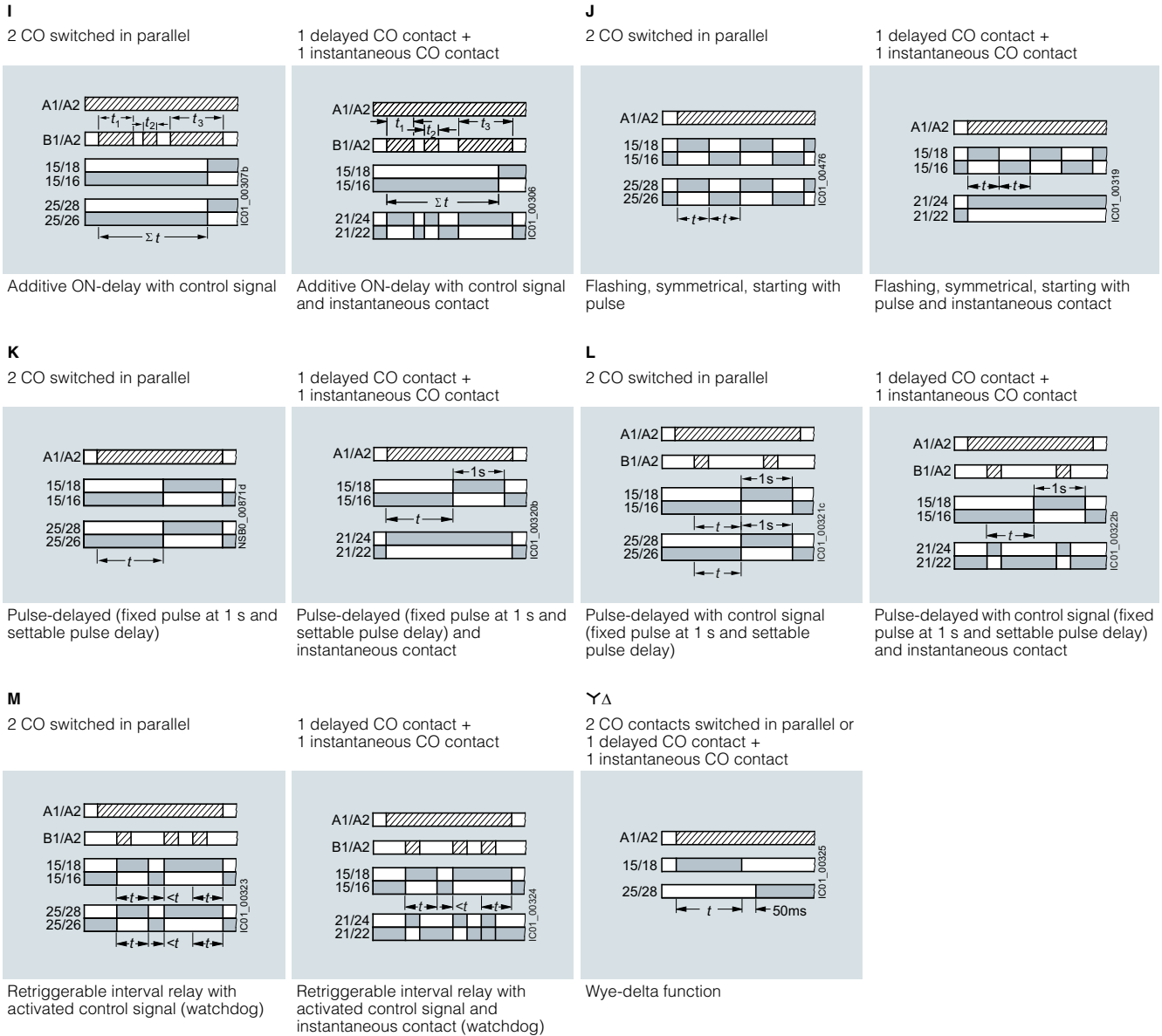

Legend

- I ... M Identification letters
- ▨ Timing relay energized
- Contact closed
- Contact open

Monitoring and control devices

Relays

Timing relays

SIRIUS 3RP25 timing relays, 17.5 mm and 22.5 mm

Monofunctions 3RP251. to 3RP257.¹⁾

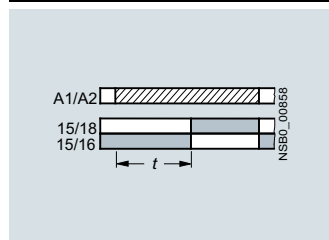

3RP251..AW30, 1 CO, ON-delay

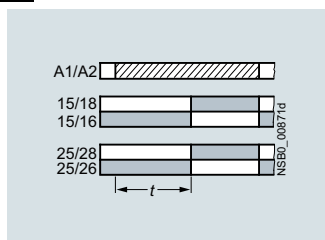

3RP2525..W30, 2 CO, ON-delay

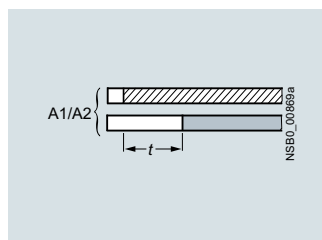

3RP2527..EW30, 1 NO
(semiconductor), ON-delay

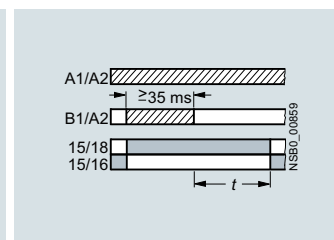

3RP2535..AW30, 1 CO, OFF-delay with
control signal

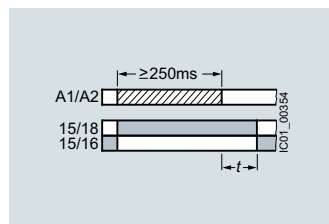

3RP2540..A.30, 1 CO, OFF-delay
(N)¹⁾

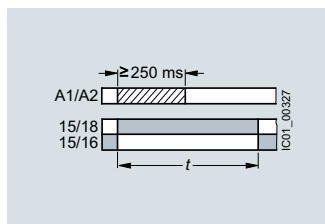

3RP2540..A.30, 1 CO, positive
passing make contact (O)¹⁾

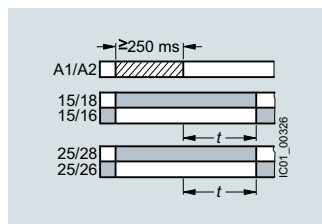

3RP2540..B.30, 2 CO, OFF-delay
(N)¹⁾

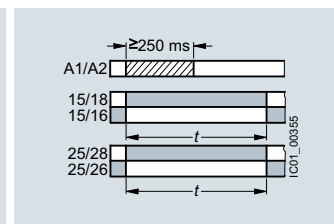

3RP2540..B.30, 2 CO, positive passing
make contact (O)¹⁾

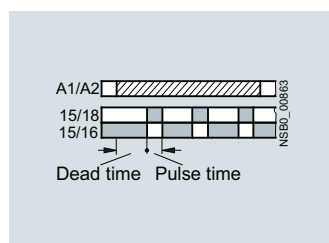

3RP2555..AW30, 1 CO, flashing,
asymmetrical, starting with interval
(clock-pulse relay)

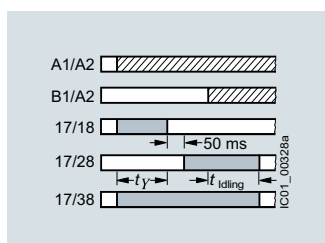

3RP2560..SW30, 3 NO, wye-delta
function with overtravel function
(idling)

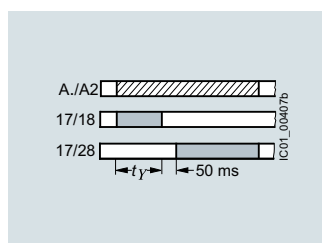

3RP257..NM20, 2 NO, wye-delta
function

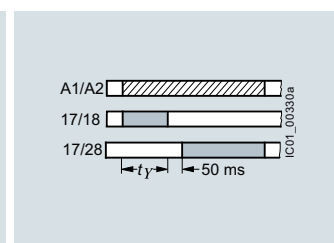

3RP257..NW30, 2 NO, wye-delta
function

Legend

- Timing relay energized
- Contact closed
- Contact open

¹⁾ 3RP2540 has a double function:
Function N = OFF-delay
Function O = Positive passing make contact

Possibilities of operation of the 3RP2560-.SW30 timing relay

Operation 1: Start contact B./A2 is open when control supply voltage A./A2 is applied

The control supply voltage is applied to A./A2 and there is no control signal on B./A2. This starts the $\Upsilon\Delta$ timing. The idling time (coasting time) is started by applying a control signal to B./A2. When the set time t_{idling} (30 to 600 s) has elapsed, the output relays (17/38 and 17/28) are reset. If the control signal on B./A2 is switched off (minimum OFF period 270 ms), a new timing is started.

Note:

Observe response time (dead time) of 400 ms on energizing control supply voltage until contacts 17/18 and 17/38 close.

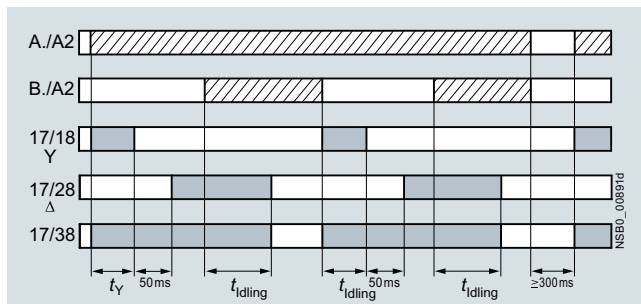

Operation 1

Operation 2: Start contact B./A2 is closed when control supply voltage A./A2 is applied

If the control signal B./A2 is already present when the control supply voltage A./A2 is applied, **no** timing is started. The timing is only started when the control signal B./A2 is switched off.

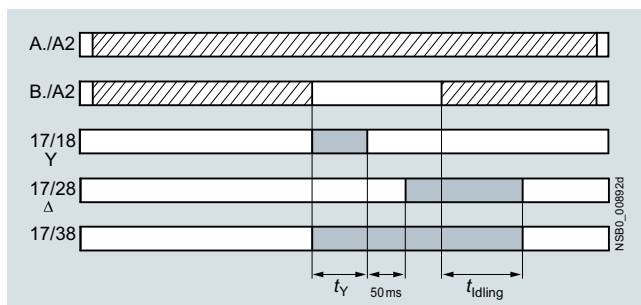

Operation 2

Operation 3: Start contact B./A2 closes while star time is running

If the control signal B./A2 is applied again during the star time, the idling time starts and the timing is terminated normally.

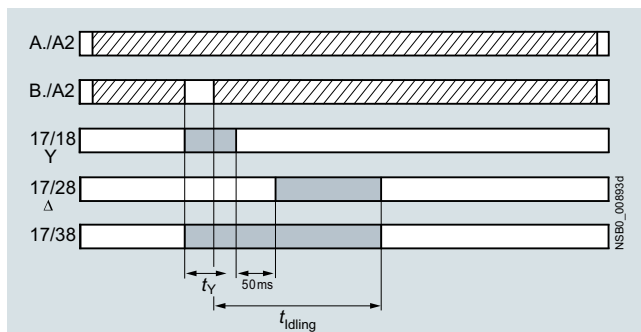

Operation 3

Operation 4: Start contact B./A2 opens while delta time is running and is applied again

If the control signal on B./A2 is applied and switched off again during the delta time, although the idling time has not yet elapsed, the idling time (coasting time) is reset to zero. If the control signal is re-applied to B./A2, the idling time is restarted.

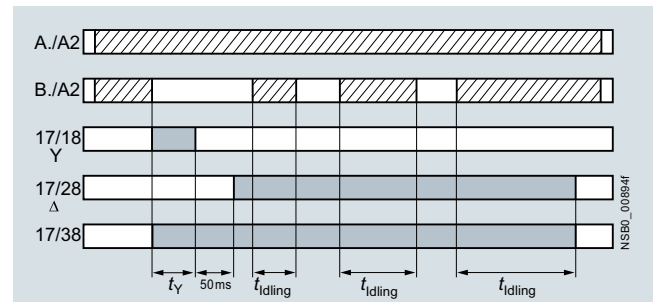

Operation 4

Legend

- Timing relay energized
- Contact closed
- Contact open

t_Y = Star time 1 to 20 s

t_{idling} = Idling time (coasting time) 30 to 600 s

Note:

The following applies to all operations: The pressure switch controls the timing via B./A2.

Application example based on standard operation (operation 1):
For example, use of 3RP2560 for compressor control

Frequent starting of compressors strains the network, the machine, and the increased costs for the operator. The new timing relay prevents frequent starting at times when there is high demand for compressed air. A special control circuit prevents the compressor from being switched off immediately when the required air pressure in the tank has been reached. Instead, the valve in the intake tube is closed and the compressor runs in "Idling" mode, i.e. in no-load operation for a specific time which can be set from 30 to 600 s.

If the pressure falls within this time, the motor does not have to be restarted again, but can return to nominal load operation from no-load operation.

If the pressure does not fall within this idling time, the motor is switched off.

The pressure switch controls the timing via B./A2.

The control supply voltage is applied to A./A2 and the start contact B./A2 is open, i.e. there is no control signal on B./A2 when the control supply voltage is applied. The pressure switch signals "too little pressure in system" and starts the timing by way of terminal B./A2. The compressor is started, enters $\Upsilon\Delta$ operation, and fills the pressure tank.

When the pressure switch signals "sufficient pressure", the control signal B./A2 is applied, the idling time (coasting time) is started, and the compressor enters no-load operation for the set period of time from 30 to 600 s. The compressor is then switched off. The compressor is only restarted if the pressure switch responds again (low pressure).

Monitoring and control devices

Relays

Timing relays

SIRIUS 3RP25 timing relays, 17.5 mm and 22.5 mm

Selection and ordering data



3RP2505-2AB30



3RP2505-2BB30



3RP2525-2AW30



3RP2540-2AW30



3RP2555-2AW30



3RP2576-2NW30

Number of NO contacts		Number of CO contacts		Semi-conductor output	Adjustable time	Control supply voltage		Standard coating IPC-610	SD	Article No.	Price per PU	PU (UNIT, SET, M)	PS*	PG
Instantaneous switching	Delayed switching	Instantaneous switching	Delayed switching			At 50/60 Hz AC	At DC							
13 functions														
0	0	0	1	No	0.05 s ... 100 h	24	24	No	▶	3RP2505-□AB30		1	1 unit	41H
						12 ... 240	12 ... 240	No	▶	3RP2505-□AW30		1	1 unit	41H
								NEW	X	3RP2505-2AW30-0AX0		1	1 unit	41H
0	1	0	0	Yes	0.05 s ... 100 h	12 ... 240	12 ... 240	No	2	3RP2505-□CW30		1	1 unit	41H
13 functions, suitable for railway applications														
0	0	0	2 ¹⁾	No	0.05 s ... 100 h	24 ... 240	24 ... 240	No	▶	3RP2505-□RW30		1	1 unit	41H
								NEW	X	3RP2505-2RW30-0AX0		1	1 unit	41H
27 functions														
0	0	0	2 ²⁾	No	0.05 s ... 100 h	24	24	No	▶	3RP2505-□BB30		1	1 unit	41H
						400 ... 440	--	No	▶	3RP2505-□BT20		1	1 unit	41H
						12 ... 240	12 ... 240	No	▶	3RP2505-□BW30		1	1 unit	41H
								NEW	X	3RP2505-2BW30-0AX0		1	1 unit	41H
ON-delay														
0	0	0	1	No	0.5 ... 10 s	12 ... 240	12 ... 240	No	▶	3RP2511-□AW30		1	1 unit	41H
					1 ... 30 s	12 ... 240	12 ... 240	No	▶	3RP2512-□AW30		1	1 unit	41H
					5 ... 100 s	12 ... 240	12 ... 240	No	▶	3RP2513-□AW30		1	1 unit	41H
					0.05 s ... 100 h	12 ... 240	12 ... 240	No	▶	3RP2525-□AW30		1	1 unit	41H
0	0	0	2	No	0.05 s ... 100 h	24	24	No	▶	3RP2525-□BB30		1	1 unit	41H
						12 ... 240	12 ... 240	No	▶	3RP2525-□BW30		1	1 unit	41H
0	1	0	0	Yes	0.05 s ... 240 s	12 ... 240	12 ... 240	No	2	3RP2527-□EW30		1	1 unit	41H
OFF-delay with control signal														
0	0	0	1	No	0.05 s ... 100 h	12 ... 240	12 ... 240	No	▶	3RP2535-□AW30		1	1 unit	41H
OFF-delay without control signal, non-volatile, passing make contact														
0	0	0	1 ⁴⁾	No	0.05 s ... 600 s	24	24	No	2	3RP2540-□AB30		1	1 unit	41H
						12 ... 240	12 ... 240	No	▶	3RP2540-□AW30		1	1 unit	41H
0	0	0	2 ⁴⁾	No	0.05 s ... 600 s	24	24	No	2	3RP2540-□BB30		1	1 unit	41H
						12 ... 240	12 ... 240	No	▶	3RP2540-□BW30		1	1 unit	41H
Clock-pulse relay, flashing, asymmetrical														
0	0	0	1	No	0.05 s ... 100 h	12 ... 240	12 ... 240	No	▶	3RP2555-□AW30		1	1 unit	41H
Wye-delta function with coasting function (idling)														
1	2	0	0	No	1 ... 20 s	12 ... 240	12 ... 240	No	▶	3RP2560-□SW30		1	1 unit	41H
Wye-delta function														
1	1	0	0	No	1 ... 20 s	380 ... 440 ³⁾	--	No	2	3RP2574-□NM20		1	1 unit	41H
						12 ... 240	12 ... 240	No	▶	3RP2574-□NW30		1	1 unit	41H
1	1	0	0	No	3 ... 60 s	380 ... 440 ³⁾	--	No	2	3RP2576-□NM20		1	1 unit	41H
						12 ... 240	12 ... 240	No	▶	3RP2576-□NW30		1	1 unit	41H

Type of electrical connection

- Screw terminals
- Spring-loaded terminals (push-in)

1) Force-guided contacts.

2) Optionally 1 CO delayed + 1 CO instantaneous.

3) With 3RP2574-.NM20 and 3RP2576-.NM20, connection of 200 to 240 V AC, 50/60 Hz control voltage is also possible.

4) Setting of output contacts in as-supplied state not defined (bistable relay). Application of the control supply voltage once results in contact changeover to the correct setting.

Notes:

For accessories, see page 10/39.

In the case of 3RP2505, the functions can be adjusted by means of function selector switches on the device. With a set of foil labels the timing relay can be legibly marked with the functions which can be selected on the timing relay. This is included in the scope of supply. The same potential must be applied to terminals A. and B.











For functions, see the overview of functions on page 10/29.

1
2

Accessories

More information

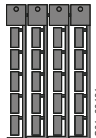
You can find information on configuring and dimensioning the accessories in the Equipment Manual, see <https://support.industry.siemens.com/cs/ww/en/view/103532830>

Version	SD	Article No.	Price per PU	PU (UNIT, SET, M)	PS*	PG	
Terminals for SIRIUS devices in the industrial standard mounting rail enclosure							
 3ZY1122-1BA00	Removable terminals • 2-pole, up to 1 x 4 mm ² or 2 x 2.5 mm ²		2	Screw terminals  3ZY1122-1BA00	1	6 units	41L
	 3ZY1122-2BA00	Removable terminals • 2-pole, up to 1 x 4 mm ² or 2 x 1.5 mm ² (in shared end sleeve)		2	Spring-loaded terminals (push-in)  3ZY1122-2BA00	1	6 units
Accessories for enclosures							
 3ZY1321-2AA00	Sealing covers • 17.5 mm • 22.5 mm		2	3ZY1321-1AA00 3ZY1321-2AA00	1	5 units	41L
			2		1	5 units	41L
 3ZY1311-0AA00	Push-in lugs For wall mounting		2	3ZY1311-0AA00	1	10 units	41L
 3ZY1440-1AA00	Coding pins For removable terminals of SIRIUS devices in the industrial standard mounting rail enclosure; enable the mechanical coding of terminals		2	3ZY1440-1AA00	1	12 units	41L
 3ZY1450-1AB00	Hinged cover Replacement cover, without terminal labeling, titanium gray • 17.5 mm wide • 22.5 mm wide		2	3ZY1450-1AA00 3ZY1450-1AB00	1	5 units	41L
			2		1	5 units	41L
Blank labels							
 3RT2900-1SB20	Unit labeling plates¹⁾ For SIRIUS devices • 10 mm x 7 mm, titanium gray • 20 mm x 7 mm, titanium gray		20	3RT2900-1SB10 3RT2900-1SB20	100	816 units	41B
			20		100	340 units	41B
Tools for opening spring-loaded terminals							
 3RA2908-1A	Screwdrivers For all SIRIUS devices with spring-loaded terminals Length approx. 200 mm, 3.0 mm x 0.5 mm, titanium gray/black, partially insulated		2	Spring-loaded terminals (push-in)  3RA2908-1A	1	1 unit	41B

¹⁾ PC labeling system for individual inscription of unit labeling plates available from: murrplastik Systemtechnik GmbH, see page 16/16.

Monitoring and control devices

Relays

Timing relays

SIRIUS 3RP20 timing relays, 45 mm

Overview

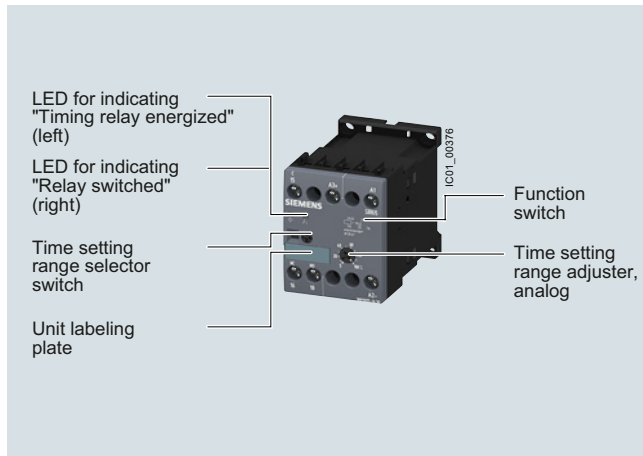

SIRIUS 3RP20 timing relay

SIRIUS 3RP20 electronic timing relays for use in control systems and mechanical engineering with:

- 1 or 2 CO contacts
- Multifunction or monofunction
- Wide voltage range or combination voltage
- Single or selectable time setting ranges
- Switch position indication and voltage indication by LED

Standards

The timing relays comply with:

- IEC 60721-3-3 "Classification of environmental conditions"
- IEC 61812-1 "Specified time relays for industrial use"
- IEC 61000-6-2 and IEC 61000-6-4 "Electromagnetic compatibility"
- IEC 60947-5-1 "Low-voltage switchgear and controlgear – Electromechanical control circuit devices"
- IEC 60947-1, Annex N "Protective separation"

Multifunction

The functions of the 3RP2005 multifunctional timing relays can be set by means of the function selector switch. Insert labels can be used to adjust different functions of the timing relay clearly and unmistakably. The corresponding labels can be ordered as an accessory. The same potential must be applied to terminals A. and B.

For functions, see 3RP2901 label set, page 10/45.

Note:

The activation of loads parallel to the start input is not permissible when using AC control voltage.

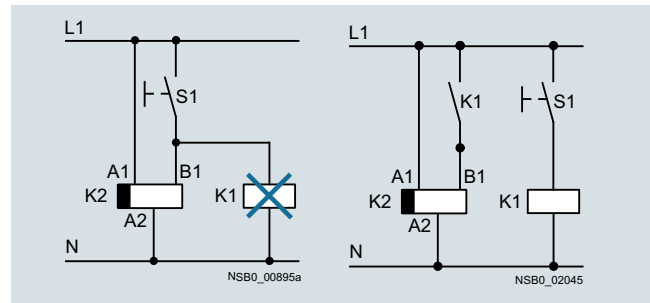

Diagrams

Accessories

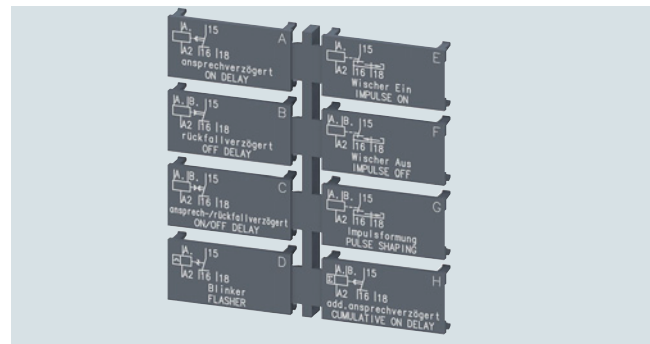

Label set for marking the multifunctional relay

Article No. scheme

Product versions		Article number			
SIRIUS timing relays, 45 mm enclosure		3RP20	<input type="checkbox"/>	<input type="checkbox"/>	3 0
Product function/ time setting ranges	Multifunction	0 5			15 time ranges 0.05 s... 100 h
	ON-delay	2 5			15 time ranges 0.05 s... 100 h
Connection type	Screw terminals			1	
	Spring-loaded terminals			2	
Contacts	1 CO				A
	2 CO				B
Control supply voltage	24 V AC/DC/100 ... 127 V AC				Q Combination voltage
	24 V AC/DC/200 ... 240 V AC				P Combination voltage
	24 ... 240 V AC/DC				W Wide voltage range
Example		3RP20	0 5	- 1 A P 3 0	

Note:

The Article No. scheme shows an overview of product versions for better understanding of the logic behind the article numbers.

For your orders, please use the article numbers quoted in the selection and ordering data.



Benefits

- Suitable for 3RT miniature contactors
- Uniform design
- Ideal for small distance between standard mounting rails and/or for low mounting depth, e.g. in control boxes
- Labels are used on the multifunctional timing relay to document the function that has been set

Application

Timing relays are used in control, starting, and protective circuits for all switching operations involving time delays. They guarantee a high level of functionality and a high repeat accuracy of timer settings.

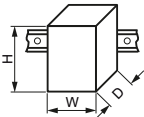
Technical specifications

More information	
Technical specifications, see https://support.industry.siemens.com/cs/ww/en/ps/16356/td Operating Instructions, see https://support.industry.siemens.com/cs/ww/en/view/11647144	Internal circuit diagrams, see CAx Download Manager https://support.industry.siemens.com/my/ww/en/CAxOnline#CAxOnline FAQs, see https://support.industry.siemens.com/cs/ww/en/ps/16356/faq
Type	3RP2005, 3RP2025
Dimensions (W x H x D)	mm 45 x 57 x 73
	
Rated insulation voltage Pollution degree 3 Overvoltage category III	V AC 300
Permissible ambient temperature • During operation • During storage	°C -25 ... +60 °C -40 ... +85
Operating range of excitation¹⁾	0.85 ... 1.1 x U _N at AC; 0.8 ... 1.25 x U _N at DC; 0.95 ... 1.05 times the rated frequency
Mechanical service life	Operating cycles 10 x 10 ⁶
Electrical endurance at I_e	Operating cycles 1 x 10 ⁵
Connection type	 Screw terminals
• Terminal screw • Solid • Finely stranded with end sleeve • Stranded • AWG cables • Tightening torque	mm ² M3 (for standard screwdriver, size 2 and Pozidriv 2) mm ² 2 x (0.5 ... 1.5) ²⁾ , 2 x (0.75 ... 2.5) ²⁾ mm ² 2 x (0.5 ... 1.5) ²⁾ , 2 x (0.75 ... 2.5) ²⁾ AWG 2 x (0.5 ... 1.5) ²⁾ , 2 x (0.75 ... 2.5) ²⁾ AWG 2 x (18 ... 14) Nm 0.8 ... 1.2
Connection type	 Spring-loaded terminals
• Solid • Finely stranded with end sleeve • Finely stranded without end sleeve • AWG cables, solid or stranded • Max. external diameter of the conductor insulation	mm ² 2 x (0.25 ... 2.5) mm ² 2 x (0.25 ... 1.5) mm ² 2 x (0.25 ... 2.5) AWG 2 x (24 ... 14) mm 3.6

¹⁾ If nothing else is stated.

²⁾ If two different conductor cross-sections are connected to one clamping point, both cross-sections must lie in one of the ranges specified.

Monitoring and control devices

Relays

Timing relays

SIRIUS 3RP20 timing relays, 45 mm

3RP20 function diagrams and 3RP2901 label set

1 CO contact

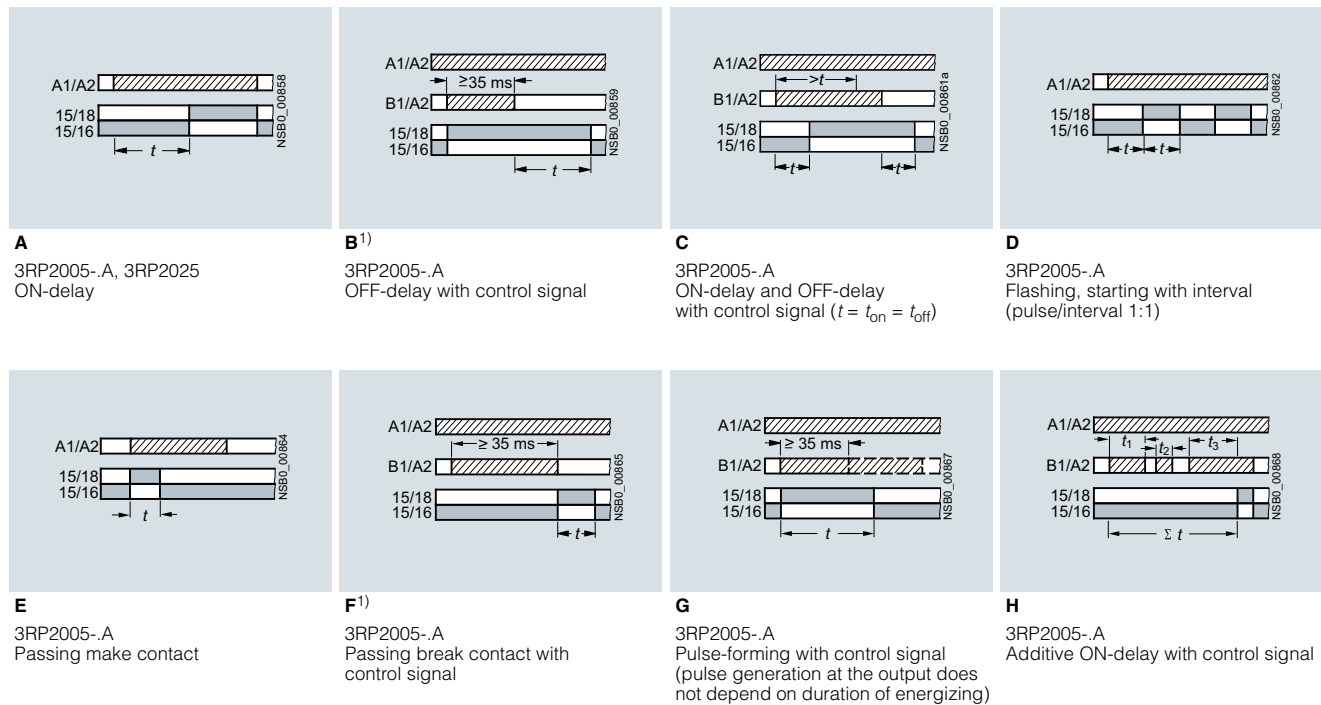

Legend

A ... H Identification letters for 3RP2005

▨ Timing relay energized

■ Contact closed

□ Contact open

¹⁾ A new control signal at terminal B, after the operating time has started, resets the operating time to zero (retriggerable).

2 CO contacts

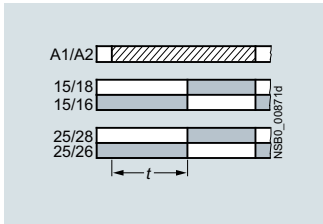

A
3RP2005-B
ON-delay

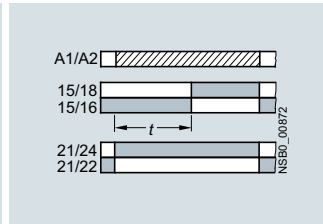

A•
3RP2005-B
ON-delay and instantaneous contact

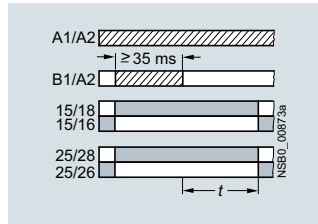

B¹)
3RP2005-B
OFF-delay with control signal

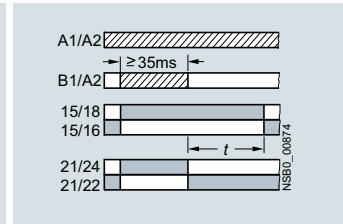

B•¹)
3RP2005-B
OFF-delay with control signal
and instantaneous contact

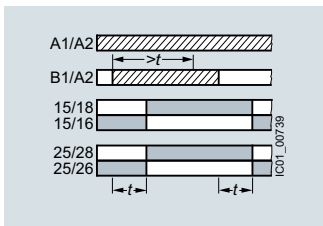

C
3RP2005-B
ON-delay and OFF-delay
with control signal ($t = t_{on} = t_{off}$)

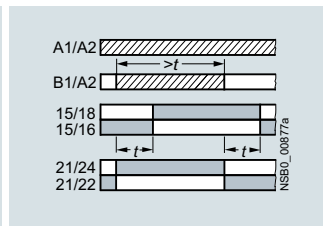

C•
3RP2005-B
ON-delay and OFF-delay
with control signal and instantaneous
contact ($t = t_{on} = t_{off}$)

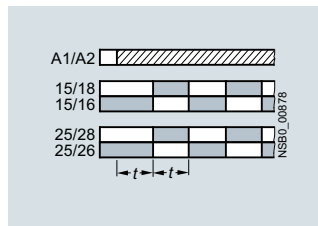

D
3RP2005-B
Flashing, starting with interval
(pulse/interval 1:1)

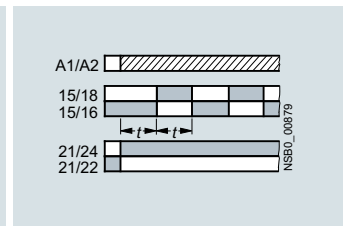

D•
3RP2005-B
Flashing, starting with interval
(pulse/interval 1:1) and instantaneous
contact

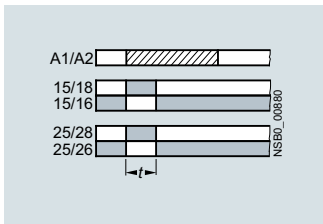

E
3RP2005-B
Passing make contact

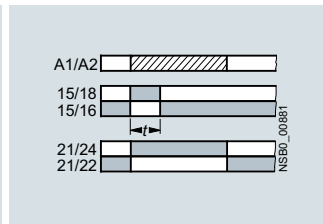

E•
3RP2005-B
Passing make contact and
instantaneous contact

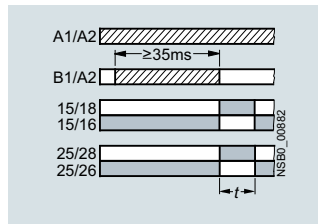

F¹)
3RP2005-B
Passing break contact with
control signal

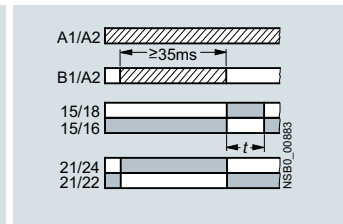

F•¹)
3RP2005-B
Passing break contact with
control signal and instantaneous
contact

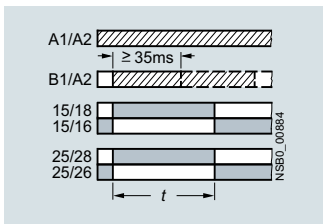

G
3RP2005-B
Pulse-forming with control signal
(pulse generation at the output does
not depend on duration of energizing)

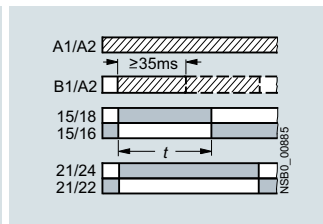

G•
3RP2005-B
Pulse-forming with control signal
and instantaneous contact (pulse
generation at the output does not
depend on duration of energizing)

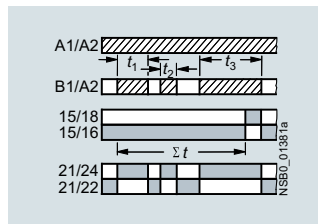

H•
3RP2005-B
Additive ON-delay with control signal
and instantaneous contact

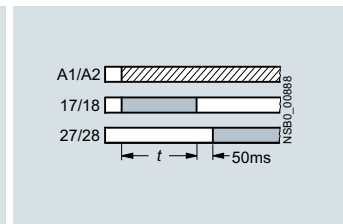

YΔ
3RP2005-B
Wye-delta function

Legend

A ... H Identification letters for 3RP2005

▨ Timing relay energized

■ Contact closed

□ Contact open

¹) A new control signal at terminal B, after the operating time has started, resets the operating time to zero (retriggerable).

Monitoring and control devices

Relays

Timing relays

SIRIUS 3RP20 timing relays, 45 mm

Selection and ordering data

PU (UNIT, SET, M) = 1
 PS* = 1 unit
 PG = 41H



3RP2005-1AP30



3RP2005-1BW30



3RP2005-2AP30



3RP2005-2BW30

Version	Time setting range t	Rated control supply voltage U_s	SD	Screw terminals	SD	Spring-loaded terminals	
		50/60 Hz AC					
		DC					
		V	V	Article No.	Price per PU	Article No.	Price per PU

3RP2005 timing relays, multifunction, 15 time setting ranges

The functions can be adjusted by means of rotary switches. Insert labels can be used to adjust different functions of the 3RP2005 timing relay clearly and unmistakably. The corresponding labels can be ordered as an accessory. The same potential must be applied to terminals A. and B.
 For functions, see 3RP2901 label set, page 10/45.

With LED and 1 CO contact ¹⁾ , 8 functions	0.05 ... 1 s 0.15 ... 3 s 0.5 ... 10 s	24/100 ... 127 24/200 ... 240	24 24	▶	3RP2005-1AQ30 3RP2005-1AP30	2	3RP2005-2AQ30 3RP2005-2AP30
With LED and 2 CO contacts, 16 functions	1.5 ... 30 s 0.05 ... 1 min 5 ... 100 s 0.15 ... 3 min 0.5 ... 10 min 1.5 ... 30 min 0.05 ... 1 h 5 ... 100 min 0.15 ... 3 h 0.5 ... 10 h 1.5 ... 30 h 5 ... 100 h ∞ ²⁾	24 ... 240 ³⁾	24 ... 240 ⁴⁾	▶	3RP2005-1BW30	2	3RP2005-2BW30



3RP2025 timing relays, ON-delay, 15 time setting ranges

With LED and 1 CO contact ¹⁾	0.05 ... 1 s 0.15 ... 3 s 0.5 ... 10 s 1.5 ... 30 s 0.05 ... 1 min 5 ... 100 s 0.15 ... 3 min 0.5 ... 10 min 1.5 ... 30 min 0.05 ... 1 h 5 ... 100 min 0.15 ... 3 h 0.5 ... 10 h 1.5 ... 30 h 5 ... 100 h ∞ ²⁾	24/100 ... 127 24/200 ... 240	24 24	▶	3RP2025-1AQ30 3RP2025-1AP30	5	3RP2025-2AQ30 3RP2025-2AP30
---	---	----------------------------------	----------	---	--	---	--

For accessories, see page 10/45.

- 1) Units with protective separation.
- 2) With ∞ switch position no timing. For test purposes (ON/OFF function) on site. Relay is constantly on when activated, or relay remains constantly off when activated. Depending on which function is set.
- 3) Operating range 0.8 to 1.1 $\times U_s$.
- 4) Operating range 0.7 to 1.1 $\times U_s$.

Accessories

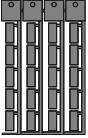
Version	Function	Identifi- cation letter	Use	SD	Article No.	Price per PU	PU (UNIT, SET, M)	PS*	PG
Label sets for 3RP20									
Accessories for 3RP20 (not included in the scope of supply). The label set can be used to label timing relays with the set function in English and German.									
	1 label set (1 unit) with 8 functions	<ul style="list-style-type: none"> • ON-delay • OFF-delay with control signal • ON-delay and OFF-delay with control signal • Flashing, starting with interval • Passing make contact • Passing break contact with control signal • Pulse-forming with control signal • Additive ON-delay with control signal 	A B C D E F G H	For devices with 1 CO	10	3RP2901-0A	1	5 units	41H
	1 label set (1 unit) with 16 functions	<ul style="list-style-type: none"> • ON-delay • OFF-delay with control signal • ON-delay and OFF-delay with control signal • Flashing, starting with interval • Passing make contact • Passing break contact with control signal • Pulse-forming with control signal • ON-delay and instantaneous contact • OFF-delay with control signal and instantaneous contact • ON-delay and OFF-delay with control signal and instantaneous contact • Flashing, starting with interval, and instantaneous contact • Passing make contact and instantaneous contact • Passing break contact with control signal and instantaneous contact • Pulse-forming with control signal and instantaneous contact • Additive ON-delay with control signal and instantaneous contact • Wye-delta function 	A B C D E F G A• B• C• D• E• F• G• H• YΔ	For devices with 2 CO	10	3RP2901-0B	1	5 units	41H
Blank labels									
	Unit labeling plates¹⁾ For SIRIUS devices			For 3RP20					
	• 20 mm x 7 mm, titanium gray				20	3RT2900-1SB20	100	340 units	41B

¹⁾ PC labeling system for individual inscription
of unit labeling plates available from:
murrplastik Systemtechnik GmbH,
[see page 16/16](#).

Monitoring and control devices

Relays

Timing relays

7PV15 timing relays, 17.5 mm

Overview



7PV15 timing relay

Electronic timing relays for general use in control systems, mechanical engineering and infrastructure with:

- 1 or 2 CO contacts
- Multifunction or monofunction
- Wide voltage range or combination voltage
- Single or selectable time setting ranges
- Switch position indication and voltage indication by LED

Standards

The timing relays comply with:

- IEC 60721-3-3 "Classification of environmental conditions"
- IEC 61812-1 "Specified time relays for industrial use"
- IEC 61000-6-2 and IEC 61000-6-4 "Electromagnetic compatibility"
- IEC 60947-5-1 "Low-voltage switchgear and controlgear – Electromechanical control circuit devices"
- DIN 43880 "Built-in equipment for electrical installations; overall dimensions and related mounting dimensions"

Multifunction

The functions of the 7PV1508-1A multifunctional timing relay can be set by means of rotary switches. The identification letters A to G are printed on the front alongside the rotary selector switch of the unit. The related function can be found in the form of a bar graph on the side of the device.

Enclosure version

All timing relays are suitable for snap-on mounting on TH 35 standard mounting rails according to IEC 60715. The enclosure complies with DIN 43880, 1 MW.

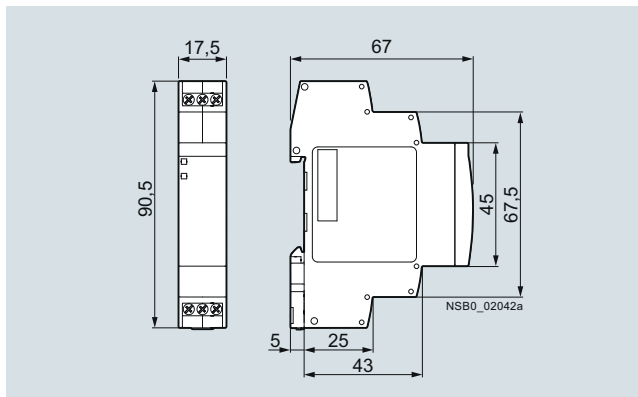

Dimensions

Note:

The activation of loads parallel to the start input is not permissible when using AC control voltage.

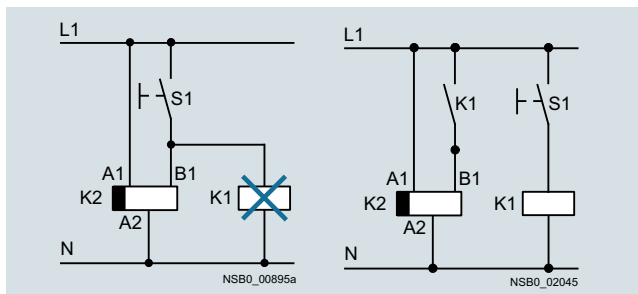

Diagrams

Article No. scheme

Product versions		Article number	
Timing relays in industrial enclosure, 17.5 mm		7PV15	<input type="checkbox"/> <input type="checkbox"/> - 1 <input type="checkbox"/> <input type="checkbox"/> 3 0
Product function/ time setting ranges	Multifunction ON-delay	0 8	7 time ranges 0.05 s ... 100 h
		1 1	1 time range 0.05 ... 1 s
		1 2	1 time range 0.5 ... 10 s
		1 3	1 time range 5 ... 100 s
		1 8	7 time ranges 0.05 s ... 100 h
	OFF-delay with control signal	3 8	7 time ranges 0.05 s ... 100 h
	OFF-delay without control signal	4 0	7 time ranges 0.05 s ... 100 s
	Clock-pulse relay	5 8	7 time ranges 0.05 s ... 100 h
	Wye-delta function	7 8	7 time ranges 0.05 s ... 100 h
Contacts	e.g. A = 1 CO		<input type="checkbox"/>
Control supply voltage	e.g. W = 12 ... 240 V AC/DC		<input type="checkbox"/> Combination voltage
Example		7PV15 0 8 - 1 A W 3 0	

Note:

The Article No. scheme shows an overview of product versions for better understanding of the logic behind the article numbers.

For your orders, please use the article numbers quoted in the selection and ordering data.

Benefits

- Wide voltage range 12 to 240 V AC/DC
- High switching capacity, e.g. AC-15 at 230 V, 3 A
- Combination voltage, e.g. 24 V AC/DC and 200 to 240 V AC
- Changes to the time setting range during operation
- Changes to the function in the de-energized state
- High level of functionality and a high repeat accuracy of timer settings
- Integrated surge suppressor
- Function charts printed on the side of the device for reliable device adjustment

Application

Timing relays are used in control, starting and protective circuits for all switching operations involving time delays, e.g. in functional buildings, airports, building industry, etc.

Technical specifications

More information	
Technical specifications, see https://support.industry.siemens.com/cs/ww/en/ps/16358/td	Operating Instructions and internal circuit diagrams, see https://support.industry.siemens.com/cs/ww/en/view/35210295
Type	7PV15
Rated insulation voltage	V AC 300
Pollution degree 2, overvoltage category III	
Permissible ambient temperature	
• During operation	°C -25 ... +55
• During storage	°C -40 ... +70
Operating range of excitation¹⁾	0.85 ... 1.1 x U _s
Rated operational current I_e	
• AC-15 at 24 ... 240 V, 50 Hz	A 3
• DC-13 at	
- 24 V	A 1
- 125 V	A 0.2
Uninterrupted thermal current I_{th}	A 5
Mechanical service life	Operating cycles 1 x 10 ⁷
Electrical endurance at I_e	Operating cycles 1 x 10 ⁵
Connection type	 Screw terminals
• Terminal screw	M3 (for standard screwdriver, size 2 and Pozidriv 2)
• Solid	1 x (0.2 ... 2.5)
• Finely stranded with end sleeve	1 x (0.25 ... 1.5)
• Finely stranded without end sleeve	1 x (0.2 ... 1.5)
• AWG cables, solid or stranded	1 x (24 ... 14)
• Tightening torque	0.4 ... 0.5 Nm

¹⁾ If nothing else is stated.

Monitoring and control devices

Relays

Timing relays

7PV15 timing relays, 17.5 mm

7PV15 function diagrams

1 CO contact

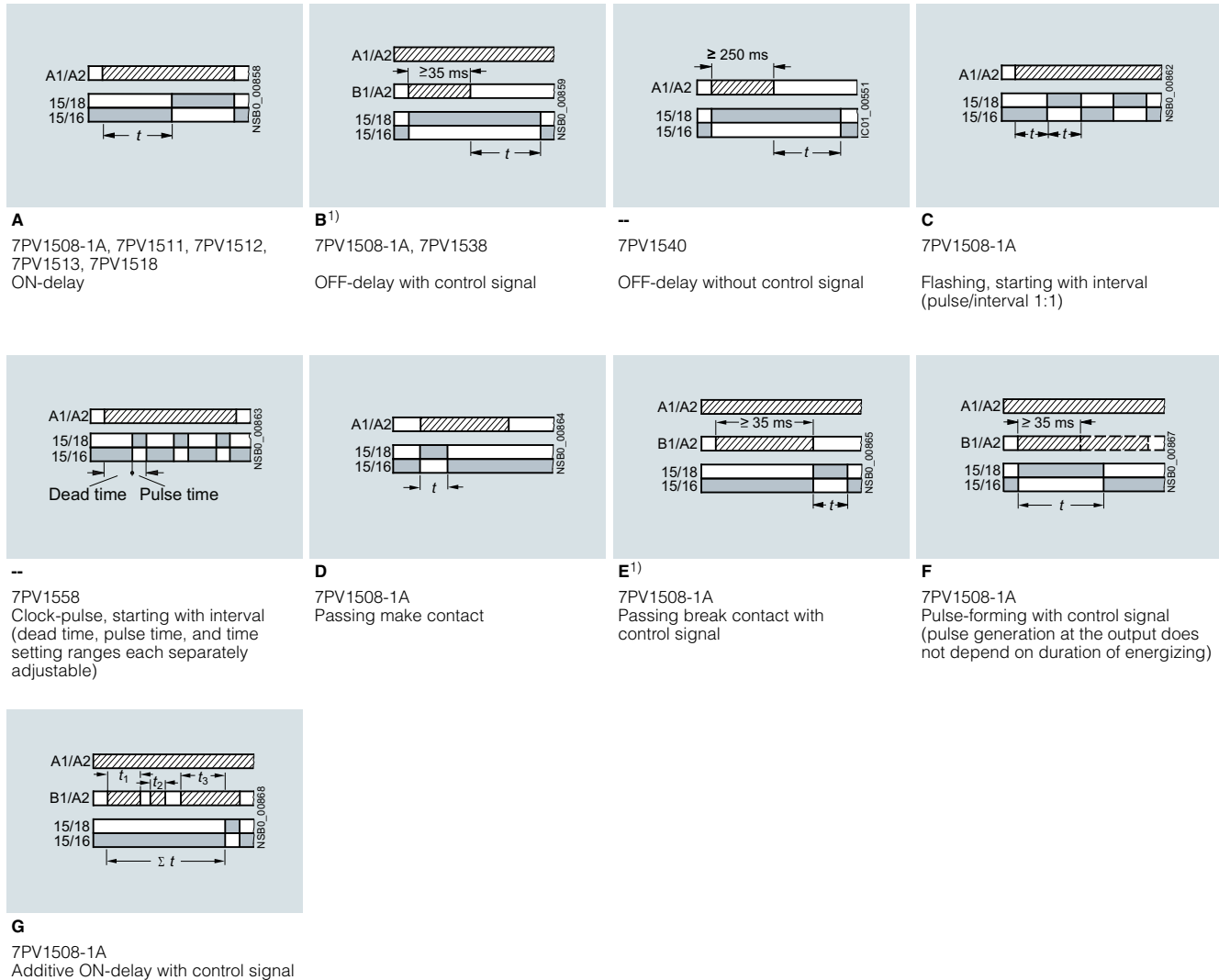

Legend

A ... G Identification letters for 7PV1508

▨ Timing relay energized

■ Contact closed

□ Contact open

¹⁾ A new control signal at terminal B, after the operating time has started, resets the operating time to zero (retriggerable).

Note:

With the 7PV1508-1A multifunctional timing relay the identification letters A to G are printed on the front alongside the rotary selector switch of the unit. The related function can be found in the form of a bar graph on the side of the device.

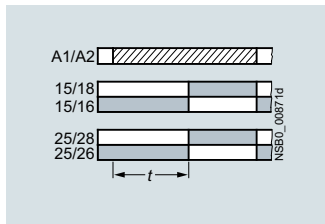
2 CO contacts

A
7PV1508-1B
ON-delay

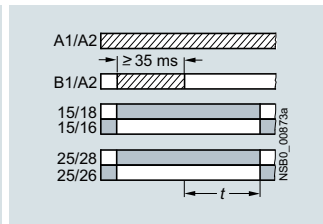

B¹⁾
7PV1508-1B
OFF-delay with control signal

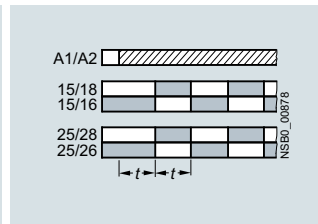

C
7PV1508-1B
Flashing, starting with interval
(pulse/interval 1:1)

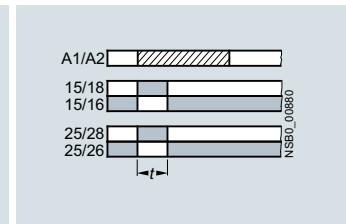

D
7PV1508-1B
Passing make contact

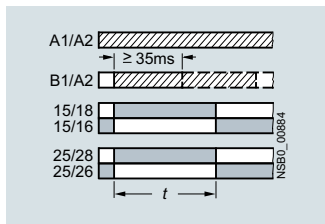

F
7PV1508-1B
Pulse-forming with control signal
(pulse generation
at the output does not depend
on duration of energizing)

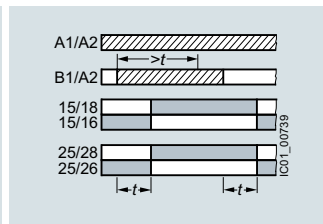

H
7PV1508-1B
ON-delay and OFF-delay with
control signal

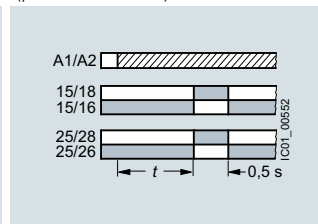

I
7PV1508-1B
Fixed pulse after ON-delay

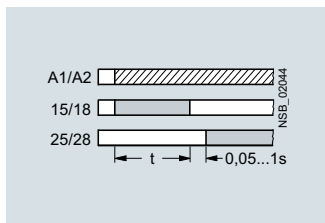
2 NO contacts

--
7PV1578
Wye-delta function²⁾

Legend

A ... D, F, H, I Identification letters for 7PV1508

▨ Timing relay energized

■ Contact closed

□ Contact open

¹⁾ A new control signal at terminal B, after the operating time has started, resets the operating time to zero (retriggerable).

²⁾ With 7PV1578 the contacts 16 and 26 are not needed for the wye-delta function.

Note:

With the 7PV1508-1B multifunctional timing relay the identification letters A to D, F, H, I are printed on the front alongside the rotary selector switch of the unit. The related function can be found in the form of a bar graph on the side of the device.

Monitoring and control devices

Relays

Timing relays

7PV15 timing relays, 17.5 mm

Selection and ordering data



7PV1508-1AW30



7PV1512-1AP30



7PV1518-1AW30



7PV1538-1AW30



7PV1540-1AW30



7PV1558-1AW30



7PV1578-1BW30

Version	Time setting range t adjustable by rotary switch to	Rated control supply voltage U_s		SD	Screw terminals	PU (UNIT, SET, M)	PS*	PG
		50/60 Hz AC V	DC V	d	Article No.	Price per PU		
7PV1508 timing relays, multifunction, 7 time setting ranges								
The functions can be adjusted by means of rotary switches. The same potential must be applied to terminals A. and B.								
With LED and 1 CO contact, 7 functions	0.05 ... 1 s 0.5 ... 10 s 5 ... 100 s	12 ... 240	12 ... 240	▶	7PV1508-1AW30	1	1 unit	41H
With LED and 2 CO contacts, 7 functions	30 s ... 10 min 3 min ... 1 h 30 min ... 10 h 5 ... 100 h	12 ... 240	12 ... 240	▶	7PV1508-1BW30	1	1 unit	41H
7PV151. timing relays, ON-delay, 1 time setting range								
With LED and 1 CO contact	0.05 ... 1 s	24/200 ... 240	24	▶	7PV1511-1AP30	1	1 unit	41H
	0.5 ... 10 s	24/100 ... 127	24	▶	7PV1512-1AQ30	1	1 unit	41H
		24/200 ... 240	24	▶	7PV1512-1AP30	1	1 unit	41H
	5 ... 100 s	24/100 ... 127	24	▶	7PV1513-1AQ30	1	1 unit	41H
24/200 ... 240		24	▶	7PV1513-1AP30	1	1 unit	41H	
7PV1518 timing relays, ON-delay, 7 time setting ranges								
With LED and 1 CO contact	0.05 ... 1 s 0.5 ... 10 s 5 ... 100 s 30 s ... 10 min 3 min ... 1 h 30 min ... 10 h 5 ... 100 h	12 ... 240	12 ... 240	▶	7PV1518-1AW30	1	1 unit	41H
7PV1538 timing relays, OFF-delay, with control signal, 7 time setting ranges								
With LED and 1 CO contact	0.05 ... 1 s 0.5 ... 10 s 5 ... 100 s 30 s ... 10 min 3 min ... 1 h 30 min ... 10 h 5 ... 100 h	12 ... 240	12 ... 240	▶	7PV1538-1AW30	1	1 unit	41H
7PV1540 timing relays, OFF-delay, without control signal, 7 time setting ranges								
With LED and 1 CO contact ¹⁾	0.05 ... 1 s 0.15 ... 3 s 0.3 ... 6 s 0.5 ... 10 s 1.5 ... 30 s 3 ... 60 s 5 ... 100 s	12 ... 240	12 ... 240	▶	7PV1540-1AW30	1	1 unit	41H
7PV1558 timing relays, clock-pulse relay, 7 time setting ranges								
With LED and 1 CO contact	0.05 ... 1 s 0.5 ... 10 s 5 ... 100 s 30 s ... 10 min 3 min ... 1 h 30 min ... 10 h 5 ... 100 h	12 ... 240	12 ... 240	▶	7PV1558-1AW30	1	1 unit	41H
7PV1578 timing relays, wye-delta function, 7 time setting ranges								
With LED and 2 NO contacts, dead interval 0.05 ... 1 s adjustable	0.05 ... 1 s 0.5 ... 10 s 5 ... 100 s 30 s ... 10 min 3 min ... 1 h 30 min ... 10 h 5 ... 100 h	12 ... 240	12 ... 240	▶	7PV1578-1BW30	1	1 unit	41H

¹⁾ Setting of output contacts in as-supplied state not defined (bistable relay).
Application of the control supply voltage once results in contact
changeover to the correct setting.

Overview

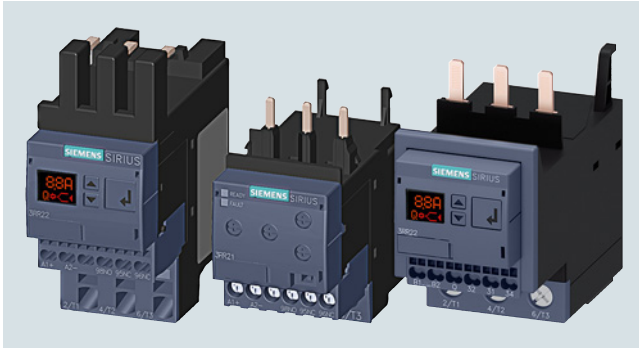

SIRIUS 3RR2242, 3RR2142, 3RR2243 current monitoring relays

More information

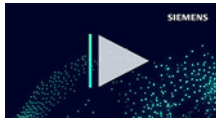
Homepage, see www.siemens.com/sirius-monitoring-relaysIndustry Mall, see www.siemens.com/product?3RR21

Video: SIRIUS 3RR2 current monitoring relays

The SIRIUS 3RR2 current monitoring relays are suitable for load monitoring of motors or other loads. In 2 or 3 phases they monitor the rms value of AC currents for overshooting or undershooting of set threshold values.

Whereas apparent current monitoring is used above all in connection with the rated torque or in case of overload, the active current monitoring option can be used to observe and evaluate the load factor over a motor's entire torque range.

The 3RR2 current monitoring relays can be integrated directly in the feeder by mounting on the 3RT2 contactor; separate wiring of the main circuit is therefore superfluous. No separate transformers are required.

For a line-oriented configuration or simultaneous use of an overload relay, terminal supports for stand-alone installation are available for separate standard rail mounting.

Versions

Basic versions

The basic versions with 2-phase apparent current monitoring, a CO contact output and analog adjustability provide a high level of monitoring reliability especially in the rated and overload range.

Standard versions

The standard versions monitor the current in 3 phases with selectable active current monitoring. They have additional diagnostics options such as residual-current monitoring and phase sequence monitoring, and they are also suitable for monitoring motors below the rated torque. These devices have an additional independent semiconductor output, an actual value indicator, and are digitally adjustable.

Both versions are available optionally with screw or spring-loaded terminals, in each case for sizes S00 and S0. With variants of size S2 the main conducting paths always have screw terminals; the control current side can have screw or spring-loaded terminals.

Note:

In addition to the features of the standard versions, the 3RR24 monitoring relays for mounting on 3RT2 contactors for IO-Link also offer the possibility of transmitting the measured values and diagnostics data to a controller via an IO-Link. Furthermore, the devices can be parameterized on the devices themselves or via IO-Link.

For more information, see page 10/59 onwards.

3RR21 and 3RR22 overview table



Features	3RR21	3RR22	Benefits
General data			
Sizes	S00, S0, S2	S00, S0, S2	<ul style="list-style-type: none"> Are coordinated with the dimensions, connections and technical characteristics of the other devices in the SIRIUS modular system (contactors, soft starters, etc.) Permit the mounting of slim-line and compact load feeders in widths of 45 mm (S00 and S0) and 55 mm (S2) Simplify configuration
Dimensions in mm (W x H x D)	S00: 45 x 79 x 80, S0: 45 x 87 x 91, S2: 55 x 99 x 112	S00: 45 x 79 x 80, S0: 45 x 87 x 91, S2: 55 x 99 x 112	
• Screw terminals			
• Spring-loaded terminals	S00: 45 x 90 x 80, S0: 45 x 109 x 92, S2: 55 x 99 x 112	S00: 45 x 90 x 80, S0: 45 x 109 x 92, S2: 55 x 99 x 112	
Current range	S00: 1.6 ... 16 A S0: 4 ... 40 A S2: 8 ... 80 A	S00: 1.6 ... 16 A S0: 4 ... 40 A S2: 8 ... 80 A	<ul style="list-style-type: none"> Is adapted to the other devices in the SIRIUS modular system Just a single version per size with a wide setting range enables easy configuration
Permissible ambient temperature			
During operation	-25 ... +60 °C	-25 ... +60 °C	<ul style="list-style-type: none"> Suitable for applications in the control cabinet, worldwide

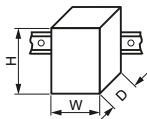

Monitoring and control devices

Relays

SIRIUS 3RR21, 3RR22 monitoring relays for mounting on 3RT2 contactors

Current and active current monitoring



Features	3RR21	3RR22	Benefits
Monitoring functions			
Current overshoot	✓ (2-phase)	✓ (3-phase)	<ul style="list-style-type: none"> Provides optimum inverse-time delayed protection of loads against excessive temperature rises due to overload Enables detection of filter blockages or pumping against closed gate valves Enables drawing conclusions about wear, poor lubrication or other maintenance-relevant phenomena
Current undershoot	✓ (2-phase)	✓ (3-phase)	<ul style="list-style-type: none"> Enables detection of overload due to a slipping or torn belt Guarantees protection of pumps against dry running Facilitates monitoring of the functions of resistive loads such as heaters Permits energy savings through monitoring of no-load operation
Apparent current monitoring	✓	✓ (Selectable)	<ul style="list-style-type: none"> Precision current monitoring especially in a motor's rated and upper torque range
Active current monitoring	--	✓ (Selectable)	<ul style="list-style-type: none"> Optimum current monitoring over a motor's entire torque range through the patented combination of power factor and apparent current monitoring
Range monitoring	✓ (2-phase)	✓ (3-phase)	<ul style="list-style-type: none"> Simultaneous monitoring of current overshoot and undershoot with a single device
Phase failure, open circuit	✓ (2-phase)	✓ (3-phase)	<ul style="list-style-type: none"> Minimizes heating of three-phase motors during phase failure through immediate disconnection Prevents operation of hoisting equipment with half the load carrying capacity
Phase sequence monitoring	--	✓ (Selectable)	<ul style="list-style-type: none"> Prevents starting of motors, pumps or compressors in the wrong direction of rotation
Internal ground-fault detection (residual-current monitoring)	--	✓ (Selectable)	<ul style="list-style-type: none"> Provides optimum protection of loads against high-resistance short circuits or ground faults due to moisture, condensed water, damage to the insulation material, etc. Eliminates the need for additional special equipment and thus space in the control cabinet Reduces wiring overhead and costs
Blocking current monitoring	--	✓ (Selectable)	<ul style="list-style-type: none"> Minimizes heating of three-phase motors when blocked during operation through immediate disconnection Minimizes mechanical loading of the system by acting as an electronic shear pin
Features			
RESET function	✓	✓	<ul style="list-style-type: none"> Allows manual or automatic resetting of the relay Resetting directly on the device or by switching the control supply voltage off and on (Remote RESET)
ON-delay time	0 ... 60 s	0 ... 99 s	<ul style="list-style-type: none"> Enables motor starting without evaluation of the starting current Can be used for monitoring motors with lengthy startup
Tripping delay time	0 ... 30 s	0 ... 30 s	<ul style="list-style-type: none"> Permits brief threshold value violations during operation Prevents frequent warnings and disconnections with currents near the threshold values
Operating and indicating elements	LEDs and rotary potentiometers	Displays and buttons	<ul style="list-style-type: none"> For setting the threshold values and delay times and for fast and targeted diagnostics For selectable functions Displays for permanent display of measured values
Integrated contacts	1 CO contact	1 CO contact, 1 semiconductor output	<ul style="list-style-type: none"> Enable disconnection of the system or process when there is an irregularity Can be used to output signals

✓ Available

-- Not available

SIRIUS 3RR21, 3RR22 monitoring relays for mounting on 3RT2 contactors

Current and active current monitoring

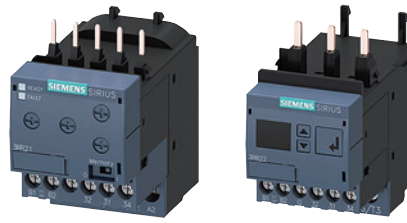

Features	3RR21	3RR22	Benefits
Design of load feeders			
Short-circuit strength up to 100 kA at 690 V (in conjunction with the corresponding fuses or the corresponding motor starter protector)	✓	✓	<ul style="list-style-type: none"> Provides optimum protection of the loads and operating personnel in the event of short circuits due to insulation faults or faulty switching operations
Electrical and mechanical matching to 3RT2 contactors	✓	✓	<ul style="list-style-type: none"> Simplifies configuration Reduces wiring overhead and costs Enables stand-alone installation as well as space-saving direct mounting
Spring-loaded terminals for main circuit (with S00, S0) and auxiliary circuits	✓ (optional)	✓ (optional)	<ul style="list-style-type: none"> Enables fast connections Permits vibration-resistant connections Enables maintenance-free connections
Other features			
Suitable for 1-phase and 3-phase loads	✓	✓	<ul style="list-style-type: none"> Enables the monitoring of 1-phase systems through parallel infeed at the contactor or looping the current through the three phase connections
Wide setting ranges	✓	✓	<ul style="list-style-type: none"> Reduce the number of versions Minimize the configuration overhead and costs Minimize storage overhead, storage costs, tied-up capital
Wide-voltage supply range	✓ (optional)	✓ (optional)	<ul style="list-style-type: none"> Reduces the number of versions Minimizes the configuring overhead and costs Minimizes storage overhead, storage costs, tied-up capital

✓ Available

Possible combinations of 3RR21/3RR22 monitoring relays with 3RT2 contactors

Monitoring relays	Current range	Contactors (type, size, operating power)		
		3RT201 S00	3RT202 S0	3RT203 S2
Type	A	3/4/5.5/7.5 kW	5.5/7.5/11/15/18.5 kW	18.5/22/30/37 kW
3RR2.41				
3RR2141	1.6 ... 16	✓	With stand-alone installation support	With stand-alone installation support
3RR2241	1.6 ... 16	✓	With stand-alone installation support	With stand-alone installation support
3RR2.42				
3RR2142	4 ... 40	With stand-alone installation support	✓	With stand-alone installation support
3RR2242	4 ... 40	With stand-alone installation support	✓	With stand-alone installation support
3RR2.43				
3RR2143	8 ... 80	With stand-alone installation support	With stand-alone installation support	✓
3RR2243	8 ... 80	With stand-alone installation support	With stand-alone installation support	✓

✓ Available

Monitoring and control devices

Relays

SIRIUS 3RR21, 3RR22 monitoring relays for mounting on 3RT2 contactors

Current and active current monitoring

Article No. scheme

Product versions		Article number						
Monitoring relays		3RR2	4	-			3	0
Type of setting	Analogically adjustable, 2-phase	1						
	Digitally adjustable, 3-phase	2						
Size	S00		1					
	S0		2					
	S2		3					
Connection type	Screw terminals				1			
	Spring-loaded terminals Size S00, S0				2			
	Size S2				3			
Number and type of outputs	1 CO contact					A		
	1 CO contact + 1 semiconductor					F		
Rated control supply voltage	24 V AC/DC						A	
	24 ... 240 V AC/DC						W	
Example		3RR2	1	4	1	-	1	A A 3 0

Note:

The Article No. scheme shows an overview of product versions for better understanding of the logic behind the article numbers.

For your orders, please use the article numbers quoted in the selection and ordering data.

Benefits

- Can be mounted directly on 3RT2 contactors and 3RA23 reversing contactor assemblies, in other words, there is no need for additional wiring in the main circuit
- Optimally coordinated with the technical characteristics of the 3RT2 contactors
- No separate current transformer required
- Versions with wide voltage supply range
- Variably adjustable to overshoot, undershoot or range monitoring
- Freely configurable delay times and RESET response
- Display of actual value and status messages
- All versions with removable control current terminals
- All versions with screw terminals or spring-loaded terminals
- Simple determination of the threshold values through direct reference to actually measured values for setpoint loading
- Range monitoring and selectable active current measurement mean that only one device for monitoring a motor is required along the entire torque curve
- In addition to current monitoring it is also possible to monitor for broken cables, phase failure, phase sequence, residual current and motor blocking

Application

- Monitoring for current overshoot and undershoot
- Monitoring of broken conductors
- Monitoring of no-load operation and load shedding, e.g. in the event of a torn V-belt or no-load operation of a pump
- Monitoring of overload, e.g. on conveyor belts or cranes due to an excessive load
- Monitoring the functionality of electrical loads such as heaters
- Monitoring of wrong phase sequence on mobile equipment such as compressors or cranes
- Monitoring of high-resistance ground faults, e.g. caused by damaged insulation or moisture

Technical specifications

More information

Technical specifications, see <https://support.industry.siemens.com/cs/ww/en/ps/16205/td>
 Configuration Manual for load feeders, see <https://support.industry.siemens.com/cs/ww/en/view/39714188>

System Manual for modular system, see <https://support.industry.siemens.com/cs/ww/en/view/60311318>
 Equipment Manual, see <https://support.industry.siemens.com/cs/ww/en/view/54397927>
 FAQs, see <https://support.industry.siemens.com/cs/ww/en/ps/16205/faq>

Function diagrams of 3RR214.-A.30 basic versions, analogically adjustable

Closed-circuit principle upon application of the control supply voltage

Current overshoot

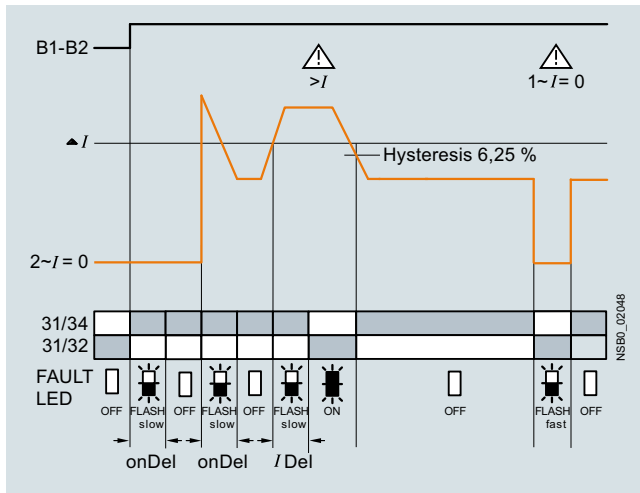

Range monitoring

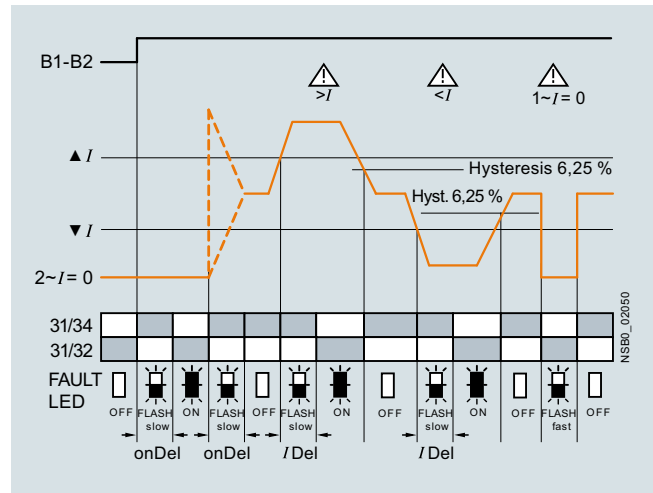

Current undershoot

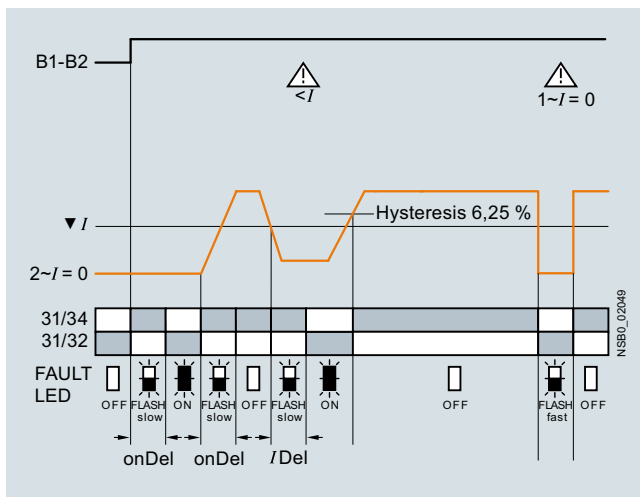

Monitoring and control devices

Relays

SIRIUS 3RR21, 3RR22 monitoring relays for mounting on 3RT2 contactors

Current and active current monitoring

Function diagrams of 3RR224.-F.30 standard versions, digitally adjustable

With the closed-circuit principle selected upon application of the control supply voltage

Current overshoot

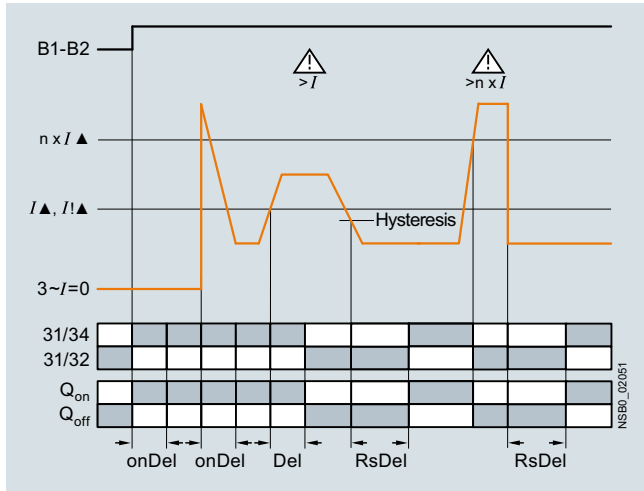

Range monitoring

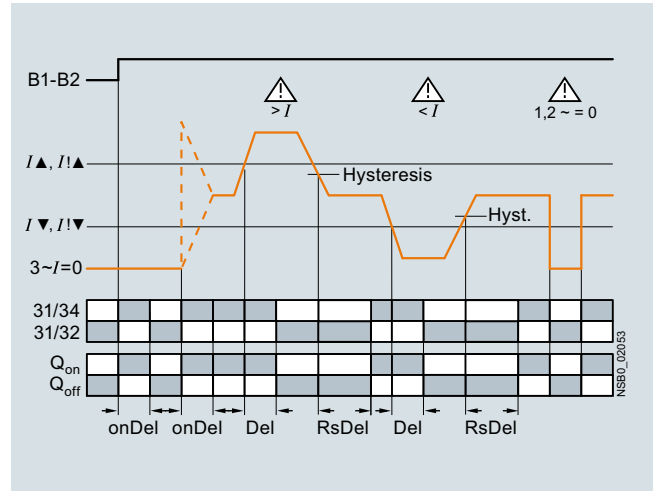

Current undershoot with residual-current monitoring

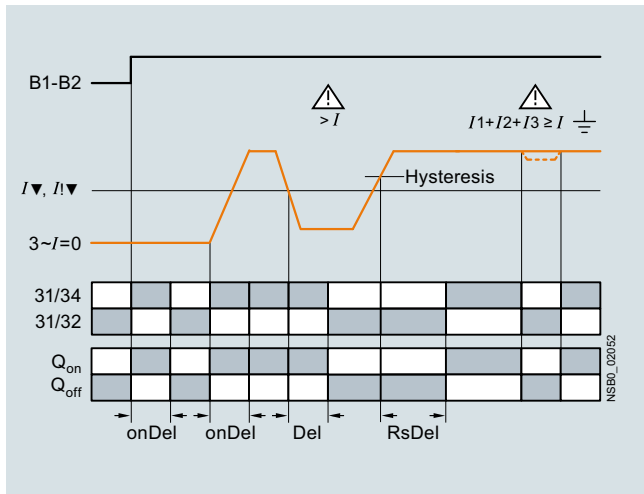

Phase sequence monitoring

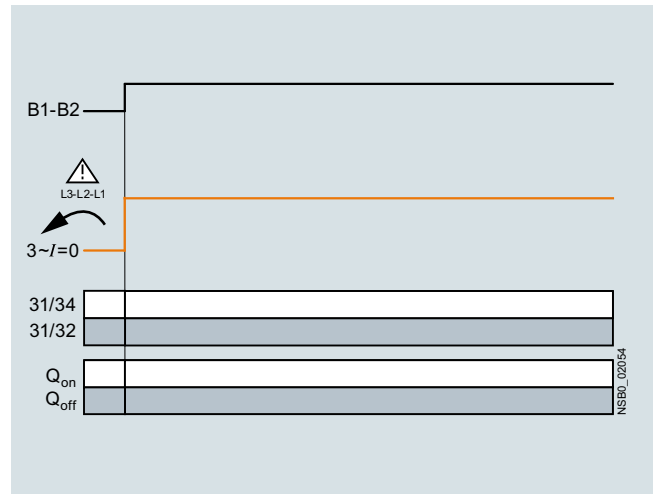

Selection and ordering data



3RR2141-1AW30



3RR2142-1AW30



3RR2241-1FW30



3RR2242-2FW30



3RR2141-2AA30



3RR2243-3FW30

Size	Measuring range	Hysteresis	Supply voltage U_s	SD	Article No.	Price per PU	PU (UNIT, SET, M)	PS*	PG
A	A	A	V	d					

Basic versions

- Analogically adjustable
- Closed-circuit principle
- 1 CO contact
- 2-phase current monitoring
- Apparent current monitoring
- ON-delay 0 ... 60 s
- Tripping delay 0 ... 30 s

S00	1.6 ... 16	6.25% of threshold value	24 AC/DC 24 ... 240 AC/DC	2	3RR2141-□AA30		1	1 unit	41H
				2	3RR2141-□AW30		1	1 unit	41H
S0	4 ... 40	6.25% of threshold value	24 AC/DC 24 ... 240 AC/DC	2	3RR2142-□AA30		1	1 unit	41H
				2	3RR2142-□AW30		1	1 unit	41H
S2	8 ... 80	6.25% of threshold value	24 AC/DC 24 ... 240 AC/DC	2	3RR2143-□AA30		1	1 unit	41H
				2	3RR2143-□AW30		1	1 unit	41H

Standard versions

- Digitally adjustable
- LC display
- Open-circuit or closed-circuit principle
- 1 CO, 1 semiconductor output
- 3-phase current monitoring
- Active current or apparent current monitoring
- Phase sequence monitoring
- Residual-current monitoring
- Blocking current monitoring
- Reclosing delay time 0 ... 300 min
- ON-delay 0 ... 99 s
- Separate settings for warning and alarm thresholds
- Tripping delay 0 ... 30 s

S00	1.6 ... 16	0.1 ... 3	24 AC/DC 24 ... 240 AC/DC	▶	3RR2241-□FA30		1	1 unit	41H
				▶	3RR2241-□FW30		1	1 unit	41H
S0	4 ... 40	0.1 ... 8	24 AC/DC 24 ... 240 AC/DC	2	3RR2242-□FA30		1	1 unit	41H
				2	3RR2242-□FW30		1	1 unit	41H
S2	8 ... 80	0.2 ... 16	24 AC/DC 24 ... 240 AC/DC	2	3RR2243-□FA30		1	1 unit	41H
				2	3RR2243-□FW30		1	1 unit	41H

Type of electrical connection

- Screw terminals
- Spring-loaded terminals size S00, S0
- Spring-loaded terminals size S2

1
2
3

Monitoring and control devices

Relays

SIRIUS 3RR21, 3RR22 monitoring relays for mounting on 3RT2 contactors

Current and active current monitoring

Accessories

Use	Version	Size	SD	Article No.	Price per PU	PU (UNIT, SET, M)	PS*	PG
Terminal supports for stand-alone installation¹⁾								
 3RU2916-3AA01	For 3RR21, 3RR22 For separate mounting of the overload relays or monitoring relays; screw fixing and snap-on mounting on TH 35 standard mounting rail according to IEC 60715	• Screw terminals	S00 ▶	3RU2916-3AA01		1	1 unit	41F
			S0 ▶	3RU2926-3AA01		1	1 unit	41F
			S2 ▶	3RU2936-3AA01		1	1 unit	41F
 3RU2936-3AA01		• Spring-loaded terminals	S00 ▶	3RU2916-3AC01		1	1 unit	41F
			S0 ▶	3RU2926-3AC01		1	1 unit	41F
 3RU2926-3AC01				3RU2916-3AC01		1	1 unit	41F
				3RU2926-3AC01		1	1 unit	41F
Sealable covers								
 3RR2940	For 3RR21, 3RR22	Sealable covers For securing against unintentional or unauthorized adjustment of settings	▶	3RR2940		1	5 units	41H
Blank labels								
 3RT2900-1SB20	For 3RR21, 3RR22	Unit labeling plates²⁾ For SIRIUS devices	• 20 mm x 7 mm, titanium gray	20	3RT2900-1SB20	100	340 units	41B
Tools for opening spring-loaded terminals								
 3RA2908-1A	For auxiliary circuit connections	Screwdrivers For all SIRIUS devices with spring-loaded terminals	Length approx. 200 mm, 3,0 mm x 0,5 mm, titanium gray/black, partially insulated	2	3RA2908-1A	1	1 unit	41B

¹⁾ The accessories are exactly the same as the accessories for the 3RU21 thermal overload relay and the 3RB3 electronic overload relay, see page 7/104 onwards.

²⁾ PC labeling system for individual inscription of unit labeling plates available from: murrplastik Systemtechnik GmbH, see page 16/16.

Overview

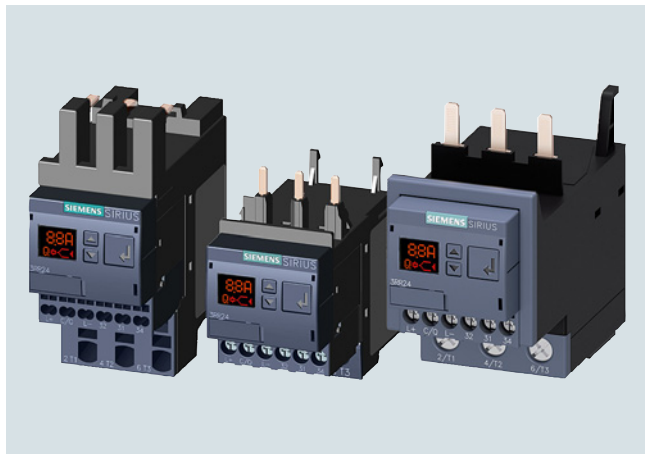

SIRIUS 3RR2441, 3RR2442 and 3RR2443 current monitoring relays

More information

Homepage, see www.siemens.com/sirius-monitoring-relays

Industry Mall, see www.siemens.com/product?3RR24



Video: SIRIUS 3RR2 current monitoring relays

The SIRIUS 3RR24 current monitoring relays for IO-Link are suitable for the load monitoring of motors or other loads. In 3 phases they monitor the rms value of AC currents for overshooting or undershooting of set threshold values.

Whereas apparent current monitoring is used above all in connection with the rated torque or in case of overload, the active current monitoring option, which is also selectable, can be used to observe and evaluate the load factor over a motor's entire torque range.

The 3RR24 current monitoring relays for IO-Link can be integrated directly in the feeder by mounting on the 3RT2 contactor; separate wiring of the main circuit is therefore superfluous. No separate transformers are required.

For a line-oriented configuration or simultaneous use of an overload relay, terminal supports for stand-alone installation are available for separate standard rail mounting.

The SIRIUS 3RR24 current monitoring relays for IO-Link also offer many other options based upon the monitoring functions of the conventional SIRIUS 3RR2 monitoring relays:

- Measured value transmission to a controller, including resolution and unit, may be parameterizable as to which value is cyclically transmitted
- Transmission of alarm flags to a controller
- Full diagnostics capability by inquiry as to the cause of the fault in the diagnostics data record
- Remote parameterization is also possible, in addition to or instead of local parameterization

- Rapid parameterization of the same devices by duplication of the parameterization in the controller
- Parameter transmission through upload to a controller by IO-Link call or by parameter server (if IO-Link master from IO-Link specification V1.1 and higher is used)
- Consistent central data storage in the event of parameter change locally or via a controller
- Automatic reparameterizing when devices are exchanged
- Blocking of local parameterization via IO-Link possible
- Faults are saved in parameterizable and non-volatile fashion to prevent an automatic startup after voltage failure and to make sure diagnostics data are not lost
- Integration into the automation level provides the option of parameterizing the monitoring relays at any time via a display unit, or displaying the measured values in a control room or locally at the machine/control cabinet.
- The MindSphere app SIRIUS Asset Monitor enables access to the SIRIUS 3RR24 current monitoring relay anytime and anywhere. It provides the user with detailed information on the device status as well as fault messages and warnings in a clearly arranged form, see [page 14/26](#).

Even without communication via IO-Link the devices continue to function fully autonomously:

- Parameterization can take place locally at the device, independently of a controller.
- In the event of failure or before the controller becomes available the monitoring relays work as long as the control supply voltage (24 V DC) is present.
- If the monitoring relays are operated without the controller, the 3RR24 monitoring relays for IO-Link have, thanks to the integrated SIO mode, an additional semiconductor output, which switches when the adjustable warning threshold is exceeded.

Thanks to the combination of autonomous monitoring relay function and integrated IO-Link communication, redundant sensors and/or analog signal converters – which previously took over the transmission of measured values to a controller, leading to considerable extra cost and wiring overhead – are no longer needed.

Because the output relays are still present, the monitoring relays increase the functional reliability of the system, since only the controller can fulfill the control tasks if the current measured values are available, whereas the output relays can also be used for the disconnection of the system if limit values that cannot be reached during operation are exceeded.

For more information on the IO-Link communication system, see [page 2/87](#) onwards.

Notes on security

In order to protect plants, systems, machines and networks against cyber threats, it is necessary to implement – and continuously maintain – a holistic, state-of-the-art industrial security concept. Siemens products and solutions represent only one component of such a concept.

For more information about the subject of Industrial Security, see www.siemens.com/industrialsecurity.

Monitoring and control devices

Relays

SIRIUS 3RR24 monitoring relays for mounting on 3RT2 contactors for IO-Link

Current and active current monitoring

3RR24 overview table

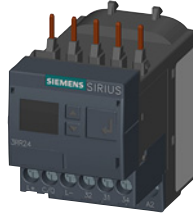

Features	3RR24	Benefits
General data		
Sizes Dimensions in mm (W x H x D) • Screw terminals • Spring-loaded terminals	 S00, S0, S2 S00: 45 x 79 x 80, S0: 45 x 87 x 91, S2: 55 x 99 x 112 S00: 45 x 90 x 80, S0: 45 x 109 x 92, S2: 55 x 99 x 112	<ul style="list-style-type: none"> • Are coordinated with the dimensions, connections and technical characteristics of the other devices in the SIRIUS modular system (contactors, soft starters, etc.) • Permit the mounting of slim-line and compact load feeders in widths of 45 mm (S00 and S0) and 55 mm (S2) • Simplify configuration
Current range	S00: 1.6 ... 16 A S0: 4 ... 40 A S2: 8 ... 80 A	<ul style="list-style-type: none"> • Is adapted to the other devices in the SIRIUS modular system • Just a single version per size with a wide setting range enables easy configuration
Permissible ambient temperature		
During operation	-25 ... +60 °C	<ul style="list-style-type: none"> • Suitable for applications in the control cabinet, worldwide
Monitoring functions		
Current overshoot	✓ (3-phase)	<ul style="list-style-type: none"> • Provides optimum inverse-time delayed protection of loads against excessive temperature rises due to overload • Enables detection of filter blockages or pumping against closed gate valves • Enables drawing conclusions about wear, poor lubrication or other maintenance-relevant phenomena
Current undershoot	✓ (3-phase)	<ul style="list-style-type: none"> • Enables detection of overload due to a slipping or torn belt • Guarantees protection of pumps against dry running • Facilitates monitoring of the functions of resistive loads such as heaters • Permits energy savings through monitoring of no-load operation
Apparent current monitoring	✓ (Selectable)	<ul style="list-style-type: none"> • Precision current monitoring especially in a motor's rated and upper torque range
Active current monitoring	✓ (Selectable)	<ul style="list-style-type: none"> • Optimum current monitoring over a motor's entire torque range through the patented combination of power factor and apparent current monitoring
Range monitoring	✓ (3-phase)	<ul style="list-style-type: none"> • Simultaneous monitoring of current overshoot and undershoot with a single device
Phase failure, open circuit	✓ (3-phase)	<ul style="list-style-type: none"> • Minimizes heating of three-phase motors during phase failure through immediate disconnection • Prevents operation of hoisting equipment with half the load carrying capacity
Phase sequence monitoring	✓ (Selectable)	<ul style="list-style-type: none"> • Prevents starting of motors, pumps or compressors in the wrong direction of rotation
Internal ground-fault detection (residual-current monitoring)	✓ (Selectable)	<ul style="list-style-type: none"> • Provides optimum protection of loads against high-resistance short circuits or ground faults due to moisture, condensed water, damage to the insulation material, etc. • Eliminates the need for additional special equipment • Saves space in the control cabinet • Reduces wiring overhead and costs
Blocking current monitoring	✓ (Selectable)	<ul style="list-style-type: none"> • Minimizes heating of three-phase motors when blocked during operation through immediate disconnection • Minimizes mechanical loading of the system by acting as an electronic shear pin
Operating hours counter	✓	<ul style="list-style-type: none"> • Gives the time during which there was a measurable current in at least 2 conducting paths • As an indicator for upcoming maintenance or replacement of machine and system components
Operating cycles counter	✓	<ul style="list-style-type: none"> • Is incremented by 1 each time a breaking operation is detected, in other words a transition from 3-phase current flow to no measurable current flow • As an indicator for upcoming maintenance or replacement of contact blocks

✓ Available



Features	3RR24	Benefits
Features		
RESET function	✓	<ul style="list-style-type: none"> Allows manual or automatic resetting of the relay Resetting directly on the device, by switching the control supply voltage off and on or via IO-Link (Remote RESET)
ON-delay time	0 ... 999.9 s	<ul style="list-style-type: none"> Enables motor starting without evaluation of the starting current Can be used for monitoring motors with lengthy startup
Tripping delay time	0 ... 999.9 s	<ul style="list-style-type: none"> Permits brief threshold value violations during operation Prevents frequent warnings and disconnections with currents near the threshold values
Operating and indicating elements	Displays and buttons	<ul style="list-style-type: none"> For setting the threshold values and delay times For selectable functions For quick and selective diagnostics Displays for permanent display of measured values
Integrated contacts	1 CO contact, 1 semiconductor output (in SIO mode)	<ul style="list-style-type: none"> Enable disconnection of the system or process when there is an irregularity Can be used to output signals
Design of load feeders		
Short-circuit strength up to 100 kA at 690 V (in conjunction with the corresponding fuses or the corresponding motor starter protector)	✓	<ul style="list-style-type: none"> Provides optimum protection of the loads and operating personnel in the event of short circuits due to insulation faults or faulty switching operations
Electrical and mechanical matching to 3RT2 contactors	✓	<ul style="list-style-type: none"> Simplifies configuration Reduces wiring overhead and costs Enables stand-alone installation as well as space-saving direct mounting
Spring-loaded terminals for main circuit (with S00, S0) and auxiliary circuits	✓ (optional)	<ul style="list-style-type: none"> Enables fast connections Permits vibration-resistant connections Enables maintenance-free connections
Other features		
Suitable for 1-phase and 3-phase loads	✓	<ul style="list-style-type: none"> Enables the monitoring of 1-phase systems through parallel infeed at the contactor or looping the current through the three phase connections
Wide setting ranges	✓	<ul style="list-style-type: none"> Reduce the number of variants Minimize the configuration overhead and costs Minimize storage overhead, storage costs, tied-up capital
Power supply	24 V DC	<ul style="list-style-type: none"> Direct via IO-Link master or via an external auxiliary voltage independent of the IO-Link Minimizes the configuring overhead and costs

✓ Available

Possible ways of combining the 3RR24 monitoring relay with the 3RT2 contactor for IO-Link

Monitoring relays	Current range	Contactors (type, size, operating power)		
		3RT201 S00	3RT202 S0	3RT203 S2
Type	A	3/4/5.5/7.5 kW	5.5/7.5/11/15/18.5 kW	18.5/22/30/37 kW
3RR2441	1.6 ... 16	✓	With stand-alone installation support	With stand-alone installation support
3RR2442	4 ... 40	With stand-alone installation support	✓	With stand-alone installation support
3RR2443	8 ... 80	With stand-alone installation support	With stand-alone installation support	✓

✓ Available

Notes:

Devices required for communication via IO-Link:

- Any controller that supports IO-Link (e.g. ET 200SP with CPU or S7-1200), [see Catalog ST 70](#).
- IO-Link master (e.g. CM 4xIO-Link for SIMATIC ET 200SP, [see page 2/98](#) or SM 1278 for S7-1200, [see page 2/97](#)).

Each monitoring relay requires an IO-Link channel.

Monitoring and control devices

Relays

SIRIUS 3RR24 monitoring relays for mounting on 3RT2 contactors for IO-Link

Current and active current monitoring

Article No. scheme

Product versions		Article number									
3RR24 monitoring relay, digitally adjustable with IO-Link		3RR2	4	4	<input type="checkbox"/>	-	<input type="checkbox"/>	A	A	4	0
Size	S00										1
	S0										2
	S2										3
Connection type	Screw terminals										1
	Spring-loaded terminals										2
	Size S00, S0										3
	Size S2										3
Example		3RR2	4	4	1	-	1	A	A	4	0

Note:

The Article No. scheme shows an overview of product versions for better understanding of the logic behind the article numbers.

For your orders, please use the article numbers quoted in the selection and ordering data.

Benefits

- Can be mounted directly on 3RT2 contactors and 3RA23 reversing contactor assemblies, in other words, there is no need for additional wiring in the main circuit
- Optimally coordinated with the technical characteristics of the 3RT2 contactors
- No separate current transformer required
- Variably adjustable to overshoot, undershoot or range monitoring
- Freely configurable delay times and RESET response
- Display of actual value and status messages
- All versions with removable control current terminals
- All versions with screw or spring-loaded terminals
- Simple determination of the threshold values through direct reference to actually measured values for setpoint loading
- Range monitoring and selectable active current measurement mean that only one device for monitoring a motor is required along the entire torque curve
- In addition to current monitoring it is also possible to monitor for current asymmetry, broken cables, phase failure, phase sequence, residual current and motor blocking
- Integrated counter for operating cycles and operating hours to support requirements-based maintenance of the monitored machine or application
- Simple cyclical transmission of the current measured values, relay switching states and events to a controller
- Remote parameterization
- Automatic reparameterizing when devices are exchanged
- Simple duplication of identical or similar parameterizations
- Reduction of control current wiring
- Elimination of testing costs and wiring errors
- Reduction of configuration work
- Integration in TIA means clear diagnostics if a fault occurs
- Cost saving and space saving in control cabinet due to the elimination of AI and IO modules as well as analog signal converters and duplicated sensors

Application

- Monitoring for current overshoot and undershoot
- Monitoring of broken conductors
- Monitoring of no-load operation and load shedding, e.g. in the event of a torn V-belt or no-load operation of a pump
- Monitoring of overload, e.g. on pumps due to a dirty filter system
- Monitoring the functionality of electrical loads such as heaters
- Monitoring of wrong phase sequence on mobile equipment such as compressors or cranes
- Monitoring of high-resistance short circuits or ground faults, e.g. caused by damaged insulation or moisture

The use of SIRIUS monitoring relays for IO-Link is particularly recommended for machines and plants in which these relays, in addition to their monitoring function, are to be connected to the automation level for the rapid, simple and fault-free provision of the current measured values and/or for remote parameterization.

The monitoring relays can either relieve the controller of monitoring tasks or, as a second monitoring entity in parallel to and independent of the controller, increase the reliability in the process or in the system. In addition, the elimination of AI and IO modules allows the width of the controller to be reduced despite significantly expanded functionality.

Technical specifications

More information

Technical specifications, see <https://support.industry.siemens.com/cs/ww/en/ps/16206/td>
 Configuration Manual for load feeders, see <https://support.industry.siemens.com/cs/ww/en/view/39714188>

System Manual for modular system, see <https://support.industry.siemens.com/cs/ww/en/view/60311318>
 Equipment Manual, see <https://support.industry.siemens.com/cs/ww/en/view/54375430>
 FAQs, see <https://support.industry.siemens.com/cs/ww/en/ps/16206/faq>

Function diagrams of 3RR24 for IO-Link, digitally adjustable

With the closed-circuit principle selected upon application of the control supply voltage

Current overshoot

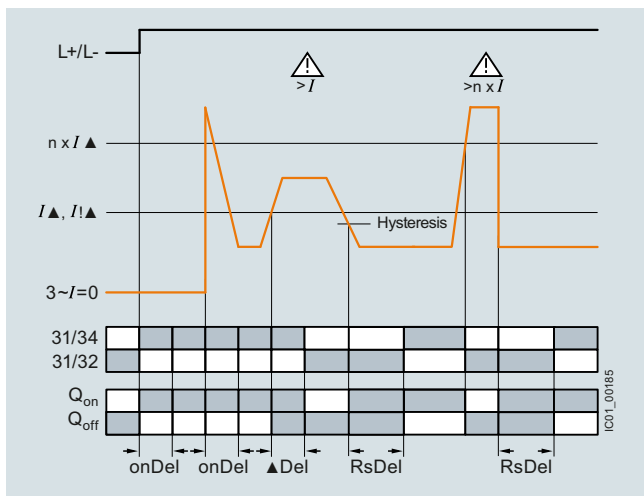

Range monitoring

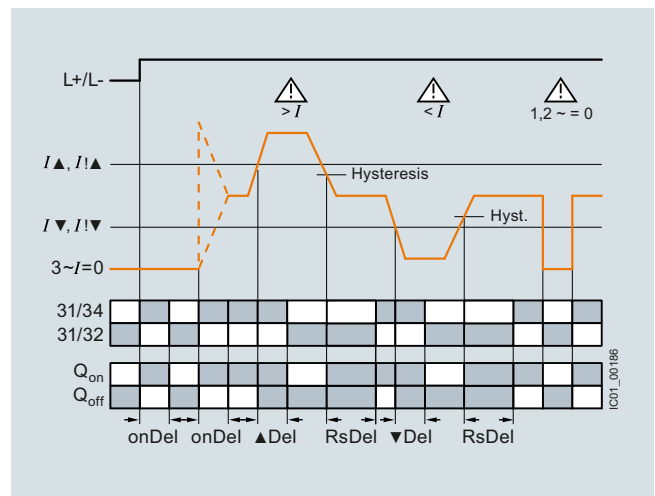

Current undershoot with residual-current monitoring

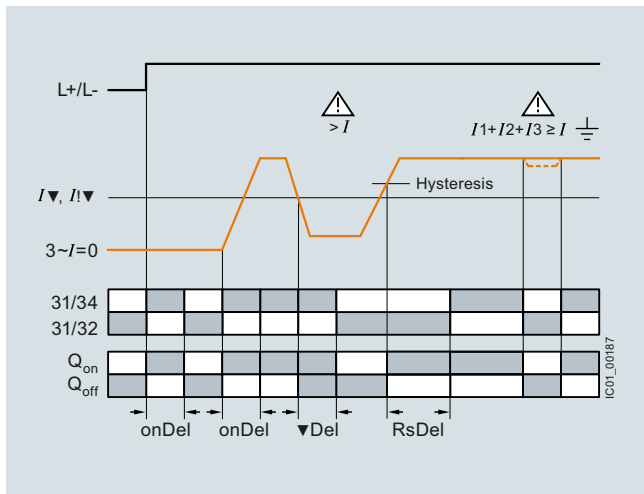

Phase sequence monitoring

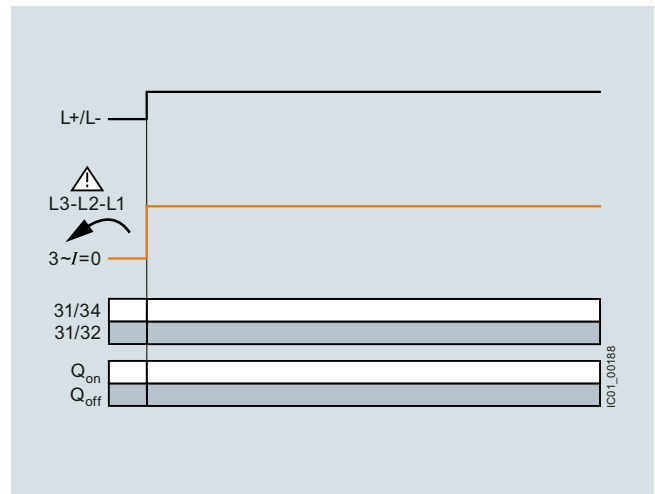

Monitoring and control devices

Relays

SIRIUS 3RR24 monitoring relays for mounting on 3RT2 contactors for IO-Link

Current and active current monitoring

Selection and ordering data

SIRIUS 3RR24 current monitoring relays for IO-Link



3RR2441-1AA40

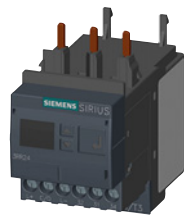

3RR2442-1AA40

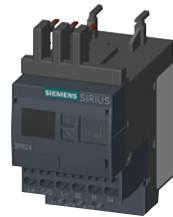

3RR2441-2AA40



3RR2442-2AA40



3RR2443-1AA40

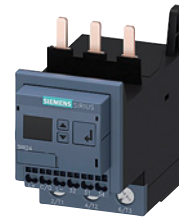

3RR2443-2AA40









Size	Measuring range	Hysteresis	Supply voltage U_s	SD	Article No.	Price per PU	PU (UNIT, SET, M)	PS*	PG
A	A	A	V	d					
<ul style="list-style-type: none"> Digitally adjustable LC display Open-circuit or closed-circuit principle 1 CO contact 1 semiconductor output (in SIO mode) 3-phase current monitoring Active current or apparent current monitoring Current asymmetry monitoring Phase sequence monitoring Residual-current monitoring Blocking current monitoring Operating hours counter Operating cycles counter Reclosing delay time 0 ... 300 min ON-delay 0 ... 999.9 s Tripping delay 0 ... 999.9 s Separate settings for warning and alarm thresholds Auto or Manual RESET 									
S00	1.6 ... 16	0.1 ... 3	24 DC	2	3RR2441-□AA40		1	1 unit	41H
S0	4 ... 40	0.1 ... 8	24 DC	2	3RR2442-□AA40		1	1 unit	41H
S2	8 ... 80	0.2 ... 16	24 DC	2	3RR2443-□AA40		1	1 unit	41H

Type of electrical connection

- Screw terminals
- Spring-loaded terminals size S00, S0
- Spring-loaded terminals size S2

1
2
3

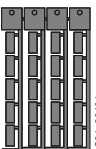
Accessories

Use	Version	Size	SD	Article No.	Price per PU	PU (UNIT, SET, M)	PS*	PG				
Terminal supports for stand-alone installation¹⁾												
 3RU2916-3AA01	For 3RR24	For separate mounting of the overload relays or monitoring relays; screw fixing and snap-on mounting on TH 35 standard mounting rail according to IEC 60715	▶	Screw terminals 		1	1 unit	41F				
				S00	▶				3RU2916-3AA01	1	1 unit	41F
				S0	▶				3RU2926-3AA01	1	1 unit	41F
 3RU2936-3AA01			▶			1	1 unit	41F				
				S2	▶				3RU2936-3AA01	1	1 unit	41F
 3RU2926-3AC01			▶	Spring-loaded terminals 		1	1 unit	41F				
				S00	▶				3RU2916-3AC01	1	1 unit	41F
			▶									
			▶									
Sealable covers												
 3RR2940	For 3RR24	Sealable covers For securing against unintentional or unauthorized adjustment of settings	▶			1	5 units	41H				
									3RR2940			
Blank labels												
 3RT2900-1SB20	For 3RR24	Unit labeling plates²⁾ For SIRIUS devices	▶			100	340 units	41B				
									20	3RT2900-1SB20		
Tools for opening spring-loaded terminals												
 3RA2908-1A	For auxiliary circuit connections	Screwdrivers For all SIRIUS devices with spring-loaded terminals Length approx. 200 mm, 3,0 mm x 0,5 mm, titanium gray/black, partially insulated	▶	Spring-loaded terminals 		1	1 unit	41B				
									2	3RA2908-1A		
Software												
	For 3RR24	SIRIUS Asset Monitor The MindSphere app enables access to the SIRIUS 3RR24 monitoring relays anytime and anywhere and provides detailed information about the device status and fault messages and warnings, see page 14/26 .										

¹⁾ The accessories are exactly the same as the accessories for the 3RU21 thermal overload relay and the 3RB3 electronic overload relay, see [page 7/104](#) onwards.

²⁾ PC labeling system for individual inscription of unit labeling plates available from: murrplastik Systemtechnik GmbH, see [page 16/16](#).

Monitoring and control devices

Relays

SIRIUS 3UG5 monitoring relays for stand-alone installation

DC load monitoring

Overview



SIRIUS 3UG546 DC load monitoring relays

More information

Homepage, see www.siemens.com/sirius-monitoring-relays

Industry Mall, see www.siemens.com/product?3UG5

The SIRIUS 3UG546 DC load monitoring relays are suitable for monitoring motors, batteries, and other DC equipment. They are also suitable for applications where batteries are used. The devices monitor the DC current, voltage, and actual power for overshooting or undershooting of the set limit values in 1 or 2 channels. The relays have a CO contact output for alarms and operate on the closed-circuit principle (NC).

The devices are parameterized via PROFINET, and transfer the measured values and diagnostic messages to a controller. Besides providing detailed fault diagnostics, the integrated energy counters, operating hours counters, and operating cycle counters can also be read out and reset.

When metering energy consumption, the SIRIUS 3UG546 DC load monitoring relays distinguish the direction of current flow and can thus, for example, separately sense the quantities of energy stored in or drawn from a battery.

Article No. scheme

Product versions		Article number				
Monitoring relays		3UG546	<input type="checkbox"/>	1	A A 4	<input type="checkbox"/>
Current measuring range	2 x 8 A/1 x 16 A		1			
	1 x 63 A		2			
Voltage range	0 ... 800 V					0
	0 ... 60 V					1
Example		3UG546	1	- 1	A A 4	0

Note:

The Article No. scheme shows an overview of product versions for better understanding of the logic behind the article numbers.

Features	3UG5461-1AA4., 3UG5462-1AA4.
DC monitoring	
Monitoring the DC current for undershoot	✓
Monitoring the DC current for overshoot	✓
Range monitoring	✓
Voltage monitoring	
Monitoring the voltage for undershoot	✓
Monitoring the voltage for overshoot	✓
Range monitoring	✓
Power monitoring	
Monitoring the power for undershoot	✓
Monitoring the power for overshoot	✓
Range monitoring	✓
Delay times	
ON-delay	✓
Tripping delay	✓
Operating hours counter	
Monitoring for overshoot	✓
Operating cycles counter	
Monitoring for overshoot	✓
Energy recovery counter	
Monitoring for overshoot	✓
Energy consumption counter	
Monitoring for overshoot	✓
PROFINET IO functions	
Ethernet services	✓
Port diagnostics	✓
Min. update time	2 ms
Resetting of communication parameters to factory settings	✓
PROFINET RT (real-time communication)	✓
Firmware update via PROFINET IO	✓
I&M identification data 0 to 3	✓
✓ Available	

For your orders, please use the article numbers quoted in the selection and ordering data.

Benefits

- Wide voltage measuring range of up to 800 V
- 60 V versions especially for applications where batteries are used
- Detection and monitoring of current, voltage and power in a single device
- Detailed fault diagnostics
- Energy metering with distinction of direction of current flow
- Communication and visualization via PROFINET and thus quick and easy integration for visualizing plant energy values
- Integration in the TIA Portal
- Customary screw terminals for quick and reliable wiring
- Device replacement without renewed wiring thanks to removable terminals

Application

- Exhaustive discharge protection on battery-operated vehicles
- Acquisition of energy flows, incl. energy recovery, e.g. for robots
- DC line monitoring
- DC heaters
- Lighting systems
- Energy management
- Condition monitoring

Technical specifications**More information**

Technical specifications, see <https://support.industry.siemens.com/cs/ww/en/ps/25412/td>

Equipment Manual, see <https://support.industry.siemens.com/cs/ww/en/ps/25412/man>
 FAQs, see <https://support.industry.siemens.com/cs/ww/en/ps/25412/faq>

Article number		3UG5461-1AA40	3UG5461-1AA41	3UG5462-1AA40	3UG5462-1AA41
General technical specifications:					
Dimensions (W x H x D)	mm	22.5 x 100 x 141.6		45 x 100 x 141.6	
Type of electrical separation		Protective separation			
Electrical endurance (operating cycles) for relay outputs, maximum		100 000, 0.5 A, 125 V AC, for resistive load up to 40 °C			
Mechanical service life (operating cycles), typical		10 000 000			
Power loss [W], maximum	W	3			
Adjustable response value current 1	A	-8 ... +8		-63 ... +63	
Adjustable response value current 2	A	-8 ... +8		--	
Adjustable ON-delay time					
• On starting	s	0 ... 999			
• On upper or lower limit violation	s	0 ... 999			
Adjustable voltage range	V	0 ... 800	0 ... 60	0 ... 800	0 ... 60
Minimum supply voltage failure buffering time	ms	10			
Reaction time, maximum	ms	100			
Degree of protection IP on the front according to IEC 60529		IP20			
Touch protection on the front according to IEC 60529		Finger-safe		Finger-safe for vertical touching from the front	
Type of mounting		Screw fixing and snap-on mounting on 35 mm standard mounting rail			
• Mounting position		Any			
Installation altitude at height above sea level, maximum	m	2 000			
Ambient temperature					
• During operation	°C	-25 ... +60			
• During storage	°C	-40 ... +80			
Relative temperature-related measurement deviation	%	0.5			
Number of ports at the interface 1		1			
Product function					
• Operating cycles counter		Yes			
• Operating hours counter		Yes			
• Auto RESET		Yes			
• Manual RESET		Yes			
• Overvoltage detection DC		Yes			
• Overcurrent detection DC		Yes			
• Undervoltage detection DC		Yes			
• Undercurrent detection DC		Yes			
Product component					
• Removable terminal for main circuit		Yes		No	
• Removable terminal for auxiliary and control circuit		Yes			

Monitoring and control devices

Relays

SIRIUS 3UG5 monitoring relays for stand-alone installation

DC load monitoring

Article number	3UG5461-1AA40	3UG5461-1AA41	3UG5462-1AA40	3UG5462-1AA41
Measuring circuit:				
Relative measuring accuracy with reference to the full-scale value	%	2		
Number of CO contacts for auxiliary contacts		1		
Control circuit:				
Current-carrying capacity of the output relay at DC-13 at 24 V	A	1		
Thermal current of the non-solid-state contact blocks, maximum	A	1		
Type of voltage for monitoring		DC		
Type of current for monitoring		DC		
Supply voltage type		DC		
Supply voltage 1 at DC, rated value	V	24		
Supply voltage:				
Operating range factor of the supply voltage, rated value At DC		0.85 ... 1.15		

Article number	3UG5461-1AA40	3UG5461-1AA41	3UG5462-1AA40	3UG5462-1AA41
Type of electrical connection	 Screw terminals			
Connectable conductor cross-section for auxiliary contacts				
• Solid	mm ²	1 x (0.5 ... 4), 2 x (0.5 ... 2.5)		
• Finely stranded with end sleeve	mm ²	1 x (0.5 ... 4), 2 x (0.5 ... 1.5)		
• For AWG cables		1 x (20 ... 12), 2 x (20 ... 14)		
Connectable conductor cross-section for main contacts				
• Solid	mm ²	1 x (0.5 ... 4), 2 x (0.5 ... 2.5)	2 x (1 ... 16), 1 x (1 ... 16)	
• Finely stranded with end sleeve	mm ²	1 x (0.5 ... 4), 2 x (0.5 ... 2.5)	2 x (1 ... 25), 1 x (1 ... 35)	
• Stranded	mm ²	1 x (0.5 ... 4), 2 x (0.5 ... 2.5)	2 x (1 ... 16), 1 x (1 ... 16)	
• For AWG cables		1 x (20 ... 12), 2 x (20 ... 14)	1 x (18 ... 1), 2 x (18 ... 2)	

The SIRIUS 3UG546 DC load monitoring relays monitor a DC load current circuit for undershooting or overshooting of set limit values in 1 or 2 channels. Current, voltage, and power can be monitored separately. When the relays measure the current, they also detect the direction of current and have separate counters for measuring energy consumption and energy recovery.

The devices count the operating cycles and the operating hours of the connected loads as well as the operating cycles of the internal relay. All counters can be monitored for settable limit values and the counter statuses can be reset (with the exception of the operating cycle counter of the internal relay).

The SIRIUS 3UG546 DC load monitoring relays are parameterized exclusively via a PROFINET interface. All measured values and counter values as well as other diagnostics data are transmitted to a controller via PROFINET. The relays can also be operated without PROFINET. If communication fails, the monitoring function continues to be reliably executed. The internal relay, which is switched as a signaling output that responds when a set limit value is undershot or overshoot, responds to detected system faults.

All monitored counter values and measured values can be additionally assigned a warning limit, which generates an alarm via PROFINET when the set value is undershot or overshoot. Violations of the set limit values are also signaled as an alarm via PROFINET.

The devices are supplied via an external 24 V DC voltage source.

The integral counters for operating hours and operating cycles support operators in requirement-oriented plant maintenance. The operating hours counter outputs the time during which a measurable current flows. The properties of the insulation material of the motor windings, for example, deteriorate during operation due to the thermal load. The operating hours serve as an indicator of upcoming maintenance or replacement of machine parts and system components.

The operating cycles counter is incremented by one each time a breaking operation of the monitored load is detected (transition from current flow to no measurable current flow). The number of operating cycles serves as an indicator of upcoming maintenance or replacement of contact blocks. Arcs in breaking operations cause high loads and wear in particular in DC current circuits.

With the closed-circuit principle selected upon application of the control supply voltage

Monitoring for overshooting and undershooting of a measured value including parameterized warning limit/current flow in one direction only/automatic RESET

Monitoring for overshooting of a measured value including parameterized warning limit/manual RESET

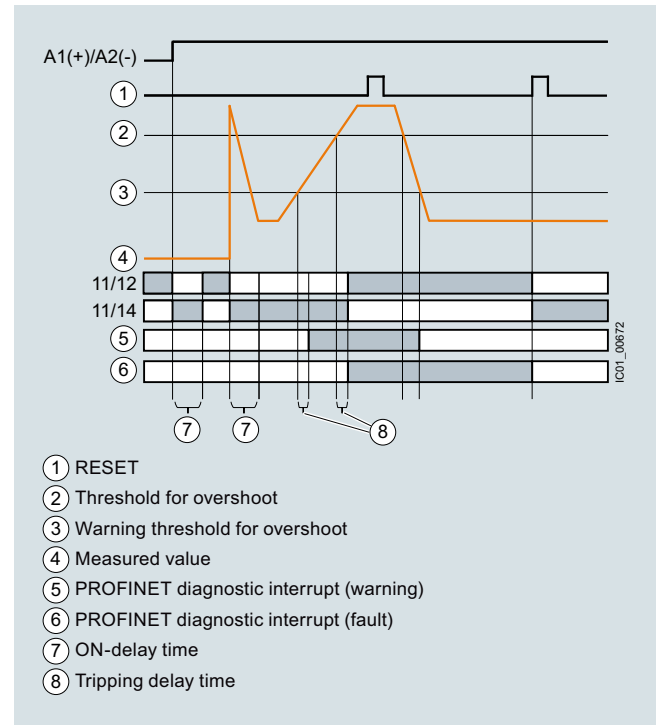
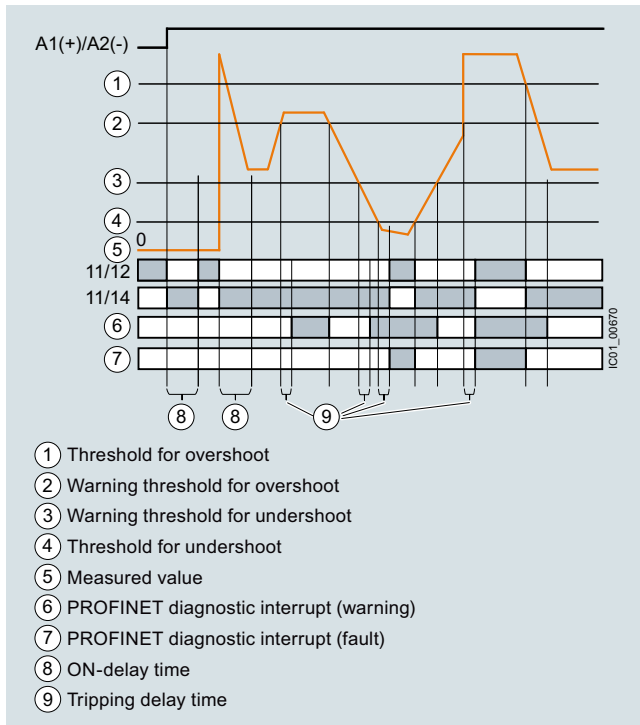

Monitoring for overshooting and undershooting of a measured value including parameterized warning limit/current flow in both directions (energy consumption and energy recovery)/ automatic RESET

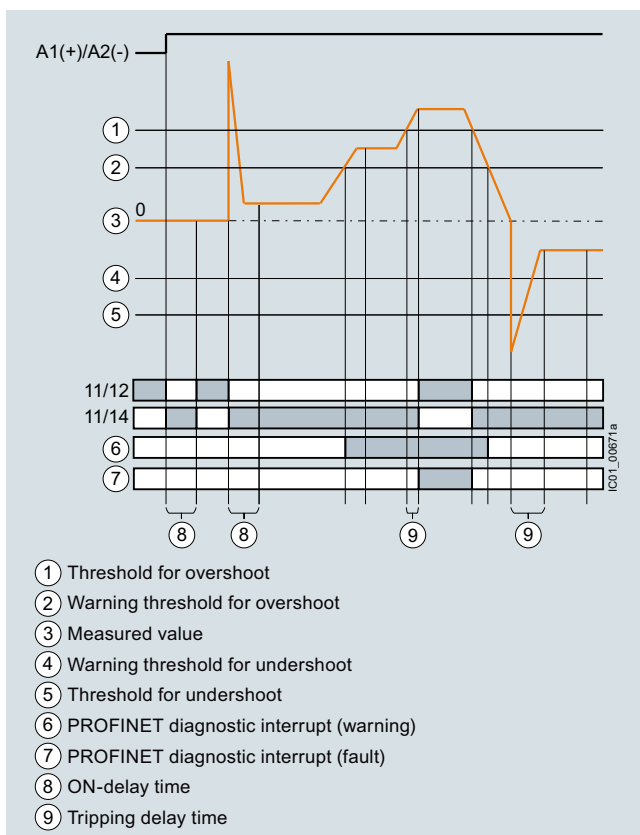

Monitoring and control devices

Relays

SIRIUS 3UG5 monitoring relays for stand-alone installation

DC load monitoring

Selection and ordering data



3UG5461-1AA40



3UG5462-1AA40

Measurable voltage	Measurable current	Width	SD	Screw terminals	⊕	PU (UNIT, SET, M)	PS*	PG
V	A	mm	d	Article No.	Price per PU			
DC load monitoring relay								
0 ... 800	2 x 8/1 x 16	22.5	20	3UG5461-1AA40		1	1 unit	41H
	1 x 63	45	20	3UG5462-1AA40		1	1 unit	41H
0 ... 60	2 x 8/1 x 16	22.5	20	3UG5461-1AA41		1	1 unit	41H
	1 x 63	45	20	3UG5462-1AA41		1	1 unit	41H

Accessories

Version	SD	Article No.	Price per PU	PU (UNIT, SET, M)	PS*	PG
	d					

Terminals for SIRIUS devices in the industrial standard mounting rail enclosure



3ZY1122-1BA00

Removable terminals

- 2-pole, up to 1 x 4 mm² or 2 x 2.5 mm²

Screw terminals



2 **3ZY1122-1BA00**

1 6 units 41L

Accessories for enclosures



3ZY1311-0AA00

Push-in lugs

For wall mounting

2 **3ZY1311-0AA00**

1 10 units 41L



3ZY1440-1AA00

Coding pins

For removable terminals of SIRIUS devices in the industrial standard mounting rail enclosure; enable the mechanical coding of terminals

2 **3ZY1440-1AA00**

1 12 units 41L



3ZY1450-1AB00

Hinged cover

Replacement cover, without terminal labeling, titanium gray

- 22.5 mm wide

2 **3ZY1450-1AB00**

1 5 units 41L

Blank labels

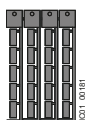

3RT2900-1SB20

Unit labeling plates¹⁾

For SIRIUS devices

- 20 mm x 7 mm, titanium gray

20 **3RT2900-1SB20**

100 340 units 41B

Tools for opening spring-loaded terminals



3RA2908-1A

Screwdrivers

For all SIRIUS devices with spring-loaded terminals

Length approx. 200 mm,
3.0 mm x 0.5 mm,
titanium gray/black,
partially insulated

Spring-loaded terminals (push-in)



2 **3RA2908-1A**

1 1 unit 41B

¹⁾ PC labeling system for individual inscription of unit labeling plates available from: murrplastik Systemtechnik GmbH, see page 16/16.

Overview



SIRIUS 3UG4 monitoring relay

More information

Homepage, see www.siemens.com/sirius-monitoring-relays

Industry Mall, see www.siemens.com/product?3UG45

Conversion tool, see www.siemens.com/conversion-tool

The field-proven SIRIUS monitoring relays for electrical and mechanical variables enable constant monitoring of all important characteristic quantities that provide information about the functional capability of a plant. Both sudden disturbances and gradual changes, which may indicate the need for maintenance, are detected. Thanks to their relay outputs, the monitoring relays permit direct disconnection of the affected system components as well as alerting (e.g. by switching a warning lamp).

Thanks to adjustable delay times the monitoring relays can respond very flexibly to brief faults such as voltage dips or load changes. This avoids unnecessary alarms and disconnections while enhancing plant availability.

The individual 3UG4 monitoring relays offer the following functions in various combinations:

- Undershooting and/or overshooting of liquid levels
- Phase sequence
- Phase failure, neutral conductor failure
- Phase asymmetry
- Undershooting and/or overshooting of limit values for voltage
- Undershooting and/or overshooting of limit values for current
- Undershooting and/or overshooting of limit values for power factor
- Monitoring of the active current or the apparent current
- Monitoring of the residual current
- Monitoring of the insulation resistance
- Undershooting and/or overshooting of limit values for speed

Article No. scheme

Product versions	Article number
Monitoring relays	3UG4 <input type="checkbox"/> <input type="checkbox"/> <input type="checkbox"/> - <input type="checkbox"/> <input type="checkbox"/> <input type="checkbox"/> <input type="checkbox"/> <input type="checkbox"/> 0
Type of setting	e.g. 5 = analogically adjustable <input type="checkbox"/>
Functions	e.g. 11 = line monitoring <input type="checkbox"/> <input type="checkbox"/>
Connection type	Screw terminals 1
	Spring-loaded terminals 2
Contacts	e.g. A = 1 CO contact <input type="checkbox"/>
Supply voltage	e.g. N2 = 160 ... 260 V AC <input type="checkbox"/> <input type="checkbox"/>
Example	3UG4 5 1 1 - 1 A N 2 0

Note:

The Article No. scheme shows an overview of product versions for better understanding of the logic behind the article numbers.

For your orders, please use the article numbers quoted in the selection and ordering data.

Monitoring and control devices

Relays

SIRIUS 3UG45, 3UG46 monitoring relays for stand-alone installation

General data

Benefits

- Customary screw and spring-loaded terminals for quick and reliable wiring
- Fast commissioning thanks to menu-guided parameterization and actual value display for limit value determination
- Reduced space requirement in the control cabinet thanks to a consistent width of 22.5 mm
- Parameterizable monitoring functions, delay times, RESET response, etc.
- Reduced stockkeeping thanks to minimized variance and large measuring ranges
- Wide-voltage power supply units for global applicability
- Device replacement without renewed wiring thanks to removable terminals
- Reliable system diagnostics thanks to actual value display and connectable fault storage
- Rapid diagnostics thanks to unambiguous fault messages on the display

Application

The SIRIUS 3UG4 monitoring relays monitor the most diverse electrical and mechanical quantities in the feeder, and provide reliable protection against damage in the plant. For this purpose, they offer freely parameterizable limit values and diverse options for adapting to the respective task, and in the event of a fault, they provide clear diagnostics information.

The digitally adjustable products also display the current measured values direct on the device. This not only facilitates the display of valuable plant status information during operation, it also enables adjustment of the monitored limit values in accordance with the actual conditions.

The positive result: More selective avoidance of production faults – sustained increases in availability and productivity.

The 3UG4 monitoring relays are available for the following applications:

- Line and 1-phase voltage monitoring
- 1-phase current monitoring or power factor and active current monitoring
- Residual-current monitoring
- Insulation monitoring
- Level monitoring
- Speed monitoring

Technical specifications

More information

Technical specifications, see <https://support.industry.siemens.com/cs/ww/en/ps/16367/td>
Equipment Manual and internal circuit diagrams, see <https://support.industry.siemens.com/cs/ww/en/view/54397927>

FAQs, see <https://support.industry.siemens.com/cs/ww/en/ps/16367/faq>

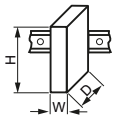
Type	3UG		
General data			
Dimensions (W x H x D)			
• For 2 terminal blocks		mm	22.5 x 83 x 91
- Screw terminals		mm	22.5 x 84 x 91
- Spring-loaded terminals			
• For 3 terminal blocks		mm	22.5 x 92 x 91
- Screw terminals		mm	22.5 x 94 x 91
- Spring-loaded terminals			
• For 4 terminal blocks	mm	22.5 x 103 x 91	
- Screw terminals	mm	22.5 x 103 x 91	
- Spring-loaded terminals			
Permissible ambient temperature			
• During operation	°C	-25 ... +60	
Connection type			
Screw terminals			
• Terminal screw		M3 (for standard screwdriver, size 2 and Pozidriv 2)	
• Solid	mm ²	1 x (0.5 ... 4)/2 x (0.5 ... 2.5)	
• Finely stranded with end sleeve	mm ²	1 x (0.5 ... 2.5)/2 x (0.5 ... 1.5)	
• AWG cables, solid or stranded	AWG	2 x (20 ... 14)	
Spring-loaded terminals			
• Solid	mm ²	2 x (0.25 ... 1.5)	
• Finely stranded, with end sleeve acc. to DIN 46228	mm ²	2 x (0.25 ... 1.5)	
• Finely stranded	mm ²	2 x (0.25 ... 1.5)	
• AWG cables, solid or stranded	AWG	2 x (24 ... 16)	

Overview



SIRIUS 3UG4616 monitoring relay

Electronic line monitoring relays provide maximum protection for mobile machines and plants or for unstable networks. Network and voltage faults can thus be detected early and rectified before far greater damage ensues.

Depending on the version, the relays monitor phase sequence, phase failure with and without N conductor monitoring, phase asymmetry, undervoltage or overvoltage.

Phase asymmetry is evaluated as the difference between the greatest and the smallest phase voltage relative to the greatest phase voltage. Undervoltage or overvoltage exists when at least one phase voltage deviates by 20% from the set rated system voltage or the directly set limit values are overshoot or undershot. The rms value of the voltage is measured.

With the 3UG4617 or 3UG4618 relay, a wrong direction of rotation can also be corrected automatically.

Benefits

- Can be used without auxiliary voltage in any network from 160 to 630 V AC worldwide thanks to wide voltage range
- Variably adjustable to overshoot, undershoot or range monitoring
- Freely configurable delay times and RESET response
- Width 22.5 mm
- Permanent display of actual value and line fault type on the digital versions
- Automatic correction of the direction of rotation by distinguishing between power system faults and wrong phase sequence
- All versions with removable terminals
- All versions with screw or spring-loaded terminals

Application

The relays are used above all for mobile equipment, e.g. air conditioning compressors, refrigerating containers, building site compressors and cranes.

Function	Application
Phase sequence	<ul style="list-style-type: none"> • Direction of rotation of the drive
Phase failure	<ul style="list-style-type: none"> • A fuse has tripped • Failure of the control supply voltage • Broken cable
Phase asymmetry	<ul style="list-style-type: none"> • Overheating of the motor due to asymmetrical voltage • Detection of asymmetrically loaded networks
Undervoltage	<ul style="list-style-type: none"> • Increased current on a motor with corresponding overheating • Unintentional resetting of a device • Network collapse, particularly with battery power
Overtvoltage	<ul style="list-style-type: none"> • Protection of a plant against destruction due to overvoltage

Technical specifications

3UG4511 monitoring relays

The 3UG4511 phase sequenced relay monitors the phase sequence in a 3-phase network. No adjustments are required for operation. The device has an internal power supply and works using the closed-circuit principle. If the phase sequence at the terminals L1-L2-L3 is correct, the output relay picks up after the delay time has elapsed and the green LED is lit. If the phase sequence is wrong, the output relay remains in its rest position.

Note:

When one phase fails, connected loads (motor windings, lamps, transformers, coils, etc.) create a feedback voltage at the terminal of the failed phase due to the network coupling. Because the 3UG4511 relays are not resistant to voltage feedback, such a phase failure is not detected. Should this be required, then the 3UG4512 monitoring relay must be used.

Correct phase sequence

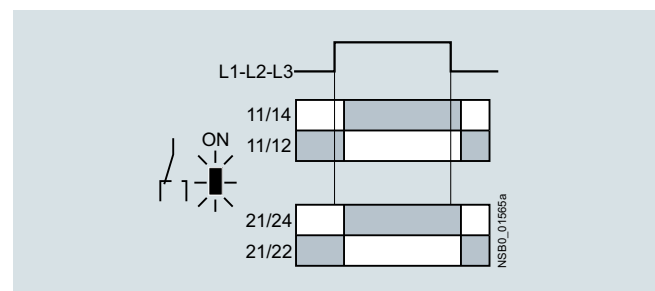

Wrong phase sequence

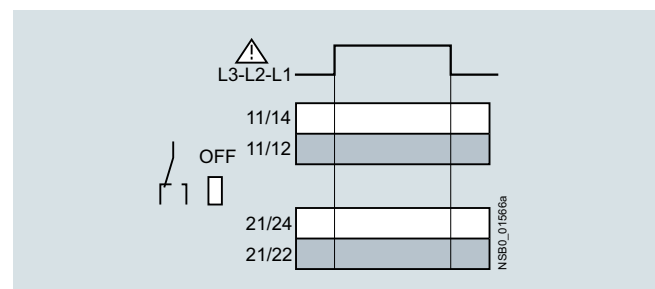

Monitoring and control devices

Relays

SIRIUS 3UG45, 3UG46 monitoring relays for stand-alone installation

Line monitoring

3UG4512 monitoring relays

The 3UG4512 line monitoring relay monitors 3-phase networks with regard to phase sequence, phase failure and phase asymmetry of 10%. Thanks to a special measuring method, a phase failure is reliably detected in spite of the wide voltage range from 160 to 690 V AC and feedback through the load of up to 90%. The device has an internal power supply and works using the closed-circuit principle. No adjustments are required. If the line voltage is switched on, the green LED will light up. If the phase sequence at the terminals L1-L2-L3 is correct, the output relay picks up. If the phase sequence is wrong, the red LED flashes and the output relay remains in its rest position. If a phase fails, the red LED is permanently lit and the output relay drops.

Note:

The red LED is a fault diagnostic indicator and does not show the current relay status. The 3UG4512 monitoring relay is suitable for line frequencies of 50/60 Hz.

Phase failure

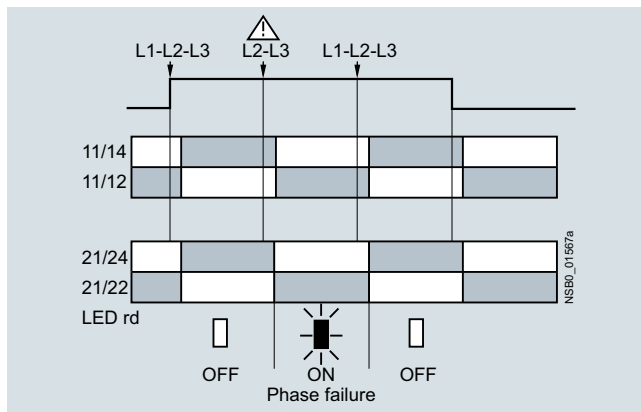

Wrong phase sequence

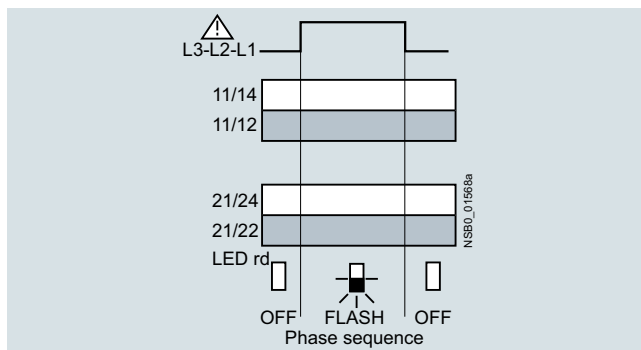

3UG4513 monitoring relays

The 3UG4513 line monitoring relay monitors 3-phase networks with regard to phase sequence, phase failure, phase asymmetry and undervoltage of 20%. The device has an internal power supply and works using the closed-circuit principle. The hysteresis is 5%. The integrated response delay time T is adjustable from 0 to 20 s and responds to undervoltage. If the direction is incorrect, the device switches off immediately. Thanks to a special measuring method, a phase failure is reliably detected in spite of the wide voltage range from 160 to 690 V AC and feedback through the load of up to 80%. If the line voltage is switched on, the green LED will light up. If the phase sequence at the terminals L1-L2-L3 is correct, the output relay picks up. If the phase sequence is wrong, the red LED flashes and the output relay remains in its rest position. If a phase fails, the red LED is permanently lit and the output relay drops.

Note:

The red LED is a fault diagnostic indicator and does not show the current relay status. The 3UG4513 monitoring relay is suitable for line frequencies of 50/60 Hz.

Phase failure and undervoltage

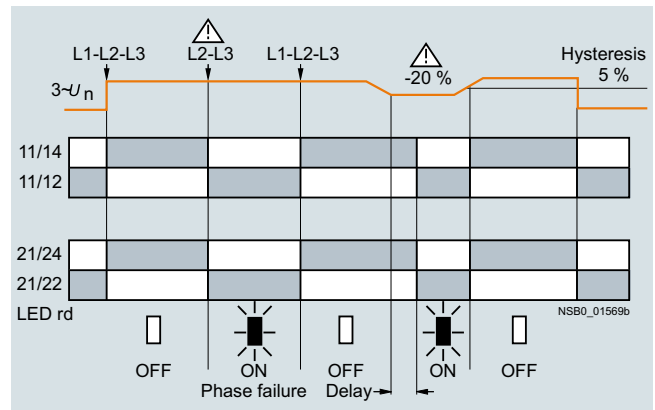

Wrong phase sequence

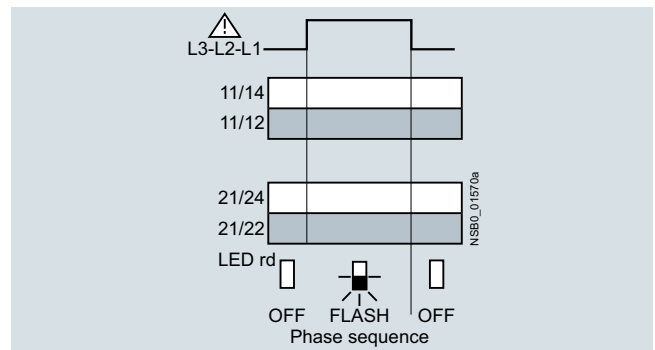

3UG4614 monitoring relays

The 3UG4614 line monitoring relay has a wide voltage range input and an internal power supply. The device is equipped with a display and is parameterized using three buttons. The unit monitors 3-phase networks with regard to phase asymmetry from 5 to 20%, phase failure, undervoltage and phase sequence. The hysteresis is adjustable from 1 to 20 V. In addition the device has a response delay and ON-delay from 0 to 20 s in each case. The response delay time responds to phase asymmetry and undervoltage. If the direction is incorrect, the device switches off immediately. Thanks to a special measuring method, a phase failure is reliably detected in spite of the wide voltage range from 160 to 690 V AC and feedback through the load of up to 80%.

The 3UG4614 monitoring relay can be operated on the basis of either the open-circuit or closed-circuit principle and with Manual or Auto RESET.

With the closed-circuit principle selected

Wrong phase sequence

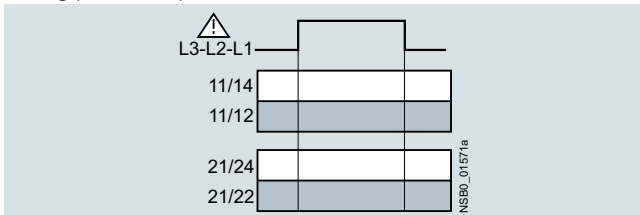

Phase failure

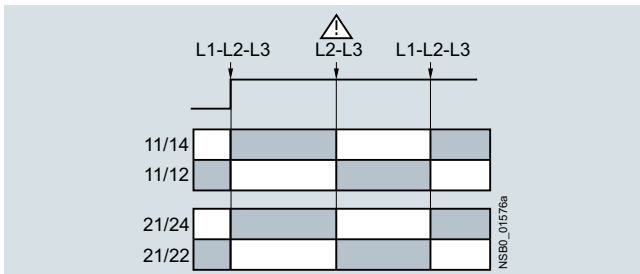

Undervoltage

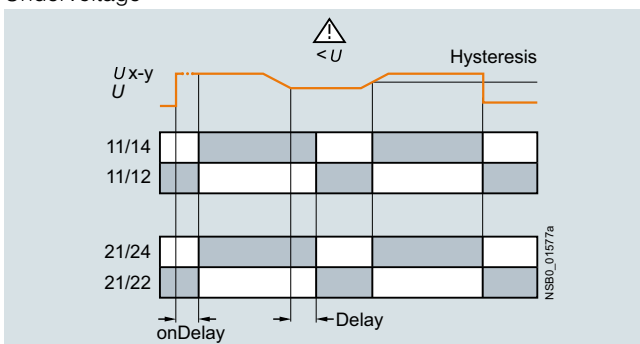

Asymmetry

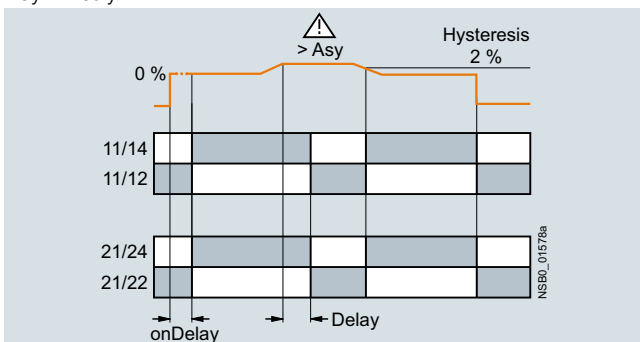
**3UG4615/3UG4616 monitoring relays**

The 3UG4615/3UG4616 line monitoring relay has a wide voltage range input and an internal power supply. The device is equipped with a display and is parameterized using three buttons. The 3UG4615 device monitors 3-phase networks with regard to phase failure, undervoltage, overvoltage and phase sequence. The 3UG4616 monitoring relay monitors the neutral conductor as well. The hysteresis is adjustable from 1 to 20 V. In addition the device has two separately adjustable delay times for overvoltage and undervoltage from 0 to 20 s in each case. If the direction of rotation is incorrect, the device switches off immediately. Thanks to a special measuring method, a phase failure is reliably detected in spite of the wide voltage range from 160 to 690 V AC and feedback through the load of up to 80%.

The 3UG4615/3UG4616 monitoring relay can be operated on the basis of either the open-circuit or closed-circuit principle and with Manual or Auto RESET.

With the closed-circuit principle selected

Wrong phase sequence

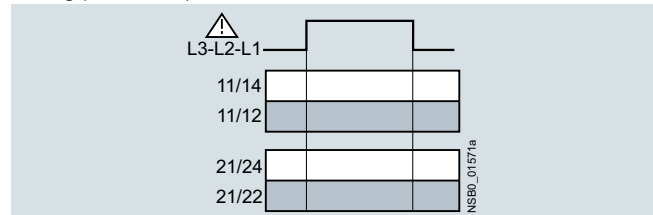

Phase failure

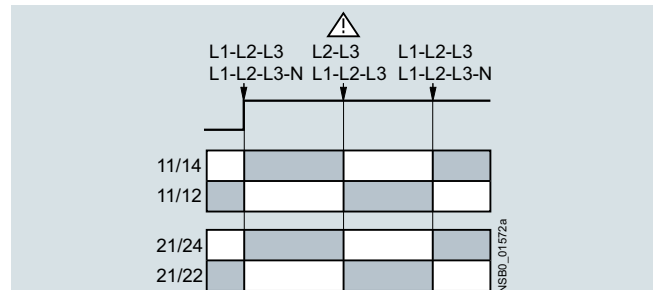

Undervoltage

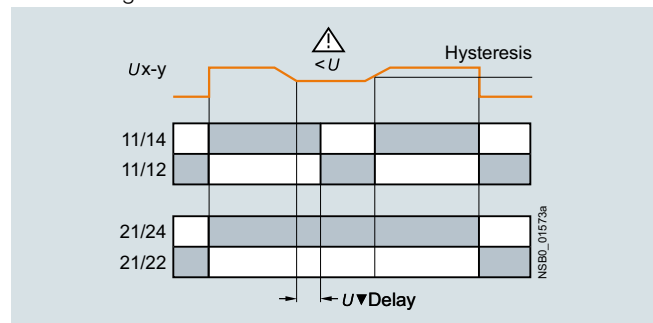

Overvoltage

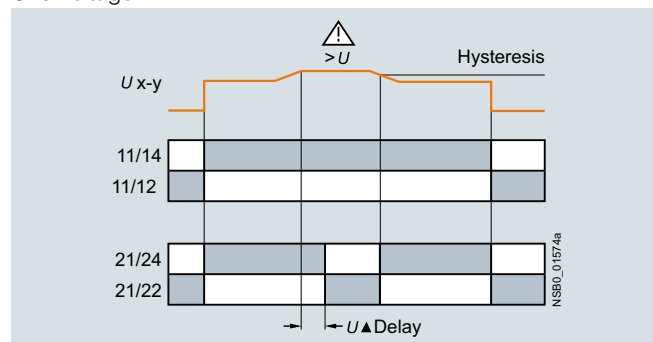

Monitoring and control devices

Relays

SIRIUS 3UG45, 3UG46 monitoring relays for stand-alone installation

Line monitoring

3UG4617/3UG4618 monitoring relays

The 3UG4617/3UG4618 line monitoring relay has an internal power supply and can automatically correct a wrong direction of rotation. Thanks to a special measuring method, a phase failure is reliably detected in spite of the wide voltage range from 160 to 690 V AC and feedback through the load of up to 80%. The device is equipped with a display and is parameterized using three buttons. The 3UG4617 line monitoring relay unit monitors 3-phase networks with regard to phase sequence, phase failure, phase asymmetry, undervoltage and overvoltage. The 3UG4618 monitoring relay monitors the neutral conductor as well. The hysteresis is adjustable from 1 to 20 V. In addition the device has delay times from 0 to 20 s in each case for overvoltage, undervoltage, phase failure and phase asymmetry. The 3UG4617/3UG4618 monitoring relay can be operated on the basis of either the open-circuit or closed-circuit principle and with Manual or Auto RESET. The one changeover contact is used for warning or disconnection in the event of power system faults (voltage, asymmetry), the other responds only to a wrong phase sequence. In conjunction with a contactor reversing assembly it is thus possible to change the direction automatically.

With the closed-circuit principle selected

Phase failure

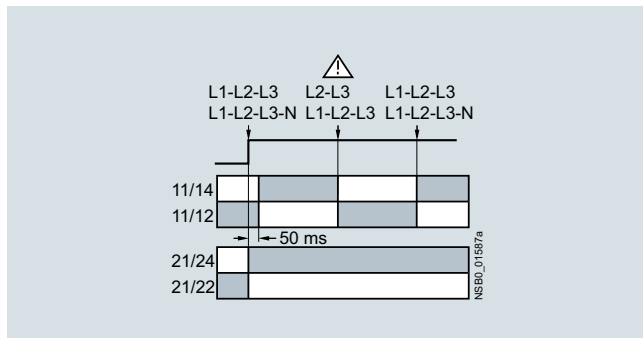

Undervoltage

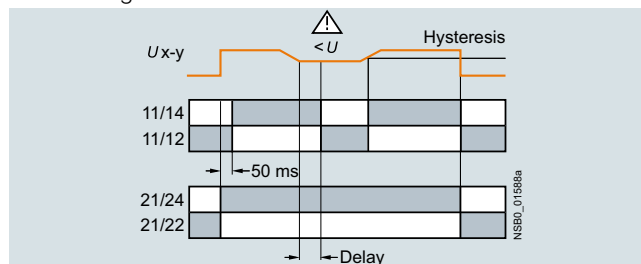

Overvoltage

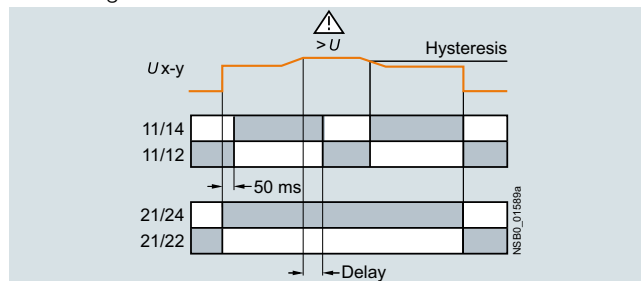

Asymmetry

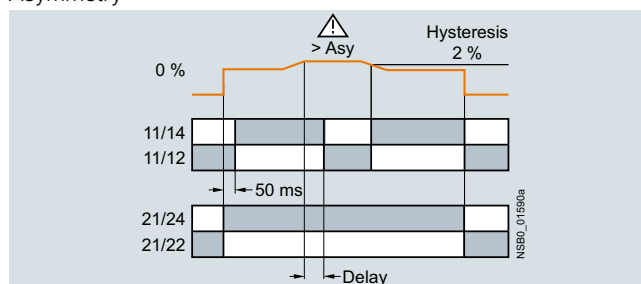

Type	3UG4511 ... 3UG4513, 3UG4614 ... 3UG4618	
General data		
Rated insulation voltage U_i	V	690
Pollution degree 3 Overvoltage category III acc. to VDE 0110		
Rated impulse withstand voltage U_{imp}	kV	6
Control circuit		
Load capacity of the output relay		
• Thermal current I_{th}	A	5
Rated operational current I_e at		
• AC-15/24 ... 400 V	A	3
• DC-13/24 V	A	1
• DC-13/125 V	A	0.2
• DC-13/250 V	A	0.1
Minimum contact load at 17 V DC	mA	5
Electrical endurance AC-15	million operating cycles	0.1
Mechanical service life	million operating cycles	10

Selection and ordering data

PU (UNIT, SET, M) = 1
 PS* = 1 unit
 PG = 41H



3UG4511-1AP20



3UG4615-1CR20



3UG4616-1CR20



3UG4617-1CR20



3UG4618-1CR20



3UG4511-2BP20



3UG4512-2BR20

Adjustable hysteresis	Under-voltage detection	Over-voltage detection	Stabilization time adjustable stDEL	Tripping delay time adjustable Del	Version of auxiliary contacts	Measurable line voltage ¹⁾	SD	Screw terminals	SD	Spring-loaded terminals	
			s	s	CO contact	V	d	Article No.	Price per PU	Article No.	Price per PU

Monitoring of phase sequence

Auto RESET

--	--	--	--	--	1	160 ... 260 AC	2	3UG4511-1AN20	5	3UG4511-2AN20	
					2		2	3UG4511-1BN20	5	3UG4511-2BN20	
					1	320 ... 500 AC	2	3UG4511-1AP20	2	3UG4511-2AP20	
					2		2	3UG4511-1BP20	2	3UG4511-2BP20	
					1	420 ... 690 AC	2	3UG4511-1AQ20	5	3UG4511-2AQ20	
					2		2	3UG4511-1BQ20	5	3UG4511-2BQ20	

Monitoring of phase sequence, phase failure and phase asymmetry

Auto RESET, closed-circuit principle, asymmetry threshold permanently 10%

--	--	--	--	--	1	160 ... 690 AC	2	3UG4512-1AR20	2	3UG4512-2AR20	
					2		2	3UG4512-1BR20	2	3UG4512-2BR20	

Monitoring of phase sequence, phase failure, asymmetry and undervoltage

Analogically adjustable, Auto RESET, closed-circuit principle, asymmetry and undervoltage threshold permanently 20%

5% of set value	✓	--	--	0.1 ... 20	2	160 ... 690 AC	2	3UG4513-1BR20	2	3UG4513-2BR20	
-----------------	---	----	----	------------	---	----------------	---	----------------------	---	----------------------	--

Digitally adjustable, Auto RESET or Manual RESET, open-circuit or closed-circuit principle, asymmetry threshold 0 or 5 ... 20%

Adjustable	✓	--	0.1 ... 20	0.1 ... 20	2	160 ... 690 AC	2	3UG4614-1BR20	2	3UG4614-2BR20	
------------	---	----	------------	------------	---	----------------	---	----------------------	---	----------------------	--

Monitoring of phase sequence, phase failure, overvoltage and undervoltage

Digitally adjustable, Auto RESET or Manual RESET, open-circuit or closed-circuit principle

Adjustable	✓	✓	--	0.1 ... 20 ²⁾	2 ²⁾	160 ... 690 AC	2	3UG4615-1CR20	2	3UG4615-2CR20	
------------	---	---	----	--------------------------	-----------------	----------------	---	----------------------	---	----------------------	--

Monitoring of phase sequence, phase and N conductor failure, overvoltage and undervoltage

Digitally adjustable, Auto RESET or Manual RESET, open-circuit or closed-circuit principle

Adjustable	✓	✓	--	0.1 ... 20 ²⁾	2 ²⁾	90 ... 400 AC against N	2	3UG4616-1CR20	2	3UG4616-2CR20	
------------	---	---	----	--------------------------	-----------------	-------------------------	---	----------------------	---	----------------------	--

Automatic correction of the direction of rotation in case of wrong phase sequence, phase failure, asymmetry, overvoltage and undervoltage

Digitally adjustable, Auto RESET or Manual RESET, open-circuit or closed-circuit principle, asymmetry threshold 0 or 5 ... 20%

Adjustable	✓	✓	--	0.1 ... 20	2 ³⁾	160 ... 690 AC	2	3UG4617-1CR20	2	3UG4617-2CR20	
------------	---	---	----	------------	-----------------	----------------	---	----------------------	---	----------------------	--

Automatic correction of the direction of rotation in case of wrong phase sequence, phase and N conductor failure, phase asymmetry, overvoltage and undervoltage

Digitally adjustable, Auto RESET or Manual RESET, open-circuit or closed-circuit principle, asymmetry threshold 0 or 5 ... 20%

Adjustable	✓	✓	--	0.1 ... 20	2 ³⁾	90 ... 400 AC against N	2	3UG4618-1CR20	2	3UG4618-2CR20	
------------	---	---	----	------------	-----------------	-------------------------	---	----------------------	---	----------------------	--

- ✓ Function available
 -- Function not available

For accessories, see page 10/99.

¹⁾ Absolute limit values.

²⁾ 1 CO contact each and one tripping delay time each for U_{min} and U_{max} .

³⁾ 1 CO contact each for power system fault and phase sequence correction.

Monitoring and control devices

Relays

SIRIUS 3UG45, 3UG46 monitoring relays for stand-alone installation

Voltage monitoring

Overview



SIRIUS 3UG4631 monitoring relay

The relays monitor 1-phase AC voltages (rms value) and DC voltages against the set threshold value for overshoot and undershoot. The devices differ with regard to their power supply (internal or external).

Benefits

- Versions with wide voltage supply range
- Variably adjustable to overshoot, undershoot or range monitoring
- Freely configurable delay times and RESET response
- Width 22.5 mm
- Display of actual value and status messages
- All versions with removable terminals
- All versions with screw or spring-loaded terminals

Application

- Protection of a plant against destruction due to overvoltage
- Switch-on of a plant at a defined voltage and higher
- Protection from undervoltage due to overloaded supply voltages, particularly with battery power
- Threshold switch for analog signals from 0.1 to 10 V

Technical specifications

3UG4631/3UG4632 monitoring relays

The 3UG4631/3UG4632 voltage monitoring relay is supplied with an auxiliary voltage of 24 V AC/DC or 24 to 240 V AC/DC and performs overshoot, undershoot or range monitoring of the voltage depending on parameterization. The device is equipped with a display and is parameterized using three buttons.

The measuring range extends from 0.1 to 60 V or 10 to 600 V AC/DC. The threshold values for overshoot or undershoot can be freely configured within this range. If one of these threshold values is reached, the output relay responds according to the set principle of operation as soon as the delay time has elapsed. This delay time U_{Del} can be set from 0.1 to 20 s. The hysteresis can be set from 0.1 to 30 V or 0.1 to 300 V. The device can be operated on the basis of either the open-circuit or closed-circuit principle and with Manual or Auto RESET. One output changeover contact is available as signaling contact.

With the closed-circuit principle selected

Overvoltage

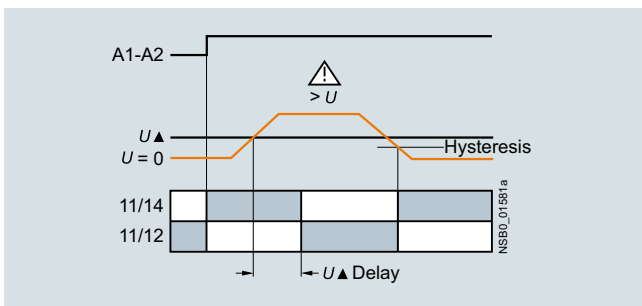

Undervoltage

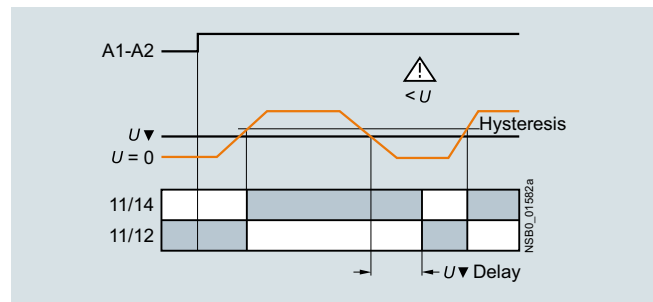

Range monitoring

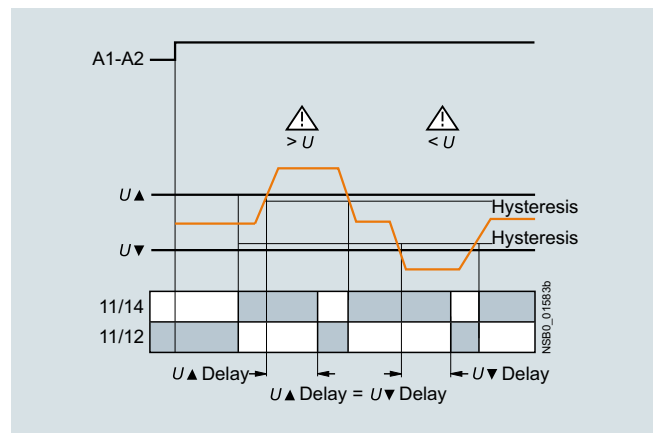

3UG4633 monitoring relay

The 3UG4633 voltage monitoring relay has an internal power supply and performs overshoot, undershoot or range monitoring of the voltage depending on parameterization. The device is equipped with a display and is parameterized using three buttons.

The operating and measuring range extends from 17 to 275 V AC/DC. The threshold values for overshoot or undershoot can be freely configured within this range. If one of these threshold values is reached, the output relay responds according to the set principle of operation as soon as the tripping delay time has elapsed. This delay time U_{Del} can also be adjusted, just like the ON-delay time $onDel$ from 0.1 to 20 s.

The hysteresis is adjustable from 0.1 to 150 V. The device can be operated on the basis of either the open-circuit or closed-circuit principle and with Manual or Auto RESET. One output changeover contact is available as signaling contact.

With the closed-circuit principle selected

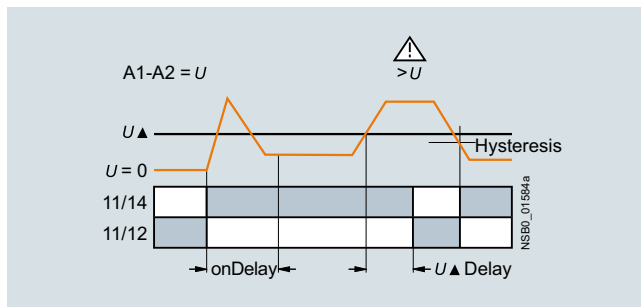
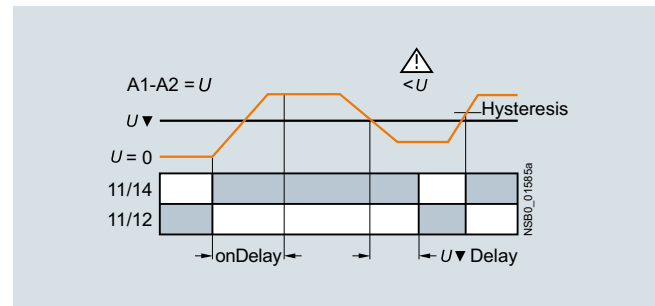
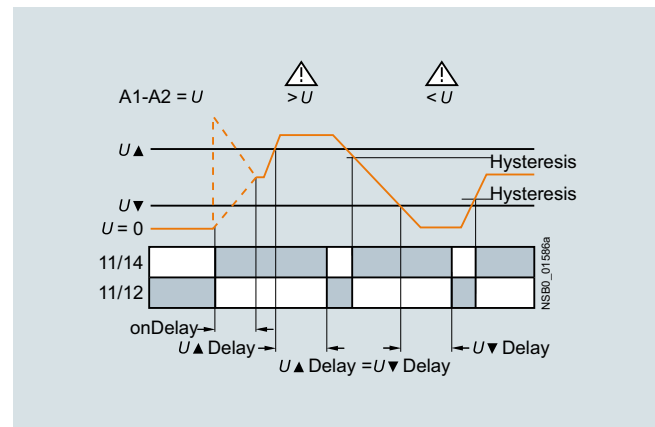
Overvoltage**Undervoltage****Range monitoring**

Type		3UG4631	3UG4632	3UG4633
General data				
Rated insulation voltage U_i	V	690		
Pollution degree 3 Overvoltage category III acc. to VDE 0110				
Rated impulse withstand voltage U_{imp}	kV	6		
Measuring circuit				
Permissible measuring range 1-phase AC/DC voltage	V	0.1 ... 60	10 ... 650	17 ... 275
Measuring frequency	Hz	40 ... 500		
Setting range 1-phase voltage	V	0.1 ... 60	10 ... 600	17 ... 275
Control circuit				
Load capacity of the output relay				
• Thermal current I_{th}	A	5		
Rated operational current I_e at				
• AC-15/24 ... 400 V	A	3		
• DC-13/24 V	A	1		
• DC-13/125 V	A	0.2		
• DC-13/250 V	A	0.1		
Minimum contact load at 17 V DC	mA	5		

Monitoring and control devices

Relays

SIRIUS 3UG45, 3UG46 monitoring relays for stand-alone installation

Voltage monitoring

Selection and ordering data

- Digitally adjustable, with illuminated LCD
- Auto or Manual RESET
- Open-circuit or closed-circuit principle
- 1 CO contact



PU (UNIT, SET, M) = 1
 PS* = 1 unit
 PG = 41H



3UG4631-1AA30



3UG4633-2AL30

Measuring range	Adjustable hysteresis	Rated control supply voltage U_s	SD	Screw terminals 	SD	Spring-loaded terminals 		
V	V	V	d	Article No.	Price per PU	d	Article No.	Price per PU
Internal power supply without auxiliary voltage, separately adjustable ON-delay and tripping delay time 0.1 ... 20 s								
17 ... 275 AC/DC	0.1 ... 150	17 ... 275 AC/DC ¹⁾	2	3UG4633-1AL30	2	3UG4633-2AL30		
Externally supplied with auxiliary voltage, tripping delay time adjustable 0.1 ... 20 s								
0.1 ... 60 AC/DC 10 ... 600 AC/DC	0.1 ... 30 0.1 ... 300	24 AC/DC	2 2	3UG4631-1AA30 3UG4632-1AA30	2 5	3UG4631-2AA30 3UG4632-2AA30		
0.1 ... 60 AC/DC 10 ... 600 AC/DC	0.1 ... 30 0.1 ... 300	24 ... 240 AC/DC	2 2	3UG4631-1AW30 3UG4632-1AW30	2 2	3UG4631-2AW30 3UG4632-2AW30		

¹⁾ Absolute limit values.

For accessories, see page 10/99.

Overview



SIRIUS 3UG4622 monitoring relay

The relays monitor 1-phase AC currents (rms value) and DC currents against the set threshold value for overshoot and undershoot. They differ with regard to their measuring ranges and control supply voltage types.

Technical specifications

3UG4621/3UG4622 monitoring relays

The 3UG4621 or 3UG4622 current monitoring relay is supplied with an auxiliary voltage of 24 V AC/DC or 24 to 240 V AC/DC and performs overshoot, undershoot or range monitoring of the current depending on parameterization. The device is equipped with a display and is parameterized using three buttons.

The measuring range extends from 3 to 500 mA or 0.05 to 10 A. The rms value of the current is measured. The threshold values for overshoot or undershoot can be freely configured within this range. If one of these threshold values is reached, the output relay responds according to the set principle of operation as soon as the tripping delay time I_{Del} has elapsed. This time and the ON-delay time $onDel$ are adjustable from 0.1 to 20 s.

The hysteresis is adjustable from 0.1 to 250 mA or 0.01 to 5 A. The device can be operated with Manual or Auto RESET and on the basis of either the open-circuit or closed-circuit principle. You can decide here whether the output relay is to respond when the supply voltage $U_S = ON$ is applied, or not until the lower measuring range limit of the measuring current ($I > 3 \text{ mA}/50 \text{ mA}$) is reached. One output changeover contact is available as signaling contact.

With the closed-circuit principle selected upon application of the control supply voltage

Current overshoot

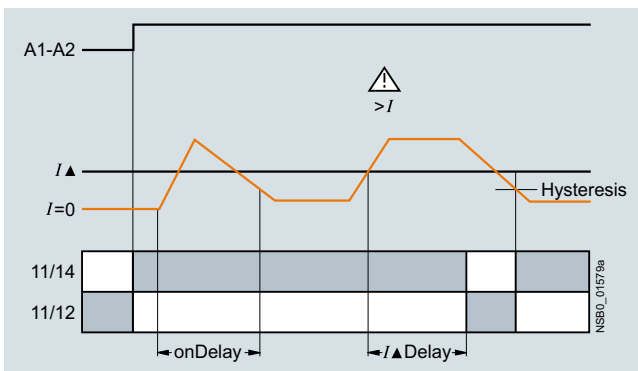

Benefits

- Versions with wide voltage supply range
- Variably adjustable to overshoot, undershoot or range monitoring
- Freely configurable delay times and RESET response
- Width 22.5 mm
- Display of actual value and status messages
- All versions with removable terminals
- All versions with screw or spring-loaded terminals

Application

- Overcurrent and undercurrent monitoring
- Monitoring the functionality of electrical loads
- Open-circuit monitoring
- Threshold switch for analog signals from 4 to 20 mA

Current undershoot

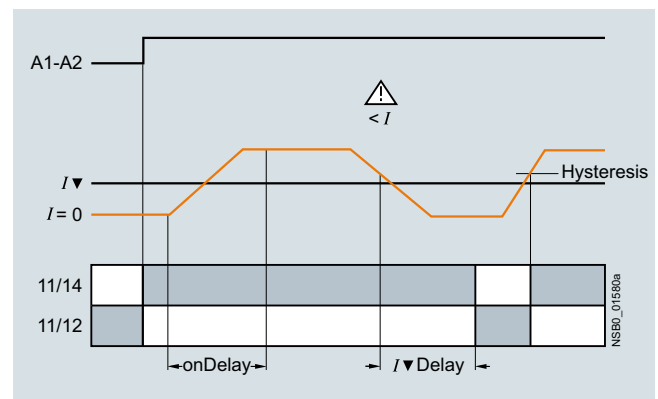

Range monitoring

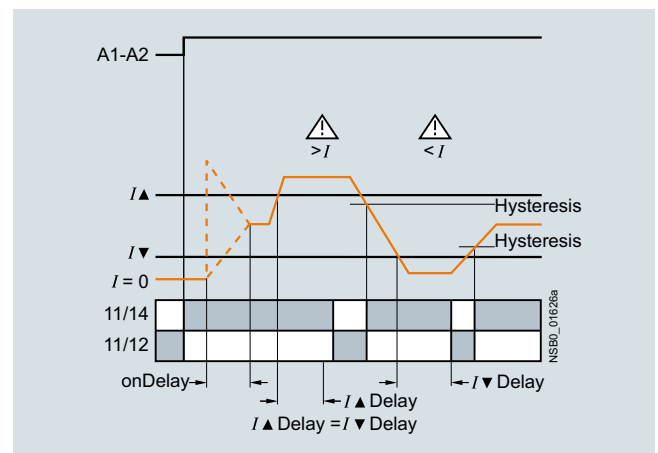

Monitoring and control devices

Relays

SIRIUS 3UG45, 3UG46 monitoring relays for stand-alone installation

Current monitoring

Type		3UG4621-.AA	3UG4621-.AW	3UG4622-.AA	3UG4622-.AW
General data					
Rated insulation voltage U_i Pollution degree 3; overvoltage category III according to VDE 0110	V	690			
Rated impulse withstand voltage U_{imp}	kV	6			
Measuring circuit					
Measuring range for 1-phase AC/DC current	A	0.003 ... 0.6		0.05 ... 15	
Measuring frequency	Hz	40 ... 500			
Setting range for 1-phase current	A	0.003 ... 0.5		0.05 ... 10	
Load supply voltage	V	24	Max. 300 ¹⁾ Max. 500 ²⁾	24	Max. 300 ¹⁾ Max. 500 ²⁾
Control circuit					
Load capacity of the output relay • Thermal current I_{th}	A	5			
Rated operational current I_o at • AC-15/24 ... 400 V • DC-13/24 V • DC-13/125 V • DC-13/250 V	A	3 1 0.2 0.1			
Minimum contact load at 17 V DC	mA	5			

1) With protective separation.

2) With simple separation.

Selection and ordering data

- Digitally adjustable, with illuminated LCD
- Auto or Manual RESET
- Open-circuit or closed-circuit principle
- 1 CO contact

PU (UNIT, SET, M) = 1
PS* = 1 unit
PG = 41H



3UG4621-1AA30



3UG4622-2AW30

Measuring range	Adjustable hysteresis	Rated control supply voltage U_s	SD	Screw terminals		Spring-loaded terminals	
				Article No.	Price per PU	Article No.	Price per PU
Monitoring of undercurrent and overcurrent, startup delay and tripping delay times can be adjusted separately 0.1 ... 20 s							
3 ... 500 mA AC/DC	0.1 ... 250 mA	24 AC/DC ¹⁾	2	3UG4621-1AA30	5	3UG4621-2AA30	
0.05 ... 10 A AC/DC	0.01 ... 5 A		2	3UG4622-1AA30	2	3UG4622-2AA30	
3 ... 500 mA AC/DC	0.1 ... 250 mA	24 ... 240 AC/DC ²⁾	2	3UG4621-1AW30	2	3UG4621-2AW30	
0.05 ... 10 A AC/DC	0.01 ... 5 A		2	3UG4622-1AW30	2	3UG4622-2AW30	

1) No electrical separation. Load supply voltage 24 V.

2) Electrical separation between control circuit and measuring circuit.
Load supply voltage for protective separation max. 300 V, for simple separation max. 500 V.

For accessories, see page 10/99.

For AC currents $I > 10$ A it is possible to use 4NC current transformers as an accessory, see Catalog LV 10.

Overview



SIRIUS 3UG4641 monitoring relay

The 3UG4641 power factor and active current monitoring device enables load monitoring of motors.

Whereas power factor (p.f.) monitoring is used above all for monitoring no-load operation, the active current monitoring option can be used to observe and evaluate the load factor over the entire torque range.

Benefits

- Can be used worldwide thanks to wide voltage range from 90 to 690 V (absolute limit values)
- Monitoring of even small 1-phase motors with a no-load supply current below 0.5 A
- Simple determination of threshold values by directly referencing measured variables to motor loading
- Range monitoring and active current measurement enable detection of cable breaks between control cabinets and motors, as well as phase failures
- Power factor (p.f.) or I_{res} (active current) can be selected as the measurement principle
- Width 22.5 mm
- All versions with removable terminals
- All versions with screw or spring-loaded terminals

Application

- No-load monitoring and load shedding, such as in the event of a V-belt tear
- Underload monitoring in the low-end performance range, e.g. in the event of pump no-load operation
- Monitoring of overload, e.g. due to a dirty filter system
- Simple power factor monitoring in power systems for control of compensation equipment
- Broken cable between control cabinet and motor

Technical specifications

3UG4641 monitoring relays

The 3UG4641 monitoring relay is self-powered and serves the 1-phase monitoring of the power factor or performs overshoot, undershoot or range monitoring of the active current depending on how it is parameterized. The load to be monitored is connected upstream of the IN terminal. The load current flows through the terminals IN and Ly/N. The setting range for the power factor is 0.1 to 0.99 and for the active current I_{res} it is 0.2 to 10 A. If the control supply voltage is switched on and no load current flows, the display will show $I < 0.2$ and a symbol for overshoot, undershoot or range monitoring. If the motor is now switched on and the current exceeds 0.2 A, the set ON-delay time begins. During this time, if the set limit values are undershot or exceeded, this does not lead to a relay reaction of the changeover contact. If the operational flowing active current and/or the power factor value falls below or exceeds the respective set threshold value, the spike delay begins. When this time has expired, the relay changes its switch position. The relevant measured variables for overshooting and undershooting in the display flash. If monitoring for active current undershoot is switched off ($I_{res} \nabla = \text{OFF}$), and if the load current undershoots the lower measuring range threshold (0.2 A), the CO contacts remain unchanged. If a threshold value is set for the monitoring of active current undershooting, then undershooting of the measuring range threshold (0.2 A) will result in a response of the CO contacts.

The relay operates either according to the open-circuit or closed-circuit principle. If the device is set to Auto RESET (Memory = No), depending on the set principle of operation, the switching relay returns to its initial state and the flashing ends when the hysteresis threshold is reached.

If Manual RESET is selected in the menu (Memory = Yes), the switching relay remains in its current switching state and the current measured value and the symbol for undershooting and overshooting continue to flash, even when the measured variable reaches a permissible value again. This stored fault status can be reset by simultaneously pressing the UP▲ and DOWN▼ keys for 2 seconds, or by switching the supply voltage off and back on again.

With the closed-circuit principle selected

Response in the event of undershooting the measuring range limit

- With activated monitoring of $I_{res} \nabla$

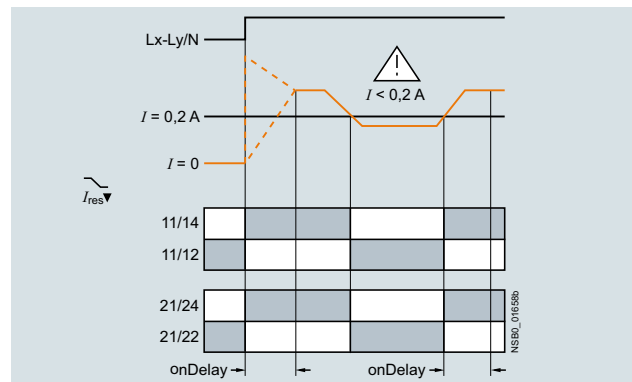

- With deactivated monitoring of active current undershooting

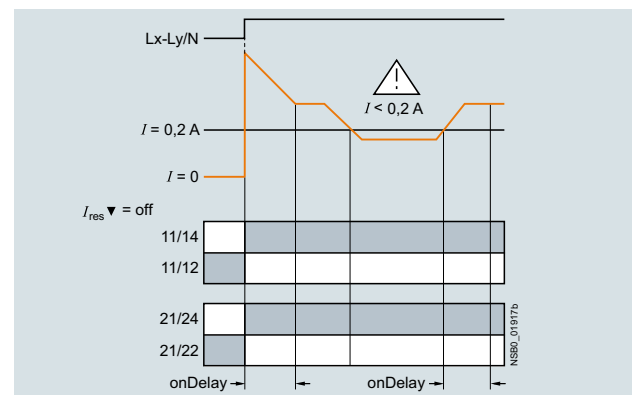

Monitoring and control devices

Relays

SIRIUS 3UG45, 3UG46 monitoring relays for stand-alone installation

Power factor and active current monitoring

Overshooting of active current

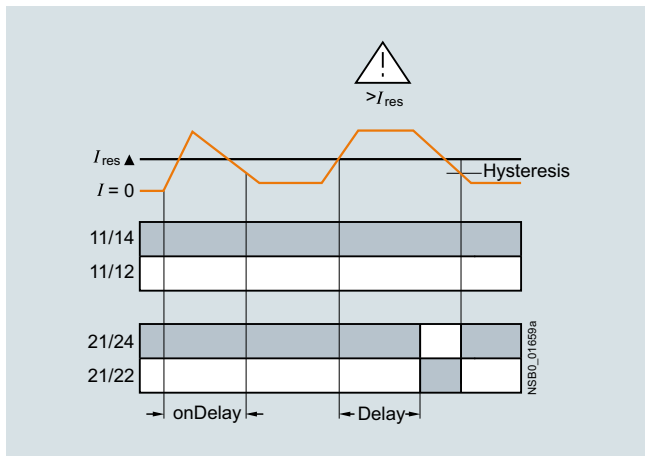

Overshooting of power factor

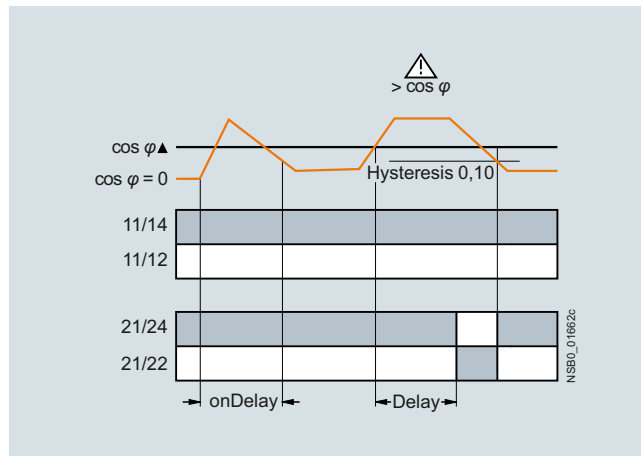

Undershooting of active current

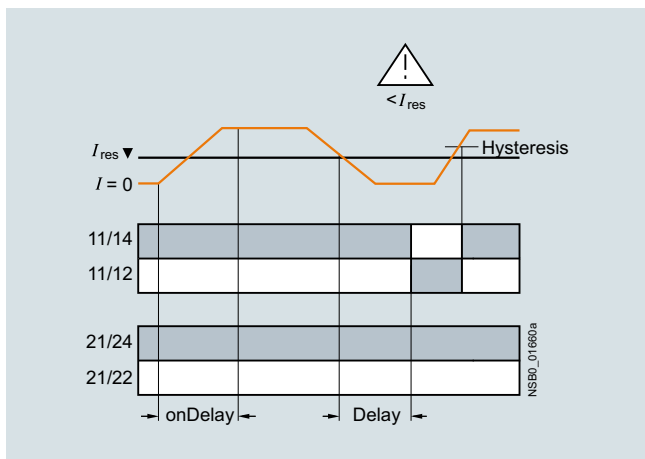

Undershooting of power factor

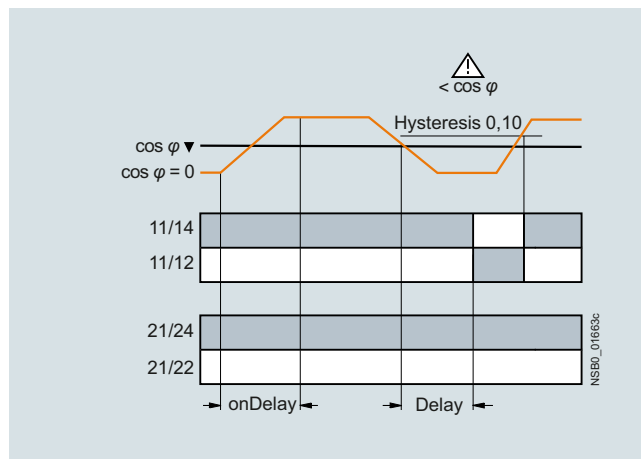

Range monitoring of active current

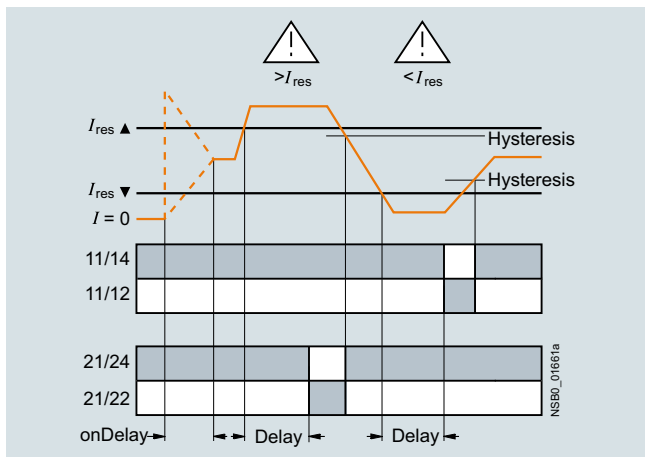

Range monitoring of power factor

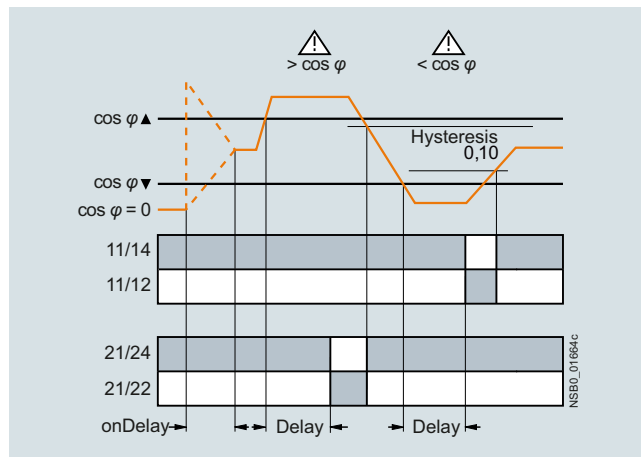



Type	3UG4641	
General data		
Rated insulation voltage U_i Pollution degree 3 Overvoltage category III acc. to VDE 0110	V	690
Rated impulse withstand voltage U_{imp}	kV	6
Control circuit		
Number of CO contacts for auxiliary contacts		2
Load capacity of the output relay		
• Thermal current I_{th}	A	5
Rated operational current I_e at		
• AC-15/24 ... 400 V	A	3
• DC-13/24 V	A	1
• DC-13/125 V	A	0.2
• DC-13/250 V	A	0.1
Minimum contact load at 17 V DC	mA	5

Selection and ordering data

- For monitoring the power factor and the active current I_{res} (p.f. $\times I$)
- Suitable for 1-phase and 3-phase currents
- Digitally adjustable, with illuminated LCD
- Overshoot, undershoot or range monitoring adjustable
- Upper and lower threshold value can be adjusted separately
- Permanent display of actual value and tripping state
- 1 changeover contact each for undershoot/overshoot

PU (UNIT, SET, M) = 1
 PS* = 1 unit
 PG = 41H

Measuring range		Adjustable hysteresis		ON-delay time adjustable onDel	Tripping delay time adjustable I/Δ Del/ I/∇ Del, φ/Δ Del/ φ/∇ Del	Rated control supply voltage U_s ¹⁾ 50/60 Hz AC	SD	Screw terminals 	SD	Spring-loaded terminals 		
For power factor	For active current I_{res}	For power factor	For active current I_{res}									
P.f.	A	P.f.	A	s	s	V	d	Article No.	Price per PU	d	Article No.	Price per PU
0.10 ... 0.99	0.2 ... 10.0	0.1	0.1 ... 2.0	0 ... 99	0.1 ... 20.0	90 ... 690	2	3UG4641-1CS20	5	3UG4641-2CS20		

¹⁾ Absolute limit values.

For accessories, see [page 10/99](#).

For AC active currents $I_{res} > 10$ A it is possible to use 4NC current transformers as an accessory, see [Catalog LV 10](#).

Monitoring and control devices

Relays

SIRIUS 3UG45, 3UG46 monitoring relays for stand-alone installation

Residual-current monitoring > Residual-current monitoring relays

Overview

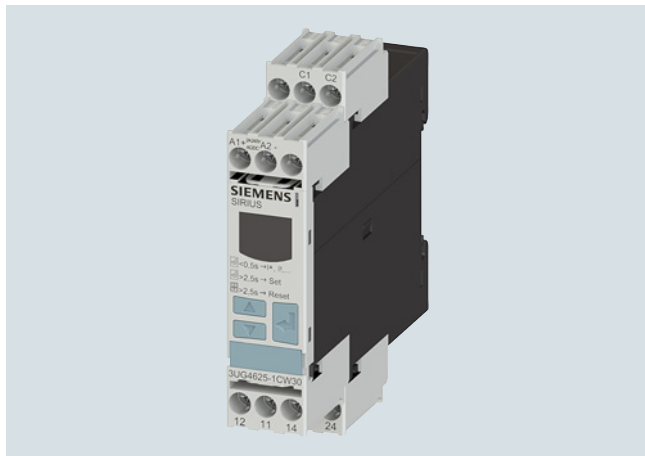

SIRIUS 3UG4625 monitoring relay

The 3UG4625 residual-current monitoring relays are used in conjunction with the 3UL23 residual-current transformers for monitoring plants in which higher residual currents are increasingly expected due to ambient conditions. Monitoring encompasses pure AC residual currents or AC residual currents with a pulsating DC fault current component (transformer type A in accordance with DIN VDE 0100-530/IEC TR 60755).

Benefits

- Worldwide use thanks to wide voltage range from 24 to 240 V AC/DC
- High measuring accuracy of $\pm 7.5\%$
- Permanent self-monitoring
- Variable threshold values for warning and disconnection
- Freely configurable delay times and RESET response
- Permanent display of the actual value and fault diagnostics via the display
- High level of flexibility and space saving through installation of the transformer inside or outside the control cabinet
- Width 22.5 mm
- All versions with removable terminals
- All versions with screw or spring-loaded terminals

Application

Monitoring of plants in which residual currents can occur, e.g. due to dust deposits or moisture, porous cables and leads, or capacitive residual currents.

Technical specifications

3UG4625 monitoring relays

The main conductor, and any neutral conductor to which a load is connected, are routed through the opening of the toroidal core of a residual-current transformer. A secondary winding is placed around this toroidal core to which the monitoring relay is connected.

If operation of a plant is fault-free, the sum of the inflowing and outward currents equals zero. No current is then induced in the secondary winding of the residual-current transformer.

However, if an insulation fault occurs, the sum of the inflowing currents is greater than that of the outward currents. The differential current – i.e. the residual current – induces a secondary current in the secondary winding of the transformer. This current is evaluated in the monitoring relay and is used on the one hand to display the actual residual current and on the other, to switch the relay if the set warning or tripping threshold is overshot.

If the measured residual current exceeds the set warning value, the associated changeover contact instantly changes the switching state and an indication appears on the display.

If the measured residual current exceeds the set tripping value, the set delay time begins and the associated relay symbol flashes. On expiry of this time, the associated changeover contact changes the switching state.

ON-delay time for motor start

To be able to start a drive when a residual current is detected, the output relays switch to the OK state for an adjustable ON-delay time depending on the selected open-circuit or closed-circuit principle.

The changeover contacts do not react if the set threshold values are overshot during this period.

With the closed-circuit principle selected

Residual-current monitoring with Auto RESET (Memory = no)

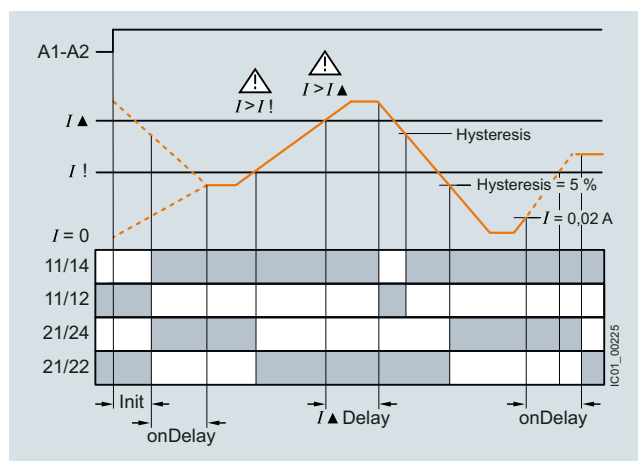

If the device is set to Auto RESET, the relay switches back to the OK state for the tripping value after tripping once the value falls below the set hysteresis threshold and the display stops flashing.

The associated relay changes its switching state if the value falls below the fixed hysteresis value of 5% of the set warning value.

Any overshoots are therefore not stored.

Residual-current monitoring with Manual RESET (Memory = yes)

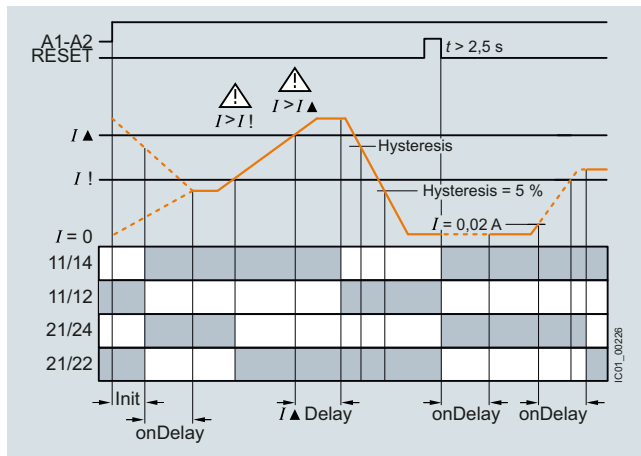

If Manual RESET is selected in the menu, the output relays remain in their current switching state and the current measured value and the symbol for overshooting continue to flash, even when the measured residual current returns to a permissible value. This stored fault status can be reset by simultaneously pressing the UP▲ and DOWN▼ keys for > 2 seconds, or by switching the supply voltage off and back on again.

Note:

Do not ground the neutral conductor downstream of the residual-current transformer as otherwise residual current monitoring functions can no longer be ensured.

Type	3UG4625-1CW30, 3UG4625-2CW30	
General data		
Insulation voltage for overvoltage category III acc. to IEC 60664 for pollution degree 3, rated value	V	300
Impulse withstand voltage, rated value U_{imp}	kV	4
Control circuit		
Number of CO contacts for auxiliary contacts		2
Thermal current of the non-solid-state contact blocks, maximum	A	5
Current-carrying capacity of the output relay		
• At AC-15 at 250 V at 50/60 Hz	A	3
• At DC-13		
- At 24 V	A	1
- At 125 V	A	0.2
- At 250 V	A	0.1
Operational current at 17 V, minimum	mA	5

Selection and ordering data

- For monitoring residual currents from 0.03 to 40 A, from 16 to 400 Hz
- For 3UL23 residual-current transformers with feed-through opening from 35 to 210 mm
- Permanent self-monitoring
- Certified in accordance with IEC 60947, functionality corresponds to IEC 62020
- Digitally adjustable, with illuminated LCD

- Permanent display of actual value and tripping state
- Separately adjustable limit value and warning threshold
- 1 changeover contact each for warning threshold and tripping threshold

PU (UNIT, SET, M) = 1
 PS* = 1 unit
 PG = 41H



3UG4625-1CW30



3UG4625-2CW30

Measurable current	Adjustable response value current	Switching hysteresis	Adjustable ON-delay time	Control supply voltage			SD	Screw terminals		SD	Spring-loaded terminals	
				At AC at 50 Hz, rated value	At AC at 60 Hz, rated value	At DC, rated value		Article No.	Price per PU		Article No.	Price per PU
A	A	%	s	V	V	V	d			d		
0.01 ... 43	0.03 ... 40	0 ... 50	0 ... 20	24 ... 240	24 ... 240	24 ... 240	2	3UG4625-1CW30		2	3UG4625-2CW30	

For accessories, see page 10/99.

For the 3UL23 residual-current transformers, see page 10/88.

Monitoring and control devices

Relays

SIRIUS 3UG45, 3UG46 monitoring relays for stand-alone installation

Residual-current monitoring > 3UL23 residual-current transformers

Overview



SIRIUS 3UL23 residual-current transformer

The 3UL23 residual-current transformers detect residual currents in machines and plants. They are suitable for pure AC residual currents or AC residual currents with a pulsating DC fault current component (transformer type A in accordance with DIN VDE 0100-530/IEC TR 60755).

Together with the 3UG4625, 3UG4825 residual-current monitoring relays for IO-Link or the SIMOCODE 3UF motor management and control device they enable residual-current and ground-fault monitoring.

The 3UL2302-1A and 3UL2303-1A residual-current transformers with a feed-through opening from 35 to 55 mm can be mounted in conjunction with the 3UL2900 accessories on a TH 35 standard mounting rail according to IEC 60715.

Selection and ordering data

Diameter of the bushing opening	Connectable cross-section of the connecting terminal	SD	Screw terminals 	PU (UNIT, SET, M)	PS*	PG
mm	mm ²	d	Article No.	Price per PU		
Residual-current transformers (essential accessories for 3UG4625, 3UG4825)						
35	2.5	▶	3UL2302-1A	1	1 unit	41H
55	2.5	▶▶	3UL2303-1A	1	1 unit	41H
80	2.5	2	3UL2304-1A	1	1 unit	41H
110	2.5	2	3UL2305-1A	1	1 unit	41H
140	2.5	▶▶	3UL2306-1A	1	1 unit	41H
210	4	▶▶	3UL2307-1A	1	1 unit	41H

Accessories

Version	SD	Article No.	Price per PU	PU (UNIT, SET, M)	PS*	PG
	d					

Adapters



3UL2900

Adapters

For mounting on standard rail
for 3UL23 to diameter 55 mm

▶ **3UL2900**

1 2 units 41H

Overview

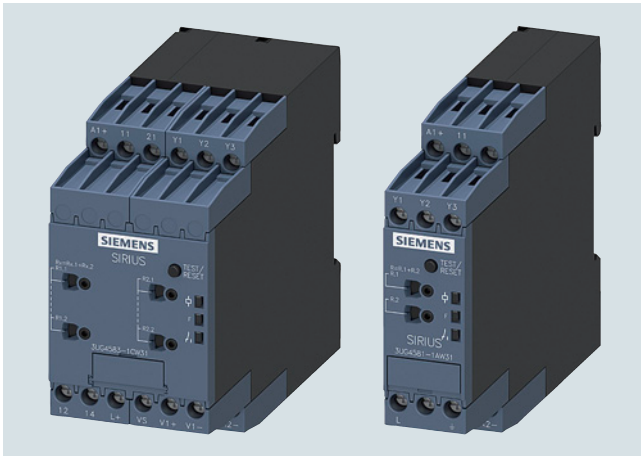

SIRIUS 3UG458 insulation monitor

Insulation monitoring relays are used for monitoring the insulation resistance between ungrounded 1-phase or 3-phase AC supplies and a protective conductor.

Ungrounded, i.e. isolated networks (IT networks) are always used where high demands are placed on the reliability of the power supply, e.g. emergency lighting systems. IT systems are supplied via an isolating transformer or by power supply sources such as batteries or a generator. While an initial insulation fault between a phase conductor and the ground effectively grounds the conductor, as a result no circuit has been closed, so it is possible to continue work in safety (single-fault safety). However, the fault must be rectified as quickly as possible before a second insulation fault occurs (e.g. according to DIN VDE 0100-410). For this purpose insulation monitoring relays are used, which constantly measure the resistance to ground of the phase conductor and the neutral conductor, reporting a fault immediately if insulation resistance falls below the set value so that either a controlled shutdown can be performed or the fault can be rectified without interrupting the power supply.

Two device series

- 3UG4581 insulation monitoring relays for ungrounded AC networks
- 3UG4582 and 3UG4583 insulation monitoring relays for ungrounded DC and AC networks

Insulation monitoring for ungrounded AC networks

The 3UG4581 insulation monitoring relays are used to monitor insulation resistance according to IEC 61557-8 in ungrounded AC networks with rated voltages of up to 400 V.

These devices can monitor control circuits (1-phase) and main circuits (3-phase).

They measure insulation resistances between system cables and system ground. If the value falls below the threshold value, the output relays are switched to fault status.

In the case of 3UG4581 a higher-level DC measuring signal is used. The higher-level DC measuring signal and the resulting current are used to determine the value of the insulation resistance of the network which is to be measured.

Insulation monitoring relay for ungrounded DC and AC networks

The 3UG4582 and 3UG4583 insulation monitoring relays are used to monitor insulation resistance in ungrounded IT AC or DC networks according to IEC 61557-8.

They measure insulation resistances between system cables and system ground. If the value falls below the threshold value, the output relays are switched to fault status. With these devices, which are suitable for both AC and DC networks, a pulsed test signal is fed into the network to be monitored and the insulation resistance is determined.

The pulsed test signal changes its form according to insulation resistance and network loss capacitance. The changed form is used to predict the changed insulation resistance.

If the predicted insulation resistance matches the insulation resistance calculated in the next measurement cycle, and is lower than the threshold value, the output relays are activated or deactivated, depending on the device configuration. This measurement principle is also suitable for identifying symmetrical insulation faults.

3UG4983 voltage reducer module

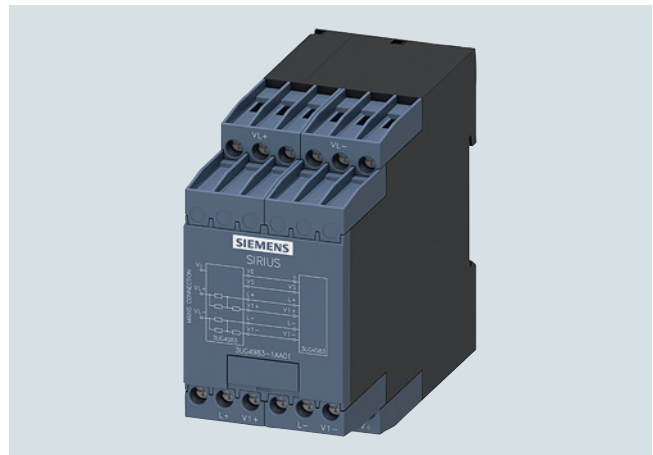

3UG4983 voltage reducer module

The 3UG4983-.AA01 voltage reducer module is available for the 3UG4583 insulation monitoring relay to extend the network voltage range to 690 V AC and 1000 V DC.

Connection methods

With the updated enclosure, future-proof push-in technology is available alongside the tried-and-trusted screw terminals.

Push-in is a form of spring-loaded connection system allowing wiring of terminals without tools. These terminals are self-adjusting, i.e. the regular tightening needed with screw terminals is not necessary.

Monitoring and control devices

Relays

SIRIUS 3UG45, 3UG46 monitoring relays for stand-alone installation

Insulation monitoring

NEW

Benefits

- Devices for AC and DC systems
- All devices have a wide control supply voltage range
- Direct connection to networks with mains voltages of up to 690 V AC and 1 000 V DC by means of a voltage reducer module
- For AC supply systems: Frequency range 15 to 400 Hz
- Monitoring of broken conductors
- Monitoring of setting errors
- Safety in use thanks to integrated system test after startup
- Option of resetting and testing (by means of button on front or using control contact)
- New predictive measurement principle allows very fast response times
- All versions with screw or spring-loaded terminals with push-in functionality

Application

IT networks are used, for example:

- In emergency power supplies
- In safety lighting systems
- In industrial production facilities with high availability requirements (chemical industry, automobile manufacturing, printing plants)
- In shipping and railways
- For mobile generators (aircraft)
- For renewable energies, such as wind energy and photovoltaic power plants
- In the mining industry

Technical specifications

More information

For equipment manuals, see

- <https://support.industry.siemens.com/cs/ww/en/view/54382552>
- <https://support.industry.siemens.com/cs/ww/en/view/54382528>

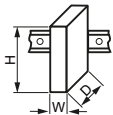

Type		3UG4581-.AW31	3UG4582-.AW31	3UG4583-.CW31	3UG4983-.AA01
General data					
Dimensions (W x H x D)	 mm	22.5 x 78 x 100		45 x 78 x 100	
Degree of protection IP on the front according to IEC 60529		IP20			
Mounting position		Any			
Type of mounting		Snap-on mounting on 35 mm standard mounting rail			
Ambient temperature during operation	°C	-25 ... +60			
Fault storage		✓	✓	✓	--
Measuring circuit					
Measurable voltage					
• At DC	V	--	0 ... 345	0 ... 600	0 ... 1000
• At AC	V	0 ... 460	0 ... 287.5	0 ... 400	0 ... 690
Measurable line frequency	Hz	50 ... 60		15 ... 400	
Adjustable response value impedance					
• 1	kΩ	1 ... 100		--	
• 2	kΩ	--		2 ... 200	
System leakage capacitance	μF	10		20	
Control circuit					
Control supply voltage					
• At AC					
- At 50 Hz	V	24 ... 240		--	
- At 60 Hz	V	24 ... 240		--	
• At DC	V	24 ... 240		--	
Operating frequency	Hz	15 ... 400			
Impulse withstand voltage	V	6000		4000	8000
Number of CO contacts with delayed switching		1		2	0
Thermal current of the non-solid-state contact blocks, maximum	A	4			

✓ Available

-- Not available

NEW

Insulation monitoring

Type	3UG4581-1AW31 3UG4582-1AW31 3UG4583-1CW31 3UG4983-1AA01	3UG4581-2AW31 3UG4582-2AW31 3UG4583-2CW31 3UG4983-2AA01
Type of electrical connection	 Screw terminals	 Spring-loaded terminals (push-in)
Tightening torque	0.6 ... 0.8 Nm	--
Type of connectable conductor cross-sections	1x (0.5 ... 4.0 mm ²), 2x (0.5 ... 2.5 mm ²)	2 x (0.5 ... 1.5 mm ²)
<ul style="list-style-type: none"> • Finely stranded • Finely stranded <ul style="list-style-type: none"> - Without end sleeves - With end sleeves • For AWG cables <ul style="list-style-type: none"> - Solid - Stranded 	1x (0.5 ... 2.5 mm ²), 2x (0.5 ... 1.5 mm ²) 1x (0.5 ... 2.5 mm ²), 2x (0.5 ... 1.5 mm ²)	2 x (0.5 ... 1.5 mm ²) 2 x (0.5 ... 1.5 mm ²)
	1 x (20 ... 12), 2x (20 ... 14) 1 x (18 ... 14), 2x (18 ... 16)	2 x (20 ... 16) 2 x (18 ... 16)

With the closed-circuit principle selected

- Insulation resistance monitoring without fault storage, with Auto RESET
- Insulation resistance monitoring with fault storage and Manual RESET

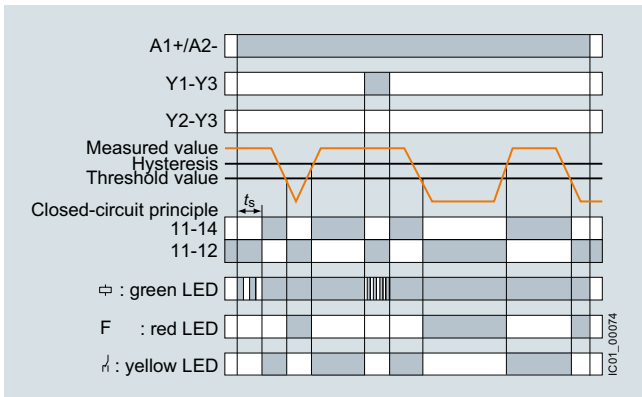

3UG4581, 3UG4582 monitoring relays

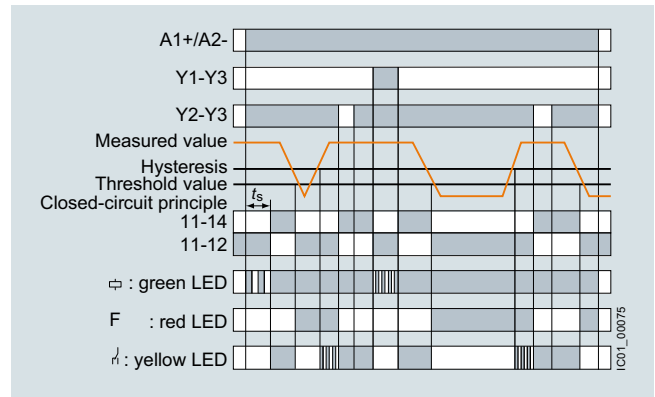

3UG4581, 3UG4582 monitoring relays

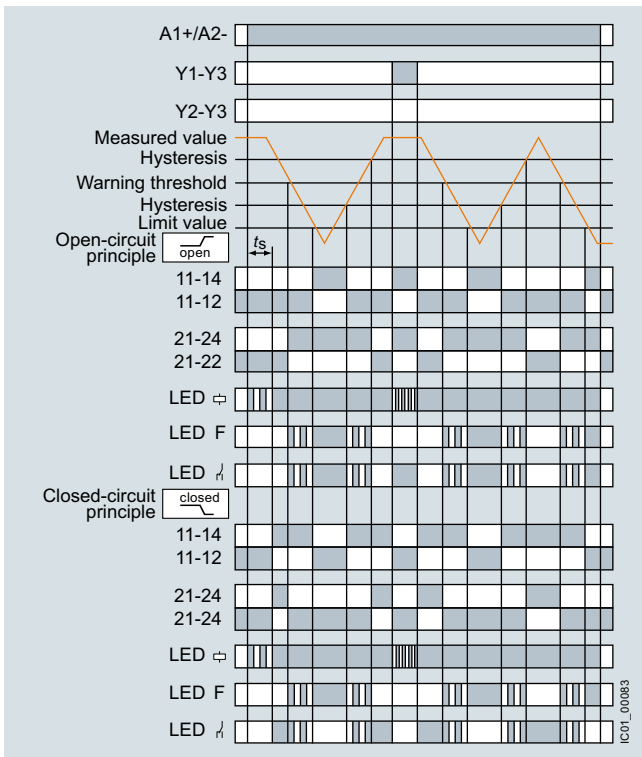

3UG4583 monitoring relays

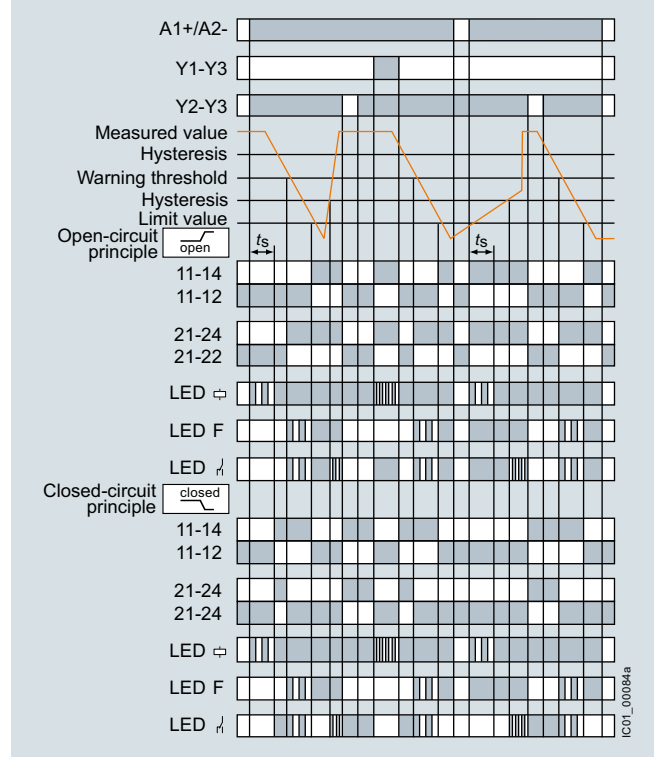

3UG4583 monitoring relays

Monitoring and control devices

Relays

SIRIUS 3UG45, 3UG46 monitoring relays for stand-alone installation

Insulation monitoring

NEW

Selection and ordering data

PU (UNIT, SET, M) = 1
 PS* = 1 unit
 PG = 41H



3UG4581-1AW31





3UG4582-1AW31



3UG4583-1CW31



3UG4583-1AA01

Measurable voltage		Type of voltage of the control supply voltage, value range	System leakage capacitance	Number of CO contacts with delayed switching	Adjustable response value impedance		SD	Screw terminals 		SD	Spring-loaded terminals (push-in) 	
At AC	At DC				1	2		Article No.	Price per PU		Article No.	Price per PU
V	V	AC/DC	μF		kΩ	kΩ	d		d			
Insulation monitors												
0 ... 460	--	24 ... 240	10	1	1 ... 100	--	5	3UG4581-1AW31	5		3UG4581-2AW31	
0 ... 287.5	0 ... 345	24 ... 240	10	1	1 ... 100	--	5	3UG4582-1AW31	5		3UG4582-2AW31	
0 ... 460	0 ... 690	24 ... 240	20	2	1 ... 100	2 ... 200	5	3UG4583-1CW31	5		3UG4583-2CW31	
Voltage reducer modules												
For the 3UG4583 insulation monitoring relay for extending the network voltage range to 690 V AC and 1 000 V DC												
0 ... 460	0 ... 690	--	20	0	--	--	5	3UG4983-1AA01	5		3UG4983-2AA01	

Overview



SIRIUS 3UG4501 monitoring relay

The 3UG4501 level monitoring relay is used in combination with 2- or 3-pole sensors to monitor the levels of conductive liquids.

Benefits

- Can be used worldwide thanks to wide voltage range from 24 to 240 V (absolute limit values)
- Individually shortenable 2- and 3-pole wire electrodes for easy mounting from above/below
- Bow electrodes for installation from the side, for larger filling levels and minimum space requirements
- Can be flexibly adapted to different conductive liquids through analog setting of the sensitivity from 2 to 200 k Ω
- Compensation for wave movements through tripping delay times from 0.1 to 10 s
- Upstream or downstream function selectable
- All versions with removable terminals
- All versions with screw or spring-loaded terminals

Application

- Single-point and two-point level monitoring
- Overflow protection
- Dry-running protection
- Leak monitoring

Technical specifications

3UG4501 monitoring relays

The principle of operation of the 3UG4501 level monitoring relay is based on measuring the electrical resistance of the liquid between two immersion sensors and a reference terminal. If the measured value is lower than the sensitivity set at the front, the output relay changes its switching state. In order to preclude active current undershooting of the liquid, the sensors are supplied with alternating current.

Two-point control

The output relay changes its switching state as soon as the liquid level reaches the maximum sensor, while the minimum sensor is submerged. The relay returns to its original switching state as soon as the minimum sensor no longer has contact with the liquid.

OVER, two-point control

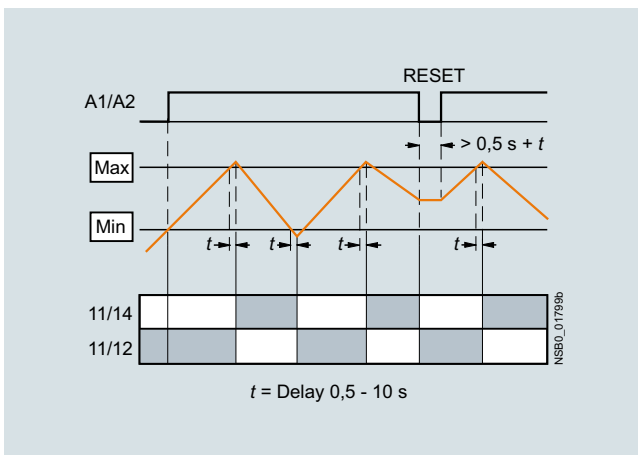

UNDER, two-point control

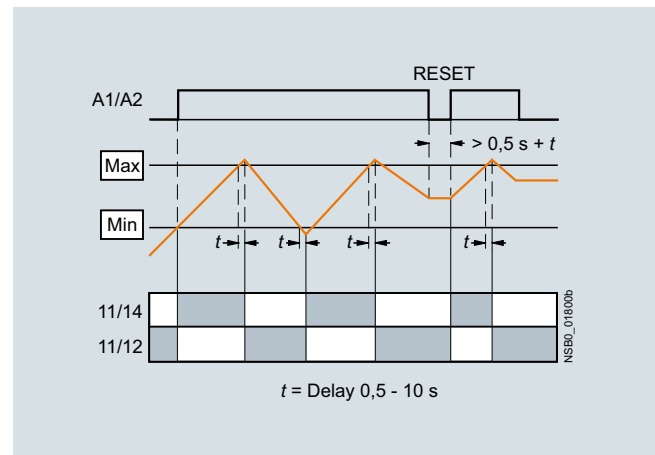
Note:

It is also possible to connect other resistance sensors to the Min and Max terminals in the range 2 to 200 k Ω , e.g. photoresistors, temperature sensors, encoders based on resistance, etc. The monitoring relay can therefore also be used for other applications as well as for monitoring the levels of liquids.

Monitoring and control devices

Relays

SIRIUS 3UG45, 3UG46 monitoring relays for stand-alone installation

Level monitoring

Single-point control

If only one level is being controlled, the terminals for Min and Max on the monitoring relay are bridged. The output relay changes its switching state as soon as the liquid level is reached and returns to its original switching state once the sensor no longer has contact with the liquid.

In order to prevent premature tripping of the switching function caused by wave motion or frothing, even though the set level has not been reached, it is possible to delay this function by 0.5 to 10 s.

For safe resetting, the control supply voltage must be interrupted for at least the set delay time of +0.5 s.

OVER, single-point control

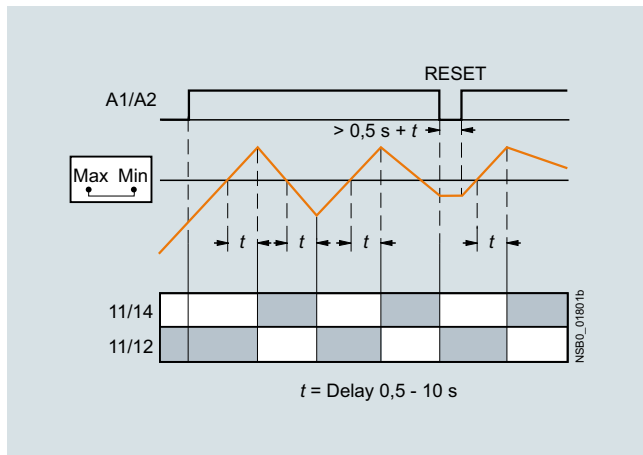

UNDER, single-point control

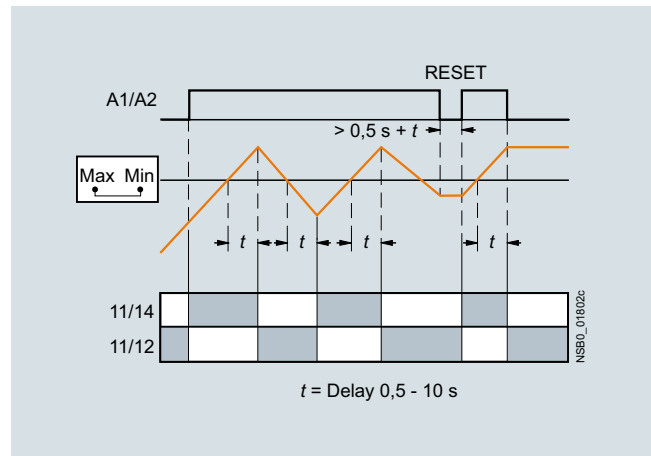



Type	3UG4501	
General data		
Rated insulation voltage U_i	V	300
Pollution degree 3 Overvoltage category III acc. to VDE 0110		
Rated impulse withstand voltage U_{imp}	kV	4
Measuring circuit		
Electrode current, max. (typ. 70 Hz)	mA	1
Electrode voltage, max. (typ. 70 Hz)	V	15
Sensor feeder cable	m	Max. 100
Conductor capacitance of sensor cable¹⁾	nF	Max. 10
Control circuit		
Load capacity of the output relay		
Thermal current I_{th}	A	5
Rated operational current I_o at		
• AC-15/24 ... 400 V	A	3
• DC-13/24 V	A	1
• DC-13/125 V	A	0.2
• DC-13/250 V	A	0.1
Minimum contact load at 17 V DC	mA	5

¹⁾ The sensor cable does not necessarily have to be shielded, but we do not recommend installing this cable parallel to the power supply lines. It is also possible to use a shielded cable, whereby the shield has to be connected to the M terminal.

Selection and ordering data

- For level monitoring of electrically conductive liquids
- Control principle: inlet or sequence control adjustable per rotary switch
- Single-point and two-point control possible
- Analogically adjustable sensitivity (specific resistance of the liquid)
- Analogically adjustable tripping delay time
- 1 yellow LED for displaying the relay state
- 1 green LED for displaying the applied control supply voltage
- 1 CO contact

PU (UNIT, SET, M) = 1
 PS* = 1 unit
 PG = 41H

Sensitivity	Tripping delay time	Rated control supply voltage U_s	SD	Screw terminals 		Spring-loaded terminals 	
				Article No.	Price per PU	Article No.	Price per PU
kΩ	s	V	d	2	3UG4501-1AA30	2	3UG4501-2AA30
		AC/DC					
2 ... 200	0.5 ... 10	24 ¹⁾	2	2	3UG4501-1AA30	2	3UG4501-2AA30
		24 ... 240	2	2	3UG4501-1AW30	2	3UG4501-2AW30

¹⁾ The rated control supply voltage and the measuring circuit are not electrically separated.

For accessories, [see page 10/99](#).

Note:

Level monitoring sensors are available from various providers. We recommend sensors made by Jacob GmbH (see "External partners", [page 16/16](#)). The previous 3UG3 level sensors are also available from here.

Monitoring and control devices

Relays

SIRIUS 3UG45, 3UG46 monitoring relays for stand-alone installation

Speed monitoring

Overview



SIRIUS 3UG4651 monitoring relay

The 3UG4651 monitoring relay is used in combination with a sensor to monitor motor drives for overspeed and/or underspeed.

Furthermore, the monitoring relay is ideal for all functions where a continuous pulse signal needs to be monitored (e.g. belt travel monitoring, completeness monitoring, passing monitoring, clock-time monitoring).

Benefits

- Can be used worldwide thanks to wide voltage range from 24 to 240 V (absolute limit values)
- Variably adjustable to overshoot, undershoot or range monitoring
- Freely configurable delay times and RESET response
- Permanent display of actual value and fault type
- Use of up to 10 sensors per rotation for extremely slowly rotating motors
- Two- or three-wire sensors and sensors with a mechanical switching output or solid-state output can be connected
- Auxiliary voltage for sensor integrated
- All versions with removable terminals
- All versions with screw or spring-loaded terminals

Application

- Slip or tear of a belt drive
- Overload monitoring
- Transport monitoring for completeness

Technical specifications

3UG4651 monitoring relays

The speed monitoring relay operates according to the principle of period duration measurement.

In the monitoring relay, the time between two successive rising edges of the pulse encoder is measured and compared to the minimum and/or maximum permissible period duration calculated from the set limit values for the speed.

Thus, the period duration measurement recognizes any deviation in speed after just two pulses, even at very low speeds or in the case of extended pulse gaps.

By using up to ten pulse encoders evenly distributed around the circumference, it is possible to shorten the period duration, and in turn the response time. By taking into account the number of sensors in the monitoring relay, the speed continues to be indicated in rpm.

ON-delay time for motor start

To be able to start a motor drive, and depending on whether the open-circuit or closed-circuit principle is selected, the output relay switches to the OK state during the ON-delay time, even if the speed is still below the set value.

The ON-delay time is started by either switching on the auxiliary voltage or, if the auxiliary voltage is already applied, by actuating the respective NC contact (e.g. auxiliary contact).

Speed monitoring with Auto RESET (Memory = no)

If the device is set to Auto RESET, the output relay switches to the OK state, once the adjustable hysteresis threshold is reached in the range of 0.1 to 99.9 rpm and the flashing stops. Any overshoots or undershoots are therefore not stored.

Speed monitoring with Manual RESET (Memory = yes)

If Manual RESET is selected in the menu, the output relay remains in its current switching state and the current measured value and the symbol for overshooting/undershooting continue to flash, even when the speed returns to a permissible value. This stored fault status can be reset by simultaneously pressing the UP▲ and DOWN▼ buttons for > 2 s, by connecting the RESET device terminal to 24 V DC or by switching the control supply voltage off and back on again.

With the closed-circuit principle selected

Range monitoring without enable input

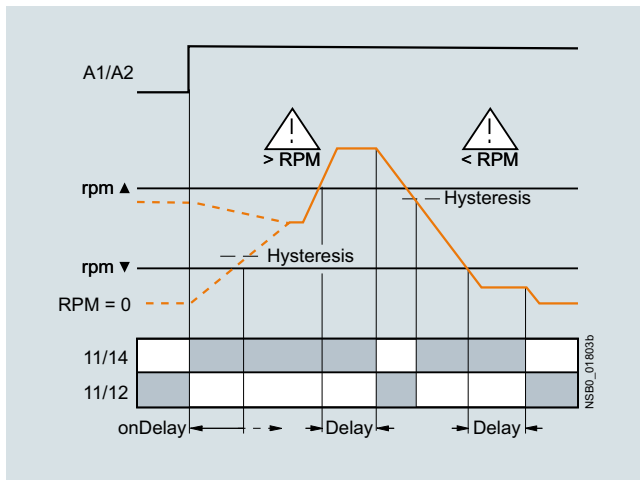

Range monitoring with enable input

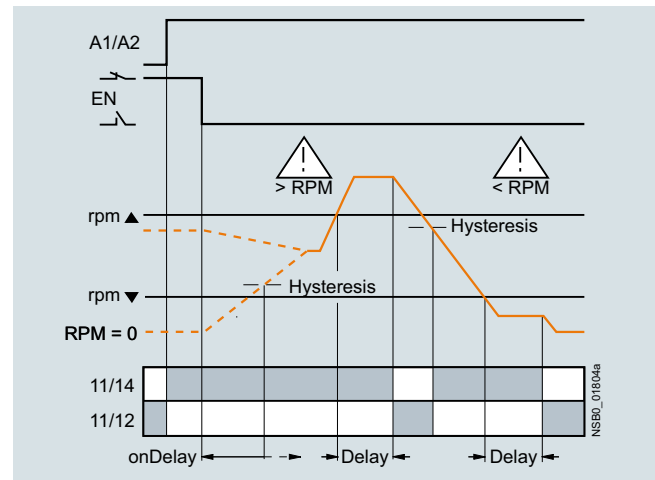

Type	3UG4651	
General data		
Rated insulation voltage U_i	V	300
Pollution degree 3 Overvoltage category III acc. to VDE 0110		
Rated impulse withstand voltage U_{imp}	kV	4
Measuring circuit		
Sensor supply		
• For three-wire sensor (24 V/0 V)	mA	Max. 50
• For two-wire NAMUR sensor (8V2)	mA	Max. 8.2
Signal input		
• IN1	k Ω	16, three-wire sensor, pnp operation
• IN2	k Ω	1, floating contact, two-wire NAMUR sensor
Voltage level		
• For level 1 at IN1	V	4.5 ... 30
• For level 0 at IN1	V	0 ... 1
Current level		
• For level 1 at IN2	mA	> 2.1
• For level 0 at IN2	mA	< 1.2
Minimum pulse duration of signal	ms	5
Minimum interval between 2 pulses	ms	5
Control circuit		
Number of CO contacts for auxiliary contacts		1
Load capacity of the output relay		
Thermal current I_{th}	A	5
Rated operational current I_e at		
• AC-15/24 ... 400 V	A	3
• DC-13/24 V	A	1
• DC-13/125 V	A	0.2
• DC-13/250 V	A	0.1
Minimum contact load at 17 V DC	mA	5

Monitoring and control devices

Relays



SIRIUS 3UG45, 3UG46 monitoring relays for stand-alone installation

Speed monitoring

Selection and ordering data

- For speed monitoring in revolutions per minute (rpm)
- Two- or three-wire sensor with mechanical or electronic switching output can be connected
- Two-wire NAMUR sensor can be connected
- Sensor supply 24 V DC/50 mA integrated
- Input frequency 0.1 to 2 200 pulses per minute (0.0017 to 36.7 Hz)
- With or without enable signal for the drive to be monitored
- Digitally adjustable, with illuminated LCD
- Overshoot, undershoot or range monitoring adjustable
- Number of pulses per revolution can be adjusted
- Upper and lower threshold value can be adjusted separately
- Auto, Manual or Remote RESET options after tripping
- Permanent display of actual value and tripping state
- 1 CO contact





PU (UNIT, SET, M) = 1
 PS* = 1 unit
 PG = 41H

Measuring range	Hysteresis	ON-delay time	Tripping delay time	Pulses per revolution	Rated control supply voltage U_s	SD	Screw terminals 	SD	Spring-loaded terminals 		
rpm	rpm	s	s		V AC/DC	d	Article No.	Price per PU	d	Article No.	Price per PU
0.1 ... 2 200	OFF 0.1 ... 99.9	0 ... 900	0.1 ... 99.9	1 ... 10	24 ¹⁾	2	3UG4651-1AA30	2	3UG4651-2AA30		
					24 ... 240	2	3UG4651-1AW30	2	3UG4651-2AW30		

¹⁾ The rated control supply voltage and the measuring circuit are not electrically separated.

For accessories, see page 10/99.

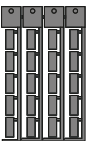
Selection and ordering data

Use	Version	SD	Article No.	Price per PU	PU (UNIT, SET, M)	PS*	PG
d							
Accessories for enclosures							
 3RP1902	For 3UG4	Sealable covers For securing against unauthorized adjustment of setting knobs	5	3RP1902	1	5 units	41H
 3RP1903	For 3UG4	Push-in lugs For screw fixing, 2 units are required for each device	5	3RP1903	1	10 units	41H
Blank labels							
 3RT2900-1SB20	For 3UG4	Unit labeling plates¹⁾ For SIRIUS devices • 20 mm x 7 mm, titanium gray ¹⁾	20	3RT2900-1SB20	100	340 units	41B
Tools for opening spring-loaded terminals							
 3RA2908-1A	For auxiliary circuit connections	Screwdrivers For all SIRIUS devices with spring-loaded terminals Length approx. 200 mm, 3.0 mm x 0.5 mm, titanium gray/black, partially insulated	2	Spring-loaded terminals  3RA2908-1A	1	1 unit	41B

¹⁾ PC labeling system for individual inscription of unit labeling plates available from: murrplastik Systemtechnik GmbH, see page 16/16.

Note:

For products for mechanical bearing monitoring, e.g. condition monitoring systems, see www.siemens.com/siplus-cms.

Monitoring and control devices

Relays

SIRIUS 3UG48 monitoring relays for stand-alone installation for IO-Link

General data

Overview

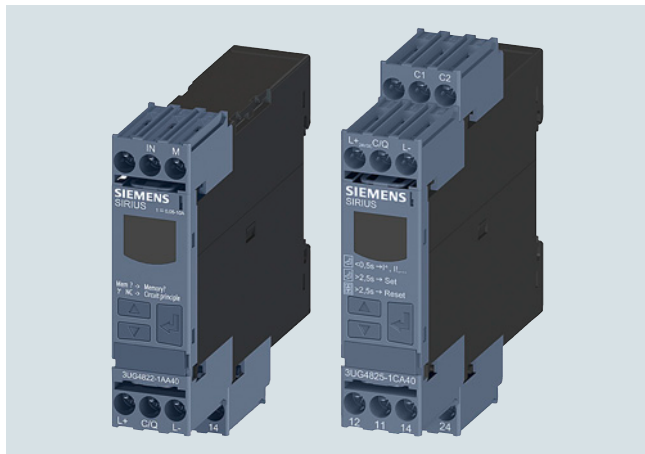

SIRIUS 3UG48 monitoring relays

More information

Homepage, see www.siemens.com/sirius-monitoring-relays

Industry Mall, see www.siemens.com/product?3UG48

Conversion tool, see www.siemens.com/conversion-tool

The SIRIUS 3UG4 monitoring relays for electronic and mechanical variables monitor all important characteristics that allow conclusions to be drawn about the functionality of a plant. Both sudden disturbances and gradual changes, which may indicate the need for maintenance, are detected.

Thanks to their relay outputs, the monitoring relays permit direct disconnection of the affected system components and alerting, e.g. by the triggering of a warning light. Thanks to adjustable delay times the 3UG4 monitoring relays can respond very flexibly to brief faults such as voltage dips or load changes and can thus avoid unnecessary alarms and disconnections and increase system availability.

3UG48 monitoring relays for IO-Link

The SIRIUS 3UG48 monitoring relays for IO-Link also offer many other options based upon the monitoring functions of the tried-and-tested SIRIUS 3UG4 monitoring relays:

- Measured value transmission to a controller, including resolution and unit, may be parameterizable as to which value is cyclically transmitted
- Transmission of alarm flags to a controller
- Full diagnostics capability by inquiry as to the cause of the fault in the diagnostics data record
- Remote parameterization is also possible, in addition to or instead of local parameterization
- Rapid parameterization of the same devices by duplication of the parameterization in the controller
- Parameter transmission through uploading to a controller by IO-Link call or by parameter server (if IO-Link master from IO-Link specification V1.1 and higher is used)
- Consistent central data storage in the event of parameter change locally or via a controller
- Automatic reparameterizing when devices are exchanged
- Blocking of local parameterization via IO-Link possible
- Faults are saved in parameterizable and non-volatile fashion to prevent an automatic startup after voltage failure and to make sure diagnostics data are not lost

- Integration into the automation level provides the option of parameterizing the monitoring relays at any time via a display unit, or displaying the measured values in a control room or locally at the machine/control cabinet.
- The MindSphere app SIRIUS Asset Monitor enables access to the SIRIUS 3UG48 monitoring relay for IO-Link anytime and anywhere. It provides the user with detailed information on the device status as well as fault messages and warnings in a clearly arranged form, see [page 14/26](#).

Even without communication via IO-Link the devices continue to function fully autonomously:

- Parameterization can take place locally at the device, independently of a controller.
- In the event of failure or before the controller becomes available the monitoring relays work as long as the control supply voltage (24 V DC) is present.
- If the monitoring relays are operated without the controller, the 3UG48 monitoring relays have, thanks to the integrated SIO mode, an additional semiconductor output, which switches when the adjustable warning threshold is exceeded.

Thanks to the combination of autonomous monitoring relay function and integrated IO-Link communication, redundant sensors and/or analog signal converters – which previously took over the transmission of measured values to a controller, leading to considerable extra cost and wiring overhead – are no longer needed.

Because the output relays are still present, the monitoring relays increase the functional reliability of the system, since only the controller can fulfill the control tasks if the current measured values are available, whereas the output relays can also be used for the disconnection of the system if limit values that cannot be reached during operation are exceeded.

The individual 3UG48 monitoring relays for IO-Link offer the following functions in different combinations:

- Phase sequence
- Phase failure, neutral conductor failure
- Phase asymmetry
- Undershooting and/or overshooting of limit values for voltage
- Undershooting and/or overshooting of limit values for current
- Undershooting and/or overshooting of power factor limit values
- Monitoring of the active current or the apparent current
- Monitoring of the residual current
- Undershooting and/or overshooting of limit values for speed

Note:

For more information on the IO-Link bus system, see [page 2/87 onwards](#).

Notes on security

In order to protect plants, systems, machines and networks against cyber threats, it is necessary to implement – and continuously maintain – a holistic, state-of-the-art industrial security concept. Siemens products and solutions represent only one component of such a concept.

For more information about the subject of Industrial Security, see www.siemens.com/industrialsecurity.

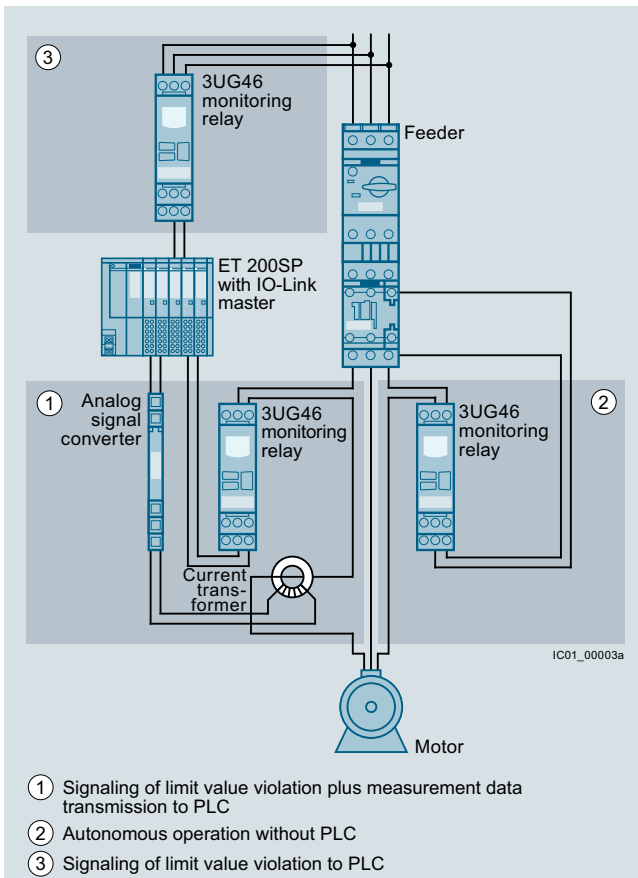

Use of conventional monitoring relays

Notes:

Devices required for communication via IO-Link:

- Any controller that supports IO-Link (e.g. ET 200SP with CPU or S7-1200), see [Catalog ST 70](#).
- IO-Link master (e.g. CM 4xIO-Link for SIMATIC ET 200SP, see [page 2/98](#) or SM 1278 for S7-1200, see [page 2/97](#)).

Article No. scheme

Product versions		Article number	
3UG4 monitoring relay with IO-Link		3UG4	<input type="checkbox"/> <input type="checkbox"/> <input type="checkbox"/> - <input type="checkbox"/> <input type="checkbox"/> <input type="checkbox"/> <input type="checkbox"/> 0
Type of setting	e.g. 8 = analogically adjustable	<input type="checkbox"/>	
Functions	e.g. 15 = line monitoring	<input type="checkbox"/> <input type="checkbox"/>	
Connection type	Screw terminals		1
	Spring-loaded terminals		2
Contacts	e.g. A = 1 CO contact	<input type="checkbox"/>	
Supply voltage	e.g. A4 = 160 ... 690 V AC		<input type="checkbox"/> <input type="checkbox"/>
Example		3UG4	8 1 5 - 1 A A 4 0

Note:

The Article No. scheme shows an overview of product versions for better understanding of the logic behind the article numbers.

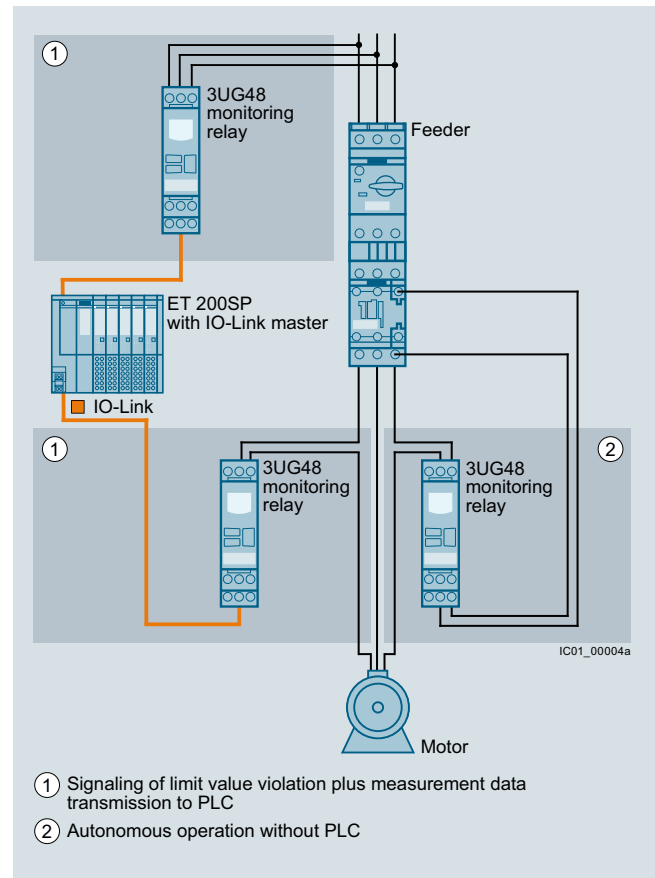

Monitoring relays for IO-Link

Each monitoring relay requires an IO-Link channel.

For your orders, please use the article numbers quoted in the selection and ordering data.

Benefits

- Simple cyclical transmission of the current measured values, relay switching states and events to a controller
- Remote parameterization
- Automatic reparameterizing when devices are exchanged
- Simple duplication of identical or similar parameterizations
- Reduction of control current wiring
- Elimination of testing costs and wiring errors
- Reduction of configuration work
- Integration in TIA means clear diagnostics if a fault occurs
- Cost saving and space saving in control cabinet due to the elimination of AI and IO modules as well as analog signal converters and duplicated sensors

Monitoring and control devices

Relays

SIRIUS 3UG48 monitoring relays for stand-alone installation for IO-Link

General data

Application

The use of SIRIUS monitoring relays for IO-Link is particularly recommended for machines and plants in which these relays, in addition to their monitoring function, are to be connected to the automation level for the rapid, simple and fault-free provision of the current measured values and/or for remote parameterization.



The monitoring relays can either relieve the controller of monitoring tasks or, as a second monitoring entity in parallel to and independent of the controller, increase the reliability in the process or in the system. In addition, the elimination of AI and IO modules allows the width of the controller to be reduced despite significantly expanded functionality.

Technical specifications

More information

Technical specifications, see <https://support.industry.siemens.com/cs/ww/en/ps/16368/td>
Equipment Manual and internal circuit diagrams, see <https://support.industry.siemens.com/cs/ww/en/view/54375430>

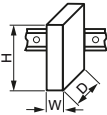
FAQs, see <https://support.industry.siemens.com/cs/ww/en/ps/16368/faq>

Type	3UG48	
General technical specifications		
Dimensions (W x H x D)		
• For 3 terminal blocks		
- Screw terminals	mm	22.5 x 92 x 91
- Spring-loaded terminals	mm	22.5 x 94 x 91
• For 4 terminal blocks		
- Screw terminals	mm	22.5 x 103 x 91
- Spring-loaded terminals	mm	22.5 x 103 x 91
Permissible ambient temperature		
• During operation	°C	-25 ... +60
Connection type		
		 Screw terminals
• Terminal screw		M3 (for standard screwdriver, size 2 and Pozidriv 2)
• Solid	mm ²	1 x (0.5 ... 4), 2 x (0.5 ... 2.5)
• Finely stranded with end sleeve	mm ²	1 x (0.5 ... 2.5), 2 x (0.5 ... 1.5)
• AWG cables, solid or stranded	AWG	2 x (20 ... 14)
• Tightening torque	Nm	0.8 ... 1.2
Connection type		
		 Spring-loaded terminals
• Solid	mm ²	2 x (0.25 ... 1.5)
• Finely stranded, with end sleeve acc. to DIN 46228	mm ²	2 x (0.25 ... 1.5)
• Finely stranded	mm ²	2 x (0.25 ... 1.5)
• AWG cables, solid or stranded	AWG	2 x (24 ... 16)

Overview



SIRIUS 3UG4815 monitoring relay

Solid-state line monitoring relays provide maximum protection for mobile machines, plants and hoisting equipment or for unstable networks. Network and voltage faults can thus be detected early and rectified before far greater damage ensues.

The line monitoring relays with IO-Link monitor phase sequence, phase failure (with or without N conductor monitoring), phase asymmetry and undervoltage and/or overvoltage.

Phase asymmetry is evaluated as the difference between the greatest and the smallest phase voltage relative to the greatest phase voltage. Undervoltage or overvoltage exist if the set limit values for at least one phase voltage are overshoot or undershot. The rms value of the voltage is measured.

Benefits

- Can be used in any network from 160 to 630 V AC worldwide thanks to wide voltage range
- Variably adjustable to overshoot, undershoot or range monitoring
- Freely configurable delay times and RESET response
- Width 22.5 mm
- Display and transmission of actual value and network fault type to controller
- All versions with removable terminals
- All versions with screw or spring-loaded terminals

Application

The relays are used above all for mobile equipment, e.g. air conditioning compressors, refrigerating containers, building site compressors and cranes.

Function	Application
Phase sequence	<ul style="list-style-type: none"> • Direction of rotation of the drive
Phase failure	<ul style="list-style-type: none"> • A fuse has tripped • Failure of the control supply voltage • Broken cable
Phase asymmetry	<ul style="list-style-type: none"> • Overheating of the motor due to asymmetrical voltage • Detection of asymmetrically loaded networks
Undervoltage	<ul style="list-style-type: none"> • Increased current on a motor with corresponding overheating • Unintentional resetting of a device • Network collapse, particularly with battery power
Overvoltage	<ul style="list-style-type: none"> • Protection of a plant against destruction due to overvoltage

Monitoring and control devices

Relays

SIRIUS 3UG48 monitoring relays for stand-alone installation for IO-Link

Line monitoring

Technical specifications

3UG4815/3UG4816 monitoring relays

The 3UG4815 and 3UG4816 line monitoring relays have a wide voltage range input and are supplied with power through IO-Link or from an external 24 V DC source.

The device is equipped with a display and is parameterized using three buttons. The 3UG4815 monitoring relay monitors 3-phase networks with regard to phase sequence, phase failure, phase asymmetry, undervoltage and overvoltage. The 3UG4816 monitoring relay monitors the neutral conductor as well. The hysteresis is adjustable from 1 to 20 V.

The device has two separately adjustable delay times for overvoltage and undervoltage and for line stabilization. If the direction of rotation is incorrect or a phase fails, the device switches off immediately. Thanks to a special measuring method, a phase failure is reliably detected in spite of the wide voltage range from and potentially high feedback through the load.

The 3UG4815 and 3UG4816 monitoring relays can be operated on the basis of either the open-circuit or closed-circuit principle and with Manual or Auto RESET.

If Manual RESET is selected in the menu (Memory = Yes), the switching relay remains in its current switching state and the current measured value and the symbol for undershooting and overshooting continue to flash, even when the measured variable reaches a permissible value again. This stored fault status can be reset by simultaneously pressing the UP▲ and DOWN▼ keys for 2.5 s.

With Manual RESET through IO-Link it is possible in addition to set whether fault messages are to be deleted when the control supply voltage is switched off and on (as Remote RESET) or whether the signals are to be permanently saved even in a voltage failure, with confirmation possible only through local RESET or via IO-Link.

With the closed-circuit principle selected

Wrong phase sequence

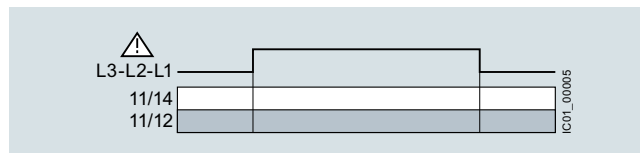

Phase failure

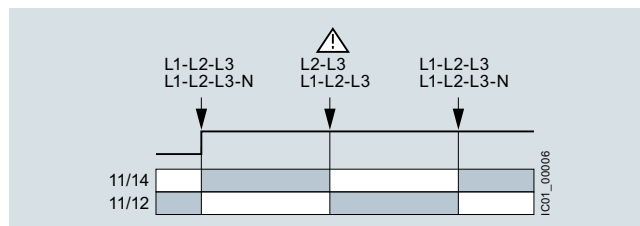

Undervoltage

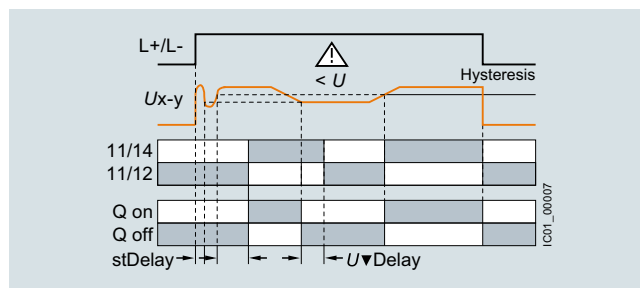

Overvoltage

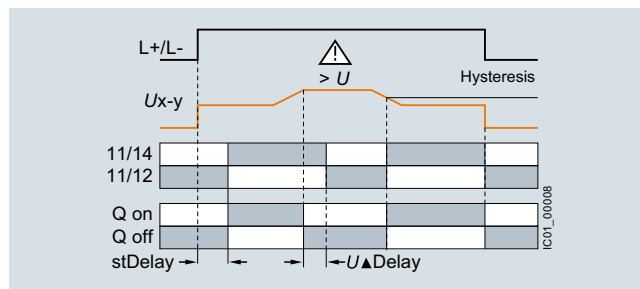



Type	3UG4815, 3UG4816	
General technical specifications		
Rated insulation voltage U_i	V	690
Pollution degree 2 Overvoltage category III acc. to VDE 0110		
Rated impulse withstand voltage U_{imp}	kV	6
Control circuit		
Load capacity of the output relay		
• Thermal current I_{th}	A	5
Rated operational current I_e at		
• AC-15/24 ... 400 V	A	3
• DC-13 at		
- 24 V	A	1
- 125 V	A	0.2
- 250 V	A	0.1
Minimum contact load at 17 V DC	mA	5
Electrical endurance AC-15	million operating cycles	0.1
Mechanical service life	million operating cycles	10

Selection and ordering data

- Adjustable via IO-Link and locally, with illuminated LCD
- Power supply with 24 V DC via IO-Link or external auxiliary voltage
- Auto or Manual RESET
- Open-circuit or closed-circuit principle
- 1 CO contact, 1 semiconductor output (in SIO mode)

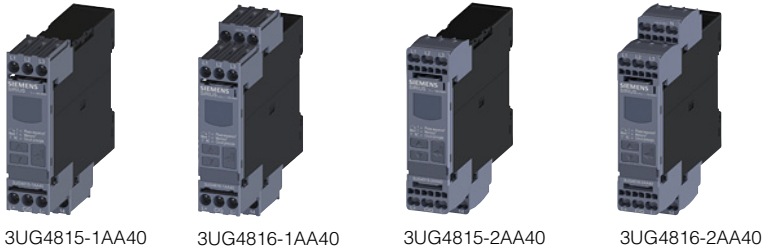
PU (UNIT, SET, M) = 1
 PS* = 1 unit
 PG = 41H



Adjustable hysteresis	Under-voltage detection	Overvoltage detection	Stabilization time adjustable stDEL	Tripping delay time adjustable Del	Version of auxiliary contacts	Measurable line voltage ¹⁾	SD	Screw terminals 	SD	Spring-loaded terminals 
V	s	s	V AC	d	Article No.	Price per PU	d	Article No.	Price per PU	
Monitoring of phase sequence, phase failure, phase asymmetry, overvoltage and undervoltage										
1 ... 20	✓	✓	0.1 ... 999.9	0.1 ... 999.9	1 CO + 1 Q ²⁾	160 ... 690	2	3UG4815-1AA40	2	3UG4815-2AA40
Monitoring of phase sequence, phase and N conductor failure, phase asymmetry, overvoltage and undervoltage										
1 ... 20	✓	✓	0.1 ... 999.9	0.1 ... 999.9	1 CO + 1 Q ²⁾	90 ... 400 against N	2	3UG4816-1AA40	2	3UG4816-2AA40

✓ Function supported

¹⁾ Absolute limit values.

²⁾ In SIO mode.

For accessories, see page 10/122.

Monitoring and control devices

Relays

SIRIUS 3UG48 monitoring relays for stand-alone installation for IO-Link

Voltage monitoring

Overview



SIRIUS 3UG4832 monitoring relay

The relays monitor 1-phase AC voltages (rms value) and DC voltages against the set limit value for overshoot and undershoot.

Benefits

- Variably adjustable to overshoot, undershoot or range monitoring
- Freely configurable delay times and RESET response
- Width 22.5 mm
- Display and transmission of actual value and status messages to controller
- All versions with removable terminals
- All versions with screw or spring-loaded terminals

Application

- Protection of a plant against destruction due to overvoltage
- Switch-on of a plant at a defined voltage and higher
- Protection from undervoltage due to overloaded supply voltages, particularly with battery power

Technical specifications

3UG4832 monitoring relays

The 3UG4832 voltage monitoring relays are supplied with power through IO-Link or with an external auxiliary voltage of 24 V DC and perform overshoot, undershoot or range monitoring of the voltage depending on parameterization. The devices are equipped with a display and are parameterized by means of three buttons or through IO-Link.

The measuring range extends from 10 to 600 V AC/DC. The limit values for overshoot or undershoot can be freely configured within this range. If one of these limit values is reached, the output relay responds according to the set principle of operation as soon as the delay time has elapsed. This tripping delay time $U\blacktriangle\text{Del}/U\blacktriangledown\text{Del}$ can be set from 0 to 999.9 s, as can the ON-delay time $on\text{Del}$. The hysteresis is adjustable from 0.1 to 300 V.

The device can be operated on the basis of either the open-circuit or closed-circuit principle and with Manual or Auto RESET. One output changeover contact is available as a signaling contact, and a semiconductor output is available in addition in SIO mode.

If Manual RESET is selected in the menu (Memory = Yes), the switching relay remains in its current switching state and the current measured value and the symbol for undershooting and overshooting continue to flash, even when the measured variable reaches a permissible value again. This stored fault status can be reset by simultaneously pressing the UP \blacktriangle and DOWN \blacktriangledown keys for 2.5 s.

With Manual RESET through IO-Link it is possible in addition to set whether fault messages are to be deleted when the control supply voltage is switched off and on (as Remote RESET) or whether the signals are to be permanently saved even in a voltage failure, with confirmation possible only through local RESET or via IO-Link.

With the closed-circuit principle selected

Overvoltage

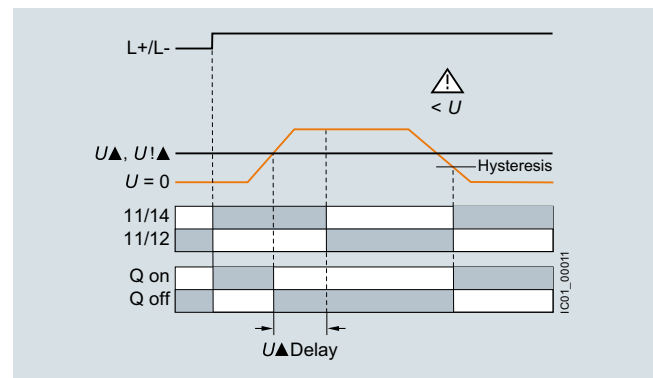

Undervoltage

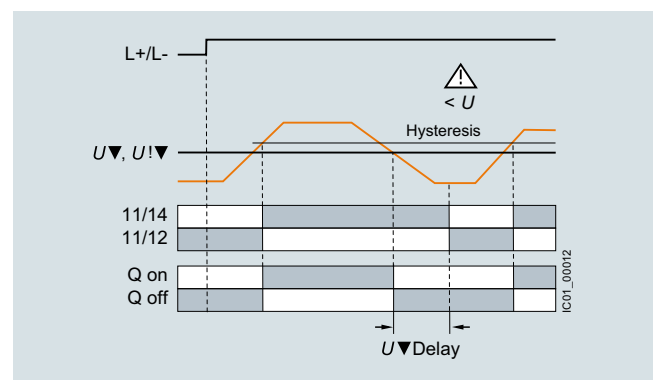

With the closed-circuit principle selected

Range monitoring

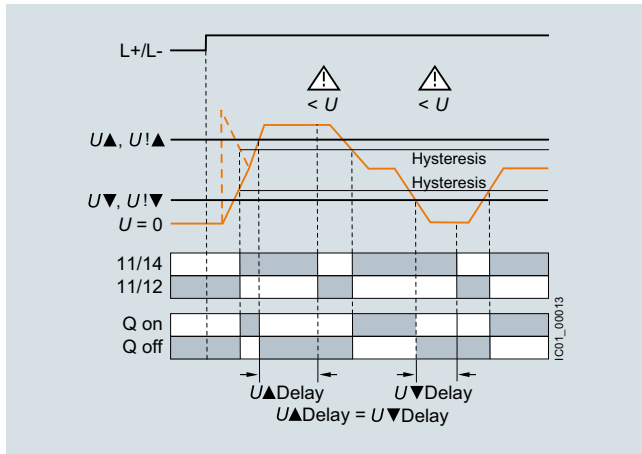

Type	3UG4832	
General technical specifications		
Rated insulation voltage U_i Pollution degree 2 Overvoltage category III acc. to VDE 0110	V	690
Rated impulse withstand voltage U_{imp}	kV	6
Measuring circuit		
Permissible measuring range 1-phase AC/DC voltage	V	10 ... 690
Measuring frequency	Hz	40 ... 500
Setting range 1-phase voltage	V	10 ... 600
Control circuit		
Load capacity of the output relay		
• Thermal current I_{th}	A	5
Rated operational current I_e at		
• AC-15/24 ... 400 V	A	3
• DC-13 at		
- 24 V	A	1
- 125 V	A	0.2
- 250 V	A	0.1
Minimum contact load at 17 V DC	mA	5

Monitoring and control devices

Relays

SIRIUS 3UG48 monitoring relays for stand-alone installation for IO-Link

Voltage monitoring

Selection and ordering data

- Adjustable via IO-Link and locally, with illuminated LCD
- Power supply with 24 V DC via IO-Link or external auxiliary voltage
- Auto or Manual RESET
- Open-circuit or closed-circuit principle
- 1 CO contact, 1 semiconductor output (in SIO mode)



PU (UNIT, SET, M) = 1
 PS* = 1 unit
 PG = 41H



3UG4832-1AA40



3UG4832-2AA40

Measuring range	Adjustable hysteresis	ON-delay time adjustable onDel	Tripping delay time separately adjustable U▲Del/U▼Del	SD	Screw terminals 	SD	Spring-loaded terminals 	
V AC/DC	V	s	s	d	Article No.	Price per PU	Article No.	Price per PU
Monitoring of voltage for overshooting and undershooting								
10 ... 600	0.1 ... 300	0 ... 999.9	0 ... 999.9	2	3UG4832-1AA40	2	3UG4832-2AA40	

For accessories, [see page 10/122](#).

Overview



SIRIUS 3UG4822 monitoring relay

The relays monitor 1-phase AC currents (rms value) and DC currents against the set limit value for overshoot and undershoot.

Benefits

- Variably adjustable to overshoot, undershoot or range monitoring
- Freely configurable delay times and RESET response
- Width 22.5 mm
- Display and transmission of actual value and status messages to controller
- All versions with removable terminals
- All versions with screw or spring-loaded terminals

Application

- Overcurrent and undercurrent monitoring
- Monitoring the functionality of electrical loads
- Monitoring for broken conductors

Technical specifications

3UG4822 monitoring relays

The 3UG4822 current monitoring relays are supplied with power through IO-Link or with an external voltage of 24 V DC and perform overshoot, undershoot or range monitoring of the current depending on the parameterization. The devices are equipped with a display and are parameterized using three buttons.

The measuring range extends from 0.05 to 10 A. For larger AC currents the measuring range can be extended by using commercially available current transformers. Using the adjustable transformer factor, the display of the measured primary currents up to 750 A instead of the secondary currents (max. 1 A or 5 A) is possible.

The rms value of the current is measured. The limit values for overshoot or undershoot can be freely configured within this range. If one of these limit values is reached, the output relay responds according to the set principle of operation as soon as the tripping delay time $I\blacktriangle\text{Del}/I\blacktriangledown\text{Del}$ has elapsed. This time and the ON-delay time onDel are adjustable from 0 to 999.9 s.

The hysteresis is adjustable from 0.01 to 5 A. The device can be operated with Manual or Auto RESET and on the basis of either the open-circuit or closed-circuit principle. You can decide here whether the output relay is to respond when the supply voltage $U_s = \text{ON}$ is applied, or not until the lower measuring range limit of the measuring current ($I > 50 \text{ mA}$) is reached. One output changeover contact is available as a signaling contact, and a semiconductor output is available in addition in SIO mode.

If Manual RESET is selected in the menu (Memory = Yes), the switching relay remains in its current switching state and the current measured value and the symbol for undershooting and overshooting continue to flash, even when the measured variable reaches a permissible value again. This stored fault status can be reset by simultaneously pressing the UP \blacktriangle and DOWN \blacktriangledown keys for 2.5 s.

With Manual RESET through IO-Link it is possible in addition to set whether fault messages are to be deleted when the control supply voltage is switched off and on (as Remote RESET) or whether the signals are to be permanently saved even in a voltage failure, with confirmation possible only through local RESET or via IO-Link.

With the closed-circuit principle selected upon application of the control supply voltage

Current overshoot

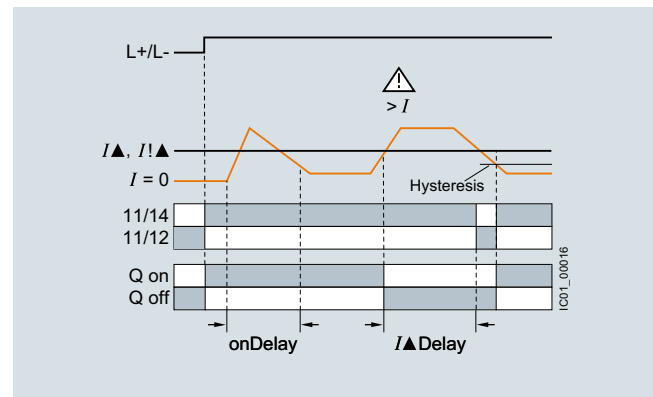

Current undershoot

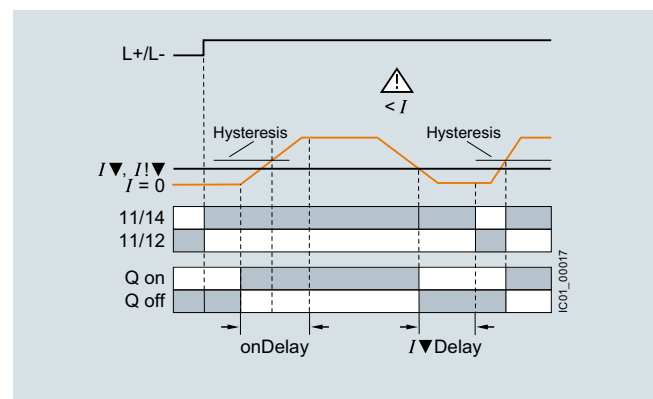

Monitoring and control devices

Relays

SIRIUS 3UG48 monitoring relays for stand-alone installation for IO-Link

Current monitoring

With the closed-circuit principle selected
upon application of the control supply voltage

Range monitoring

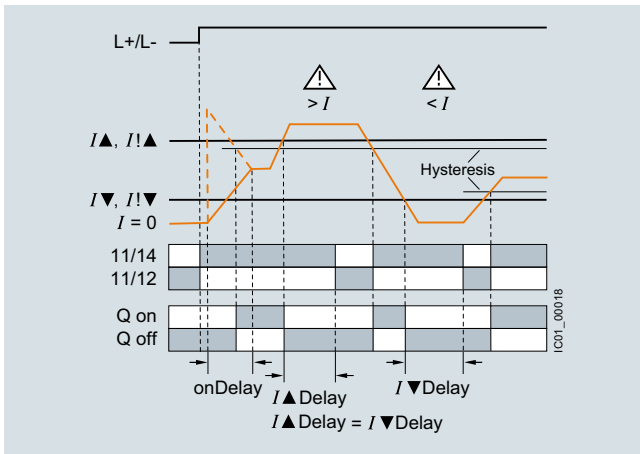

Type	3UG4822	
General technical specifications		
Rated insulation voltage U_i Pollution degree 2 Overvoltage category III acc. to VDE 0110	V	690
Rated impulse withstand voltage U_{imp}	kV	6
Measuring circuit		
Measuring range for 1-phase AC/DC current	A	0.05 ... 15
Measuring frequency	Hz	40 ... 500
Setting range for 1-phase current	A	0.05 ... 10
Load supply voltage	V	Max. 300 (with protective separation) Max. 500 (with simple separation)
Control circuit		
Load capacity of the output relay • Thermal current I_{th}	A	5
Rated operational current I_e at • AC-15/24 ... 400 V • DC-13 at	A	3
- 24 V	A	1
- 125 V	A	0.2
- 250 V	A	0.1
Minimum contact load at 17 V DC	mA	5

Selection and ordering data

- Adjustable via IO-Link and locally, with illuminated LCD
- Power supply with 24 V DC via IO-Link or external auxiliary voltage
- Adjustable transformer factor to display the measured primary current when an external current transformer is used
- Auto or Manual RESET
- Open-circuit or closed-circuit principle
- 1 CO contact, 1 semiconductor output (in SIO mode)



PU (UNIT, SET, M) = 1
 PS* = 1 unit
 PG = 41H



3UG4822-1AA40



3UG4822-2AA40

Measuring range	Adjustable hysteresis	ON-delay time adjustable onDel	Tripping delay time separately adjustable $I\Delta$ Del/ $I\nabla$ Del	SD	Screw terminals 	SD	Spring-loaded terminals 		
A AC/DC	A	s	s	d	Article No.	Price per PU	d	Article No.	Price per PU
Monitoring of current for overshooting and undershooting									
0.05 ... 10	0.01 ... 5	0.1 ... 999.9	0.1 ... 999.9	2	3UG4822-1AA40		2	3UG4822-2AA40	

For accessories, [see page 10/122](#).

For AC currents $I > 10$ A it is possible to use commercially available current transformers, e.g. the Siemens 4NC current transformers, as accessories, [see Catalog LV 10](#).

Monitoring and control devices

Relays

SIRIUS 3UG48 monitoring relays for stand-alone installation for IO-Link

Power factor and active current monitoring

Overview



SIRIUS 3UG4841 monitoring relay

The 3UG4841 power factor and active current monitoring devices enable the load monitoring of motors.

Whereas power factor (p.f.) monitoring is used above all for monitoring no-load operation, the active current monitoring option can be used to observe and evaluate the load factor over the entire torque range.

Benefits

- Monitoring of even small 1-phase motors with a no-load supply current below 0.5 A
- Simple determination of threshold values by directly referencing measured variables to motor loading
- Range monitoring and active current measurement enable detection of cable breaks between control cabinets and motors, as well as phase failures
- Power factor (p.f.) and/or I_{res} (active current) can be selected as the measurement principle
- Width 22.5 mm
- Display and transmission of actual value and status messages to controller
- All versions with removable terminals
- All versions with screw or spring-loaded terminals

Application

- No-load monitoring and load shedding, such as in the event of a V-belt tear
- Underload monitoring in the low-end performance range, e.g. in the event of pump no-load operation
- Monitoring of overload, e.g. due to a dirty filter system
- Power factor monitoring in networks for control of compensation equipment
- Broken cable between control cabinet and motor

Technical specifications

3UG4841 monitoring relays

3UG4841 monitoring relays are supplied with power through IO-Link or with an external auxiliary voltage of 24 V DC and are used for performing overshoot, undershoot or range monitoring of the power factor and/or the resulting active current, depending on parameterization. The load to be monitored is connected upstream of the IN terminal. The load current flows through the terminals IN and Ly/N. The setting range for the power factor is 0 to 0.99 and for the active current I_{res} it is 0.2 to 10 A. If the control supply voltage is switched on and no load current flows, the display will show $I < 0.2$ and a symbol for overshoot, undershoot or range monitoring. If the motor is now switched on and the current exceeds 0.2 A, the set ON-delay time onDel begins. During this time, if the set limit values are undershot or exceeded, this does not lead to a relay reaction of the changeover contact. If the operational flowing active current and/or the p.f. value falls below or exceeds the respective set threshold value, the tripping delay time begins. When this time has expired, the relay changes its switch position. The relevant measured variables for overshooting and undershooting in the display flash. If monitoring for active current undershoot is switched off ($I_{res} \nabla = \text{OFF}$), and if the load current undershoots the lower measuring range threshold (0.2 A), the CO contacts remain unchanged. If a threshold value is set for the monitoring of active current undershooting, then undershooting of the measuring range threshold (0.2 A) will result in a response of the CO contacts.

The relay operates either according to the open-circuit or closed-circuit principle.

If the device is set to Auto RESET (Memory = No), depending on the set principle of operation, the switching relay returns to its initial state and the flashing ends when the hysteresis threshold is reached.

If Manual RESET is selected in the menu (Memory = Yes), the switching relay remains in its current switching state and the current measured value and the symbol for undershooting and overshooting continue to flash, even when the measured variable reaches a permissible value again. This stored fault status can be reset by simultaneously pressing the UP▲ and DOWN▼ keys for 2.5 s.

With Manual RESET through IO-Link it is possible in addition to set whether fault messages are to be deleted when the control supply voltage is switched off and on (as Remote RESET) or whether the signals are to be permanently saved even in a voltage failure, with confirmation possible only through local RESET or via IO-Link.

With the closed-circuit principle selected

Response in the event of undershooting the measuring range limit with activated monitoring of I_{res}

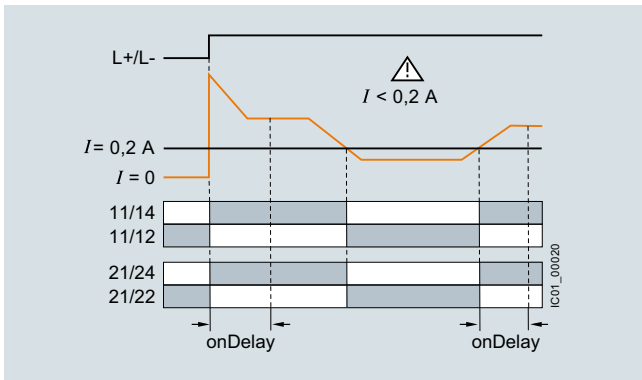

Overshooting of active current

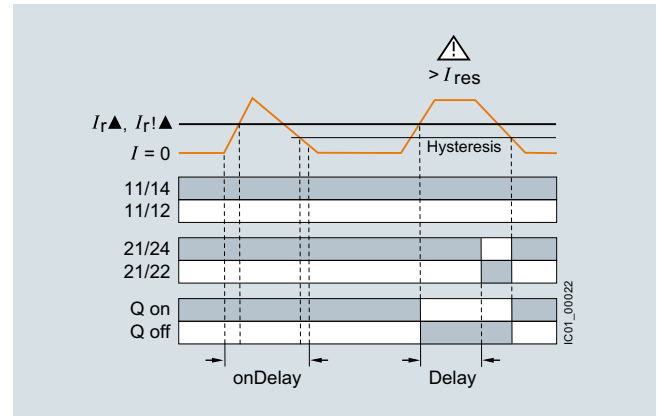

Response in the event of undershooting the measuring range limit with deactivated monitoring of active current undershooting

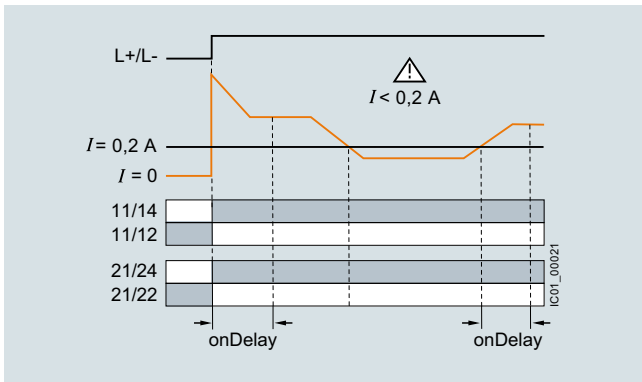

Undershooting of active current

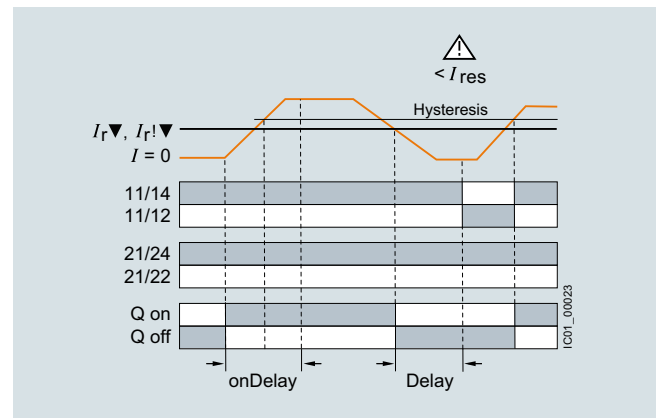

Range monitoring of active current

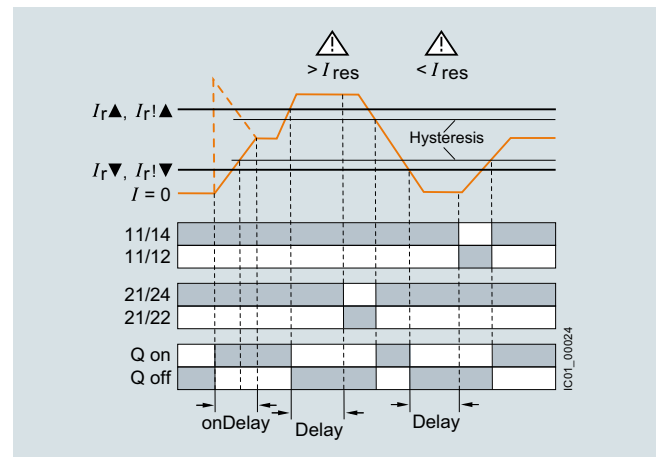

Monitoring and control devices

Relays

SIRIUS 3UG48 monitoring relays for stand-alone installation for IO-Link

Power factor and active current monitoring

With the closed-circuit principle selected

Overshooting of power factor

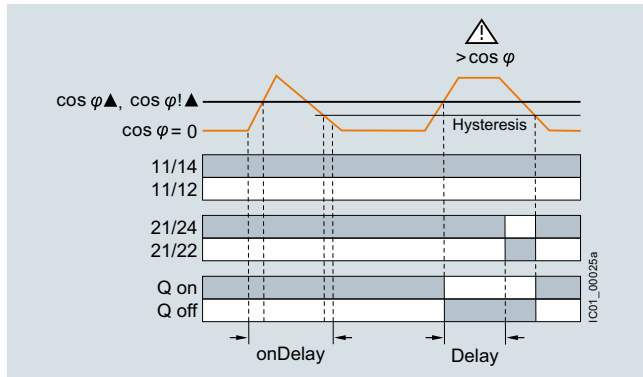

Undershooting of power factor

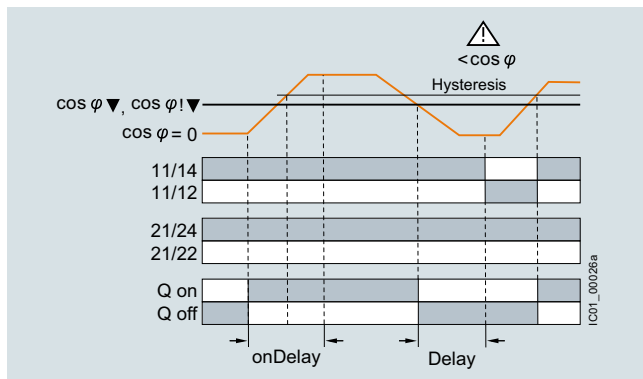

Range monitoring of power factor

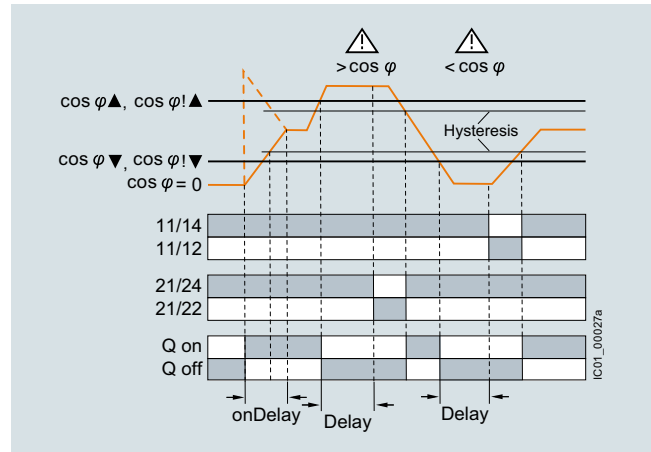

Type	3UG4841	
General technical specifications		
Rated insulation voltage U_i	V	690
Pollution degree 2 Overvoltage category III according to IEC 60664-1		
Rated impulse withstand voltage U_{imp}	kV	6
Control circuit		
Number of CO contacts for auxiliary contacts		2
Load capacity of the output relay		
• Thermal current I_{th}	A	5
Rated operational current I_o at		
• AC-15/24 ... 400 V	A	3
• DC-13 at		
- 24 V	A	1
- 125 V	A	0.2
- 250 V	A	0.1
Minimum contact load at 17 V DC	mA	5

Selection and ordering data

- For monitoring the power factor and the active current I_{res} (p.f. $\times I$)
- Suitable for 1-phase and 3-phase currents
- Adjustable via IO-Link and locally, with illuminated LCD
- Power supply with 24 V DC via IO-Link or external auxiliary voltage
- Overshoot, undershoot or range monitoring adjustable
- Upper and lower limit values can be adjusted separately
- Permanent display of actual value and tripping state
- 1 CO contact each for undershoot and overshoot, 1 semiconductor output (in SIO mode)

PU (UNIT, SET, M) = 1
 PS* = 1 unit
 PG = 41H



3UG4841-1CA40



3UG4841-2CA40

Measuring range		Voltage range of the measuring voltage ¹⁾ 50/60 Hz AC	Hysteresis		ON-delay time adjustable onDel	Tripping delay time separately adjustable U▲Del/ U▼Del, φ▲Del/ φ▼Del	SD	Screw terminals		SD	Spring-loaded terminals	
For power factor	For active current I_{res}		Adjustable for power factor	Adjustable for active current I_{res}				Article No.	Price per PU		Article No.	Price per PU
P.f.	A	V	P.f.	A	s	s	d					
Monitoring of power factor and active current for overshooting or undershooting												
0.1 ... 0.99	0.2 ... 10	90 ... 690	0.1 ... 0.2	0.1 ... 3	0 ... 999.9	0 ... 999.9	2	3UG4841-1CA40	2	3UG4841-2CA40		

¹⁾ Absolute limit values.

For accessories, see [page 10/122](#).

For AC active currents $I_{res} > 10$ A it is possible to use commercially available current transformers, e.g. Siemens 4NC current transformers, as accessories, see [Catalog LV 10](#).

Monitoring and control devices

Relays

SIRIUS 3UG48 monitoring relays for stand-alone installation for IO-Link

Residual-current monitoring > Residual-current monitoring relays

Overview

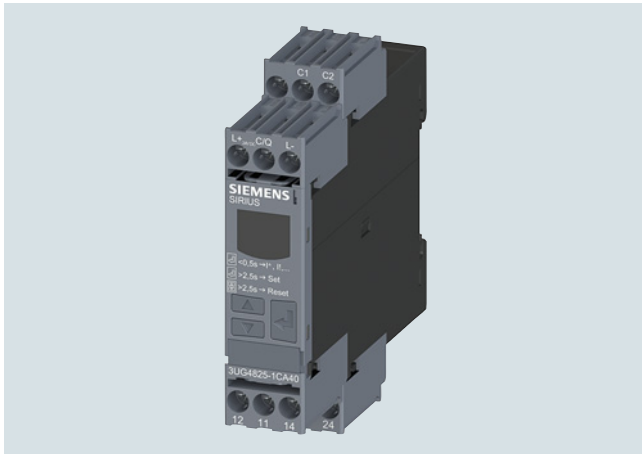

SIRIUS 3UG4825 monitoring relay

The 3UG4825 residual-current monitoring relays are used in conjunction with the 3UL23 residual-current transformers for monitoring plants in which higher residual currents are increasingly expected due to ambient conditions. Monitoring encompasses pure AC residual currents or AC residual currents with a pulsating DC fault current component (transformer type A in accordance with DIN VDE 0100-530/IEC TR 60755).

Benefits

- High measuring accuracy of $\pm 7.5\%$
- Permanent self-monitoring
- Parameterization of the devices locally or via IO-Link possible
- Variable threshold values for warning and disconnection
- Freely configurable delay times and RESET response
- Display and transmission of actual value and status messages to controller
- High level of flexibility and space saving through installation of the transformer inside or outside the control cabinet
- Width 22.5 mm
- All versions with removable terminals
- All versions with screw or spring-loaded terminals

Application

Monitoring of plants in which residual currents can occur, e.g. due to dust deposits or moisture, porous cables and leads, or capacitive residual currents.

Technical specifications

3UG4825 monitoring relays

The main conductor, and any neutral conductor to which a load is connected, are routed through the opening of the toroidal core of a residual-current transformer. A secondary winding is placed around this toroidal core to which the monitoring relay is connected.

If operation of a plant is fault-free, the sum of the inflowing and outward currents equals zero. No current is then induced in the secondary winding of the residual-current transformer.

However, if an insulation fault occurs, the sum of the inflowing currents is greater than that of the outward currents. The differential current – i.e. the residual current – induces a secondary current in the secondary winding of the transformer. This current is evaluated in the monitoring relay and is used on the one hand to display the actual residual current and on the other, to switch the relay if the set warning or tripping threshold is overshot.

If the measured residual current exceeds the set warning value, the associated changeover contact instantly changes the switching state and an indication appears on the display.

If the measured residual current exceeds the set tripping value, the set delay time begins and the associated relay symbol flashes. On expiry of this time, the associated changeover contact changes the switching state.

ON-delay time for motor start

To be able to start a drive when a residual current is detected, the output relays switch to the OK state for an adjustable ON-delay time depending on the selected open-circuit or closed-circuit principle.

The changeover contacts do not react if the set threshold values are overshoot during this period.

With the closed-circuit principle selected

Residual-current monitoring with Auto RESET (Memory = no)

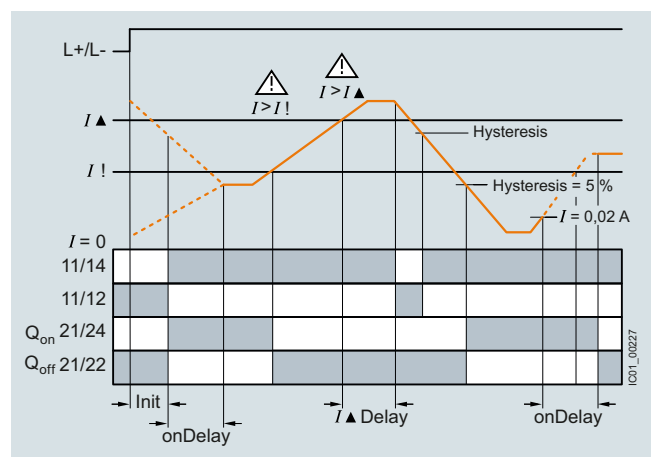

If the device is set to Auto RESET, the relay switches back to the OK state for the tripping value after tripping once the value falls below the set hysteresis threshold and the display stops flashing.

The associated relay changes its switching state if the value falls below the fixed hysteresis value of 5% of the warning value.

Any overshoots are therefore not stored.

Residual-current monitoring with Manual RESET (Memory = yes)

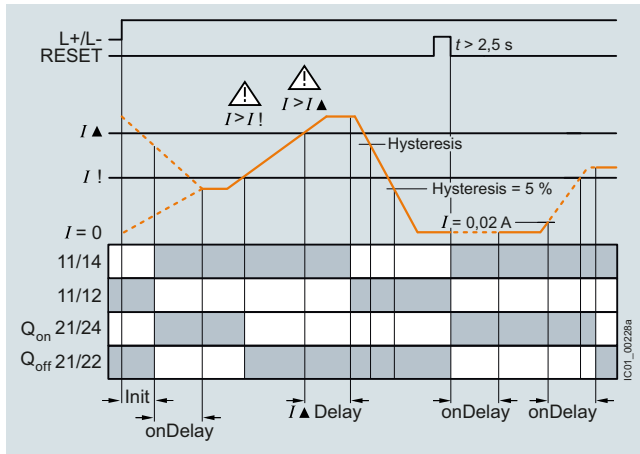

If Manual RESET is selected in the menu, the output relays remain in their current switching state and the current measured value and the symbol for overshooting continue to flash, even when the measured residual current returns to a permissible value. This stored fault status can be reset by simultaneously pressing the UP▲ and DOWN▼ keys for > 2 seconds, or by switching the supply voltage off and back on again.

Note:

The neutral conductor must not be grounded downstream of the summation current transformer as this may impair the function of the residual-current monitoring device.

Type	3UG4825-1CA40, 3UG4825-2CA40	
General data		
Insulation voltage for overvoltage category III acc. to IEC 60664 for pollution degree 3, rated value	V	300
Impulse withstand voltage, rated value U_{imp}	kV	4
Control circuit		
Number of CO contacts for auxiliary contacts		2
Thermal current of the non-solid-state contact blocks, maximum	A	5
Current-carrying capacity of the output relay		
• At AC-15 at 250 V at 50/60 Hz	A	3
• At DC-13		
- At 24 V	A	1
- At 125 V	A	0.2
- At 250 V	A	0.1
Operational current at 17 V, minimum	mA	5

Monitoring and control devices

Relays

SIRIUS 3UG48 monitoring relays for stand-alone installation for IO-Link

Residual-current monitoring > Residual-current monitoring relays

Selection and ordering data

- For monitoring residual currents from 0.03 to 40 A, from 16 to 400 Hz
- For 3UL23 residual-current transformers with feed-through opening from 35 to 210 mm
- Permanent self-monitoring
- Certified in accordance with IEC 60947, functionality corresponds to IEC 62020
- Digitally adjustable, with illuminated LCD
- Permanent display of actual value and tripping state
- Separately adjustable limit value and warning threshold
- 1 changeover contact each for warning threshold and tripping threshold



PU (UNIT, SET, M) = 1
 PS* = 1 unit
 PG = 41H



3UG4825-1CA40



3UG4825-2CA40

Measurable current	Adjustable response value current	Switching hysteresis	Adjustable ON-delay time	Control supply voltage At DC, rated value	SD	Screw terminals 		Spring-loaded terminals 	
						Article No.	Price per PU	Article No.	Price per PU
A	A	%	s	V	d				
0.01 ... 43	0.03 ... 40	0 ... 50	0 ... 999.9	24	2	3UG4825-1CA40		3UG4825-2CA40	

For accessories, see page 10/122.

For 3UL23 residual-current transformers and accessories for 3UL23, see page 10/88.

Overview

SIRIUS 3UG4851 monitoring relay

3UG4851 monitoring relays are used in combination with a sensor to monitor drives for overspeed and/or underspeed.

Furthermore, the monitoring relays are ideal for all functions where a continuous pulse signal needs to be monitored (e.g. belt travel monitoring, completeness monitoring, passing monitoring, clock-time monitoring).

Benefits

- Variably adjustable to overshoot, undershoot or range monitoring
- Freely configurable delay times and RESET response
- Display and transmission of actual value and fault type to controller
- Use of up to 10 sensors per rotation for extremely slowly rotating motors
- Two- or three-wire sensors and sensors with a mechanical switching output or solid-state output can be connected
- Auxiliary voltage for sensor integrated
- All versions with removable terminals
- All versions with screw or spring-loaded terminals

Application

- Slip or tear of a belt drive
- Overload monitoring
- Transport monitoring for completeness

Technical specifications**3UG4851 monitoring relays**

The speed monitoring relay operates according to the principle of period duration measurement.

In the monitoring relay, the time between two successive rising edges of the pulse encoder is measured and compared to the minimum and/or maximum permissible period duration calculated from the set limit values for the speed.

Thus, the period duration measurement recognizes any deviation in speed after just two pulses, even at very low speeds or in the case of extended pulse gaps.

By using up to ten pulse encoders evenly distributed around the circumference, it is possible to shorten the period duration, and in turn the response time. By taking into account the number of sensors in the monitoring relay, the speed continues to be indicated in rpm.

ON-delay time for motor start

To be able to start a motor drive, and depending on whether the open-circuit or closed-circuit principle is selected, the output relay switches to the OK state during the ON-delay time, even if the speed is still below the set value.

The ON-delay time is started by either switching on the auxiliary voltage or, if the auxiliary voltage is already applied, by actuating the respective NC contact (e.g. auxiliary contact).

Speed monitoring with Auto RESET (Memory = no)

If the device is set to Auto RESET, the output relay switches to the OK state, once the adjustable hysteresis threshold is reached in the range of 1 to 99.9 rpm and the flashing stops. Any overshoots or undershoots are therefore not stored.

Speed monitoring with Manual RESET (Memory = yes)

If Manual RESET is selected in the menu, the output relay remains in its current switching state and the current measured value and the symbol for overshooting/undershooting continue to flash, even when the speed returns to a permissible value. This stored fault status can be reset by simultaneously pressing the UP▲ and DOWN▼ buttons for > 2.5 s or by connecting the RESET device terminal to 24 V DC.

With Manual RESET through IO-Link it is possible in addition to set whether fault messages are to be deleted when the control supply voltage is switched off and on (as Remote RESET) or whether the signals are to be permanently saved even in a voltage failure, with confirmation possible only through local RESET, the Remote RESET contact, or via IO-Link.

Monitoring and control devices

Relays

SIRIUS 3UG48 monitoring relays for stand-alone installation for IO-Link

Speed monitoring

With the closed-circuit principle selected

Range monitoring without enable input

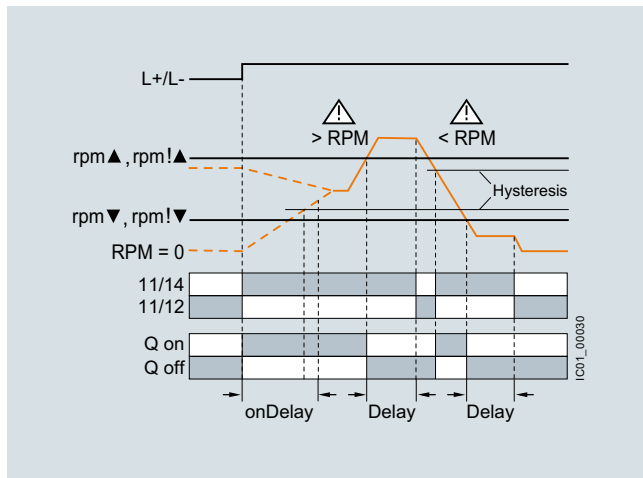

Range monitoring with enable input

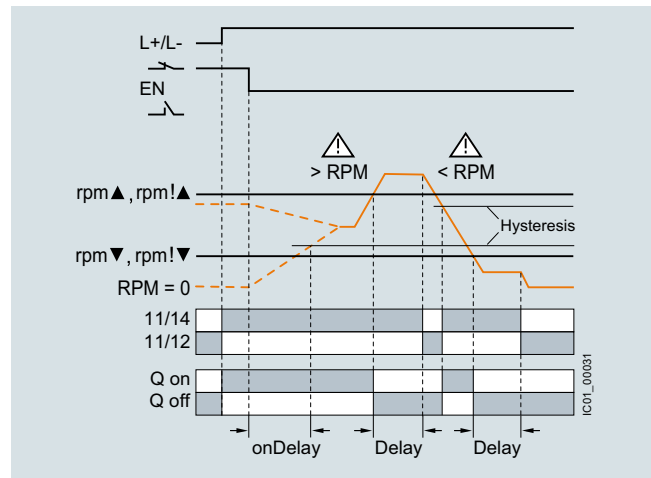

Type	3UG4851	
General technical specifications		
Rated insulation voltage U_i Pollution degree 2 Overvoltage category III acc. to VDE 0110	V	300
Rated impulse withstand voltage U_{imp}	kV	4
Measuring circuit		
Sensor supply • For three-wire sensor (24 V/0 V) • For two-wire NAMUR sensor (8V2)	mA	Max. 50 Max. 8.2
Signal input • IN1 • IN2	kΩ kΩ	16, three-wire sensor, pnp operation 1, floating contact, two-wire NAMUR sensor
Voltage level • For level 1 at IN1 • For level 0 at IN1	V V	4.5 ... 30 0 ... 1
Current level • For level 1 at IN2 • For level 0 at IN2	mA mA	> 2.1 < 1.2
Minimum pulse duration of signal	ms	5
Minimum interval between 2 pulses	ms	5
Control circuit		
Number of CO contacts for auxiliary contacts		1
Load capacity of the output relay Thermal current I_{th}	A	5
Rated operational current I_e at • AC-15/24 ... 250 V • DC-13 at - 24 V - 125 V - 250 V	A A A A	3 1 0.2 0.1
Minimum contact load at 17 V DC	mA	5

Selection and ordering data

- For speed monitoring in revolutions per minute (rpm)
- Two- or three-wire sensor with mechanical or electronic switching output can be connected
- Two-wire NAMUR sensor can be connected
- Sensor supply 24 V DC/50 mA integrated
- Input frequency 0.1 to 2 200 pulses per minute (0.0017 to 36.7 Hz)
- With or without enable signal for the drive to be monitored
- Adjustable via IO-Link and locally, with illuminated LCD
- Power supply with 24 V DC via IO-Link or external auxiliary voltage
- Overshoot, undershoot or range monitoring adjustable
- Number of pulses per revolution can be adjusted
- Upper and lower limit values can be adjusted separately
- Auto, Manual or Remote RESET options after tripping
- Permanent display of actual value and tripping state
- 1 CO contact, 1 semiconductor output (in SIO mode)



PU (UNIT, SET, M) = 1
 PS* = 1 unit
 PG = 41H



3UG4851-1AA40



3UG4851-2AA40

Measuring range	Adjustable hysteresis	ON-delay time adjustable onDel	Tripping delay time separately adjustable rpm▲Del/rpm▼Del	Pulses per revolution	SD	Screw terminals 	SD	Spring-loaded terminals 		
rpm	rpm	s	s		d	Article No.	Price per PU	d	Article No.	Price per PU
Speed monitoring for overshooting and undershooting										
0.1 ... 2 200	OFF 1 ... 99.9	0 ... 999.9	0 ... 999.9	1 ... 10	2	3UG4851-1AA40		2	3UG4851-2AA40	

For accessories, see page 10/122.





Monitoring and control devices

Relays

SIRIUS 3UG48 monitoring relays for stand-alone installation for IO-Link

Accessories

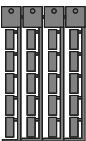
Selection and ordering data

Use	Version	SD	Article No.	Price per PU	PU (UNIT, SET, M)	PS*	PG
Accessories for enclosures							
	For 3UG48	Sealable covers For securing against unauthorized adjustment of setting knobs	5	3RP1902		1	5 units 41H
3RP1902							
	For 3UG48	Push-in lugs For screw fixing, 2 units are required for each device	5	3RP1903		1	10 units 41H
3RP1903							
Blank labels							
	For 3UG48	Unit labeling plates ¹⁾ For SIRIUS devices • 20 mm x 7 mm, titanium gray	20	3RT2900-1SB20		100	340 units 41B
3RT2900-1SB20							
	For 3UG48	Adhesive labels For SIRIUS devices, 19 mm x 6 mm, titanium gray	5	3RT2900-1SB60		100	3060 units 41B
Tools for opening spring-loaded terminals							
	For auxiliary circuit connections	Screwdrivers For all SIRIUS devices with spring-loaded terminals Length approx. 200 mm, 3.0 mm x 0.5 mm, titanium gray/black, partially insulated	2	Spring-loaded terminals 			
3RA2908-1A				3RA2908-1A		1	1 unit 41B
Software							
	For 3UG48	SIRIUS Asset Monitor The MindSphere app enables access to the SIRIUS 3UG48 monitoring relays anytime and anywhere and provides detailed information about the device status and fault messages and warnings, see page 14/26.					

¹⁾ PC labeling system for individual inscription of unit labeling plates available from: murrplastik Systemtechnik GmbH, [see page 16/16.](#)

Overview

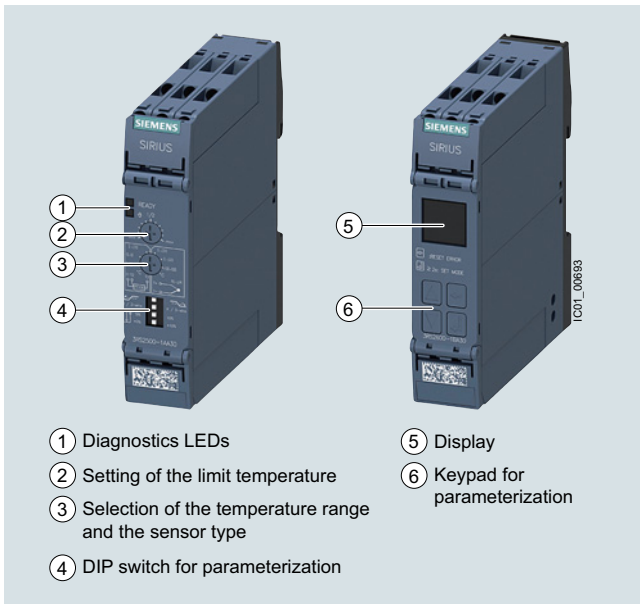

- ① Diagnostics LEDs
- ② Setting of the limit temperature
- ③ Selection of the temperature range and the sensor type
- ④ DIP switch for parameterization
- ⑤ Display
- ⑥ Keypad for parameterization

SIRIUS 3RS2 temperature monitoring relays

More information

Homepage, see www.siemens.com/sirius-monitoring-relays

Industry Mall, see www.siemens.com/product?3RS2

Conversion tool, see www.siemens.com/conversion-tool

The 3RS2 temperature monitoring relays can be used to measure temperatures in solid, liquid and gas media. The temperature is acquired by means of sensors in the medium, evaluated by the device and monitored for overshoot, undershoot or location within a specified range (window function).

The family comprises an analog multi-function device which can be set using DIP switches and potentiometers, and digital devices which can be parameterized via an intuitive LC display. The digital device is also available as a version with IO-Link.

All 3RS26 digital devices, including the 3RS28 versions with IO-Link, have safety certification according to IEC 61508/62061 or ISO 13849 up to SIL 1/PL c as well as EN 14597 for heat generating systems and EN 50156 for burners.

Furthermore, the functionality of the 3RS26/3RS28 digital devices can be expanded using a 3RS29 sensor expansion module with two additional resistance sensors, e.g. for monitoring 3-phase motors or transformers.

The 3RS29 sensor expansion module also features an additional relay for outputting the sensor status, and an additional analog input 4 to 20 mA. This analog input allows ATEX applications to be implemented when using an intrinsically safe temperature sensor or other appropriate type of protection. The 3RS29 is connected wirelessly via a SIL 1-certified infrared communication interface.

Notes:

The SIRIUS 3RS2 temperature monitoring relays fully replace the 3RS1 predecessor. The large number of 3RS1 analog devices can simply be replaced with the new 3RS25 analog multi-function device. The reduced variety of order numbers means the successors can be selected quickly and easily.

The 3RS2 digital devices fully supersede the functionality of the 3RS1 predecessor in a single device type that is now able to use resistance sensors and thermocouples – all at half the width of 22.5 mm instead of 45 mm.

Analog multi-function devices



SIRIUS 3RS25 analog multi-function device

The analog multi-function device is parameterized using DIP switches and potentiometers. The device can be used to monitor a sensor with a limit value for overshoot or undershoot. The most common temperature ranges with Pt100 resistance sensors or type J or K thermocouples can be used for this purpose. This device can therefore also be used as a compact, easy-to-adjust two-point controller. The relay CO contact output enables loads to be switched directly. The NC contact can optionally be used as a signaling contact.

Digital devices (1 sensor)



SIRIUS 3RS26 digital device (1 sensor) with 3RS29 sensor expansion module

The SIRIUS 3RS26 digital device with display enables sensors with two limit values to be monitored using all common resistance sensors and thermocouples.

Monitoring and control devices

Relays

SIRIUS 3RS2 temperature monitoring relays

General data

The additional limit value means that, in addition to overshoot and undershoot, an additional warning value can be output to the relay outputs. Alternatively, the second monitoring value can also be used to implement range monitoring. The digital devices can thus also be used as compact two or three-step controllers, with Manual RESET or Remote RESET.

Thanks to safety certification, this device can be used in a wide range of applications.

The functionality of the SIRIUS 3RS26 and 3RS28 digital devices can be expanded wirelessly with the sensor expansion module via a SIL 1-certified infrared communication interface. This combination then features three sensors and is designed for monitoring large 3-phase motors and transformers. It goes without saying that the additional sensors can also be used for other applications.

Digital devices (1 sensor) for IO-Link



SIRIUS 3RS28 digital device (1 sensor) for IO-Link with 3RS29 sensor expansion module

The 3RS28 digital temperature monitoring relays for IO-Link feature an IO-Link communication interface in addition to a display. They include all functions of the 3RS26 digital device and can also be operated on L+/L- as a stand-alone installation with 24 V DC.

Note:

The IO-Link devices can be reset on the display or via IO-Link.

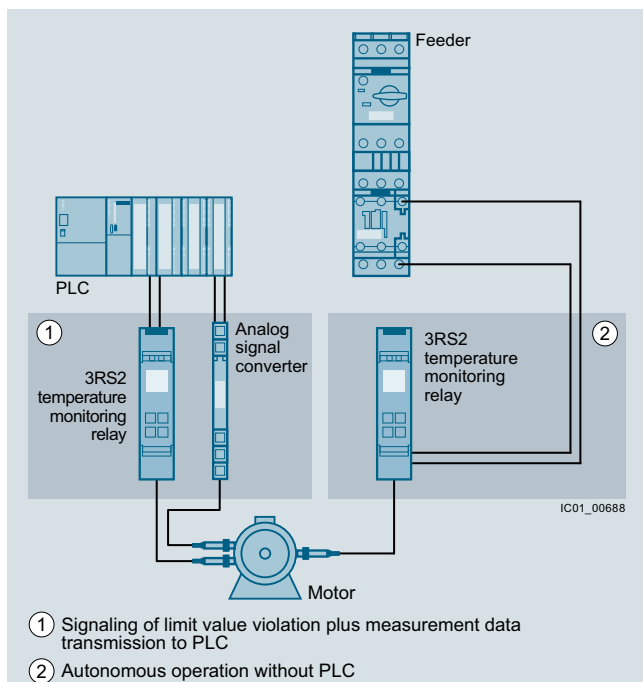

Conventional temperature monitoring relays

Notes:

Devices required for communication via IO-Link:

- Any controller that supports IO-Link (e.g. ET 200SP with CPU or S7-1200), see [Catalog ST 70](#).
- IO-Link master (e.g. CM 4xIO-Link for SIMATIC ET 200SP, see [page 2/98](#) or SM 1278 for S7-1200, see [page 2/97](#)).

Each monitoring relay requires an IO-Link channel.

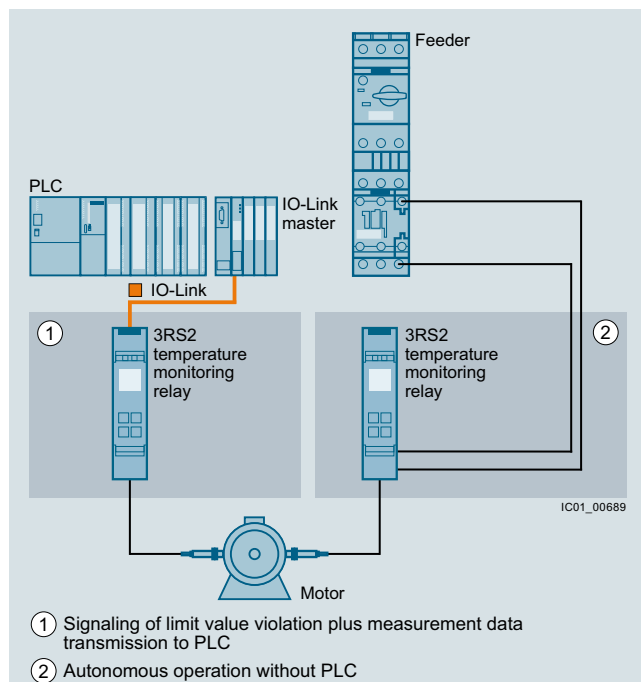

Temperature monitoring relays for IO-Link

Notes on security

In order to protect plants, systems, machines and networks against cyber threats, it is necessary to implement – and continuously maintain – a holistic, state-of-the-art industrial security concept. Siemens products and solutions represent only one component of such a concept.

For more information about the subject of Industrial Security, see www.siemens.com/industrialsecurity.

Article No. scheme

Product versions		Article number	
Temperature monitoring relays		3RS2	<input type="checkbox"/> 0 <input type="checkbox"/> 0 - <input type="checkbox"/> <input type="checkbox"/> <input type="checkbox"/> <input type="checkbox"/> 0
Device type	e.g. 5 = analogically adjustable	<input type="checkbox"/>	
Connection type	Screw terminals		1
	Spring-loaded terminals (push-in)		2
Number of CO contacts	e.g. A = 1 CO contact, B = 2 CO contacts	<input type="checkbox"/>	
Rated control supply voltage	A = 24 V AC/DC, W = 24 ... 240 V AC/DC		<input type="checkbox"/>
Type of rated control supply voltage	3 = AC/DC, 4 = DC		<input type="checkbox"/>
Example		3RS2	5 0 0 - 1 A A 3 0

Note:

The Article No. scheme shows an overview of product versions for better understanding of the logic behind the article numbers. For your orders, please use the article numbers quoted in the selection and ordering data.

Benefits

- Customary screw and spring-loaded terminals for quick and reliable wiring
- Reduced space requirement in the control cabinet thanks to a consistent width of 22.5 mm
- Easy parameterization thanks to new display and intuitive operating concept
- Reduced stock keeping and logistics thanks to heavily reduced device variance
- Cost savings thanks to additional scalable functionality with integrated infrared interface
- Communication via IO-Link for 3RS28
- Global applicability and exportability thanks to compliance with international standards and certifications
- Problem-free use in a wide range of applications thanks to Safety bundle with certification according to SIL 1/PL c, ATEX, EN 14597 for heat generating systems and EN 50156 for burners
- All versions with removable terminals
- All versions with screw or spring-loaded terminals with push-in functionality

Application

The SIRIUS 3RS2 temperature monitoring relays can be used in almost any application in which temperature overshoot or undershoot is not permitted, e.g. in the monitoring of set temperature limits and the output of alarm messages for:

- Simple and compact two-point control
- Motor and system protection
- Control cabinet temperature monitoring
- Freeze monitoring
- Temperature limits for process variables e.g. in the packaging industry or electroplating
- Controlling equipment and machines such as heating, climate and ventilation systems, solar collectors, heat pumps or warm water supplies
- Motor, bearing and gear oil monitoring
- Monitoring of coolants

Additionally for digital devices

- Simple and compact two-point or three-point control
 - Burner acc. to EN 50156
 - Temperature monitors or temperature limiters¹⁾ according to EN 14597
 - ATEX explosion protection according to EN 50495
- ¹⁾ A 3RS29 sensor expansion module with an additional sensor is required for the function as a temperature limiter.

Monitoring and control devices

Relays

SIRIUS 3RS2 temperature monitoring relays

General data

Technical specifications

More information

Technical specifications, see <https://support.industry.siemens.com/cs/ww/en/ps/25719/td>

Equipment Manual and internal circuit diagrams, see <https://support.industry.siemens.com/cs/ww/en/ps/25719/man>

FAQs, see <https://support.industry.siemens.com/cs/ww/en/ps/25719/faq>

Connection of resistance-type thermometers

Two-wire measurement

When two-wire temperature sensors are used, the resistances of the sensor and wiring are added. The resulting systematic error must be taken into account when the evaluation unit is calibrated. A jumper must be clamped between terminals T2 and T3 for this purpose.

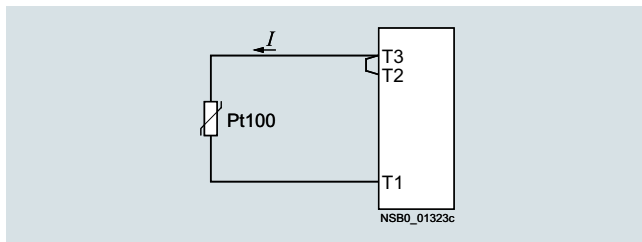

Wiring errors

The errors that are generated by the wiring comprise approximately 2.5 K/Ω. If the resistance of the cable is not known and cannot be measured, the wiring errors can also be estimated using the following table.

Temperature drift dependent on the length and cross-section of the cable with Pt100 sensors and an ambient temperature of 20 °C, in K:

Cable length in m	Cross-section mm ²			
	0.5	0.75	1	1.5
	Temperature drift in K:			
0	0	0	0	0
10	1.8	1.2	0.9	0.6
25	4.5	3.0	2.3	1.5
50	9.0	6.0	4.5	3.0
75	13.6	9.0	6.8	4.5
100	18.1	12.1	9.0	6.0
200	36.3	24.2	18.1	12.1
500	91.6	60.8	45.5	30.2

Example: On a Pt100 sensor with a cable length of 10 m and a conductor cross-section of 1 mm² the temperature drift equals 0.9 K.

Three-wire measurement

To minimize the effects of the line resistances, a three-wire circuit is often used. Using the additional cable, two measuring circuits can be formed of which one is used as a reference. The evaluation unit can then automatically calculate the line resistance and take it into account.

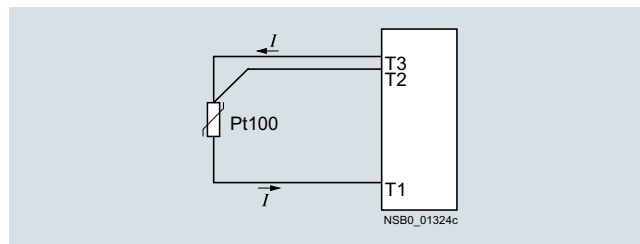

Connection of thermocouples

Based on the thermo-electrical effect, a differential temperature measurement will be performed between the measuring point and the evaluation unit.

This principle assumes that the evaluation unit knows the temperature at the clamping point (T2). For this reason, the 3RS2 temperature monitoring relays have an integral reference point compensation that determines this comparison temperature and builds it into the result of the measurement. The thermal sensors and cables must therefore be insulated.

The absolute temperature is therefore calculated from the ambient temperature of the evaluation unit and the temperature difference measured by the thermocouple.

Temperature detection is therefore possible (T1) without needing to know the precise ambient temperature of the clamping point at the evaluation unit (T2).

The connection cable is only permitted to be extended using compensating lines that are made from the same material as the thermocouple. If a different type of conductor is used, an error will result in the measurement.

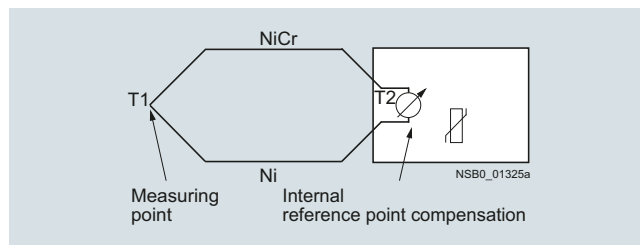

For more information, see <https://www.ephy-mess.com/en>

Principle of operation

Once the temperature has reached the set threshold value ϑ_1 , the K1 output relay changes its switching state as soon as the set time t has elapsed (K2 responds in the same manner to ϑ_2). The delay time can only be adjusted with digital units (on analog units $t = 0$).

When Auto RESET (AUTO RST) is set, the relays return to their original state as soon as the temperature reaches the set hysteresis value.

The memory function (MEMORY) allows the status to be saved even in the event of a voltage failure.

3RS25 analog multi-function devices

Temperature overshoot

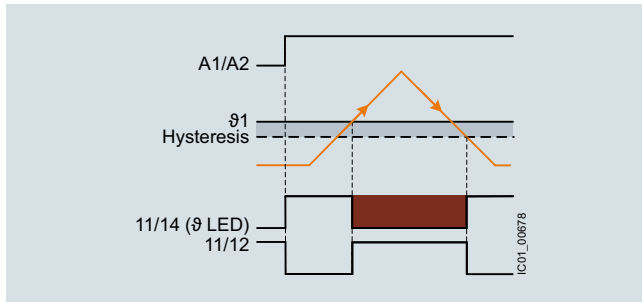

Temperature undershoot

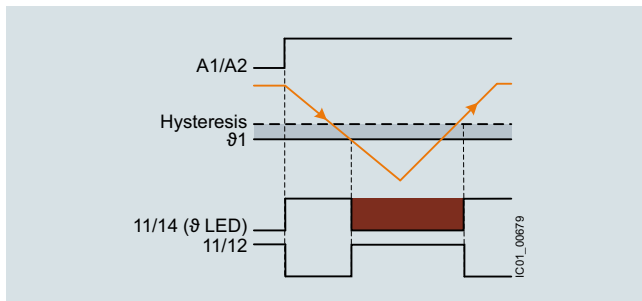

3RS26, 3RS28 digital devices (1 sensor) with Safety function

Temperature monitors according to EN 14597

Temperature overshoot

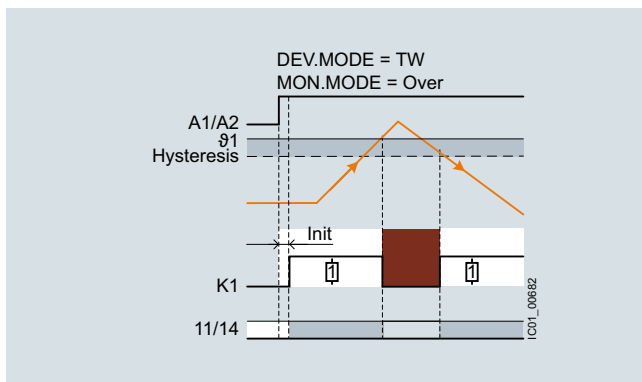

Temperature undershoot

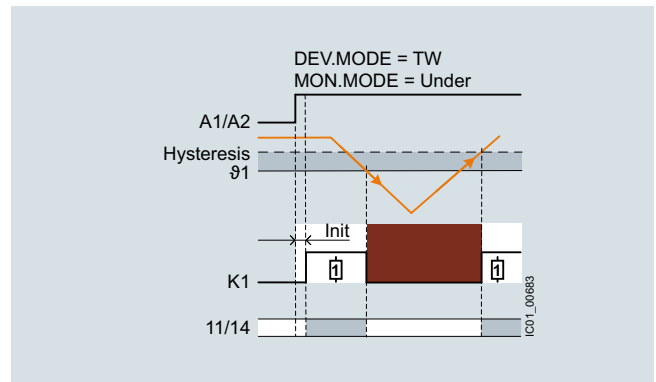

Temperature limiters according to EN 14597/ATEX

Temperature overshoot

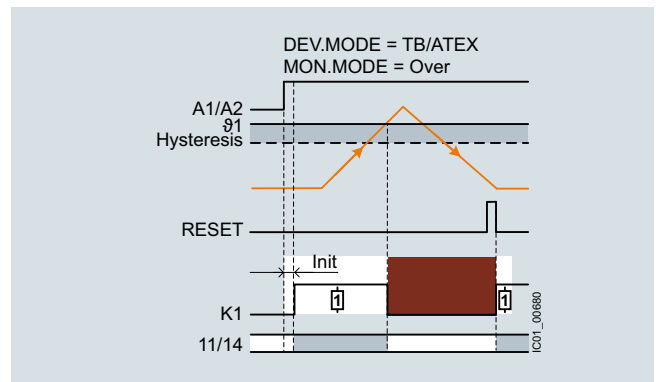

Temperature undershoot

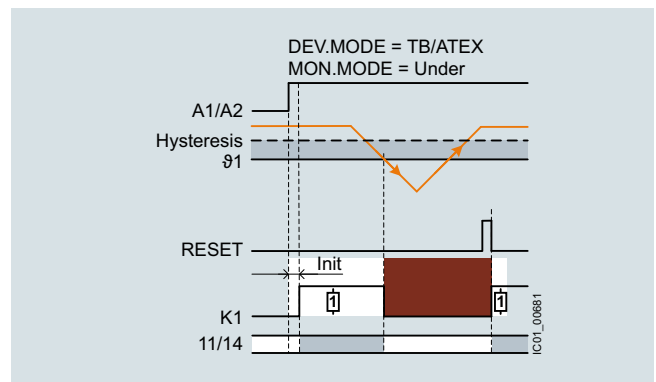

Monitoring and control devices

Relays

SIRIUS 3RS2 temperature monitoring relays

General data

3RS26, 3RS28 digital devices (1 sensor)

Temperature overshoot

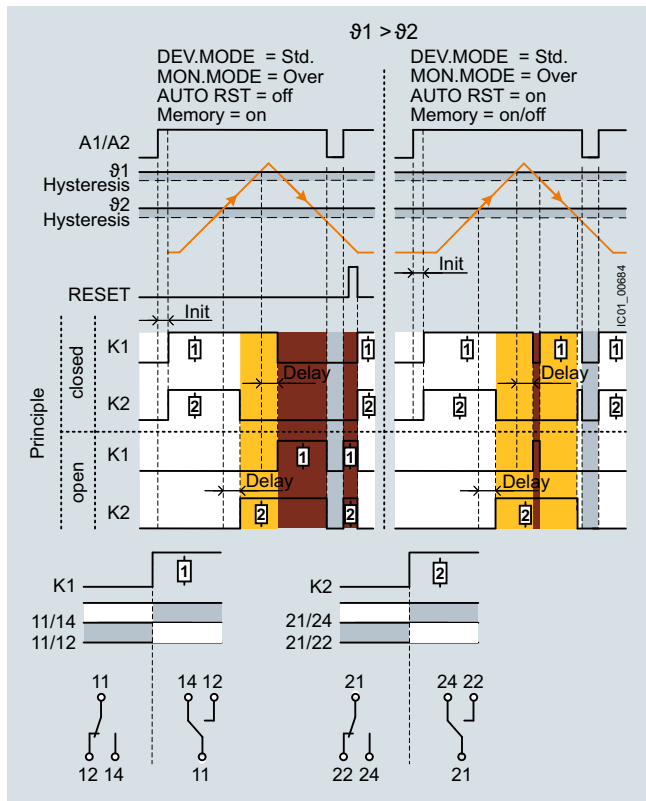

Temperature undershoot

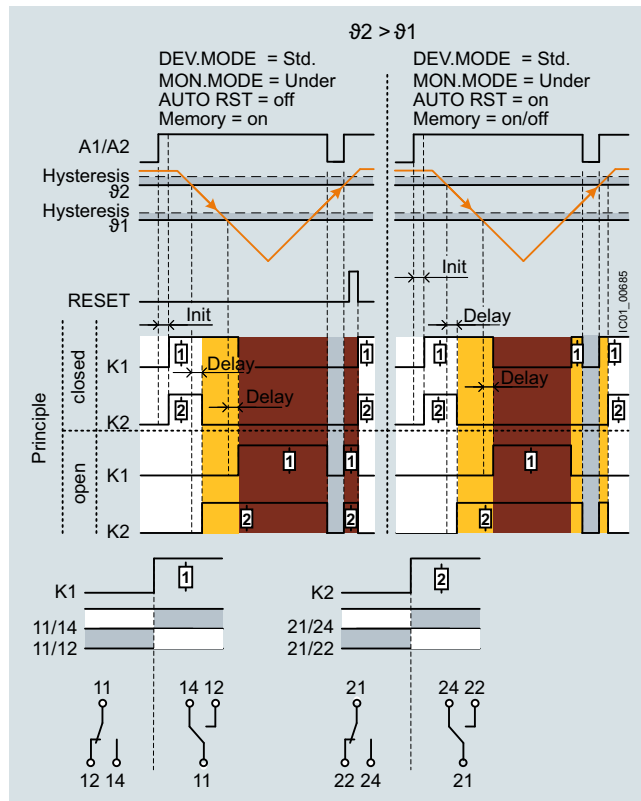

Range monitoring

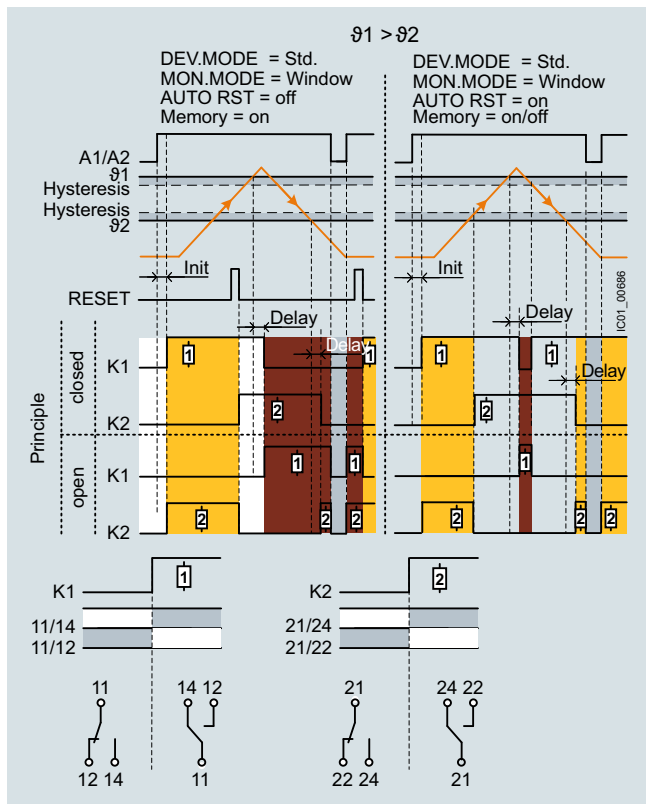

Range monitoring

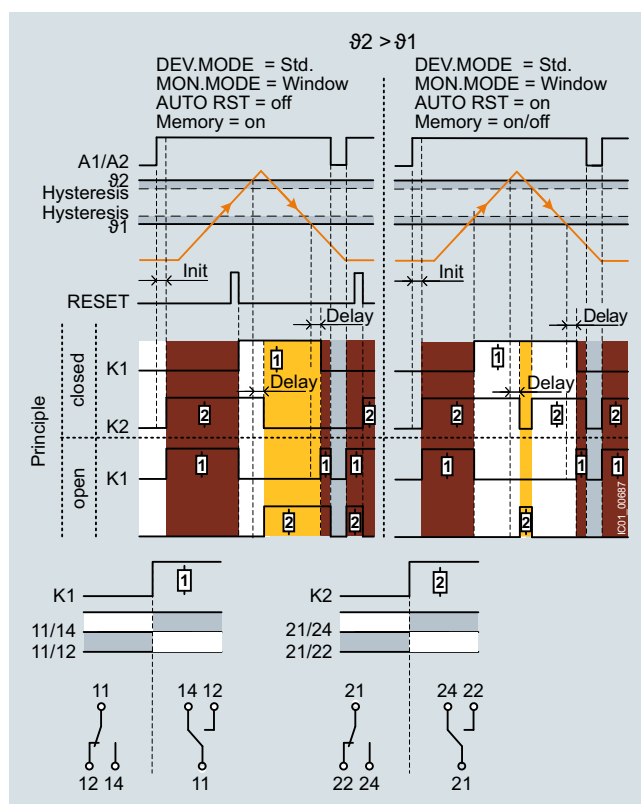

10

Characteristic curves

For resistance sensors

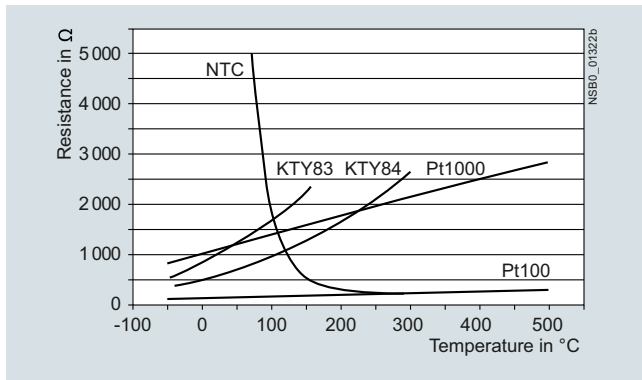

Characteristic curves for resistance sensors

The short-circuit and open-circuit detection as well as the measuring range is limited, depending on the sensor type.

Measuring ranges and switch position for analog devices in °C for Pt100 resistance sensor

Measuring range in °C	Switch position in °C										
	min.					1/2					max.
0 ... +100	0	10	20	30	40	50	60	70	80	90	100
0 ... +200	0	20	40	60	80	100	120	140	160	180	200
-50 ... +50	-50	-40	-30	-20	-10	0	10	20	30	40	50

Measuring ranges for digital devices in °C for resistance sensor

Sensor type	Short circuit	Open circuit	3RS26, 3RS28 Measuring range in °C	3RS26, 3RS28 Measuring range in °F
Pt100	✓	✓	-50 ... +750	-58 ... +1 382
Pt1000	✓	✓	-50 ... +500	-58 ... +932
KTY83-110	✓	✓	-50 ... +175	-58 ... +347
KTY84	✓	✓	-40 ... +300	-40 ... +572
NTC ¹⁾	✓	--	+80 ... +160	+176 ... +320

✓ Detection possible

-- Detection not possible

¹⁾ NTC type: B57227-K333-A1 (100 °C: 1.8 kΩ; 25 °C: 32.762 kΩ).

For thermocouples

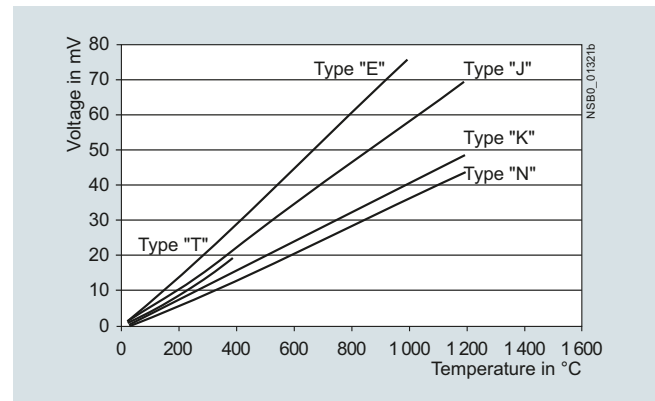

Characteristic curves for thermocouples J, K, T, E, N

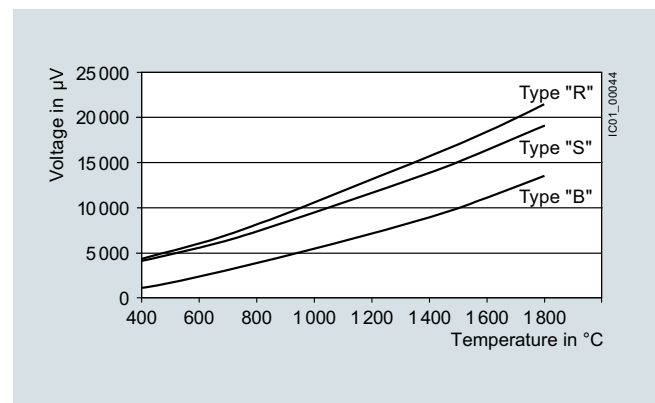

Characteristic curves for thermocouples S, R and B

Measuring ranges and switch position for analog devices in °C for thermocouple types J, K

Measuring range in °C	Switch position in °C										
	min.					1/2					max.
0 ... +200	0	20	40	60	80	100	120	140	160	180	200
0 ... +600	0	60	120	180	240	300	360	420	480	540	600
+500 ... +1 000	500	550	600	650	700	750	800	850	900	950	1 000

Measuring ranges for digital devices in °C/°F for thermocouples

Sensor type	Short circuit	Open circuit	3RS26, 3RS28 Measuring range in °C	3RS26, 3RS28 Measuring range in °F
J	--	✓	-99 ... +1 200	-146.2 ... +2 192
K	--	✓	-99 ... +1 350	-146.2 ... +2 462
T	--	✓	-99 ... +400	-146.2 ... +752
E	--	✓	-99 ... +999	-146.2 ... +1 830.2
N	--	✓	-99 ... +1 300	-146.2 ... +2 372
S	--	✓	0 ... +1 750	+32 ... +3 182
R	--	✓	0 ... +1 750	+32 ... +3 182
B	--	✓	+400 ... +1 800	+752 ... +3 272

✓ Detection possible



-- Detection not possible

Monitoring and control devices

Relays

SIRIUS 3RS2 temperature monitoring relays

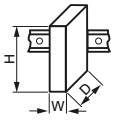
General data

Type		3RS25-....0	3RS26-....0	3RS28-....0	3RS29-....0
General technical specifications					
Dimensions (W x H x D)	 mm	22.5 x 100 x 90			
Permissible ambient temperature					
• During operation	°C	-25 ... +60			
• During transport	°C	-40 ... +85			
• During storage	°C	-40 ... +85			
Degree of protection IP		IP20			
Mounting position		Any			
Type of mounting		Screw fixing and snap-on mounting on 35 mm standard mounting rail			
Auxiliary circuit					
Type of voltage		AC/DC	DC	AC/DC	AC/DC
Operating range factor of the control supply voltage, rated value					
• At AC at 50 Hz		0.85 ... 1.1	--		0.85 ... 1.1
• At AC at 60 Hz		0.85 ... 1.1	--		0.85 ... 1.1
• At DC		0.85 ... 1.1	0.7 ... 1.25		0.85 ... 1.1
Operating frequency, rated value	Hz	50 ... 60			
Number of measuring circuits		1			3
Number of CO contacts for auxiliary contacts		1	2		0
Product function					
• Removable terminal for auxiliary and control circuit	Yes				
• Auto RESET	Yes				--
• Fault storage	No	Yes			
• External RESET	No	Yes			
ATEX					
Certificate of suitability					
• Relative to ATEX	No	Yes, with 3RS29 sensor expansion module		Yes, with 3RS26/3RS28 digital device	
Safety integrity level (SIL) according to IEC 61508		--	1		
Performance level (PL) according to ISO 13849-1		--	c		
Type		3RS2500-1....0 3RS2600-1....0 3RS2800-1....0 3RS2900-1....0		3RS2500-2....0 3RS2600-2....0 3RS2800-2....0 3RS2900-2....0	
Type of electrical connection		 Screw terminals		 Spring-loaded terminals (push-in)	
Tightening torque	Nm	0.6 ... 0.8		--	
Type of connectable conductor cross-sections					
• Solid	mm ²	1 x (0.5 ... 4), 2 x (0.5 ... 2.5)		1 x (0.5 ... 4)	
• Finely stranded	mm ²	--		1 x (0.5 ... 4)	
- Without end sleeves		1 x (0.5 ... 4), 2 x (0.5 ... 2.5)		1 x (0.5 ... 2.5)	
- With end sleeves		--		--	
• For AWG cables	AWG	1 x (20 ... 12), 2 x (20 ... 14)		1 x (20 ... 12)	
- Solid		--		1 x (20 ... 12)	
- Stranded		--		1 x (20 ... 12)	

Selection and ordering data

PU (UNIT, SET, M) = 1
 PS* = 1 unit
 PG = 41H

Number of measuring circuits	Type of sensor/connectable	Rated control supply voltage U_s 50/60 Hz AC	Suitability for use	SD	Screw terminals		Spring-loaded terminals (push-in)	
					Article No.	Price per PU	Article No.	Price per PU
		V		d				

Temperature monitoring relays

Analog multi-function device, 1 sensor, 1 threshold value

3RS2500-1AA30

1	Resistance sensors: Pt100	24 AC/DC	--	10
	Thermocouples: Type J, K	24 ... 240 AC/DC	--	10

3RS2500-1AA30

10

3RS2500-2AA30

10

3RS2500-2AW30

Digital device, 1 sensor, 2 threshold values

3RS2600-1BA30

1	Resistance sensors: Pt100, Pt1000, KTY83-110, KTY84, NTC	24 AC/DC	--	10
	Thermocouples: Type J, K, T, E, N, S, R, B	24 ... 240 AC/DC	--	10

3RS2600-1BA30

10

3RS2600-2BA30

10

3RS2600-2BW30

Digital device for IO-Link, 1 sensor, 2 threshold values

3RS2800-1BA40

1	Resistance sensors: Pt100, Pt1000, KTY83-110, KTY84, NTC	24 DC	--	10
	Thermocouples: Type J, K, T, E, N, S, R, B			

3RS2800-1BA40

10

3RS2800-2BA40

Sensor expansion modules

**2 additional resistance sensors, analog input
4 ... 20 mA, ATEX via analog input, status relay**

3RS2900-1AA30

3	Resistance sensors: Pt100, Pt1000, KTY83-110, KTY84, NTC	24 AC/DC	For 3RS26/3RS28 digital devices	10
		24 ... 240 AC/DC		10

3RS2900-1AA30

10

3RS2900-2AA30

10

3RS2900-2AW30

For accessories, see page 10/132.









Monitoring and control devices

Relays

SIRIUS 3RS2 temperature monitoring relays

Accessories

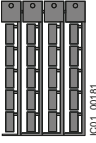
Selection and ordering data

Version	SD	Article No.	Price per PU	PU (UNIT, SET, M)	PS*	PG
Terminals for SIRIUS devices in the industrial standard mounting rail enclosure						
 3ZY1122-1BA00	Removable terminals <ul style="list-style-type: none"> • 2-pole, up to 1 x 4 mm² or 2 x 2.5 mm² 	2	Screw terminals  3ZY1122-1BA00	1	6 units	41L
	<ul style="list-style-type: none"> • 2-pole, up to 1 x 4 mm² or 2 x 1.5 mm² (in shared end sleeve) 	2	Spring-loaded terminals (push-in)  3ZY1122-2BA00	1	6 units	41L
Accessories for enclosures						
 3ZY1321-2AA00	Sealing covers <ul style="list-style-type: none"> • 22.5 mm 	2	3ZY1321-2AA00	1	5 units	41L
 3ZY1311-0AA00	Push-in lugs For wall mounting	2	3ZY1311-0AA00	1	10 units	41L
 3ZY1440-1AA00	Coding pins For removable terminals of SIRIUS devices in the industrial standard mounting rail enclosure; enable the mechanical coding of terminals	2	3ZY1440-1AA00	1	12 units	41L
 3ZY1450-1AB00	Hinged cover Replacement cover, without terminal labeling, titanium gray <ul style="list-style-type: none"> • 22.5 mm wide 	2	3ZY1450-1AB00	1	5 units	41L
Blank labels						
 3RT2900-1SB20	Unit labeling plates¹⁾ For SIRIUS devices <ul style="list-style-type: none"> • 20 mm x 7 mm, titanium gray 	20	3RT2900-1SB20	100	340 units	41B
Tools for opening spring-loaded terminals						
 3RA2908-1A	Screwdrivers For all SIRIUS devices with spring-loaded terminals Length approx. 200 mm, 3.0 mm x 0.5 mm, titanium gray/black, partially insulated	2	Spring-loaded terminals (push-in)  3RA2908-1A	1	1 unit	41B

¹⁾ PC labeling system for individual inscription of unit labeling plates available from: murrplastik Systemtechnik GmbH, see page 16/16.

For suitable sensors, see www.siemens.com/temperature.

Overview



SIRIUS 3RN2 thermistor motor protection

More information

Homepage, see www.siemens.com/sirius-monitoring-relays

Industry Mall, see www.siemens.com/product?3RN2

Conversion tool, see www.siemens.com/conversion-tool



Video: SIRIUS 3RN2 thermistor motor protection relays

Thermistor motor protection devices are used for direct monitoring of the motor winding temperature. For this purpose, the motors are equipped with temperature-dependent resistors (PTC) that are directly installed in the motor winding and abruptly change their resistance at their temperature limit.

Versions

SIRIUS 3RN2 thermistor motor protection relays are available in the following versions:

- 3RN2000 compact evaluation unit
- 3RN2010 compact/standard evaluation unit
- 3RN2012-.BW31 bistable evaluation unit
- 3RN2011, 3RN2012-...30, 3RN2013 standard evaluation unit with ATEX approval
- 3RN2023 evaluation unit with ATEX approval and 2 sensor circuits for warning and disconnection

They comply with

- IEC 60947-8. Low-voltage switchgear and controlgear – Part 8: "Control units for built-in thermal protection (PTC) for rotating electrical machines"
- IEC 61000-6-2, IEC 61000-6-4. "Electromagnetic compatibility for industrial-process measurement and control equipment"

The 3RN2 thermistor motor protection relays with ATEX approval fulfill SIL 1 in compliance with EN 50495.

The terminals of the auxiliary contacts are designated in accordance with EN 60947-1.

3RN2 evaluation units are suitable for snap-on mounting on TH 35 standard mounting rails according to IEC 60715 or for screw fixing using an adapter (accessory).

Article No. scheme

Product versions		Article number								
Thermistor motor protection relay with PTC sensor, type A		3RN20	<input type="checkbox"/>	<input type="checkbox"/>	-	<input type="checkbox"/>	<input type="checkbox"/>	<input type="checkbox"/>	<input type="checkbox"/>	
Number and version of the sensor circuits	1 sensor circuit, supply voltage = root voltage	0								
	1 sensor circuit	1								
	2 sensor circuits for warning and disconnection	2								
RESET	Auto RESET	0								
	Manual RESET, with open-circuit and short-circuit detection	1								
	Manual/Auto/Remote RESET, non-volatile, with open-circuit and short-circuit detection	2								
	Manual/Auto/Remote RESET, non-volatile, with open-circuit and short-circuit detection, with protective separation	3								
Connection method	Screw terminals				1					
	Spring-loaded terminals (push-in)				2					
Auxiliary switches	1 CO						A			
	2 CO						B			
	1 NO + 1 NC						C			
	1 NO + 1 CO						D			
	2 CO, hard gold-plated						G			
Rated control supply voltage	24 V AC/DC						A 3			
	24 ... 240 V AC/DC						W 3			
Response to failure	Monostable							0		
	Bistable							1		
Example		3RN20	0	0	-	1	A	A	3	0

Note:

The Article No. scheme shows an overview of product versions for better understanding of the logic behind the article numbers.

For your orders, please use the article numbers quoted in the selection and ordering data.

Monitoring and control devices

Relays

SIRIUS 3RN2 thermistor motor protection

General data

Benefits

- Thanks to direct motor protection, overdimensioning of the motors is not necessary
- No settings on the device are necessary
- Semiconductor compatible output thanks to versions with hard gold-plated contacts
- Rapid error diagnostics thanks to versions that indicate open and short circuits in the sensor circuit
- All versions with removable terminals
- All versions with screw or spring-loaded terminals with push-in functionality

Application

Direct motor protection through temperature monitoring of the motor winding offers 100% motor protection even under the most difficult ambient conditions, without the need to make adjustments on the device. Versions with hard gold-plated contacts additionally ensure a switching reliability that is higher than that of an electronic control.

Direct motor protection

- At increased ambient temperatures
- When switching frequency is too high
- When startup and braking procedures are too long

ATEX approval for operation in hazardous areas

The SIRIUS 3RN2011, 3RN2012-...30, 3RN2013 and 3RN2023 thermistor motor protection relays for PTC sensors are certified according to ATEX Ex II (2) G and D for environments with explosive gas or dust loads.

Motor protection using current- and temperature-dependent protective devices

IEC 60204 stipulates that motors must be protected from overheating at a rating of 0.5 kW and higher. The protection can take the form of overload protection, overtemperature protection or current limiting.

For motors with frequent starting and braking and in environments where cooling may be impaired (e.g. by dust), it is recommended to use the overtemperature protection option in the form of a protective device coordinated with this mode of operation. A good choice in this case is the use of 3RN2 thermistor motor protection devices.

On rotor-critical motors, overtemperature detection in the stator windings can lead to delayed and hence inadequate protection. In this case the standards stipulate additional protection, e.g. by means of an overload relay.

This combination of thermistor motor protection and overload relay is recommended for full motor protection in case of frequent starting and braking of motors, irregular intermittent duty or excessive switching frequency. To prevent premature tripping of the overload relay in such operating conditions, a higher setting than that normally required for the operational current is chosen. The overload relay then performs stall protection, and the 3RN2 thermistor motor protection relay monitors the temperature of the motor windings.

Application	Motor protection		
	Current-dependent only, e.g. with overload relay	Temperature-dependent only, e.g. with thermistor motor protection relay	Current- and temperature-dependent
Motor protection in case of			
Overloading in uninterrupted duty	✓	✓	✓
Long startup and braking operations	○	✓	✓
Irregular intermittent duty	○	✓	✓
When switching frequency is too high	○	✓	✓
1-phase operation and current asymmetry	✓	✓	✓
Voltage and frequency fluctuations	✓	✓	✓
Stalling of the rotor	✓	✓	✓
Switching on a stalled rotor of a stator-critical motor	✓	✓	✓
Switching on a stalled rotor of a rotor-critical motor	✓	○	✓
Elevated ambient temperature	--	✓	✓
Impeded cooling	--	✓	✓

✓ Full protection

○ Conditional protection

-- No protection

Technical specifications

More information

Technical specifications, see <https://support.industry.siemens.com/cs/ww/en/ps/24302/td>
 Operating Instructions and internal circuit diagrams, see <https://support.industry.siemens.com/cs/ww/en/ps/24302/man>

FAQs, see <https://support.industry.siemens.com/cs/ww/en/ps/24302/faq>
 For more information on explosion protection (ATEX), see www.siemens.com/sirius/atex

Type A PTC temperature sensor

If a Type A temperature sensor is connected to a Type A evaluation unit, compliance with the operating temperatures is assured (on pick-up and reset) according to IEC 60947-8.

The characteristic curves of the Type A temperature sensors are described in IEC 60947-8, EN 44081 and EN 44082 standards.

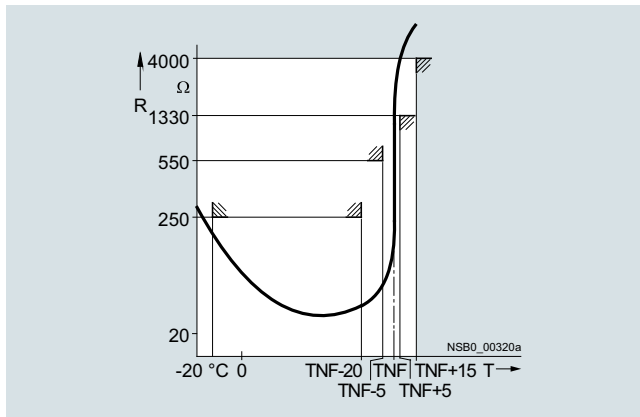

Characteristic curve of the 3RN2 evaluation unit

Bimetallic switch

In some applications, bimetallic switches (e.g. Klixon, Thermoclick) are used as sensors instead of PTC temperature sensors. Bimetallic switches are temperature- and current-dependent NC contacts and are available for different temperature ranges. Because bimetallic switches have practically no resistance below their opening temperature, short-circuit detection is not possible when using bimetallic switches. A bimetallic switch can be used for versions 3RN2000 and 3RN2010 on the SIRIUS thermistor motor protection relay.

Note:

Never use bimetallic switches in applications subject to an explosion hazard! Because of their non-standardized tripping characteristic, bimetallic switches must not be used in hazardous applications. Use Type A PTC sensors instead!

Use in hazardous areas

Increased danger in hazardous areas means it is necessary to observe the following notes and standards carefully:

- EN 60079-14/VDE 0165-1 for electrical apparatus for hazardous areas
- EN 60079-17 Explosive atmospheres - Electrical installations inspection and maintenance
- EN 50495 Safety devices required for the safe functioning of equipment with respect to explosion risks

The following SIRIUS 3RN2 thermistor motor protection relays with short-circuit detection are approved for Equipment Group II, Category (2) in Area "G" (areas in which potentially explosive gas, vapor, mist, or air mixtures are present) and are additionally approved for Area "D" (areas containing combustible dust):

- 3RN2011
- 3RN2012-...30
- 3RN2013
- 3RN2023

PTB 15 ATEX 3011 ex II (2) G (Ex e) (EX d) (EX px)

PTB 15 ATEX 3011 ex II (2) D (EX t) (EX p)

For 3RN2 thermistor motor protection relays, the EC type examination certificate is available for Group II, Category (2) G [Ex e] [Ex d] [Ex px] and D [Ex t] [Ex p]. The number is PTB 15 ATEX 3011.

SIRIUS 3RN2 thermistor motor protection relays are not intended for installation in hazardous areas. If they are installed in a hazardous area, the SIRIUS 3RN2 thermistor motor protection relays must be adapted to the applicable type of protection.

The machine or plant must shut down immediately if the SIRIUS 3RN2 thermistor motor protection relay is tripped, even if connected through a frequency converter. This must be implemented with circuitry.

SIRIUS 3RN2 thermistor motor protection relays with functional safety in accordance with EN 50495 are suitable for protecting explosion-proof motors/machines.

On evaluation units with a supply voltage of 24 V AC/DC, you must ensure electrical separation with a battery network or a power supply unit with electrical separation (e.g. isolating transformer) (does not apply to 3RN2013-.BA30).

A SIRIUS 3RN2 thermistor motor protection relay set to "Automatic RESET" mode will be reset automatically after the recovery time has elapsed, without the RESET button being pressed. An additional ON button has to be used to ensure that the motor does not start up automatically following tripping. "Automatic RESET" mode must not be used in applications where there is a risk of personal injury or damage to property if the motor restarts unexpectedly.

Monitoring and control devices

Relays

SIRIUS 3RN2 thermistor motor protection

General data

⚠ NOTICE!

When used in a hazardous area, the thermistor motor protection relay must not be operated with Auto RESET (terminals Y1 and Y2 permanently jumpered).

A risk analysis must be performed for the complete plant or machine. If this analysis yields a lower hazard potential (category 1), all SIRIUS 3RN2 thermistor motor protection relays can be used, provided the safety regulations are observed.

⚠ WARNING!

All work involved in connecting, commissioning and maintenance must be carried out by qualified, responsible personnel. Improper handling may result in serious personal injury and considerable damage to property.

Cable routing

The measuring circuit leads must be routed as separate control cables. It is not permitted to use cores from the supply line of the motor or any other main supply cables. If extreme inductive or capacitive interference is expected as a result of power lines routed in parallel, shielded control cables must be used.

Maximum length of sensor circuit cables for evaluation units without short-circuit detection in the sensor circuit:

Cable cross-section	3RN2000, 3RN2010
2.5 mm ²	2 x 2 800 m
1.5 mm ²	2 x 1 500 m
0.5 mm ²	2 x 500 m

Maximum length of sensor circuit cables for evaluation units with short-circuit detection¹⁾:

Cable cross-section	3RN2011, 3RN2012, 3RN2013, 3RN2023
2.5 mm ²	2 x 250 m
1.5 mm ²	2 x 150 m
0.5 mm ²	2 x 50 m

¹⁾ A short circuit in the sensor circuit will be detected up to this maximum cable length.

Principle of operation

SIRIUS 3RN2 thermistor motor protection relays are thermal protection devices that are suitable, in combination with Type A PTC thermistors, for monitoring temperatures of electrical drives, transformer windings, oils, bearings, air, etc.

The most frequent application is monitoring of three-phase motors in which the motor manufacturer has fitted a PTC sensor into every winding overhang and in which these PTC sensors are connected in series.

The SIRIUS 3RN2 thermistor motor protection relays operate in accordance with the closed-circuit principle and therefore monitor themselves for loss of supply voltage. The exceptions are the warning output on 3RN2023, which always works on the open-circuit principle and the bistable relays of the 3RN2012-BW31, which always retain the last switching state.

A micro-interruption in the power supply of less than 30 ms does not change the status of the output relays.

For devices with the "Manual RESET" function, the test function can be activated and a trip simulated by pressing the blue Test/RESET button for > 2 seconds.

The 3RN2011, 3RN2012, 3RN2013 and 3RN2023 devices are additionally equipped with open-circuit and short-circuit detection in the sensor circuit. The unit will trip in the event of a short circuit (resistance in sensor circuit < 10 Ω) or open circuit in the sensor circuit (dynamic open-circuit detection). Tripping as the result of a short circuit in the sensor circuit is indicated by a flickering red LED (TRIPPED). In the event of a short circuit in the sensor circuit for warning on the 3RN2023, the yellow warning LED (WARNING) flickers. The devices with dynamic open-circuit detection evaluate the rise time of the sensor circuit resistance. If the sensor circuit resistance rises from 3 300 Ω to 12 kΩ within 200 ms, the unit will not only trip, but also indicate the open circuit via a flashing red LED (TRIPPED) (in the event of an open circuit in a sensor circuit, the yellow warning LED (WARNING) flashes for the 3RN2023.)

All evaluation units (except for the 3RN2000 compact evaluation unit) feature electrical separation between the control circuit and the sensor circuit. The relay outputs are also electrically separated from all other circuits. The 3RN2013 and 3RN2023 evaluation units incorporate protective electrical separation between all circuits up to $U_i = 300$ V.

3RN2000 compact evaluation unit

The compact unit, which is only 17.5 mm wide, is equipped with a red LED (TRIPPED) for the tripped indicator and a changeover contact. After the unit has tripped, it is automatically reset once the thermistors have cooled down. The root of the changeover contact is connected to the control voltage (terminal 11 is connected to terminal A1). This unit is particularly suitable in circuits in which the control circuit and signaling circuit have the same potential, e.g. in local control boxes.

3RN2010, 3RN2011, 3RN2012, 3RN2013 compact/standard evaluation units

The units are equipped with two LEDs (READY and TRIPPED) for an operating and tripped display and are available with either 1 NO + 1 NC contacts (3RN2010, overall width 17.5 mm) or with 2 CO contacts. Depending on the version, they are available with Auto RESET (3RN2010), Manual/Remote RESET (3RN2011) or Manual/Auto and Remote RESET (3RN2012 and 3RN2013). Remote RESET can be achieved by connecting an external pushbutton with a normally-open function to terminals Y1 and Y2. If terminals Y1 and Y2 are jumpered, the unit is automatically reset once the thermistors have cooled down (Auto RESET). 3RN2012 and 3RN2013 are non-volatile. This means a previous trip remains stored in the event of a control supply voltage failure – the thermistor motor protection relay remains in the safe state with an opened output relay until it is intentionally reset by pressing the TEST/RESET button of the unit or an external pushbutton.

3RN2023 "warning and disconnection" evaluation units

Two sensor circuits can be connected to one 3RN2023 evaluation unit that act on two separate output relays with 1 NO contact for warning and 1 CO contact for disconnection. Thermistors with different rated response temperatures TNF are used to implement the "Warning" and "Disconnection" functions. When sensor circuit 2 for "Warning" responds, a yellow LED is lit and when the "Disconnection" circuit responds, a red LED is lit. The sensor circuits have a different reset response and operating behavior: The "Warning" thermistor sensor circuit 2 (terminals 2T1, T2) works only with Auto RESET and according to the open-circuit principle (output relay K2, NO contact). The "Disconnection" thermistor sensor circuit 1 (terminals 1T1, T2) can be changed from Manual RESET to Auto RESET by jumpering terminals Y1 and Y2. Remote RESET is implemented by connecting an external pushbutton with a normally-open function to these terminals.

Function diagrams

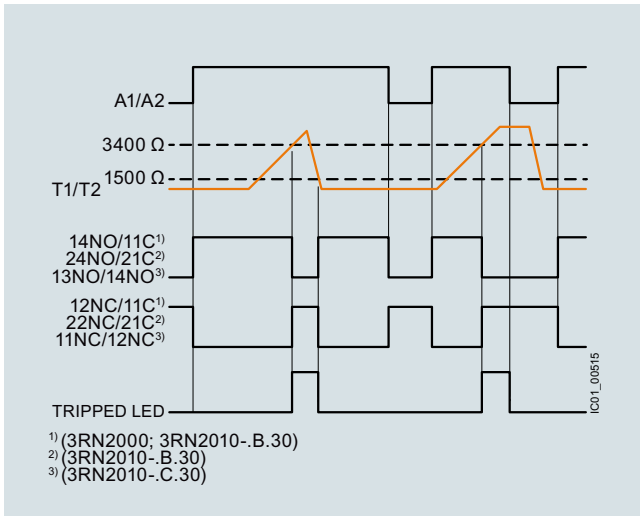

3RN2000, 3RN2010

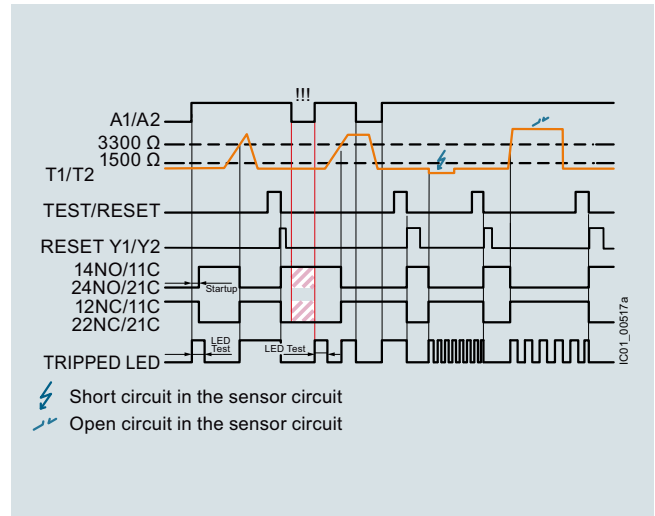

3RN2012-.BW31: resetting via the TEST/RESET button or external pushbutton

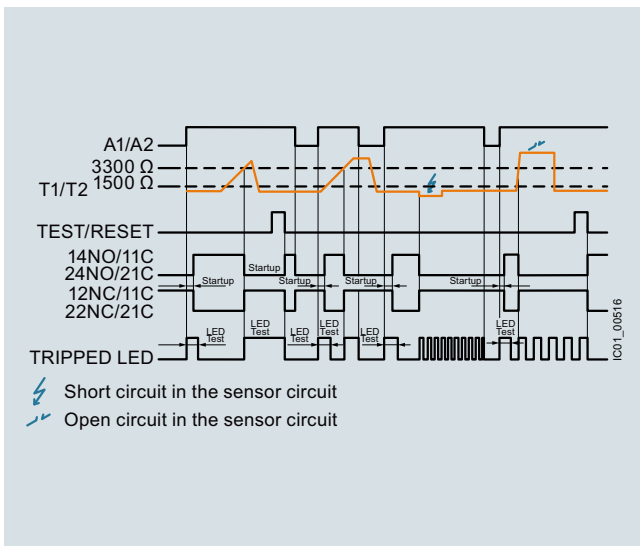

3RN2011: resetting via external pushbutton or interruption of the supply voltage

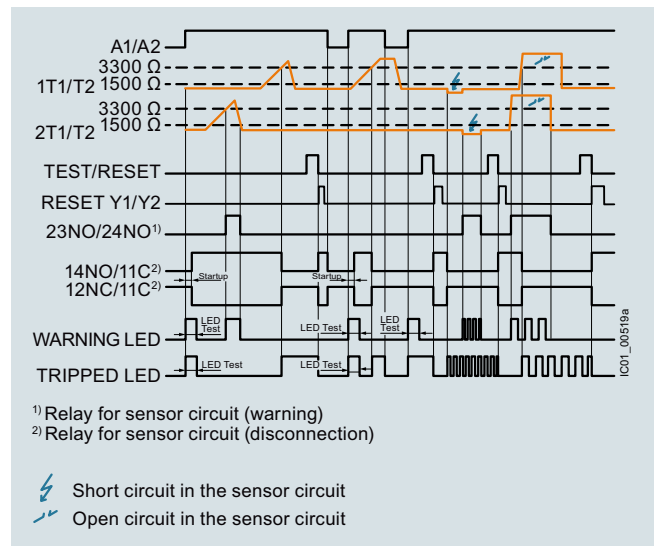

3RN2023: resetting via the TEST/RESET button or external pushbutton

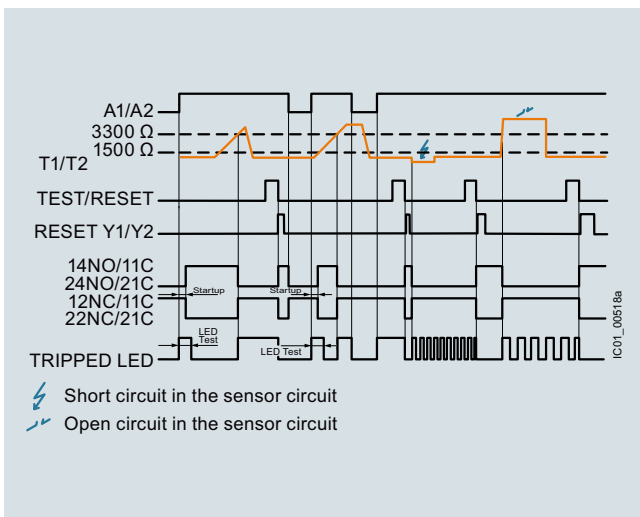

3RN2012-.B.30, 3RN2013: resetting via the TEST/RESET button or external pushbutton

Monitoring and control devices

Relays

SIRIUS 3RN2 thermistor motor protection

General data

Article number	3RN2000-A, 3RN2010-C	3RN201-.B, 3RN2013-G, 3RN2023-D
Dimensions (W x H x D)	17.5 x 100 x 90	22.5 x 100 x 90

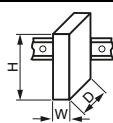

Article number	3RN2000- .AA30	3RN2000- .AW30, 3RN2010- .BW30, 3RN2010- .CW30	3RN2010- .BA30, 3RN2010- .CA30	3RN2011- .BA30, 3RN2012- .BA30	3RN2011- .BW30, 3RN2012- .BW30	3RN2012- .BW31	3RN2013- .BA30	3RN2013- .BW30, 3RN2013- .GW30	3RN2023- .DW30
----------------	---------------------------	---	---	---	---	---------------------------	---------------------------	---	---------------------------

General technical specifications:									
Type of electrical separation		Without electrical separation	Electrical separation				Protective separation		
Electrical endurance (operating cycles) for AC-15 at 230 V		100 000							
Mechanical service life (operating cycles)		10 000 000							
Insulation voltage for overvoltage category III acc. to IEC 60664 for pollution degree 3, rated value	V	300							
Impulse withstand voltage, rated value	kV	4				6			
Minimum mains failure buffering time	ms	40							30
Pollution degree		3							
Degree of protection IP		IP20							
Shock resistance acc. to IEC 60068-2-27		11g/15 ms							
Vibration resistance acc. to IEC 60068-2-6		10 ... 55 Hz: 0.35 mm							
Type of mounting		Screw fixing and snap-on mounting on 35 mm standard mounting rail							
• Mounting position		Any							
• Installation altitude at height above sea level, maximum	m	2 000							
Ambient temperature during operation	°C	-25 ... +60							
Relative humidity during operation, maximum	%	70							
ATEX									
Ex device group and Ex category according to ATEX product directive 2014/34/EU		--		II 2G, II 2D		--		II 2G, II 2D	
Safety device type according to IEC 61508-2		--		Type B		--		Type B	
Safety integrity level (SIL) according to IEC 61508		--		SIL 1		--		SIL 1	
Performance level (PL) according to ISO 13849-1		--		c		--		c	
T1 value for proof test interval or service duration according to IEC 61508	y	--		3		--		3	
Measuring circuit:									
Number of measuring circuits		1							2
Relative measuring accuracy	%	9			2				
Maximum number of sensors in series		6							
Cable length of sensor, maximum	m	2 800			250				
Thermistor resistance response value	Ω	1 500 ... 1 650			1 500 ... 1 550				
Thermistor resistance return value	Ω	3 400 ... 3 600			3 300 ... 3 350				



Monitoring and control devices

Relays

SIRIUS 3RN2 thermistor motor protection

General data

Article number	3RN2000- .AA30	3RN2000- .AW30, 3RN2010- .BW30, 3RN2010- .CW30	3RN2010- .BA30, 3RN2010- .CA30	3RN2011- .BA30, 3RN2012- .BA30	3RN2011- .BW30, 3RN2012- .BW30	3RN2012- .BW31	3RN2013- .BA30	3RN2013- .BW30, 3RN2013- .GW30	3RN2023- .DW30
Control circuit:									
Current-carrying capacity of the output relay									
• At AC-15 at 250 V at 50/60 Hz	A	3							
• At DC-13 at 24 V	A	1							
• At DC-13 at 125 V	A	0.2							
• At DC-13 at 250 V	A	0.1							
Thermal current of the non-solid-state contact blocks, maximum	A	5							
Continuous current of the output relay's DIAZED fuse link	A	6							
Supply voltage:									
Control supply voltage									
• At AC									
- At 50 Hz rated value	V	24 ... 24	24 ... 240	24 ... 24		24 ... 240	24 ... 24	24 ... 240	
- At 60 Hz rated value	V	24 ... 24	24 ... 240	24 ... 24		24 ... 240	24 ... 24	24 ... 240	
• At DC, rated value	V	24 ... 24	24 ... 240	24 ... 24		24 ... 240	24 ... 24	24 ... 240	
Operating range factor of the control supply voltage, rated value									
• At AC at 50 Hz		0.85 ... 1.1							
• At AC at 60 Hz		0.85 ... 1.1							
• At DC		0.85 ... 1.1							

Article number	3RN20..-1	3RN20..-2
Type of electrical connection	 Screw terminals	 Spring-loaded terminals (push-in)
Tightening torque	Nm 0.6 ... 0.8	--
Type of connectable conductor cross-sections		
• Solid	1 x (0.5 ... 4 mm ²), 2 x (0.5 ... 2.5 mm ²)	1 x (0.5 ... 4 mm ²)
• Finely stranded with end sleeve	1 x (0.5 ... 4 mm ²), 2 x (0.5 ... 1.5 mm ²)	1 x (0.5 ... 2.5 mm ²)
• For AWG cables		
- Solid	1 x (20 ... 12), 2 x (20 ... 14)	1 x (20 ... 12)
- Stranded	--	1 x (20 ... 12)

Monitoring and control devices

Relays

SIRIUS 3RN2 thermistor motor protection

Basic units

Selection and ordering data



3RN2000-1AA30



3RN2010-1BA30



3RN2011-1BA30



3RN2012-1BW30



3RN2023-1DW30

Product function	Number of CO contacts for auxiliary contacts	Number of NO contacts for auxiliary contacts	Number of NC contacts for auxiliary contacts	Material of switching contacts	Control supply voltage		SD	Article No.	Price per PU	PU (UNIT, SET, M)	PS*	PG
					At AC at 50 Hz, rated value	At DC rated value						
					V	V	d					

Compact evaluation unit, suitable for bimetallic switch

Terminal A1 jumpered with root of changeover contact

Auto RESET	1	0	0	AgSnO2	24 ... 24	24 ... 24	2	3RN2000-□AA30		1	1 unit	41H
					24 ... 240	24 ... 240	2	3RN2000-□AW30		1	1 unit	41H
	0	1	1	AgSnO2	24 ... 24	24 ... 24	2	3RN2010-□CA30		1	1 unit	41H
					24 ... 240	24 ... 240	2	3RN2010-□CW30		1	1 unit	41H

Standard evaluation unit, suitable for bimetallic switch

Auto RESET	2	0	0	AgSnO2	24 ... 24	24 ... 24	2	3RN2010-□BA30		1	1 unit	41H
					24 ... 240	24 ... 240	2	3RN2010-□BW30		1	1 unit	41H

Bistable evaluation unit, open-circuit and short-circuit detection in the sensor circuit

Does not trigger in the event of control supply voltage failure

Auto RESET	2	0	0	AgSnO2	24 ... 240	24 ... 240	2	3RN2012-□BW31		1	1 unit	41H
Manual RESET												
External RESET												
Fault storage												

Standard evaluation unit with ATEX approval, open-circuit and short-circuit detection in the sensor circuit¹⁾

Manual RESET	2	0	0	AgSnO2	24 ... 24	24 ... 24	2	3RN2011-□BA30		1	1 unit	41H
External RESET					24 ... 240	24 ... 240	2	3RN2011-□BW30		1	1 unit	41H

Non-volatile³⁾

Auto RESET	2 ⁴⁾	0	0	AgSnO2	24 ... 24	24 ... 24	2	3RN2012-□BA30		1	1 unit	41H
Manual RESET					24 ... 240	24 ... 240	2	3RN2012-□BW30		1	1 unit	41H
External RESET												
Fault storage												

Protective separation, non-volatile²⁾³⁾

Auto RESET	2	0	0	AgSnO2	24 ... 24	24 ... 24	2	3RN2013-□BA30		1	1 unit	41H
Manual RESET					24 ... 240	24 ... 240	2	3RN2013-□BW30		1	1 unit	41H
External RESET												
Fault storage				AgSnO2 Hard gold-plated	24 ... 240	24 ... 240	2	3RN2013-□GW30		1	1 unit	41H

Evaluation unit with ATEX approval and 2 sensor circuits for warning and disconnection, open-circuit and short-circuit detection in both sensor circuits

Protective separation, non-volatile²⁾³⁾

Auto RESET	1	1	0	AgSnO2	24 ... 240	24 ... 240	2	3RN2023-□DW30		1	1 unit	41H
Manual RESET												
External RESET												
Fault storage												

Type of electrical connection









- Screw terminals
- Spring-loaded terminals (push-in)

- 1) For 3RN2011: The unit can be reset with the RESET button or by disconnecting the control supply voltage.
- 2) Protective separation up to 300 V acc. to DIN/VDE 0160, IEC 60947-1.
- 3) Protection against voltage failure or non-volatile fault storage means that previous tripping due to a fault remains stored even if the control supply voltage fails. The monitoring device is not reset if the voltage fails. With an active fault, meaning a fault which has not been manually confirmed, an automatic restart of the plant upon recovery of the power is prevented therefore and plant safety increased as the result.
- 4) Setting of output contacts in as-supplied state not defined (bistable relay). Application of the control supply voltage once results in contact changeover to the correct setting.

1

2

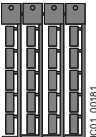
Selection and ordering data

Version	SD	Article No.	Price per PU	PU (UNIT, SET, M)	PS*	PG
Terminals for SIRIUS devices in the industrial standard mounting rail enclosure						
 3ZY1122-1BA00	Removable terminals <ul style="list-style-type: none"> • 2-pole, up to 1 x 4 mm² or 2 x 2.5 mm² 	2	Screw terminals  3ZY1122-1BA00	1	6 units	41L
	<ul style="list-style-type: none"> • 2-pole, up to 1 x 4 mm² or 2 x 1.5 mm² (in shared end sleeve) 	2	Spring-loaded terminals (push-in)  3ZY1122-2BA00	1	6 units	41L
Accessories for enclosures						
 3ZY1311-0AA00	Push-in lugs For wall mounting	2	3ZY1311-0AA00	1	10 units	41L
 3ZY1440-1AA00	Coding pins For removable terminals of SIRIUS devices in the industrial standard mounting rail enclosure; enable the mechanical coding of terminals	2	3ZY1440-1AA00	1	12 units	41L
 3ZY1450-1AB00	Hinged cover Replacement cover, without terminal labeling, titanium gray	2	3ZY1450-1AA00	1	5 units	41L
	<ul style="list-style-type: none"> • 17.5 mm wide • 22.5 mm wide 	2	3ZY1450-1AB00	1	5 units	41L
Blank labels						
 3RT2900-1SB20	Unit labeling plates¹⁾ For SIRIUS devices	20	3RT2900-1SB10	100	816 units	41B
	<ul style="list-style-type: none"> • 10 mm x 7 mm, titanium gray • 20 mm x 7 mm, titanium gray 	20	3RT2900-1SB20	100	340 units	41B
Tools for opening spring-loaded terminals						
 3RA2908-1A	Screwdrivers For all SIRIUS devices with spring-loaded terminals Length approx. 200 mm, 3.0 mm x 0.5 mm, titanium gray/black, partially insulated	2	Spring-loaded terminals (push-in)  3RA2908-1A	1	1 unit	41B

¹⁾ PC labeling system for individual inscription of unit labeling plates available from: murrplastik Systemtechnik GmbH, see page 16/16.

Monitoring and control devices

Relays

Coupling relays and signal converters

SIRIUS 3RS70 signal converters

Overview



SIRIUS 3RS70 signal converters

More information

Homepage, see www.siemens.com/sirius-coupling-relays

Industry Mall, see www.siemens.com/product?3RS70

TIA Selection Tool Cloud (TST Cloud), see www.siemens.com/tstcloud/?node=SignalConverters

Conversion tool, see www.siemens.com/conversion-tool

Signal converters perform the coupling function for analog signals on both the input side and the output side. They are indispensable when processing analog values with electronic controls. Under harsh industrial conditions in particular, it is often necessary to transmit analog signals over long distances. Electrical separation is then needed as a result of the different power supplies. The resistance of the wiring causes potential differences and losses which must be prevented.

Electromagnetic disturbance and overvoltages can affect the signals on the input side in particular or even destroy the analog modules. All terminals of the 3RS70 signal converters are safe up to a voltage of 30 V DC and protected against switching poles. Short-circuit protection is an especially important function for the outputs.

The devices are EMC-tested according to

- IEC 61000-6-4 (generic standard for emitted interference)
- IEC 61000-6-2 (generic standard for interference immunity)

The analog signals comply with

- IEC 60381-1/2

Article No. scheme

Product versions		Article number	
Signal converters		3RS70	<input type="checkbox"/> <input type="checkbox"/> - <input type="checkbox"/> <input type="checkbox"/> <input type="checkbox"/> 0 0
Product function/ type of input signal	Single-range converters, active	0 0	3-way separation, input 0 ... 10 V
		0 2	3-way separation, input 0 ... 20 mA,
		0 3	3-way separation, input 4 ... 20 mA,
	Multi-range converters, active, switchable	0 5	3-way separation, 3 standard signals can be switched 0 ... 10 V, 0/4 ... 20 mA
	Universal converters, active, switchable	0 6	3-way separation, 16 signals can be switched
	Single-range converters, passive	2 0	2-way separation, 4 ... 20 mA
	Multi-range converters, active, switchable	2 5	3-way separation, with manual/automatic switch and setting potentiometer
Connection type	Screw terminals		1
	Spring-loaded terminals (push-in)		2
Type of output signal	0 ... 10 V		A
	0 ... 20 mA		C
	4 ... 20 mA		D
	Loop power isolator 4 ... 20 mA		E
	3 standard signals can be switched		F
	4 frequencies can be switched		K
Supply voltage	24 V AC/DC		E
	None		T
	24 ... 240 V AC/DC		W
Example		3RS70 0 0 - 1 A E 0 0	

Note:

The Article No. scheme shows an overview of product versions for better understanding of the logic behind the article numbers.

For your orders, please use the article numbers quoted in the selection and ordering data.

Benefits

- Narrow width
- Easy-to-set universal converters
- Converters with frequency output
- All ranges are fully calibrated
- Universal family of devices – the perfect solution for every application
- Integrated manual/automatic switch with a setpoint generator
- Outputs are short-circuit proof
- Up to 30 V – protected against damage caused by wiring errors

Application

Signal converters are used in analog signal processing for

- Electrical separation
- Conversion of normalized and non-normalized signals
- Amplification and impedance adaptation
- Conversion to a frequency for processing by a digital input
- Overvoltage and EMC protection
- Short-circuit protection of the outputs

3RS7025 manual/automatic converter

For special applications in which analog signals have to be simulated, or during plant commissioning when the actual process value is not yet available, the 3RS7025 devices feature a setting potentiometer for manual setpoint selection and a manual/automatic switch.

The setting potentiometer for the 3RS7025 devices is used to simulate analog output signals when the changeover switch is set to "Manual" and the control supply voltage is applied, without the need for an analog input signal. The scale ranges from 0 to 100%.

Example: When it is set for an output of 4 to 20 mA, the left stop on the potentiometer represents an output current of 4 mA and the right stop represents an output current of 20 mA. In the "Auto" switch position, the output signal follows the input signal proportionally regardless of the potentiometer setting.

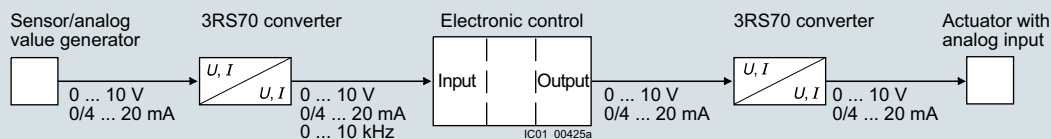

Application example of analog signal processing

Monitoring and control devices

Relays

Coupling relays and signal converters

SIRIUS 3RS70 signal converters

Technical specifications

More information

Technical specifications, see
<https://support.industry.siemens.com/cs/ww/en/ps/16691/td>
 Operating Instructions, see
<https://support.industry.siemens.com/cs/ww/en/view/109475738>

Internal circuit diagrams, see
<https://support.industry.siemens.com/cs/ww/en/view/109475738>

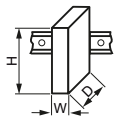
Article number	3RS7000-.AE00	3RS7002-.AE00, 3RS7003-.AE00	3RS7000-.CE00, 3RS7000-.DE00	3RS7002-.CE00, 3RS7002-.DE00, 3RS7003-.CE00, 3RS7003-.DE00	3RS7020-.ET00
Product designation Product version	Single-range converters, active				Single-range converters, passive
General data:					
Dimensions (W x H x D)	 mm				6.2 × 93 × 71
Ambient temperature					
• During operation	°C	-25 ... +60			
• During storage	°C	-40 ... +80			
Relative humidity during operation	%	10 ... 95			
Insulation voltage for overvoltage category III acc. to IEC 60664 for pollution degree 3, rated value	V	50			
Active power input	W	0.29			
Degree of protection		IP20			
Input:					
Input voltage					
• Max.	V	30			
Input impedance					
• Of current input, maximum	Ω	--	100	--	100
• Of voltage input, minimum	kΩ	330	--	330	--
Output:					
Load					
• Maximum at current output	Ω	--	500		1 000
• Minimum at voltage output	kΩ	2	--		--
Relative measuring accuracy	%	0.1			
Short-circuit-proof		Yes			No

Monitoring and control devices

Relays

Coupling relays and signal converters

SIRIUS 3RS70 signal converters

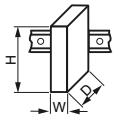
Article number		3RS7005- .FE00	3RS7005- .KE00	3RS7005- .FW00	3RS7005- .KW00	3RS7025- .FE00	3RS7025- .FW00
Product designation Product version		Multi-range converters, active, switchable				Multi-range converters, active, switchable, with manual/automatic switch and setting potentiometer	
General data:							
Dimensions (W x H x D)	 mm	6.2 × 93 × 72.5		17.5 × 93 × 72.5		17.5 × 93 × 75	
Ambient temperature		°C					
• During operation		-25 ... +60					
• During storage		-40 ... +80					
Relative humidity during operation		%					
		10 ... 95					
Insulation voltage for overvoltage category III acc. to IEC 60664 for pollution degree 3, rated value	V	50		300		50	300
Active power input	W	0.29		0.5	0.34	0.5	
Degree of protection		IP20					
Input:							
Input voltage		V					
• Max.		30					
Input impedance		Ω					
• Of current input, maximum		100					
• Of voltage input, minimum		kΩ					
		330					
Output:							
Load		Ω					
• Maximum at current output		500	--	500	--	500	
• Minimum at voltage output		kΩ	2	--	2	--	2
Relative measuring accuracy	%	0.1					
Short-circuit-proof		Yes					



Monitoring and control devices

Relays

Coupling relays and signal converters

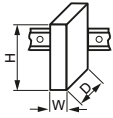
SIRIUS 3RS70 signal converters

Article number		3RS7006-FE00	3RS7006-FW00
Product designation Product version		Universal converters, active, switchable	
General data:			
Dimensions (W x H x D)		mm	17.5 x 93 x 72.5
Ambient temperature		°C	-25 ... +60
• During operation		°C	-40 ... +80
• During storage			
Relative humidity during operation		%	10 ... 95
Insulation voltage for overvoltage category III acc. to IEC 60664 for pollution degree 3, rated value		V	50
			300
Active power input		W	0.5
Degree of protection			IP20
Input:			
Input voltage		V	30
• Max.			
Input impedance		Ω	100
• Of current input, maximum		kΩ	330
• Of voltage input, minimum			
Output:			
Load		Ω	500
• Maximum at current output		kΩ	2
• Minimum at voltage output			
Relative measuring accuracy		%	0.1
Short-circuit-proof			Yes

Article number	3RS70..-1....	3RS70..-2....
Type of electrical connection	 Screw terminals	 Spring-loaded terminals (push-in)
Type of connectable conductor cross-sections		
• Solid	1 x (0.25 ... 2.5 mm ²)	1 x (0.25 ... 2.5 mm ²)
• Finely stranded	--	1 x (0.25 ... 2.5 mm ²)
- Without end sleeves	1 x (0.25 ... 1.5 mm ²)	1 x (0.25 ... 1.5 mm ²)
- With end sleeves	1 x (20 ... 14)	1 x (20 ... 14)
• Solid for AWG cables		

Selection and ordering data

Signal type		Supply voltage	Width	SD	Article No.	Price per PU	PU (UNIT, SET, M)	PS*	PG
At the input	At the output		mm	d					

Single-range converters

Passive

Type of electrical separation, 2-way

4 ... 20 mA	4 ... 20 mA	--	6.2	▶	3RS7020-□ET00		1	1 unit	41H
-------------	-------------	----	-----	---	----------------------	--	---	--------	-----

Active

Type of electrical separation, 3-way

0 ... 10 V	0 ... 10 V	24 V AC/DC	6.2	▶	3RS7000-□AE00		1	1 unit	41H
0 ... 20 mA	0 ... 10 V	24 V AC/DC	6.2	2	3RS7002-□AE00		1	1 unit	41H
4 ... 20 mA	0 ... 10 V	24 V AC/DC	6.2	▶	3RS7003-□AE00		1	1 unit	41H
0 ... 10 V	0 ... 20 mA	24 V AC/DC	6.2	2	3RS7000-□CE00		1	1 unit	41H
0 ... 20 mA	0 ... 20 mA	24 V AC/DC	6.2	2	3RS7002-□CE00		1	1 unit	41H
4 ... 20 mA	0 ... 20 mA	24 V AC/DC	6.2	2	3RS7003-□CE00		1	1 unit	41H
0 ... 10 V	4 ... 20 mA	24 V AC/DC	6.2	2	3RS7000-□DE00		1	1 unit	41H
0 ... 20 mA	4 ... 20 mA	24 V AC/DC	6.2	2	3RS7002-□DE00		1	1 unit	41H
4 ... 20 mA	4 ... 20 mA	24 V AC/DC	6.2	▶	3RS7003-□DE00		1	1 unit	41H



3RS7000-1AE00



3RS7000-2AE00

Multi-range converters

Active, switchable

Type of electrical separation, 3-way

0 ... 10 V,	0 ... 10 V,	24 V AC/DC	6.2	▶	3RS7005-□FE00		1	1 unit	41H
0 ... 20 mA,	0 ... 20 mA,	24 ... 240 V AC/DC	17.5	▶	3RS7005-□FW00		1	1 unit	41H
4 ... 20 mA	4 ... 20 mA								
0 ... 50 Hz		24 V AC/DC	6.2	2	3RS7005-□KE00		1	1 unit	41H
0 ... 100 Hz		24 ... 240 V AC/DC	17.5	2	3RS7005-□KW00		1	1 unit	41H
0 ... 1 kHz									
0 ... 10 kHz									



3RS7005-1FW00

Active, switchable, with manual/automatic switch and setting potentiometer

Type of electrical separation, 3-way

0 ... 10 V,	0 ... 10 V,	24 V AC/DC	17.5	2	3RS7025-□FE00		1	1 unit	41H
0 ... 20 mA,	0 ... 20 mA,	24 ... 240 V AC/DC	17.5	2	3RS7025-□FW00		1	1 unit	41H
4 ... 20 mA	4 ... 20 mA								

Universal converters

Active, switchable

Type of electrical separation, 3-way

0 ... 60 mV,	0 ... 10 V,	24 V AC/DC	17.5	2	3RS7006-□FE00		1	1 unit	41H
0 ... 100 mV,	0 ... 20 mA,	24 ... 240 V AC/DC	17.5	2	3RS7006-□FW00		1	1 unit	41H
0 ... 300 mV,	4 ... 20 mA								
0 ... 500 mV,									
0 ... 1 V,									
0 ... 2 V,									
0 ... 5 V,									
0 ... 10 V,									
0 ... 20 V,									
2 ... 10 V,									
0 ... 5 mA,									
0 ... 10 mA,									
0 ... 20 mA,									
4 ... 20 mA,									
-5 ... +5 mA,									
-20 ... +20 mA									



3RS7006-1FE00

Type of electrical connection

- Screw terminals
- Spring-loaded terminals (push-in)

1
2



Monitoring and control devices

Relays

Coupling relays and signal converters

SIRIUS 3RS70 signal converters

Accessories

Version	SD	Article No.	Price per PU	PU (UNIT, SET, M)	PS*	PG
Galvanic isolation plates						
		Galvanic isolation plates For electrical separation of different potentials when devices of different types are installed side by side				
3RQ3900-0A	d	3RQ3900-0A		1	10 units	41H
Connecting combs						
		Connecting combs For linking the same potentials, current-carrying capacity for infeed of max. 6 A				
3RQ3901-0B		<ul style="list-style-type: none"> ▶ 2-pole ▶ 4-pole ▶ 8-pole ▶ 16-pole 		1	10 units	41H
				1	10 units	41H
				1	10 units	41H
				1	10 units	41H
Clip-on labels						
		Clip-on labels For terminal and equipment labeling, white				
		• 5 x 5 mm ¹⁾		100	2000 units	41H
Tools for opening spring-loaded terminals						
		Screwdrivers For all SIRIUS devices with spring-loaded terminals Length approx. 200 mm, 3.0 mm x 0.5 mm, titanium gray/black, partially insulated				
3RA2908-1A				1	1 unit	41B

¹⁾ PC labeling system for individual inscription of unit labeling plates available from: Conta-Clip Verbindungstechnik GmbH, see page 16/16.