

INSTALLATION AND OPERATING INSTRUCTIONS



AIR TO WATER HEAT PUMP WITH DC INVERTER

- Split type, Series 1 -

MODELS: KS200-DC / KS250-DC

- HEATING & COOLING



CE RoHS

Please read this instruction manual before using the heat pump.

July 2019

WELCOME

Congratulations on your selection of our heat pump for your comfort conditioning requirements.

Your home is fitted with a unique renewable heating technology, allowing you to benefit from lower running costs and a more even temperature throughout your home.

An air source heat pump collects and utilizes thermal energy from the outside air to heat the home and provide domestic hot water. The heat generated can be used to warm water for radiators, underfloor heating system or provide domestic hot water in your home.

The heat pump is designed as split type, indoor unit and outdoor unit be connected by copper pipe, installation with simple, flexible and conveniently. The indoor unit can be Installed in kitchen, bathroom or basement, ensuring less energy loss, also prevent water pipes from freezing in cold winter and sun exposure in hot Summer.

Indoor unit include: LCD controller, Honeywell three way valve, water flow switch, WILO/Grundfos water pump, GEA/SWEP plate heat exchanger and inside connection, with different control languages, with remote control function(optional), additional electrical heater as back up.

Outdoor unit include: Sanyo/ Hitachi DC inverter compressor, larger evaporator, reliable inverter PCB, green refrigerant R410a, electrical expansion valve, compressor heater, condenser bottom heater and compressor heater which helpful for defrosting.

To enhance the use of your heat pump, you will want to read and carefully follow all of instructions contained in this Installation and Operating Instruction.

Please retain this manual for your future reference. We suggest that you retain it with other important documents.

We hope you enjoy a warm and comfortable winter season!

Summary

1. Warning	p4
2. Safety warnings	p4
3. Principle of working	p5
4. Checking before and after starting	p5
5. Pump capacity diagrams	p6
6. Installation outdoor unit	p7
7. The step and diagram of collect refrigerant	p8
8. Diagram for installation and connection	p9
9. Pipe connection for floor heating only	p9
10. Filling & venting the water circuit system	p10
11. Installation master plan	p11
12. Description of the display panel and menu	p12
12.1 Control Panel	p12
12.2 Functions	p12
12.3 Symbols	p13
12.4.1 Main Menu INFORMATION	p13
12.4.2 Sub-Menu OPERATION	p14
12.4.3 Sub-Menu HEAT CURVE	p15
12.4.4 Sub-Menu TEMPERATURE	p16
12.4.5 Sub-menu INTEGRAL	p17
12.4.6 Sub-Menu TIME SETTING	p20
12.4.7 Sub-Menu DEFROST	p21
12.4.8 Sub menu – SETTING	p22
12.4.9 Sub-Menu OPERATING TIME	p25
12.4.10 Sub-Menu MAN TEST	p25
12.4.11 Sub-Menu ALARM RECORD	p25
12.4.12 Sub-Menu LANGUAGE	p25
12.4.13 Sub-Menu RESET	p25
12.4.14 Adjustments made regularly	p26
12.4.15 Adjustment of CURVE value	p26
12.4.16 Adjustment of ROOM value (CURVE ROOM)	p27
12.4.17 Adjustment of Part of the heat curve	p28
12.4.18 Adjustment of HIGH T STOP and LOW T STOP	p29
12.4.19 Adjustment of the MIN and MAX value	p29
12.4.20 Graph of recent changes in TEMPERATURE.....	p30
13. Circuit board picture	p30
14. Error codes	p31
15. Alarm messages & what to do	p31
16. Sensors resistance table	p36
17. List of components	p37
18. Dimensions	p39
19. Wiring diagrams	p40
20. Technical characteristics	p41

1. Warnings

This manual is an integral part of the machine and must always be reachable in your technical room.

This Heat pump is meant exclusively for heating or cooling.

Any other non-conform and random use will be considered as dangerous and unsuitable.

The assembly, the electric connection and the start up must be carried out by specialized and professional staff.

It is essential to maintain the temperature in the DC INVERTER lower than the value recommended by the DC INVERTER's manufacturer.

You'll have to inform your retailer of any breakdown or error message; have the maintenance works done by specialized staff.

In a concern of constant improvement, our products can be modified without notice; the pictures or the characteristics described in this manual are not contractual.

2. Safety warnings

- Must be installed and serviced by qualified, trained installation personnel.
- Must be installed according with installation and operating instructions.
- Must be operated with all chassis sheet metal parts, all enclosure (cabinet) parts in place.
- Intended for outdoor use only.
- Electric shock hazard - disconnect from live electric cuit before servicing.
- Moving parts hazard - disconnect from live electric cuit before servicing.
- Read this entire manual before installing operating the unit.
- Must be operated on a dedicated single circuit with proper electrical over current protection.

Do not go up on the heat pump or do not try and move it once installed. Never cover (risk of overheating). Keep out of reach of children, and do not to let them play around; inform them of the dangers of this machine. Never introduce a stick or your fingers into the protective grille of the ventilation; the last one turns very quickly. Never clean the machine with the water jet.

Never disconnect the machine when it's working; for any intervention even of cleaning, stop the machine, by pressing first on the key OFF; in the event of an emergency, cut off the current on the table. Do not draw on the electric wire (risk of electric shock)

Warning:

When the heat pump runs at maximum frequency, the maximum current could be close to 50A, that the heat pump shall be installed in accordance with local wiring regulations, otherwise will cause danger.

3. Principle of working

The operation of the heat pump is shown below. A heat pump works on the same principle as a fridge using a refrigerant fluid which boils at low temperature. Free energy is taken from the air to boil the refrigerant in the evaporator coil, changing it from a liquid to a vapour. This low grade heat is upgraded by the compressor increasing its pressure, and consequently its temperature, to a useful high temperature. The heat is transferred to your heating system by the condenser, where the refrigerant becomes liquid once again. The liquid refrigerant is then expanded using an expansion valve to a low pressure fluid before repeating cycle. 60-80% of the heat generated by the heat pump comes from the free energy taken from the air, compared to 20-40% generated by the electricity used to power the heat pump.

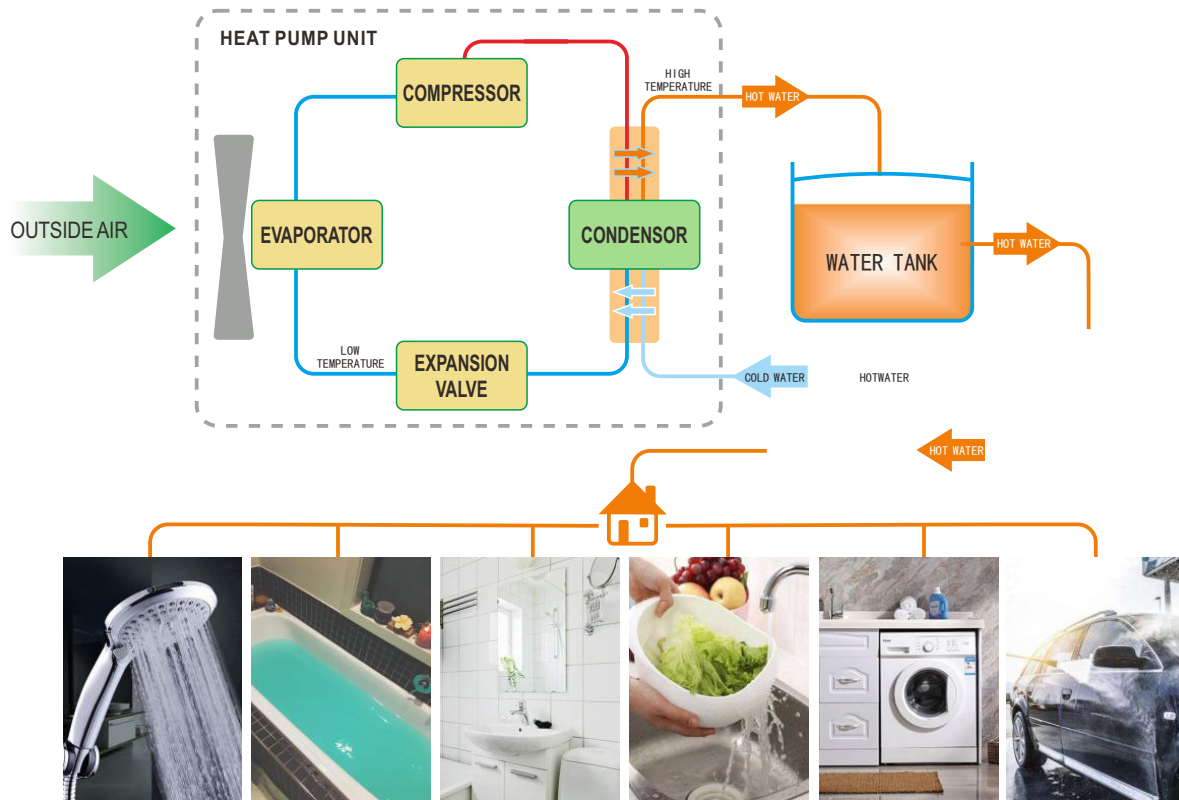

4. Checking before and after starting

Before starting:

Your machine is tested and regulated in factory; however it is advised to carry out the following controls before starting:

- Electric connections correctly carried out
- Installation carried out according to our recommendations
- Correct connection of arrival and exit water pipes according to the written indications
- No foreign things on the machine or fixed on the gills of the radiator

After starting:

Ensure that operation is regular; if high vibrations occur, stop the Heat pump and call your fitter.

5. Pump capacity diagrams

Wilo-Yonos PARA High Flow 25/10

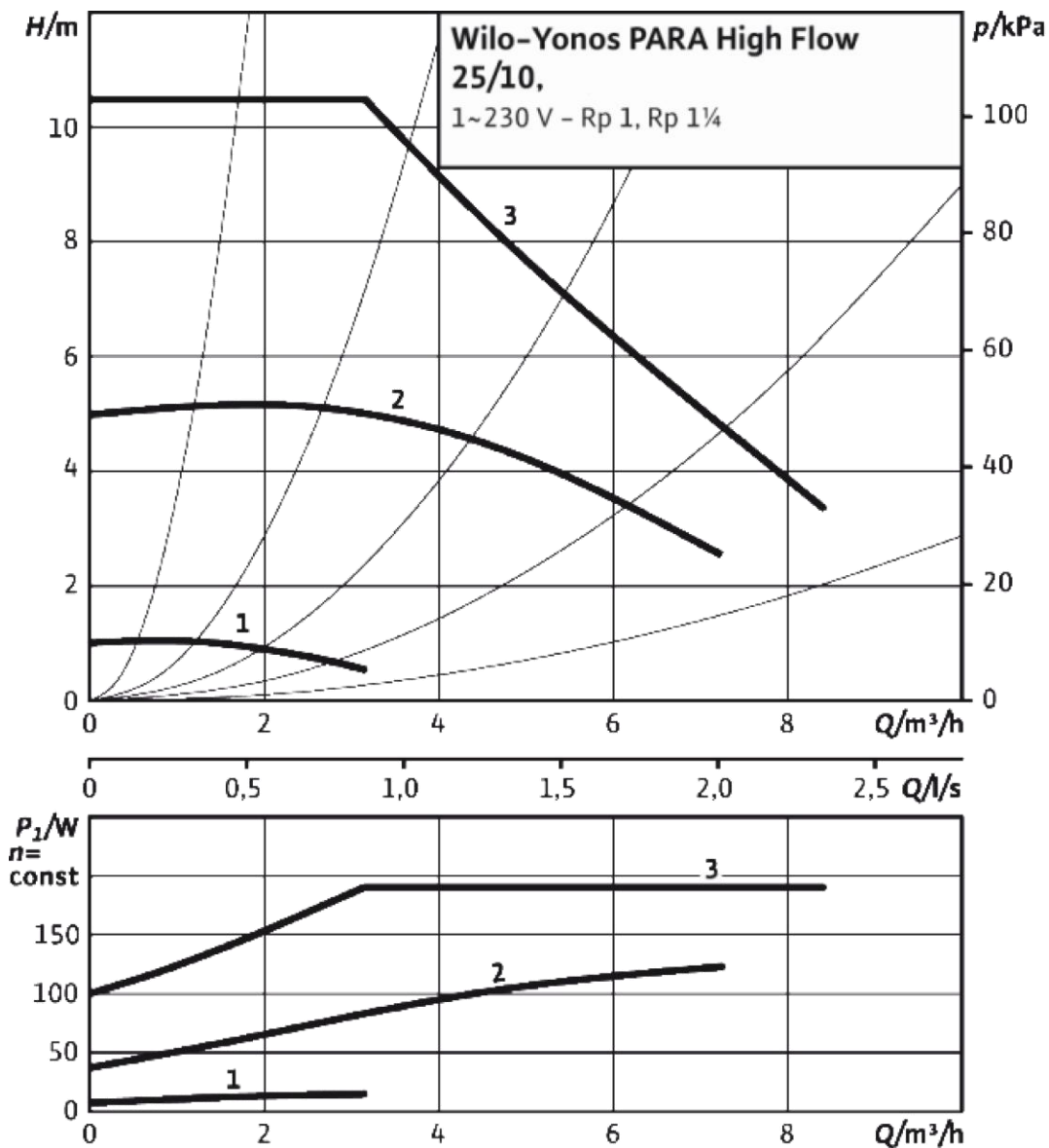

6. Installation outdoor unit

6.1 Select the installation place of outdoor unit

- The outdoor unit should be installed on a solid wall and fastened securely.
- The following procedure must be observed before connecting the pipes or electric cables.
 - 1) Decide which is the best position on the wall and leave enough space to be able to carry out maintenance easily.
 - 2) Fasten the outdoor unit support to the wall using screw anchors which are particularly suited to that type of wall.
 - 3) Use a larger quantity of screw anchors than normally required for the weight they have to bear: during operation the machine vibrates and has to remain fastened in the same position for years without the screws becoming loose.
 - 4) Mount the outdoor unit on the support using the four bolts supplied.
 - 5) Ensure rubber foot are fitted to reduce vibration.

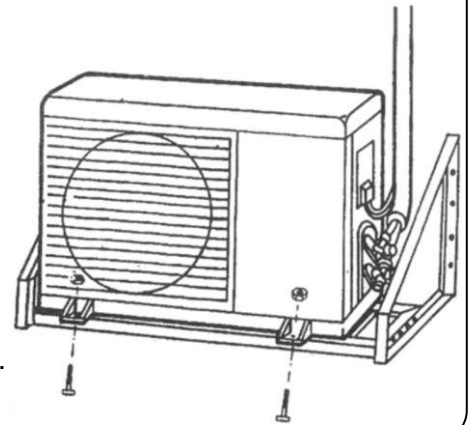

6.2 Piping connection

- 1) Open the cover of the outdoor unit.
- 2) Connect the pipe to the indoor unit and outdoor unit.
 - * Wipe the quick connectors with clean cloth to prohibit dust and impurity entering the pipes.
 - * Align the centre of the pipe and fully screw in the angular nuts with finger.

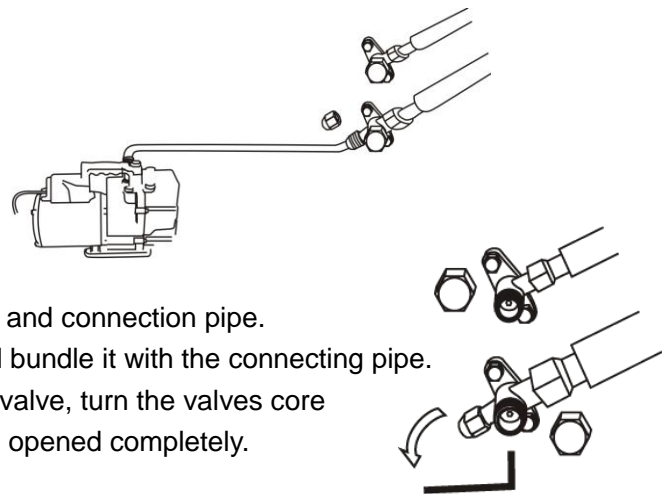
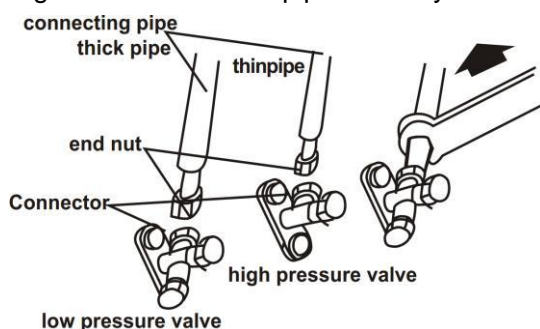

- 3) Use Vacuum pump to remove the air from indoor unit and connection pipe.
- 4) Connect the electric cable as per circuit diagram, and bundle it with the connecting pipe.
- 5) Take off the nuts in the mouths of high valve and low valve, turn the valves core anticlockwise with hexagon spanner till the valves are opened completely.
Recover and tighten the nuts.
- 6) Check leakage: check if there is leakage at each connection of the pipes or nuts. If yes, remedial measure must be taken, leakage is not permitted in any case.

Attention :

- * When connecting the pipe, a suitable pitching spanner must be used. If other spanner is used, it may damage the joint due to inappropriate force.
- * On connecting the pipe, one should ensure that the insulating material of the pipe be closely fitted to the nuts at the joint.
- * On connecting to the external unit, the pipe should be wrapped with sponge padding to prevent rain water from flowing in.
- * When bending the pipe, the radius cannot be too small and be about 150~ 160 mm.
- * KS200-DC / KS250-DC, to add 30g refrigerant per meter after 10 meter pipe runs, suggest the length is not more than 20 meters.

7. The step and diagram of collect refrigerant

If the machine needs to be disconnected and moved to another place or refrigerant charging, please recycle the gas back into the compressor according to the following steps before doing the disconnecting:

1. Turn to the menu: OPERATION---MAN TEST

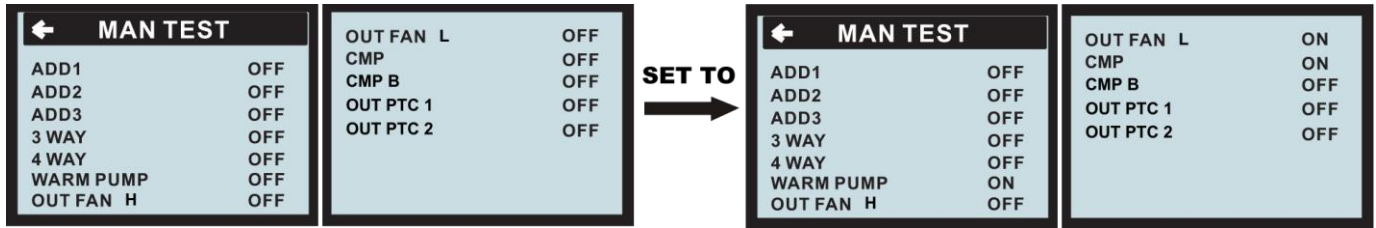

2. Remove the cap of two valves with the spanner.

3. Tighten the core of the liquid valve (the smaller one) with valve key at first .
After about 20 seconds, tighten the core of the gas (the bigger one) with valve key.

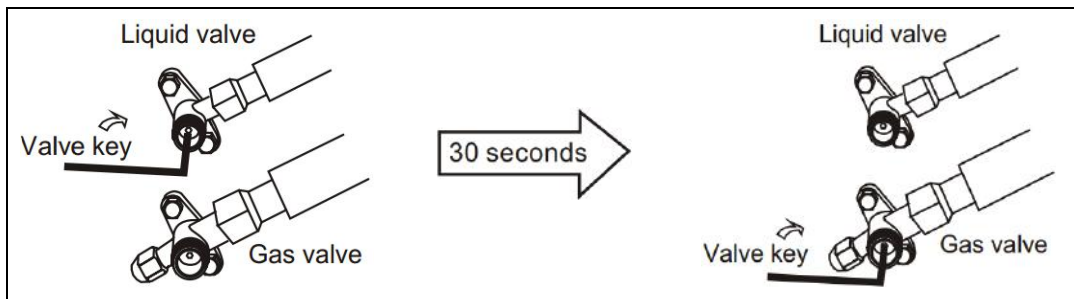
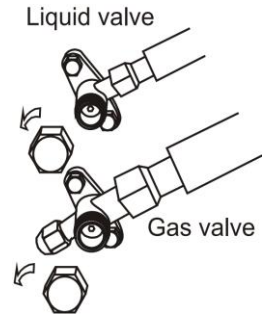

4. Exit the " MAN TEXT " at once or turn the " WARM PUMP " , " OUT FAN " , " CMP " to OFF, at that time the HEATPUMP was stopped.

5. Tighten the cap of two valves.

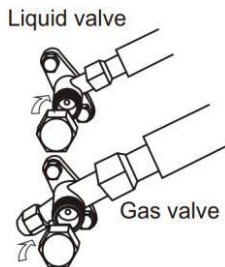

6. loose the nut of the connect pipe to the outdoor unit valve with 2 spanner, disconnect the connect pipe and the two valves.

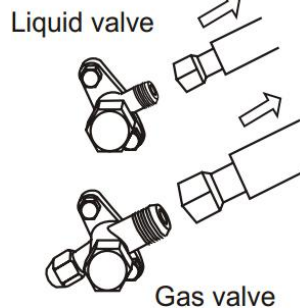
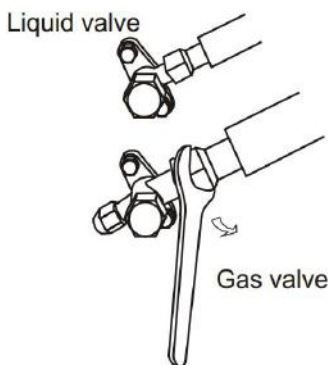

8. Diagram for installation and connection

Using for floor heating and water tank heating

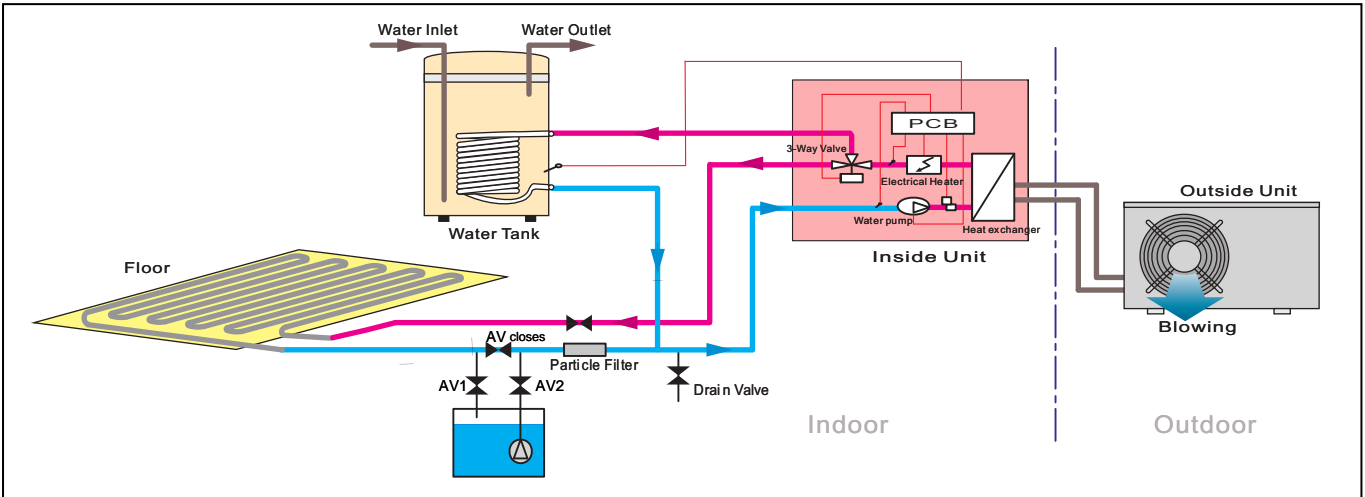

Using for radiator and water tank heating

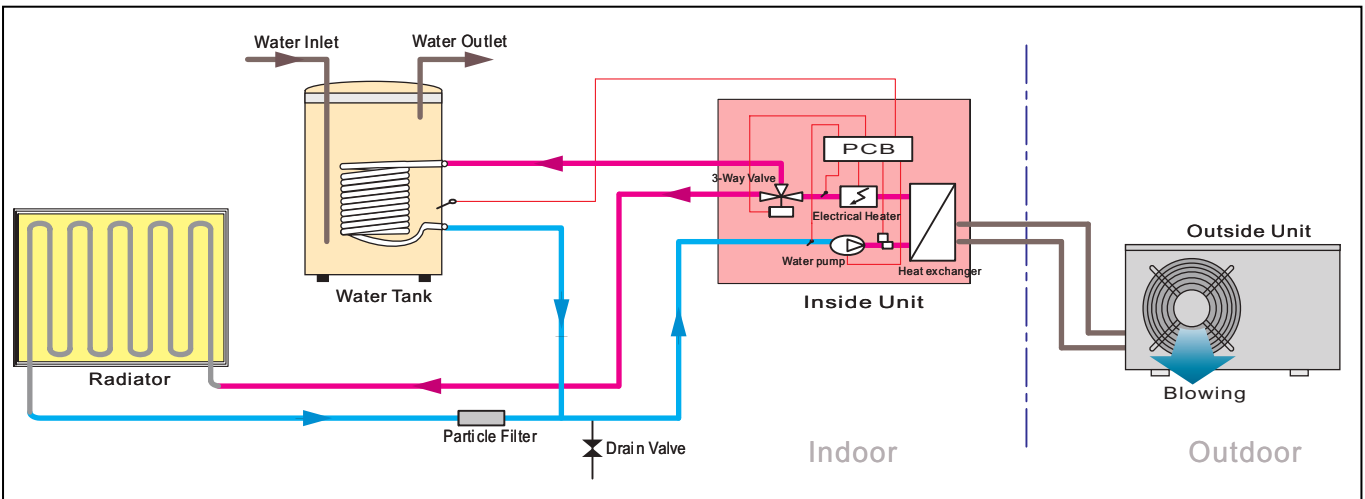

WARNING	
	To use flow gauge to get the correct flow for each unit.

WARNING	
	Ensure inline filter on the return line.

9. Pipe connection for floor heating only

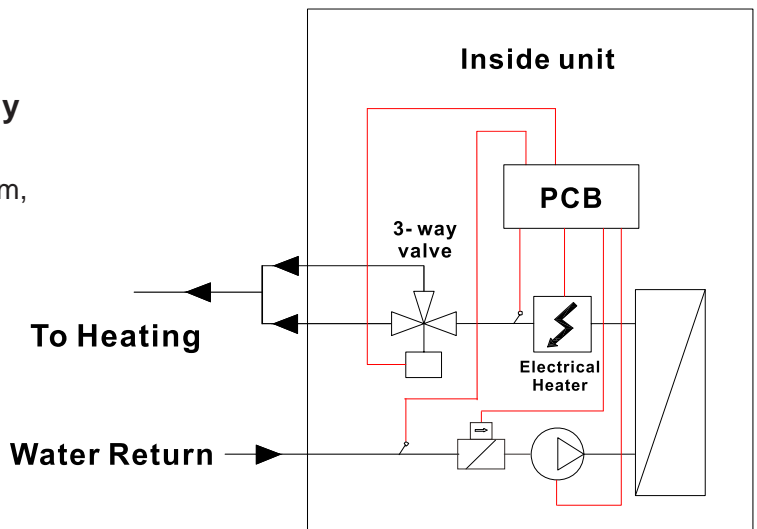

When the system is used for floor heating only, please connect the pipe according to the diagram, in order to make the system run effectively.

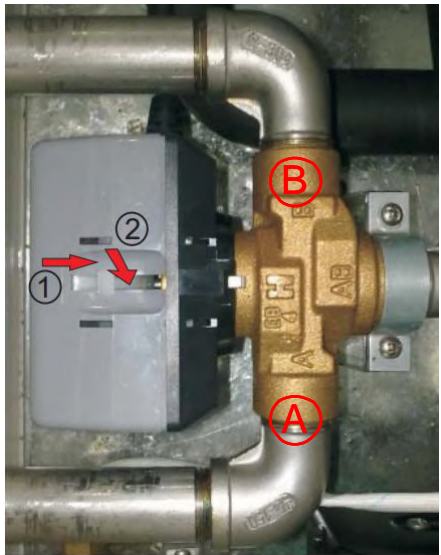
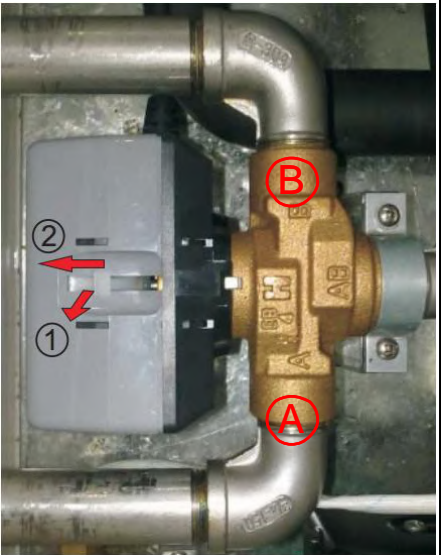
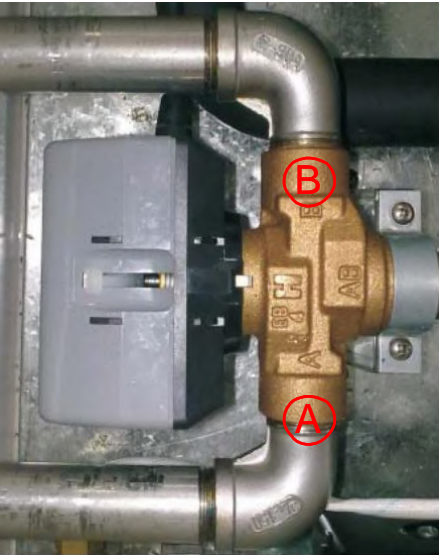

10. Filling & venting the water circuit system

1. Check the heating medium system for leakage;
2. Please follow the fig.1 (on page 10) to connect the pipeline, the water filling pump and the service connections; the capacity of external filling pump must be at least 3 m3/h;
3. Before galvanize to heat pump, Three Way Valve was in "A" state (the state when heat pump leave factory). First of all please close the drain valve and AV valve between the service connections, open AV1/AV2 valves, then start the external water filling pump to evacuate the air inside floor or radiator system. The evacuation time is decided by your load, to evacuate until has not more air coming out.
4. To galvanize the heat pump, Three Way valves gear will turns automatically, at the time "B" port is in open state; please push the white gear of Three Way Valve to the position of middle then press it inside; at the time, both port A and port B are in open state, then evacuate the air in whole water system, it needs a longer time to finish evacuation until has not more air come out from return water pipe.
5. After finish the air evacuation, please use screwdriver to unclench the white gear of Three Way Valve , then it will turn back to port B automatically;
6. Shut the external water filling pump, and close AV1 and AV2 valves, then open AV valve;
7. Recommendation: it would better to install an evacuation valve on the highest place of water system, and it is necessary to have long term water complementarity equipment.

		
<p>Push the white gear onto the position of middle, and then use your thumb to press it inside, this time both port A and port B are in open state.</p>	<p>Please use screwdriver to unclench the white gear of the three way valve</p>	<p>Then the white gear will move back to the original position. The three way valve will turn to port B automatically.</p>

WARNING	
	<p>TO CLEAN SYSTEM WITH A POWER FLUSH BEFORE INSTALLING THE HEAT PUMP AND FILL WITH CLEAN WATER.</p>
	<p>IT IS ADVISED THAT INSTALLATION OF EVACUATION VALVE SHOULD BE AT THE HIGHEST POINT.</p>

11. Installation master plan

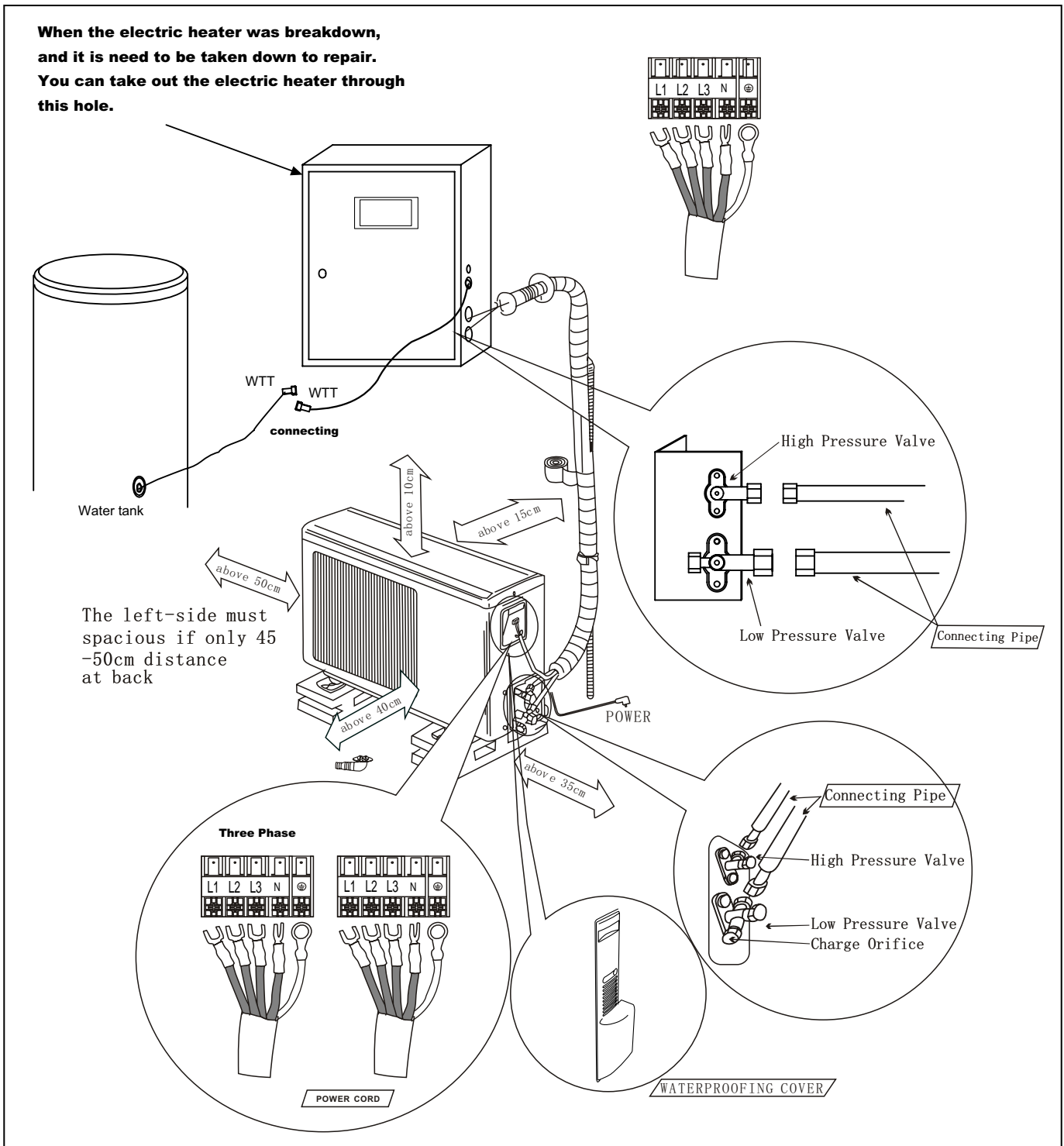

WARNING:

- Please put the water tank sensor at one-third of water tank from bottom.
If heat pump no needs to connect water tank, it must be connected with water tank sensor on the terminal, and put the sensor as the place as Room heating flow' s sensor, to ensure heat pump works normally.
- If the outdoor unit is situated on the ground, rubber feet must be fixed to the bottom of the unit, to help with vibration.
- When no need to use the heat pump in winter,

please drain the system's water out completely, to prevent the damage for heat exchanger.

- To ensure the heat pump's efficiency and safety, please periodicity clean the water circuit inside heat pump.
- To Add antifreeze, according to local installation requirements and climate condition.
- Electrical installation and service must be carried out under the supervision of a qualified electrician in accordance with the stipulations in force.

12. Description of the display panel and menu

12.1 Control panel

The control panel of DC inverter series features a graphic display with five control buttons.







12.2 Functions

The control computer is operated via a menu system displayed on the control panel.

There is a main menu and several sub-menus accessible from the main menu. The menus are described in detail later.

To be able to select the desired menu and adjust the commands, you will use the five buttons.

	ON/OFF
	up and down buttons are used to navigate between the parameters of a menu, also used if you wish to increase or reduce a preset value.
	left-hand button is used to return to the previous menu.
	right-hand button on the control panel is used to open the desired menu.
	A cursor (arrow) on the left-hand side of the display indicates which menu can be opened.

When display at the interface, press right and Left button at the same time for 5 seconds to lock the display. All buttons are not available after lock is active, until press Right button and Left at the same time for 5 seconds to open the lock.

Display of current operating mode

During normal operation, the following information will be displayed:



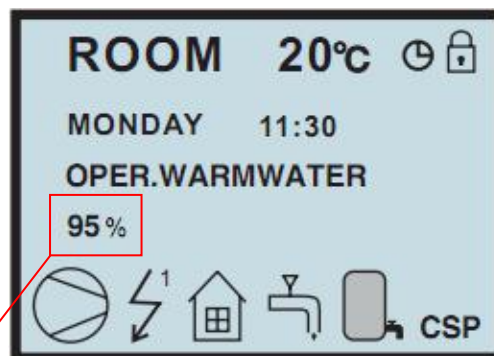



- Desired (preset) room temperature
- Date / time / timer
- Whether there is a heating demand or not. If there is, there will also be symbols telling which heat source is working, heat pump or auxiliary heater or both (see "Symbols").
- Which operating mode has been selected.



The running speed percentage of compressor

12.3 Symbols

For you to know at a glance the actual operating mode of the heat pump, each of the following symbols will be shown in the lower part of the display depending on which part of the unit is working:

Symbols	description
	The heat pump is running.
95%	Running speed percentage of compressor
	The auxiliary heater is activated.
	There is a room heating demand.
	Warm water is being produced
	Indicates the status of warm water production. If the symbol is empty, warm water temperature is under the setting temperature. It does not mean that there is no water in the water tank. The tank is always full.
	If the symbol is full, warm water temperature reached to the setting temperature.
	There is a room cooling demand. * for heating and cooling unit type
CSP	if display CSP message, means compressor stop for pressure protection. This message will be automatically disappear.
HDO	When this symbol appears, the heat pump is not running due to external signal stop it; heat pump will restore running as soon as signal input again.

NOTICE

	During heat pump running, if the water tank symbol twinkles once in every second, it means water tank temperature is too low and it is in antifreezing protection. At the time warm water heating will forcibly start until water temperature get to 20 °C, then go back to previous running mode.
---	--

12.4 Menus

12.4.1 Main Menu INFORMATION

To open the main menu INFORMATION, press the Right button once. To select the desired sub-menu, use the Up and Down button.

Open the menu by pressing the Right button once. To return to main menu, press the Left button once.

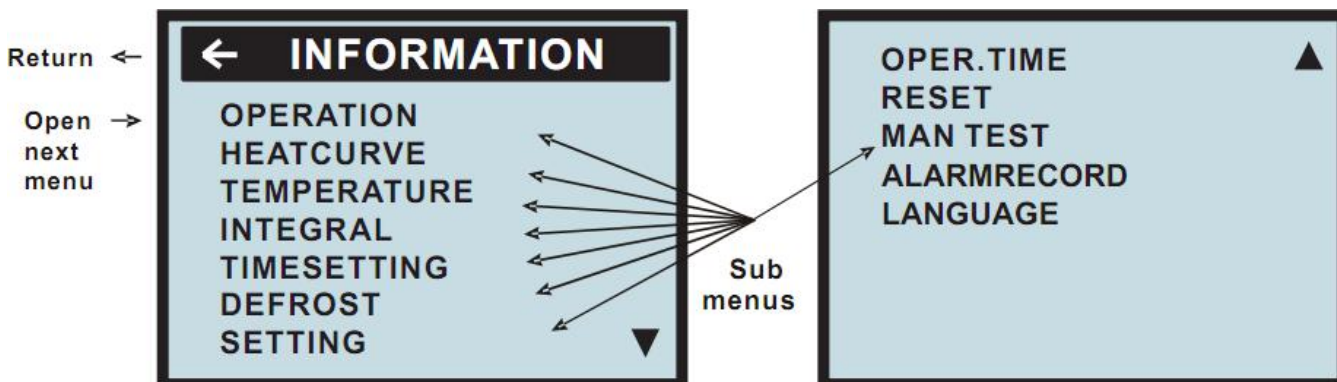

OPERATION

Running mode: Water tank heating, Room heating, Room heating 1, Room heating 2, Auto.

HEATCRVE

The setting of this submenu will affect the room temperature; CURVE is program that adjusts feed water temperature according outdoor ambient temperature, factory setting is ambient temperature 0°C as feed water temperature 40°C, that is CURVE =40; the value of CURVE is adjustable from 22°C to 56°C. How to change the slope—two points decide one beeline, point one is (0,40), the other point could be (18,24), the point (18,24) is not changing when changing the slope, because factory setting is that heat pump stops when outdoor ambient temperature is 18°C , so the feed water temperature should be 24°C.

TEMPERATURE: Temperature items setting.

INTEGRAL

Integral is a program to set the startup time and distance between compressor and electrical heater, to set stop conditions of compressor and electrical heater. This program is depends on the "feed water temperature degeneration" and Time.

TIMESETTING: To set Time, year, month, date, and week; electrical heater timing, water tank heating timing, whole unit timing.

DEFROST: To set the defrosting manually or automatic defrosting setting.

SETTING: To set Emergency mode 1, Emergency mode 2, night mode, day mode, start conditions of electrical heater.

OPER.TIME: To calculate how much time have been running by compressor, electrical heater.

RESET: Return to factory settings: press button Right to go back all factory settings.

MAN TEST: Engineer testing.

ALARM RECORD: To record 8 alarm histories recently; the newest alarm message will be seen in the first line. Press right button to check alarm history

LANGUAGE: Language selection

12.4.2 Sub-Menu OPERATION

WARMWATER

Water tank heating mode: this mode only heats water tank. Heat pump stops running as soon as water tank's temperature reaches setting temperature. Heat pump re-starts when the temperature drops back. Adjustable from 20°C to 62°C. Factory setting is 45°C.

ROOMHEAT

Room heating mode: this mode only heats room. Heat pump runs according to the relationship between time and feed water temperature. You can change the feed water temperature through slope of the CURVE.

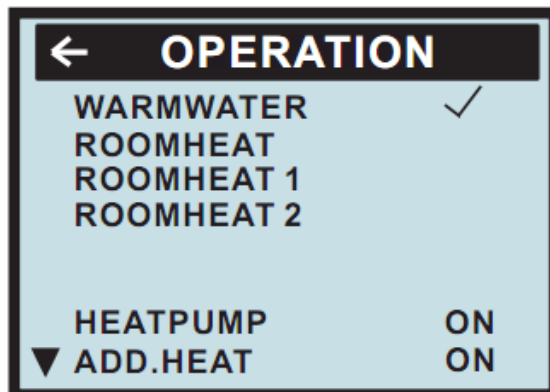

ROOMHEAT 1

Room heating mode 1 heats the room only. In this mode the heat pump runs according to feed water temperature. You can set the feed water temperature directly. Adjustable from 20°C to 65°C. Factory setting is 45°C.

ROOMHEAT 2

Room heating mode 2: this mode only heats room. Heat pump runs according to room air temperature. You can set the room air temperature directly. Adjustable from 16°C to 31°C. Factory setting is 27°C.

ROOM COOL *

Room cooling mode: this mode cools the room only. Heat pump runs according to feed water temperature. You can set the feed water temperature directly. Adjustable from 6°C to 30°C. Factory setting is 18°C.

ROOMCOOL 1 *

Room cooling mode 1: this mode cools the room only. Heat pump runs according to room air temperature. You can set the room air temperature directly. Adjustable from 16°C to 31°C. Factory setting is 24°C.

WARMWATER+ROOMHEAT, ROOMHEAT1 or ROOMHEAT2 or ROOMCOOL or ROOMCOOL 1

Auto mode: Select water tank heating and room heating or room cool at the same time to enter Auto mode. After you enter this mode, water tank heating has the priority. When water tank reaches the setting temperature, 3-way valve will turn to heat room automatically. If water tank temperature decreases, 3-way valve's direction will revert to water tank heating.

HEATPUMP ON or OFF

select **ON**: compressor is on (normal operation)

select **OFF**: compressor and fan motor is off, electrical heater and water pump still works.

ADD.HEAT ON or OFF

select **ON**: auxiliary electrical heater is on.

select **OFF**: auxiliary electrical heater is off

If you wish to change operating mode:

1. open the main menu INFORMATION by pressing Right button once. You will find the cursor at sub-menu named OPERATION.
2. Open the OPERATION menu by pressing Right button once. You will find the cursor at previously selected operating mode.
3. Select the desired mode by pressing either Up and Down button. Return to main menu by pressing Left button twice.

12.4.3 Sub-Menu HEAT CURVE

This menu is used for making adjustments to affect the room temperature. For more information, please refer to "Adjustments to be made regularly".

← HEATCURVE	
CURVE	40 °C
MIN	22 °C
MAX	70 °C
CURVE 5	0 °C
CURVE 0	0 °C
CURVE -5	0 °C
▼ CURVE ROOM	10 °C

Menu Text	Description	Adjustable by
CURVE	The value entered shows the temperature of water to be distributed to radiators (feed water temperature) when outside air temperature is 0°C.	User. See “adjustment of CURVE value”.
MIN	Adjustment of value for lowest feed water temperature allowed.	User. See “adjustment of MIN &MAN value”.
MAX	Adjustment of value for highest feed water temperature allowed.	User. See “adjustment of MIN &MAN value”.
CURVE 5	Adjustment of room temperature when outside air temperature is 5°C.	User. See “adjustment of CURVE value”.
CURVE 0	Adjustment of room temperature when outside air temperature is 0°C.	User. See “adjustment of CURVE value”.
CURVE -5	Adjustment of room temperature when outside air temperature is -5°C.	User. See “adjustment of CURVE value”.

NOTE

Please note during the Summer, if you leave the heating ON please set the display to ROOM HEAT 2 (Only applicable to radiator system).

12.4.4 Sub-Menu TEMPERATURE

This menu shows the different temperatures of the heating system. All temperature changes registered over the last 60 minutes are stored in the control system and can be viewed in shape of graphs.

← TEMPERATURE		▲ CONSTANT 6 °C	
ROOM	27(31) °C	RETURN AIR	25 °C
WARMWT	45(50) °C	EEV OUTLET	15 °C
FEED.	45(60) °C		
RETURN	30 °C		
PIPE	22 °C		
OUT	25 °C		
▼ CMPDIF TEMP	5 °C		

WARMWT: water tank temperature

The first value is water tank real temperature, the second value in brackets is water tank setting temperature in WARMWATER mode. The setting temperature is adjustable from 20°C to 62°C. Factory setting is 45°C. Compressor restart must follow the program “CMPDIF TEMP”

ROOM: room air temperature

The first value is room air real temperature, the second value in brackets is room air setting temperature in ROOMHEAT 2 mode. The setting temperature is adjustable from 16°C to 31°C. Factory setting is 27°C.

FEED: The first value is feed water real temperature, the second value in brackets is feed water setting temperature in ROOMHEAT mode which is adjusted by slope of curve according to outdoor ambient temperature. Factory setting is a feed water temperature of 40°C when outdoor ambient temperature is 0°C. That is to say curve =40.

Only under ROOMHEAT 1 mode, FEED setting can adjusted directly from 20°C to 65°C. Factory setting is 45°C. NOT for water tank heating.

RETURN: Display real return water temperature.

PIPE: Display outdoor unit evaporator temperature for defrosting.

OUT: Display real outdoor ambient temperature.

CMPDIF TEMP: Compressor restart determined by the cooling of water tank. This setting is only for water tank heating. it is adjustable from 3°C to 15°C. Factory setting is 5°C.

CONSTANT: This setting is to slow down the compressor speed when heat pump is doing room heating such as under floor heating. It is adjustable from 0 C to 12°C. Factory setting is 6°C.

For example , if you set it 6°C, and the feed water temperature is set to 35°C, then when the water reach $35-6=29$ C , the compressor will slow down its speed. This function is only for room heating mode, not for WARMWATER .

When at item WARMWT, ROOM, RETURN, FEED or PIPE, press Right button for 5 seconds to display the information as a chart showing temperature over one hour.

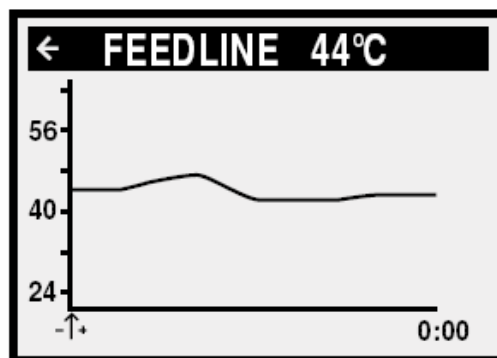

12.4.5 Sub-menu INTEGRAL

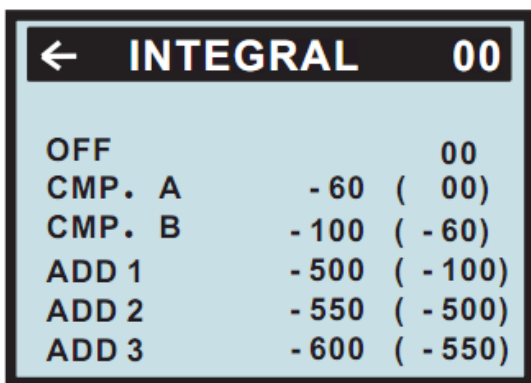

Integral (DM) is a program to set start-up time and distance between compressor and electrical heater according to heat demand and heat output. It also sets stop conditions of compressor and electrical heater. This program is depends on feed water temperature and time.

Enter this to change the factory settings:

Menu Text	Description	Adjustable by
OFF	When current value reaches setting value by user, system closes.	User
CMP A /CMP B	When the current value reaches setting value by user, compressor starts up. When current value is low than setting value, compressor closes.	User
ADD 1 / ADD2 / ADD 3	When the current value reaches setting value by user, electrical heater starts up. When current value is low than setting value, electrical heater closes.	User

Instruction of Integral (DM)

Temperature difference between the feed water and the desired water (°C)	The corresponding value	Temperature difference between the feed water and the desired water(°C)	The corresponding value
-31 ~ -40	-40	1 ~ 10	10
-21 ~ -30	-30	11 ~ 20	20
-11 ~ -20	-20	21 ~ 30	30
-1 ~ -10	-10	31 ~ 40	40

DM = the corresponding value of temperature difference between the feed water and the desired water * running time. It is calculated by integral to change. every minute is cumulative.

For example:

(UNDER DESIRED TEMPERATURE)

Feed water temperature decrease of 1°C under desired temperature in first minutes, $DM = -10 \times 1 = -10$

Feed water temperature decrease of 2°C under desired temperature in second minutes, $DM = -10 \times 1 + (-10) = -20$

Feed water temperature decrease of 2°C under desired temperature in third minutes, $DM = -10 \times 1 + (-20) = -30$

Feed water temperature decrease of 2°C under desired temperature in fourth minutes, $DM = -10 \times 1 + (-30) = -40$

.....

Before the DM reaches -60 (adjustable), the compressor is off but when the DM reaches -60(adjustable), the compressor starts automatically and the flow temperature will increase.

Higher than desired temperature: When the actual water supply temperature reaches a level higher than the desired temperature, DM will be changed.

for example: if DM was set to-160, 1 minute later when the feed water temperature is higher than desired temperature by 1°C, $10 \times 1 = 10$, $DM = 150$

2 minutes later when the feed water temperature is higher than desired temperature by 2°C, $10 \times 1 = 10$, $DM = 140$

3 minutes later when the feed water temperature is higher than desired temperature by 3°C, $10 \times 1 = 10$, $DM = 130$

4 minutes later when the feed water temperature is higher than desired temperature by 4°C, $10 \times 1 = 10$, $DM = 120$

.....

When DM is 0, compressor is off.

The chart describes the running of compressor and electrical heater depending on Integral.

Compressor A's DM is -60 start, 0 off. when $A0 = -60$, compressor A starts up.

Electrical heater 1's DM is -500 start, when the feed water temperature reaches the setting value the electrical heater 1 is off.

$A0 + A2 = -60 - 440 = -500$ start up.

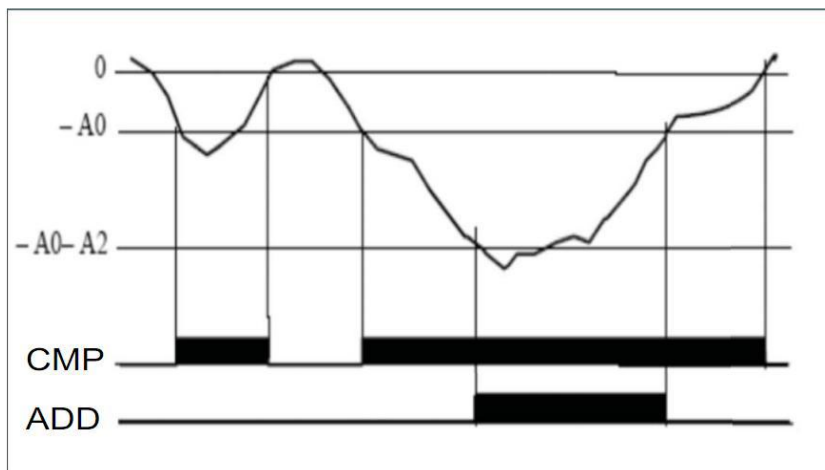

The relationship between on/off and DM.

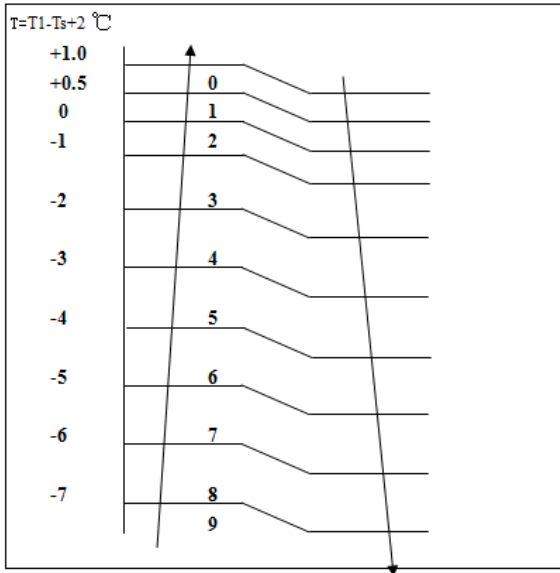

The constant temperature function is only available in Room heating, but not in water tank HEATING.

Constant temperature function has two options: integral (DM) and constant room temperature.

1. The constant area diagram:

T1-- room return water temperature, Ts-- room air setting temperature or feed water temperature.

After compressor start running, when 'setting return water temperature – actual return water temperature ≤ constant temperature setting, and the electrical heater does not start, then enter constant temperature control the temperature and its frequency during constant temperature program as seen on the chart on left.

$\Delta T = T1 - Ts + 2^\circ C$, ΔT has 10 areas, from 0 to 9, the rule of constant follows:

A.) When ΔT is changing,

- a.) When ΔT is increasing, the frequency increases 1 to run
- b.) When ΔT is decreasing, the frequency decreases 1 to run

B.) When ΔT stays within an area for 3 minutes, the rules are as follows:

4~8: The present frequency increases 1 (keep 10 min to increase 1), until the maximum frequency is reached.

3: Frequency is unchanged

0~2: The present frequency decrease 1 to run, until the frequency reaches F1.

2. Constant temperature of Integral

The constant area is from 00 to -600 (DM) IT IS running as integral.

A.) When integral is negative, the frequency is increased by 1 to run. The frequency will run automatically until maximum integral is reached.

B.) WHEN integral is positive, the frequency is decreased 1 to run. The frequency will run automatically until minimum integral is reached.

C.) room air constant temperature

a.) When ΔT is increasing, the frequency increases 1 to run. ΔT will be automatic until frequency reaches maximum.

b.) When ΔT is decreasing the frequency is decreased 1 to run. If the present frequency is f1, the frequency is automatic even if ΔT decreases.

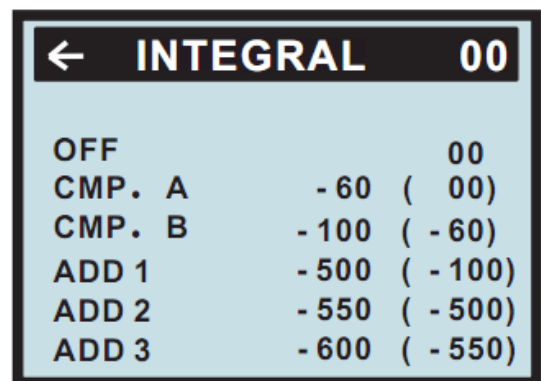

12.4.6 Sub-Menu TIME SETTING

How to enter the sub-menu TIME SETTING

Choose TIME SETTING on the main menu INFORMATION by pressing Right button, TIME SETTING menu can be seen.

TIMESETTING: use Up and Down buttons to select each item.

DATE: To display year, month, day.

DAY: To display the day of the week.

TIME: To display or adjust the time.

ROOM TIME 1 ON

When you choose the symbol "√", the Auto start function of room heating is active. Select "x" to cancel this function. If this function is active the heat pump will start heating room at the time of your choosing.

ROOM TIME 1 OFF

When you choose the symbol "√", the Auto stop function of room heating is active. Select "x" to cancel this function. If this function is active the heat pump will stop heating room at the time of your choosing.

ROOM TIME 2 ON

The second timer for room heating; Function the same with ROOM TIME 1 ON.

ROOM TIME 2 OFF

The second timer for room heating; Function the same with ROOM TIME 1 OFF.

WARMWATER TIME 1 ON

When you choose the symbol "√", the Auto start function of water tank heating is active. Select "x" to cancel this function. If this function is active the heat pump will start heating water tank at the time of your choosing.

WARMWATER TIME 1 OFF

When you choose the symbol "√", the Auto stop function of water tank heating is active. Select "x" to cancel this function. If this function is active the heat pump will stop heating water tank at the time of your choosing.

WARMWATER TIME 2 ON

The second timer for water tank heating; Function the same with WARMWATER TIME 1 ON.

WARMWATER TIME 2 OFF

The second timer for water tank heating; Function the same with WARMWATER TIME 1 OFF.

FURTHER INFORMATION ON THE TIMERS

When setting the timers please note hot water can be set separately and will over ride any hot water settings on the room heat timers.

ADD TIME ON

When you choose the symbol "√", the Auto start function of electrical heater is active. Select "x" to cancel this function. If this function is active the heat pump will start heating by electrical heater at the time of your choosing.

ADD TIME OFF

When you choose the symbol "√", the Auto stop function of electrical heater is active. Select "x" to cancel this function. If this function is active the heat pump will stop heating by electrical heater at the time of your choosing.

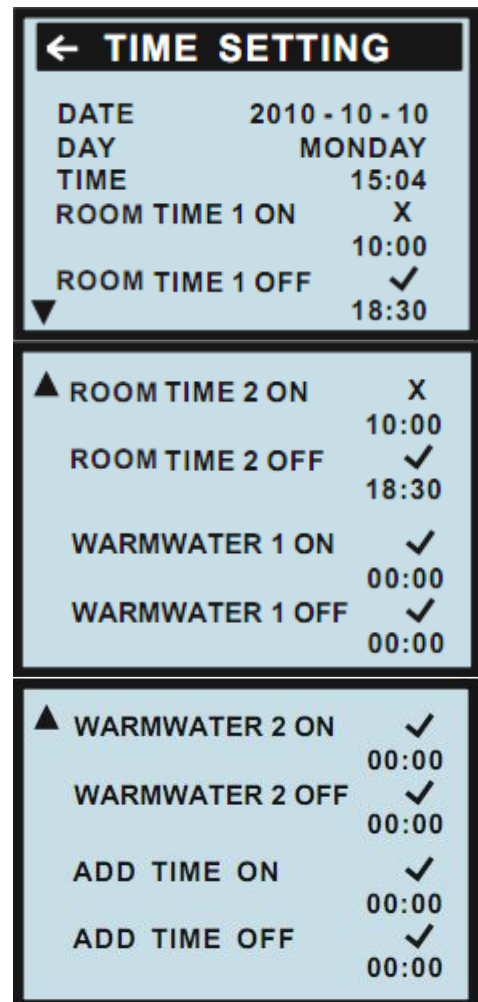

12.4.7 Sub-Menu DEFROST

How to enter the sub-menu DEFROST

Choose DEFROST on the main menu INFORMATION by pressing Right button, DEFROST menu can be seen.

You can choose intelligent defrost or manual defrost.

INTELLIGENT DEFROST

Intelligent defrost. Once you choose this function defrosting is intelligent and automatic.

When outdoor unit's heat changer (evaporator) pipe temperature is less than 3°C continuously for 40 minutes and the temperature is lower than the setting temperature, it will start the defrosting. In Intelligent defrost mode the operator can adjust the setting of defrosting according to different ambient temperature and humidity.

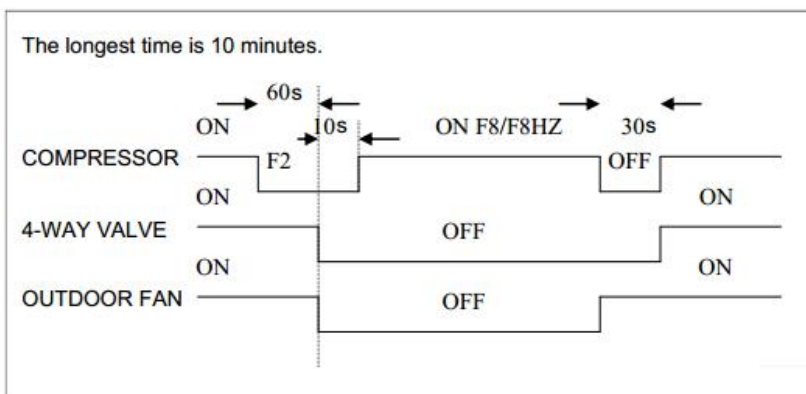
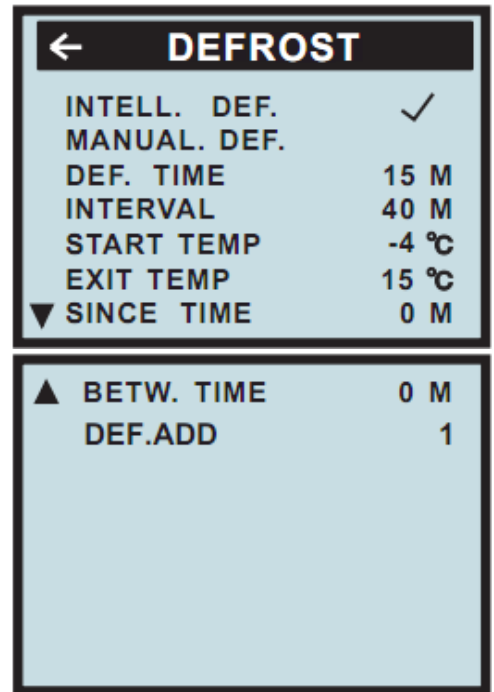

Select START TEMP, then press button Right for a long time to enter the defrosting setting.

Outdoor ambient temperature	Defrost start temperature (pipe at evaporator)	Outdoor ambient temperature	Defrost start temperature (pipe at evaporator)	Outdoor ambient temperature	Defrost start temperature (pipe at evaporator)
2	-3	-7	-11	-16	-20
1	-3	-8	-12	-17	-21
0	-4	-9	-13	-18	-22
-1	-5	-10	-14	-19	-23
-2	-6	-11	-15	-20	-24
-3	-7	-12	-16	-21	-25
-4	-8	-13	-17	-22	-26
-5	-9	-14	-18	-23	-27
-6	-10	-15	-19	-24	-28

When the ambient temperature is lower than 2°C, all the values of the table above are the factory settings. They are adjustable from 0°C to -30°C. press Right button for five seconds to select any defrost start temperature and revise it.

Outdoor ambient temperature	Defrost start temperature (pipe at evaporator)	Outdoor ambient temperature	Defrost start temperature (pipe at evaporator)	Outdoor ambient temperature	Defrost start temperature (pipe at evaporator)
-3	Change to -12	-6	Change to -12	-16	Change to -12
-4	Change to -12	-7	Change to -12	-17	Change to -12
-5	Change to -12	-8	Change to -12	-18	Change to -12

After confirmation, the factory setting will change to be a new default.

MANUAL.DEF:

Manually defrost (adjustable defrost program)

This function is semi-automatic. for example the operator can change the value of interval (the distance between defrosting) to be 40 minutes, and the START TEMP (the start temperature of defrosting) to be -4°C. If the defrosting time request and temperature request meet the heat pump goes to defrost.

Defrost finish:

When the outdoor evaporator pipe temperature (EXIT TEMP) setting is 15°C or EXIT TIME (defrosting timing) is reached the defrosting will finish.

DEF.TIME:

Duration of defrosting adjustable from 2 to 20 minutes. Factory setting is 15 minutes defrosting duration.

INTERVAL:

Interval of defrosting adjustable from 25 to 70 minutes. Factory setting is 40 minutes.

START TEMP:

Start temperature of defrosting (pipe temperature of outdoor evaporator adjustable from 2°C to -30°C. Factory setting is -4°C.

EXIT TEMP:

Exit temperature of defrosting (pipe temperature of outdoor evaporator adjustable from 0°C to 20°C. Factory setting is 15°C

SINCE TIME:

Start and exit time of defrosting, to indicate whole time of defrosting.

BETW.TIME:

To record the interval between the ending of first defrosting and the beginning of second defrosting.

12.4.8 Sub menu – SETTING

← SETTING			
EMERGENCY 1	OFF	OUTADD.HEAT	ON
EMERGENCY 2	OFF	ADD ENFORCE	OFF
STERILAZE		WATER PUMP	0 / 0
ADD START	50°C	HIGH T° STOP	50°C
ADD DELAY	30M	LOW T° STOP	-50°C
INTEGRAL	ON	HDO	✓
ADD DIF TEMP	4°C		

EMERGENCY 1

Is either ON or OFF, Factory setting is OFF.

If you select emergency mode the unit will continuously execute the same objective namely room heating only, water tank heating only or auto.

If you select ON the compressor will switch off. Only the electrical heater, water pump or other temperature protections are available.

When in water tank heating, the electrical heater will function instead of the compressor.

When in room heating mode the electrical heater will run depending on Integral. When in room heating 1 mode, the electrical heater will run depending on Integral. When in room heating 2 mode, the electrical heater automatically starts.

EMERGENCY2

Is either ON or OFF, Factory setting is OFF.

If you select ON the compressor will stop in a way determined by outdoor temperature. The temperature setting is from 0°C to -50°C and adjustable. Factory setting is -25°C.

If you select emergency mode the unit will continuously execute the same objective namely room heating only, water tank heating only or auto.

Once active only the electrical heater, water pump or other temperature protections are available.

* When in water tank heating the electrical heater will function instead of the compressor.

* When in room heating mode the electrical heater will run depending on Integral.

* When in room heating 1 mode, the electrical heater will run depending on Integral.

* When in room heating 2 mode, the electrical heater automatically starts.

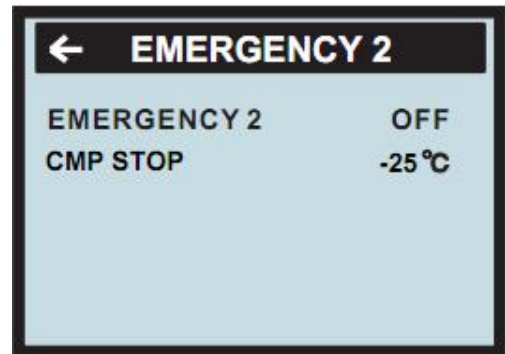

STERILIZE:

NOTE: The sterilize action only will be active during the select time period of the day.

Sterilize water temperature:

adjustable from 60°C to 80°C. Default is 60°C.

Sterilize duration:

adjustable from 10 to 90 minutes. Default is 10 minutes.

Sterilize period:

adjustable from 7 to 99 days. Default is 15 days.

Time: Default is 10:00 - 14:00

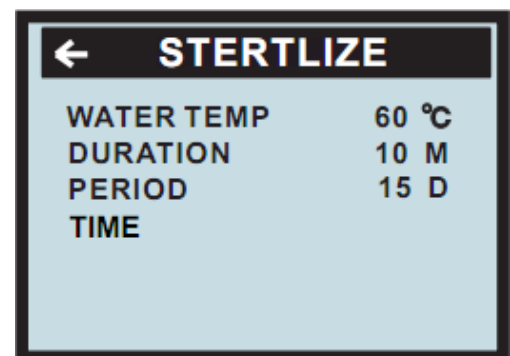

If the water tank temperature is less than 60°C over 360 hours, the heat pump will start the sterilize function. The electrical heater will start as soon as water reaches 50°C and carry on until it reaches 60°C for a period of 10 minutes. If after three hours the water temperature still cannot reach 60°C, the sterilize function will end.



ADD START:

Adjustable from 10°C to 65°C. Factory setting is 40°C.

The compressor heats the water temperature to above 40°C then allow the electrical heater to start. This setting is for energy saving and water tank heating (WARMWATER) only.

ADD DELAY:

Adjustable from 3 to 10 minutes. Factory setting is 10 minutes.

Sets how long the compressor will work alone before employing the electrical heater for extra power.

ADD DIF TEMP

Additional electrical heater restart determined by water temperature drop! Adjustable from 1°C to 10°C. Factory setting is 4°C.

OUTADD.HEAT ON (OFF)

Factory setting is ON. To control outdoor unit electrical heater (bottom electrical heater evaporator heater). The heater will start when ambient temperature is lower than 0°C, and stop when ambient temperature is more than 2°C.

When outdoor electrical heater is OFF, the outdoor heater can not start automatically. Display : OUT ADD . HEAT OFF

ADD ENFORCE ON (OFF)

This function is only available for WARMWATER (water tank heating). When you select "ON", the ADD (additional electrical heater) will start enforcedly as soon as compressor start, then stop as soon as water reach setting temperature; when you select "OFF", the ADD only start after fulfill two other conditions (ADD START and ADD DELAY).

INTEGRAL ON (OFF)

When set it to ON, the integral function is available. When set it to OFF, the integral function is not available.

WATER PUMP ON (OFF)

Press right button once will change from 0/0 to 3/10, press the button again will change to 3/10, press again will change to 3/15, press again will change to 3/20, press again will return to 0/0. Factory setting is 0/0.

0/0 means water pump (for heating) will keep running when house or water tank reach setting temperature in ROOMHEAT 1 and ROOMHEAT2.

3/10 means that under ROOMHEAT 1 and ROOMHEAT 2; if the setting temperature reach and the compressor stops, the water pumps (for heating) will runs 3 minutes to detect the water temperature, if no need to keep running the water pump will stop 10 minutes, then runs 3 minutes again to see if need to restart compressor and keep water pump running.

3/15 means that under ROOMHEAT 1 and ROOMHEAT 2; if the setting temperature reach and the compressor stops, the water pumps (for heating) will runs 3 minutes to detect the water temperature, if no need to keep running the water pump will stop 15 minutes, then runs 3 minutes again to see if need to restart compressor and keep water pump running.

3/20 means that under ROOMHEAT 1 and ROOMHEAT 2; if the setting temperature reach and the compressor stops, the water pumps (for heating) will runs 3 minutes to detect the water temperature, if no need to keep running the water pump will stop 20 minutes, then runs 3 minutes again to see if need to restart compressor and keep water pump running.

Menu Text	Description	Adjustable by
HIGH T STOP	When outdoor ambient temperature is higher than this setting, the hot water to room or water tank will be stopped.	User. See "Adjustment of HIGH T STOP and LOW T STOP".
LOW T STOP	When outdoor ambient temperature is lower than this setting, the hot water to room or water tank will be stopped.	User. See "Adjustment of HIGH T STOP and LOW T STOP".

HDO ON (OFF)

Choose "√" to activate the function 'External signal controls heat pump to start or stop'; there are two signal connections (NC), when external signal switch on them, the compressor, electrical heater and motor will stop running (The water pump will keep running if the operation mode is 'Room heating'); After switch off them, the compressor, electrical heater, motor will restart and work as previous setting.

This function is for the countries which electricity has two different prices in high peak and low peak that peak electricity;

they can use signal to stop heat pump when in high peak electricity and start the heat pump when in low

Notice: never input electricity directly to HDO terminals!

12.4.9 Sub-Menu OPERATING TIME

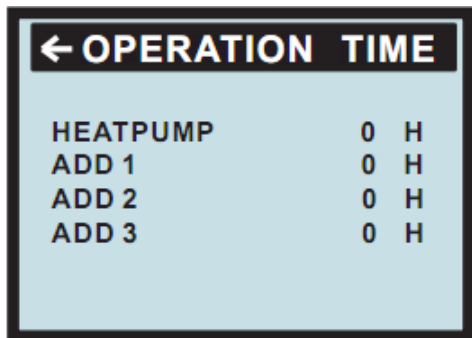

Menu Text	Description	Adjustable by
HEAT PUMP	Total operating hours of heat pump since installation. Operating time can not be reset to zero.	can not
ADD 1 / ADD 2 / ADD 3	Total operating hours of auxiliary heater (3KW/6KW/9KW) since installation. Operating time can not be reset to zero.	can not

12.4.10 Sub-Menu MAN TEST

How to enter the Sub-Menu MAN TEST:

Select "MAN TEST" on the main menu INFORMATION and press Right button for three seconds.

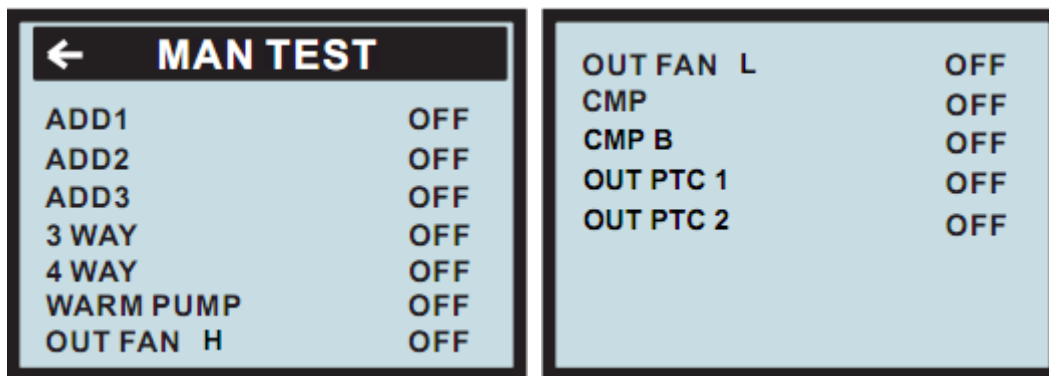

ADD1 / ADD2 / ADD3	ON or OFF	ELECTRICAL HEATER 1 / 2 / 3
3 WAY	ON or OFF	3-WAY VALVE
4 WAY	ON or OFF	4-WAY VALVE
WARM PUMP	ON or OFF	WATER PUMP
OUT FAN H	ON or OFF	OUTDOOR FAN HIGH SPEED
OUT FAN L	ON or OFF	OUTDOOR FAN LOW SPEED
CMP	ON or OFF	COMPRESSOR A
OUT PTC	ON or OFF	OUTDOOR COMPRESSOR HEATER

NOTE!

Compressor only runs for five minutes in testing, and its frequency is 45Hz. This menu is for an installation engineer. **Owner operation is prohibited.** The testing function will dissolve as soon as the menu is off the interface.

12.4.11 Sub-Menu ALARM RECORD

To record 8 alarm histories recently; the newest alarm message will be seen in the first line. Press right button to check alarm history.

12.4.12 Sub-Menu LANGUAGE

Language selection:

12.4.13 Sub-Menu RESET

Reset to factory setting value.

12.4.14 Adjustments made regularly:

- * Selection of operating mode.
- * Adjustment of desired room temperature by changing the room value.
- * Adjustment of heat curve.
- * Adjustment of maximum and minimum values for feed line temperature.
- * Heat Generation-General

The indoor temperature should be adjusted by changing the heat curve.

The control computer uses the heat curve to determine the correct temperature of the water to be distributed to the heating system, heat curve will be set during **installation**.

It must be adapted later on however to obtain a pleasant indoor temperature under varying weather conditions. A correct heat curve reduces maintenance and saves energy.

The heat curve determines the feed line temperature, depending on the outside air temperature. The lower the outside air temperature, the higher the feed line temperature.

In other words, the temperature of the water feed to the radiators will increase sharply as the outside air temperature falls.

If you select CURVE in sub-menu named HEAT CURVE, a diagram will be displayed. It represents the relation of outside air temperature to feed line temperature. This relationship is the heat curve

12.4.15 Adjustment of the CURVE value

Heat curve is adjusted by the CURVE value. This value indicates the feed line temperature to The radiators at 0°C outside temperature. When you increase the CURVE value, the heat curve will become steeper and when you reduce it, it will become flatter.

At outside air temperature is lower than 0°C, the water sent to the radiators will be warmer than 40°C. At outside temperature is higher than 0°C, the water will be colder than 40°C. This is the most energy and cost efficient way to set the indoor temperature and should therefore be used for long term temperature settings.

If you wish to make a temporary change of temperature, you can simply change the ROOM value (see 'adjustment of the ROOM value' on page 28).

CURVE is program that adjusts feed water temperature according outdoor ambient temperature. Factory setting is ambient temperature 0°C and feed water temperature 40°C. that is represented CURVE = 40.

The value of CURVE is adjustable from 22°C TO 56°C.

How to change the slope: Two points decide one beeline, point one is (0, 40) the other point could be (18, 24) , the point (18, 24) is not changing when changing the slope, because factory SETTING IS THAT HEAT PUMP STOPS WHEN OUTDOOR ambient temperature is 18°C, so the feed water temperature should be 24°C.

If you wish to change the CURVE value:

1. Open the main menu INFORMATION by pressing right button once. You will find the cursor at sub-menu named OPERATION.
2. Press down button to move the cursor to sub-menu called HEAT CURVE.
3. Press right button once to open the menu, you will

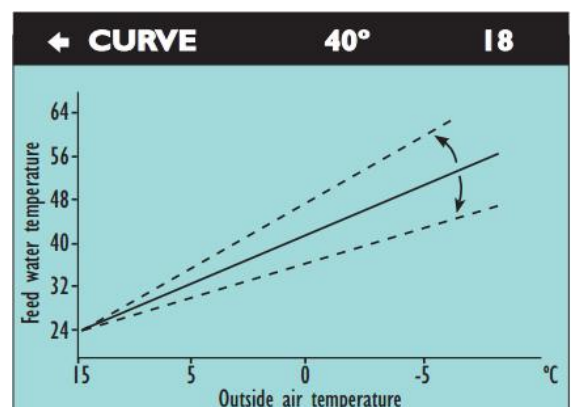
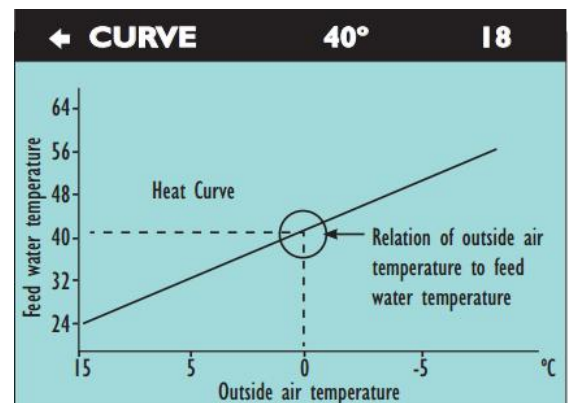

find the cursor at the parameter CURVE.

4. Open the selected parameter by pressing right button once.
5. Increase or reduce the pre-set value using up or down button, you will see from the diagram how the gradient of CURVE changes.
6. Press left button three times to return to main menu.

12.4.16 Adjustment of ROOM value (CURVE ROOM)

You can also adjust the heat curve and indoor temperature by changing ROOM value.

If you use ROOM value to adjust the heat curve the gradient does not change, meaning it does not become steeper or flatter. Instead the whole curve is moved by 1°C for every $^{\circ}\text{C}$ by which the ROOM value is changed. The relationship between feed line temperature and outside air temperature will not be affected. The feed water temperature will be increased or reduced by the same number of $^{\circ}\text{C}$ s all along the heat curve. See the following diagram

IMPORTANT

Adjustment of the ROOM value should only be used for temporary changes of the indoor temperature.

For long term settings, the CURVE value should be adjusted as this is the most energy and cost efficient way to set the indoor temperature. For adjusting the heat curve, please refer to the chapter "adjustment of the CURVE value" on page 31.

Select ROOM CURVE on the sub-menu HEAT CURVE, then press right button. Use up and down button to adjust the ROOM CURVE.

Factory setting of ROOM value is 20°C .

If you wish to change the ROOM CURVE:

1. Press up or down button once to open ROOM CURVE for adjustment.
2. Increase or reduce the pre-set value using the up or down button so that the desired room temperature is reached.
3. Wait for 10 seconds or press left button once to return to the main menu. When you enter ROOM HEAT mode, you may control compressor and electrical heater through regulating the heat curve or DM ($^{\circ}\text{C}$ minute).

Under a certain ambient temperatures the time start of compressor is determined by $^{\circ}\text{C}$ minute (DM)

Following are two examples for guidance:

START QUICKLY is determined by FEED (HEAT CURVE).

Suppose the feed water temperature is 25°C . Regulate the heat curve to make the water temperature a high value such as 55°C , that is FEED 25 (55).

DM will then decrease to -30 per minute. When DM reaches -60, compressor will start.

NOTE

If the water temperature setting is lower than feed water temperature DM would turn to positive number, meaning the compressor will not start. For that reason you also can regulate the DM to be near the value for compressor start, such as -20.

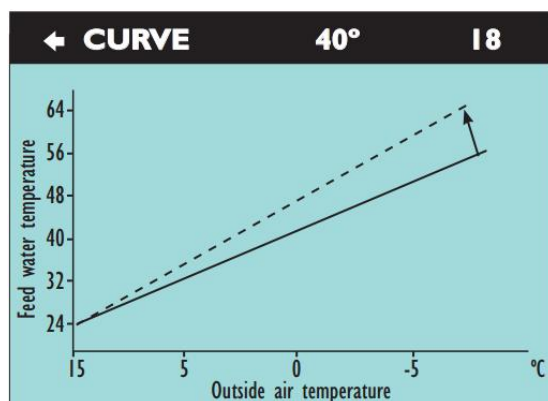
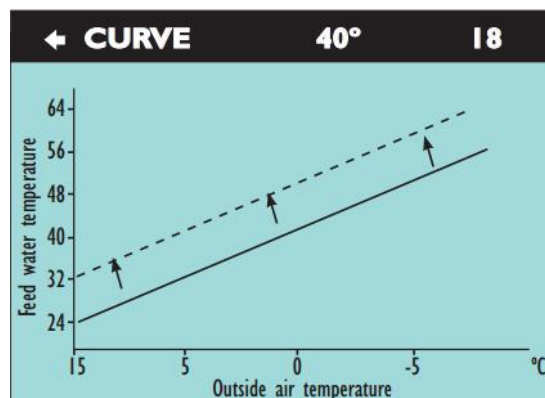

SLOW START is determined by FEED (heat curve) again, suppose the feed water temperature is 25°C. You may regulate the heat curve to set the water temperature to be a lower value such as 30°C, that is FEED 25 (30). When that happens the dm would decrease to -10 per minute. The time it takes to -60 becomes longer, meaning it takes that much longer for the compressor to start. You also can regulate the DM to extend the time before compressor starts, such as -100.

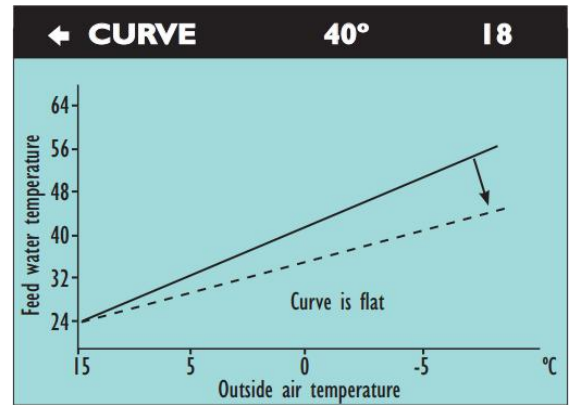

12.4.17 Adjustment of Part of the Heat Curve

At outdoor temperature of between -5°C and +5°C, part of the heat curve may need adjusting if the indoor temperature does not stay at the pre-set ROOM value.

For this reason, the control system includes a function adjusting the curve at three outside temperatures -5°C, 0°C, +5°C. this function will allow you to increase or reduce the feed line temperature without affecting the heat curve at these three specific outdoor temperature.

If, for example the outside temperature is -5°C, feed line temperature will change gradually in the outdoor temperature range of 0°C to -10°C, maximum adjustment being reached at -5°C.

The diagram below shows an adjusted -5. the point of maximum adjustment is clearly visible.

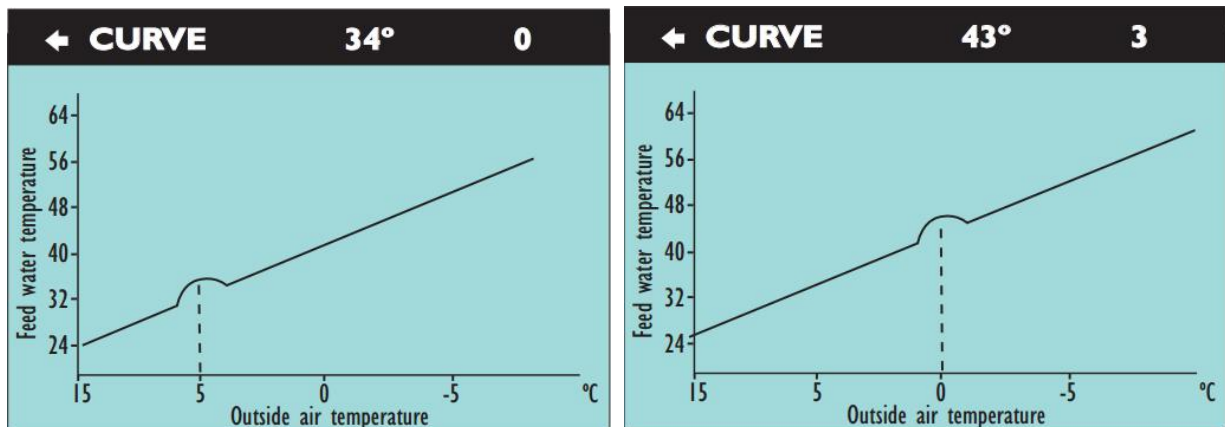

As we have seen, you can choose to adjust the heat curve at three specific outside air temperatures: -5°C, 0°C and +5°C. The feed line temperature can be changed by plus or minus 3°C.

When the outdoor ambient temperature is 5°C, this setting allows you to change the feed water temperature. the heat curve will not change but the point on the curve near 5°C (strictly speaking from 0°C to 10°C) can be adjusted. As you can see the variable is the biggest around 5°C.

In the same way when the outdoor ambient temperature is 0°C, this setting allows you to change the feed water temperature. The heat curve will not change, but the point on curve near 0°C (from -5°C to 5°C) can be adjusted. The variable is the biggest at 0°C.

Finally (you should be seeing a pattern here) , when outdoor ambient temperature is -5°C, this setting allows you to change the feed water temperature.

The heat curve will not change, but the point on curve near -5°C (FROM 0°C TO -10°C) can be adjusted. The variable is the biggest at -5°C.

If you wish to change a specific part of the heat curve:

1. Open main menu INFORMATION by pressing right button once. You will find the cursor at sub-menu OPERATION.
2. Press down button to move the cursor to sub-menu HEAT CURVE.
3. Open the menu by pressing right button once. You will find the cursor at the parameter CURVE.
4. USING UP OR DOWN BUTTON SELECT EITHER CURVE 5, CURVE 0 OR CURVE -5.
5. Open the selected curve by pressing right button once.
6. Raise or lower the value using up or down button.
7. Press left button three times to return to main menu.

12.4.18 Adjustment of HIGH T STOP and LOW T STOP

The HIGH T STOP and LOW T STOP function stops all production of radiator heat when the outside air temperature is equal to higher or lower than the value entered for HIGH T STOP or LOW T STOP.

Essentially, it tells the unit when it has become either too hot or too cold outside to carry on working. When activated the circulation pump will be turned off.

The factory setting of HIGH T STOP is 50°C. It is adjustable from 0°C to 50°C.

The factory setting of LOW T STOP is -50°C. It is adjustable from -50°C to 0°C.

If you wish to change HIGH T STOP or LOW T STOP value:

1. Open the main menu information by pressing right or left button once. You will find the cursor at sub-menu OPERATION.
2. Press down button to move the cursor to sub-menu HEAT CURVE.
3. Open the menu by pressing right button once.
4. You will find the cursor at the parameter CURVE.
5. Press down button to move the cursor to sub-menu HIGH T STOP or LOW T STOP.
6. Open the selected curve by pressing right button once. The cursor moves to HIGH T STOP or LOW T STOP.
7. Raise or lower the value using up or down button.
8. Press left button three times to return to main menu.

12.4.19 Adjustment of the MIN and MAX value

The MIN and MAX value are respectively the lowest and highest values allowed for the supply line temperature.

Adjusting the minimum and maximum supply line temperature is particularly important if your home has underfloor heating.

If your house has underfloor heating and a parquet floor, the supply line temperature should not be higher than 45°C. If you have floor coils and stone tiles, the MIN value should be 22-25°C in summer when no heating is required to obtain a comfortable floor temperature.

WARNING

IGNORING THIS ADVICE RISKS DAMAGE TO YOUR FLOOR. IF YOU HAVE A BASEMEN, THE MIN VALUE SHOULD BE ADJUSTED TO A SUITABLE TEMPERATURE IN SUMMER, TO AVOID A HUMID AND CHILLY BASEMENT. IN SUCH CASES, THE VALUE FOR HEAT STOP NEEDS BEING ADJUSTED UPWARDS.

MIN is the minimum setting of feed water temperature; it is adjustable by operator from 10 to 30 °C, factory setting is 22 °C; if the room's floor use ceramic tile, then the setting of MIN can not less than 22°C (this value can get a comfortable floor temperature); the heat pump will restart as soon as actual feed water temperature less than MIN setting.

MAX is the maximum setting of feed water temperature, it is adjustable by operator from 30 to 70°C, and

factory setting is 70°C; if heat pump is using for floor heating, this setting is very important, because at the time the feed water temperature can not higher than 70°C, otherwise could be dangerous; the heat pump will stop as soon as actual feed water temperature more than MAX setting.

If you wish to change the MIN or MAX value:

1. Open the main menu INFORMATION by pressing right or left button once. You will find the cursor at the sub-menu OPERATION
2. Press the "down" button to move the cursor to the sub-menu HEAT CURVE
3. Open the selected menu by pressing the right-hand button once. You will find the cursor at the parameter CURVE.
4. Press the "down" button to move the cursor to MIN.
5. Open the selected parameter by pressing the right-hand button once. The cursor is at MIN
6. Raise or lower the value, using the "up" and "down" button respectively.
7. Press the left-hand button three times to return to the main menu.
8. Repeat the procedure to change the MAX value, replacing MIN by MAX at step 4.

12.4.20 Graph of recent changes in TEMPERATURE

All temperatures registered during the last hour can be viewed in the sub-menu TEMPERATURE in the shape of a graph. This will enable you to monitor changes in the different system temperatures.

When at item WARMWT or ROOM OR RETURN or FEED, or PIPE, pressing right button for five seconds will display the information as a chart covering one hour.

There is a graph available for all temperatures, where you can only view the set point value. The integral value displayed represents the heating system's energy balance.

If you wish to check the TEMPERATURE graphs:

1. Open the main menu information by pressing right or left button once. You will find the cursor at sub-menu OPERATION.
2. Press down button to move the cursor to sub-menu TEMPERATURE.
3. Open the menu by pressing right button once.
4. You will find the cursor at the parameter OUT.
5. Press down button to move the cursor to the desired temperature.
6. Open the selected curve by pressing right button for five seconds. A graph will be shown in the display.
7. Move the cursor along the time axis using up or down button. The exact temperature at the selected point of time appears at the top of the display.
8. Press left button three times to return to main menu.

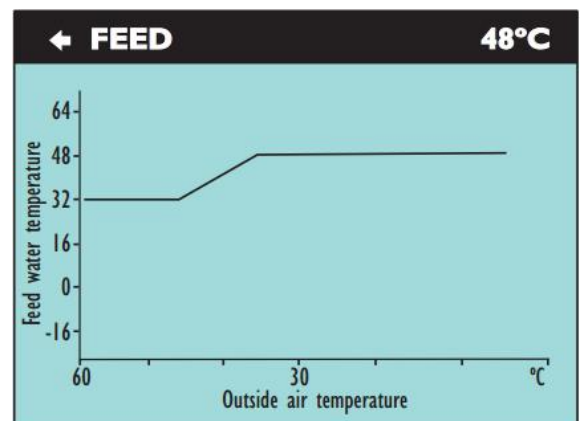

13. Circuit board picture

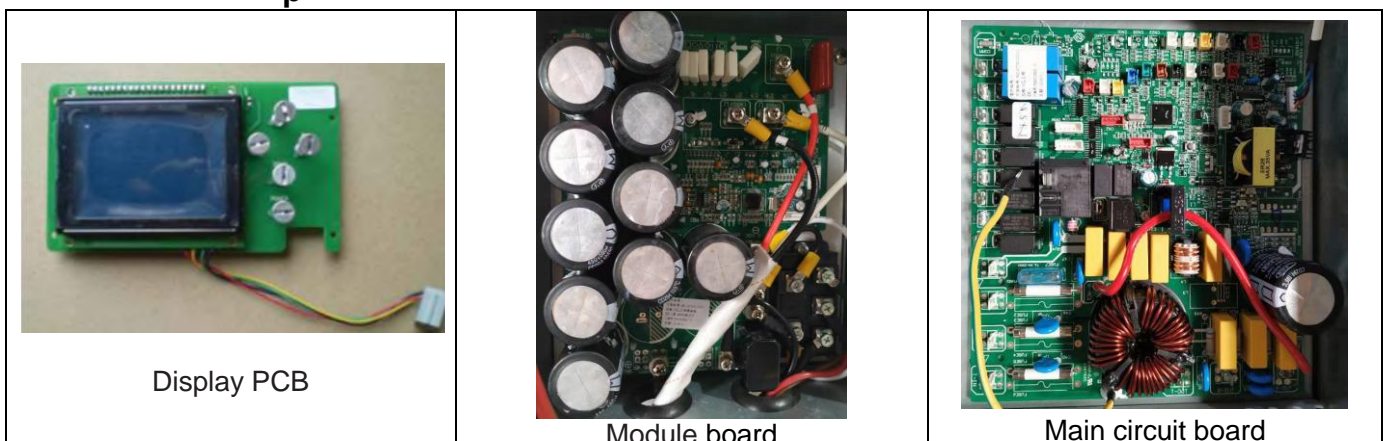

14. Error codes

This table explains the error codes caused by a defective regulating component or by a security operation. You have to call your retailer.

Alarm	Explanation
DISPLAY EEPROM	EEPROM reading failure from display
DISPLAY-TRANSITION COMMUNICATE	The communications failure between display and main board
TRANSITION EEPROM	EEPROM reading error from main board
MAIN-MODULE COMMUNICATE	The communications failure between main board and module
OUTDOOR TEMP.	Outdoor ambient temperature sensor error
MODULE VOLTAGE OVER	Module voltage error
IPM MODULE	IPM module error
CMP TOP OVER	Compressor discharge gas temperature too high
CMP TEMP.	Compressor discharge gas temperature sensor error
RETURN TEMP.	Return water temperature sensor error
WARM WATER TEMP.	Water tank temperature sensor error
FEEDLINE TEMP.	Feed water temperature sensor error
PIPE TEMP.	Pipe temperature sensor error(defrosting)
WATER FLOW TROUBLE OR ADD OVER	Water flow error or electrical heater over heat
HIGH PRESS	High pressure side's pressure too high
LOW PRESS	Low pressure side's pressure too low
ROOM TEMP.	Room air temperature sensor error
WARM WATER TEMP. TOO LOW	The water tank temperature is too low

15. Alarm messages and what to do

The cause of alarm '**IPM MODULE**' could be:

(Notice: before check below please disconnect the compressor's wire from module, in case the compressor has a short circuit)

- 1、 The communications between Module and outdoor main circuit board is jamming;
- 2、 Module is jamming and can not detect current of compressor;
- 3、 Module can not start compressor; The compressor has a short circuit
- 4、 Module's rated 15VDC voltage is not steady
- 5、 Module's current overload;
- 6、 The module is over heat, because the heat conducting is not well;

How to do:

1. Please check if all terminals connections among circuit boards were good, whether some of the wire damaged;
2. Please check if the compressor wire connection loose (on the top of compressor);
3. Please measure each two of the connections (terminals of compressor)'s resistance, if the resistance are always the same, means the compressor is fine. there 3 terminal connections on the compressor , you need to measure each two 's resistance, for example , let 's say the connections are A, B, C, then you need to measure the resistance of AB, AC, BC; if the result is not good, you must change a new compressor.
4. Please check wire connection between the Main circuit board and module; see the follow picture



5. Check the DC voltage between Positive pole and Negative pole if normal, the DC voltage should be: KS200-DC / 250-DC (triple phase): 540VDC , **if it is not, you must change a new module:**



6. Check the if DC voltage between A(first wire) and B(third wire) is normal, it should be 13.5V ~16.5V; if it is not, **you must change a new module.**

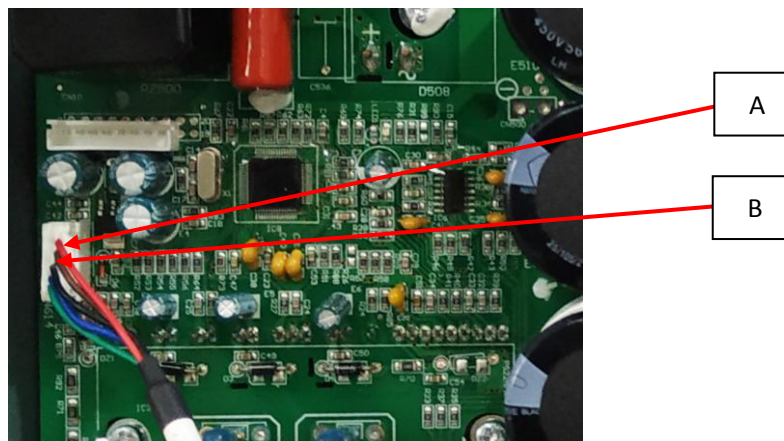

7. Check if some place has creepage, on the strong current wires of the compressor, reactance etc...

8. if you had once changed the module on this unit before, please recall had you add the heat-conducting silicone grease on module and make sure the surface is clean (if you do not know what is it please ask factory for more information); Make sure the electrical box and circuit boards are clean and seal well, make sure not bug can enter; Make sure the power supply is correct; if the alarm shows on the units which was doing WARMWATER(hot water) and the water tank was not provided from factory, you must also check the water tank's water temperature sensor level, do not put it too low because it will feel low water temperature but the heat pump keep heating the water tank and cause high actual water temperature and high pressure.

9. In first installation, check if the installation is correct, put the water tank sensor at one-third of water tank from bottom. is correct, put the water tank sensor at one-third of water tank from bottom.

The cause of alarm 'MODULE VOLTAGE OVER' could be:

1. Water flow was not enough;
2. One of the sensors got problem;
3. Ambient temperature was too high
4. Main board or power board (see pictures and name of PCB) has problem.

How to do:

1. Check if the water flow was not enough; check if the water flow switch has problem, screw it out and check if there some dirt around it, make sure the heating medium water is in a good condition. Measure the water flow switch, see below.
2. Check all the sensors if they are normal, see below the resistance table for sensors.
3. Check the module board as above information;
4. Change the main board or power board one by one.

The cause of alarm 'CMP TOP OVER' could be:

1. Water flow was not enough;
2. Refrigerant was not enough
3. Ambient temperature was too high;
4. Compressor exhaust temperature sensor has problem

How to do:

1. Check if the water flow was not enough, so that the heat exchange efficiency was not good;
 2. Check the refrigerant quantity, and make sure the system has not any leak. ;
 3. Make sure the resistance of compressor exhaust temperature sensor as per resistance table of below.
- More information for the compressor exhaust temperature sensor.

The cause of alarm 'ADD OVER OR WATER FLOW TROUBLE' could be:

1. Water flow is not enough; heating medium water has problem such as dirty
2. The connection of water flow switch was loose or water flow switch was broken;
3. There some air inside the water system, so that the heat exchange area was not enough;
4. The temperature protector of the electrical heater was broken;

How to do:

1. Always ensure enough water flow; otherwise the flow switch can not open;
2. Check the wire connection of water flow switch was normal or not, or change a water flow switch; screw it out and check if there some dirt around it, make sure the heating medium water is in a good condition.
3. Check the water flow switch.
4. Vent the air from the water system following this manual's instructions.
5. Measure the thermostat switch of electrical heater by ampere meter.

The cause of 'LOW PRESS' could be :

1. The refrigerant was not enough
2. The connection of low pressure switch was loose, or the switch was broken;
3. The outdoor fan can not run

How to do:

1. Check if there any place leak refrigerant, especially on the connections valves;
2. Check if the wire connection of low pressure switch was ok, or change a new low pressure switch;
3. Check if the outdoor unit's fan was running, if not, please check if the fan was normal, such as the capacitor of motor.

The cause of 'HIGH PRESS' could be :

1. The water flow was not enough;
2. The high pressure switch's connection was not good; or the switch was broken;
3. The ambient temperature was too high.

How to do:

1. Always ensure enough water flow; otherwise the flow switch can not open;
2. Check if the wire connection of high pressure switch was ok, or change a new one;

The cause of alarm 'WARM WATER TEMP.' could be:

1. The connection of water tank temperature sensor was loose;
2. The water tank temperature sensor was broken;

How to do:

1. Find the connection and make sure it is fine;
2. As per resistance table of the sensor, please measure the sensor's resistance, to judge the sensor was good or bad; change a new one if the sensor get problem.

The cause of alarm 'FEEDLINE TEMP.' could be:

1. The connection of feed water temperature sensor was loose;
2. The feed water temperature sensor was broken;

How to do:

1. Find the connection and make sure it is fine;
2. As per resistance table of the sensor, please measure the sensor's resistance, to judge the sensor was good or bad; change a new one if the sensor get problem.

The cause of alarm 'RETURN TEMP.' could be:

1. The connection of return water temperature sensor was loose;
2. The return water temperature sensor was broken;

How to do:

1. Find the connection and make sure it is fine;
2. As per resistance table of the sensor, please measure the sensor's resistance, to judge the sensor was good or bad; change a new one if the sensor get problem.

The cause of alarm 'PIPE TEMP.' could be:

1. The connection of pipe temperature sensor (on evaporator, for defrosting) was loose; on the LCD display menu TEMPERATURE, you will see the data on PIPE
2. The pipe temperature sensor was broken;

How to do:

1. Find the connection and make sure it is fine;
2. As per resistance table of the sensor, please measure the sensor's resistance, to judge the sensor was good or bad; change a new one if the sensor get problem.

The cause of alarm 'OUTDOOR TEMP.' could be:

1. The connection of outdoor ambient temperature sensor was loose;
2. The outdoor ambient temperature sensor was broken;

How to do:

1. Find the connection and make sure it is fine;
2. As per resistance table of the sensor, please measure the sensor's resistance, to judge the sensor was good or bad; change a new one if the sensor get problem.

The cause of alarm 'CMP TEMP.' could be:

1. The connection of compressor discharge gas temperature sensor was loose;
2. The compressor discharge gas temperature sensor was broken;

How to do:

1. Find the connection and make sure it is fine;
2. As per resistance table of the sensor, please measure the sensor's resistance, to judge the sensor was good or bad; change a new one if the sensor get problem.

16. Sensors resistance table 1

compressor exhaust temperature sensor resistance

Unit: °C--KΩ (compressor exhaust temperature sensor) 55K											
T °C	R(KΩ)	AD	T °C	R(KΩ)	AD	T °C	R(KΩ)	AD	T °C	R(KΩ)	AD
-20	542.7	3	20	68.66	26	60	13.59	95	100	3.702	175
-19	511.9	3	21	65.62	28	61	13.11	97	101	3.595	177
-18	483	4	22	62.73	29	62	12.65	99	102	3.492	178
-17	455.9	4	23	59.98	30	63	12.21	101	103	3.392	180
-16	430.5	4	24	57.37	31	64	11.79	103	104	3.296	181
-15	406.7	4	25	54.89	32	65	11.38	106	105	3.203	183
-14	384.3	5	26	52.53	34	66	10.99	108	106	3.113	184
-13	363.3	5	27	50.28	35	67	10.61	110	107	3.025	186
-12	343.6	5	28	48.14	36	68	10.25	112	108	2.941	187
-11	325.1	6	29	46.11	38	69	9.902	114	109	2.86	188
-10	307.7	6	30	44.17	39	70	9.569	117	110	2.781	190
-9	291.3	6	31	42.33	40	71	9.248	119	111	2.704	191
-8	275.9	7	32	40.57	42	72	8.94	121	112	2.63	193
-7	261.4	7	33	38.89	43	73	8.643	123	113	2.559	194
-6	247.8	8	34	37.3	45	74	8.358	125	114	2.489	195
-5	234.9	8	35	35.78	47	75	8.084	127	115	2.422	196
-4	222.8	8	36	34.32	48	76	7.82	129	116	2.357	198
-3	211.4	9	37	32.94	50	77	7.566	132	117	2.294	199
-2	200.7	9	38	31.62	52	78	7.321	134	118	2.233	200
-1	190.5	10	39	30.36	53	79	7.086	136	119	2.174	201
0	180.9	10	40	29.15	55	80	6.859	138	120	2.117	202
1	171.9	11	41	28	57	81	6.641	140	121	2.061	203
2	163.3	12	42	26.9	59	82	6.43	142	122	2.007	204
3	155.2	12	43	25.86	60	83	6.228	144	123	1.955	206
4	147.6	13	44	24.85	62	84	6.033	146	124	1.905	207
5	140.4	13	45	23.89	64	85	5.844	148	125	1.856	208
6	133.5	14	46	22.89	66	86	5.663	150	126	1.808	209
7	127.1	15	47	22.1	68	87	5.488	152	127	1.762	210
8	121	15	48	21.26	70	88	5.32	154	128	1.717	211
9	115.2	16	49	20.46	72	89	5.157	156	129	1.674	211
10	109.8	17	50	19.69	74	90	5	157	130	1.632	212
11	104.6	18	51	18.96	76	91	4.849	159			256
12	99.69	19	52	18.26	78	92	4.703	161			256
13	95.05	20	53	17.58	80	93	4.562	163	B(25/50)=3950K+-3% R(90°C)=5KΩ+-3%		256
14	90.66	20	54	16.94	82	94	4.426	165			256
15	86.49	21	55	16.32	84	95	4.294	167			256
16	82.54	22	56	15.73	86	96	4.167	168			256
17	78.79	23	57	15.16	88	97	4.045	170			256
18	75.24	24	58	14.62	90	98	3.927	172			256
19	71.86	25	59	14.09	93	99	3.812	173			256

Sensors resistance table 2**water/ambient/pipe sensor resistance**

Unit: °C--KΩ (water/ambient/pipe sensor) 10K											
T °C	R(KΩ)	AD	T °C	R(KΩ)	AD	T °C	R(KΩ)	AD	T °C	R(KΩ)	AD
-20	115.266	16	20	12.6431	99	60	2.35774	197	100	0.62973	236
-19	108.146	17	21	12.0561	102	61	2.27249	198	101	0.61148	237
-18	101.517	18	22	11.5	105	62	2.19073	200	102	0.59386	237
-17	96.3423	19	23	10.9731	107	63	2.11241	202	103	0.57683	237
-16	89.5865	21	24	10.4736	110	64	2.03732	203	104	0.56038	238
-15	84.219	22	25	10	113	65	1.96532	205	105	0.54448	238
-14	79.311	23	26	9.55074	116	66	1.89627	206	106	0.52912	239
-13	74.536	24	27	9.12445	119	67	1.83003	207	107	0.51426	239
-12	70.1698	26	28	8.71983	122	68	1.76647	209	108	0.49989	240
-11	66.0898	27	29	8.33566	125	69	1.70547	210	109	0.486	240
-10	62.2756	29	30	7.97078	128	70	1.64691	211	110	0.47256	240
-9	58.7079	30	31	7.62411	131	71	1.59068	212	111	0.45957	241
-8	56.3694	31	32	7.29464	133	72	1.53668	214	112	0.44699	241
-7	52.2438	34	33	6.98142	136	73	1.48481	215	113	0.43482	241
-6	49.3161	35	34	6.68355	139	74	1.43498	216	114	0.42304	242
-5	46.5725	37	35	6.40021	142	75	1.38703	217	115	0.41164	242
-4	44	39	36	6.13059	144	76	1.34105	218	116	0.4006	242
-3	41.5878	41	37	5.87359	147	77	1.29078	219	117	0.38991	243
-2	39.8239	42	38	5.62961	150	78	1.25423	220	118	0.37956	243
-1	37.1988	45	39	5.39689	152	79	1.2133	221	119	0.36954	243
0	35.2024	47	40	5.17519	155	80	1.17393	222	120	0.35982	244
1	33.3269	49	41	4.96392	157	81	1.13604	223	121	0.35042	244
2	31.5635	51	42	4.76253	160	82	1.09958	224	122	0.3413	244
3	29.9058	54	43	4.5705	162	83	1.06448	225	123	0.33246	244
4	28.3459	56	44	4.38736	165	84	1.03069	226	124	0.3239	245
5	26.8778	58	45	4.21263	167	85	0.99815	226	125	0.31559	245
6	25.4954	61	46	4.04589	169	86	0.96681	227	126	0.30754	245
7	24.1932	63	47	3.88673	172	87	0.93662	228	127	0.29974	245
8	22.5662	67	48	3.73476	174	88	0.90753	229	128	0.29216	246
9	21.8094	68	49	3.58962	176	89	0.8795	229	129	0.28482	246
10	20.7184	71	50	3.45097	178	90	0.85248	230	130	0.2777	246
11	19.6891	74	51	3.31847	180	91	0.82643	231	131	0.27078	246
12	18.7177	76	52	3.19183	182	92	0.80132	231	132	0.26408	246
13	17.8005	79	53	3.07075	184	93	0.77709	232	133	0.25757	247
14	16.9341	82	54	2.95896	186	94	0.75373	233	134	0.25125	247
15	16.1156	85	55	2.84421	188	95	0.73119	233	135	0.24512	247
16	15.3418	87	56	2.73823	190	96	0.70944	234	136	0.23916	247
17	14.6181	90	57	2.63682	192	97	0.68844	234	137	0.23338	247
18	13.918	93	58	2.53973	193	98	0.66818	235	138	0.22776	247
19	13.2631	96	59	2.44677	195	99	0.64862	236	139	0.22231	248

17. List of components

Indoor unit:

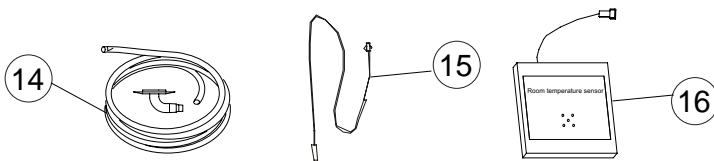
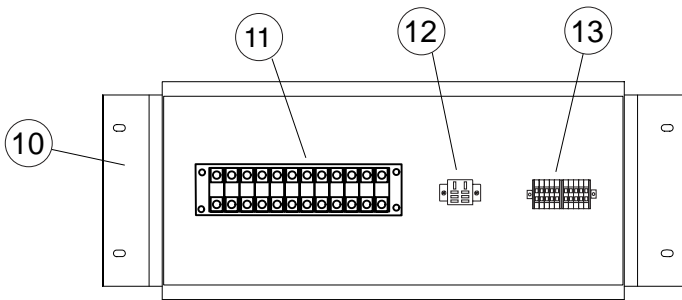
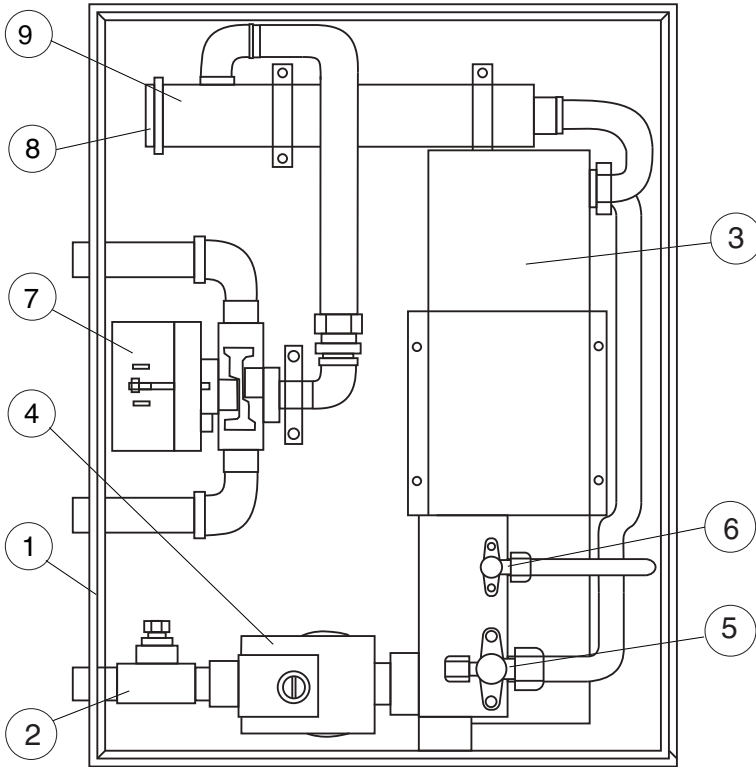

1	Indoor electrical box
2	Water flow switch
3	Stainless steel plate heat exchanger
4	Water pump
5	Valve 1
6	Valve 2
7	Three way valve
8	Electrical heater rod
9	Electrical heater sleeve
10	Indoor electrical box
11	Connecting terminal
12	Relay for 3 way valve
13	2.5mm ² terminal
14	Drain pipe and connector
15	Water tank temperature sensor
16	Room temperature sensor
17	Control panel
18	Control panel box
19	Lock
20	Metal door
21	Hole for connecting wire
22	Hole for connecting pipe
23	Supply to water tank
24	Feed line connection
25	Return line connection

Copper tube	Valve 1	Valve 2
KS200-DC	7/8"	5/8"
KS250-DC	7/8"	5/8"

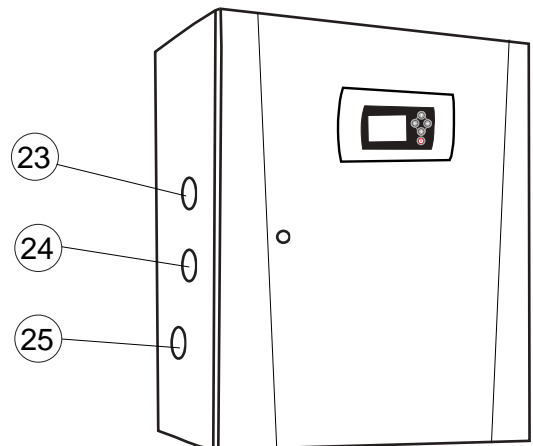
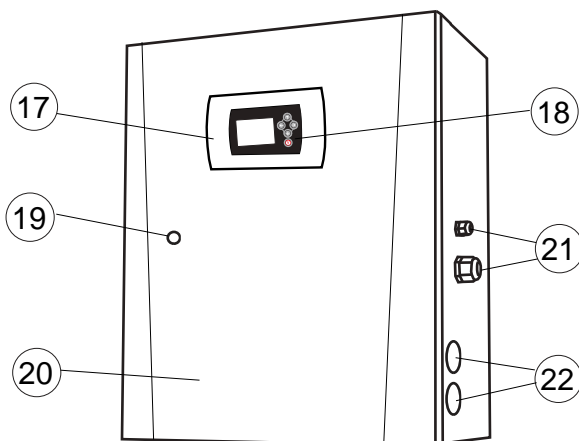

Outdoor unit

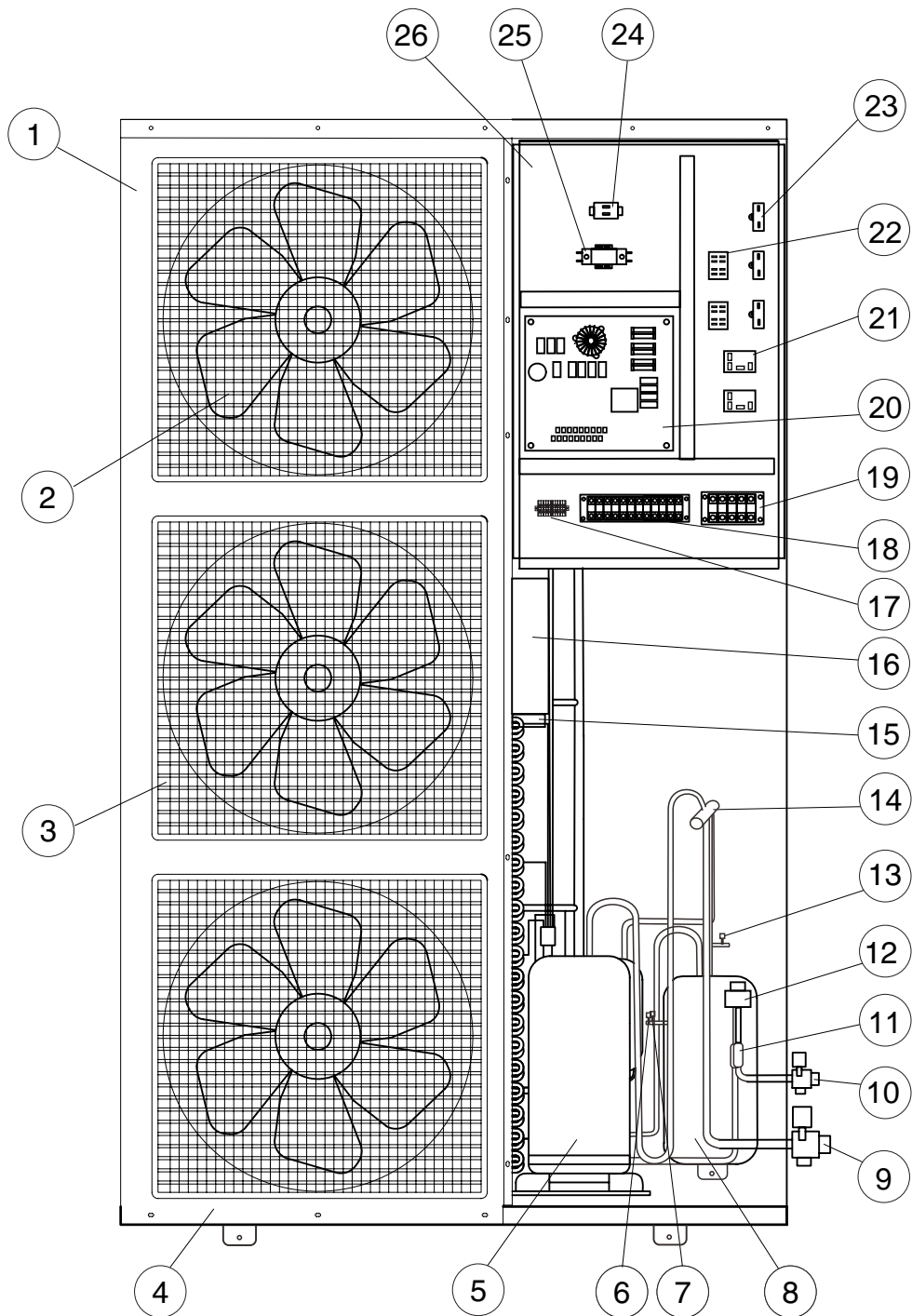

NO.	NAME	NO.	NAME	NO.	NAME
1	Top panel	10	Valve 2	19	White terminal
2	Outdoor fan and motor	11	Filter	20	Outdoor main PCB
3	Front grill	12	Electrical expansion valve	21	Relay for electrical heater
4	Bottom plate	13	Low pressure switch	22	Public terminal
5	Compressor	14	Four way valve	23	Fan motor capacitor
6	High pressure switch 1	15	Reactor	24	PTC
7	High pressure switch 2	16	Module and Radiator	25	AC Contactor
8	Liquid vapor separator	17	2.5mm ² terminal	26	Outdoor electrical box
9	Valve 1	18	Black terminal		

18. Dimensions

Indoor unit

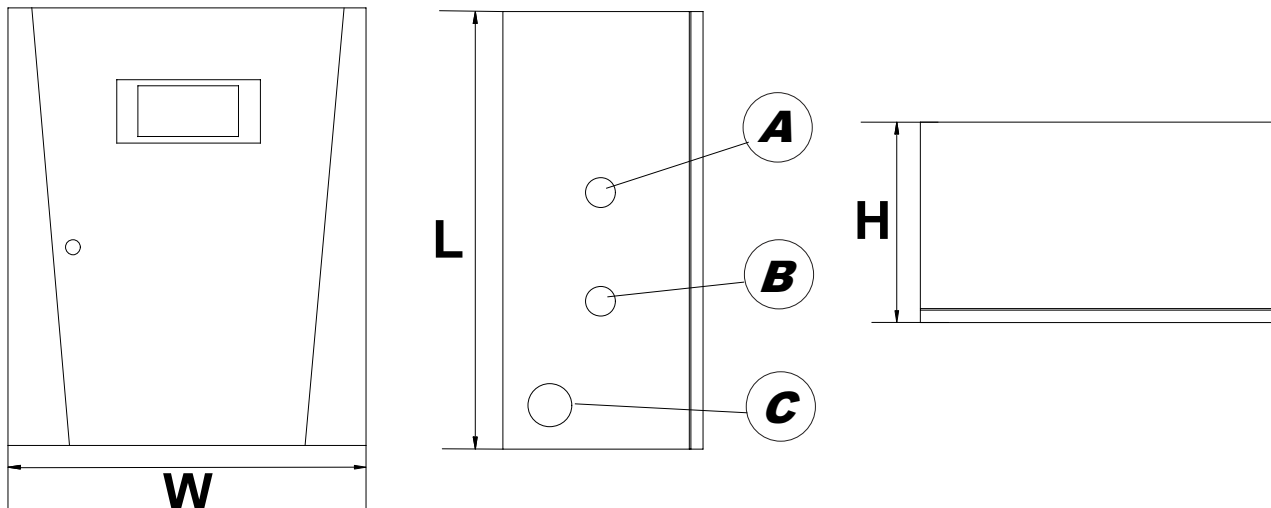

Connection Pipe	SIZE	TYPE	Dimensions (mm)			
			L	M	H	
A	1"	External thread	KS200-DC/ KS250-DC	850	650	330
B	1"	External thread				
C	1"	External thread				

Outdoor unit

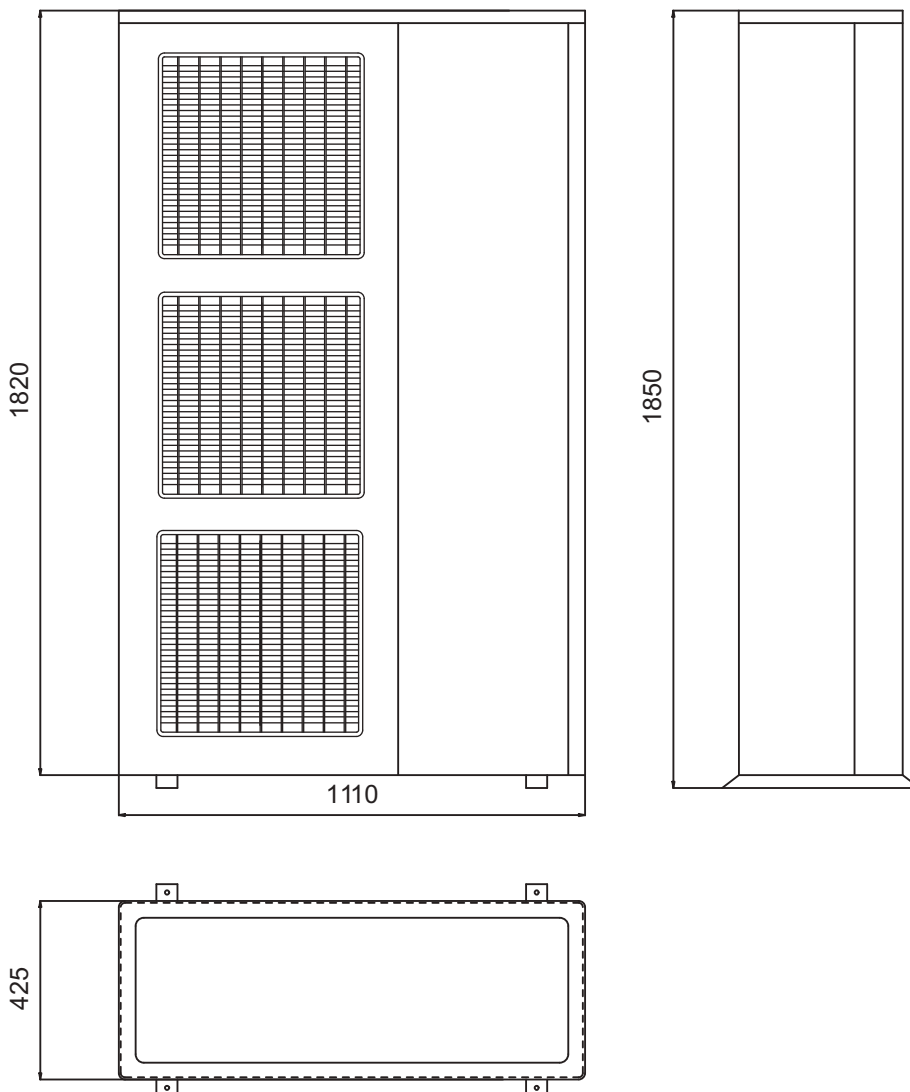

19. Wiring diagrams

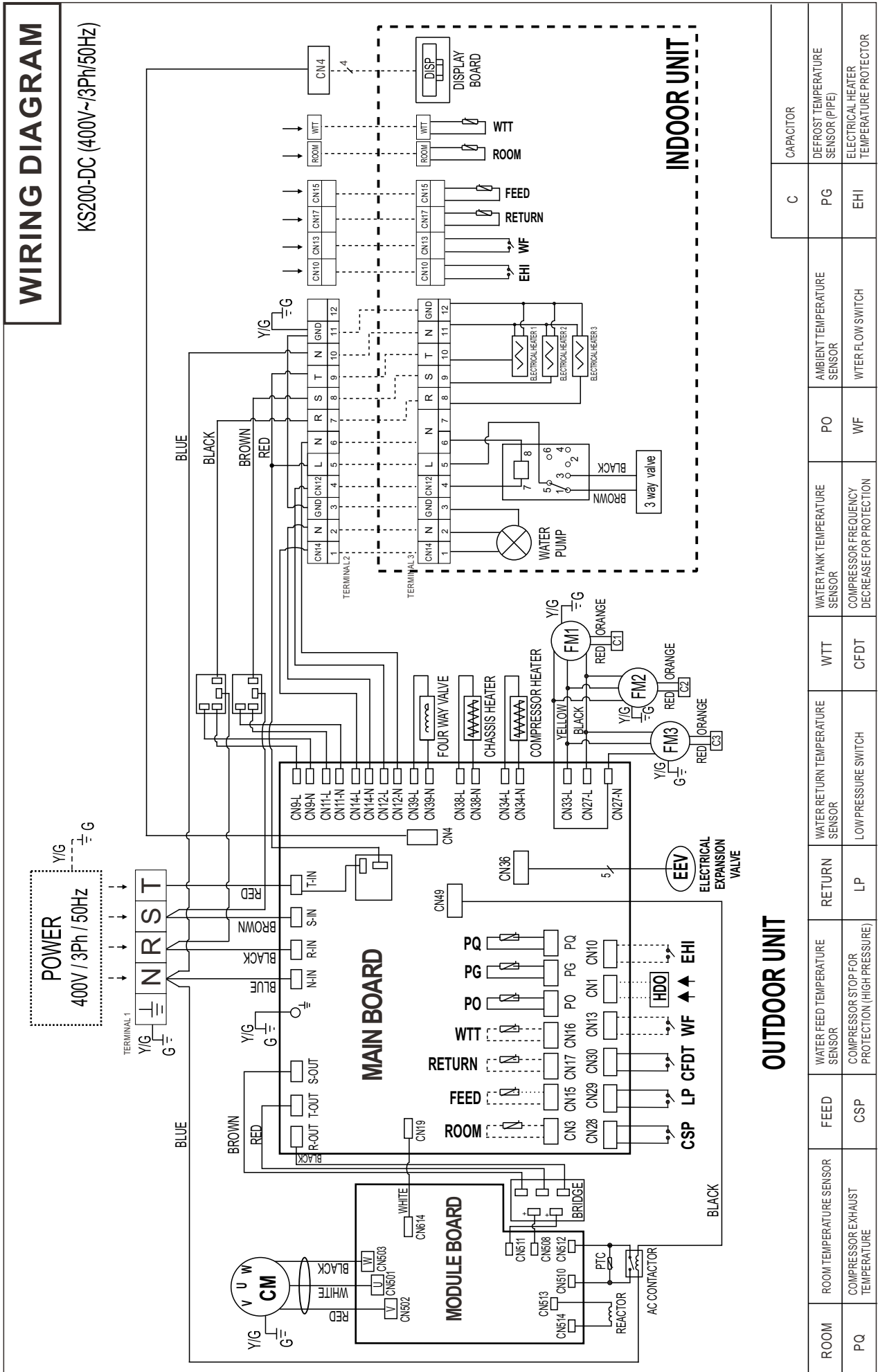

20 . Technical Characteristics

Model	KS200-DC	KS250-DC
Heating capacity	19800W	25800W
Heating power input	4805W	6386W
Cooling capacity	18200W	22500W
Cooling power input	6546W	8093W
Current (heating/cooling)	8.1A/11.1A	10.8A/13.7A
Power supply	380-415V~/50Hz/3Ph	380-415V~/50Hz/3Ph
Electrical heater power	3000W X 3	3000W X 3
Electrical heater current	13A X 3	13A X 3
Max. Input power	7950W	10150W
Max. Current	25.0A	27.0A
Max Discharge Pressure	4.0MPa	4.0MPa
Max Suction Pressure	0.95MPa	0.95MPa
Refrigerant	R410a /4.5KG	R410a /5.0KG
Water pump flux	3.5m ³ /h	4.4m ³ /h
Water Proof Class	IPX4	IPX4
Ambient condition	-20 - 43°C	-20 - 43°C
Noise (indoor)	48dB(A)	48dB(A)
Noise (outdoor)	52dB(A)	53dB(A)
Net Weight (indoor)	56KG	58KG
Net Weight (outdoor)	143KG	153KG

The series number for your heat pump:

Please check above series number whether is the same as your heat pump, and always provide the series number if you ask for help from retailer.

