

VERBINDUNGSTECHNIK

**Gewindefittings
aus Temperguss
nach DIN EN 10242
Designsymbol „A“,
Gewinde nach DIN EN 10226**

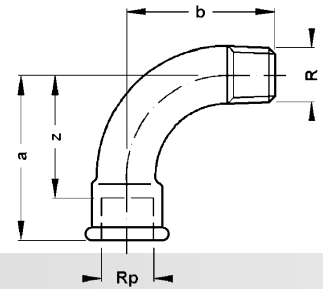

РОСС DE.АЮ.Н05760



Katalog-Nr. und -bezeichnung

1# – Bogen 90°, lang, mit Innen- und Außengewinde, schwarz oder verzinkt

Artikel-Nr.	Abmessung Rp x R	Beutel	Karton	EAN-Code-Nr.	a	b	z
schwarz							
9114S#	1/4	10	400	4021343185687	40	36	30
9138S#	3/8	10	250	4021343099793	48	42	38
9112S#	1/2	10	160	4021343095870	55	48	42
9134S#	3/4	10	90	4021343099755	69	60	54
911S#	1	10	40	4021343095740	85	75	68
91114S#	1 1/4		20	4021343095832	105	95	86
91112S#	1 1/2		18	4021343095795	116	105	97
912S#	2		8	4021343095955	140	130	116
91212SA#*	2 1/2		4	4021343096426	176	165	149
verzinkt							
9114V#	1/4	10	400	4021343185694	40	36	30
9138V#	3/8	10	250	4021343099816	48	42	38
9112V#	1/2	10	160	4021343095894	55	48	42
9134V#	3/4	10	90	4021343099779	69	60	54
911V#	1	10	40	4021343095764	85	75	68
91114V#	1 1/4		20	4021343095856	105	95	86
91112V#	1 1/2		18	4021343095818	116	105	97
912V#	2		8	4021343095979	140	130	116
91212VA#	2 1/2		4	4021343096464	176	165	149
913V#	3		2	4021343096563	206	190	176
914V#	4		1	4021343099854	264	245	228

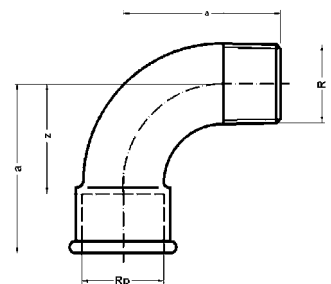

Katalog-Nr. und -bezeichnung

1 A# – Bogen 90°, kurz, mit Innen- und Außengewinde, schwarz oder verzinkt

Artikel-Nr.	Abmessung Rp x R	Beutel	Karton	EAN-Code-Nr.	a	z
schwarz						
91A12S#	1/2	10	160	4021343156236	45	32
91A34S#	3/4	10	70	4021343168123	50	35
91A1S#	1	10	60	4021343156229	63	46
91A114S#	1 1/4		30	4021343156250	76	57
91A112S#	1 1/2		20	4021343156243	85	66
91A2S#	2		10	4021343156267	102	78
verzinkt						
91A12V#	1/2	10	160	4021343156274	45	32

Katalog-Nr. und -bezeichnung

1 A# – Bogen 90°, kurz, mit Innen- und Außengewinde, schwarz oder verzinkt (Fortsetzung)

Artikel-Nr.	Abmessung Rp x R	Beutel	Karton	EAN-Code-Nr.	a	z
91A34V#	3/4	10	70	4021343156281	50	35
91A1V#	1	10	60	4021343156298	63	46
91A114V#	1 1/4		30	4021343156304	76	57
91A112V#	1 1/2		20	4021343156311	85	66
91A2V#	2		10	4021343156328	102	78

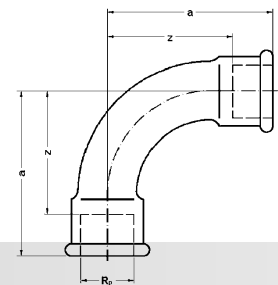

Katalog-Nr. und -bezeichnung

2# – Bogen 90°, lang, beidseitig mit Innengewinde, schwarz oder verzinkt

Artikel-Nr.	Abmessung Rp	Beutel	Karton	EAN-Code-Nr.	a	z
schwarz						
9214S#*	1/4	10	250	4021343186851	40	30
9238S#	3/8	10	200	4021343101021	48	38
9212S#	1/2	10	120	4021343100536	55	42
9234S#	3/4	10	60	4021343100987	69	54
921S#	1	10	40	4021343100406	85	68
92114S#	1 1/4		20	4021343100499	105	86
92112S#	1 1/2		15	4021343100451	116	97
922S#	2		7	4021343100611	140	116
92212SA#	2 1/2		3	4021343100772	176	149
923S#	3		2	4021343100949	205	175
924S#*	4		1	4021343101069	260	224
verzinkt						
9214V#	1/4	10	250	4021343186868	40	30
9238V#	3/8	10	200	4021343101045	48	38
9212V#	1/2	10	120	4021343100550	55	42
9234V#	3/4	10	60	4021343101007	69	54
921V#	1	10	40	4021343100420	85	68
92114V#	1 1/4		20	4021343100512	105	86
92112V#	1 1/2		15	4021343100475	116	97
922V#	2		7	4021343100635	140	116
92212VA#	2 1/2		3	4021343100802	176	149
923V#	3		2	4021343100963	205	175
924V#	4		2	4021343101083	260	224

* nur noch aus Lagervorrat lieferbar.

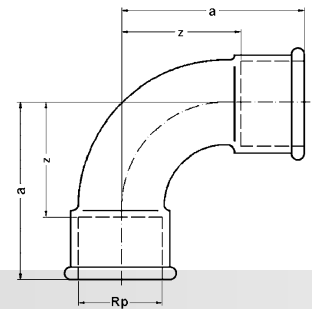

Katalog-Nr. und -bezeichnung

2A# – Bogen 90°, kurz, beidseitig mit Innengewinde, schwarz oder verzinkt

Artikel-Nr.	Abmessung Rp	Beutel	Karton	EAN-Code-Nr.	a	z
schwarz						
92A12S#	1/2	10	120	4021343156335	45	32
92A34S#	3/4	10	60	4021343156359	50	35
92A1S#	1	10	40	4021343156366	63	46
92A114S#	1 1/4	20	20	4021343156380	76	57
92A112S#	1 1/2	20	20	4021343156373	85	66
92A2S#	2	9	9	4021343156342	102	78
verzinkt						
92A12V#	1/2	10	120	4021343156397	45	32
92A34V#	3/4	10	60	4021343156403	50	35
92A1V#	1	10	40	4021343156410	63	46
92A114V#	1 1/4	20	20	4021343156434	76	57
92A112V#	1 1/2	20	20	4021343156427	85	66
92A2V#	2	9	9	4021343156441	102	78

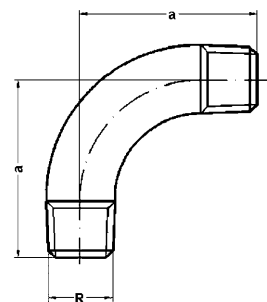

Katalog-Nr. und -bezeichnung

3# – Bogen 90°, beidseitig mit Außengewinde, verzinkt

Artikel-Nr.	Abmessung R	Beutel	Karton	EAN-Code-Nr.	a
9338V#*	3/8	10	250	4021343188145	42
9312V#	1/2	10	200	4021343186080	48
9334V#	3/4	10	80	4021343186097	60
931V#	1	10	50	4021343186103	63
93114V#	1 1/4	20	20	4021343188121	76
93112V#	1 1/2	25	25	4021343188114	89
932V#	2	8	8	4021343188138	105

* nur noch aus Lagervorrat lieferbar.



Katalog-Nr. und -bezeichnung

40# – Bogen 45°, mit Innen- und Außengewinde, schwarz oder verzinkt

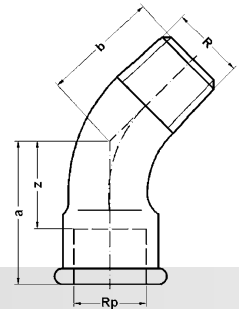

Artikel-Nr.	Abmessung Rp x R	Beutel	Karton	EAN-Code-Nr.	a	b	z
schwarz							
94038S#	3/8	10	300	4021343113109	30	24	20
94012S#	1/2	10	220	4021343112881	36	30	23
94034S#	3/4	10	100	4021343113055	43	36	28
9401S#	1	10	70	4021343112751	51	42	34
940114S#	1 1/4		35	4021343112843	64	54	45
940112S#	1 1/2		25	4021343112805	68	58	49
9402S#	2		14	4021343112973	81	70	57
9404S#*	4		1	4021343188909	143	148	115
verzinkt							
94038V#*	3/8	10	300	4021343113123	30	24	20
94012V#	1/2	10	220	4021343112904	36	30	23
94034V#	3/4	10	100	4021343113079	43	36	28
9401V#	1	10	70	4021343112775	51	42	34
940114V#	1 1/4		35	4021343112867	64	54	45
940112V#	1 1/2		25	4021343112829	68	58	49
9402V#	2		14	4021343112997	81	70	57
940212V#	2 1/2		6	4021343188879	99	100	75
9403V#	3		4	4021343188893	113	118	84
9404V#	4		1	4021343188916	143	148	115

* nur noch aus Lagervorrat lieferbar.



Katalog-Nr. und -bezeichnung

41# – Bogen 45°, beidseitig mit Innengewinde, schwarz oder verzinkt

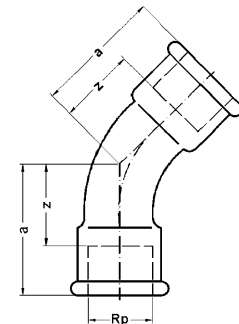

Artikel-Nr.	Abmessung Rp	Beutel	Karton	EAN-Code-Nr.	a	z
schwarz						
94112S#*	1/2	10	140	4021343113307	36	23
94134S#*	3/4	10	80	4021343113444	43	28
9411S#*	1	10	60	4021343113161	51	34
941114S#*	1 1/4	10	25	4021343113260	64	45
941112S#*	1 1/2		22	4021343113215	68	49
9412S#*	2		15	4021343113352	81	57
941212S#*	2 1/2		6	4021343188923	103	80
9413S#*	3		3	4021343188947	113	83
9414S#*	4		1	4021343188961	146	118
verzinkt						
94138V#*	3/8	10	280	4021343113512	30	20
94112V#	1/2	10	140	4021343113321	36	23

* nur noch aus Lagervorrat lieferbar.

Katalog-Nr. und -bezeichnung

41# – Bogen 45°, beidseitig mit Innengewinde, schwarz oder verzinkt (Fortsetzung)

Artikel-Nr.	Abmessung Rp	Beutel	Karton	EAN-Code-Nr.	a	z
94134V#	3/4	10	80	4021343113468	43	28
9411V#	1	10	60	4021343113185	51	34
941114V#	1 1/4		25	4021343113284	64	45
941112V#	1 1/2		22	4021343113239	68	49
9412V#	2		15	4021343113376	81	57
941212V#	2 1/2		5	4021343188930	103	80
9413V#	3		3	4021343188954	113	83
9414V#	4		1	4021343186158	146	118

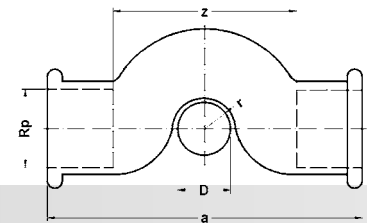

Katalog-Nr. und -bezeichnung

85# – Überspringbogen, beidseitig mit Innengewinde, schwarz oder verzinkt

Artikel-Nr.	Abmessung Rp	Beutel	Karton	EAN-Code-Nr.	a	z	D
schwarz							
98538S#*	3/8	10	90	4021343114113	76	56	3/8
98512S#	1/2	10	80	4021343114038	90	64	1/2
98534S#	3/4	10	50	4021343114076	106	76	3/4
9851S#*	1	10	20	4021343113994	125	91	1
verzinkt							
98512V#	1/2	10	80	4021343114052	90	64	1/2
98534V#	3/4	10	50	4021343114090	106	76	3/4
9851V#	1	10	30	4021343114014	125	91	1

* nur noch aus Lagervorrat lieferbar.



Katalog-Nr. und -bezeichnung

90# – Winkel 90°, beidseitig mit Innengewinde, schwarz oder verzinkt

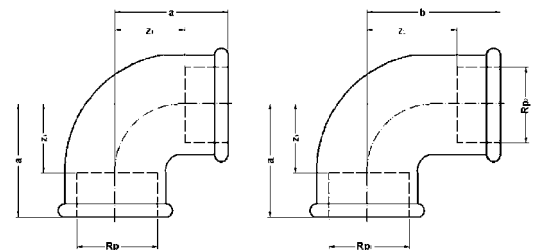

Artikel-Nr.	Abmessung Rp1 x Rp2	Beutel	Karton	EAN-Code-Nr.	a	b	z1	z2
schwarz								
99014S#	1/4	10	450	4021343114687	21		11	
99038S#	3/8	10	300	4021343115134	25		15	
99012S#	1/2	10	200	4021343114557	28		15	

Katalog-Nr. und -bezeichnung

90# – Winkel 90°, beidseitig mit Innengewinde, schwarz oder verzinkt (Fortsetzung)

Artikel-Nr.	Abmessung Rp1 x Rp2	Beutel	Karton	EAN-Code-Nr.	a	b	z1	z2
99034S#	3/4	10	120	4021343115011	33		18	
9901S#	1	10	70	4021343114212	38		21	
990114S#	11/4		45	4021343114434	45		26	
990112SA#	11/2		30	4021343114250	50		31	
9902S#	2		18	4021343114755	58		34	
990212S#	21/2		10	4021343114915	69		42	
9903S#	3		5	4021343114977	78		48	
9904S#*	4		2	4021343114335	96		60	
9901238S#	1/2 x 3/8	10	200	4021343114595	26	26	13	16
9903438S#*	3/4 x 3/8	10	150	4021343115097	28	28	13	13
9903412S#	3/4 x 1/2	10	150	4021343115059	30	31	15	18
990112SB#	1 x 1/2	10	100	4021343114274	32	34	15	21
990134S#	1 x 3/4	10	90	4021343114649	35	36	18	21
99011434S#	11/4 x 3/4		55	4021343114519	36	41	17	26
9901141S#	11/4 x 1		55	4021343114472	40	42	21	25
9901121S#*	11/2 x 1		45	4021343114335	42	46	23	29
990112114S#*	11/2 x 11/4		35	4021343114373	46	48	27	29
99021S#*	2 x 1		25	4021343114793	44	52	8	6
9902114S#*	2 x 11/4		20	4021343114878	55	50	24	34
9902112S#*	2 x 11/2		20	4021343114830	52	55	28	36
verzinkt								
99018V#	1/8	10	600	4021343114731	20		13	
99014V#	1/4	10	450	4021343114700	21		11	
99038V#	3/8	10	300	4021343115158	25		15	
99012V#	1/2	10	200	4021343114571	28		15	
99034V#	3/4	10	120	4021343115035	33		18	
9901V#	1	10	70	4021343114236	38		21	
990114V#	11/4		45	4021343114458	45		26	
990112VA#	11/2		30	4021343114298	50		31	
9902V#	2		18	4021343114779	58		34	
990212V#	21/2		10	4021343114939	69		42	
9903V#	3		5	4021343114991	78		48	
9904V#	4		2	4021343115226	98		65	
9905V#	5		1	4021343166211	114		82	
9903814V#*	3/8 x 1/4	10	250	4021343115189	23	23	13	13
9901238V#	1/2 x 3/8	10	200	4021343114618	26	26	13	16
9903438V#*	3/4 x 3/8	10	150	4021343115110	28	28	13	13
9903412V#	3/4 x 1/2	10	150	4021343115073	30	31	15	18
990112VB#	1 x 1/2	10	100	4021343114311	32	34	15	21
990134V#	1 x 3/4	10	90	4021343114663	35	36	18	21
99011434V#	11/4 x 3/4		55	4021343114533	36	41	17	26
9901141V#	11/4 x 1		55	4021343114496	40	42	21	25
99011234V#	11/2 x 3/4		45	4021343124112	23	30	9	12
9901121V#	11/2 x 1		45	4021343114359	42	46	23	29
990112114V#	11/2 x 11/4		40	4021343114397	46	48	27	29
99021V#	2 x 1		25	4021343114816	24	30	8	6
9902114V#	2 x 11/4		20	4021343114892	48	53	24	34
9902112V#	2 x 11/2		20	4021343114854	52	55	28	36
9902122V#	21/2 x 2		12	4021343194528	30	33	10	10

* nur noch aus Lagervorrat lieferbar.

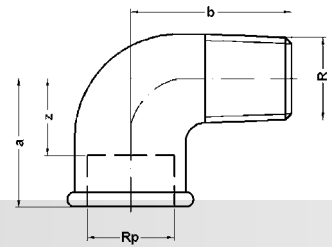

Katalog-Nr. und -bezeichnung

92# – Winkel 90°, mit Innen- und Außengewinde, schwarz oder verzinkt

Artikel-Nr.	Abmessung Rp x R	Beutel	Karton	EAN-Code-Nr.	a	b	z
schwarz							
99214S#	1/4	10	600	4021343115530	21	28	11
99238S#	3/8	10	350	4021343115752	25	32	15
99212S#	1/2	10	220	4021343115493	28	38	15
99234S#	3/4	10	100	4021343115714	33	46	18
9921S#	1	10	70	4021343115363	38	56	21
992114S#	1 1/4		40	4021343115448	45	63	26
992112S#	1 1/2		30	4021343115400	50	68	31
9922S#	2		15	4021343115592	58	78	34
992212S#	2 1/2		9	4021343115639	69	98	42
9923S#	3		5	4021343115677	78	99	48
9924S#*	4		2	4021343115790	96	119	60
verzinkt							
99214V#	1/4	10	600	4021343115554	21	28	11
99238V#	3/8	10	350	4021343115776	25	32	15
99212V#	1/2	10	220	4021343115516	28	38	15
99234V#	3/4	10	100	4021343115738	33	46	18
9921V#	1	10	70	4021343115387	38	56	21
992114V#	1 1/4		40	4021343115462	45	63	26
992112V#	1 1/2		30	4021343115424	50	68	31
9922V#	2		15	4021343115615	58	78	34
992212V#	2 1/2		9	4021343115653	69	98	42
9923V#	3		5	4021343115691	78	99	48
9924V#	4		2	4021343115813	96	119	60

* nur noch aus Lagervorrat lieferbar

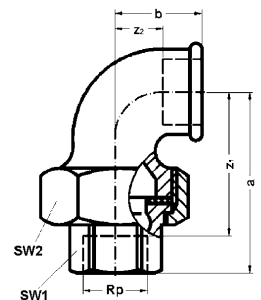

Katalog-Nr. und -bezeichnung

95# – Winkelverschraubung 90°, beidseitig mit Innengewinde, flachdichtend, schwarz oder verzinkt

Artikel-Nr.	Abmessung Rp	Beutel	Karton	EAN-Code-Nr.	a	b	z1	z2	SW1	SW2
schwarz										
99514S#*	1/4	10	120	4021343188978	48	21	38	11	18	32
99538S#*	3/8	10	100	4021343116179	52	25	42	15	22	36
99534S#	3/4	10	50	4021343116131	62	33	47	18	32	49
9951S#	1	10	40	4021343115868	72	38	55	21	38	55
995114S#	1 1/4		20	4021343115950	82	45	63	26	48	70
995112S#	1 1/2		16	4021343115912	90	50	71	31	53	75
9953S#*	3		4	4021343189012	135	78	105	48	95	125

* nur noch aus Lagervorrat lieferbar

95# – Winkelverschraubung 90°, beidseitig mit Innengewinde, flachdichtend, schwarz oder verzinkt (Fortsetzung)

Artikel-Nr.	Abmessung Rp	Beutel	Karton	EAN-Code-Nr.	a	b	z1	z2	SW1	SW2
9954S#*	4		3	4021343189036	165	96	129	60	123	165
verzinkt										
99512V#	1/2	10	80	4021343116018	58	28	45	15	25	41
99534V#	3/4	10	50	4021343116155	62	33	47	18	32	49
9951V#	1	10	40	4021343115882	72	38	55	21	38	55
995114V#	1 1/4		20	4021343115974	82	45	63	26	48	70
995112V#	1 1/2		16	4021343115936	90	50	71	31	53	75
9952V#	2		10	4021343116070	100	58	76	34	67	91
995212V#	2 1/2		6	4021343189005	122	70	95	43	85	110
9954V#*	4		3	402134318943	165	96	129	60	123	165

* nur noch aus Lagervorrat lieferbar.

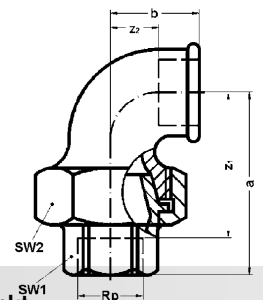

Katalog-Nr. und -bezeichnung

96# – Winkelverschraubung 90°, konisch dichtend, beidseitig mit Innengewinde, schwarz oder verzinkt

Artikel-Nr.	Abmessung Rp	Beutel	Karton	EAN-Code-Nr.	a	b	z1	z2	SW1	SW2
schwarz										
99614S#	1/4	10	120	4021343189050	48	21	38	11	18	32
99638S#	3/8	10	100	4021343116575	52	25	42	15	22	36
99612S#	1/2	10	80	4021343116384	58	28	45	15	25	41
99634S#	3/4	10	50	4021343116520	62	33	47	18	32	49
9961S#	1	10	40	4021343116261	72	38	55	21	38	55
996114S#	1 1/4		20	4021343116346	82	45	63	26	48	70
996112S#	1 1/2		16	4021343116308	90	50	71	31	53	75
9962S#	2		10	4021343116445	100	58	76	34	67	91
996212S#*	2 1/2		5	4021343189074	122	70	95	43	83	110
9964S#*	4		3	4021343189098	165	96	129	60	123	165
verzinkt										
99638V#	3/8	10	100	4021343116599	52	25	42	15	22	36
99612V#	1/2	10	80	4021343116407	58	28	45	15	25	41
99634V#	3/4	10	50	4021343116544	62	33	47	18	32	49
9961V#	1	10	40	4021343116285	72	38	55	21	38	55
996114V#	1 1/4		20	4021343116360	82	45	63	26	48	70
996112V#	1 1/2		16	4021343116322	90	50	71	31	53	75
9962V#	2		10	4021343116469	100	58	76	34	67	91
996212V#	2 1/2		5	4021343164668	114	75	86	50	86	111
9963V#	3		4	4021343164675	128	82	96	56	99	132

* nur noch aus Lagervorrat lieferbar.

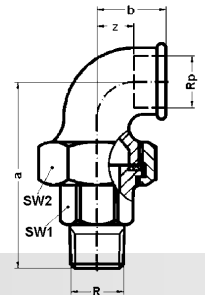

Katalog-Nr. und -bezeichnung

97# – Winkelverschraubung 90°, mit Innen- und Außengewinde, flachdichtend, schwarz oder verzinkt

Artikel-Nr.	Abmessung R x Rp	Beutel	Karton	EAN-Code-Nr.	a	b	z	SW1	SW2
schwarz									
99714S#*	1/4	10	120	4021343189111	61	21	11	18	32
99738S#*	3/8	10	100	4021343116933	65	25	15	22	36
99712S#	1/2	10	80	4021343116759	76	28	15	25	41
99734S#	3/4	10	40	4021343116896	82	33	18	32	49
9971S#	1	10	30	4021343116636	94	38	21	38	55
997114S#	1 1/4		18	4021343116711	107	45	26	48	70
997112S#	1 1/2		12	4021343116674	115	50	31	53	75
9972S#	2		7	4021343116810	128	58	34	67	91
9973S#*	3		2	4021343189159	165	78	48	99	131
verzinkt									
99738V#	3/8	10	100	4021343116957	65	25	15	22	36
99712V#	1/2	10	80	4021343116773	76	28	15	25	41
99734V#	3/4	10	40	4021343116919	82	33	18	32	49
9971V#	1	10	30	4021343116650	94	38	21	38	55
997114V#	1 1/4		18	4021343116735	107	45	26	48	70
997112V#	1 1/2		12	4021343116698	115	50	31	53	75
9972V#	2		7	4021343116834	128	58	34	67	91
9974V#*	4		1	4021343189180	204	96	60	123	165

* nur noch aus Lagervorrat lieferbar.

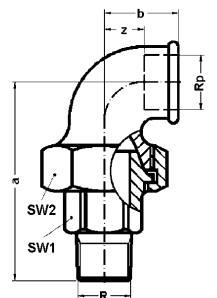

Katalog-Nr. und -bezeichnung

98# – Winkelverschraubung 90°, konisch dichtend, mit Innen- und Außengewinde, schwarz oder verzinkt

Artikel-Nr.	Abmessung Rp x R	Beutel	Karton	EAN-Code-Nr.	a	b	z	SW1	SW2
schwarz									
99814S#	1/4	10	150	4021343189197	61	21	11	18	32
99838S#	3/8	10	100	4021343117336	65	25	15	22	36
99812S#	1/2	10	80	4021343117145	76	28	15	25	41
99834S#	3/4	10	40	4021343117299	82	33	18	32	49
9981S#	1	10	30	4021343117022	94	38	21	38	55
998114S#	1 1/4		18	4021343117107	107	45	26	48	70
998112S#	1 1/2		12	4021343117060	115	50	31	53	75
9982S#	2		7	4021343117213	128	58	34	67	91
998212S#	2 1/2		4	4021343166334	152	70	43	85	110
9984S#*	4		1	4021343189227	204	96	60	123	165

* nur noch aus Lagervorrat lieferbar.

Katalog-Nr. und -bezeichnung

98# – Winkelverschraubung 90°, konisch dichtend, mit Innen- und Außengewinde, schwarz oder verzinkt (Fortsetzung)

Artikel-Nr.	Abmessung R x Rp	Beutel	Karton	EAN-Code-Nr.	a	b	z	SW1	SW2
verzinkt									
99838V#	3/8	10	100	4021343117350	65	25	15	22	36
99812V#	1/2	10	80	4021343117169	76	28	15	25	41
99834V#	3/4	10	40	4021343117312	82	33	18	32	49
9981V#	1	10	30	4021343117046	94	38	21	38	55
998114V#	1 1/4		18	4021343117121	107	45	26	48	70
998112V#	1 1/2		12	4021343117084	115	50	31	53	75
9982V#	2		7	4021343117237	128	58	34	67	91
998212V#	2 1/2		4	4021343166426	152	70	43	85	110
9983V#	3		2	4021343166419	165	78	48	99	131



Katalog-Nr. und -bezeichnung

120# – Winkel 45°, beidseitig mit Innengewinde, schwarz oder verzinkt

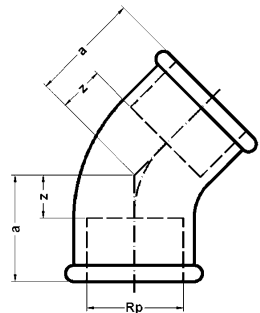

Artikel-Nr.	Abmessung Rp	Beutel	Karton	EAN-Code-Nr.	a	z
schwarz						
912012S#	1/2	10	200	4021343096112	22	9
912034S#	3/4	10	120	4021343096198	25	10
91201S#	1	10	90	4021343095993	28	11
9120114S#	1 1/4		45	4021343096075	33	14
9120112S#	1 1/2		30	4021343096037	36	17
91202S#	2		18	4021343096150	43	19
verzinkt						
912012V#	1/2	10	200	4021343096136	22	9
912034V#	3/4	10	120	4021343096211	25	10
91201V#	1	10	90	4021343096013	28	11
9120114V#	1 1/4		45	4021343096099	33	14
9120112V#	1 1/2		30	4021343096051	36	17
91202V#	2		18	4021343096174	43	19

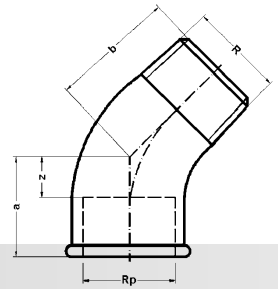

Katalog-Nr. und -bezeichnung

121# – Winkel 45°, mit Innen- und Außengewinde, schwarz oder verzinkt

Artikel-Nr.	Abmessung Rp x R	Beutel	Karton	EAN-Code-Nr.	a	b	z
schwarz							
912112S#	1/2	10	200	4021343096372	22	28	9
912134S#	3/4	10	150	4021343096501	25	32	10
91211S#	1	10	90	4021343096259	28	37	11
9121114S#	1 1/4	50	50	4021343096334	33	43	14
9121112S#	1 1/2	35	35	4021343096297	36	46	17
91212SB#	2	20	20	4021343096440	43	55	19
verzinkt							
912112V#	1/2	10	200	4021343096396	22	28	9
912134V#	3/4	10	150	4021343096525	25	32	10
91211V#	1	10	90	4021343096273	28	37	11
9121114V#	1 1/4	50	50	4021343096358	33	43	14
9121112V#	1 1/2	35	35	4021343096310	36	46	17
91212VB#	2	20	20	4021343096488	43	55	19

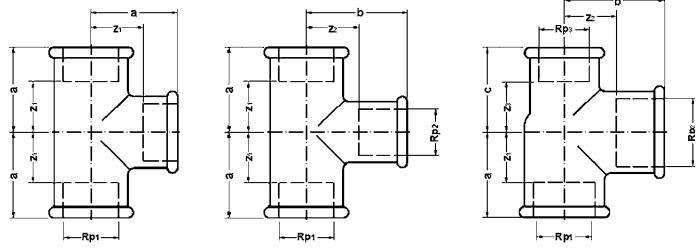

Katalog-Nr. und -bezeichnung

130# – T-Stück, allseitig mit Innengewinde, schwarz oder verzinkt

Artikel-Nr.	Abmessung Rp1 x Rp2 x Rp3	Beutel	Karton	EAN-Code-Nr.	a	b	c	z1	z2	z3
schwarz										
913014S#	1/4	10	300	4021343098239	21			11		
913038S#	3/8	10	180	4021343099373	25			15		
913012S#	1/2	10	120	4021343097843	28			18		
913034S#	3/4	10	60	4021343099052	33			18		
91301S#	1	10	40	4021343096686	38			21		
9130114S#	1 1/4	25	25	4021343097362	45			26		
9130112S#	1 1/2	22	22	4021343096815	50			31		
91302S#	2	13	13	4021343098291	58			34		
9130212SA#	2 1/2	6	6	4021343098475	69			42		
91303S#	3	4	4	4021343098895	78			48		
91304S#	4	2	2	4021343099458	96			60		
9130381438S#*	3/8 x 1/4 x 3/8	10	200	4021343187612	23	23		13	13	
9130381238S#*	3/8 x 1/2 x 3/8	10	130	4021343185830	26	26		15	13	
9130123812S#	1/2 x 3/8 x 1/2	10	140	4021343098000	26	26		13	16	
9130123412S#	1/2 x 3/4 x 1/2	10	90	4021343097966	31	30		18	15	
913012112S#*	1/2 x 1 x 1/2	10	70	4021343187216	34	33		24	19	
9130343834S#	3/4 x 3/8 x 3/4	10	100	4021343099335	28	28		13	18	
9130341234S#	3/4 x 1/2 x 3/4	10	90	4021343099151	30	31		15	18	

Artikel-Nr.	Abmessung Rp1 x Rp2 x Rp3	Beutel	Karton	EAN-Code-Nr.	a	b	c	z1	z2	z3
91301381S#	1 x 3/8 x 1	10	60	4021343185762	30	32		13	22	
91301121S#	1 x 1/2 x 1	10	60	4021343096860	32	34		15	21	
91301341S#	1 x 3/4 x 1	10	50	4021343098093	35	36		18	21	
913011141S#	1 x 11/4 x 1	35		4021343186899	42	40		25	21	
913011121S#	1 x 11/2 x 1	30		4021343186875	46	42		29	23	
913011438114S#*	11/4 x 3/8 x 11/4	40		4021343185724	32	36		13	26	
913011412114S#	11/4 x 1/2 x 11/4	40		4021343097676	34	38		15	25	
913011434114S#	11/4 x 3/4 x 11/4	40		4021343097751	36	41		17	26	
913011411114S#	11/4 x 1 x 11/4	35		4021343097454	40	42		21	25	
9130114112114S#	11/4 x 11/2 x 11/4	20		4021343187100	48	46		29	27	
913011238112S#*	11/2 x 3/8 x 11/2	40		4021343187063	33	38		14	28	
913011212112S#	11/2 x 1/2 x 11/2	30		4021343097164	36	42		17	29	
913011234112S#	11/2 x 3/4 x 11/2	30		4021343097249	38	44		19	29	
913011211112S#	11/2 x 1 x 11/2	25		4021343096921	42	46		23	29	
9130112114112S#	11/2 x 11/4 x 11/2	20		4021343097065	46	48		27	29	
91302122S#	2 x 1/2 x 2	20		4021343098611	61	66		14	35	
91302342S#	2 x 3/4 x 2	20		4021343098857	40	50		16	35	
9130212SB#	2 x 1 x 2	18		4021343098499	44	52		20	34	
913021142S#	2 x 11/4 x 2	15		4021343098437	48	54		24	34	
913021122S#	2 x 11/2 x 2	15		4021343098376	52	55		28	36	
913021234212S#*	21/2 x 3/4 x 21/2	6		4021343187384	44	59		17	44	
91302121212S#*	21/2 x 1 x 21/2	8		4021343187322	48	59		22	43	
9130212114212S#*	21/2 x 11/4 x 21/2	8		4021343187315	53	63		27	46	
9130313S#*	3 x 1 x 3	6		4021343187537	51	67		21	50	
9130323S#*	3 x 2 x 3	5		4021343187551	66	75		34	52	
913032123S#*	3 x 21/2 x 3	5		4021343187544	72	76		42	49	
913041124S#*	4 x 11/2 x 4	3		4021343187636	64	84		58	62	
9130434S#*	4 x 3 x 4	3		4021343187681	84	92		48	15	
9130123838S#	1/2 x 3/8 x 3/8	10	150	4021343098048	26	26	25	13	16	15
9130121238S#	1/2 x 1/2 x 3/8	10	150	4021343097904	28	28	26	15	15	16
9130341212S#	3/4 x 1/2 x 1/2	10	100	4021343099113	30	31	28	15	18	15
9130343438S#	3/4 x 3/4 x 3/8	10	90	4021343185793	33	33	28	18	18	18
9130343412S#	3/4 x 3/4 x 1/2	10	80	4021343099250	33	33	31	18	18	18
913011212S#*	1 x 1/2 x 1/2	10		4021343097126	32	34	28	15	21	15
913011234S#	1 x 1/2 x 3/4	10	70	4021343185700	32	34	30	15	21	15
913013412S#	1 x 3/4 x 1/2	10	50	4021343098130	35	36	31	18	21	18
913013434S#	1 x 3/4 x 3/4	10	50	4021343098178	35	36	33	18	21	18
91301138S#	1 x 1 x 3/8	10	60	4021343187087	38	38	32	21	21	22
91301112S#	1 x 1 x 1/2	10	50	4021343096730	38	38	34	21	21	21
91301134S#	1 x 1 x 3/4	10	50	4021343097300	38	38	36	21	21	21
9130114121S#	11/4 x 1/2 x 1	45		4021343187148	34	38	32	15	25	15
9130114341S#	11/4 x 3/4 x 1	40		4021343187179	36	41	35	17	26	18
9130114112S#*	11/4 x 1 x 1/2	40		4021343187124	48	46	48	29	27	29
9130114134S#*	11/4 x 1 x 3/4	40		4021343187155	40	42	36	21	25	21
913011411S#	11/4 x 1 x 1	35		4021343097409	40	42	38	21	25	21
913011411412S#	11/4 x 11/4 x 1/2	35		4021343097577	45	45	38	26	26	25
91301141141S#	11/4 x 11/4 x 1	30		4021343097539	45	45	42	26	26	25
913011211S#	11/2 x 1 x 1	25		4021343187025	42	46	38	23	29	21
91301121141S#*	11/2 x 11/4 x 1	25		4021343187001	46	48	42	27	29	25
9130112114114S#	11/2 x 11/4 x 11/4	28		4021343186998	46	48	45	27	29	26
913011211234S#*	11/2 x 11/2 x 3/4	30		4021343186967	50	50	44	31	31	29
91301121121S#	11/2 x 11/2 x 1	25		4021343186943	50	50	46	31	31	29
91302112114S#*	2 x 11/2 x 11/4	15		4021343187254	52	55	49	29	37	31
9130221S#*	2 x 2 x 1	18		4021343187476	58	58	51	38	38	37
913022114S#	2 x 2 x 11/4	15		4021343187421	58	58	54	34	34	35
913022112S#	2 x 2 x 11/2	24		4021343187407	58	58	55	34	34	36
91302122122S#*	21/2 x 21/2 x 2	6		4021343187339	70	70	68	43	43	48
verzinkt										
913014V#	1/4	10	300	4021343098253	21			11		
913038V#	3/8	10	180	4021343099397	25			15		
913012V#	1/2	10	120	4021343097867	28			18		
913034V#	3/4	10	60	4021343099076	33			18		
91301V#	1	10	40	4021343096709	38			21		
9130114V#	11/4	25		4021343097386	45			26		
9130112V#	11/2	22		4021343096839	50			31		
91302V#	2	13		4021343098314	58			34		

Katalog-Nr. und -bezeichnung

130# – T-Stück, allseitig mit Innengewinde, schwarz oder verzinkt (Fortsetzung)

Artikel-Nr.	Abmessung Rp1 x Rp2 x Rp3	Beutel	Karton	EAN-Code-Nr.	a	b	c	z1	z2	z3
9130212VA#	21/2		6	4021343098512	69			42		
91303V#	3		4	4021343098918	78			48		
91304V#	4		2	4021343099472	96			60		
91305V#	5		1	4021343166235	115			75		
91306V#*	6		2	4021343168130	115			75		
9130381238V#	3/8 x 1/2 x 3/8	10	130	4021343187605	26	26	26	15	13	16
9130121412V#	1/2 x 1/4 x 1/2	10	150	4021343185755	25	25		15	18	
9130123812V#	1/2 x 3/8 x 1/2	10	140	4021343098024	26	26		13	16	
9130123412V#	1/2 x 3/4 x 1/2	10	90	4021343097980	31	30		18	15	
913012112V#	1/2 x 1 x 1/2	10	70	4021343187223	34	33		24	19	
9130343834V#	3/4 x 3/8 x 3/4	10	100	4021343099359	28	28		13	18	
9130341234V#	3/4 x 1/2 x 3/4	10	90	4021343099175	30	31		15	18	
913034134V#	3/4 x 1 x 3/4	10	50	4021343099236	37	48		22	32	
91301381V#	1 x 3/8 x 1	10	60	4021343185779	30	32		13	22	
91301121V#	1 x 1/2 x 1	10	60	4021343096884	32	34		15	21	
91301341V#	1 x 3/4 x 1	10	50	4021343098116	35	36		18	21	
913011141V#	1 x 11/4 x 1		35	4021343181702	42	40		25	21	
913011121V#	1 x 11/2 x 1		30	4021343186882	46	42		29	23	
913011412114V#	11/4 x 1/2 x 11/4		40	4021343097690	34	38		15	25	
913011434114V#	11/4 x 3/4 x 11/4		40	4021343097775	36	41		17	26	
91301141114V#	11/4 x 1 x 11/4		35	4021343097478	40	42		21	25	
9130114112114V#	11/4 x 11/2 x 11/4		20	4021343187117	48	46		29	27	
913011238112V#*	11/2 x 3/8 x 11/2		40	4021343187070	33	38		14	28	
913011212112V#	11/2 x 1/2 x 11/2		30	4021343097188	36	42		17	29	
913011234112V#	11/2 x 3/4 x 11/2		30	4021343097263	38	44		19	29	
91301121112V#	11/2 x 1 x 11/2		25	4021343096945	42	46		23	29	
9130112114112V#	11/2 x 11/4 x 11/2		20	4021343097089	46	48		27	29	
91301122112V#	11/2 x 2 x 11/2		18	4021343187056	57	56		38	34	
91302122V#	2 x 1/2 x 2		20	4021343098635	61	66		14	35	
91302342V#	2 x 3/4 x 2		20	4021343098871	40	50		16	35	
9130212VB#	2 x 1 x 2		18	4021343098536	44	52		20	34	
913021142V#	2 x 11/4 x 2		15	4021343098451	48	54		24	34	
913021122V#	2 x 11/2 x 2		15	4021343098390	52	55		28	36	
913021234212V#	21/2 x 3/4 x 21/2		6	4021343187391	44	59		17	44	
91302121212V#	21/2 x 1 x 21/2		8	4021343164637	48	59		22	43	
9130212114212V#	21/2 x 11/4 x 21/2		8	4021343164644	53	63		27	46	
9130212112212V#	21/2 x 11/2 x 21/2		8	4021343166341	56	64		32	46	
91302122212V#	21/2 x 2 x 21/2		8	4021343166433	62	67		38	44	
9130313V#	3 x 1 x 3		6	4021343164651	51	67		21	50	
913031143V#	3 x 11/4 x 3		6	4021343187520	51	70		29	52	
913031123V#	3 x 11/2 x 3		6	4021343166440	58	71		28	52	
9130323V#	3 x 2 x 3		5	4021343166457	66	75		34	52	
913032123V#	3 x 21/2 x 3		5	4021343166464	72	76		42	49	
9130424V#	4 x 2 x 4		3	4021343099557	71	86		33	60	
913042124V#	4 x 21/2 x 4		2	4021343187667	79	93		34	60	
9130434V#	4 x 3 x 4		3	4021343166471	84	94		37	60	
9130123838V#	1/2 x 3/8 x 3/8	10	150	4021343098062	26	26	25	13	16	15
9130121238V#	1/2 x 1/2 x 3/8	10	150	4021343097928	28	28	26	15	15	16
9130343812V#*	3/4 x 3/8 x 1/2	10	100	4021343185823	28	28	26	13	18	13
9130341212V#	3/4 x 1/2 x 1/2	10	100	4021343099137	30	31	28	15	18	15
9130343412V#	3/4 x 3/4 x 1/2	10	80	4021343099274	33	33	31	18	18	18
913034112V#	3/4 x 1 x 1/2	10	60	4021343187599	36	34	34	23	20	22
913011212V#	1 x 1/2 x 1/2	10	80	4021343097140	32	34	28	15	21	15
913011234V#	1 x 1/2 x 3/4	10	70	4021343185717	32	34	30	15	21	15
913013412V#	1 x 3/4 x 1/2	10	50	4021343098154	35	36	31	18	21	18
913013434V#	1 x 3/4 x 3/4	10	50	4021343098192	35	36	33	18	21	18
91301112V#	1 x 1 x 1/2	10	50	4021343096754	38	38	34	21	21	21
91301134V#	1 x 1 x 3/4	10	50	4021343097324	38	38	36	21	21	21
91301141211V#	11/4 x 1/2 x 1		45	4021343181719	34	38	32	15	25	15
91301143411V#	11/4 x 3/4 x 1		40	4021343187186	36	41	35	17	26	18
9130114112V#	11/4 x 1 x 1/2		40	4021343187131	48	46	48	29	27	29
9130114134V#	11/4 x 1 x 3/4		40	4021343187162	40	42	36	21	25	21
9130114111V#	11/4 x 1 x 1		35	4021343097423	40	42	38	21	25	21
913011411412V#	11/4 x 11/4 x 1/2		35	4021343097591	45	45	38	26	26	25
913011411434V#	11/4 x 11/4 x 3/4		35	4021343097638	45	45	41	26	26	26
91301141141V#	11/4 x 11/4 x 1		30	4021343097553	45	45	42	26	26	25

Katalog-Nr. und -bezeichnung

130# – T-Stück, allseitig mit Innengewinde, schwarz oder verzinkt (Fortsetzung)

Artikel-Nr.	Abmessung Rp1 x Rp2 x Rp3	Beutel	Karton	EAN-Code-Nr.	a	b	c	z1	z2	z3
913011212114V#	11/2 x 1/2 x 11/4	30	4021343181733		35	42	36	17	30	20
9130112111V#	11/2 x 1 x 1	25	4021343187032		42	46	38	23	29	21
91301121114V#	11/2 x 1 x 11/4	25	4021343181740		43	47	40	24	32	24
91301121141V#	11/2 x 11/4 x 1	25	4021343187018		46	48	42	27	29	25
9130112114114V#	11/2 x 11/4 x 11/4	28	4021343186981		46	48	45	27	29	26
913011211212V#	11/2 x 11/2 x 1/2	24	4021343186936		49	50	44	31	32	32
913011211234V#	11/2 x 11/2 x 3/4	30	4021343186974		50	50	44	31	31	29
91301121121V#	11/2 x 11/2 x 1	25	4021343186950		50	50	46	31	31	29
9130112112114V#	11/2 x 11/2 x 11/4	25	4021343186929		50	50	48	32	32	32
91302114114V#	2 x 11/4 x 11/4	15	4021343187285		50	55	46	30	39	30
91302112114V#	2 x 11/2 x 11/4	15	4021343187261		52	55	49	29	37	31
91302112112V#	2 x 11/2 x 11/2	15	4021343185786		52	56	50	32	38	31
91302212V#	2 x 2 x 1/2	15	4021343187469		58	58	52	38	38	40
91302234V#	2 x 2 x 3/4	15	4021343187490		58	58	50	38	38	37
9130221V#	2 x 2 x 1	18	4021343181757		58	58	51	38	38	37
913022114V#	2 x 2 x 11/4	15	4021343181764		58	58	54	34	34	35
913022112V#	2 x 2 x 11/2	24	4021343187414		58	58	55	34	34	36
91302122122V#	21/2 x 21/2 x 2	6	4021343187346		70	70	68	43	43	48

* nur noch aus Lagervorrat lieferbar.

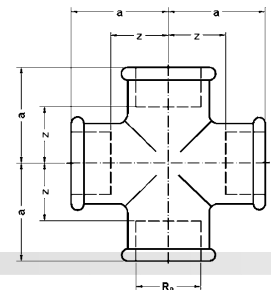

Katalog-Nr. und -bezeichnung

180# – Kreuz-Stück, allseitig mit Innengewinde, schwarz oder verzinkt

Artikel-Nr.	Abmessung Rp	Beutel	Karton	EAN-Code-Nr.	a	z
918038S#*	3/8	10	140	4021343100215	26	16
918012S#	1/2	10	110	4021343100017	28	15
918034S#	3/4	10	50	4021343100178	33	18
91801S#	1	10	40	4021343099892	38	21
9180114S#	11/4	25	4021343099977	45	26	
9180112S#	11/2	18	4021343099939	50	31	
91802S#	2	7	4021343100079	58	34	
9180212S#*	21/2	5	4021343187827	71	45	
91804S# *	4	3	4021343187834	96	60	
verzinkt						
918014V#	1/4	10	250	4021343187810	21	13
918038V#	3/8	10	140	4021343100239	26	16
918012V#	1/2	10	110	4021343100031	28	15
918034V#	3/4	10	50	4021343100192	33	18
91801V#	1	10	40	4021343099915	38	21
9180114V#	11/4	25	4021343099991	45	26	
9180112V#	11/2	18	4021343099953	50	31	
91802V#	2	7	4021343100093	58	34	
9180212V#	21/2	5	4021343185847	71	45	
91803V#	3	3	4021343100154	79	53	

* nur noch aus Lagervorrat lieferbar.



Katalog-Nr. und -bezeichnung

221# – Winkelverteiler, allseitig mit Innengewinde, schwarz oder verzinkt

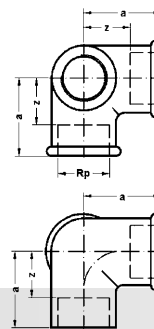

Artikel-Nr.	Abmessung Rp	Beutel	Karton	EAN-Code-Nr.	a	z
schwarz						
922112S#	1/2	10	120	4021343100734	28	15
922134S#	3/4	10	80	4021343100833	33	18
92211S#	1	10	50	4021343100659	38	21
922112S#*	1 1/2		25	4021343187841	50	31
verzinkt						
922138V#	3/8	10	190	4021343100901	25	16
922112V#	1/2	10	120	4021343100758	28	15
922134V#	3/4	10	80	4021343100857	33	18
92211V#	1	10	50	4021343100673	38	21
9221114V#	1 1/4	10	50	4021343187865	45	28
922112V#	1 1/2		25	4021343185861	50	31
92212VB#	2		15	4021343187889	58	34

* nur noch aus Lagervorrat lieferbar.



Katalog-Nr. und -bezeichnung

240# – Reduziermuffe, beidseitig mit Innengewinde, schwarz oder verzinkt

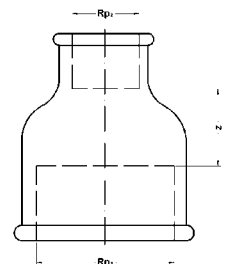

Artikel-Nr.	Abmessung Rp1 x Rp2	Beutel	Karton	EAN-Code-Nr.	a	z
92403814S#	3/8 x 1/4	10	500	4021343102073	30	10
92401214S#	1/2 x 1/4	10	300	4021343185878	36	13
92401238S#	1/2 x 3/8	10	300	4021343101489	36	13
92403438S#	3/4 x 3/8	10	160	4021343185939	39	14
92403412S#	3/4 x 1/2	10	150	4021343101991	39	11
9240138S#	1 x 3/8	10	120	4021343187896	45	18
9240112S#	1 x 1/2	10	120	4021343101144	45	15
9240134S#	1 x 3/4	10	100	4021343101533	45	13
924011412S#	1 1/4 x 1/2	10	90	4021343101380	50	18
924011434S#	1 1/4 x 3/4		90	4021343101427	48	16
92401141S#	1 1/4 x 1		80	4021343101342	50	14
924011234S#	1 1/2 x 3/4		60	4021343101304	55	21
92401121S#	1 1/2 x 1		50	4021343101182	55	19
9240112114S#	1 1/2 x 1 1/4		50	4021343101229	55	17
9240234S#	2 x 3/4		42	4021343101854	65	26
924021S#	2 x 1		42	4021343101618	65	24
92402114S#	2 x 1 1/4		30	4021343101694	65	22
92402112S#	2 x 1 1/2		30	4021343101656	65	22

Katalog-Nr. und -bezeichnung

240# – Reduziermuffe, beidseitig mit Innengewinde, schwarz oder verzinkt (Fortsetzung)

Artikel-Nr.	Abmessung Rp1 x Rp2	Beutel	Karton	EAN-Code-Nr.	a	z
92402121S#*	2 1/2 x 1		20	4021343187919	74	30
92402122S#	2 1/2 x 2		18	4021343101816	74	23
92403112S#*	3 x 1 1/2		18	4021343187933	75	32
924032S#*	3 x 2		18	4021343101915	80	26
92403212S#*	3 x 2 1/2		12	4021343101953	80	23
924042S#*	4 x 2		6	4021343187988	88	42
92404212S#*	4 x 2 1/2		6	4021343187964	94	31
924043S#*	4 x 3		6	4021343102172	94	28
verzinkt						
92403818V#	3/8 x 1/8	10	500	4021343189531	33	17
92403814V#	3/8 x 1/4	10	500	4021343102097	30	10
92401214V#	1/2 x 1/4	10	300	4021343185885	36	13
92401238V#	1/2 x 3/8	10	300	4021343101502	36	13
92403414V#	3/4 x 1/4	10	180	4021343187957	39	21
92403438V#	3/4 x 3/8	10	160	4021343185946	39	14
92403412V#	3/4 x 1/2	10	150	4021343102011	39	11
9240138V#	1 x 3/8	10	120	4021343187902	45	18
9240112V#	1 x 1/2	10	120	4021343101168	45	15
9240134V#	1 x 3/4	10	100	4021343101557	45	13
924011412V#	1 1/4 x 1/2	10	90	4021343101403	50	18
924011434V#	1 1/4 x 3/4		90	4021343101441	48	16
92401141V#	1 1/4 x 1		80	4021343101366	50	14
924011212V#	1 1/2 x 1/2		60	4021343101281	55	23
924011234V#	1 1/2 x 3/4		60	4021343101328	55	21
92401121V#	1 1/2 x 1		50	4021343101205	55	19
9240112114V#	1 1/2 x 1 1/4		50	4021343101243	55	17
9240212V#	2 x 1/2		50	4021343185908	65	28
9240234V#	2 x 3/4		42	4021343101878	65	26
924021V#	2 x 1		42	4021343101632	65	24
92402114V#	2 x 1 1/4		30	4021343101717	65	22
92402112V#	2 x 1 1/2		30	4021343101670	65	22
9240212114V#*	2 1/2 x 1 1/4		30	4021343186141	74	28
9240212112V#	2 1/2 x 1 1/2		30	4021343185922	67	31
92402122V#	2 1/2 x 2		18	4021343101830	74	23
92403112V#	3 x 1 1/2		18	4021343187940	75	32
924032V#	3 x 2		18	4021343101939	80	26
92403212V#	3 x 2 1/2		12	4021343101977	80	23
924042V#	4 x 2		6	4021343185953	88	42
92404212V#*	4 x 2 1/2		6	4021343187971	94	31
924043V#	4 x 3		6	4021343102196	94	28

* nur noch aus Lagervorrat lieferbar.



Katalog-Nr. und -bezeichnung

241# – Reduziernippel, mit Außen- und Innengewinde, schwarz oder verzinkt

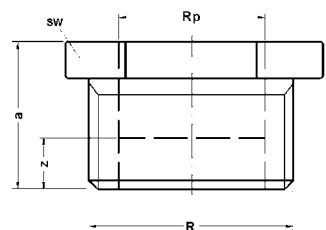

Artikel-Nr.	Abmessung R x Rp	Beutel	Karton	EAN-Code-Nr.	a	z	SW
schwarz							
92411418S#	1/4 x 1/8	10	1000	4021343102936	20	13	18
92413818S#	3/8 x 1/8	10	1000	4021343103728	20	13	20

Katalog-Nr. und -bezeichnung

241# – Reduziernippel, mit Außen- und Innengewinde, schwarz oder verzinkt (Fortsetzung)

Artikel-Nr.	Abmessung R x Rp	Beutel	Karton	EAN-Code-Nr.	a	z	SW
92413814S#	3/8 x 1/4	10	1000	4021343103681	20	10	20
92411218S#	1/2 x 1/8	10	500	4021343102769	24	17	24
92411214S#	1/2 x 1/4	10	500	4021343102721	24	14	28
92411238S#	1/2 x 3/8	10	500	4021343102813	24	14	28
92413414S#	3/4 x 1/4	10	320	4021343103605	26	16	33
92413438S#	3/4 x 3/8	10	320	4021343103643	26	16	33
92413412S#	3/4 x 1/2	10	320	4021343103568	26	13	33
9241138S#	1 x 3/8	10	200	4021343102899	29	19	36
9241112S#	1 x 1/2	10	200	4021343102271	29	16	42
9241134S#	1 x 3/4	10	200	4021343102851	29	14	42
924111438S#	1 1/4 x 3/8		200	4021343102684	31	21	47
924111412S#	1 1/4 x 1/2		140	4021343102608	31	18	47
924111434S#	1 1/4 x 3/4		140	4021343102646	31	16	47
92411141S#	1 1/4 x 1		140	4021343102561	31	14	47
924111238S#*	1 1/2 x 3/8		120	4021343102479	31	23	50
924111212S#	1 1/2 x 1/2		110	4021343102394	31	18	52
924111234S#	1 1/2 x 3/4		110	4021343102431	31	16	52
92411121S#	1 1/2 x 1		110	4021343102318	31	14	52
9241112114S#	1 1/2 x 1 1/4		110	4021343102356	31	12	52
9241238S#*	2 x 3/8		40	4021343189548	35	11	65
9241212S#	2 x 1/2		50	4021343103094	35	35	65
9241234S#	2 x 3/4		50	4021343103315	35	33	65
924121S#	2 x 1		60	4021343102974	35	18	67
92412114S#	2 x 1 1/4		60	4021343103056	35	16	67
92412112S#	2 x 1 1/2		60	4021343103018	35	16	67
92412121S#	2 1/2 x 1		30	4021343103131	40	37	82
9241212114S#	2 1/2 x 1 1/4		30	4021343103216	40	35	82
9241212112S#	2 1/2 x 1 1/2		30	4021343103179	40	21	82
92412122S#	2 1/2 x 2		30	4021343103254	40	16	82
92413112S#*	3 x 1 1/2		20	4021343103391	44	40	97
924132S#	3 x 2		24	4021343103476	44	20	97
92413212S#	3 x 2 1/2		24	4021343103513	44	17	97
924142S#	4 x 2		9	4021343158056	51	45	122
92414212S#*	4 x 2 1/2		10	4021343103780	52	44	122
verzinkt							
92411418V#	1/4 x 1/8	10	1000	4021343102950	20	13	18
92413818V#	3/8 x 1/8	10	1000	4021343103742	20	13	20
92413814V#	3/8 x 1/4	10	1000	4021343103704	20	10	20
92411218V#	1/2 x 1/8	10	500	4021343102783	24	17	24
92411214V#	1/2 x 1/4	10	500	4021343102745	24	14	28
92411238V#	1/2 x 3/8	10	500	4021343102837	24	14	28
92413414V#	3/4 x 1/4	10	320	4021343103629	26	16	33
92413438V#	3/4 x 3/8	10	320	4021343103667	26	16	33
92413412V#	3/4 x 1/2	10	320	4021343103582	26	13	33
9241114V#	1 x 1/4	10	200	4021343102530	29	19	37
9241138V#	1 x 3/8	10	200	4021343102912	29	19	36
9241112V#	1 x 1/2	10	200	4021343102295	29	16	42
9241134V#	1 x 3/4	10	200	4021343102875	29	14	42
924111438V#	1 1/4 x 3/8		200	4021343102707	31	21	47
924111412V#	1 1/4 x 1/2		140	4021343102622	31	18	47
924111434V#	1 1/4 x 3/4		140	4021343102660	31	16	47
92411141V#	1 1/4 x 1		140	4021343102585	31	14	47
924111238V#	1 1/2 x 3/8		120	4021343102493	31	23	50
924111212V#	1 1/2 x 1/2		110	4021343102417	31	18	52
924111234V#	1 1/2 x 3/4		110	4021343102455	31	16	52
92411121V#	1 1/2 x 1		110	4021343102332	31	14	52
9241112114V#	1 1/2 x 1 1/4		110	4021343102370	31	12	52
9241238V#	2 x 3/8		40	4021343189555	35	37	65
9241212V#	2 x 1/2		50	4021343103117	35	35	65
9241234V#	2 x 3/4		50	4021343103339	35	33	65
924121V#	2 x 1		60	4021343102998	35	18	67
92412114V#	2 x 1 1/4		60	4021343103070	35	16	67
92412112V#	2 x 1 1/2		60	4021343103032	35	16	67
924121234V#	2 1/2 x 3/4		30	4021343185977	40	40	82
92412121V#	2 1/2 x 1		30	4021343103155	40	37	82
9241212114V#	2 1/2 x 1 1/4		30	4021343103230	40	35	82

Katalog-Nr. und -bezeichnung

241# – Reduziernippel, mit Außen- und Innengewinde, schwarz oder verzinkt (Fortsetzung)

Artikel-Nr.	Abmessung R x Rp	Beutel	Karton	EAN-Code-Nr.	a	z	SW
9241212112V#	21/2 x 11/2		30	4021343103193	40	21	82
924121222V#	21/2 x 2		30	4021343103278	40	16	82
924131V#	3 x 1		20	4021343185984	48	46	97
92413114V#	3 x 11/4		20	4021343103452	44	40	97
92413112V#	3 x 11/2		20	4021343103414	44	40	97
924132V#	3 x 2		24	4021343103490	44	20	97
92413212V#	3 x 21/2		24	4021343103537	44	17	97
92414112V#	4 x 11/2		9	4021343164682	54	49	122
924142V#	4 x 2		9	4021343158063	51	45	122
92414212V#	4 x 21/2		10	4021343103803	52	44	122
924143V#	4 x 3		12	4021343103841	53	24	122
924154V#	5 x 4		6	4021343166303	58	31	148
924164V#*	6 x 4		4	4021343166327	64	24	170

* nur noch aus Lagervorrat lieferbar

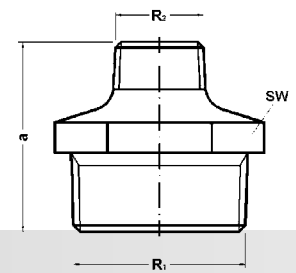

Katalog-Nr. und -bezeichnung

245# – Reduzier-Doppelnippel, beidseitig mit Außengewinde, schwarz oder verzinkt

Artikel-Nr.	Abmessung R1 x R2	Beutel	Karton	EAN-Code-Nr.	a	SW
schwarz						
92451418S#*	1/4 x 1/8	10	800	4021343188008	40	18
92453814S#	3/8 x 1/4	10	700	4021343104688	38	20
92451214S#	1/2 x 1/4	10	400	4021343104169	44	24
92451238S#	1/2 x 3/8	10	400	4021343104206	44	24
92453438S#*	3/4 x 3/8	10	220	4021343104640	47	31
92453412S#	3/4 x 1/2	10	200	4021343104602	47	31
9245112S#	1 x 1/2	10	150	4021343103889	53	37
9245134S#	1 x 3/4	10	140	4021343104244	53	37
924511412S#*	11/4 x 1/2		100	4021343104084	57	47
924511434S#	11/4 x 3/4		100	4021343104121	57	47
92451141S#	11/4 x 1		85	4021343104046	57	47
924511234S#	11/2 x 3/4		60	4021343104008	59	51
92451121S#	11/2 x 1		60	4021343103926	59	51
9245112114S#	11/2 x 11/4		60	4021343103964	59	51
924521S#	2 x 1		45	4021343104329	68	65
92452114S#	2 x 11/4		45	4021343104404	68	66
92452112S#	2 x 11/2		48	4021343104367	68	66
9245212112S#*	21/2 x 11/2		25	4021343104442	77	81
92452122S#	21/2 x 2		25	4021343104480	75	81
924532S#*	3 x 2		20	4021343104527	86	95
verzinkt						
92451418V#	1/4 x 1/8	10	800	4021343185991	40	18
92453814V#	3/8 x 1/4	10	700	4021343104701	38	20
92451214V#	1/2 x 1/4	10	400	4021343104183	44	24
92451238V#	1/2 x 3/8	10	400	4021343104220	44	24
92453438V#	3/4 x 3/8	10	220	4021343104664	47	31
92453412V#	3/4 x 1/2	10	200	4021343104626	47	31
9245112V#	1 x 1/2	10	150	4021343103902	53	37
9245134V#	1 x 3/4	10	140	4021343104268	53	37

Katalog-Nr. und -bezeichnung

245# – Reduzier-Doppelnippel, beidseitig mit Außengewinde, schwarz oder verzinkt (Fortsetzung)

Artikel-Nr.	Abmessung R1 x R2	Beutel	Karton	EAN-Code-Nr.	a	SW
924511412V#	1 1/4 x 1/2	100	4021343104107	57	47	
924511434V#	1 1/4 x 3/4	100	4021343104145	57	47	
92451141V#	1 1/4 x 1	85	4021343104060	57	47	
924511234V#	1 1/2 x 3/4	60	4021343104022	59	51	
92451121V#	1 1/2 x 1	60	4021343103940	59	51	
9245112114V#	1 1/2 x 1 1/4	60	4021343103988	59	51	
924521V#	2 x 1	45	4021343104343	68	65	
92452114V#	2 x 1 1/4	45	4021343104428	68	66	
92452112V#	2 x 1 1/2	48	4021343104381	68	66	
9245212112V#	2 1/2 x 1 1/2	25	4021343104466	77	81	
92452122V#	2 1/2 x 2	25	4021343104503	75	81	
924532V#	3 x 2	20	4021343104541	86	95	
92453212V#	3 x 2 1/2	16	4021343104589	86	95	
92454212V#	4 x 2 1/2	7	4021343164705	97	121	
924543V#	4 x 3	7	4021343164699	98	121	

* nur noch aus Lagervorrat lieferbar.

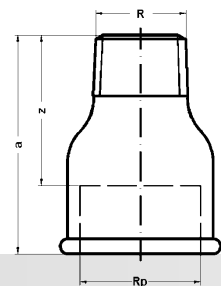

Katalog-Nr. und -bezeichnung

246# – Reduziermuffennippel, mit Außen- und Innengewinde, schwarz oder verzinkt

Artikel-Nr.	Abmessung Rp x R	Beutel	Karton	EAN-Code-Nr.	a	z
schwarz						
92463814S#	3/8 x 1/4	10	400	4021343188084	35	25
92461214S#	1/2 x 1/4	10	350	4021343188022	43	30
92461238S#	1/2 x 3/8	10	320	4021343104992	43	30
92463412S#	3/4 x 1/2	10	200	4021343105296	48	33
9246138S#*	1 x 3/8	10	150	4021343188046	55	38
9246112S#	1 x 1/2	10	130	4021343104725	55	38
9246134S#	1 x 3/4	10	110	4021343105036	55	38
924611412S#*	1 1/4 x 1/2	60	4021343186011	60	41	
924611434S#	1 1/4 x 3/4	60	4021343104930	60	41	
92461141S#	1 1/4 x 1	70	4021343104879	60	41	
924611234S#*	1 1/2 x 3/4	50	4021343188015	63	44	
92461121S#	1 1/2 x 1	60	4021343104763	63	44	
9246112114S#	1 1/2 x 1 1/4	50	4021343104800	63	44	
9246234S#*	2 x 3/4	40	4021343188060	70	46	
924621S#*	2 x 1	42	4021343105173	70	46	
92462114S#	2 x 1 1/4	42	4021343105173	70	46	
92462112S#	2 x 1 1/2	42	4021343105135	70	46	
92462122S#	2 1/2 x 2	24	4021343158070	80	43	
924632S#	3 x 2	15	4021343158094	89	59	
92463212S#	3 x 2 1/2	15	4021343168147	89	59	
verzinkt						
92461418V#	1/4 x 1/8	10	800	4021343189579	28	18
92463814V#	3/8 x 1/4	10	400	4021343186059	35	25
92461214V#	1/2 x 1/4	10	350	4021343188039	43	30
92461238V#	1/2 x 3/8	10	320	4021343105012	43	30
92463438V#	3/4 x 3/8	10	100	4021343105340	48	33
92463412V#	3/4 x 1/2	10	200	4021343105319	48	33

Katalog-Nr. und -bezeichnung

246# – Reduziermuffenrippl, mit Außen- und Innengewinde, schwarz oder verzinkt (Fortsetzung)

Artikel-Nr.	Abmessung Rp x R	Beutel	Karton	EAN-Code-Nr.	a	z
9246112V#	1 x 1/2	10	130	4021343104749	55	38
9246134V#	1 x 3/4	10	110	4021343105050	55	38
924611412V#	1 1/4 x 1/2		60	4021343186028	60	41
924611434V#	1 1/4 x 3/4		60	4021343104954	60	41
92461141V#	1 1/4 x 1		70	4021343104893	60	41
924611234V#	1 1/2 x 3/4		50	4021343186004	63	44
92461121V#	1 1/2 x 1		60	4021343104787	63	44
9246112114V#	1 1/2 x 1 1/4		50	4021343104824	63	44
9246234V#	2 x 3/4		42	4021343188077	70	46
924621V#	2 x 1		42	4021343186042	70	46
92462114V#	2 x 1 1/4		42	4021343105197	70	46
92462112V#	2 x 1 1/2		42	4021343105159	70	46
92462122V#	2 1/2 x 2		24	4021343158087	80	43
924632V#	3 x 2		15	4021343158100	89	59
92463212V#	3 x 2 1/2		15	4021343158117	89	59

* nur noch aus Lagervorrat lieferbar.

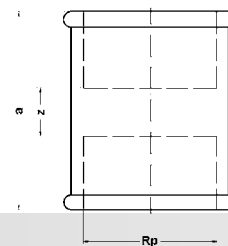

Katalog-Nr. und -bezeichnung

270# – Muffe, beidseitig mit Innengewinde, schwarz oder verzinkt

Artikel-Nr.	Abmessung Rp	Beutel	Karton	EAN-Code-Nr.	a	z
schwarz						
927018S#	1/8	10	700	4021343105678	25	11
927014S#	1/4	10	500	4021343105630	27	7
927038S#	3/8	10	300	4021343105876	30	10
927012S#	1/2	10	250	4021343105593	36	10
927034S#	3/4	10	150	4021343105838	39	9
92701S#	1	10	90	4021343105449	45	11
9270114S#	1 1/4		70	4021343105548	50	12
9270112S#	1 1/2		50	4021343105494	55	17
92702S#	2		24	4021343105715	65	17
9270212S#	2 1/2		18	4021343105753	74	20
92703S#	3		12	4021343105791	80	20
verzinkt						
927018V#	1/8	10	700	4021343105692	25	11
927014V#	1/4	10	500	4021343105654	27	7
927038V#	3/8	10	300	4021343105890	30	10
927012V#	1/2	10	250	4021343105616	36	10
927034V#	3/4	10	150	4021343105852	39	9
92701V#	1	10	90	4021343105463	45	11
9270114V#	1 1/4		70	4021343105562	50	12
9270112V#	1 1/2		50	4021343105517	55	17
92702V#	2		24	4021343105739	65	17
9270212V#	2 1/2		18	4021343105777	74	20
92703V#	3		12	4021343105814	80	20
92704V#	4		5	4021343105937	94	22
92705V#	5		3	4021343194535	112	32

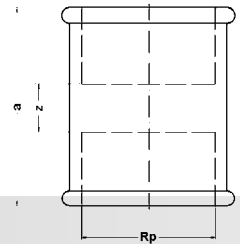

Katalog-Nr. und -bezeichnung

271# – Muffe, mit Rechts- und Linksinnengewinde, schwarz oder verzinkt

Artikel-Nr.	Abmessung Rp	Beutel	Karton	EAN-Code-Nr.	a	z
schwarz						
927138S#*	3/8	10	300	4021343168215	30	10
927112S#*	1/2	10	250	4021343168185	36	10
9271112S#*	1 1/2	10	50	4021343158155	55	17
92712S#*	2	24	24	4021343158179	65	17
9271212S#*	2 1/2	18	18	4021343158193	74	20
verzinkt						
927138V#	3/8	10	300	4021343158124	30	10
927112V#	1/2	10	250	4021343168192	36	10
927134V#	3/4	10	150	4021343168208	39	9
927111V#	1	10	90	4021343168154	45	11
9271114V#	1 1/4	70	70	4021343168178	50	12
9271112V#	1 1/2	50	50	4021343158162	55	17
92712V#	2	24	24	4021343158186	65	17

* nur noch aus Lagervorrat lieferbar.

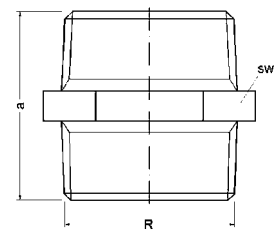

Katalog-Nr. und -bezeichnung

280# – Doppelnippel, beidseitig mit Außengewinde, schwarz oder verzinkt

Artikel-Nr.	Abmessung R	Beutel	Karton	EAN-Code-Nr.	a	SW
schwarz						
928018S#	1/8	10	1200	4021343106392	29	17
928014S#	1/4	10	800	4021343106354	36	19
928038S#	3/8	10	500	4021343106590	38	22
928012S#	1/2	10	350	4021343106316	44	27
928034S#	3/4	10	200	4021343106552	47	32
92801S#	1	10	100	4021343106187	53	41
9280114S#	1 1/4	70	70	4021343106262	57	50
9280112S#	1 1/2	50	50	4021343106224	59	55
92802S#	2	30	30	4021343106439	68	70
9280212S#	2 1/2	20	20	4021343106477	75	85
92803S#	3	12	12	4021343106514	83	100
92804S#	4	5	5	4021343106637	95	130

Katalog-Nr. und -bezeichnung

280# – Doppelnippel, beidseitig mit Außengewinde, schwarz oder verzinkt (Fortsetzung)

Artikel-Nr.	Abmessung R	Beutel	Karton	EAN-Code-Nr.	a	SW
verzinkt						
928018V#	1/8	10	1200	4021343106415	29	17
928014V#	1/4	10	800	4021343106378	36	19
928038V#	3/8	10	500	4021343106613	38	22
928012V#	1/2	10	350	4021343106330	44	27
928034V#	3/4	10	200	4021343106576	47	32
92801V#	1	10	100	4021343106200	53	41
9280114V#	1 1/4		70	4021343106286	57	50
9280112V#	1 1/2		50	4021343106248	59	55
92802V#	2		30	4021343106453	68	70
9280212V#	2 1/2		20	4021343106491	75	85
92803V#	3		12	4021343106538	83	100
92804V#	4		5	4021343106651	95	130
92805V#	5		4	4021343158223	106	146
92806V#	6		2	4021343158230	117	170

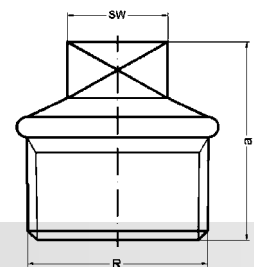

Katalog-Nr. und -bezeichnung

290# – Stopfen mit Rand, mit Außengewinde, schwarz oder verzinkt

Artikel-Nr.	Abmessung R	Beutel	Karton	EAN-Code-Nr.	a	SW
schwarz						
929018S#	1/8	10	1000	4021343106965	20	8
929014S#	1/4	10	500	4021343106927	22	10
929038S#	3/8	10	800	4021343107160	24	10
929012S#	1/2	10	450	4021343106880	30	12
929034S#	3/4	10	300	4021343107122	32	17
92901S#	1	10	180	4021343106767	36	19
9290114S#	1 1/4		140	4021343106842	39	22
9290112S#	1 1/2		100	4021343106804	41	22
92902S#	2		60	4021343107009	48	27
9290212S#	2 1/2		35	4021343107047	54	32
92903S#	3		20	4021343107085	60	36
92904S#	4		14	4021343107207	70	41
verzinkt						
929018V#	1/8	10	1000	4021343106989	20	8
929014V#	1/4	10	500	4021343106941	22	10
929038V#	3/8	10	800	4021343107184	24	10
929012V#	1/2	10	450	4021343106903	30	12
929034V#	3/4	10	300	4021343107146	32	17
92901V#	1	10	180	4021343106781	36	19
9290114V#	1 1/4		140	4021343106866	39	22
9290112V#	1 1/2		100	4021343106828	41	22
92902V#	2		60	4021343107023	48	27
9290212V#	2 1/2		35	4021343107061	54	32
92903V#	3		20	4021343107108	60	36
92904V#	4		14	4021343107221	70	41

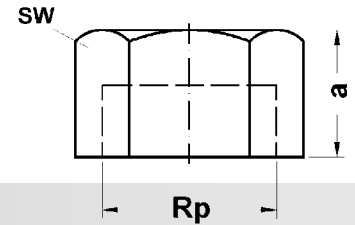

Katalog-Nr. und -bezeichnung

300# – Kappe, 6-kant, mit Innengewinde, schwarz oder verzinkt

Artikel-Nr.	Abmessung Rp	Beutel	Karton	EAN-Code-Nr.	a	SW
schwarz						
930014S#	1/4	10	600	4021343186066	15	19
930038S#	3/8	10	700	4021343107627	18	22
930012S#	1/2	10	400	4021343107405	22	27
930034S#	3/4	10	250	4021343107580	26	32
93001S#	1	10	150	4021343107283	31	40
9300114S#	11/4		120	4021343107368	33	51
9300112S#	11/2		90	4021343107320	3	56
93002S#	2		50	4021343107467	38	71
9300212S#	21/2		30	4021343107504	43	86
93003S#	3		25	4021343107542	46	101
93004S#	4		4	4021343107665	52	131
verzinkt						
930014V#	1/4	10	600	4021343186073	15	19
930038V#	3/8	10	700	4021343107641	18	22
930012V#	1/2	10	400	4021343107429	22	27
930034V#	3/4	10	250	4021343107603	26	32
93001V#	1	10	150	4021343107306	31	40
9300114V#	11/4		120	4021343107382	33	51
9300112V#	11/2		90	4021343107344	33	56
93002V#	2		50	4021343107481	38	71
9300212V#	21/2		30	4021343107528	43	86
93003V#	3		25	4021343107566	46	101
93004V#	4		4	4021343107689	52	131

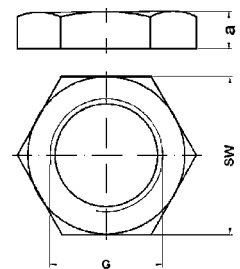

Katalog-Nr. und -bezeichnung

310# – Gegenmutter, schwarz oder verzinkt

Artikel-Nr.	Abmessung G	Beutel	Karton	EAN-Code-Nr.	a	SW
schwarz						
931038S#*	3/8	10	1000	4021343158247	7	27
931012S#	1/2	10	600	4021343158261	8	32
931034S#	3/4	10	400	4021343158285	9	36
93101S#	1	10	250	4021343163005	10	46
9310114S#	11/4		200	4021343158308	11	55
9310112S#	11/2		200	4021343132117	12	60
93102S#	2		60	4021343132179	13	75
9310212S#	21/2		40	4021343158322	16	95

* nur noch aus Lagervorrat lieferbar.

Katalog-Nr. und -bezeichnung

310# – Gegenmutter, schwarz oder verzinkt (Fortsetzung)

Artikel-Nr.	Abmessung G	Beutel	Karton	EAN-Code-Nr.	a	SW
93103S#	3		35	4021343188091	19	105
verzinkt						
931038V#	3/8	10	1000	4021343158254	7	27
931012V#	1/2	10	600	4021343158278	8	32
931034V#	3/4	10	400	4021343158292	9	36
93101V#	1	10	250	4021343132100	10	46
9310114V#	1 1/4		200	4021343158315	11	55
9310112V#	1 1/2		200	4021343132124	12	60
93102V#	2		60	4021343132186	13	75
9310212V#	2 1/2		50	4021343158339	16	95
93103V#	3		35	4021343188107	19	105



Katalog-Nr. und -bezeichnung

330# – Verschraubung, beidseitig mit Innengewinde, flachdichtend, schwarz oder verzinkt

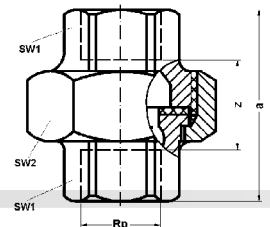

Artikel-Nr.	Abmessung Rp	Beutel	Karton	EAN-Code-Nr.	a	z	SW1	SW2
schwarz								
933012S#	1/2	10	100	4021343108419	48	35	26	45
933034S#	3/4	10	80	4021343108594	52	37	32	50
93301S#	1	10	50	4021343108297	58	41	38	55
9330114S#	1 1/4		30	4021343108372	65	46	47	70
9330112S#	1 1/2		25	4021343108334	70	51	53	75
93302S#	2		14	4021343108471	78	54	65	90
93303S#*	3		5	4021343108556	95	65	95	125
verzinkt								
933038V#	3/8	10	200	4021343108655	45	35	22	36
933012V#	1/2	10	100	4021343108433	48	35	26	45
933034V#	3/4	10	80	4021343108617	52	37	32	50
93301V#	1	10	50	4021343108310	58	41	38	55
9330114V#	1 1/4		30	4021343108396	65	46	47	70
9330112V#	1 1/2		25	4021343108358	70	51	53	75
93302V#	2		14	4021343108495	78	54	65	90
9330212V#	2 1/2		10	4021343108532	85	58	83	110
93303V#	3		5	4021343108570	95	65	95	125
93304V#	4		4	4021343108693	110	74	123	165

* nur noch aus Lagervorrat lieferbar



Katalog-Nr. und -bezeichnung

331# – Verschraubung, mit Innen- und Außengewinde, flachdichtend, schwarz oder verzinkt

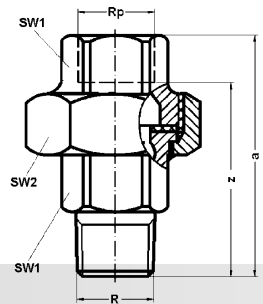

Artikel-Nr.	Abmessung R x Rp	Beutel	Karton	EAN-Code-Nr.	a	z	SW1	SW2
schwarz								
933138S#	3/8	10	180	4021343109072	58	48	22	36
933112S#	1/2	10	120	4021343108839	66	53	26	45
933134S#	3/4	10	60	4021343109034	72	57	32	50
93311S#	1	10	40	4021343108716	80	63	38	55
9331114S#	1 1/4		25	4021343108792	90	71	47	70
9331112S#	1 1/2		20	4021343108754	95	76	53	75
93312S#	2		12	4021343108914	106	82	65	90
9331212S#	2 1/2		7	4021343108952	118	91	83	110
93313S#	3		4	4021343108990	130	100	95	125
93314S#*	4		2	4021343109119	145	109	123	165
verzinkt								
933138V#	3/8	10	180	4021343109096	58	48	22	36
933112V#	1/2	10	120	4021343108853	66	53	26	45
933134V#	3/4	10	60	4021343109058	72	57	32	50
93311V#	1	10	40	4021343108730	80	63	38	55
9331114V#	1 1/4		25	4021343108815	90	71	47	70
9331112V#	1 1/2		20	4021343108778	95	76	53	75
93312V#	2		12	4021343108938	106	82	65	90
9331212V#	2 1/2		7	4021343108976	118	91	83	110
93313V#	3		4	4021343109010	130	100	95	125
93314V#	4		2	4021343109133	145	109	123	165

* nur noch aus Lagervorrat lieferbar.



Katalog-Nr. und -bezeichnung

340# – Verschraubung, beidseitig mit Innengewinde, konisch dichtend, schwarz oder verzinkt

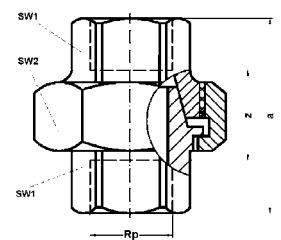

Artikel-Nr.	Abmessung Rp	Beutel	Karton	EAN-Code-Nr.	a	z	SW1	SW2
schwarz								
934014S#*	1/4	10	250	4021343188190	142	32	18	32
934038S#	3/8	10	200	4021343109591	45	35	22	36
934012S#	1/2	10	120	4021343109355	48	35	26	45
934034S#	3/4	10	60	4021343109553	52	37	32	50
93401S#	1	10	50	4021343109232	58	41	38	55
9340114S#	1 1/4		30	4021343109317	65	46	47	70
9340112S#	1 1/2		25	4021343109270	70	51	53	75
93402S#	2		14	4021343109430	78	54	65	90
9340212S#	2 1/2		12	4021343109478	85	58	83	110
93403S#	3		5	4021343109515	95	65	95	125

* nur noch aus Lagervorrat lieferbar.

Katalog-Nr. und -bezeichnung

340# – Verschraubung, beidseitig mit Innengewinde, konisch dichtend, schwarz oder verzinkt (Fortsetzung)

Artikel-Nr.	Abmessung Rp	Beutel	Karton	EAN-Code-Nr.	a	z	SW1	SW2
verzinkt								
934014V#	1/4	10	250	4021343188206	42	32	18	32
934038V#	3/8	10	200	4021343109614	45	35	22	36
934012V#	1/2	10	100	4021343109379	48	35	26	45
934034V#	3/4	10	60	4021343109577	52	37	32	50
93401V#	1	10	50	4021343109256	58	41	38	55
9340114V#	1 1/4		30	4021343109331	65	46	47	70
9340112V#	1 1/2		25	4021343109294	70	51	53	75
93402V#	2		14	4021343109454	78	54	65	90
9340212V#	2 1/2		12	4021343109492	85	58	83	110
93403V#	3		5	4021343109539	95	65	95	125
93404V#	4		4	4021343109652	110	74	123	165

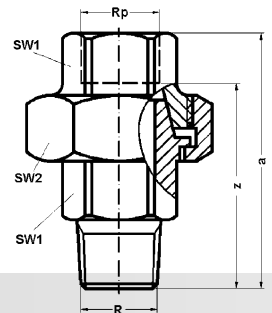

Katalog-Nr. und -bezeichnung

341# – Verschraubung, mit Innen- und Außengewinde, konisch dichtend, schwarz oder verzinkt

Artikel-Nr.	Abmessung R x Rp	Beutel	Karton	EAN-Code-Nr.	a	z	SW1	SW2
schwarz								
934114S#	1/4	10	200	4021343188213	55	45	18	32
934138S#	3/8	10	180	4021343110054	58	48	22	36
934112S#	1/2	10	120	4021343109836	66	53	26	45
934134S#	3/4	10	60	4021343110016	72	57	32	50
93411S#	1	10	40	4021343109713	80	63	38	55
9341114S#	1 1/4		25	4021343109799	90	71	47	70
9341112S#	1 1/2		20	4021343109751	95	76	53	75
93412S#	2		12	4021343109898	106	82	65	90
9341212S#	2 1/2		7	4021343109935	118	91	83	110
93413S#	3		4	4021343109973	130	100	95	125
93414S#*	4		2	4021343110092	145	109	123	165
verzinkt								
934114V#	1/4	10	200	4021343188220	55	45	18	32
934138V#	3/8	10	180	4021343110078	58	48	22	36
934112V#	1/2	10	120	4021343109850	66	53	26	45
934134V#	3/4	10	60	4021343110030	72	57	32	50
93411V#	1	10	40	4021343109737	80	63	38	55
9341114V#	1 1/4		25	4021343109812	90	71	47	70
9341112V#	1 1/2		20	4021343109775	95	76	53	75
93412V#	2		12	4021343109911	106	82	65	90
9341212V#	2 1/2		7	4021343109959	118	91	83	110
93413V#	3		4	4021343109997	130	100	95	125
93414V#	4		2	4021343110115	145	109	123	165

* nur noch aus Lagervorrat lieferbar.

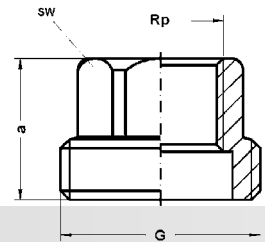

Katalog-Nr. und -bezeichnung

370# – Einschraubteil, mit Innengewinde, flachdichtend, schwarz oder verzinkt

Artikel-Nr.	Abmessung Rp x G	Karton	EAN-Code-Nr.	a	SW
schwarz					
937012118S#	1/2 x 11/8	200	4021343188275	24	26
937034114S#	3/4 x 11/4	200	4021343188329	26	32
93701112S#	1 x 11/2	150	4021343158346	29	38
93701142S#	1 1/4 x 2	100	4021343188251	32	47
9370112214S#	1 1/2 x 2 1/4	80	4021343188244	34	53
93702234S#*	2 x 2 3/4	60	4021343188305	38	65
verzinkt					
937012118V#	1/2 x 11/8	200	4021343188282	24	26
937034114V#	3/4 x 11/4	200	4021343188336	26	32
93701112V#	1 x 11/2	150	4021343158353	29	38
9370112214V#	1 1/2 x 2 1/4	80	4021343186110	34	53

* nur noch aus Lagervorrat lieferbar.

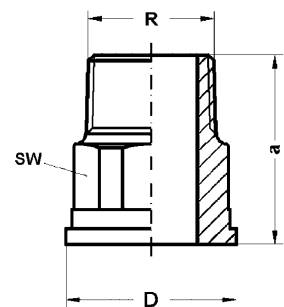

Katalog-Nr. und -bezeichnung

371# – Einlegteil, mit Außengewinde, flachdichtend, schwarz oder verzinkt

Artikel-Nr.	Abmessung R x G _{ü-Mutter}	Karton	EAN-Code-Nr.	a	D	SW
schwarz						
937112118S#	1/2 x 11/8	200	4021343188428	44	35	26
937134114S#	3/4 x 11/4	200	4021343188480	47	39	32
93711112S#	1 x 11/2	130	4021343158360	50	45	38
93711142S#	1 1/4 x 2	70	4021343179590	56	56	48
9371112214S#	1 1/2 x 2 1/4	50	4021343188398	57	62	53
verzinkt						
937134114V#	3/4 x 11/4	200	4021343188497	47	39	32
93711112V#	1 x 11/2	130	4021343158377	50	45	38
93711142V#	1 1/4 x 2	70	4021343188411	56	56	48

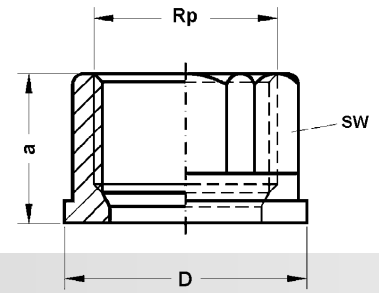

Katalog-Nr. und -bezeichnung

372# – Einlegeteil, mit Innengewinde, flachdichtend, schwarz oder verzinkt

Artikel-Nr.	Abmessung R x G _ü -Mutter	Karton	EAN-Code-Nr.	a	D	SW
schwarz						
937212118S#	1/2 x 11/8	300	4021343188596	26	35	26
937234114S#	3/4 x 11/4	300	4021343172502	28	39	32
93721112S#	1 x 11/2	220	4021343126857	28	44	38
93721142S#	1 1/4 x 2	100	4021343172519	33	56	48
9372112214S#	1 1/2 x 2 1/4	45	4021343188565	34	62	53
93722234S#	2 x 2 3/4	30	4021343188626	39	78	67
937234S#*	3 x 4	20	4021343188640	46	109	98
verzinkt						
937212118V#	1/2 x 11/8	300	4021343188602	26	35	26
937234114V#	3/4 x 11/4	300	4021343186127	28	39	32
93721112V#	1 x 11/2	220	4021343158384	28	44	38
93721142V#	1 1/4 x 2	100	4021343188589	33	56	48
9372112214V#	1 1/2 x 2 1/4	45	4021343188572	34	62	53

* nur noch aus Lagervorrat lieferbar.

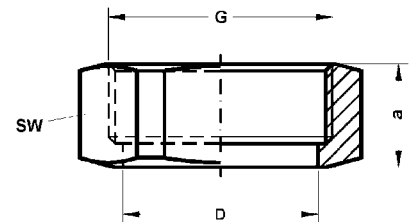

Katalog-Nr. und -bezeichnung

374# – Überwurfmutter, schwarz oder verzinkt

Artikel-Nr.	Abmessung R/Rp x G	Karton	EAN-Code-Nr.	a	D	SW
schwarz						
9374121S#	1/2 x 1	350	4021343188749	18	28	41
937412118S#	1/2 x 1 1/8	300	4021343188725	19	32	45
937434114S#	3/4 x 1 1/4	50	4021343188787	20	36	50
93741112S#	1 x 1 1/2	150	4021343126864	22	42	55
93741142S#	1 1/4 x 2	80	4021343172526	25	53	70
9374112214S#	1 1/2 x 2 1/4	65	4021343188695	26	59	75
verzinkt						
93743878V#	3/8 x 7/8	400	4021343188831	17	25	36
9374121V#	1/2 x 1	350	4021343140990	18	28	41
937412118V#	1/2 x 1 1/8	300	4021343188732	19	32	45
937434114V#	3/4 x 1 1/4	50	4021343188794	20	36	50
93741112V#	1 x 1 1/2	150	4021343156212	22	42	55
93741142V#	1 1/4 x 2	80	4021343188718	25	53	70
9374112214V#	1 1/2 x 2 1/4	65	4021343188701	26	59	75
937434V#	3 x 4	17	4021343188817	31	105	125

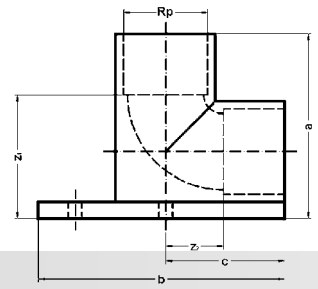

Katalog-Nr. und -bezeichnung

471# – Wandscheibe, beidseitig mit Innengewinde, schwarz oder verzinkt

Artikel-Nr.	Abmessung Rp	Beutel	Karton	EAN-Code-Nr.	a	b	c	z1	z2
schwarz									
947112S#*	1/2	10	80	4021343113574	44	64	28	31	16
verzinkt									
947112V#	1/2	10	80	4021343113598	44	64	28	31	16
947134V#	3/4	10	40	4021343113635	53	78	39	37	21

* nur noch aus Lagervorrat lieferbar.

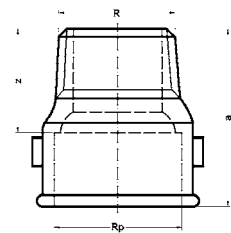

Katalog-Nr. und -bezeichnung

529a# – Verlängerung mit Innen- und Außengewinde, schwarz oder verzinkt

Artikel-Nr.	Abmessung R x Rp	Beutel	Karton	EAN-Code-Nr.	a	z
schwarz						
952938S#	3/8	10	300	4021343113932	35	25
952912S#	1/2	10	300	4021343113796	43	30
952934S#	3/4	10	160	4021343113895	48	33
95291S#	1	10	90	4021343113673	55	38
9529114S#	1 1/4	60	60	4021343113758	60	41
9529112S#*	1 1/2	50	50	4021343113710	63	44
95292S#	2	28	28	4021343113857	70	46
verzinkt						
952938V#	3/8	10	300	4021343113956	35	25
952912V#	1/2	10	300	4021343113819	43	30
952934V#	3/4	10	160	4021343113918	48	33
95291V#	1	10	90	4021343113697	55	38
9529114V#	1 1/4	60	60	4021343113772	60	41
9529112V#	1 1/2	55	55	4021343113734	63	44
95292V#	2	28	28	4021343113871	70	46

* nur noch aus Lagervorrat lieferbar



Katalog-Nr. und -bezeichnung

DTG – Dichtung aus AFM 34, für Verschraubung aus Temperguss, geprüft nach DIN 3535 Teil 6

- hergestellt ohne Asbest
- temperaturbeständig bis maximal 200 °C
- Einsatzbereich: Wasser, Dampf, Alkohole, Glykole, Öle auf Kohlenwasserstoffbasis, brennbare Gase

Artikel-Nr.	Abmessung D x d x s	passend zu	Karton	EAN-Code-Nr.
9DTG14	24 x 17 x 2	Überwurfmutter 1/4	600	4021343093920
9DTG38	27 x 19 x 2	Überwurfmutter 3/8	400	4021343093975
9DTG12	34 x 24 x 2	Überwurfmutter 1/2	400	4021343093913
9DTG34	38 x 27 x 2	Überwurfmutter 3/4	400	4021343093968
9DTG1	44 x 32 x 2	Überwurfmutter 1	400	4021343093883
9DTG114	55 x 42 x 2	Überwurfmutter 1 1/4	240	4021343093906
9DTG112	62 x 45 x 2	Überwurfmutter 1 1/2	200	4021343093890
9DTG2	78 x 60 x 2	Überwurfmutter 2	120	4021343093937
9DTG212	97 x 75 x 2	Überwurfmutter 2 1/2	80	4021343093944
9DTG3	110 x 88 x 2	Überwurfmutter 3	60	4021343093951
9DTG4	148 x 120 x 2	Überwurfmutter 4	40	4021343093982

SANHA[®]

VERBINDUNGSTECHNIK

Rohnippel und Muffen
aus Schmiedeeisen



РОСС DE.АЮ.Н05760

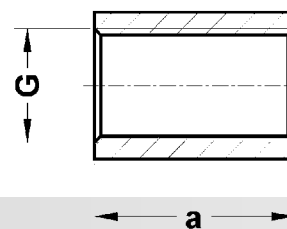

Katalog-Nr. und -bezeichnung

16 – Muffe, geschweißte Ausführung, schwarz oder verzinkt

Artikel-Nr.	Abmessung G	Beutel	Karton	EAN-Code-Nr.	a
schwarz					
11618S	1/8	10	1500	4021343003523	18
11614S	1/4	10	1000	4021343003509	25
11638S	3/8	10	400	4021343003622	26
11612S	1/2	10	150	4021343003486	34
1161260S	1/2 x 60	10	100	4021343140402	60
1161280S	1/2 x 80	10	80	4021343140419	80
11612100S	1/2 x 100	10	50	4021343140426	100
11634S	3/4	10	120	4021343003608	36
1161S	1	10	60	4021343003417	43
116114S	1 1/4		45	4021343003462	47
116112S	1 1/2		35	4021343003431	49
1162S	2		20	4021343003547	52
116212S	2 1/2		12	4021343003561	65
1163S	3		8	4021343003585	72
1164S	4		4	4021343003646	84
verzinkt					
11618V*	1/8	10	1500	4021343003530	18
11614V	1/4	10	1000	4021343003516	25
11638V	3/8	10	400	4021343003639	26
11612V	1/2	10	150	4021343003493	34
11634V	3/4	10	120	4021343003615	36
1161V	1	10	60	4021343003424	43
116114V	1 1/4		45	4021343003479	47
116112V	1 1/2		35	4021343003448	49
1162V	2		20	4021343003554	52
116212V	2 1/2		12	4021343003578	65
1163V	3		8	4021343003592	72
1164V	4		4	4021343003653	84

* nur noch aus Lagervorrat lieferbar.

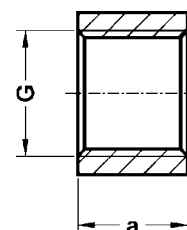

Katalog-Nr. und -bezeichnung

16D – Muffe, geschweißte Ausführung, halbe Länge, schwarz

Artikel-Nr.	Abmessung G	Karton	EAN-Code-Nr.	a
116D14S	1/4	2000	4021343003240	13
116D38S	3/8	1000	4021343003363	13
116D12S	1/2	500	4021343003226	17

Katalog-Nr. und -bezeichnung

16D – Muffe, geschweißte Ausführung, halbe Länge, schwarz (Fortsetzung)

Artikel-Nr.	Abmessung G	Karton	EAN-Code-Nr.	a
116D34S	3/4	300	4021343003349	18
116D1S	1	150	4021343003165	22
116D114S	1 1/4	100	4021343003202	24
116D112S	1 1/2	80	4021343003189	25
116D2S	2	40	4021343003288	26
116D212S	2 1/2	25	4021343003301	33
116D3S	3	16	4021343003325	36

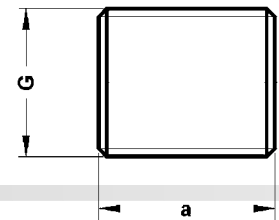

Katalog-Nr. und -bezeichnung

22 – Rohrnickel aus Rohr nach DIN EN 10255, schwarz oder verzinkt

Artikel-Nr.	Abmessung G	Karton	EAN-Code-Nr.	a
schwarz				
12218S*	1/8	1000	402134300376	11
12212S*	1/2	350	4021343003738	25
12234S*	3/4	140	4021343003851	30
1221S*	1	120	4021343003677	37
122114S*	1 1/4	80	4021343003714	37
122112S*	1 1/2	60	4021343003691	38
1222S*	2	36	4021343003790	48
1223S*	3	12	4021343003837	59
1224S*	4	5	4021343003899	69
verzinkt				
12218V*	1/8	1000	4021343003783	11
12214V*	1/4	750	4021343003752	18
12238V*	3/8	500	4021343003875	22
12212V*	1/2	350	4021343003745	25
122114V*	1 1/4	80	4021343003721	37
122112V*	1 1/2	60	4021343003707	38
1222V*	2	36	4021343003790	48
1224V*	4	5	4021343003899	69

* nur noch aus Lagervorrat lieferbar

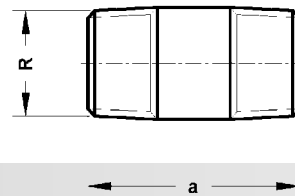

Katalog-Nr. und -bezeichnung

23 – Rohrdoppelnippel, schwarz oder verzinkt

Artikel-Nr.	Abmessung R	Beutel	Karton	EAN-Code-Nr.	a
schwarz					
1231440S	1/4 x 40	10	500	4021343005954	40
1231460S	1/4 x 60	10	400	4021343005992	60
1231480S	1/4 x 80	10	200	4021343006036	80
12314100S	1/4 x 100	10	150	4021343005671	100
12314120S	1/4 x 120	10	120	4021343005718	120
12314150S	1/4 x 150	10	120	4021343005770	150
12314200S	1/4 x 200	10	120	4021343005879	200
1233840S	3/8 x 40	10	200	4021343008573	40
1233860S	3/8 x 60	10	250	4021343008610	60
1233880S	3/8 x 80	10	150	4021343008658	80
12338100S	3/8 x 100	10	100	4021343008290	100
12338120S	3/8 x 120	10	100	4021343008337	120
12338150S	3/8 x 150	10	80	4021343008399	150
12338180S	3/8 x 180	10	80	4021343008450	180
12338200S	3/8 x 200	10	80	4021343008498	200
12338250S	3/8 x 250	10	80	4021343008511	250
12338300S	3/8 x 300	10	100	4021343008559	300
1231240S	1/2 x 40	10	200	4021343005404	40
1231260S	1/2 x 60	10	160	4021343005503	60
1231280S	1/2 x 80	10	150	4021343005558	80
12312100S	1/2 x 100	10	100	4021343005077	100
12312120S	1/2 x 120	10	90	4021343005121	120
12312150S	1/2 x 150	10	60	4021343005190	150
12312180S	1/2 x 180	10	60	4021343005268	180
12312200S	1/2 x 200	10	60	4021343005305	200
12312250S	1/2 x 250	10	60	4021343005336	250
12312300S	1/2 x 300	10	70	4021343005381	300
1233440S	3/4 x 40	10	120	4021343008054	40
1233460S	3/4 x 60	10	90	4021343008115	60
1233480S	3/4 x 80	10	70	4021343008160	80
12334100S	3/4 x 100	10	50	4021343007736	100
12334120S	3/4 x 120	5	50	4021343007781	120
12334150S	3/4 x 150	5	50	4021343007842	150
12334180S	3/4 x 180	5	50	4021343007910	180
12334200S	3/4 x 200	5	30	4021343007958	200
12334250S	3/4 x 250	5	30	4021343007989	250
12334300S	3/4 x 300	5	50	4021343008030	300
123140S	1 x 40	10	80	4021343005640	40
123160S	1 x 60	10	80	4021343006128	60
123180S	1 x 80	10	50	4021343006180	80
1231100S	1 x 100	10	40	4021343003929	100
1231120S	1 x 120	5	50	4021343003974	120
1231150S	1 x 150	5	30	4021343004926	150
1231180S	1 x 180	5	20	4021343004995	180
1231200S	1 x 200	5	20	4021343005039	200
1231250SA	1 x 250	5	20	4021343005435	250
1231300S	1 x 300	5	30	4021343005626	300
12311440S	1 1/4 x 40	5	60	4021343004759	40
12311460S	1 1/4 x 60	5	40	4021343004810	60
12311480S	1 1/4 x 80	5	40	4021343004872	80
123114100S	1 1/4 x 100	20	4021343004438	100	
123114120S	1 1/4 x 120	20	4021343004483	120	
123114150S	1 1/4 x 150	20	4021343004544	150	
123114180S	1 1/4 x 180	15	4021343004612	180	

Artikel-Nr.	Abmessung R	Beutel	Karton	EAN-Code-Nr.	a
123114200S	1 1/4 x 200		15	4021343004650	200
123114250S	1 1/4 x 250		12	4021343004681	250
123114300S	1 1/4 x 300		18	4021343004735	300
12311240S	1 1/2 x 40		50	4021343004278	40
12311260S	1 1/2 x 60		30	4021343004315	60
12311280S	1 1/2 x 80		20	4021343004353	80
123112100S	1 1/2 x 100		20	4021343003998	100
123112120S	1 1/2 x 120		20	4021343004032	120
123112150S	1 1/2 x 150		15	4021343004094	150
123112180S	1 1/2 x 180		15	4021343004155	180
123112200S	1 1/2 x 200		12	4021343004193	200
123112250S	1 1/2 x 250		12	4021343004216	250
123112300S	1 1/2 x 300		15	4021343004254	300
123240S	2 x 40		50	4021343007316	40
123260S	2 x 60		24	4021343007354	60
123280S	2 x 80		16	4021343007392	80
1232100S	2 x 100		12	4021343006630	100
1232120S	2 x 120		12	4021343006678	120
1232150S	2 x 150		12	4021343007132	150
1232180S	2 x 180		8	4021343007194	180
1232200S	2 x 200		6	4021343007231	200
1232250S	2 x 250		6	4021343007255	250
1232300S	2 x 300		8	4021343007293	300
12321260S	2 1/2 x 60		12	4021343007019	60
12321280S	2 1/2 x 80		12	4021343007057	80
123212100S	2 1/2 x 100		6	4021343006692	100
123212120S	2 1/2 x 120		6	4021343006739	120
123212150S	2 1/2 x 150		5	4021343006791	150
123212180S	2 1/2 x 180		3	4021343006852	180
123212200S	2 1/2 x 200		3	4021343006890	200
123212250S	2 1/2 x 250		3	4021343006913	250
123212300S	2 1/2 x 300		6	4021343006951	300
123360S	3 x 60		10	4021343008238	60
123380S	3 x 80		5	4021343008276	80
1233100S	3 x 100		5	4021343007439	100
1233120S	3 x 120		5	4021343007477	120
1233150S	3 x 150		3	4021343007538	150
1233180S	3 x 180		3	4021343007590	180
1233200S	3 x 200		2	4021343007637	200
1233250S	3 x 250		2	4021343007651	250
1233300S	3 x 300		3	4021343007699	300
123460S	4 x 60		6	4021343009037	60
123480S	4 x 80		3	4021343009075	80
1234100S	4 x 100		2	4021343008719	100
1234120S	4 x 120		2	4021343008757	120
1234150S	4 x 150		2	4021343008818	150
1234180S	4 x 180		2	4021343008870	180
1234200S	4 x 200		1	4021343008917	200
1234250S	4 x 250		1	4021343008931	250
1234300S	4 x 300		2	4021343008979	300
verzinkt					
1231440V	1/4 x 40	10	500	4021343005961	40
1231460V	1/4 x 60	10	400	4021343006005	60
1231480V	1/4 x 80	10	200	4021343006043	80
12314100V	1/4 x 100	10	150	4021343005688	100
12314120V	1/4 x 120	10	120	4021343005725	120
12314150V	1/4 x 150	10	120	4021343005787	150
12314180V	1/4 x 180	10	120	4021343005848	180
12314250V*	1/4 x 250	10	100	4021343005909	250
12314300V*	1/4 x 300	10	50	4021343005947	300
1233840V	3/8 x 40	10	200	4021343008580	40
1233860V	3/8 x 60	10	250	4021343008627	60
1233880V	3/8 x 80	10	150	4021343008665	80

* nur noch aus Lagervorrat lieferbar.

Katalog-Nr. und -bezeichnung

23 – Rohrdoppelnippel, schwarz oder verzinkt (Fortsetzung)

Artikel-Nr.	Abmessung R	Beutel	Karton	EAN-Code-Nr.	a
12338100V	3/8 x 100	10	100	4021343008306	100
12338120V	3/8 x 120	10	100	4021343008344	120
12338150V	3/8 x 150	10	80	4021343008405	150
12338180V	3/8 x 180	10	80	4021343008467	180
12338200V	3/8 x 200	10	80	4021343008504	200
12338250V	3/8 x 250	10	80	4021343008528	250
12338300V	3/8 x 300	10	100	4021343008566	300
1231240V	1/2 x 40	10	200	4021343005411	40
1231260V	1/2 x 60	10	160	4021343005510	60
1231280V	1/2 x 80	10	150	4021343005565	80
12312100V	1/2 x 100	10	100	4021343005084	100
12312120V	1/2 x 120	10	90	4021343005138	120
12312150V	1/2 x 150	10	60	4021343005206	150
12312180V	1/2 x 180	10	60	4021343005275	180
12312200V	1/2 x 200	10	60	4021343005312	200
12312250V	1/2 x 250	10	60	4021343005343	250
12312300V	1/2 x 300	10	70	4021343005398	300
1233440V	3/4 x 40	10	120	4021343008061	40
1233460V	3/4 x 60	10	90	4021343008122	60
1233480V	3/4 x 80	10	70	4021343008177	80
12334100V	3/4 x 100	10	50	4021343007743	100
12334120V	3/4 x 120	5	50	4021343007798	120
12334150V	3/4 x 150	5	50	4021343007859	150
12334180V	3/4 x 180	5	50	4021343007927	180
12334200V	3/4 x 200	5	30	4021343007965	200
12334250V	3/4 x 250	5	30	4021343007996	250
12334300V	3/4 x 300	5	50	4021343008047	300
123140V	1 x 40	10	80	4021343005657	40
123160V	1 x 60	10	80	4021343006135	60
123180V	1 x 80	10	50	4021343006197	80
1231100V	1 x 100	10	40	4021343003936	100
1231120V	1 x 120	5	50	4021343003981	120
1231150V	1 x 150	5	30	4021343004933	150
1231180V	1 x 180	5	20	4021343005008	180
1231200V	1 x 200	5	20	4021343005046	200
1231250VA	1 x 250	5	20	4021343005459	250
1231300V	1 x 300	5	30	4021343005633	300
12311440V	1 1/4 x 40	5	60	4021343004766	40
12311460V	1 1/4 x 60	5	40	4021343004827	60
12311480V	1 1/4 x 80	5	40	4021343004889	80
123114100V	1 1/4 x 100		20	4021343004445	100
123114120V	1 1/4 x 120		20	4021343004490	120
123114150V	1 1/4 x 150		20	4021343004551	150
123114180V	1 1/4 x 180		15	4021343004629	180
123114200V	1 1/4 x 200		15	4021343004667	200
123114250V	1 1/4 x 250		12	4021343004698	250
123114300V	1 1/4 x 300		18	4021343004742	300
12311240V	1 1/2 x 40		50	4021343004285	40
12311260V	1 1/2 x 60		30	4021343004322	60
12311280V	1 1/2 x 80		20	4021343004360	80
123112100V	1 1/2 x 100		20	4021343004001	100
123112120V	1 1/2 x 120		20	4021343004049	120
123112150V	1 1/2 x 150		15	4021343004100	150
123112180V	1 1/2 x 180		15	4021343004162	180
123112200V	1 1/2 x 200		12	4021343004209	200
123112250V	1 1/2 x 250		12	4021343004223	250
123112300V	1 1/2 x 300		15	4021343004261	300
123240V	2 x 40		50	4021343007323	40
123260V	2 x 60		24	4021343007361	60
123280V	2 x 80		16	4021343007408	80
1232100V	2 x 100		12	4021343006647	100
1232120V	2 x 120		12	4021343006685	120
1232150V	2 x 150		12	4021343007149	150

Katalog-Nr. und -bezeichnung

23 – Rohrdoppelnippel, schwarz oder verzinkt (Fortsetzung)

Artikel-Nr.	Abmessung R	Karton	EAN-Code-Nr.	a
1232180V	2 x 180	8	4021343007200	180
1232200V	2 x 200	6	4021343007248	200
1232250V	2 x 250	6	4021343007262	250
1232300V	2 x 300	8	4021343007309	300
12321260V	21/2 x 60	12	4021343007026	60
12321280V	21/2 x 80	12	4021343007064	80
123212100V	21/2 x 100	6	4021343006708	100
123212120V	21/2 x 120	6	4021343006746	120
123212150V	21/2 x 150	5	4021343006807	150
123212180V	21/2 x 180	3	4021343006869	180
123212200V	21/2 x 200	3	4021343006906	200
123212250V	21/2 x 250	3	4021343006920	250
123212300V	21/2 x 300	6	4021343006968	300
123360V	3 x 60	10	4021343008245	60
123380V	3 x 80	5	4021343008283	80
1233100V	3 x 100	5	4021343007446	100
1233120V	3 x 120	5	4021343007484	120
1233150V	3 x 150	3	4021343007545	150
1233180V	3 x 180	3	4021343007606	180
1233200V	3 x 200	2	4021343007644	200
1233250V	3 x 250	2	4021343007668	250
1233300V	3 x 300	3	4021343007705	300
123460V	4 x 60	6	4021343009044	60
123480V	4 x 80	3	4021343009082	80
1234100V	4 x 100	2	4021343008726	100
1234120V	4 x 120	2	4021343008764	120
1234150V	4 x 150	2	4021343008825	150
1234180V	4 x 180	2	4021343008887	180
1234200V	4 x 200	1	4021343008924	200
1234250V	4 x 250	1	4021343008948	250
1234300V	4 x 300	2	4021343008986	300

