

Installer manual
NIBE™ F1255
Ground source heat pump

Quick guide

Navigation

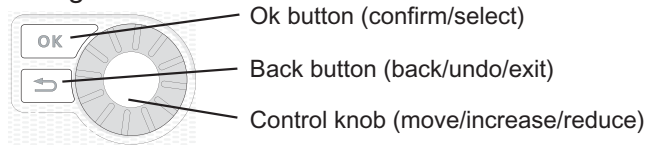

A detailed explanation of the button functions can be found on page 30.

How to scroll through menus and make different settings is described on page 32.

Set the indoor climate

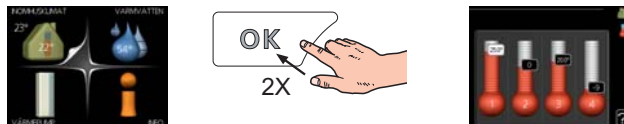

The mode for setting the indoor temperature is reached, when in the start mode in the main menu, by pressing the OK button twice. Read more about the settings on page 34.

Increase hot water volume



To temporarily increase the amount of hot water, first turn the control knob to mark menu 2 (water droplet) and then press the OK button twice. Read more about the settings on page 42.

In event of disturbances in comfort

If a disturbance in comfort of any type occurs there are some measures that can be taken before you need to contact your installer. See page 62 for instructions.

Table of Contents

1 Important information	2	Filling and venting	26
Safety information	2	Start guide	27
2 Delivery and handling	5	Post adjustment and venting	28
Transport	5	7 Control - Introduction	30
Assembly	5	Display unit	30
Supplied components	6	Menu system	31
Removing the covers	6	8 Control - Menus	34
Removing parts of the insulation	7	Menu 1 - INDOOR CLIMATE	34
3 The heat pump design	8	Menu 2 - HOT WATER	42
General	8	Menu 3 - INFO	44
Electrical cabinets	10	Menu 4 - HEAT PUMP	45
Cooling section	11	Menu 5 - SERVICE	50
4 Pipe connections	12	9 Service	56
General	12	Service actions	56
Dimensions and pipe connections	13	10 Disturbances in comfort	62
Brine side	13	Info-menu	62
Heating medium side	14	Manage alarm	62
Hot water heater	14	Troubleshooting	62
Docking alternatives	14	11 Accessories	64
5 Electrical connections	17	12 Technical data	66
General	17	Dimensions and setting-out coordinates	66
Connections	19	Technical specifications	67
Settings	21	Electrical circuit diagram	70
Optional connections	22	Item register	76
Connecting accessories	25		
6 Commissioning and adjusting	26		
Preparations	26		

1 Important information

Safety information

This manual describes installation and service procedures for implementation by specialists.

This appliance can be used by children aged from 8 years and above and persons with reduced physical, sensory or mental capabilities or lack of experience and knowledge if they have been given supervision or instruction concerning use of the appliance in a safe way and understand the hazards involved. Children shall not play with the appliance. Cleaning and user maintenance shall not be made by children without supervision.

Rights to make any design or technical modifications are reserved.

©NIBE 2013.

Symbols



NOTE

This symbol indicates danger to machine or person.



Caution

This symbol indicates important information about what you should observe when maintaining your installation.



TIP

This symbol indicates tips on how to facilitate using the product.

Marking

The CE marking means that NIBE ensures that the product meets all regulations that are placed on it based on relevant EU directives. The CE mark is obligatory for most products sold in the EU, regardless where they are made.

Serial number

The serial number can be found at the bottom right of the front cover and in the info menu (menu 3.1).

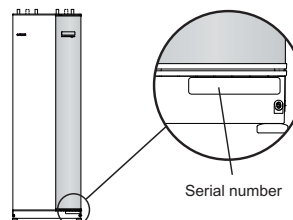

Caution

Always give the product's serial number (14 digits) when reporting a fault.

Country specific information

Installer manual

This installer manual must be left with the customer.

Inspection of the installation

Current regulations require the heating installation to be inspected before it is commissioned. The inspection must be carried out by a suitably qualified person. Fill in the page for information about installation data in the User manual.

✓	Description	Notes	Signature	Date
	Brine (page 13)			
	System flushed			
	System vented			
	Antifreeze			
	Level/Expansion vessel			
	Particle filter			
	Safety valve			
	Shut off valves			
	Circulation pump setting			
	Heating medium (page 14)			
	System flushed			
	System vented			
	Expansion vessel			
	Particle filter			
	Safety valve			
	Shut off valves			
	Circulation pump setting			
	Electricity (page 17)			
	Fuses heat pump			
	Fuses property			
	Outside sensor			
	Room sensor			
	Current sensor			
	Safety breaker			
	Earth circuit-breaker			
	Setting of emergency mode thermostat			
	Miscellaneous			
	Guarantee submitted			

Contact information

AT KNV Energietechnik GmbH, Gahberggasse 11, 4861 Schörfling

Tel: +43 (0)7662 8963-0 Fax: +43 (0)7662 8963-44 E-mail: mail@knv.at www.knv.at

CH NIBE Wärmetechnik AG, Winterthurerstrasse 710, CH-8247 Flurlingen

Tel: (52) 647 00 30 Fax: (52) 647 00 31 E-mail: info@nibe.ch www.nibe.ch

CZ Druzstevni zavody Drazice s.r.o., Drazice 69, CZ - 294 71 Benatky nad Jizerou

Tel: +420 326 373 801 Fax: +420 326 373 803 E-mail: nibe@nibe.cz www.nibe.cz

DE NIBE Systemtechnik GmbH, Am Reiherpfahl 3, 29223 Celle

Tel: 05141/7546-0 Fax: 05141/7546-99 E-mail: info@nibe.de www.nibe.de

DK Vølund Varmeteknik A/S, Member of the Nibe Group, Brogårdsvej 7, 6920 Videbæk

Tel: 97 17 20 33 Fax: 97 17 29 33 E-mail: info@volundvt.dk www.volundvt.dk

FI NIBE Energy Systems OY, Juurakkotie 3, 01510 Vantaa

Puh: 09-274 697 0 Fax: 09-274 697 40 E-mail: info@nibe.fi www.nibe.fi

FR AIT France, 10 rue des Moines, 67000 Haguenau

Tel : 03 88 06 24 10 Fax : 03 88 06 90 15 E-mail: info@nibe.fr www.nibe.fr

GB NIBE Energy Systems Ltd, 3C Broom Business Park, Bridge Way, Chesterfield S41 9QG

Tel: 0845 095 1200 Fax: 0845 095 1201 E-mail: info@nibe.co.uk www.nibe.co.uk

NL NIBE Energietechnik B.V., Postbus 2, NL-4797 ZG WILLEMSTAD (NB)

Tel: 0168 477722 Fax: 0168 476998 E-mail: info@nibenl.nl www.nibenl.nl

NO ABK AS, Brobekkveien 80, 0582 Oslo, Postadresse: Postboks 64 Vollebekk, 0516 Oslo

Tel. sentralbord: +47 23 17 05 20 E-mail: post@abkklima.no www.nibeenergysystems.no

PL NIBE-BIAWAR Sp. z o. o. Aleja Jana Pawła II 57, 15-703 BIAŁYSTOK

Tel: 085 662 84 90 Fax: 085 662 84 14 E-mail: sekretariat@biawar.com.pl www.biawar.com.pl

RU © "EVAN" 17, per. Boynovskiy, Nizhny Novgorod

Tel./fax +7 831 419 57 06 E-mail: info@evan.ru www.nibe-evan.ru

SE NIBE AB Sweden, Box 14, Hannabadsvägen 5, SE-285 21 Markaryd

Tel: +46-(0)433-73 000 Fax: +46-(0)433-73 190 E-mail: info@nibe.se www.nibe.se

For countries not mention in this list, please contact Nibe Sweden or check www.nibe.eu for more information.

2 Delivery and handling

Transport

F1255 should be transported and stored vertically in a dry place. When being moved into a building, F1255 may be leant back 45°. **Note!** Can be tail heavy.



TIP

The side panels can be removed for easier installation in the building.

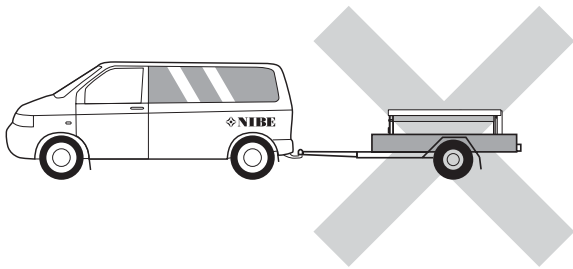
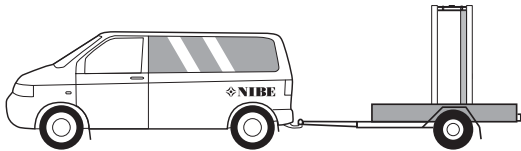

Installation area

Leave a space of 800 mm in front of the product. Approx 50 mm free space is required in order to open the side hatches. The hatches do not need to be opened during service, all service on F1255 can be carried out from the front. Leave space between the heat pump and wall behind (and any routing of supply cables and pipes) to reduce the risk reproduction of any vibration.

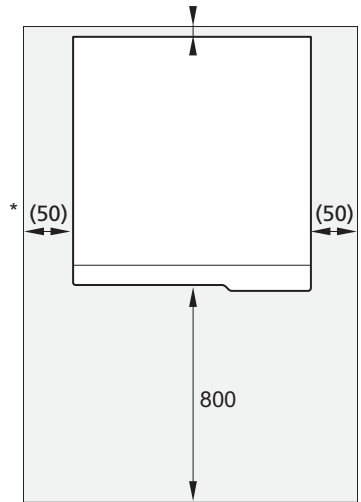

* A normal installation needs 300 - 400 mm (any side) for connection equipment, i.e. level vessel, valves and electrical equipment.

Pulling out the cooling module

To simplify transport and service, the heat pump can be separated by pulling the cooling module out from the cabinet.

See page 58 for instructions about the separation.

Assembly

- Position F1255 on a firm base that can take the weight, preferably on a concrete floor or foundation. Use the product's adjustable feet to obtain a horizontal and stable set-up.

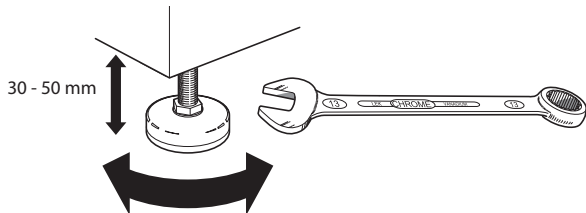

- The area where F1255 is located must be equipped with floor drainage.
- Install with its back to an outside wall, ideally in a room where noise does not matter, in order to eliminate noise problems. If this is not possible, avoid placing it against a wall behind a bedroom or other room where noise may be a problem.
- Wherever the unit is located, walls to sound sensitive rooms should be fitted with sound insulation.
- Route pipes so they are not fixed to an internal wall that backs on to a bedroom or living room.

Supplied components

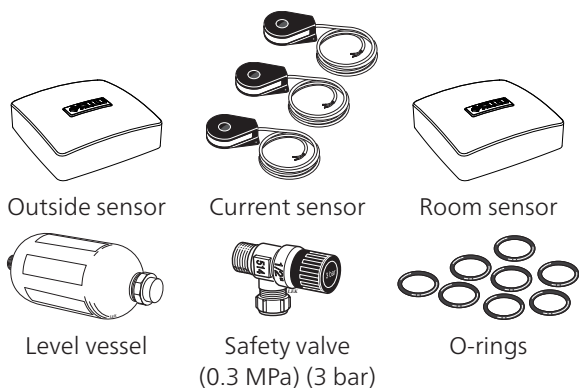

Location

The kit of supplied items is placed in packaging on top of the heat pump.

Removing the covers

Front cover

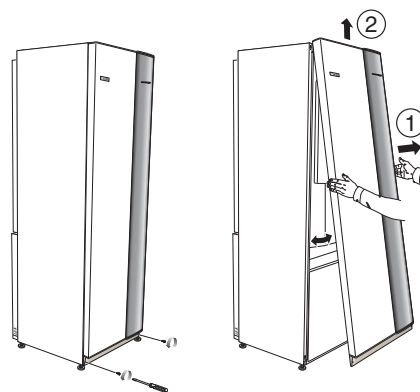

1. Remove the screws from the lower edge of the front cover.
2. Lift the cover out at the bottom edge and up.

Side covers

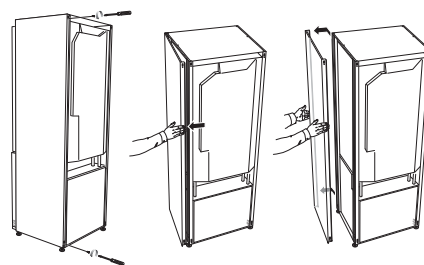

The side covers can be removed to facilitate the installation.

1. Remove the screws from the upper and lower edges.
2. Twist the cover slightly outward.
3. Move the cover backwards and slightly to the side.
4. Pull the cover to one side.
5. Pull the cover forwards.

Removing parts of the insulation

Parts of the insulation can be removed to facilitate the installation.

Insulation, top

1. Disconnect the cable from the motor and remove the motor from the shuttle valve as illustrated.

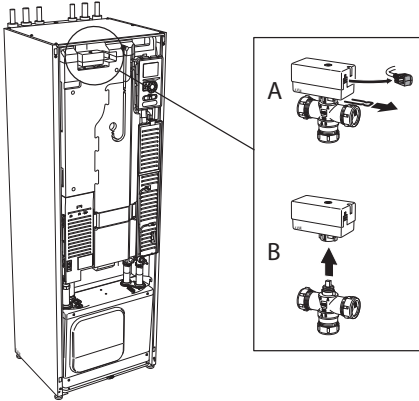

2. Grip the handle and pull straight out as illustrated.

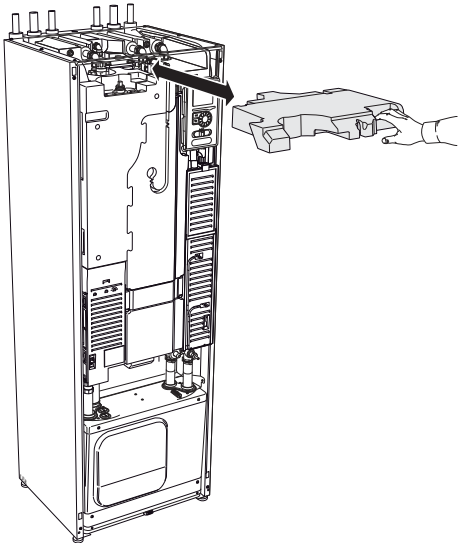

Insulation, immersion heater



NOTE

Electrical installation and service must be carried out under the supervision of a qualified electrician. Electrical installation and wiring must be carried out in accordance with the stipulations in force.

1. Remove the cover for the junction box according to the description on page 18.
2. Grip the handle and pull the insulation carefully towards you as illustrated.

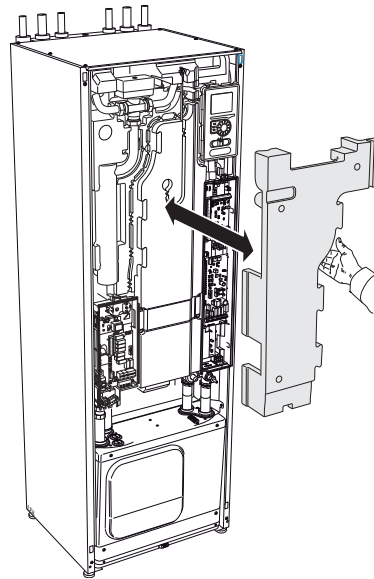

3 The heat pump design

General

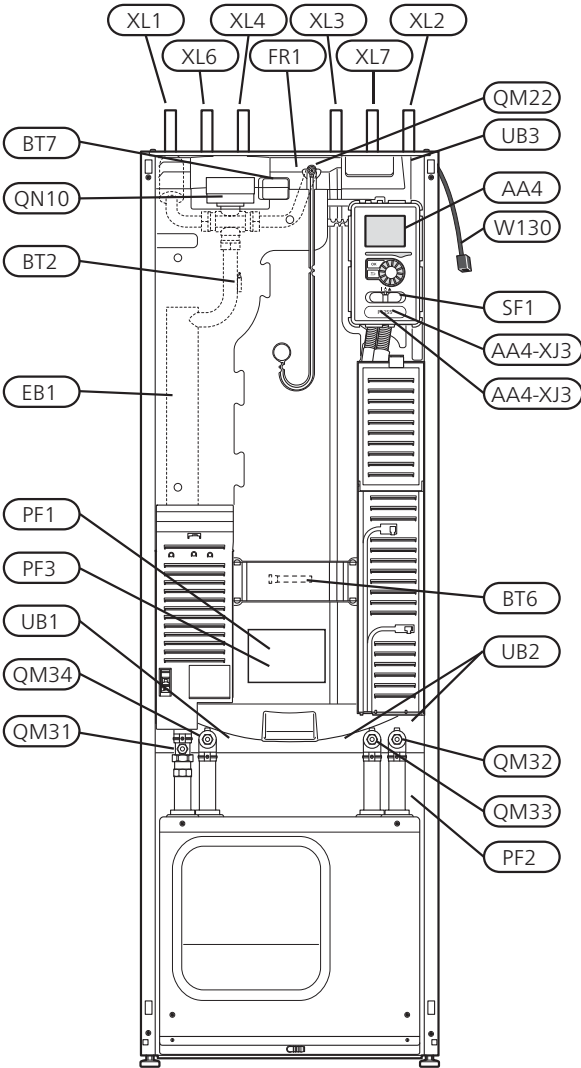

View from behind

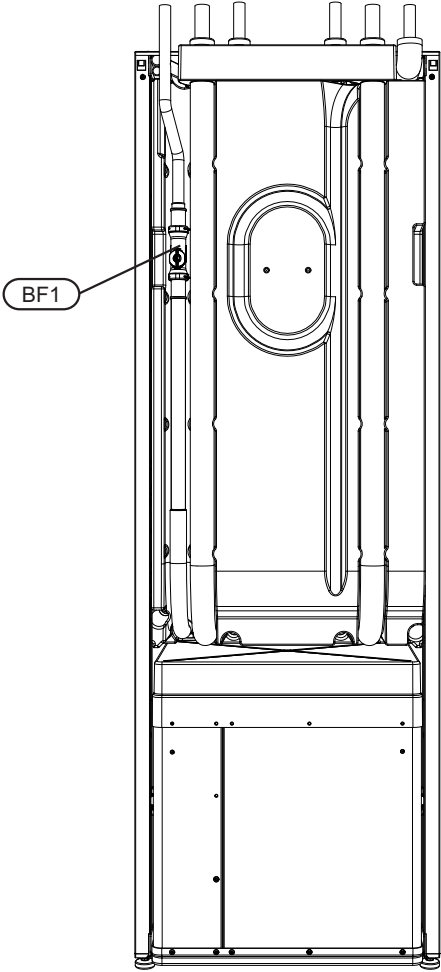

View from above

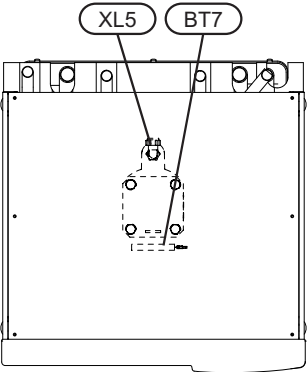

Pipe connections

XL 1	Connection, heating medium flow
XL 2	Connection, heating medium return
XL 3	Connection, cold water
XL 4	Connection, hot water
XL 5	Connection, HWC*
XL 6	Connection, brine in
XL 7	Connection, brine out

* Only applies to enamelled or stainless steel vessels.

HVAC components

QM 22	Venting, coil
QM 31	Shut-off valve, heating medium flow
QM 32	Shut off valve, heating medium return
QM 33	Shut off valve, brine out
QM 34	Shut-off valve, brine in
QN 10	Shuttle valve, climate system/water heater

Sensors etc.

BF 1	Flow meter (only for Germany, Switzerland and Austria)
BT 1	Outside sensor
BT 2	Temperature sensors, heating medium flow
BT 6	Temperature sensor, hot water charging
BT 7	Temperature sensor, hot water top

Electrical components

AA 4	Display unit
	AA4-XJ3 USB socket
	AA4-XJ4 Service outlet (No function)
EB 1	Immersion heater
FR 1	Sacrificial anode*
SF 1	Switch
W130	Network cable for NIBE Uplink™

* Only heat pump with enamelled vessel.

Miscellaneous

PF 1	Rating plate
PF 2	Type plate, cooling section
PF 3	Serial number plate
UB 1	Cable gland, incoming electricity
UB 2	Cable gland
UB 3	Cable gland, rear side, sensor

Designations in component locations according to standard IEC 81346-1 and 81346-2.

Electrical cabinets

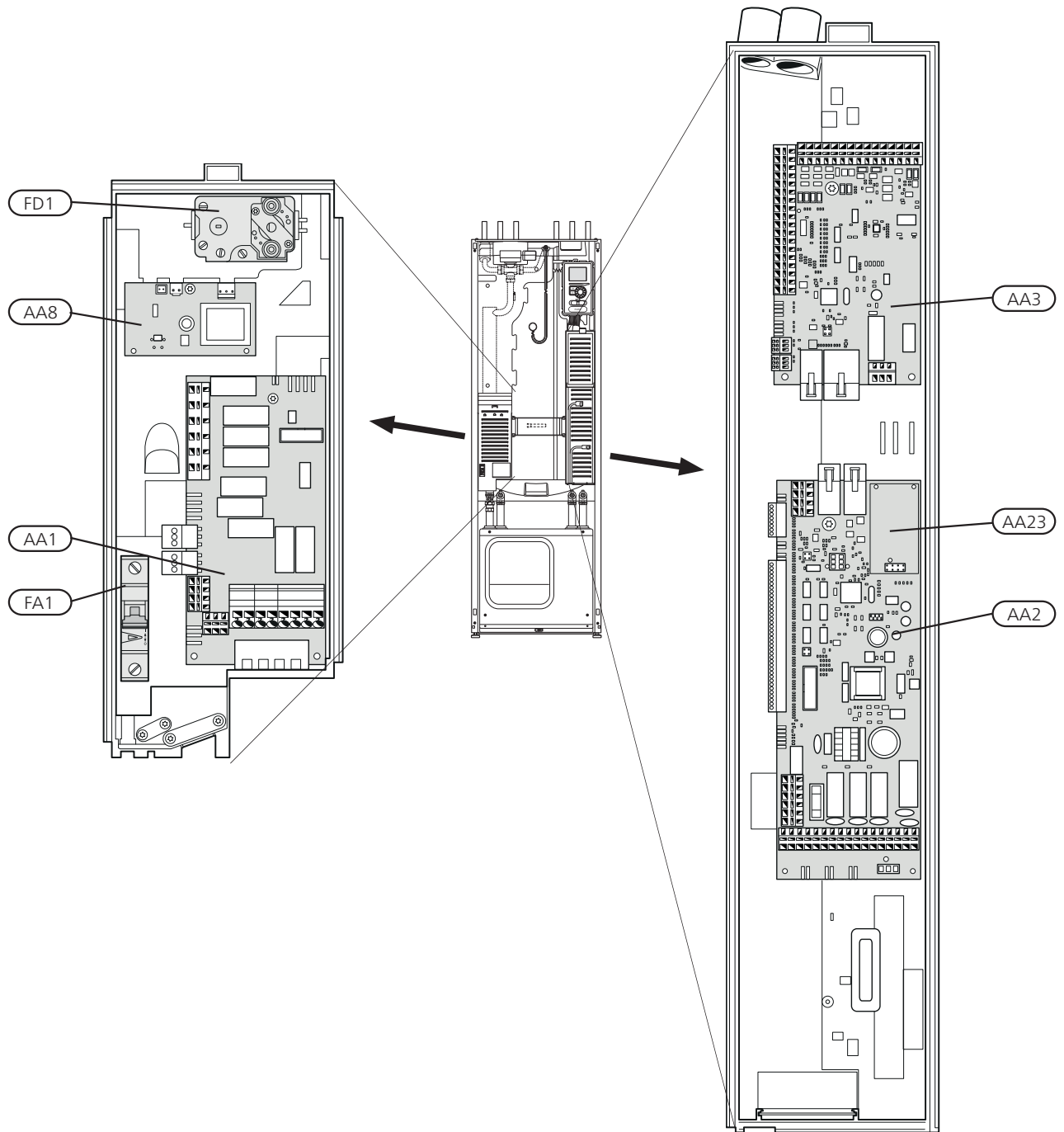

Electrical components

- AA 1 Immersion heater card
- AA 2 Base card
- AA 3 Input circuit board
- AA 8 Sacrificial anode card*
- AA23 Communication board
- FA 1 Miniature circuit-breaker
- FB 1 Motor cut-out

FD 1 Temperature limiter/Emergency mode thermostat

* Only heat pump with enamelled vessel.

Designations in component locations according to standard IEC 81346-1 and 81346-2.

Cooling section

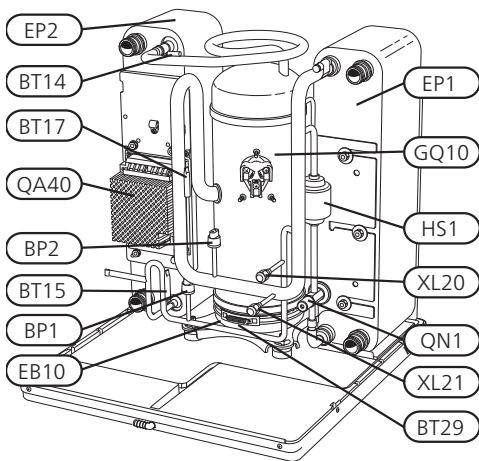
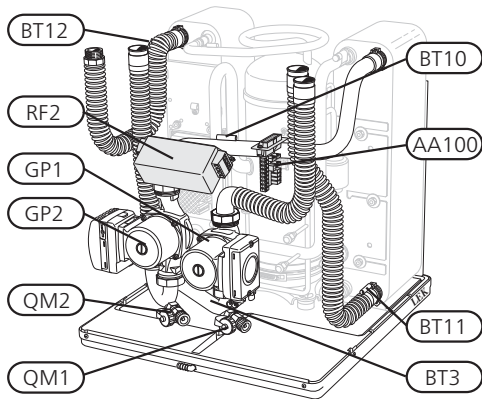

Pipe connections

- XL 20 Service connection, high pressure
- XL 21 Service connection, low pressure

HVAC components

- GP 1 Circulation pump
- GP 2 Brine pump
- QM 1 Drainage, climate system
- QM 2 Draining, brine side

Sensors etc.

- BP 1 High pressure pressostat
- BP 2 Low pressure pressostat
- BT 3 Temperature sensors, heating medium return
- BT 10 Temperature sensor, brine in
- BT 11 Temperature sensor, brine out
- BT 12 Temperature sensor, condenser supply line
- BT 14 Temperature sensor, hot gas
- BT 15 Temperature sensor, fluid pipe
- BT 17 Temperature sensor, suction gas
- BT 29 Temperature sensor, compressor

Electrical components

- AA 100 Joint card
- EB 10 Compressor heater
- QA 40 Inverter
- RF 2 EMC-filter

Cooling components

- EP 1 Evaporator
- EP 2 Condenser
- GQ 10 Compressor
- HS 1 Drying filter
- QN 1 Expansion valve

Designations in component locations according to standard IEC 81346-1 and 81346-2.

4 Pipe connections

General

Pipe installation must be carried out in accordance with current norms and directives. F1255 can operate with a return temperature of up to 58 °C and an outgoing temperature from the heat pump of 70 (65 °C with only the compressor).

F1255 is not equipped with external shut off valves; these must be installed to facilitate any future servicing.

Caution
Any high points in the climate system, must be equipped with air vents.

NOTE
The pipe system needs to be flushed out before the heat pump is connected so that debris cannot damage component parts.

Symbol key

Symbol	Meaning
↑	Venting valve
∩	Shut-off valve
∩	Non-return valve
⊕	Shunt / shuttle valve
∩	Safety valve
∩	Trim valve
⊗	Temperature sensor
⊕	Level vessel
⊕	Expansion vessel
⊕	Pressure gauge
⊕	Circulation pump
⊕	Particle filter
⊕	Auxiliary relay
⊕	Flow meter (only for Germany, Switzerland and Austria)
⊕	Compressor
⊕	Heat exchanger

System diagram

F1255 consists of a heat pump, water heater, electrical module, circulation pumps and a control system. F1255 is connected to the brine and heating medium circuits.

In the heat pump evaporator, the brine (water mixed with anti-freeze, glycol or ethanol) releases its energy to the refrigerant, which is vaporised in order to be compressed in the compressor. The refrigerant, of which the temperature has now been raised, is passed to the condenser where it gives off its energy to the heating medium circuit and, if necessary, to the water heater. If there is a greater need for heating/hot water than the compressor can provide there is an integrated immersion heater.

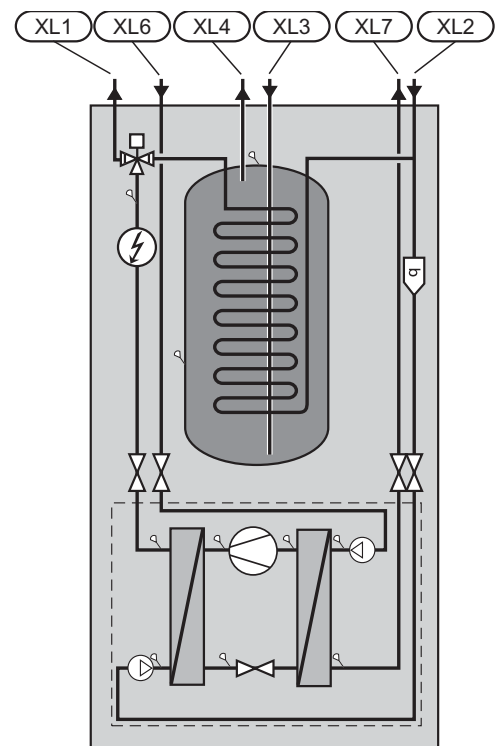

- XL 1 Connection, heating medium flow
- XL 2 Connection, heating medium return
- XL 3 Connection, cold water
- XL 4 Connection, hot water
- XL 6 Connection, brine in
- XL 7 Connection, brine out

Dimensions and pipe connections

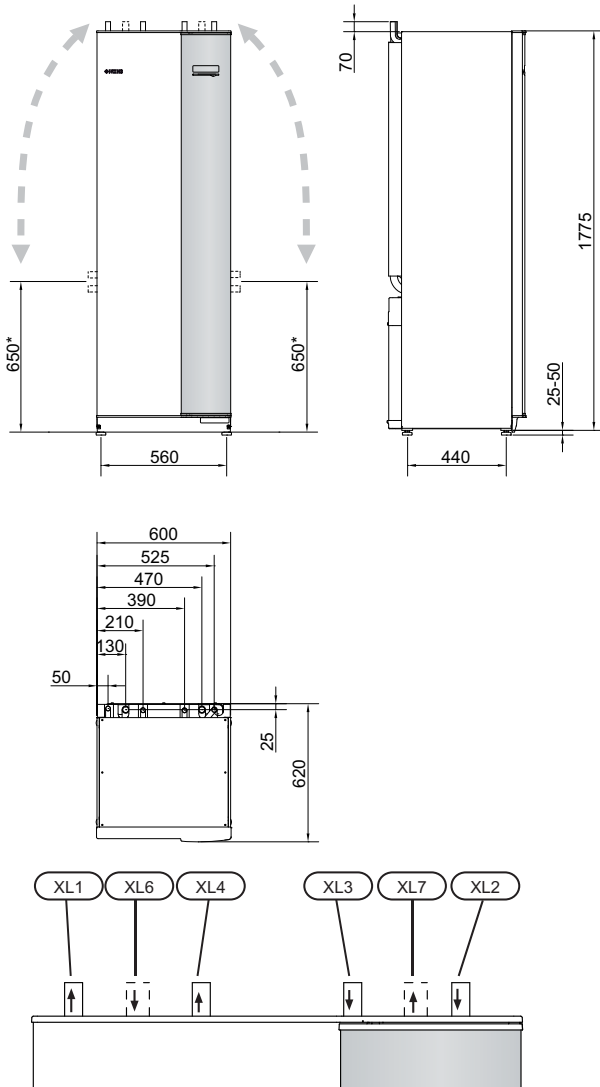

Pipe dimensions

Connection		
(XL6)/(XL7) Brine in/out ext Ø	(mm)	28
(XL1)/(XL2) Heating medium flow/return ext Ø	(mm)	28
(XL3)/(XL4) Cold/hot water Ø	(mm)	22

* Can be angled for side connection.

Brine side

Collector



Caution

The length of the collector hose varies depending on the rock/soil conditions, climate zone and on the climate system (radiators or under-floor heating) and the heating requirement of the building. Each installation must be sized individually.

Max length per coil for the collector should not exceed 400 m.

In those cases where it is necessary to have several collectors, these should be connected in parallel with the possibility for adjusting the flow of the relevant coil.

For surface soil heat, the hose should be buried at a depth determined by local conditions and the distance between the hoses should be at least 1 metre.

For several bore holes, the distance between the holes must be determined according to local conditions.

Ensure the collector hose rises constantly towards the heat pump to avoid air pockets. If this is not possible, airvents should be used.

As the temperature of brine system can fall below 0 °C it must be protected against freezing down to -15 °C. 1 litre of ready mixed brine per meter of collector hose (applies when using PEM-hose 40x 2.4 PN 6.3) is used as a guide value when making the volume calculation.

Side connection

It is possible to angle the brine connections, for connection to the side instead of top connection.

To angle out a connection:

1. Disconnect the pipe at the top connection.
2. Angle the pipe in the desired direction.
3. If necessary, cut the pipe to the desired length.

Connecting the brine side

- Insulate all indoor brine pipes against condensation.
- The level vessel must be installed as the highest point in the brine system on the incoming pipe before the brine pump (Alt. 1).

If the level vessel cannot be placed at the highest point an expansion vessel must be used (Alt. 2).



NOTE

Note that condensation may drip from the level vessel. Position the vessel so that this does not harm other equipment.

- Details of the antifreeze used must be shown on the level vessel.
- Install the supplied safety valve under the level vessel as illustrated. The entire length of the overflow water

pipe from the safety valves must be inclined to prevent water pockets and must also be frost proof.

- Install shut off valves as close to the heat pump as possible.
- Fit the supplied particle filter on the incoming pipe.

In the case of connection to an open groundwater system, an intermediate frost-protected circuit must be provided, because of the risk of dirt and freezing in the evaporator. This requires an extra heat exchanger.

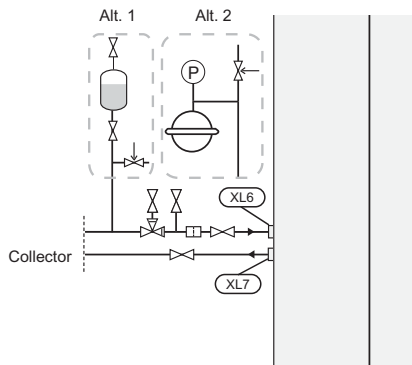

Heating medium side

Connecting the climate system

A climate system is a system that regulates indoor comfort with the help of the control system in F1255 and for example radiators, underfloor heating/cooling, fan convectors etc.

- Install all required safety devices, shut-off valves (as close to the heat pump as possible), and supplied particle filter.
- The safety valve must have a maximum 0.25 MPa (2.5 bar) opening pressure and be installed on the heating medium return as illustrated. The entire length of the overflow water pipe from the safety valves must be inclined to prevent water pockets and must also be frost proof.
- When connecting to a system with thermostats on all radiators, a relief valve must be fitted, or some of the thermostats must be removed to ensure sufficient flow.

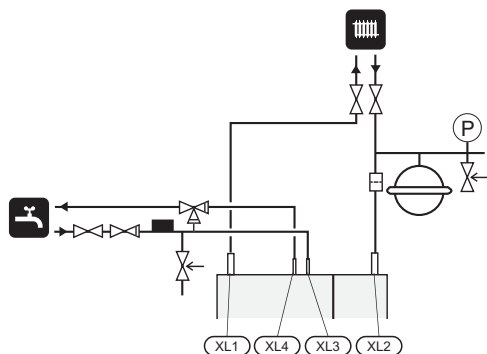

Hot water heater

Connecting the hot water heater

- The hot water heater in the heat pump must be supplied with necessary set of valves.
- The mixing valve must be installed if the setting is changed so that the temperature can exceed 60 °C.
- The setting for hot water is made in menu 5.1.1.
- The safety valve must have a maximum 1.0 MPa (10.0 bar) opening pressure and be installed on the incoming domestic water line as illustrated. The entire length of the overflow water pipe from the safety valves must be inclined to prevent water pockets and must also be frost proof.

Docking alternatives

F1255 can be connected in several different ways, some of which are shown below.

Further option information is available at www.nibe.eu and in the respective assembly instructions for the accessories used. See page 64 for a list of the accessories that can be used with F1255.

Extra electric hot water heater

The heat pump should be supplemented with an electric water heater, for example NIBE COMPACT, if a whirlpool or other significant consumer of hot water is installed.

- The valve connection on COMPACT can be separated. The mixing valve remains on COMPACT and the remaining valve connector can be used for incoming cold water in F1255.

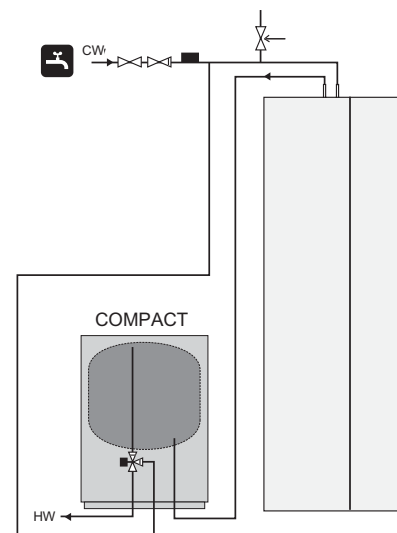

Buffer vessel

If the climate system volume is too small for the heat pump output, the radiator system can be supplemented with a buffer vessel, for example NIBE UKV.

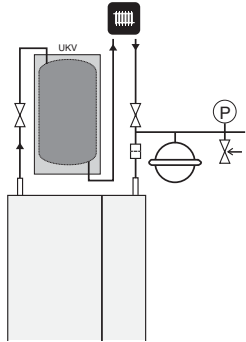

Ventilation recovery

The installation can be supplemented with the exhaust air module FLM to provide ventilation recovery.

- Pipes and other cold surfaces must be insulated with diffusion-proof material to prevent condensation.
- The brine system must be supplied with a pressure expansion vessel (CM3). If there is a level vessel (CM2) this should be replaced.

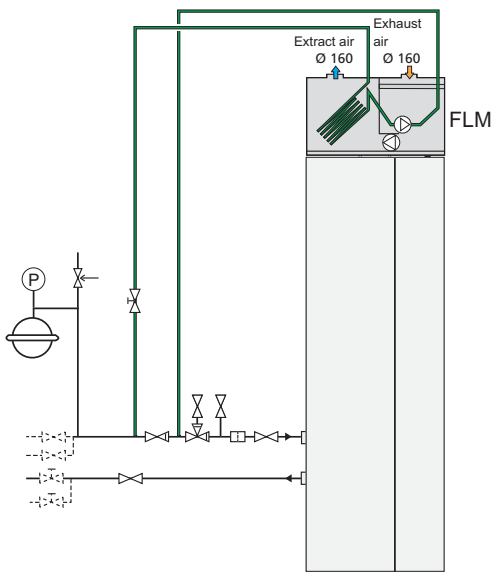

Free cooling

The installation can be supplemented with fan convectors, for example, in order to allow connections for free cooling (PCS 44).

- Pipes and other cold surfaces must be insulated with diffusion-proof material to prevent condensation.
- Where the cooling demand is high, fan convectors with drip trays and drain connection are needed.
- The brine system must be supplied with a pressure expansion vessel (CM3). If there is a level vessel (CM2) this should be replaced.

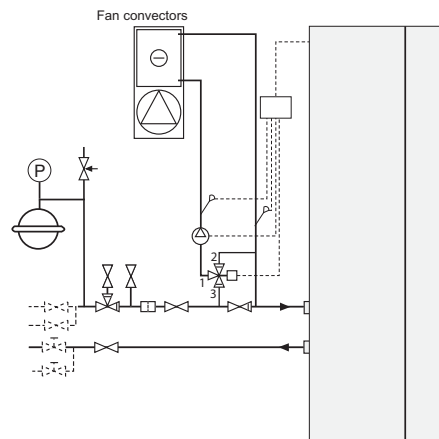

Under floor heating systems

The external circulation pump is dimensioned for the under floor heating system's demand.

If the climate system volume is too small for the heat pump output, the underfloor heating system can be supplemented with a buffer vessel, for example NIBE UKV.

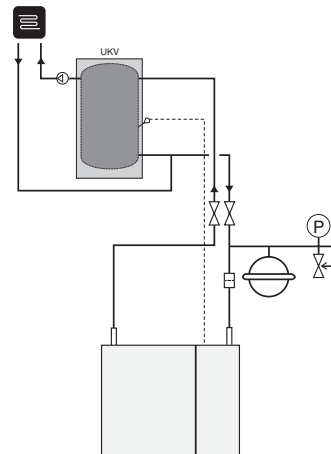

Two or more climate systems

When more than one climate system, with a lower temperature, is to be heated up, the following connection can be used. The shunt valve lowers the temperature to, for example, the under floor heating system.

The ECS 40/ECS 41 accessory is required for this connection.

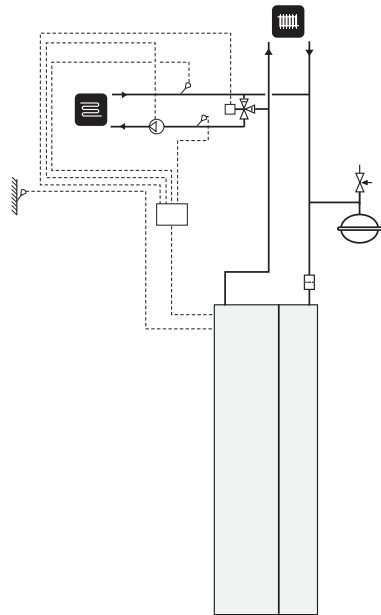

Pool

Charging of the pool is controlled by the pool sensor. In the case of low pool temperatures, the shuttle valve reverses direction and opens towards the pool exchanger. The POOL 40 accessory is required for this connection.

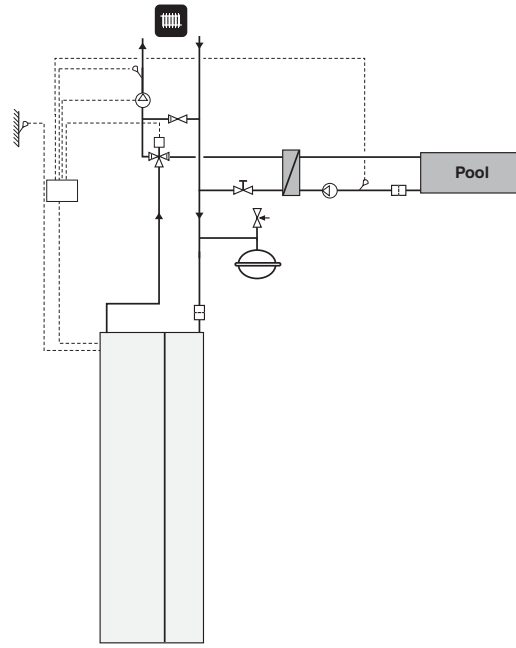

Ground water system

An intermediate heat exchanger is used to protect the heat pump's exchanger from dirt. The water is released into a buried filtration unit or a drilled well. See page 24 for more information about connecting a ground water pump.

If this docking alternative is used, "min. brine out" in menu 5.1.7 "br pmp al set." must be changed to a suitable value to prevent freezing in the heat exchanger.

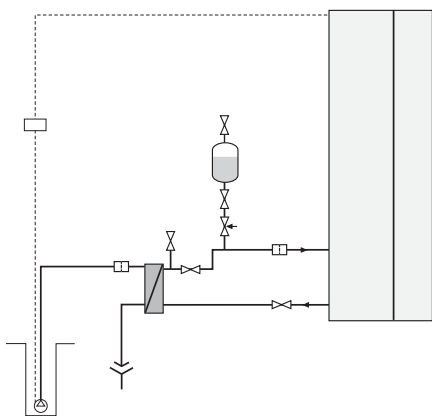

5 Electrical connections

General

All electrical equipment, except the outdoor sensors, room sensors and the current sensors are ready connected at the factory.

- Disconnect the heat pump before insulation testing the house wiring.
- If the building is equipped with an earth-fault breaker, F1255 should be equipped with a separate one.
- If a miniature circuit breaker is used this should have at least motor characteristic "C". See page 67 for fuse size.
- For wiring diagrams for the heat pump, see separate installation handbook for wiring diagrams.
- Communication and sensor cables to external connections must not be laid close to high current cables.
- The minimum area of communication and sensor cables to external connections must be 0.5 mm² up to 50 m, for example EKKX or LiYY or equivalent.
- When cable routing in F1255, cable grommets (e.g. UB1-UB3, marked in image) must be used. In UB1-UB3 the cables are inserted through the heat pump from the back to the front.

Miniature circuit-breaker

The heat pump operating circuit and a large proportion of its internal components are internally fused by a miniature circuit breaker (FA1).

Temperature limiter

The temperature limiter (FD1) cuts the current supply to the electrical addition if the temperature rises between 90 and 100°C and can be manually reset.

Resetting

The temperature limiter (FD1) is accessible behind the front cover. Reset the temperature limiter by pressing the button (FD1-SF2) using a small screwdriver.



NOTE

The switch (SF1) must not be moved to "I" or "Δ" until the boiler has been filled with water. Otherwise the temperature limiter, thermostat, compressor and the immersion heater can be damaged.



NOTE

Electrical installation and service must be carried out under the supervision of a qualified electrician. Cut the current with the circuit breaker before carrying out any servicing. Electrical installation and wiring must be carried out in accordance with the stipulations in force.

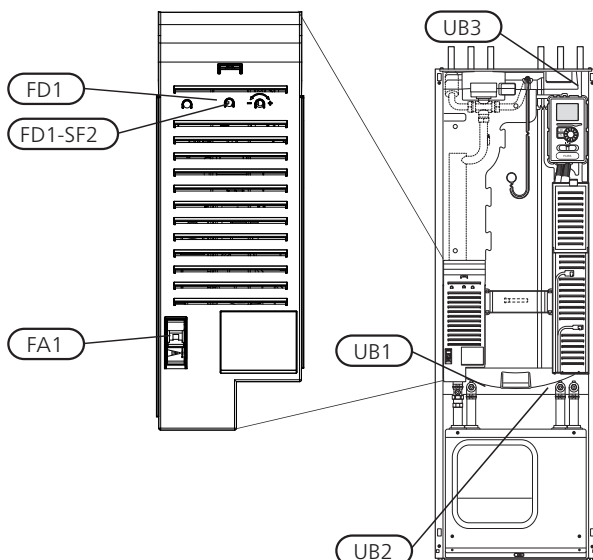

Accessibility, electrical connection

The plastic cap of the electrical boxes is opened using a screwdriver.



NOTE

The cover for the input card is opened without a tool.

Removing the cover, input circuit board

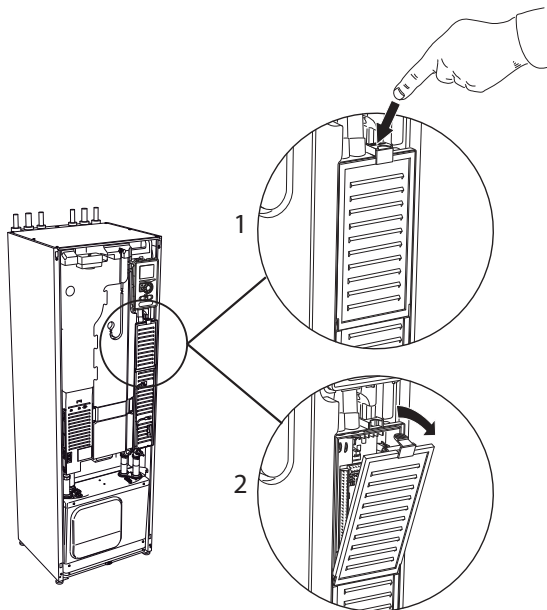

1. Push the catch down.
2. Angle out the cover and remove it.

Removing the cover, immersion heater circuit board

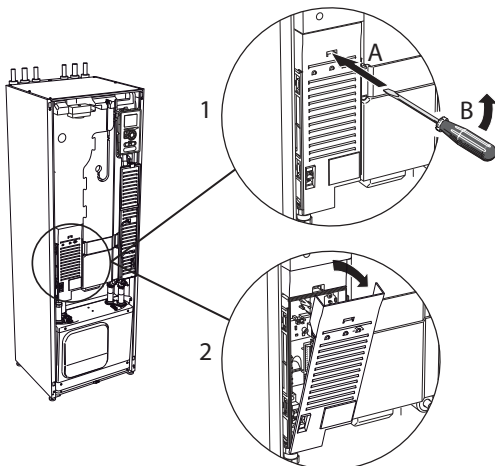

1. Insert the screwdriver (A) and pry the catch carefully downwards (B).
2. Angle out the cover and remove it.

Removing the cover, base board



Caution

To remove the cover for the base board, the cover for the input circuit board must first be removed.

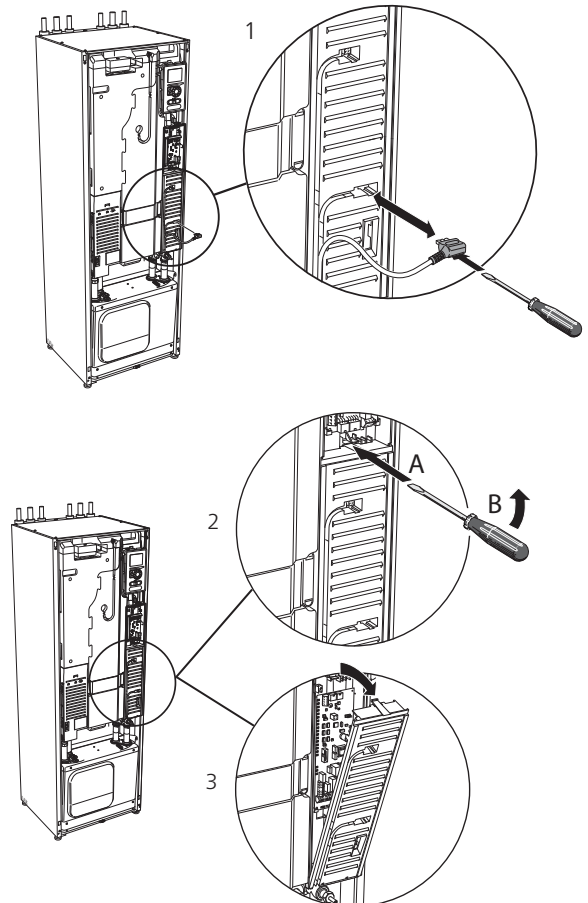

1. Disconnect the switches using a screwdriver.
2. Insert the screwdriver (A) and pry the catch carefully downwards (B).
3. Angle out the cover and remove it.

Cable lock

Use a suitable tool to release/lock cables in the heat pump terminal blocks.

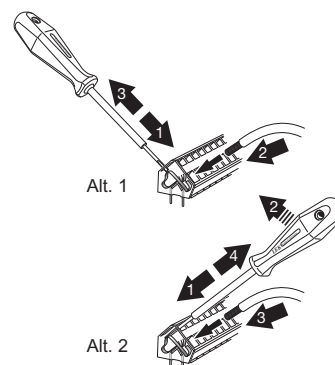

Connections



NOTE

To prevent interference, unscreened communication and/or sensor to external connections cables must not be laid closer than 20 cm to high voltage cable when cable routing.

Power connection

F1255 must be installed via an isolator switch with a minimum breaking gap of 3mm. Minimum cable area must be dimensioned according to the fuse rating used. Supplied cable for incoming electricity is connected to terminal block X1 on the immersion heater card (AA1).

Connection 3x400V

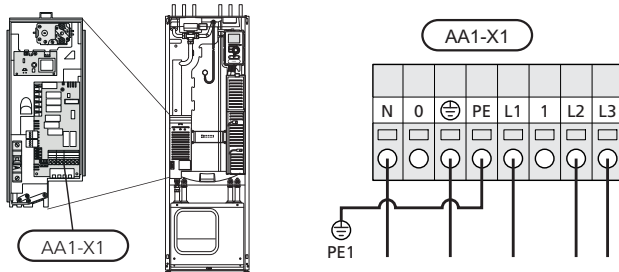

NOTE

F1255 contains scroll compressor, which means that it is important that electrical connections are made with the correct phase sequence. With the incorrect phase sequence, the compressor does not start and an alarm is displayed.

If separate supply to the compressor and immersion heater is required, see section "Switch for external blocking of addition and/or compressor" on page 23.

Tariff control

If the voltage to the immersion heater and/or the compressor disappears during a certain period, there must also be blocking via the AUX-input, see "Connection options- Possible selection for AUX inputs".

Connecting external operating voltage for the control system



NOTE

Mark up any junction boxes with warnings for external voltage.

If you wish to connect external operating voltage for the control system to F1255 on the immersion heater circuit board (AA1) the edge connector at AA1:X2 must be moved to AA1:X9 (as illustrated).

When connecting external operating voltage for the control system with separate earth-fault breaker, disconnect the blue cable from terminal block X7:24 on the immersion heater circuit board (AA1) and connect in the enclosed top clamp together with the incoming operating zero. Connect a blue cable (min 0.75 mm²) between the top clamp and X11:N on the immersion heater circuit board (as illustrated).

Operating voltage (1x230V+N+PE) is connected to AA1:X11 (as illustrated).

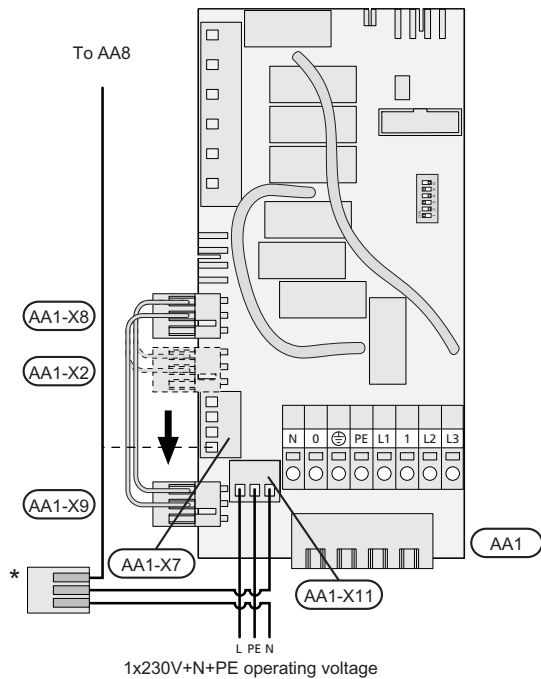

* Only with separate earth-fault breaker.

Outside sensor

Install the outside temperature sensor (BT1) in the shade on a wall facing north or north-west, so it is unaffected by the morning sun.

Connect the sensor to terminal block X6:1 and X6:2 on the input card (AA3). Use a twin core cable of at least 0.5 mm² cable area.

If a conduit is used it must be sealed to prevent condensation in the sensor capsule.

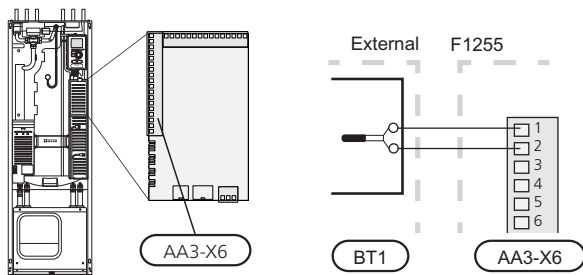

Temperature sensor, external flow line

If temperature sensor, external flow line (BT25) needs to be used, connect it to terminal block X6:5 and X6:6 on the input card (AA3). Use a 2 core cable of at least 0.5 mm² cable area.

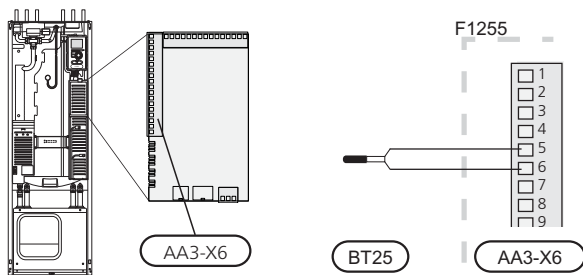

Room sensor

F1255 is delivered with a room sensor supplied (BT50). The room temperature sensor has up to three functions:

1. Show current room temperature in F1255's display.
2. Option of changing the room temperature in °C.
3. Makes it possible to change/stabilise the room temperature.

Install the sensor in a neutral position where the set temperature is required. A suitable location is on a free inner wall in a hall approx. 1.5 m above the floor. It is important that the sensor is not obstructed from measuring the correct room temperature by being located, for example, in a recess, between shelves, behind a curtain, above or close to a heat source, in a draft from an external door or in direct sunlight. Closed radiator thermostats can also cause problems.

The heat pump operates without the sensor, but if one wishes to read off the accommodation's indoor temperature in F1255's display the sensor must be installed. Connect the room sensor to X6:3 and X6:4 on the input circuit board (AA3).

If the sensor is to be used to change the room temperature in °C and/or to change/stabilise the room temperature, the sensor must be activated in menu 1.9.4.

If the room sensor is used in a room with under floor heating it should only have an indicatory function, not control of the room temperature.

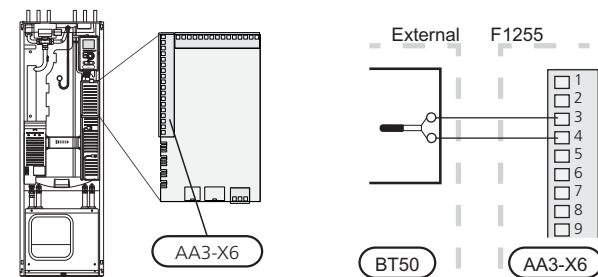

Caution

Changes of temperature in accommodation take time. For example, short time periods in combination with underfloor heating will not give a noticeable difference in room temperature.

Settings

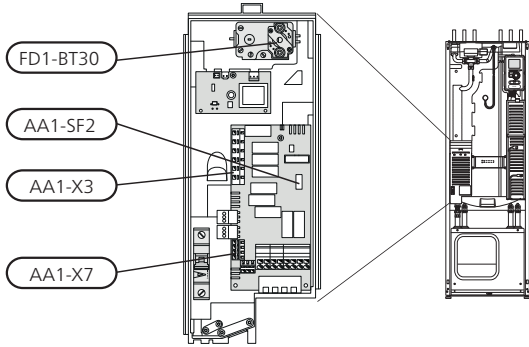

Electrical addition - maximum output

On delivery the immersion heater is connected for a maximum of 7 kW (switchable to 9 kW).

The immersion heater's output is split into seven steps (four steps if the immersion heater is switched to maximum 9 kW), according to the table below.

Setting max electrical output

Setting maximum output in the electrical addition is done in menu 5.1.12.

The tables display the total phase current for the immersion heater.

Switching to maximum electrical output



NOTE

This switch only applies to 3x400V.

If more than the maximum output for the immersion heater connected on delivery is needed, the heat pump can be switched to maximum 9 kW.

Move the white cable from terminal block X7:23 to terminal block X3:13 (the seal on the terminal block must be broken) on the immersion heater card (AA1).

3x400V (maximum electrical output, connected upon delivery 7 kW)

Max electrical addition (kW)	Max phase current L1(A)	Max phase current L2(A)	Max phase current L3(A)
0	0	0	0
1	0	0	4.3
2	0	8.7	0
3	0	8.7	4.3
4	0	8.7	8.7
5	8.7	8.7	4.3
6	8.7	8.7	8.7
7	8.7	8.7	13

3x400V (maximum electrical output, switched to 9 kW)

Max electrical addition (kW)	Max phase current L1(A)	Max phase current L2(A)	Max phase current L3(A)
0	0	0	0
2	0	8.7	0
4	0	8.7	8.7
6	8.7	8.7	8.7
9	8.7	16.2	16.2

If the current sensors are connected, the heat pump monitors the phase currents and allocates the electrical steps automatically to the least loaded phase.

Emergency mode

When the heat pump is set to emergency mode (SF1 is set to Δ) only the most necessary functions are activated.

- The compressor is off and heating is managed by the immersion heater.
- Hot water is not produced.
- The load monitor is not connected.



NOTE

Switch (SF1) must not be moved to "I" or " Δ " until F1255 has been filled with water. Otherwise the temperature limiter, thermostat, compressor and the immersion heater can be damaged.

Power in emergency mode

The immersion heater's output in emergency mode is set with the dipswitch (S2) on the immersion heater circuit board (AA1) according to the table below. Factory setting is 6 kW.

3x400V (maximum electrical output, connected upon delivery 7 kW)

	1	2	3	4	5	6
1 kW	off	off	off	off	off	on
2 kW	off	off	on	off	off	off
3 kW	off	off	on	off	off	on
4 kW	off	off	on	off	on	off
5 kW	on	off	on	off	off	on
6 kW	on	off	on	off	on	off
7 kW	on	off	on	off	on	on

3x400V (maximum electrical output, switched to 9 kW)

	1	2	3	4	5	6
2 kW	off	off	off	off	on	off
4 kW	off	off	on	off	on	off
6 kW	on	off	on	off	on	off
9 kW	on	off	on	on	on	on

3x400V

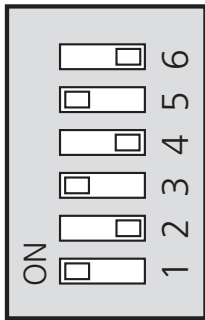

AA1-SF2

The image shows the dip-switch (AA1-SF2) in the factory setting, that is 6 kW.

Emergency mode thermostat

The supply temperature is set in emergency mode using a thermostat (FD1-BT30). It can be set to 35 (pre-set, for example underfloor heating) or 45 °C (for example radiators).

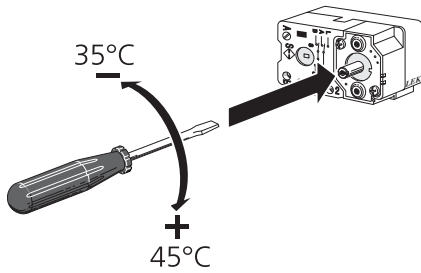

Optional connections

Load monitor

When many power consumers are connected in the property at the same time as the electric addition is operating, there is a risk of the property's main fuse tripping. The heat pump has integrated load monitors that control the electrical steps for the electrical addition by redistributing the power between the different phases or disengaging in event of overload in a phase. Reconnection occurs when other current consumption is reduced.

Connecting current sensors

A current sensor should be installed on each incoming phase conductor in to the distribution box to measure the current. The distribution box is an appropriate installation point.

Connect the current sensors to a multi-core cable in an enclosure next to the distribution box. Use a multi-core cable of at least 0.5 mm² from the enclosure to the heat pump.

Connect the cable to the input card (AA3) on terminal block X4:1-4 where X4:1 is the common terminal block for the three current sensors.

The size of the property's main fuse is set in menu 5.1.12.

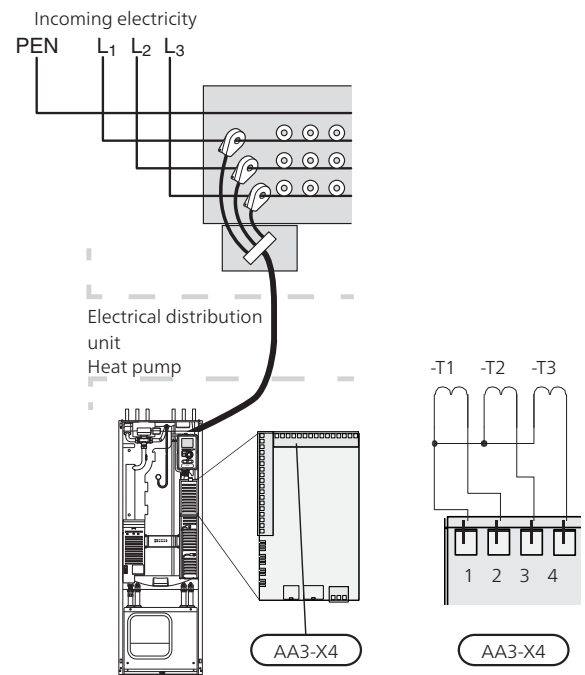

NIBE Uplink™

Connect the network connected cable (straight, Cat.5e UTP) with RJ45-contact (male) to RJ45 contact (female) on the rear of the heat pump.

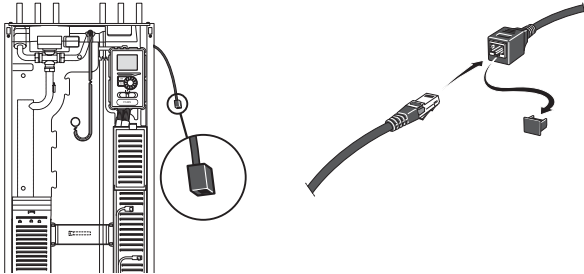

External connection options

F1255 has software controlled inputs and outputs on the input card (AA3), for connecting the external switch function or sensor. This means that when an external switch function or sensor is connected to one of six special connections, the correct function must be selected to the correct connection in the software in F1255.



Caution

If an external switch function or sensor is connected to F1255, the function to use input or output must be selected in menu 5.4, see page 54.

Selectable inputs on the input card for these functions are AUX1 (X6:9-10), AUX2 (X6:11-12), AUX3 (X6:13-14), AUX4 (X6:15-16) and AUX5 (X6:17-18). Selectable outputs are AA3:X7.

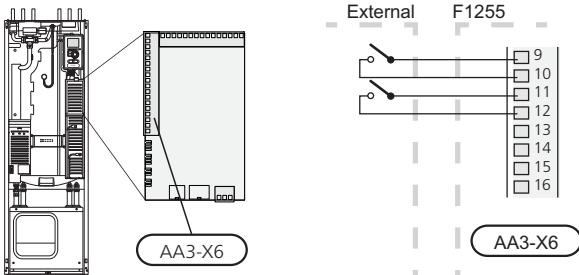
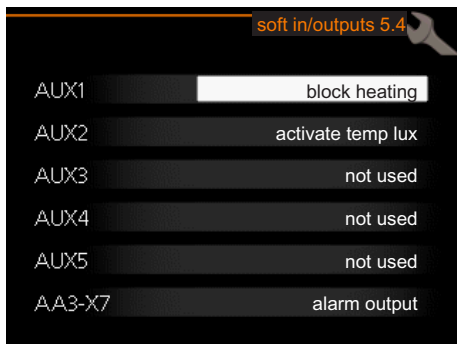

The example above uses the inputs AUX1 (X6:9-10) and AUX2 (X6:11-12) on the input circuit board (AA3).



Caution

Some of the following functions can also be activated and scheduled via menu settings.

Possible selection for AUX inputs

Temperature sensor, cooling/heating

An extra temperature sensor can be connected to F1255 in order to better determine when it is time to switch between heating and cooling operation.

The temperature sensor is connected to the selected input (menu 5.4, the alternative is only displayed if cooling accessory is installed, see page 54) on terminal block X6 on the input card (AA3) which is located behind the front cover and is positioned in a suitable place in the climate system.

Use a 2 core cable of at least 0.5 mm² cable area.

Switch for external blocking of addition and/or compressor

In those cases external blocking of addition and/or compressor is wanted, this can be connected to terminal block X6 on the input card (AA3), which is positioned behind the front cover.

The additional heat and/or the compressor are disconnected by connecting a potential free switch function to the input selected in menu 5.4, see page 54.

External blocking of addition and compressor can be combined.

A closed contact results in the electrical output being disconnected.

Contact for external tariff blocking

In those cases external tariff blocking is used, this can be connected to terminal block X6 on the input card (AA3), which is positioned behind the front cover.

Tariff blocking means that the additional heat, the compressor and heating are disconnected by connecting a potential free switch function to the input selected in menu 5.4, see page 54.

A closed contact results in the electrical output being disconnected.

Switch for "SG ready"



NOTE

This function can only be used in mains networks that support the "SG Ready"-standard (Germany).

"SG Ready" requires two AUX inputs.

In cases where this function is required it must be connected to terminal block X6 on the input card (AA3).

"SG Ready" is a smart form of tariff control where your electricity supplier can affect the indoor, hot water and/or pool temperatures (if applicable) or simply block the additional heat and/or compressor in the heat pump at certain times of the day (can be selected in menu 4.1.5 after the function of the day is activated). Activate the function by connecting potential free switch functions

to two inputs selected in menu 5.4 (SG Ready A and SG Ready B), see page 54.

Closed or open switch means one of the following (A = SG Ready A and B = SG Ready B):

■ **Blocking (A: Closed, B: Open)**

"SG Ready" is active. The compressor in the heat pump and additional heat is blocked like the day's tariff blocking.

■ **Normal mode (A: Open, B: Open)**

"SG Ready" is not active. No effect on the system.

■ **Low price mode (A: Open, B: Closed)**

"SG Ready" is active. The system focuses on costs savings and can for example exploit a low tariff from the electricity supplier or over capacity from any own power source (effect on the system can be adjusted in the menu 4.1.5).

■ **Overcapacity mode (A: Closed, B: Closed)**

"SG Ready" is active. The system is permitted to run at full capacity at over capacity with the electricity supplier (effect on the system is settable in menu 4.1.5).

Switch for external blocking of heating

In those cases external blocking of heat is used, this can be connected to terminal block X6 on the input card (AA3), which is positioned behind the front cover.

Heating operation is disconnected by connecting a potential free switch function to the input selected in menu 5.4, see page 54.

A closed switch results in blocked heating operation.

Switch for external forced control of brine pump

In those cases external forced control of brine pump is used, this can be connected to terminal block X6 on the input card (AA3), which is positioned behind the front cover.

The brine pump can be force controlled by connecting a potential free switch function to the input selected in menu 5.4, see page 54.

A closed switch means that the brine pump is active.

Contact for activation of "temporary lux"

An external contact function can be connected to F1255 for activation of the hot water function "temporary lux". The switch must be potential free and connected to the selected input (menu 5.4, see page 54) on terminal block X6 on the input circuit board (AA3).

"temporary lux" is activated for the time that the contact is connected.

Contact for activation of "external adjustment"

An external contact function can be connected to F1255 to change the supply temperature and the room temperature.

When the switch is closed the temperature changes in °C (if the room sensor is connected and activated). If a room sensor is not connected or not activated, the desired offset of "temperature" (heating curve offset) is set with the number of steps selected. The value is adjustable between -10 and +10.

■ *climate system 1*

The switch must be potential free and connected to the selected input (menu 5.4, see page 54) on terminal block X6 on the input circuit board (AA3).

The value for the change is set in menu 1.9.2, "external adjustment".

■ *climate system 2 to 4*

External adjustment for climate systems 2 to 4 require accessories (ECS 40).

See the accessory's installer handbook for installation instructions.

Contact for activation of fan speed



Caution

The external contact function functions only if the accessory FLM is installed and activated.

An external contact function can be connected to F1255 for activation of one of the four fan speeds. The switch must be potential free and connected to the selected input (menu 5.4, see page 54) on terminal block X6 on the input circuit board (AA3). When the switch closes, the selected fan speed is activated. Normal speed is resumed when the contact is opened again.

NV 10, pressure/level/flow monitor brine

If the level sensor (accessory NV10) is desired for the brine installation it can be connected on the selected input (menu 5.4, see page 54) on terminal block X6 on the input circuit board (AA3).

Pressure and flow sensors can also be connected to the input.

For function the input must be connected during normal operation.

Possible selection for AUX output (potential free variable relay)

It is possible to have an external connection through the relay function via a potential free variable relay (max 2 A) on the input circuit board (AA3), terminal block X7.

Optional functions for external connection:

- Indication of buzzer alarm.
- Controlling ground water pump.
- Cooling mode indication (only applies if accessories for cooling are present or if the heat pump has the integrated cooling function).
- Control of circulation pump for hot water circulation.
- External circulation pump (for heating medium).
- External, reversing valve for hot water.

If any of the above is installed to terminal block X7 it must be selected in menu 5.4, see page 54.

The common alarm is preselected at the factory.



NOTE

An accessory card is required if several functions are connected to terminal block X7 at the same time that the buzzer alarm is activated (see page 64).

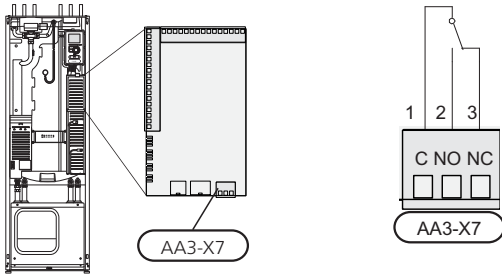

The picture shows the relay in the alarm position.

When switch (SF1) is in the "⏻" or "⚠" position the relay is in the alarm position.

External circulation pump, ground water pump or hot water circulation pump connected to the buzzer alarm relay as illustrated below.



NOTE

Mark up any junction boxes with warnings for external voltage.

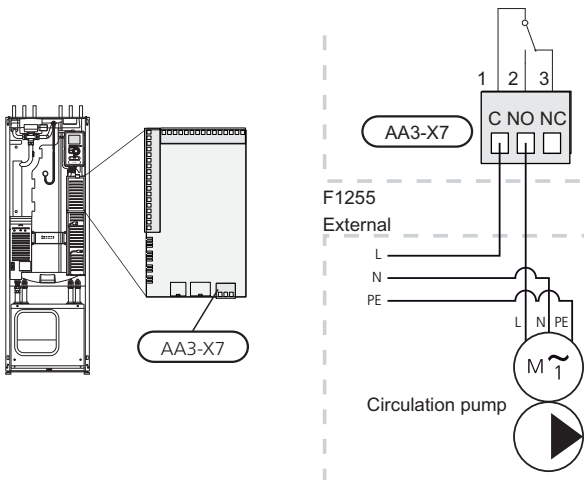

Caution

The relay outputs can have a max load of 2 A (230 V AC) in total.

Connecting accessories

Instructions for connecting accessories are in the installation instructions provided for the respective accessory. See page 64 for the list of the accessories that can be used with F1255.

6 Commissioning and adjusting

Preparations

1. Ensure that F1255 has not been damaged during transport.
2. Check that the switch (SF1) is in position "⏻".
3. Check for water in the hot water heater and climate system.



Caution

Check the miniature circuit-breaker and the motor protection breakers. They may have tripped during transportation.

Filling and venting



Caution

Insufficient venting can damage internal components in F1255.

Filling and venting the climate system

Filling

1. Open the venting valve (QM22).
2. When the water that exits the venting valve (QM22) is not mixed with air, close the valve. After a while the pressure starts to rise.
3. Close the filling valve when the correct pressure is obtained.

Venting



NOTE

Insufficient venting can cause damage to internal components.

1. Bleed the heat pump via the bleed valve (QM22) and the rest of the climate system via the relevant bleed valves.
2. Keep topping up and venting until all air has been removed and the pressure is correct.



TIP

If the heating medium pump (GP1) must be run during venting, it can be started via the start guide.



NOTE

The pipe from the coil in the container must be drained of water before air can be released. This means that the system is not necessarily vented despite the flow of water when the venting valve (QM22) is opened.

Filling the hot water heater

1. Open a hot water tap in the house.
2. Fill the hot water heater through the cold water connection (XL3).

3. When the water that comes out of the hot water tap is no longer mixed with air, the water heater is full and the tap can be closed.

Filling and venting the brine system



NOTE

Insufficient venting can cause damage to the brine pump.

When filling the brine system, mix the water with anti-freeze in an open container. The mixture should be protected against freezing down to about -15 °C. The brine is filled by connecting a filling pump.

1. Check the brine system for leakage.
2. Connect the filling pump and return line on the brine system's filler connector as illustrated.
3. If alternative 1 (level vessel) is used, close the valve under the level vessel (CM2).
4. Close the three way valve in the filler connector (accessory).
5. Open the valves on the filler connector.
6. Start the filling pump.
7. Fill until liquid enters the return pipe.
8. Vent the brine system with venting valve on F1255.
9. Close the valves on the filler connector.
10. Open the three way valve in the filler connector.
11. If alternative 1 (level vessel) is used, open the valve under the level vessel (CM2).



TIP

If the brine pump (GP2) must be run during venting, it can be started via the start guide.

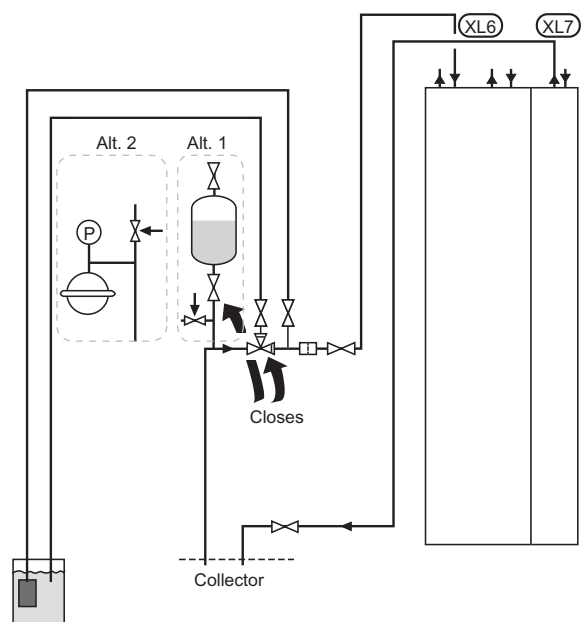

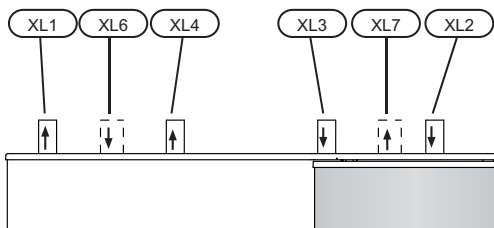

- XL 1 Connection, heating medium flow
- XL 2 Connection, heating medium return
- XL 3 Connection, cold water
- XL 4 Connection, hot water
- XL 6 Connection, brine in
- XL 7 Connection, brine out

Symbol key

Symbol	Meaning
	Shut-off valve
	Safety valve
	Level vessel
	Expansion vessel
	Pressure gauge
	Particle filter

Start guide



NOTE

There must be water in the climate system before the switch is set to "I".

1. Turn the heat pump's switch (SF1) to "I".
2. Follow the instructions in the start guide in the heat pump display. If the start guide does not start when you start the heat pump, start it manually in menu 5.7.



TIP

See page 30 for a more in-depth introduction to the heat pump's control system (operation, menus etc.).

Commissioning

The first time the heat pump is started a start guide is started. The start guide instructions state what needs to be carried out at the first start together with a run through of the heat pump's basic settings.

The start guide ensures that the start-up is carried out correctly and cannot be bypassed. The start guide can be started later in menu 5.7.



Caution

As long as the start guide is active, no function in the installation will start automatically.

The guide will appear at each installation re-start until it is deselected on the last page.

Operation in the start guide

A. Page

B. Name and menu number

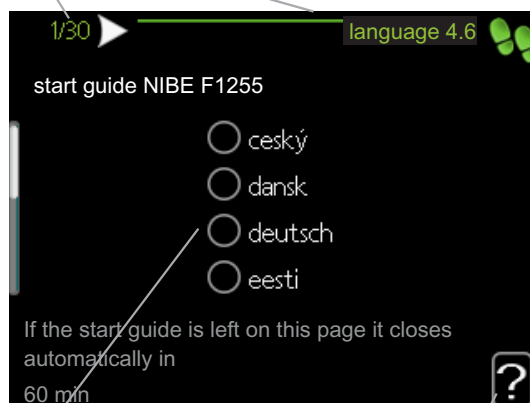

C. Option / setting

D. Help menu

A. Page

Here you can see how far you have come in the start guide.

Scroll between the pages of the start guide as follows:

1. Turn the control knob until one of the arrows in the top left corner (at the page number) has been marked.
2. Press the OK button to skip between the pages in the start guide.

B. Name and menu number

Read what menu in the control system this page of the start guide is based on. The digits in brackets refer to the menu number in the control system.

If you want to read more about affected menus either read off in the sub-menu or in the installation manual from page 34.

C. Option / setting

Make settings for the system here.

D. Help menu



In many menus there is a symbol that indicates that extra help is available.

To access the help text:

1. Use the control knob to select the help symbol.
2. Press the OK button.

The help text often consists of several windows that you can scroll between using the control knob.

Post adjustment and venting

Pump adjustment, automatic operation

Brine side

To set the correct flow in the brine system the correct speed must be set for the brine pump. This heat pump has a brine pump that can automatically controlled.

This automatic control occurs when the compressor is running and automatically sets the speed of the brine pump to obtain the optimal temperature difference between the supply and return lines. For passive cooling operation the brine pump must run at a set speed which is set in menu 5.1.9.

Heating medium side

To set the correct flow in the climate system the correct speed must be set for the heating medium pump. This heat pump has a heating medium pump that can automatically controlled.

This automatic control occurs when the compressor is running and automatically sets the speed of the heating medium pump, for the present operating mode, to obtain the optimal temperature difference between the supply and return lines. During heating operation the set DOT (dimensioned outdoor temperature) and temperature differential in menu 5.1.14 are used instead. If necessary the maximum speed of the circulation pump can be limited in menu 5.1.11.

Pump adjustment, manual operation

Brine side

To set the correct flow in the brine system the correct speed must be set for the brine pump. This heat pump has a brine pump that can automatically controlled, but if a manual speed is desired it must be set according to the following information and diagram. For manual operation "auto" must be deactivated in menu 5.1.9.

The flow must have a temperature difference between brine out (BT11) and brine in (BT10) of 2 - 5 °C when the system is balanced (suitably 5 minutes after compressor start). Check these temperatures in menu 3.1 "service info" and adjust the brine pump (GP2) speed until the temperature difference is achieved. A high difference indicates a low brine flow and a low difference indicates a high brine flow.

Read off what speed the brine pump should have during manual operation from the diagram below.

— Available pressure
—_p Electrical output

F1255 4 – 16 kW

Available pressure, kPa
Electrical output, W

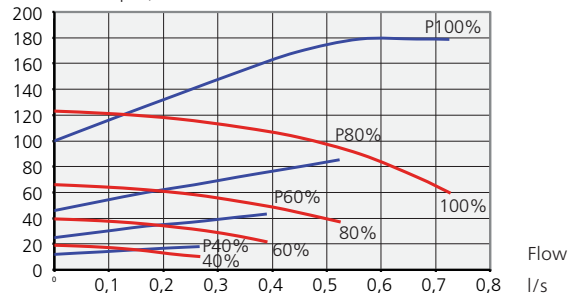

Heating medium side

To set the correct flow in the climate system the correct speed must be set for the heating medium pump in the different operating conditions. This heat pump has a heating medium pump that can automatically controlled, but if a manual speed is desired it must be set according to the following information and diagram. For manual operation "auto" must be deactivated in menu 5.1.11.

The flow must have a suitable temperature difference for the operation (heating operation: 5 - 10 °C, hot water regeneration: 8 - 10 °C, pool heating: approx. 15 °C) between flow temperature (BT2) and the return temperature (BT3). Check these temperatures in menu 3.1 "service info" and adjust the heating medium pump (GP1) speed until the temperature difference is achieved. A high difference indicates a low heating medium flow and a low difference indicates a high heating medium flow.

Set the speed of the heating medium pump in menu 5.1.11, see page 52.

Read off what speed the heating medium pump should have during manual operation from the diagrams below.

— Available pressure
— p Electrical output

F1255 4 – 16 kW

Available pressure, kPa
Electrical output, W

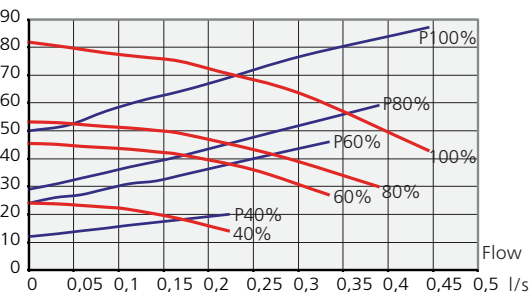

Readjusting, venting, heat medium side

Air is initially released from the hot water and venting may be necessary. If gurgling sounds can be heard from the heat pump or climate system, the entire system will require additional venting.

Readjusting, venting, collector side

Level vessel

Check the fluid level in the level vessel (CM2). If the fluid level has dropped, top up the system.

1. Close the valve under the vessel.
2. Disconnect the connection on top of the vessel.
3. Fill with brine until approx 2/3 of the vessel is full.
4. Reconnect the connector at the top of the vessel.
5. Open the valve under the vessel.

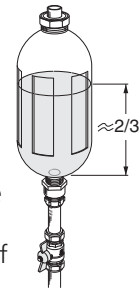

The pressure is raised by closing the valve on the incoming main line when the brine pump (GP2) is running and the level vessel (CM2) is open, so that liquid is drawn down from the vessel.

Expansion vessel

If a pressure expansion vessel (CM3) is used instead of a level vessel, the pressure level is checked. If the pressure drops, the system should be replenished.

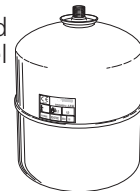

Post adjusting the room temperature

If the required room temperature is not obtained, re-adjustment may be necessary.

Cold weather conditions

- If the room temperature is too low, increase "heating curve" in menu 1.9.1, one step.
- If the room temperature is too high, reduce "heating curve" in menu 1.9.1, one step.

Warm weather conditions

- If the room temperature is too low, increase "temperature" (heating curve offset) in menu 1.1, one step.
- If the room temperature is too high, reduce "temperature" (heating curve offset) in menu 1.1, one step.

7 Control - Introduction

Display unit

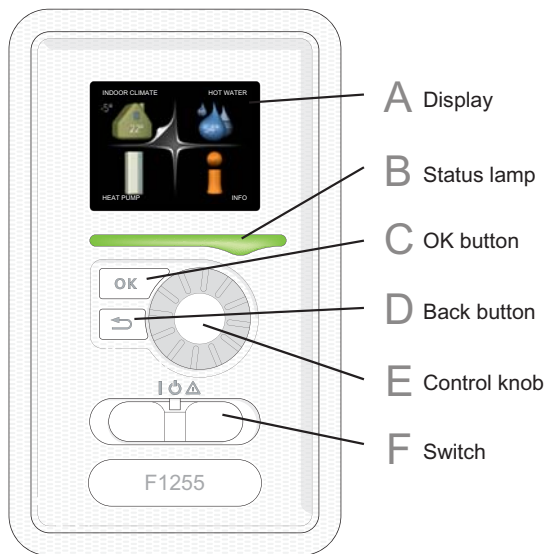

F

Switch (SF1)

The switch assumes three positions:

- On (I)
- Standby (⏻)
- Emergency mode (⚠)

Emergency mode must only be used in the event of a fault on the heat pump. In this mode, the compressor switches off and the immersion heater engages. The heat pump display is not illuminated and the status lamp illuminates yellow.

A Display

Instructions, settings and operational information are shown on the display. The easy-to-read display and menu system, facilitates navigation between the different menus and options to set the comfort or obtain the information you require.

B Status lamp

The status lamp indicates the status of the heat pump. It:

- lights green during normal operation.
- lights yellow in emergency mode.
- lights red in the event of a deployed alarm.

C OK button

The OK button is used to:

- confirm selections of sub menus/options/set values/page in the start guide.

D Back button

The back button is used to:

- go back to the previous menu.
- change a setting that has not been confirmed.

E Control knob

The control knob can be turned to the right or left. You can:

- scroll in menus and between options.
- increase and decrease the values.
- change page in multiple page instructions (for example help text and service info).

Menu system

When the door to the heat pump is opened, the menu system's four main menus are shown in the display as well as certain basic information.

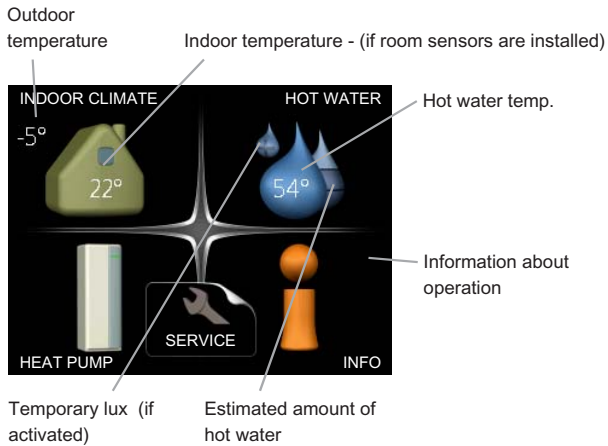

Menu 1 - INDOOR CLIMATE

Setting and scheduling the indoor climate. See page 34.

Menu 2 - HOT WATER

Setting and scheduling hot water production. See page 42.

Menu 3 - INFO

Display of temperature and other operating information and access to the alarm log. See page 44.

Menu 4 - HEAT PUMP

Setting time, date, language, display, operating mode etc. See page 45.

Menu 5 - SERVICE

Advanced settings. These settings are not available to the end user. The menu is visible by pressing the Back button for 7 seconds. See page 50.

Symbols in the display

The following symbols can appear in the display during operation.

Symbol	Description
	This symbol appears by the information sign if there is information in menu 3.1 that you should note.
	These two symbols indicate whether the compressor or addition is blocked in F1255.
	These can, for example, be blocked depending on which operating mode is selected in menu 4.2, if blocking is scheduled in menu 4.9.5 or if an alarm has occurred that blocks one of them.
	Blocking the compressor.
	Blocking additional heat.
	This symbol appears if lux mode for the hot water is activated.
	This symbol indicates the actual speed of the fan if the speed has changed from the normal setting. Accessory NIBE FLM required.
	This symbol indicates whether F1255 has contact with NIBE Uplink™.
	This symbol indicates whether "holiday setting" is activated in menu 4.7.

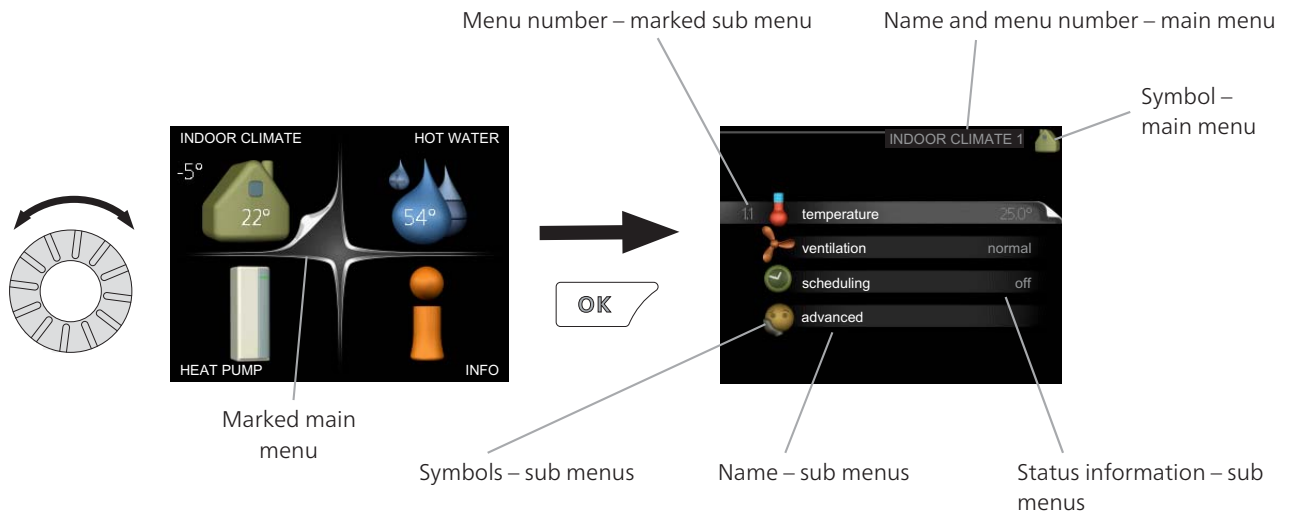

Operation

To move the cursor, turn the control knob to the left or the right. The marked position is brighter and/or has a turned up tab.

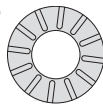

Selecting menu

To advance in the menu system select a main menu by marking it and then pressing the OK button. A new window then opens with sub menus.

Select one of the sub menus by marking it and then pressing the OK button.



Selecting options



Alternative

In an options menu the current selected option is indicated by a green tick. 

To select another option:





1. Mark the applicable option. One of the options is pre-selected (white). 
2. Press the OK button to confirm the selected option. The selected option has a green tick. 

Setting a value



Values to be changed

To set a value:

1. Mark the value you want to set using the control knob. 
2. Press the OK button. The background of the value becomes green, which means that you have accessed the setting mode. 
3. Turn the control knob to the right to increase the value and to the left to reduce the value. 
4. Press the OK button to confirm the value you have set. To change and return to the original value, press the Back button. 

Use the virtual keyboard

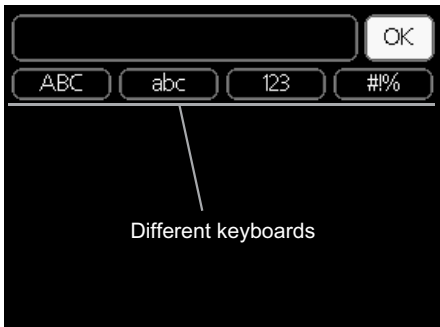

In some menus where text may require entering, a virtual keyboard is available.

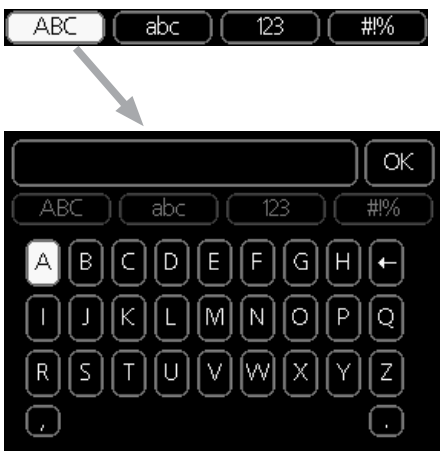

Depending on the menu, you can gain access to different character sets which you can select using the control knob. To change character table, press the Back button. If a menu only has one character set the keyboard is displayed directly.

When you have finished writing, mark "OK" and press the OK button.

Scroll through the windows

A menu can consist of several windows. Turn the control knob to scroll between the windows.

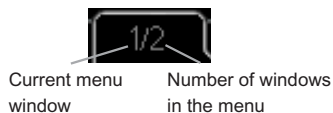

Scroll through the windows in the start guide



Arrows to scroll through window in start guide

1. Turn the control knob until one of the arrows in the top left corner (at the page number) has been marked.
2. Press the OK button to skip between the steps in the start guide.

Help menu

 In many menus there is a symbol that indicates that extra help is available.

To access the help text:

1. Use the control knob to select the help symbol.
2. Press the OK button.

The help text often consists of several windows that you can scroll between using the control knob.

8 Control - Menus

Menu 1 - INDOOR CLIMATE

Overview

1 - INDOOR CLIMATE	1.1 - temperature	
	1.2 - ventilation *	
	1.3 - scheduling	1.3.1 - heating
		1.3.2 - cooling *
		1.3.3 - ventilation *
	1.9 - advanced	1.9.1 - heating curve
		1.9.2 - external adjustment
		1.9.3 - min. flow line temp.
		1.9.4 - room sensor settings
		1.9.5 - cooling settings *
		1.9.6 - fan return time *
		1.9.7 - own curve
		1.9.8 - point offset
		1.9.9 - night cooling

* Accessories are needed.

Sub-menus

For the menu **INDOOR CLIMATE** there are several sub-menus. Status information for the relevant menu can be found on the display to the right of the menus.

temperature Setting the temperature for the climate system. The status information shows the set values for the climate system.

ventilation Setting the fan speed. The status information shows the selected setting. This menu is only displayed if the exhaust air module is connected (accessory).

scheduling Scheduling heating, cooling and ventilation. Status information "set" is displayed if you set a schedule but it is not active now, "holiday setting" is displayed if the vacation schedule is active at the same time as the schedule (the vacation function is prioritised), "active" displays if any part of the schedule is active, otherwise it displays "off".

advanced Setting of heat curve, adjusting with external contact, minimum value for supply temperature, room sensor and cooling function.

Menu 1.1 - temperature

If the house has several climate systems, this is indicated on the display by a thermometer for each system.

If the heat pump has an accessory for cooling or integrated cooling function this is shown in the display with an extra tab.

Set the temperature (with room sensors installed and activated):

Setting range: 5 - 30 °C

Default value: 20

The value in the display appears as a temperature in °C if the heating system is controlled by a room sensor.

To change the room temperature, use the control knob to set the desired temperature in the display. Confirm the new setting by pressing the OK button. The new temperature is shown on the right-hand side of the symbol in the display.

Setting the temperature (without room sensors activated):

Setting range: -10 to +10

Default value: 0

The display shows the set values for heating (curve offset). To increase or reduce the indoor temperature, increase or reduce the value on the display.

Use the control knob to set a new value. Confirm the new setting by pressing the OK button.

The number of steps the value has to be changed to achieve a degree change of the indoor temperature depends on the heating installation. One step is usually enough but in some cases several steps may be required.

Setting the desired value. The new value is shown on the right-hand side of the symbol in the display.



Caution

An increase in the room temperature can be slowed by the thermostats for the radiators or under floor heating. Therefore, open the thermostats fully, except in those rooms where a cooler temperature is required, e.g. bedrooms.

**TIP**

Wait 24 hours before making a new setting, so that the room temperature has time to stabilise.

If it is cold outdoors and the room temperature is too low, increase the curve slope in menu 1.9.1 by one increment.

If it is cold outdoors and the room temperature is too high, lower the curve slope menu 1.9.1 by one increment.

If it is warm outdoors and the room temperature is too low, increase the value in menu 1.1 by one increment.

If it is warm outdoors and the room temperature is too high, reduce the value in menu 1.1 by one increment.

Menu 1.2 - ventilation (accessory required)

Setting range: normal and speed 1-4

Default value: normal

The ventilation in the accommodation can be temporarily increased or reduced here.

When you have selected a new speed a clock starts a count down. When the time has counted down the ventilation speed returns to the normal setting.

If necessary, the different return times can be changed in menu 1.9.6.

The fan speed is shown in brackets (in percent) after each speed alternative.

**TIP**

If longer time changes are required use the holiday function or scheduling.

Menu 1.3 - scheduling

In the menu **scheduling** indoor climate (heating/cooling/ventilation) is scheduled for each weekday.

You can also schedule a longer period during a selected period (vacation) in menu 4.7.

Menu 1.3.1 - heating

Increases or decreases in the accommodation temperature can be scheduled here for up to three time periods per day. If a room sensor is installed and activated the desired room temperature (°C) is set during the time period. Without an activated room sensor the desired change is set (of setting in menu 1.1). One step is usually enough to change the room temperature by one degree, but in some cases several steps may be required.

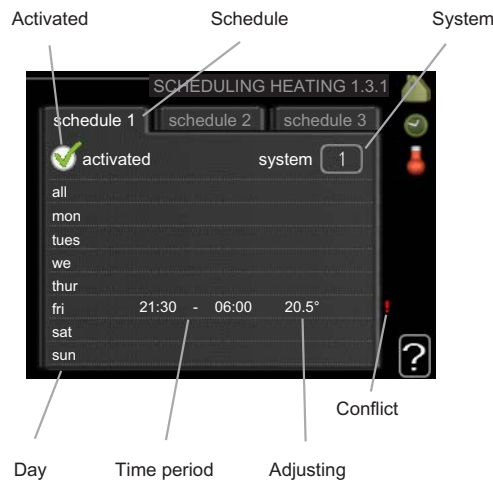

Schedule: The schedule to be changed is selected here.

Activated: Scheduling for the selected period is activated here. Set times are not affected at deactivation.

System: Which climate system the schedule is for is selected here. This alternative is only displayed if more than one climate system is present.

Day: Select which day or days of the week the schedule is to apply to here. To remove the scheduling for a particular day, the time for that day must be reset by setting the start time to the same as the stop time. If the line "all" is used, all days in the period are set for these times.

Time period: The start and stop time for the selected day for scheduling are selected here.

Adjusting: How much the heating curve is to be offset in relation to menu 1.1 during scheduling is set here. If the room sensor is installed the desired room temperature is set in °C.

Conflict: If two settings conflict with each other a red exclamation mark is displayed.

**TIP**

If you wish to set similar scheduling for every day of the week start by filling in "all" and then changing the desired days.

**Caution**

If the stop time is before the start time it means that the period extends past midnight. Scheduling always starts on the date that the start time is set for.

Changes of temperature in accommodation take time. For example, short time periods in combination with underfloor heating will not give a noticeable difference in room temperature.

Menu 1.3.2 - cooling (accessory required)

Here you can schedule when cooling is permitted in the accommodation for up to two different time periods per day.



Schedule: The schedule to be changed is selected here.

Activated: Scheduling for the selected period is activated here. Set times are not affected at deactivation.

Day: Select which day or days of the week the schedule is to apply to here. To remove the scheduling for a particular day, the time for that day must be reset by setting the start time to the same as the stop time. If the line "all" is used, all days in the period are set for these times.

Time period: The start and stop time for the selected day for scheduling are selected here.

Adjusting: Whether or not cooling is permitted during scheduling is set here.

Conflict: If two settings conflict with each other a red exclamation mark is displayed.

TIP
 If you wish to set similar scheduling for every day of the week start by filling in "all" and then changing the desired days.

Caution
 If the stop time is before the start time it means that the period extends past midnight. Scheduling always starts on the date that the start time is set for.

Menu 1.3.3 - ventilation (accessory required)

Increases or decreases in the ventilation to the accommodation can be scheduled here for up to two time periods per day.

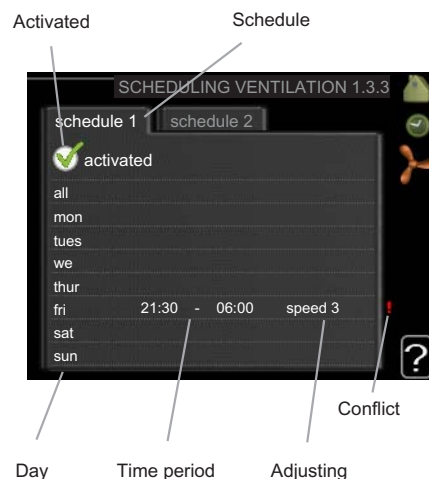

Schedule: The schedule to be changed is selected here.

Activated: Scheduling for the selected period is activated here. Set times are not affected at deactivation.

Day: Select which day or days of the week the schedule is to apply to here. To remove the scheduling for a particular day, the time for that day must be reset by setting the start time to the same as the stop time. If the line "all" is used, all days in the period are set for these times.

Time period: The start and stop time for the selected day for scheduling are selected here.

Adjusting: The desired fan speed is set here.

Conflict: If two settings conflict with each other a red exclamation mark is displayed.

TIP
 If you wish to set similar scheduling for every day of the week start by filling in "all" and then changing the desired days.

Caution
 If the stop time is before the start time it means that the period extends past midnight. Scheduling always starts on the date that the start time is set for.
 A significant change over a longer period of time may cause poor indoor environment and worse operating economy.

Menu 1.9 - advanced

Menu **advanced** has orange text and is intended for the advanced user. This menu has several sub-menus.

heating curve Setting the heating curve slope.

external adjustment Setting the heat curve offset when the external contact is connected.

min. flow line temp. Setting minimum permitted flow line temperature.

room sensor settings Settings regarding the room sensor.

cooling settings Settings for cooling.

fan return time Fan return time settings in the event of temporary ventilation speed change.

own curve Setting own heat curve.

point offset Setting the offset of the heating curve at a specific outdoor temperature.

night cooling Setting night cooling.

Menu 1.9.1 - heating curve

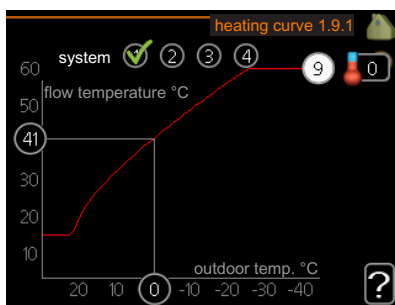

heating curve

Setting range: 0 - 15

Default value: 9

In the menu **heating curve** the so-called heating curve for your house can be viewed. The task of the heating curve is to give an even indoor temperature, regardless of the outdoor temperature, and thereby energy efficient operation. It is from this heating curve that the heat pump's control computer determines the temperature of the water to the heating system, flow line temperature, and therefore the indoor temperature. You can select heating curve and read off how the flow line temperature changes at different outdoor temperatures here.

Curve coefficient

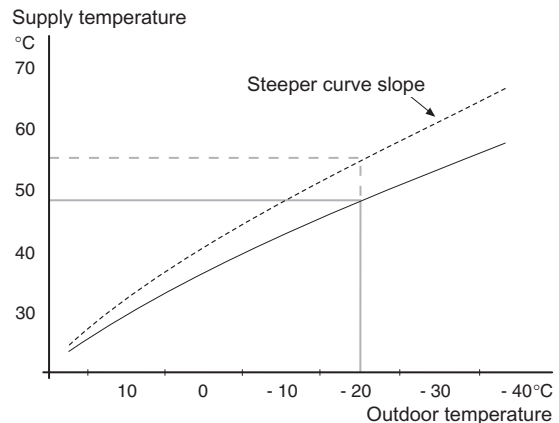

The slope of the heating curve indicates how many degrees the supply temperature is to be increased/reduced when the outdoor temperature drops/increases. A steeper slope means a higher supply temperature at a certain outdoor temperature.

The optimum slope depends on the climate conditions in your location, if the house has radiators or under floor heating and how well insulated the house is.

The heating curve is set when the heating installation is installed, but may need adjusting later. Thereafter the heating curve should not need further adjustment.



Caution

In the event of making fine adjustments for the indoor temperature, the heat curve must be offset up or down instead, this is done in menu 1.1 **temperature**.

Curve offset

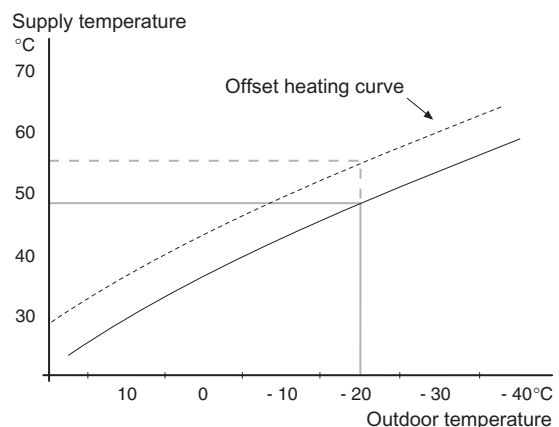

An offset of the heating curve means that the supply temperature changes as much for all the outdoor temperatures, e.g. that a curve offset of +2 steps increases the supply temperature by 5 °C at all outdoor temperatures.

Flow line temperature– maximum and minimum values

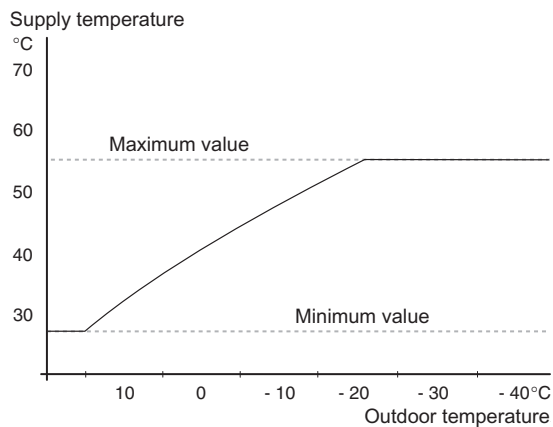

Because the flow line temperature cannot be calculated higher than the set maximum value or lower than the set minimum value the heating curve flattens out at these temperatures.



Caution

Underfloor heating systems are normally **max flow line temperature** set between 35 and 45 °C.

Check the max temperature for your floor with your installer/floor supplier.

The figure at the end of the curve indicates the curve slope. The figure beside the thermometer gives the curve offset. Use the control knob to set a new value. Confirm the new setting by pressing the OK button.

Curve 0 is an own heating curve created in menu 1.9.7.

To select another heat curve (slope):



NOTE

If you only have one heating system, the number of the curve is already marked when the menu window opens.

1. Select the system (if more than one) for which the heat curve is to be changed.
2. When the system selection has been confirmed the heat curve number is marked.
3. Press the OK button to access the setting mode
4. Select a new heating curve. The heat curves are numbered from 0 to 15, the greater the number, the steeper the slope and the greater the supply temperature. Heating curve 0 means that **own curve** (menu 1.9.7) is used.
5. Press the OK button to exit the setting.

To read off a heating curve:

1. Turn the control knob so that the ring on the shaft with the outdoor temperature is marked.
2. Press the OK button.
3. Follow the grey line up to the heat curve and out to the left to read off the value for the supply temperature at the selected outdoor temperature.

4. You can now select to take read outs for different outdoor temperatures by turning the control knob to the right or left and read off the corresponding flow temperature.
5. Press the OK or Back button to exit read off mode.



TIP

Wait 24 hours before making a new setting, so that the room temperature has time to stabilise.

If it is cold outdoors and the room temperature is too low, increase the curve slope by one increment.

If it is cold outdoors and the room temperature is too high, lower the curve slope by one increment.

If it is warm outdoors and the room temperature is too low, increase the curve offset by one increment.

If it is warm outdoors and the room temperature is too high, lower the curve offset by one increment.

Menu 1.9.2 - external adjustment

climate system

Setting range: -10 to +10 or desired room temperature if the room sensor is installed.

Default value: 0

Connecting an external contact, for example, a room thermostat or a timer allows you to temporarily or periodically raise or lower the room temperature. When the contact is on, the heat curve offset is changed by the number of steps selected in the menu. If a room sensor is installed and activated the desired room temperature (°C) is set.

If there is more than one climate system the setting can be made separately for each system.

Menu 1.9.3 - min. flow line temp.

climate system

Setting range: 5-70 °C

Default value: 20 °C

Set the minimum temperature on the supply temperature to the climate system. This means that F1255 never calculates a temperature lower than that set here.

If there is more than one climate system the setting can be made separately for each system.

**TIP**

The value can be increased if you have, for example, a cellar that you always want to heat, even in summer.

You may also need to increase the value in "stop heating" menu 4.9.2 "auto mode setting".

Menu 1.9.4 - room sensor settings**factor system**

Setting range: 0.0 - 6.0

Default value: 2.0

Room sensors to control the room temperature can be activated here.

Here you can set a factor that determines how much the supply temperature is to be affected by the difference between the desired room temperature and the actual room temperature. A higher value gives a greater change of the heating curve's set offset.

If several climate systems are installed the above settings can be made for the relevant systems.

Menu 1.9.5 - cooling settings (accessory required)**min. temp. cooling flow**

Setting range: 5 - 30 °C

Default value: 17

cooling flow temp. at +20°C

Setting range: 5 - 30 °C

Default value: 20

cooling flow temp. at +40°C

Setting range: 5 - 30 °C

Default value: 20

set pt value cool/heat sensor

Setting range: 5 - 40 °C

Default value: 21

heat at room under temp.

Setting range: 0.5 - 10.0 °C

Default value: 1.0

cool at room over temp.

Setting range: 0.5 - 10.0 °C

Default value: 1.0

start passive cooling

Setting range: 10 – 200

Default value: 30

start active cooling

Setting range: 10 – 300

Default value: 90

compressor speed

Setting range: 1 – 100 %

Default value: 1

time betw. switch heat/cool

Setting range: 0 - 48 h

Default value: 2

mixing valve amplifier

Setting range: 0.1 –10.0

Default value: 1.0

mixing valve step delay

Setting range: 10 – 300 s

Default values: 30 s

You can use F1255 to cool the house during hot periods of the year.

min. temp. cooling flow

Set the minimum temperature on the supply temperature to the climate system during cooling operation. This means that F1255 never calculates a temperature lower than that set here.

cooling flow temp. at +20°C

Set the desired temperature on the flow temperature to the climate system during cooling operation when the outdoor temperature is +20 °C. F1255 then attempts to get as close to the set temperature as possible.

cooling flow temp. at +40°C

Set the desired temperature on the flow temperature to the climate system during cooling operation when the outdoor temperature is +40 °C. F1255 then attempts to get as close to the set temperature as possible.

use system 2 in cool mode - use system 4 in cool mode**Caution**

This setting option only appears if "passive/active cooling 2-pipe" or "passive cooling 2-pipe" is activated in menu 5.2.4.

Here you select whether you want to use climate system 2 - 4 in cooling mode (if there is more than one). If this function is activated, you can set "cooling flow temp. at +20°C" and "cooling flow temp. at +40°C" for each climate system where the function is activated.

use room sensor

Here you can set whether room temperature sensors are to be used in cooling mode.

set pt value cool/heat sensor



Caution

This setting option only appears if sensors for cooling/heating (BT74) are installed and activated in F1255.

Here you can set at which indoor temperature F1255 is to shift between heating respectively cooling operation.

heat at room under temp.



Caution

This setting option only appears if a room temperature sensor is connected to F1255 and has been activated.

Here you can set how far the room temperature can drop below the desired temperature before F1255 switches to heating operation.

start passive cooling



Caution

This setting option only appears if "passive/active cooling" is activated in menu 5.2.4.

Here you can set when passive cooling is to start.

Degree minutes are a measurement of the current heating demand in the house and determine when the compressor, cooling operation respectively additional heat will start/stop.

start active cooling



Caution

This setting option only appears if "passive/active cooling" is activated in menu 5.2.4.

Here you can set when active cooling is to start.

Degree minutes are a measurement of the current heating demand in the house and determine when the compressor, cooling operation respectively additional heat will start/stop.

compressor speed



Caution

This setting option only appears if passive/active cooling is activated in menu 5.2.4.

Here you can set at what speed the compressor is to operate at during active cooling. Set value corresponds to part of the available output (see diagram, page 69).

cool at room over temp.



Caution

This setting option only appears if a room temperature sensor is connected to F1255 and has been activated.

Here you can set how high the room temperature can increase above the desired temperature before F1255 switches to cooling operation.

time betw. switch heat/cool

Here you can set how long F1255 is to wait before it returns to heating mode when the cooling demand has ceased or vice versa.

close mix. valves in cool mode



Caution

This setting option only appears if passive cooling is activated in menu 5.2.4.

If the heat pump is connected to more than one climate system condensation may occur in these if they are not intended for cooling.

To avoid this check "close mix. valves in cool mode", which means that the sub-shunts for the extra climate systems close when cooling operation is activated.

mixing valve amplifier and mixing valve step delay



Caution

This setting option only appears if passive cooling is activated in menu 5.2.4.

Shunt reinforcement and shunt wait time for the cooling system are set here.

Menu 1.9.6 - fan return time (accessory required)

speed 1-4

Setting range: 1 – 99 h

Default value: 4 h

Here you select the return time for temporary speed change (speed 1-4) on the ventilation in menu 1.2.

Return time is the time it takes before ventilation speed returns to normal.

Menu 1.9.7 - own curve

supply temperature

Setting range: 0 – 80 °C

You can create your own heating curve here, if there are special requirements, by setting the desired supply temperatures for different outdoor temperatures.



Caution

Curve 0 in menu 1.9.1 must be selected for this curve to apply.

Menu 1.9.8 - point offset

outdoor temp. point

Setting range: -40 – 30 °C

Default value: 0 °C

change in curve

Setting range: -10 – 10 °C

Default value: 0 °C

Select a change in the heating curve at a certain outdoor temperature here. One step is usually enough to change the room temperature by one degree, but in some cases several steps may be required.

The heat curve is affected at ± 5 °C from set outdoor temp. point.

It is important that the correct heating curve is selected so that the room temperature is experienced as even.



TIP

If it is cold in the house, at, for example -2 °C, "outdoor temp. point" is set to "-2" and "change in curve" is increased until the desired room temperature is maintained.



Caution

Wait 24 hours before making a new setting, so that the room temperature has time to stabilise.

Menu 1.9.9 - night cooling (accessory required)

start temp. exhaust air

Setting range: 20 – 30 °C

Default value: 25 °C

min diff. outdoor-exhaust

Setting range: 3 – 10 °C

Default value: 6 °C

Activate night cooling here.

When the temperature in the house is high and the outdoor temperature is lower, a cooling effect can be obtained by forcing the ventilation.

If the temperature difference between the exhaust air and the outdoor air temperature is greater than the set value ("min diff. outdoor-exhaust") and the exhaust air temperature is higher than the set value ("start temp. exhaust air") run the ventilation at speed 4 until one of the conditions is no longer met.



Caution

Night cooling can only be activated when house heating has been deactivated. This is done in menu 4.2.

Menu 2 - HOT WATER

Overview

2 - HOT WATER	2.1 - temporary lux	
	2.2 - comfort mode	
	2.3 - scheduling	
	2.9 - advanced	2.9.1 - periodic increases
		2.9.2 - hot water recirc.

Sub-menus

For the menu **HOT WATER** there are several sub-menus. Status information for the relevant menu can be found on the display to the right of the menus.

temporary lux Activation of temporary increase in the hot water temperature. Status information displays "off" or what length of time of the temporary temperature increase remains.

comfort mode Setting hot water comfort. The status information displays what mode is selected, "economy", "normal" or "luxury".

scheduling Scheduling hot water comfort. Status information "set" displays if any part of the schedule is active at present, "holiday setting" displays if vacation setting is in progress (menu 4.7), otherwise it displays "off".

advanced Setting periodic increase in the hot water temperature.

in smaller households with a small hot water requirement.

normal: Normal mode gives a larger amount of hot water and is suitable for most households.

luxury: Lux mode gives the greatest possible amount of hot water. In this mode the immersion heater may be partially used to heat hot water, which may increase operating costs.

Menu 2.3 - scheduling

What hot water comfort the heat pump is to work with can be scheduled here for up to two different time periods per day.

Scheduling is activated/deactivated by ticking/unticking "activated". Set times are not affected at deactivation.

Menu 2.1 - temporary lux

Setting range: 3, 6 and 12 hours and mode "off"
Default value: "off"

When hot water requirement has temporarily increased this menu can be used to select an increase in the hot water temperature to lux mode for a selectable time.



Caution

If comfort mode "luxury" is selected in menu 2.2 no further increase can be carried out.

The function is activated immediately when a time period is selected and confirmed using the OK button. The remaining time for the selected setting is shown to the right.

When the time has run out F1255 returns to the mode set in menu 2.2.

Select "off" to switch off **temporary lux**.

Menu 2.2 - comfort mode

Setting range: economy, normal, luxury
Default value: normal

The difference between the selectable modes is the temperature of the hot tap water. Higher temperature means that the hot water lasts longer.

economy: This mode gives less hot water than the other, but is more economical. This mode can be used

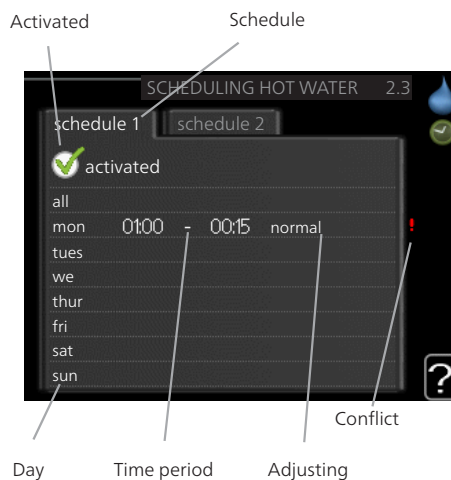

Schedule: The schedule to be changed is selected here.

Activated: Scheduling for the selected period is activated here. Set times are not affected at deactivation.

Day: Select which day or days of the week the schedule is to apply to here. To remove the scheduling for a particular day, the time for that day must be reset by setting the start time to the same as the stop time. If the line "all" is used, all days in the period are set for these times.

Time period: The start and stop time for the selected day for scheduling are selected here.

Adjusting: Set the hot water comfort that is to apply during scheduling here.

Conflict: If two settings conflict with each other a red exclamation mark is displayed.

**TIP**

If you wish to set similar scheduling for every day of the week start by filling in "all" and then changing the desired days.

**Caution**

If the stop time is earlier in the day than the start time it means that the period extends past midnight.

Scheduling always starts on the date that the start time is set for.

Menu 2.9 - advanced

Menu **advanced** has orange text and is intended for the advanced user. This menu has several sub-menus.

Menu 2.9.1 - periodic increases

period

Setting range: 1 - 90 days

Default value: 14 days

start time

Setting range: 00:00 - 23:00

Default value: 00:00

To prevent bacterial growth in the water heater, the compressor and the immersion heater can increase the hot water temperature for a short time at regular intervals.

The length of time between increases can be selected here. The time can be set between 1 and 90 days. Factory setting is 14 days. Untick "activated" to switch off the function.

Menu 2.9.2 - hot water recirc.

operating time

Setting range: 1 - 60 min

Default value: 60 min

downtime

Setting range: 0 - 60 min

Default value: 0 min

Set the hot water circulation for up to three periods per day here. During the set periods the hot water circulation pump will run according to the settings above.

"operating time" decide how long the hot water circulation pump must run per operating instance.

"downtime" decide how long the hot water circulation pump must be stationary between operating instances.

Menu 3 - INFO

Overview

3 - INFO	3.1 - service info
	3.2 - compressor info
	3.3 - add. heat info
	3.4 - alarm log
	3.5 - indoor temp. log

Sub-menus

For the menu **INFO** there are several sub-menus. No settings can be made in these menus, they just display information. Status information for the relevant menu can be found on the display to the right of the menus.

service info shows temperature levels and settings in the installation.

compressor info shows operating times, number of starts etc for the compressor in the heat pump.

add. heat info displays information about the addition's operating times etc.

alarm log displays the latest alarm and information about the heat pump when the alarm occurred.

indoor temp. log the average temperature indoors week by week during the past year.







Menu 3.1 - service info

Information about the heat pump's actual operating status (e.g. current temperatures etc.) can be obtained here. No changes can be made.

The information is on several pages. Turn the control knob to scroll between the pages.

A QR code appears on one side. This QR code indicates serial number, product name and limited operating data.

Symbols in this menu:

	Compressor		Heating
	Addition		Hot water
	Brine pump (blue)		Heating medium pump (orange)
	Cooling		Pool
	Ventilation		

Menu 3.2 - compressor info

Information about the compressor's operating status and statistics can be obtained here. No changes can be made.

The information is on several pages. Turn the control knob to scroll between the pages.

Menu 3.3 - add. heat info

Information about the additional heat settings, operating status and statistics can be obtained here. No changes can be made.

The information is on several pages. Turn the control knob to scroll between the pages.

Menu 3.4 - alarm log

To facilitate fault-finding the heat pump operating status at alarm alerts is stored here. You can see information for the 10 most recent alarms.

To view the run status in the event of an alarm, mark the alarm and press the OK button.

Menu 3.5 - indoor temp. log

Here you can see the average temperature indoors week by week during the past year. The dotted line indicates the annual average temperature.

The average outdoor temperature is only shown if a room temperature sensor/room unit is installed.

Otherwise, if an exhaust air module (NIBE FLM) is installed, the exhaust air temperature is shown.

To read off an average temperature

1. Turn the control knob so that the ring on the shaft with the week number is marked.
2. Press the OK button.
3. Follow the grey line up to the graph and out to the left to read off the average indoor temperature at the selected week.
4. You can now select to take read outs for different weeks by turning the control knob to the right or left and read off the average temperature.
5. Press the OK or Back button to exit read off mode.

Menu 4 - HEAT PUMP

Overview

4 - HEAT PUMP	4.1 - plus functions *	4.1.1 - pool *	
		4.1.3 - internet	4.1.3.1 - nibe uplink
			4.1.3.8 - tcp/ip settings
			4.1.3.9 - proxy settings
		4.1.4 - sms *	
		4.1.5 - SG Ready	
	4.2 - op. mode		
	4.3 - my icons		
	4.4 - time & date		
	4.6 - language		
	4.7 - holiday setting		
	4.9 - advanced	4.9.1 - op. prioritisation	
		4.9.2 - auto mode setting	
		4.9.3 - degree minute setting	
		4.9.4 - factory setting user	
		4.9.5 - schedule blocking	

* Accessory needed.

Sub-menus

For the menu **HEAT PUMP** there are several sub-menus. Status information for the relevant menu can be found on the display to the right of the menus.

plus functions Settings applying to any installed extra functions in the heating system.

op. mode Activation of manual or automatic operating mode. The status information shows the selected operating mode.

my icons Settings regarding which icons in the heat pump's user interface that are to appear in the slot when the door is closed.

time & date Setting current time and date.

language Select the language for the display here. The status information shows the selected language.

holiday setting Vacation scheduling heating, hot water and ventilation. Status information "set" is displayed if you set a vacation schedule but it is not active at the moment, "active" is displayed if any part of the vacation schedule is active, otherwise it displays " off".

advanced Setting heat pump work mode.

Menu 4.1 - plus functions

Settings for any additional functions installed in F1255 can be made in the sub menus.

Menu 4.1.1 - pool (accessory is required)

start temp

Setting range: 5.0 - 80.0 °C

Default value: 22.0 °C

stop temperature

Setting range: 5.0 - 80.0 °C

Default value: 24.0 °C

compressor speed

Setting range: 1 – 100 %

Default value: 1

Select whether the pool control is to be activated and within what temperatures (start and stop temperature) pool heating must occur.

Here you can also set at what speed the compressor is to operate during pool heating. Set value corresponds to part of the available output (see diagram, page 69).

When the pool temperature drops below the set start temperature and there is no hot water or heating requirement, F1255 starts pool heating.

Untick "activated" to switch off the pool heating.



Caution

The start temperature cannot be set to a value that is higher than the stop temperature.

Menu 4.1.3 - internet

Here you make settings for connecting F1255 to the internet.

**NOTE**

For these functions to work the network cable must be connected.

Menu 4.1.3.1 - nibe uplink

Here you can manage the installation's connection to NIBE Uplink™ (<http://www.nibeuplink.com>) and see the number of users connected to the installation via the internet.

A connected user has a user account in NIBE Uplink™ which have been given permission to control and/or monitor your installation.

Request new connection string

To connect a user account on NIBE Uplink™ to your installation, you must request a unique connection string.

1. Mark "request new connection string" and press the OK button.
2. The installation now communicates with NIBE Uplink™ to create a connection string.
3. When a connection string has been received, it is shown in this menu at "connection string" and is valid for 60 minutes.

Disconnect all users

1. Mark "switch off all users" and press the OK button.
2. The installation now communicates with NIBE Uplink™ to release your installation from all connected users via the internet.

**NOTE**

After disconnecting all users none of them can monitor or control your installation via NIBE Uplink™ without requesting a new connection string.

Menu 4.1.3.8 - tcp/ip settings

You can set TCP/IP settings for your installation here.

Automatic setting (DHCP)

1. Tick "automatic". The installation now receives the TCP/IP settings using DHCP.
2. Mark "confirm" and press the OK button.

Manual setting

1. Untick "automatic", you now have access to several setting options.
2. Mark "ip-address" and press the OK button.
3. Enter the correct details via the virtual keypad.
4. Mark "OK" and press the OK button.
5. Repeat 1 - 3 for "net mask", "gateway" and "dns".
6. Mark "confirm" and press the OK button.

**Caution**

The installation cannot connect to the internet without the correct TCP/IP settings. If unsure about applicable settings use the automatic mode or contact your network administrator (or similar) for further information.

**TIP**

All settings made since opening the menu can be reset by marking "reset" and pressing the OK button.

Menu 4.1.3.9 - proxy settings

You can set proxy settings for your installation here.

Proxy settings are used to give connection information to a intermediate server (proxy server) between the installation and Internet. These settings are primarily used when the installation connects to the Internet via a company network. The installation supports proxy authentication of the HTTP Basic and HTTP Digest type.

If unsure about applicable settings use the preset settings or contact your network administrator (or similar) for further information.

Setting

1. Tick "use proxy" if you do not want to use a proxy.
2. Mark "server" and press the OK button.
3. Enter the correct details via the virtual keypad.
4. Mark "OK" and press the OK button.
5. Repeat 1 - 3 for "port", "user name" and "password".
6. Mark "confirm" and press the OK button.

**TIP**

All settings made since opening the menu can be reset by marking "reset" and pressing the OK button.

Menu 4.1.4 - sms (accessory is required)

Make settings for the accessory SMS 40 here.

Add the mobile numbers that are to have access to change and receive status information from the heat pump. Mobile numbers must include country code e.g. +46 XXXXXXXX.

If you want to receive an SMS message in the event of the alarm mark the box to the right of the telephone number.

**NOTE**

Telephone numbers provided must be able to receive SMS messages.

Menu 4.1.5 - SG Ready

This function can only be used in mains networks that support the "SG Ready"-standard (Germany).

Make settings for the function "SG Ready" here.

affect room temperature

Here you set whether room temperature should be affected when activating "SG Ready".

With low price mode of "SG Ready" the parallel offset of the indoor temperature is increased by "+1". If a room sensor is installed and activated, the desired room temperature increases by 1 °C.

With over capacity mode of "SG Ready" the parallel offset for the indoor temperature is increased by "+2". If a room sensor is installed and activated, the desired room temperature increases by 2 °C.

affect hot water

Here you set whether the temperature of the hot water should be affected when activating "SG Ready".

With low price mode on "SG Ready" the stop temperature of the hot water is set as high as possible at only compressor operation (immersion heater not permitted).

With over capacity mode of "SG Ready" the hot water is set to "luxury" (immersion heater permitted).

affect cooling (accessories required)

Here you set whether room temperature during cooling operation should be affected when activating "SG Ready".

With low price mode of "SG Ready" and cooling operation the indoor temperature is not affected.

With over capacity mode of "SG Ready" and cooling operation the parallel offset for the indoor temperature is reduced by "-1". If a room sensor is installed and activated, the desired room temperature decreases by 1 °C.

affect pool temperature (accessories required)

Here you set whether pool temperature should be affected when activating "SG Ready".

With low price mode of "SG Ready" the desired pool temperature (start and stop temperature) is increased by 1 °C.

With over capacity mode of "SG Ready" the desired pool temperature (start and stop temperature) is increased by 2 °C.



NOTE

The function must be connected to two AUX inputs and activated in menu 5.4.

Menu 4.2 - op. mode

op. mode

Setting range: auto, manual, add. heat only

Default value: auto

functions

Setting range: compressor, addition, heating, cooling

The heat pump operating mode is usually set to "auto". It is also possible to set the heat pump to "add. heat

only", but only when an addition is used, or "manual" and select yourself what functions are to be permitted.

Change the operating mode by marking the desired mode and pressing the OK button. When an operating mode is selected it shows what in the heat pump is permitted (crossed out = not permitted) and selectable alternatives to the right. To select selectable functions that are permitted or not you mark the function using the control knob and press the OK button.

Operating mode auto

In this operating mode the heat pump automatically selects what functions are permitted.

Operating mode manual

In this operating mode you can select what functions are permitted. You cannot deselect "compressor" in manual mode.

Operating mode add. heat only

In this operating mode the compressor is not active and only additional heating is used.



Caution

If you choose mode "add. heat only" the compressor is deselected and there is a higher operating cost.

Functions

"**compressor**" is that which produces heating and hot water for the accommodation. If "compressor" is deselected, a symbol in the main menu on the heat pump symbol is displayed. You cannot deselect "compressor" in manual mode.

"**addition**" is what helps the compressor to heat the accommodation and/or the hot water when it cannot manage the whole requirement alone.

"**heating**" means that you get heat in the accommodation. You can deselect the function when you do not wish to have heating running.

"**cooling**" means that you get cooling in the accommodation in hot weather. You can deselect the function when you do not wish to have the cooling running. This alternative requires an accessory for cooling or if the heat pump has a built in function for cooling.



Caution

If you deselect "addition" it may mean that sufficient heating in the accommodation is not achieved.

Menu 4.3 - my icons

You can select what icon should be visible when the door to F1255 is closed. You can select up to 3 icons. If you select more, the ones you selected first will disappear. The icons are displayed in the order you selected them.

Menu 4.4 - time & date

Set time and date, display mode and time zone here.



TIP

Time and date are set automatically if the heat pump is connected to NIBE Uplink™. To obtain the correct time, the time zone must be set.

Menu 4.6 - language

Choose the language that you want the information to be displayed in here.

Menu 4.7 - holiday setting

To reduce energy consumption during a holiday you can schedule a reduction in heating and hot water temperature. Cooling, ventilation and pool can also be scheduled if the functions are connected.

If a room sensor is installed and activated the desired room temperature (°C) is set during the time period. This setting applies to all climate systems with room sensors.

If a room sensor is not activated, the desired offset of the heating curve is set. This setting applies to all climate systems without room sensors. One step is usually enough to change the room temperature by one degree, but in some cases several steps may be required.

Vacation scheduling starts at 00:00 on the start date and stops at 23:59 on the stop date.



TIP

Complete holiday setting about a day before your return so that room temperature and hot water have time to regain usual levels.



TIP

Set the vacation setting in advance and activate just before departure in order to maintain the comfort.



Caution

If you choose to switch off hot water production during the vacation "periodic increases" (preventing bacterial growth) are blocked during this time. "periodic increases" started in conjunction with the vacation setting being completed.

Menu 4.9 - advanced

Menu **advanced** has orange text and is intended for the advanced user. This menu has several sub-menus.

Menu 4.9.1 - op. prioritisation

op. prioritisation

Setting range: 0 to 180 min

Default value: 30 min

Choose here how long the heat pump should work with each requirement if there are two or more requirements at the same time. If there is only one requirement the heat pump only works with that requirement.

The indicator marks where in the cycle the heat pump is.

If 0 minutes is selected it means that requirement is not prioritised, but will only be activated when there is no other requirement.

Menu 4.9.2 - auto mode setting

start cooling

Setting range: -20 – 40 °C

Default value: 25

stop heating

Setting range: -20 – 40 °C

Default values: 20

stop additional heat

Setting range: -25 – 40 °C

Default values: 15

filtering time

Setting range: 0 – 48 h

Default value: 24 h

When operating mode is set to "auto" the heat pump selects when start and stop of additional heat and heat production is permitted, dependent on the average outdoor temperature. If accessories for cooling are present or if the heat pump has the integrated cooling function you can also select the start temperature for cooling.

Select the average outdoor temperatures in this menu.

You can also set the time over which (filtering time) the average temperature is calculated. If you select 0, the present outdoor temperature is used.



Caution

It cannot be set "stop additional heat" higher than "stop heating".



Caution

In systems where heating and cooling share the same pipes "stop heating" cannot be set higher than "start cooling".

Menu 4.9.3 - degree minute setting

current value

Setting range: -3000 – 3000

start compressor

Setting range: -1000 – -30

Default value: -60

start diff additional heat

Setting range: 100 – 1000

Default value: 400

diff. between additional steps

Setting range: 0 – 1000

Default value: 100

Degree minutes are a measurement of the current heating requirement in the house and determine when the compressor respectively additional heat will start/stop.



Caution

Higher value on "start compressor" gives more compressor starts, which increases wear in the compressor. Too low value can give uneven indoor temperatures.

Menu 4.9.4 - factory setting user

All settings that are available to the user (including advanced menus) can be reset to default values here.



Caution

After factory setting, personal settings such as heating curves must be reset.

Menu 4.9.5 - schedule blocking

The compressor can be scheduled to be blocked for up to two different time periods here.

When scheduling is active the actual blocking symbol in the main menu on the heat pump symbol is displayed.

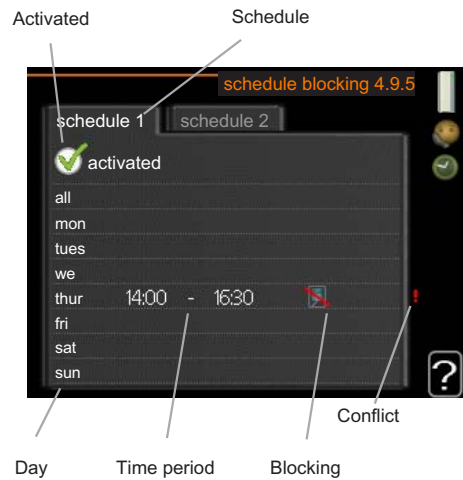

Schedule: The period to be changed is selected here.

Activated: Scheduling for the selected period is activated here. Set times are not affected at deactivation.

Day: Select which day or days of the week the schedule is to apply to here. To remove the scheduling for a particular day, the time for that day must be reset by setting the start time to the same as the stop time. If the line "all" is used, all days in the period are set for these times.

Time period: The start and stop time for the selected day for scheduling are selected here.

Blocking: The desired blocking is selected here.

Conflict: If two settings conflict with each other a red exclamation mark is displayed.



Blocking the compressor.



Blocking additional heat.



TIP

If you wish to set similar scheduling for every day of the week start by filling in "all" and then changing the desired days.



Caution

If the stop time is before the start time it means that the period extends past midnight. Scheduling always starts on the date that the start time is set for.



Caution

Long term blocking can cause reduced comfort and operating economy.

Menu 5 - SERVICE

Overview

5 - SERVICE	5.1 - operating settings	5.1.1 - hot water settings
		5.1.2 - max flow line temperature
		5.1.3 - max diff flow line temp.
		5.1.4 - alarm actions
		5.1.5 - fan sp. exhaust air *
		5.1.7 - br pmp al set.
		5.1.8 - operating mode brine pump
		5.1.9 - brine pump speed
		5.1.10 - op. mod heat med pump
		5.1.11 - pump speed heating medium
		5.1.12 - internal electrical addition
		5.1.14 - flow set. climate system
		5.1.22 - heat pump testing
	5.2 - system settings	
	5.3 - accessory settings	5.3.1 - FLM *
		5.3.2 - shunt controlled add. heat *
		5.3.3 - extra climate system *
		5.3.6 - step controlled add. heat *
	5.4 - soft in/outputs	
	5.5 - factory setting service	
	5.6 - forced control	
	5.7 - start guide	
	5.8 - quick start	
	5.9 - floor drying function	
	5.10 - change log	

* Accessory needed.

Hold the Back button in for 7 seconds to access the Service menu.

Sub-menus

Menu **SERVICE** has orange text and is intended for the advanced user. This menu has several sub-menus. Status information for the relevant menu can be found on the display to the right of the menus.

operating settings Operating settings for the heat pump.

system settings System settings for the heat pump, activating accessories etc.

accessory settings Operational settings for different accessories.

soft in/outputs Setting software controlled in and outputs on the input circuit board (AA3).

factory setting service Total reset of all settings (including settings available to the user) to default values.

forced control Forced control of the different components in the heat pump.

start guide Manual start of the start guide which is run the first time the heat pump is started.

quick start Quick starting the compressor.



NOTE

Incorrect settings in the service menus can damage the heat pump.

Menu 5.1 - operating settings

Operating settings can be made for the heat pump in the sub menus.

Menu 5.1.1 - hot water settings

start temp. economy / normal / lux

Setting range: 5 – 70 °C

Factory setting (°C):

stop temp. economy / normal / lux

Setting range: 5 – 70 °C

Factory setting (°C):

stop temp. per. increase

Setting range: 55 – 70 °C

Default values: 55 °C

Here you set the start and stop temperature of the hot water for the different comfort options in menu 2.2 as well as the stop temperature for periodic increase in menu 2.9.1.

Menu 5.1.2 - max flow line temperature

climate system

Setting range: 5-70 °C

Default value: 60 °C

Set the maximum supply temperature for the climate system here. If the installation has more than one climate system, individual maximum flow temperatures can be set for each system.



Caution

Underfloor heating systems are normally **max flow line temperature** set between 35 and 45 °C.

Check the max floor temperature with your floor supplier.

Menu 5.1.3 - max diff flow line temp.

max diff compressor

Setting range: 1 – 25 °C

Default value: 10 °C

max diff addition

Setting range: 1 – 24 °C

Default value: 7 °C

Here you set the maximum permitted difference between the calculated and actual supply temperature during compressor respectively add. heat mode.

max diff compressor

When the current supply temperature **deviates** from the set value compared to that calculated, the heat

pump is forced to stop irrespective of the degree-minute value.

If the current supply temperature **exceeds** the calculated flow with set value, the degree minute value is set to 0. The compressor in the heat pump stops when there is only a heating demand.

max diff addition

If "addition" is selected and activated in menu 4.2 and the present supply temp **exceeds** the calculated with set value, the additional heat is forced to stop.

Menu 5.1.4 - alarm actions

Select how you want the heat pump to alert you that there is an alarm in the display here.

The different alternatives are that the heat pump stops producing hot water (default setting) and/or reduces the room temperature.



Caution

If no alarm action is selected, it can result in higher energy consumption in the event of an alarm.

Menu 5.1.5 - fan sp. exhaust air (accessory is required)

normal and speed 1-4

Setting range: 0 – 100 %

Set the speed for the five different selectable speeds for the fan here.



Caution

An incorrectly set ventilation flow can damage the house and may also increase energy consumption.

Menu 5.1.7 - br pmp al set.

min. brine out

Setting range: -12 – 15 °C

Default value: -8 °C

max brine in

Setting range: 10 – 30 °C

Default value: 20 °C

min. brine out

Set the temperature at which the heat pump is to activate the alarm for low temperature in outgoing brine. If "automatic reset" is selected, the alarm resets when the temperature has increased by 1 °C below the set value.

max brine in

Set the temperature at which the heat pump is to activate the alarm for high temperature in incoming brine.

Select "alarm activated" to activate the alarm.

Menu 5.1.8 - operating mode brine pump

op. mode

Setting range: intermittent, continuous, 10 days continuous

Default value: intermittent

Set the operating mode of the brine pump here.

intermittent: The brine pump starts approx. 20 seconds before and stops approx. 20 seconds after the compressor.

continuous: Continuous operation.

10 days continuous: Continuous operation for 10 days. Then the pump shifts to intermittent operation.



TIP

You can use "10 days continuous" at start-up to obtain continuous circulation during a start-up time in order to make it easier to bleed the system.

Menu 5.1.9 - brine pump speed

brine pump speed

Setting range: auto / manual

Default value: auto

Manual setting

Setting range: 1 - 100 %

Default values: 100 %

Manual setting, passive cooling

Setting range: 1 - 100 %

Default values: 75 %

Set the speed of the brine pump here. Select "auto" if the speed of the brine pump is to be regulated automatically (factory setting) for optimal operation.

For manual operation of the brine pump deactivate "auto" and set the value to between 0 and 100%.

If there are accessories for cooling present or if the heat pump has a built-in function for cooling you can also set the brine pump speed during passive cooling operation (the brine pump then runs in manual operation).

Menu 5.1.10 - op. mod heat med pump

op. mode

Setting range: auto, intermittent,

Default value: auto

Set the operating mode of the heating medium pump here.

auto: The heating medium pump runs according to the current operating mode for F1255.

intermittent: The heating medium pump starts 20 seconds before and stops at the same time as the compressor.

Menu 5.1.11 - pump speed heating medium

Operating status

Setting range: auto / manual

Default value: auto

Manual setting

Setting range: 1 - 100 %

Default values: 70 %

max. allowed speed

Setting range: 50 - 100 %

Default values: 100 %

wait mode

Setting range: 1 - 100 %

Default values: 30 %

speed active cooling

Setting range: 1 - 100 %

Default values: 70 %

speed passive cooling

Setting range: 1 - 100 %

Default values: 70 %

Set the speed at which the heating medium pump is to operate in the present operating mode. Select "auto" if the speed of the heating medium pump is to be regulated automatically (factory setting) for optimal operation.

If "auto" is activated for heating operation, you can also make the setting "max. allowed speed" which restricts the heating medium pump and does not allow it to run at a higher speed than the set value.

For manual operation of the heating medium pump deactivate "auto" for the current operating mode and set the value to between 0 and 100% (the previously set value for "max. allowed speed" no longer applies).

"heating" means operating mode heating for the heating medium pump.

"wait mode" means heating or cooling operating modes for the heating medium pump but when the heat pump has neither a need for compressor operation nor electrical addition and slows down.

"hot water" means operating mode hot water for the heating medium pump.

"pool" means operating mode pool heating for the heating medium pump.

"cooling" means operating mode cooling for the heating medium pump.

If there are accessories for cooling present or if the heat pump has a built-in function for cooling you can also set the heating medium pump speed during active respectively cooling operating modes (the heating medium pump then runs in manual operation).

Menu 5.1.12 - internal electrical addition

max connected el. add.

Setting range: 7 / 9

Factory setting: 7 kW

set max electrical add.

Setting range: 0 - 9 kW

Default values: 6 kW

fuse size

Setting range: 1 - 200 A

Default values: 16 A

Here you set the max. electrical output of the internal electrical addition in F1255 and the fuse size for the installation.

Here you can also check which current sensor is installed on which incoming phase to the property (this requires current sensors to be installed, see page 22). This is achieved by marking "detect phase order" and pressing the OK button.

The results of these checks appear just below where the checks were activated.

Menu 5.1.14 - flow set. climate system

presettings

Setting range: radiator, floor heat., rad. + floor heat., DOT °C

Default value: radiator

Setting range DOT: -40,0 - 20,0 °C

Factory setting DOT: -18,0 °C

own setting

Setting range dT at DOT: 0,0-25,0

Factory setting dT at DOT: 10,0

Setting range DOT: -40,0 - 20,0 °C

Factory setting DOT: -18,0 °C

The type of heating distribution system the heating medium pump (GP1) works towards is set here.

dT at DOT is the difference in degrees between flow and return temperatures at dimensioned outdoor temperature.

Menu 5.1.22 - heat pump testing



NOTE

This menu is intended for testing F1255 according to different standards.

Use of this menu for other reasons may result in your installation not functioning as intended.

This menu contains several sub-menus, one for each standard.

Menu 5.3 - accessory settings

The operating settings for accessories that are installed and activated are made in the sub-menus for this.

Menu 5.3.1 - FLM

time between defrosts

Setting range: 1 – 30 h

Default value: 10 h

months btwn filter alarms

Setting range: 1 – 12

Default value: 3

continuous pump op.: Select for continuous operation of the circulation pump in the exhaust air module.

time between defrosts: Set the minimum time that must pass between defrostings of the heat exchanger in the exhaust air module.

When the exhaust air module is in operation the heat exchanger is cooled so that ice builds up on it. When too much ice builds up the heat transfer capacity of the heat exchanger is reduced and defrosting is required. Defrosting warms up the heat exchanger so that the ice melts and runs off via the condensation hose.

months btwn filter alarms: Set how many months should pass before the heat pump informs that it is time to clean the filter in the exhaust air module.

Clean the exhaust air module's air filter regularly, how often depends on the amount of dust in the ventilation air.

activate cooling: Activate cooling via the exhaust air module here. When the function has been activated, the cooling settings are displayed in the menu system.

Menu 5.3.2 - shunt controlled add. heat

start addition

Setting range: -2000 – -30 GM

Default values: -400 GM

minimum running time

Setting range: 0 – 48 h

Default value: 12 h

min temp.

Setting range: 5 – 90 °C

Default value: 55 °C

mixing valve amplifier

Setting range: 0.1 – 10.0

Default value: 1.0

mixing valve step delay

Setting range: 10 – 300 s

Default values: 30 s

Set when the addition is to start, the minimum run time and the minimum temperature for external addition with shunt here. External addition with shunt is then for example wood/oil/gas/pellet boiler.

For the shunt you can set shunt amplification and shunt waiting time.

See the accessory installation instructions for function description.

Menu 5.3.3 - extra climate system

mixing valve amplifier

Setting range: 0.1 – 10.0

Default value: 1.0

mixing valve step delay

Setting range: 10 – 300 s

Default values: 30 s

Set the shunt amplification and shunt waiting time for the different extra climate systems that are installed.

See the accessory installation instructions for function description.

Menu 5.3.6 - step controlled add. heat

start addition

Setting range: -2000 – -30 GM

Default values: -400 GM

diff. between additional steps

Setting range: 0 – 1000 GM

Default values: 100 GM

max step

Setting range
(binary stepping deactivated): 0 – 3

Setting range
(binary stepping activated): 0 – 7

Default value: 3

Make settings for step controlled addition here. Step controlled addition is for example an external electric boiler.

It is possible, for example, to select when the additional heat is to start, to set the maximum number of permitted steps and whether binary stepping is to be used.

See the accessory installation instructions for function description.

Menu 5.4 - soft in/outputs

Here you can select which in/output on the input circuit board (AA3) the external contact function (page 22) is to be connected to.

Selectable inputs on terminal block AUX1-5 (AA3-X6:9-18) and output AA3-X7 (on the input circuit board).

Menu 5.5 - factory setting service

All settings can be reset (including settings available to the user) to default values here.



NOTE

When resetting, the start guide is displayed the next time the heat pump is restarted.

Menu 5.6 - forced control

You can force control the different components in the heat pump and any connected accessories here.

Menu 5.7 - start guide

When the heat pump is started for the first time the start guide starts automatically. Start it manually here.

See page 27 for more information about the start guide.

Menu 5.8 - quick start

It is possible to start the compressor from here.



Caution

There must be a heating or hot water demand to start the compressor.



Caution

Do not quick start the compressor too many times in succession over a short period of time as this may damage the compressor and its ancillary equipment.

Menu 5.9 - floor drying function

length of period 1 - 3, 5-7

Setting range: 0 - 30 days

Default value: 2 days

temp. period 1 - 3, 5-7

Setting range: 15 - 70 °C

Default value:

temp. period 1 20 °C

temp. period 2 30 °C

temp. period 3 40 °C

temp. period 5 40 °C

temp. period 6 30 °C

temp. period 7 20 °C

length of period 4

Setting range: 0 - 30 days

Default value: 3 days

temp. period 4

Setting range: 15 - 70 °C

Default value: 45 °C

Set the function for under floor drying here.

You can set up to seven period times with different calculated flow temperatures. If less than seven periods are to be used, set the remaining period times to 0 days.

Mark the active window to activate the under floor drying function. A counter at the bottom shows the number of days the function has been active. The function counts degree minutes as during normal heating operation but for the flow temperatures that are set for the respective period.



NOTE

During floor drying the heating medium pump in 100% runs regardless of the setting in menu 5.1.10.



TIP

If operating mode "add. heat only" is to be used, select it in menu 4.2.

For a more even flow temperature the addition can be started earlier by setting "start for addition" in menus 4.9.2 to -80. When set under floor drying periods have stopped, reset the menus 4.2 and 4.9.2 as per previous settings.

Menu 5.10 - change log

Read off any previous changes to the control system here.

The date, time and ID no. (unique to certain settings) and the new set value is shown for every change.



NOTE

The change log is saved at restart and remains unchanged after factory setting.

9 Service

Service actions

NOTE
 Servicing should only be carried out by persons with the necessary expertise.
 When replacing components on F1255 only replacement parts from NIBE may be used.

Emergency mode

NOTE
 Switch (SF1) must not be moved to "I" or "Δ" until F1255 has been filled with water. Otherwise the temperature limiter, thermostat, compressor and the immersion heater can be damaged.

Emergency mode is used in event of operational interference and in conjunction with service. Hot water is not produced in emergency mode.

Activate emergency mode by setting the switch (SF1) to "Δ" (press the button on the switch and move it to the right). This means that:

- The status lamp illuminates yellow.
- The display is not lit and the control computer is not connected.
- The temperature at the immersion heater is controlled by the thermostat (FD1-BT30). It can be set either to 35 or 45 °C.
- The compressor and the brine system are off and only the heating medium pump and the electrical addition are active. The addition power in emergency mode is set in the immersion heater card (AA1). See page 21 for instructions.

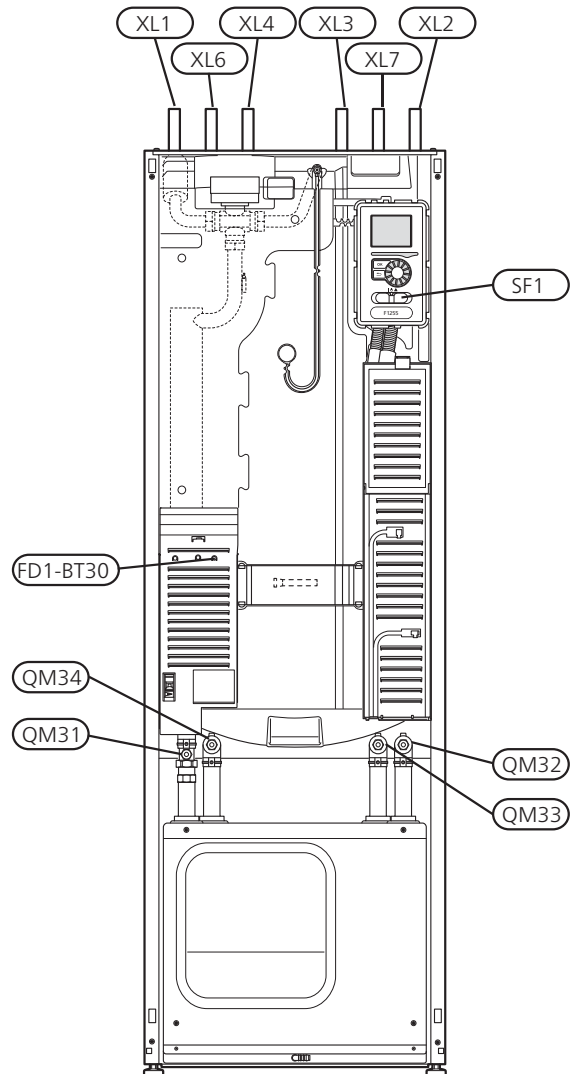
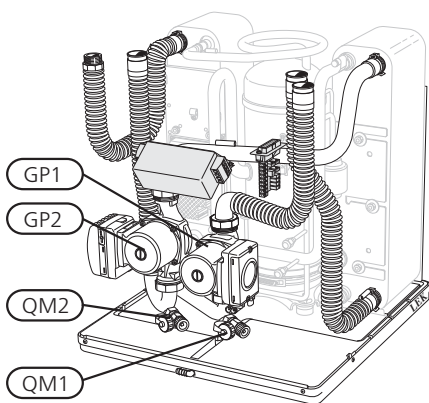

Draining the water heater

The siphon principle is used to empty the hot water heater. This can be done either via the drain valve on the incoming cold water pipe or by inserting a hose into the cold water connection.

Draining the climate system

In order to carry out service on the climate system, it may be easier to drain the system first. This can be done in different ways depending on what needs doing:

NOTE
 There may be some hot water when draining the heating medium side/climate system. There is a risk of scalding.

Draining the heating medium side in the cooling module

If, for example, the heating medium pump requires replacing or the cooling module requires servicing, drain the heating medium side as follows:

1. Close the shut-off valves to heating medium side (QM31) and (QM32).

2. Connect a hose to the bleed valve (QM1) and open the valve. Some liquid will run out.
3. Air must get into the system for the remaining liquid to run out. Do this by slightly slackening off the connection at the shut-off valve (QM32) that joins the heat pump to the cooling module.

When the heating medium side is drained, the required service can be performed and/or replacement of any components carried out.

Draining the heating medium system in the heat pump

If the heat pump requires servicing, drain the heating medium side as follows:

1. Close the shut-off valves outside the heat pump for the heating medium side (return and flow line).
2. Connect a hose to the bleed valve (QM1) and open the valve. Some liquid will run out.
3. Air must get into the system for the remaining liquid to run out. Do this by slightly slackening off the connection at the shut-off valve that joins the climate system and the heat pump at the connection (XL2).

When the heating medium side is empty the requisite service can be carried out.

Draining the entire climate system

If the entire climate system requires draining, do this as follows:

1. Connect a hose to the bleed valve (QM1) and open the valve. Some liquid will run out.
2. Air must get into the system for the remaining liquid to run out. This is done by unscrewing the bleed screw on the highest radiator in the house.

When the climate system is empty the requisite service can be carried out.

Emptying the brine system

In order to service the brine system it may be easier to drain the system first. This can be done in different ways depending on what needs doing:

Draining the brine system in the cooling module

If, for example, the brine pump requires replacing or the cooling module requires servicing, drain the brine system by:

1. Close the shut-off valves to brine system (QM33) and (QM34).
2. Connect a hose to the drain valve (QM2), place the other opening of the hose in a container and open the valve. A small amount of brine will flow into the container.
3. Air must get into the system for the remaining brine to run out. Do this by slightly slackening off the connection at the shut-off valve (QM33) that joins the heat pump with the cooling module.

When the brine side is empty the requisite service can be carried out.

Draining the brine system in the heat pump

If the heat pump requires servicing, drain the brine system by:

1. Close the shut-off valve outside the heat pump for the brine system.
2. Connect a hose to the drain valve (QM2), place the other opening of the hose in a container and open the valve. A small amount of brine will flow into the container.
3. Air must get into the system for the remaining brine to run out. Do this by slightly slackening off the connection at the shut-off valve that joins the brine side and the heat pump at the connection (XL7).

When the brine side is empty the requisite service can be carried out.

Helping the circulation pump to start



NOTE

Help starting the heating medium pump (GP1) only applies to F1255 -6 to -12 kW.

1. Shut off F1255 by setting the switch (SF1) to "0".
2. Open the service cover.
3. Remove the cover for the cooling module.
4. Loosen the venting screw (QM5) with a screwdriver. Hold a cloth around the screwdriver blade as a small amount of water may run out.
5. Insert a screwdriver and turn the pump motor around.
6. Screw in the venting screw (QM5).
7. Start F1255 by setting the switch (SF1) to "I" and check whether the circulation pump works.

It is usually easier to start the circulation pump with F1255 running, switch (SF1) set to "I". Helping the circulation pump to start is performed with F1255 running, be prepared for the screwdriver to jerk when the pump starts.

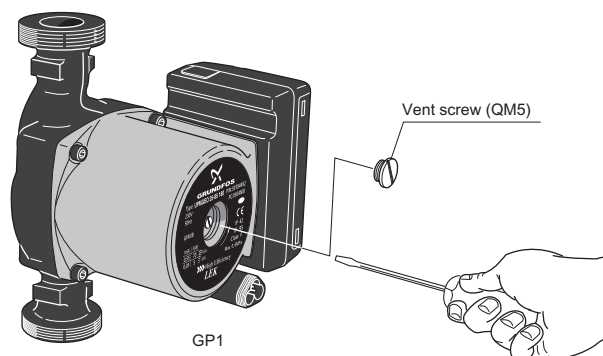

The image shows an example of what a circulation pump can look like.

Temperature sensor data

Temperature (°C)	Resistance (kOhm)	Voltage (VDC)
-40	351.0	3.256
-35	251.6	3.240
-30	182.5	3.218
-25	133.8	3.189
-20	99.22	3.150
-15	74.32	3.105
-10	56.20	3.047
-5	42.89	2.976
0	33.02	2.889
5	25.61	2.789
10	20.02	2.673
15	15.77	2.541
20	12.51	2.399
25	10.00	2.245
30	8.045	2.083
35	6.514	1.916
40	5.306	1.752
45	4.348	1.587
50	3.583	1.426
55	2.968	1.278
60	2.467	1.136
65	2.068	1.007
70	1.739	0.891
75	1.469	0.785
80	1.246	0.691
85	1.061	0.607
90	0.908	0.533
95	0.779	0.469
100	0.672	0.414

Pulling out the cooling module

The cooling module can be pulled out for service and transport.



Caution

The cooling module is easy to remove if it is drained first (see page 56).

Weight of the cooling module

Type (kW)	Weight (kg)
4 – 16 kW	125



NOTE

Shut off the heat pump and turn off the current on the safety breaker.



Caution

Remove the front cover according to the description on page 6.

- 1 Close the shut-off valves (QM31), (QM32), (QM33) and (QM34).

Drain the compressor module according to the instructions on page 56

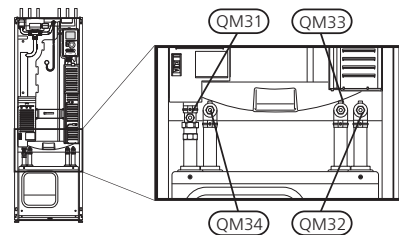

- 2 Pull off the lock catches.

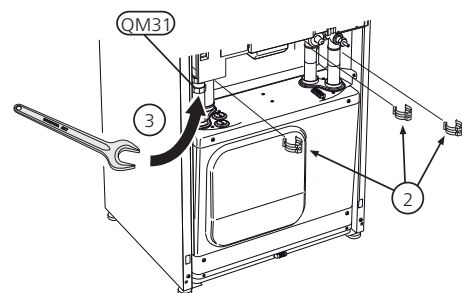

- 3 Disconnect the pipe connection at the shut-off valve (QM31).

- 4 Remove the two screws.

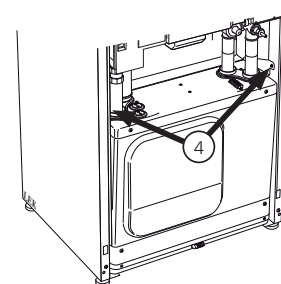

- Remove the connection from the base card (AA2) using a screwdriver.

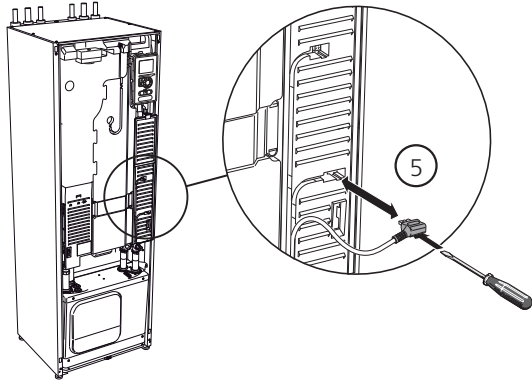

NOTE
 At reinstallation, the supplied O-rings must replace the existing ones at the connections to the heat pump (see image).

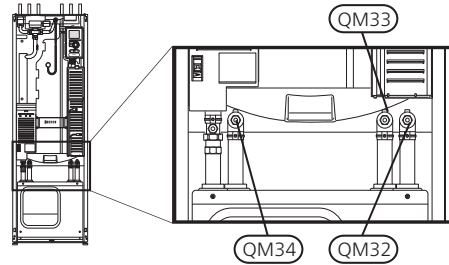

- Disconnect the connectors (A) and (B) from the underside of the base card cabinet.
- Disconnect the connector (C) from the immersion heater circuit board (AA1) using a screwdriver.
- Disconnect the connector (D) from the joint circuit board (AA100).
- Carefully pull out the cooling module.

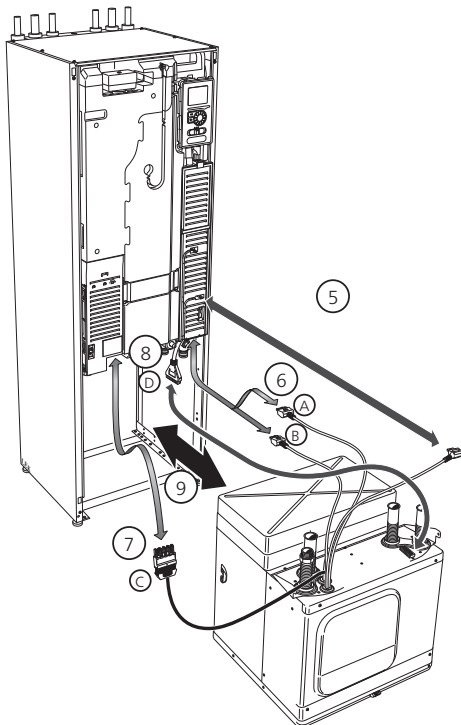

TIP
 The cooling module is installed in reverse order.

USB service outlet

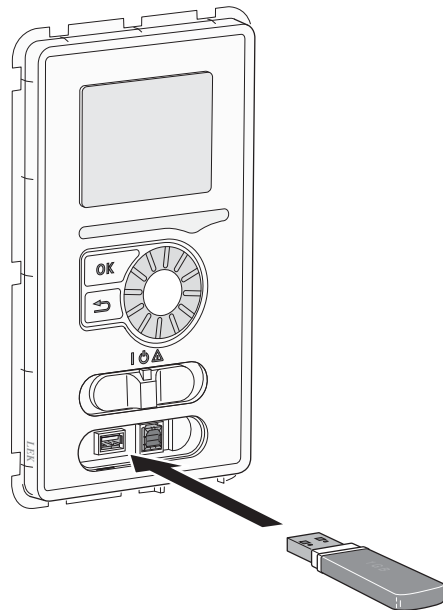

F1255 is equipped with a USB socket in the display unit. This USB socket can be used to connect a USB memory to update the software, save logged information and handle the settings in F1255.

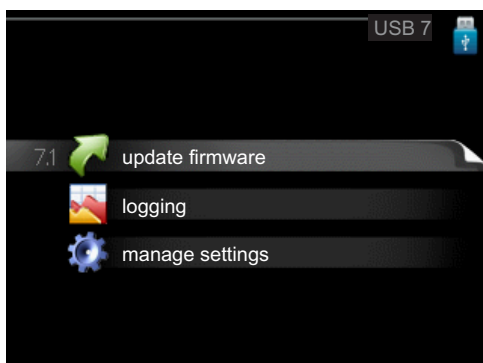
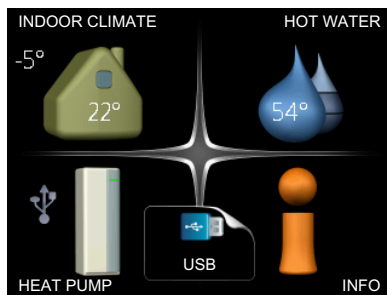

When a USB memory is connected a new menu (menu 7) appears in the display.

Menu 7.1 - update firmware

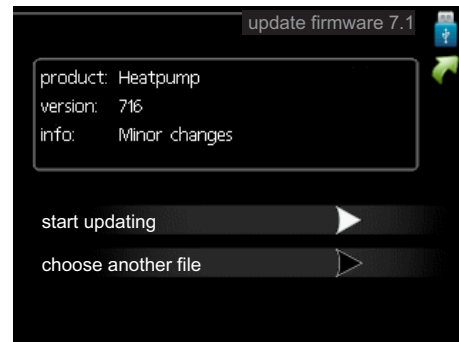

This allows you to update the software in F1255.



NOTE

For the following functions to work the USB memory must contain files with software for F1255 from NIBE.

The fact box at the top of the display shows information (always in English) of the most probable update that the update software has selected from the USB memory.

This information states which product the software is intended for, the software version and general information about them. If you wish to select another file than the one selected, the correct file can be selected by "choose another file".

start updating

Select "start updating" if you want to start the update. You are asked whether you really want to update the software. Respond "yes" to continue or "no" to undo.

If you responded "yes" to the previous question the update starts and you can now follow the progress of the update on the display. When the update is complete F1255 restarts.



NOTE

A software update does not reset the menu settings in F1255.



NOTE

If the update is interrupted before it is complete (for example power cut etc.) the software can be reset to the previous version if the OK button is held in during start up until the green lamp starts to illuminate (takes about 10 seconds).

choose another file

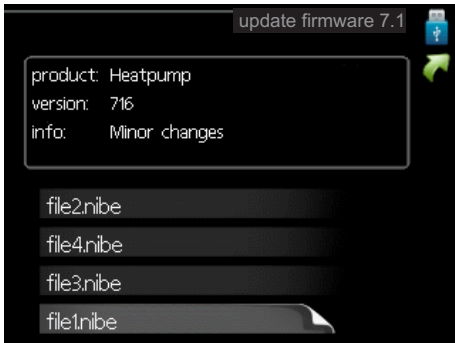

Select "choose another file" if you do not want to use the suggested software. When you scroll through the files, information about the marked software is shown in a fact box just as before. When you have selected a file with the OK button you will return to the previous page (menu 7.1) where you can choose to start the update.

Menu 7.2 - logging

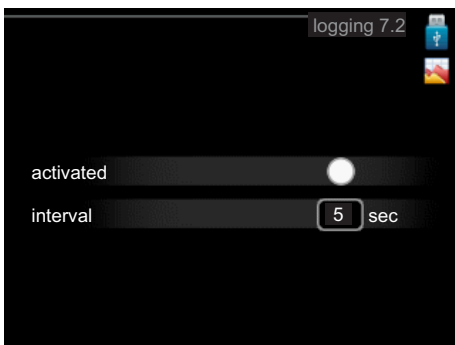

Setting range: 1 s – 60 min
Default setting range: 5 s

Set whether the present measurement values from F1255 are to be saved in a log on the USB memory.

Log for longer periods

1. Set the desired interval between loggings.
2. Tick "activated".
3. The present values from F1255 are saved in a file in the USB memory at the set interval until "activated" is unticked.



Caution

Untick "activated" before removing the USB memory.

Menu 7.3 - manage settings

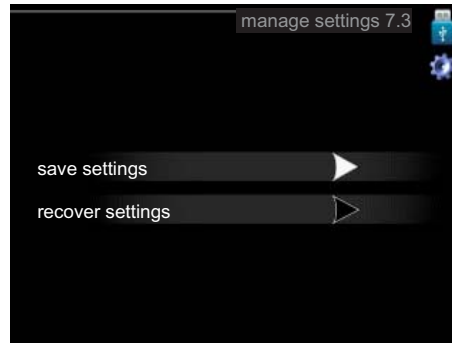

Here you can manage (save as or retrieve from) all the menu settings (user and service menus) in F1255 with a USB memory.

Via "save settings" you save the menu settings to the USB memory in order to restore them later or to copy the settings to another F1255.



NOTE

When you save the menu settings to the USB memory you replace any previously saved settings on the USB memory.

Via "recover settings" you reset all menu settings from the USB memory.



NOTE

Reset of the menu settings from the USB memory cannot be undone.

10 Disturbances in comfort

In most cases, the heat pump notes operational interference (operational interference can lead to disturbance in comfort) and indicates this with alarms and shows action instructions in the display.

Info-menu

All the heat pump measurement values are gathered under menu 3.1 in the heat pump menu system. Looking through the values in this menu can often simplify finding the fault source. See page 44 for more information about menu 3.1.

Manage alarm

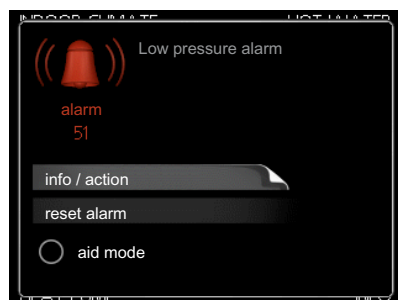

In the event of an alarm, some kind of malfunction has occurred, which is indicated by the status lamp changing from green continuously to red continuously. In addition, an alarm bell appears in the information window.

Alarm

In the event of an alarm with a red status lamp a malfunction has occurred that the heat pump cannot remedy itself. In the display, by turning the control knob and pressing the OK button, you can see the type of alarm it is and reset it. You can also choose to set the heat pump to aid mode.

info / action Here you can read what the alarm means and receive tips on what you can do to correct the problem that caused the alarm.

reset alarm In most cases it is enough to select "reset alarm" to correct the problem that caused the alarm. If a green light illuminates after selecting "reset alarm" the alarm has been remedied. If a red light is still visible and a menu called "alarm" is visible in the display, the problem that caused the alarm remains. If the alarm disappears and then returns, see the troubleshooting section (page 62).

aid mode "aid mode" is a type of emergency mode. This means that the heat pump produces heat and/or hot water despite there being some kind of problem. This can mean that the heat pump's compressor is not running. In this case the immersion heater produces heat and/or hot water.



Caution

Selecting "aid mode" is not the same as correcting the problem that caused the alarm. The status lamp will therefore continue to be red.

Troubleshooting

If the operational interference is not shown in the display the following tips can be used:

Basic actions

Start by checking the following possible fault sources:

- The switch's (SF1) position.
- Group and main fuses of the accommodation.
- The property's earth circuit breaker.
- The heat pump's miniature circuit breaker (FA1).
- The heat pump's temperature limiter (FD1).
- Correctly set load monitor (if installed).

Low hot water temperature or a lack of hot water

- Closed or choked filling valve for the hot water heater.
 - Open the valve.
- Heat pump in incorrect operating mode.
 - If mode "manual" is selected, select "addition".
- Large hot water consumption.
 - Wait until the hot water has heated up. Temporarily increased hot water capacity (temporary lux) can be activated in menu 2.1.
- Too low hot water setting.
 - Enter menu 2.2 and select a higher comfort mode.
- Too low or no operating prioritisation of hot water.
 - Enter menu 4.9.1 and increase the time for when hot water is to be prioritised.

Low room temperature

- Closed thermostats in several rooms.
 - Set the thermostats to max in as many rooms as possible. Adjust the room temperature via menu 1.1 instead of choking the thermostats.
- Heat pump in incorrect operating mode.
 - Enter menu 4.2. If mode "auto" is selected, select a higher value on "stop heating" in menu 4.9.2.
 - If mode "manual" is selected, select "heating". If this is not enough, select "addition".
- Too low set value on the automatic heating control.
 - Enter menu 1.1 "temperature" and adjust the offset of the heating curve. If the room temperature is only low in cold weather the curve slope in menu 1.9.1 "heating curve" needs adjusting up.
- Too low or no operating prioritisation of heat.
 - Enter menu 4.9.1 and increase the time for when heating is to be prioritised.
- "Holiday mode" activated in menu 4.7.
 - Enter menu 4.7 and select "Off".
- External switch for changing the room heating activated.
 - Check any external switches.
- Circulation pump(s) (GP1 and/or GP2) stopped.
 - See section "Helping the circulation pump to start" on page 57.

- Air in the climate system.
 - Vent the climate system (see page 26).
- Closed valves (QM20), (QM32) to the climate system.
 - Open the valves.

High room temperature

- Too high set value on the automatic heating control.
 - Enter menu 1.1 (temperature) and adjust the heat curve offset downwards. If the room temperature is only high in cold weather the curve slope in menu 1.9.1 (heating curve) needs to be adjusted down.
- External switch for changing the room heating activated.
 - Check any external switches.

Uneven room temperature.

- Incorrectly set heating curve.
 - Adjust the heating curve in menu 1.9.1.
- Too high set value on "dT at DOT"..
 - Enter menu 5.1.14 (flow set. climate system) and reduce the value of "dT at DOT".
- Uneven flow over the radiators.
 - Adjust the flow distribution between the radiators.

Low system pressure

- Not enough water in the climate system.
 - Top up the water in the climate system (see page 26).

Low or a lack of ventilation

This part of the fault-tracing chapter only applies if the NIBE FLM accessory is installed.

- The ventilation is not adjusted.
 - Order/implement ventilation adjustment.
- Filter (HQ10) blocked.
 - Clean or replace the filter.
- Exhaust air device blocked or throttled down too much.
 - Check and clean the exhaust air devices.
- Fan speed in reduced mode.
 - Enter menu 1.2 and select "normal".
- External switch for changing the fan speed activated.
 - Check any external switches.

High or distracting ventilation

This part of the fault-tracing chapter only applies if the NIBE FLM accessory is installed.

- The ventilation is not adjusted.
 - Order/implement ventilation adjustment.
- Fan speed in forced mode.
 - Enter menu 1.2 and select "normal".
- External switch for changing the fan speed activated.
 - Check any external switches.
- Filter blocked.
 - Clean or replace the filter.

The compressor does not start

- There is no heating requirement.
 - The heat pump does not call on heating nor hot water.
- Temperature conditions tripped.
 - Wait until the temperature condition has been reset.
- Minimum time between compressor starts has not been reached.
 - Wait 30 minutes and check if the compressor has started.
- Alarm tripped.
 - Follow the display instructions.

Whining noise in the radiators

- Closed thermostats in the rooms and incorrectly set heating curve.
 - Set the thermostats to max in as many rooms as possible. Adjust the heating curve via menu 1.1 instead of choking the thermostats.
- Circulation pump speed set too high.
 - Enter menu 5.1.11 (pump speed heating medium) and reduce the speed of the circulation pump.
- Uneven flow over the radiators.
 - Adjust the flow distribution between the radiators.

Gurgling sound

This part of the fault-tracing chapter only applies if the NIBE FLM accessory is installed.

- Not enough water in the water seal.
 - Refill the water seal with water.
- Choked water seal.
 - Check and adjust the condensation water hose.

11 Accessories

Accessory card AXC 40

An accessory card is required if step controlled addition (e.g. external electric boiler) or if shunt controlled addition (e.g. wood/oil/gas/pellet boiler) is to be connected to F1255.

An accessory card is also required if the ground water pump or external circulation pump is connected to F1255 at the same time that the buzzer alarm is activated.

Part no. 067 060

Active/Passive cooling HPAC 40

Part no. 067 076

Auxiliary relay HR 10

Part no. 067 309

Base extension EF 45

Part no. 067 152

Buffer vessel UKV

UKV 40

Part no. 088 470

UKV 100

Part no. 088 207

UKV 200

Part no. 080 300

UKV 300

Part no. 080 301

UKV 500

Part no. 080 302

Communications module MODBUS 40

MODBUS 40 enables F1255 to be controlled and monitored using a DUC (computer sub-center) in the building. Communication occurs using MODBUS-RTU.

Part no. 067 144

Communications module SMS 40

SMS 40 enables operation and monitoring of F1255, via a GSM module, using a mobile phone via SMS messages. If the mobile telephone also has the Android operating system the mobile application "NIBE Mobile App" can be used.

Part no. 067 073

Exhaust air module FLM

FLM is an exhaust air module specially designed to combine recovery of mechanical exhaust air with an energy collector in rock.

FLM

Part no. 067 011

Bracket pack FLM

Part no. 067 083

External electrical addition ELK

These accessories require accessories card AXC 40 (step controlled addition).

ELK 5

Immersion heater

5 kW, 1 x 230 V

Part no. 069 025

ELK 8

Immersion heater

8 kW, 1 x 230 V

Part no. 069 026

ELK 15

Immersion heater

15 kW, 3 x 400 V

Part no. 069 022

ELK 213

Part no. 069 500

Extra shunt group ECS 40/ECS 41

This accessory is used when F1255 is installed in houses with two or more different climate systems that require different supply temperatures.

ECS 40 (Max. 80 m²) Part no. 067 287

ECS 41 (Min. 80 m²) Part no. 067 288

Filling valve kit KB 32

Filling valve kit for filling brine in the collector hose for rock heat pumps. Includes dirt filter and insulation.

KB 32 (max 30 kW)

Part no. 089 971

Free cooling PCS 44

Part no. 067 296

Level monitor NV 10

Part no. 089 315

Passive cooling PCM 42

Part no. 067 078

Pool heating POOL 40

POOL 40 is an accessory that enables pool heating with F1255.

Part no. 067 062

Room unit RMU 40

RMU 40 means that control and monitoring of the heat pump can be carried out in a different part of the accommodation to where F1255 is located.

Part no. 067 064

Water heater/Accumulator tank

AHPS

Accumulator tank with a solar coil (copper) and a combined pre-heating and post-heating coil (stainless steel) for hot water production.

Part no. 056 283

AHP

Volume expansion tank that is primarily used for expanding the volume with an AHPS.

Part no. 056 284

12 Technical data

Dimensions and setting-out coordinates

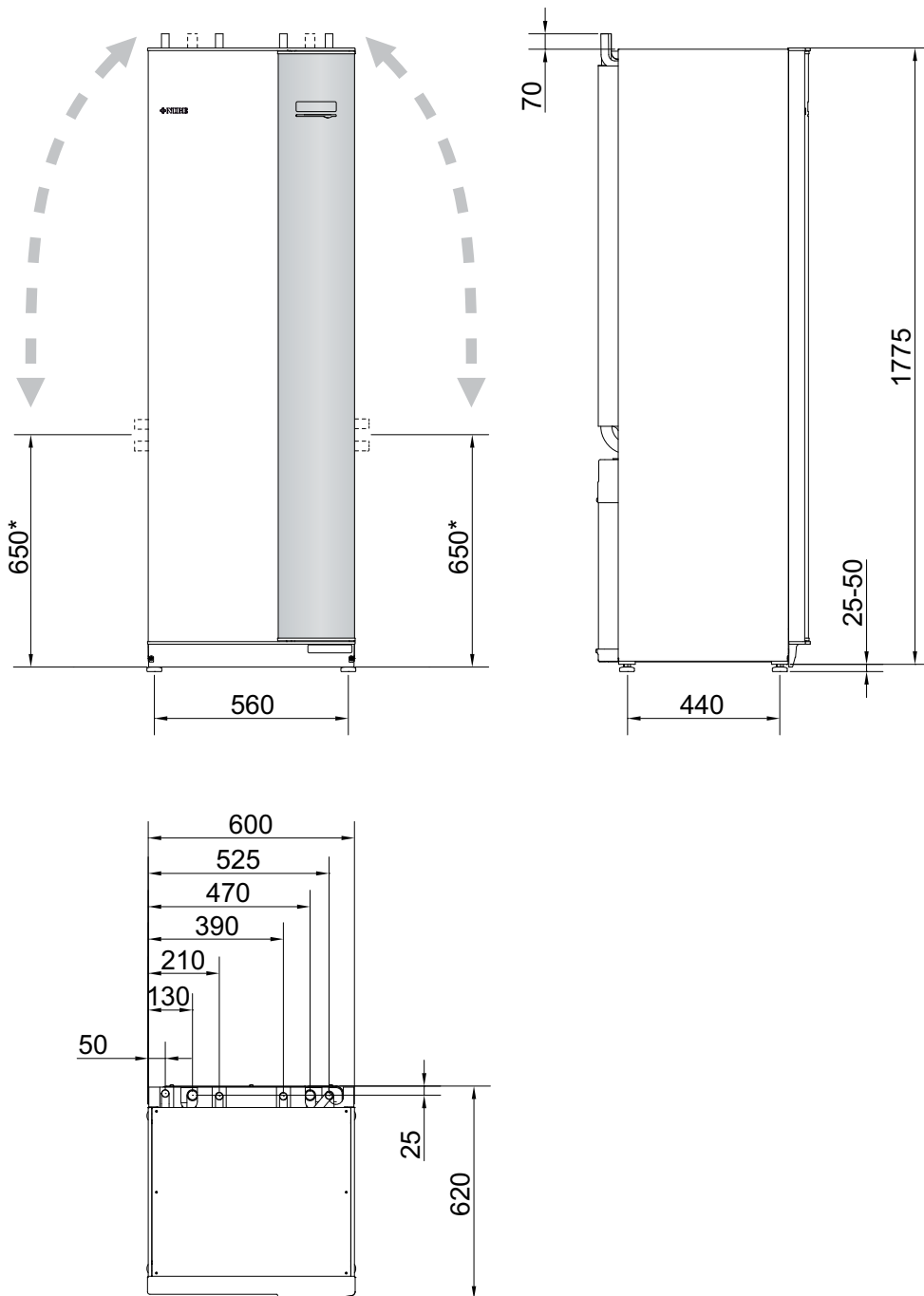

* This dimension applies at 90° angle on the brine pipes (side connection). The dimension can vary approx. ± 100 mm in height as the brine pipes partially consist of flexible pipes.

Technical specifications



3x400V

3x400V		4 – 16 kW
Output data at nom flow(50 Hz) <small>Refers to performance of heat pump excl. circulation pumps</small>		
0/35		
Rated output	kW	9.27
Electrical output	kW	1.81
COP		5.12
0/50		
Rated output	kW	8.95
Electrical output	kW	2.50
COP		3.59
Output data according to EN 14511:2011 nominal (50 Hz)		
0/35		
Rated output	kW	8.89
Electrical output	kW	1.83
COP		4.85
0/45		
Rated output	kW	8.63
Electrical output	kW	2.29
COP		3.77
10/35		
Rated output	kW	11.22
Electrical output	kW	1.84
COP		6.11
10/45		
Rated output	kW	10.92
Electrical output	kW	2.32
COP		4.72
SCOP according to EN 14825 Cold climate		
SCOP 0/35, Pdesign 12kW	-	5.5
SCOP 0/55, Pdesign 12kW		4.1
SCOP 0/35, Pdesign 16kW		5.4
SCOP 0/55, Pdesign 16kW		4.1
Additional power	kW	1/2/3/4/5/6/7 (switchable to 2/4/6/9)
Electrical data		
Rated voltage		400V 3NAC 50Hz
Max operating current, compressor Including Control system, Circulation pumps and 0 kW immersion heater (Recommended fuse rating)	A _{rms}	10(10)
Max operating current heat pump including 1 kW immersion heater (Recommended fuse rating)	A _{rms}	13(16)
Max operating current heat pump incl. 2 – 4 kW immersion heater (Recommended fuse rating)	A _{rms}	17(20)
Max operating current heat pump including 5 kW immersion heater (Recommended fuse rating)	A _{rms}	21(25)
Max operating current heat pump including 6 kW immersion heater (Recommended fuse rating)	A _{rms}	18(25)

3x400V		4 – 16 kW
Max operating current heat pump including 7 kW immersion heater, connected upon delivery (Recommended fuse rating)	A _{rms}	21(25)
Max operating current heat pump including 9 kW immersion heater, requires switching (Recommended fuse rating)	A _{rms}	24(25)
Short circuit power (Ssc) ¹⁾	MVA	2.2
Output, Brine pump	W	20 – 180
Output, Heating medium pump	W	10 – 87
IP class		IP 21
Refrigerant circuit		
Type of refrigerant		R407C
Volume	kg	2.2
Cut-out value pressostat HP	MPa	3.2 (32 bar)
Difference pressostat HP	MPa	-0.7 (-7 bar)
Cut-out value pressostat LP	MPa	0.15 (1.5 bar)
Difference pressostat LP	MPa	0.15 (1.5 bar)
Brine circuit		
Energy class Brine pump		low energy
Max system pressure brine	MPa	0.3 (3 bar)
Nominal flow (50 Hz)	l/s	0.51
Max external avail. press at nom flow	kPa	95
Max/Min incoming Brine temp	°C	see diagram
Min. outgoing brine temp.	°C	-10
Heating medium circuit		
Energy class circ-pump		low energy
Max system pressure heating medium	MPa	0.4 (4 bar)
Nominal flow (50 Hz)	l/s	0.22
Max external avail. press at nom flow	kPa	71
Max/Min heating medium temp	°C	see diagram
Noise output (L_{WA}) according to EN 12102 at 0/35	dB(A)	36 – 47
Sound pressure level (L_{PA}) calculated values according to EN ISO 11203 at 0/35 and a distance of 1 m	dB(A)	21 – 32
Pipe connections		
Brine ext diam. CU pipe	mm	28
Heating medium ext diam. CU pipes	mm	28
Hot water connection external diam	mm	22
Cold water connection external diam	mm	22

Miscellaneous

Miscellaneous		4 – 16 kW
Water heater		
Volume water heater	l	180
Max pressure in water heater	MPa	1.0 (10 bar)
Capacity hot water heating (comfort mode Normal) According to EN16147		
Amount of hot water (40 °C)		240
COP _{DHW} (tap profile XL)		2.7
Dimensions and weight		
Width	mm	600

Miscellaneous		4 – 16 kW
Depth	mm	620
Height	mm	1800
Required ceiling height ²⁾	mm	1950
Weight complete heat pump	kg	245
Weight only cooling module	kg	125
Part number, 3x400V, Enamel (for Germany, Switzerland and Austria only)		065 258
Part no., 3x400V, Enamel		065 239
Part number, 3x400V, Stainless		065 257
Part no. 3x400V, Copper		065 059

¹⁾This equipment meets IEC 61000-3-12 on the condition that short circuit power S_{sc} is greater than or equal to S_{sc} at the connection point between the customer installation electrical supply and the mains network. It is the responsibility of the installer or user to ensure, through consultation with the distribution network operator if required, that the equipment is only connected to a supply with a short circuit power S_{sc} equal to or greater than S_{sc} .

²⁾With feet dismantled the height is approx. 1930 mm.

Working range heat pump, compressor operation

The compressor provides a flow temperature up to 65 °C, the remainder (up to 70 °C) is obtained using the additional heat.

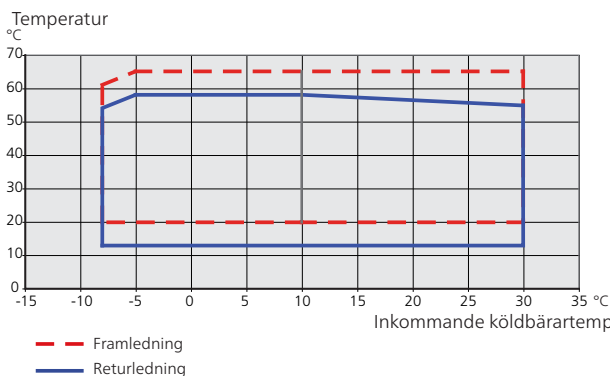

Diagram, dimensioning compressor speed

Heating mode

Specified heating output
kW

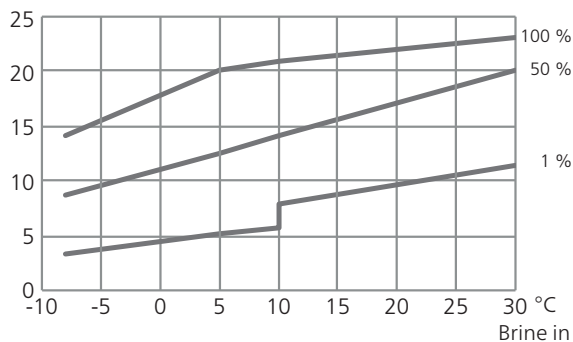

Use this diagram to size the heating dump (for cooling operation) and for pool heating.

Cooling mode



Caution

To size heating dump, see the diagram for heating operation.

Supply temperature, heating medium 35 -C

Specified cooling output
kW

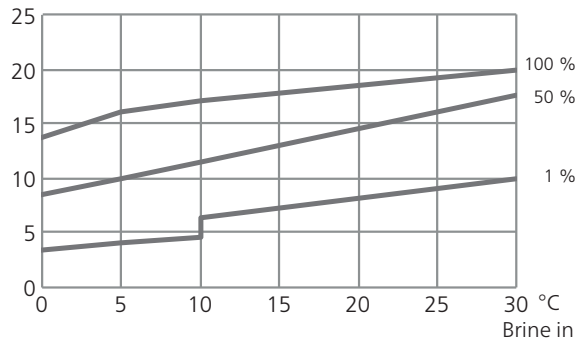

Supply temperature, heating medium 50 -C

Specified cooling output
kW

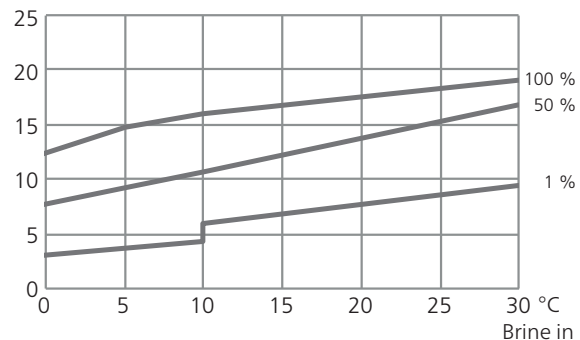

Electrical circuit diagram

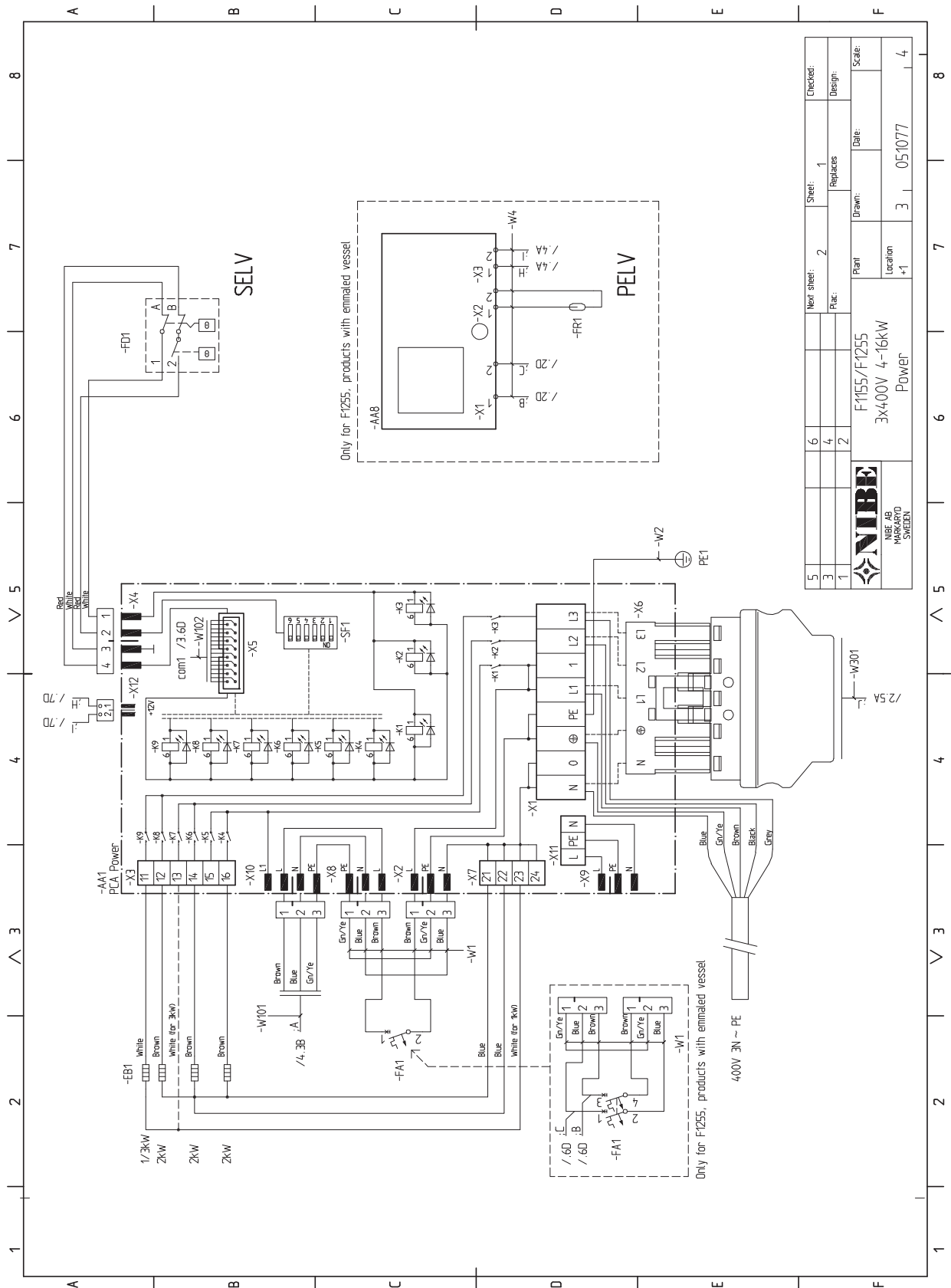

5	6	Next sheet:	2	Sheet:	1	Checked:	
3	4	Plac.:		Replaces:		Design:	
1	2	Plan:		Drawn:		Date:	
		Location:	+1	3	051077	Scale:	4
		F1255/F1255		Power			
		3x400V 4-16kW					
		NIBE					
		NIBE AB					
		SE-2000					
		SMEDJA					

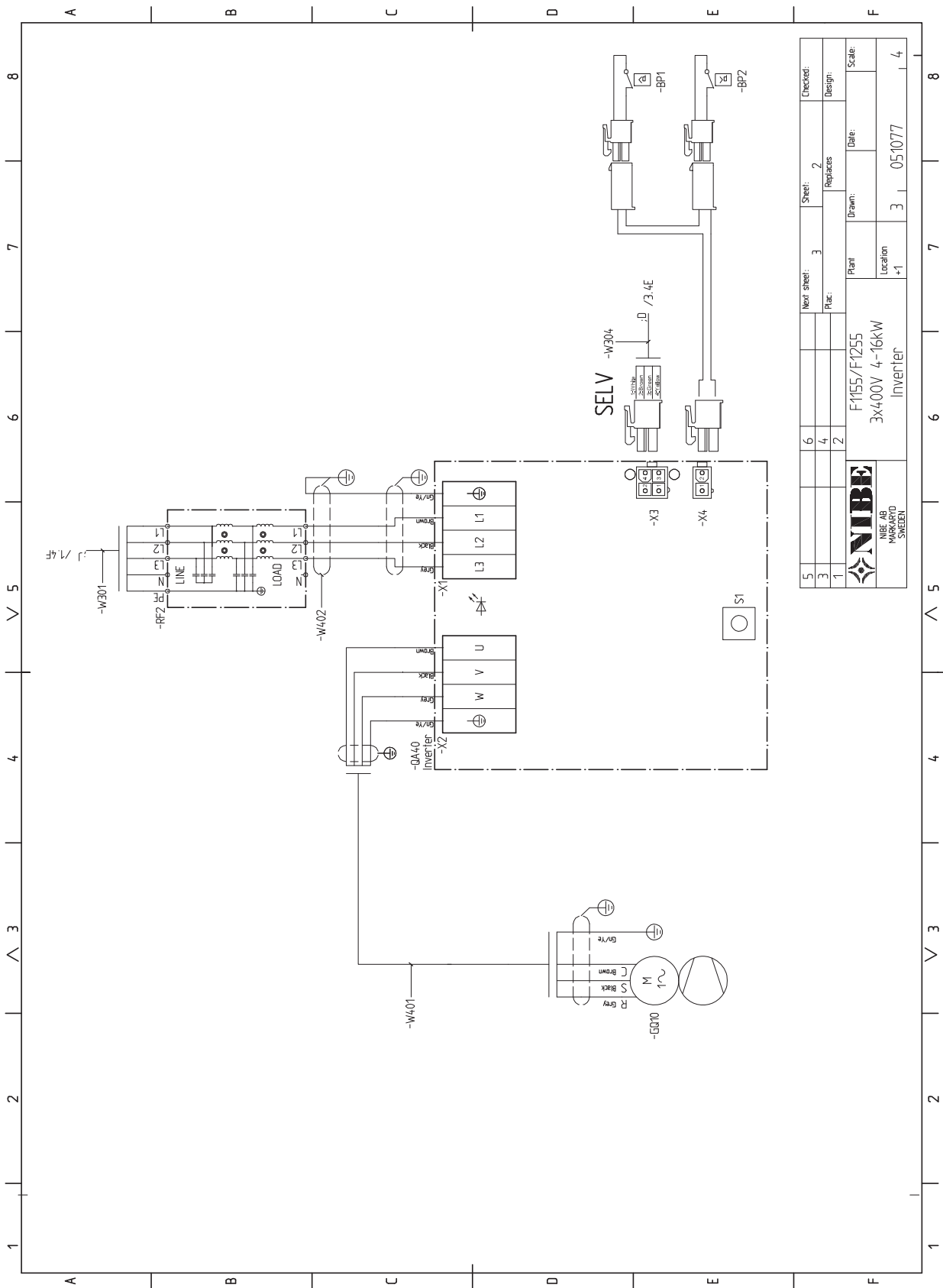

5	6	Next sheet:	3	Sheet:	2	Checked:
3	4	Plat.:		Replaces:		Design:
1	2			Drawn:		Scale:
		Plant	F1255/F1255	Date:		
		Location	3X400V 4-16KW	Date:	05/07/77	
			Inverter			
			+1			

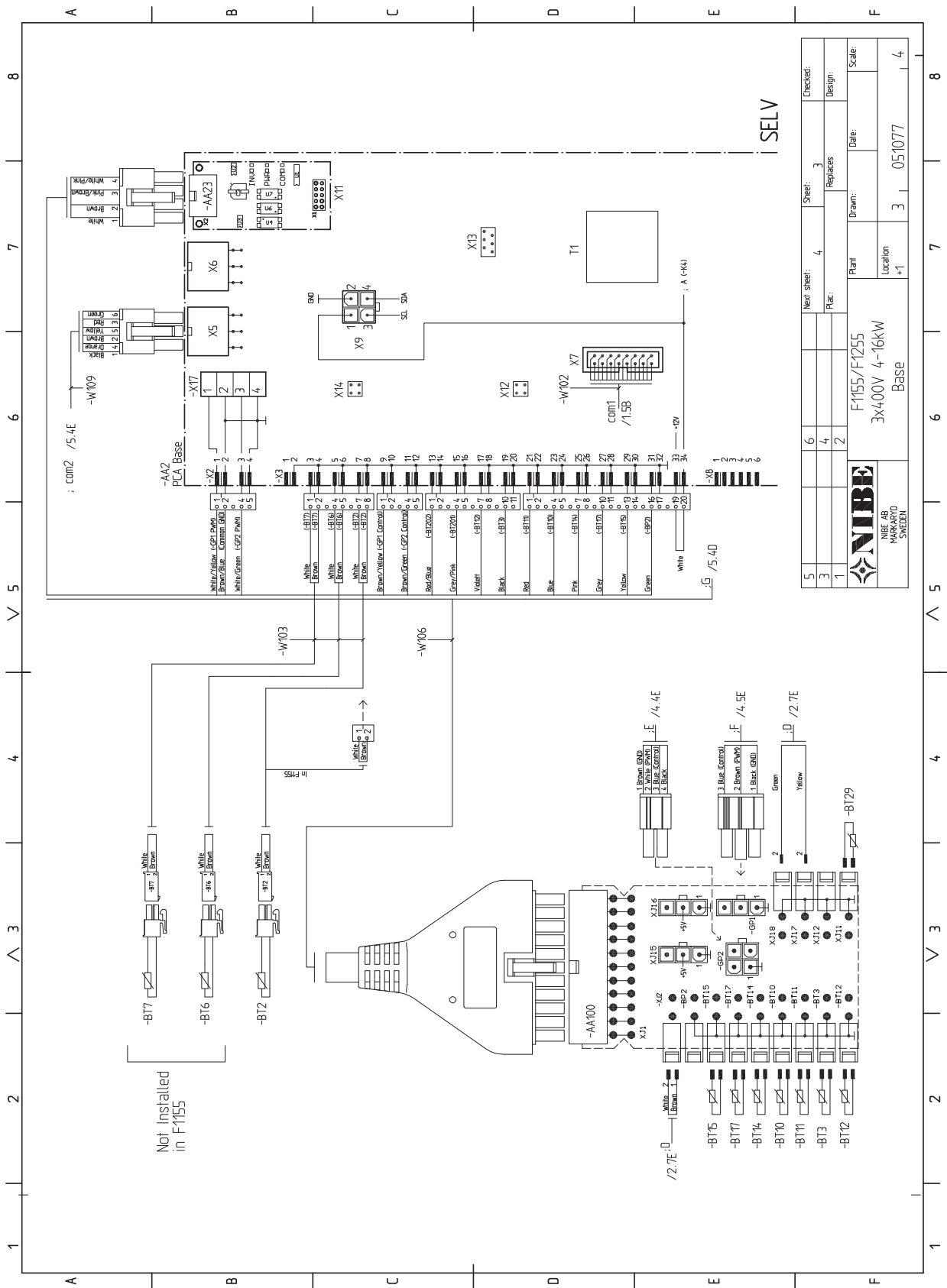

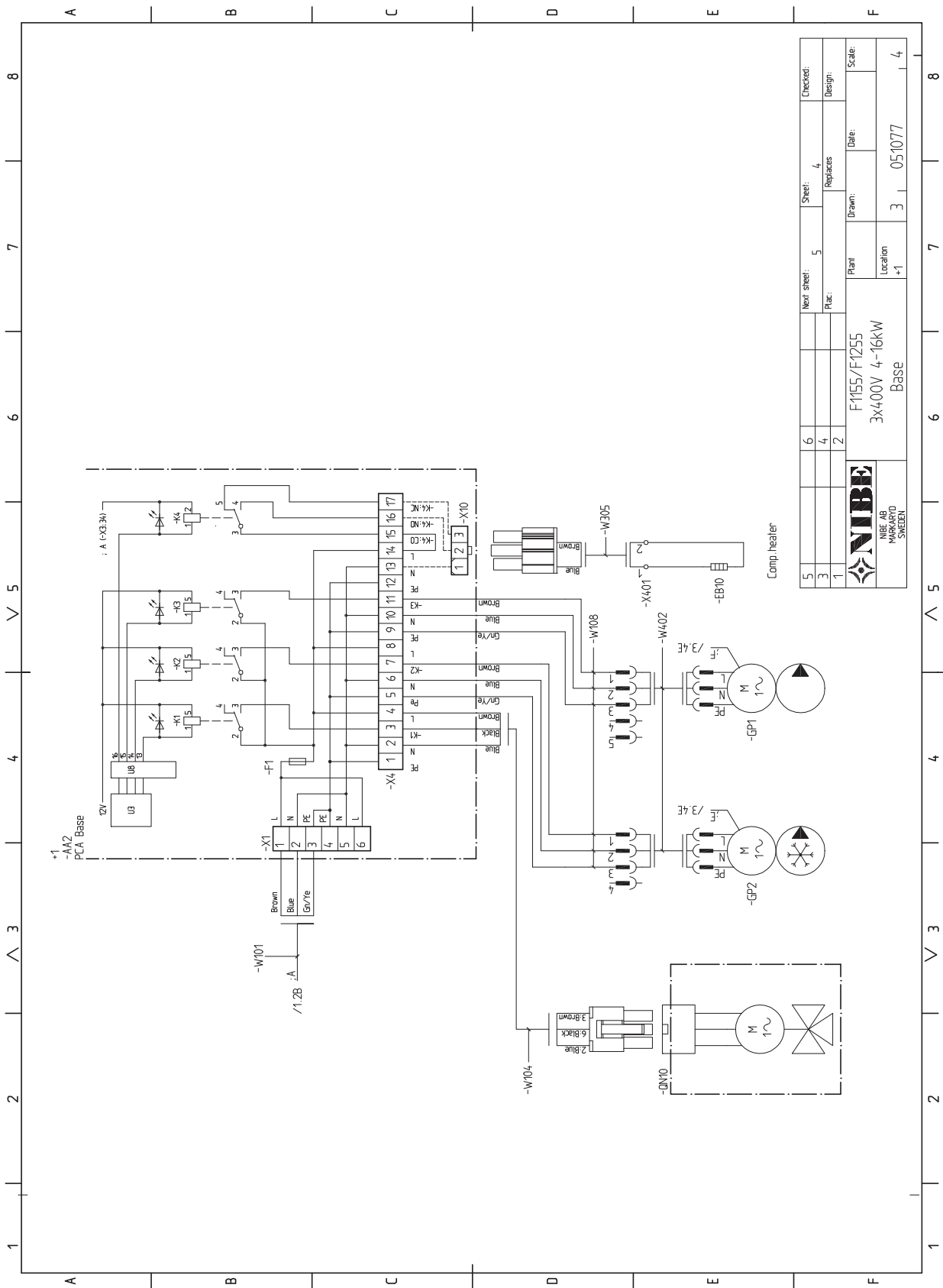

5	6	Next sheet:	5	Sheet:	4	Checked:
3	4	Plat.:		Replaces:		Design:
1	2	Plan	F1255/F1255	Drawn:		Scale:
		Location	3X400V 4-16kW			
		Base	+1	3	051077	4



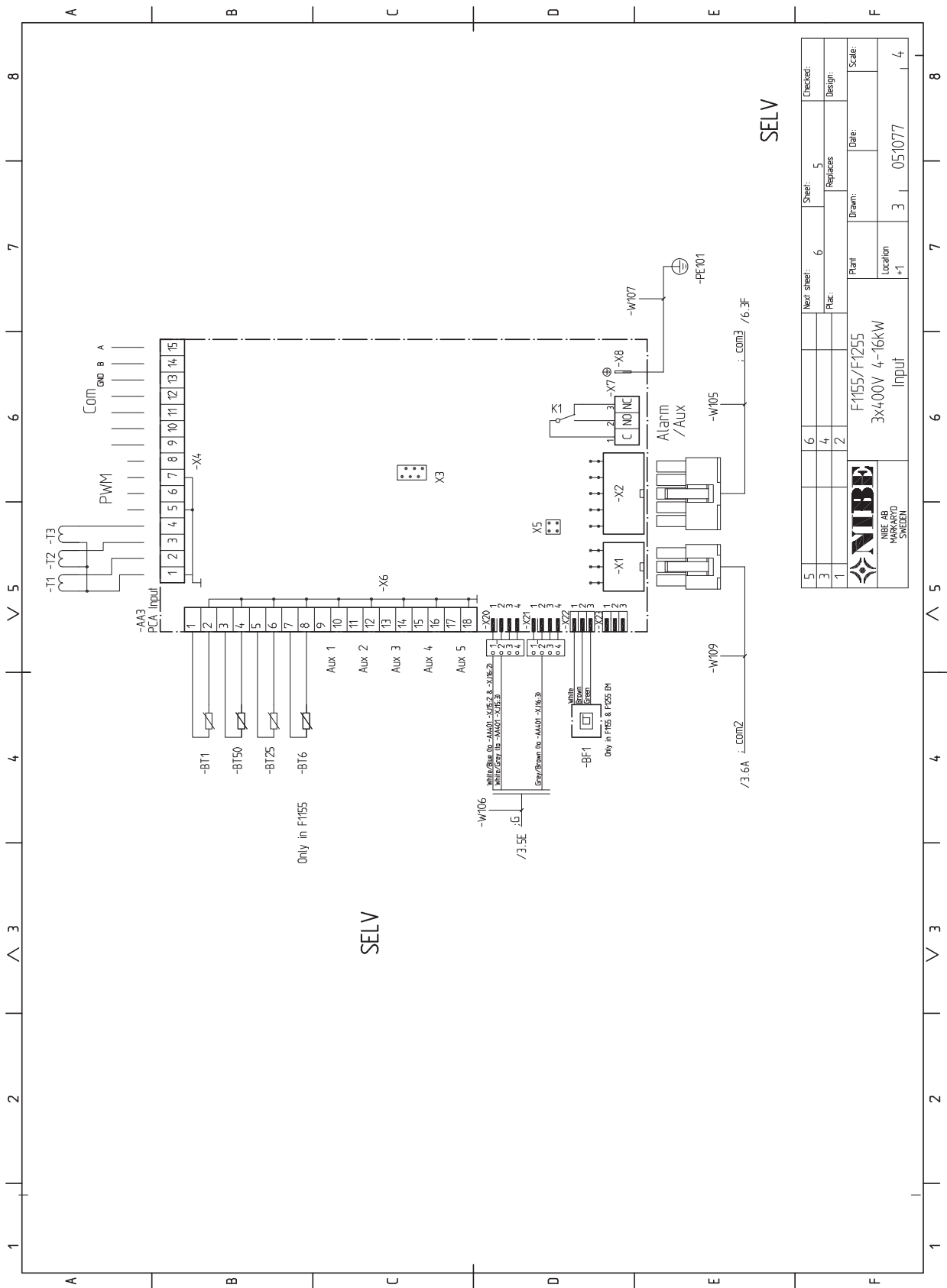

SELV

5	Next sheet:	6	Sheet:	5	Checked:
3	Replaces:	6	Replaces:	5	Design:
1	Plant:	2	Drawn:		Scale:
F155/F1255			Date:		
3x400V 4-16kW			Location		
Input			+1	3	051077
				4	



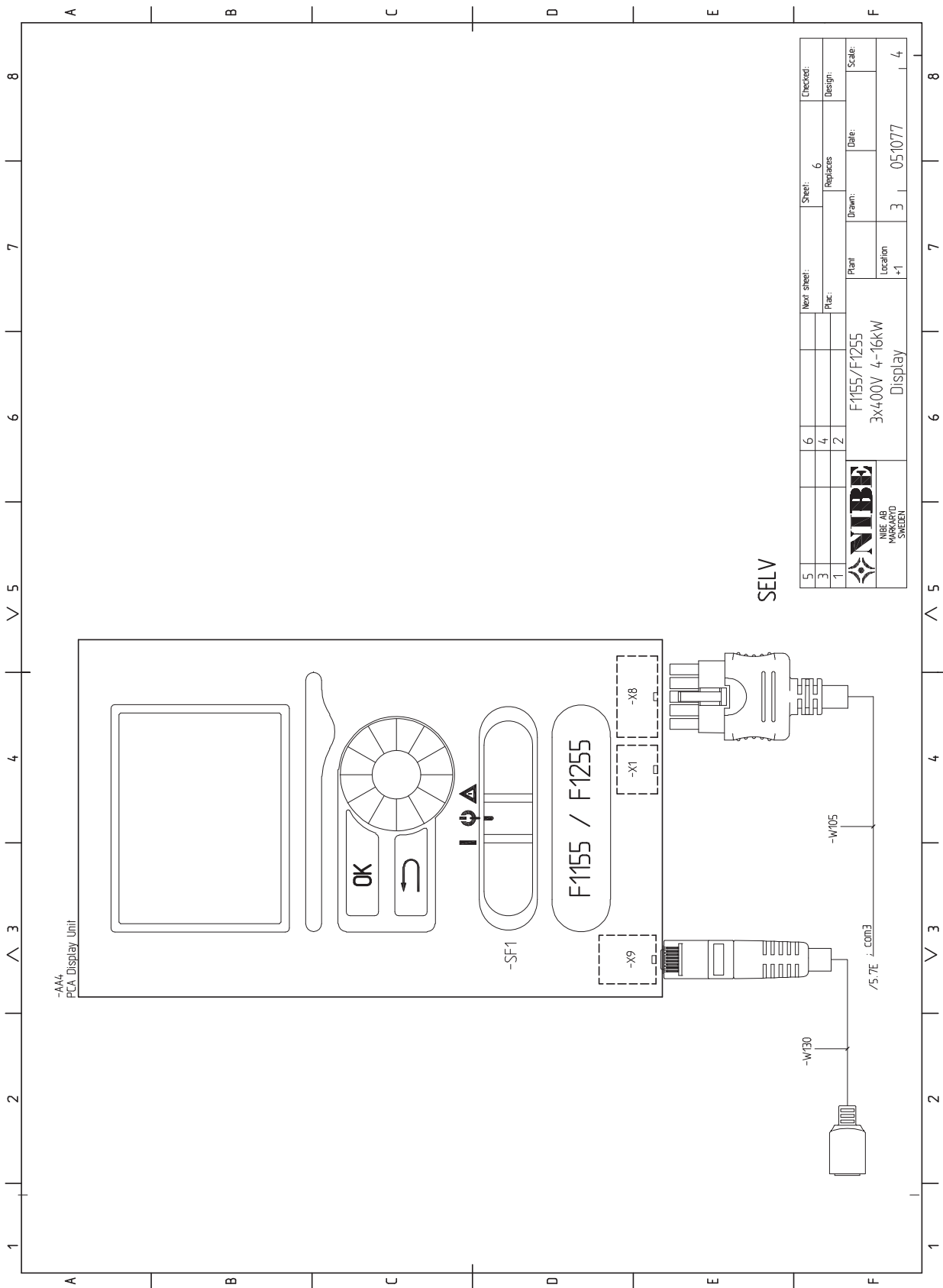

-AA4
PCA Display Unit

SELV

5					Sheet:	6	Checked:
3					Replaces:		Design:
1					Drawn:		Scale:
 NIBE AB MARKARYD SWEDET		Plan:	F1155/F1255	Date:			
		Location:	3x400V 4-16kW	Date:	051077		
		Location:	+1	Drawn:	3		4
			Display				

13 Item register

Item register

A

Accessibility, electrical connection, 18
Accessories, 64
Alarm, 62
Assembly, 5

B

Back button, 30
Brine side, 13

C

Cable lock, 18
Commissioning and adjusting, 26
 Filling and venting, 26
 Post adjustment and bleeding, 28
 Preparations, 26
 Start guide, 27
Connecting accessories, 25
Connecting current sensors, 22
Connecting external operating voltage for the control system, 19
Connecting the climate system, 14
Connecting the hot water heater, 14
Connections, 19
Contact for activation of fan speed, 24
Contact for activation of "external adjustment", 24
Contact for activation of "temporary lux", 24
Contact for external tariff blocking, 23
Contact information, 4
Control, 30, 34
 Control - Introduction, 30
 Control - Menus, 34
Control - Introduction, 30
 Display unit, 30
 Menu system, 31
Control knob, 30
Controlling ground water pump, 24
Control - Menus, 34
 Menu 1 - INDOOR CLIMATE, 34
 Menu 2 - HOT WATER, 42
 Menu 3 - INFO, 44
 Menu 4 - HEAT PUMP, 45
 Menu 5 - SERVICE, 50
Cooling mode indication, 24
Cooling section, 11

D

Delivery and handling, 5
 Assembly, 5
 Drawing out the cooling module, 5
 Installation area, 5
 Removing parts of the insulation, 7
 Removing the covers, 6
 Supplied components, 6
 Transport, 5
Diagram, dimensioning compressor speed, 69
Dimensions and pipe connections, 13
Dimensions and setting-out coordinates, 66
Display, 30
Display unit, 30
 Back button, 30
 Control knob, 30
 Display, 30
 OK button, 30
 Status lamp, 30
 Switch, 30
Disturbances in comfort, 62
 Alarm, 62
 Manage alarm, 62
 Troubleshooting, 62

Docking alternatives, 14
 Extra electric hot water heater, 14
 Free cooling, 15
 Ground water system, 16
 Neutralization vessel, 15
 Pool, 16
 Two or more climate systems, 16
 Under floor heating systems, 15
 Ventilation recovery, 15
Draining the climate system, 56
Draining the hot water heater, 56
Drawing out the cooling module, 5, 58

E

Electrical addition - maximum output, 21
 Setting max electrical output, 21
 Switching to maximum electrical output, 21
Electrical cabinets, 10
Electrical circuit diagram, 70
Electrical connections, 17
 Accessibility, electrical connection, 18
 Cable lock, 18
 Connecting accessories, 25
 Connecting external operating voltage for the control system, 19
 Connections, 19
 Electrical addition - maximum output, 21
 External connection options, 23
 General, 17
 Load monitor, 22
 Miniature circuit-breaker, 17
 NIBE Uplink™, 23
 Optional connections, 22
 Outdoor sensor, 20
 Power connection, 19
 Removing the cover, base board, 18
 Removing the cover, immersion heater circuit board, 18
 Removing the hatch, input circuit board, 18
 Room sensor, 20
 Settings, 21
 Standby mode, 21
 Temperature limiter, 17
 Temperature sensor, external flow line, 20
Emptying the brine system, 57
External connection options, 23
 Contact for activation of fan speed, 24
 Contact for activation of "external adjustment", 24
 Contact for activation of "temporary lux", 24
 Contact for external tariff blocking, 23
 Controlling ground water pump, 24
 Cooling mode indication, 24
 Extra circulation pump, 24
 Hot water circulation, 24
 NV 10, pressure/level/flow monitor brine, 24
 Possible selection for AUX inputs, 23
 Possible selection for AUX output (potential free variable relay), 24
 Switch for "Smart Grid ready", 23
 Switch for external blocking of addition and/or compressor, 23
 Switch for external blocking of heating, 24
 Switch for external forced control of brine pump, 24
 Temperature sensor, cooling/heating, 23
Extra circulation pump, 24

F

Filling and venting, 26
 Filling and venting the brine system, 26
 Filling and venting the climate system, 26

- Filling the hot water heater, 26
 - Symbol key, 27
- Filling and venting the brine system, 26
- Filling and venting the climate system, 26
- Filling the hot water heater, 26
- H**
- Heating medium side, 14
 - Connecting the climate system, 14
- Helping the circulation pump to start, 57
- Help menu, 27, 33
- Hot water circulation, 24
- Hot water heater, 14
 - Connecting the hot water heater, 14
- I**
- Important information, 2
 - Safety information, 2
- Inspection of the installation, 3
- Installation area, 5
- M**
- Manage alarm, 62
- Marking, 2
- Menu 1 - INDOOR CLIMATE, 34
- Menu 2 - HOT WATER, 42
- Menu 3 - INFO, 44
- Menu 4 - HEAT PUMP, 45
- Menu 5 - SERVICE, 50
- Menu system, 31
 - Help menu, 27, 33
 - Operation, 32
 - Scroll through the windows, 33
 - Selecting menu, 32
 - Selecting options, 32
 - Setting a value, 32
 - Use the virtual keyboard, 33
- Miniature circuit-breaker, 17
- N**
- NIBE Uplink™, 23
- NV 10, pressure/level/flow monitor brine, 24
- O**
- OK button, 30
- Operation, 32
- Optional connections, 22
- Outdoor sensor, 20
- P**
- Pipe connections, 12
 - Brine side, 13
 - Dimensions and pipe connections, 13
 - Docking alternatives, 14
 - General, 12
 - Heating medium side, 14
 - Hot water heater, 14
 - Pipe dimensions, 13
 - Symbol key, 12
 - System diagram, 12
- Pipe dimensions, 13
- Possible selection for AUX inputs, 23
- Possible selection for AUX output (potential free variable relay), 24
- Post adjusting the room temperature, 29
- Post adjustment and bleeding, 28
 - Post adjusting the room temperature, 29
 - Pump adjustment, automatic operation, 28
 - Pump adjustment, manual operation, 28
 - Pump capacity diagram, brine side, manual operation, 28
 - Readjusting, venting, heat medium side, 29
- Power connection, 19
- Preparations, 26
- Pump adjustment, automatic operation, 28
 - Brine side, 28
 - Heating medium side, 28
- Pump adjustment, manual operation, 28
 - Heating medium side, 29
- Pump capacity diagram, brine side, manual operation, 28
- R**
- Readjusting, venting, heat medium side, 29
- Removing parts of the insulation, 7
- Removing the cover, base board, 18
- Removing the cover, immersion heater circuit board, 18
- Removing the covers, 6
- Removing the hatch, input circuit board, 18
- Room sensor, 20
- S**
- Safety information, 2
 - Contact information, 4
 - Inspection of the installation, 3
 - Marking, 2
 - Serial number, 2
 - Symbols, 2
- Scroll through the windows, 33
- Selecting menu, 32
- Selecting options, 32
- Serial number, 2
- Service, 56
 - Service actions, 56
- Service actions, 56
 - Draining the climate system, 56
 - Draining the hot water heater, 56
 - Drawing out the cooling module, 58
 - Emptying the brine system, 57
 - Helping the circulation pump to start, 57
 - Standby mode, 56
 - Temperature sensor data, 58
 - USB service outlet, 60
- Setting a value, 32
- Settings, 21
- Standby mode, 56
 - Power in emergency mode, 21
- Start guide, 27
- Status lamp, 30
- Supplied components, 6
- Switch, 30
- Switch for "Smart Grid ready", 23
- Switch for external blocking of addition and/or compressor, 23
- Switch for external blocking of heating, 24
- Switch for external forced control of brine pump, 24
- Symbol key, 12, 27
- Symbols, 2
- System diagram, 12
- T**
- Technical data, 66
 - Dimensions and setting-out coordinates, 66
 - Electrical circuit diagram, 70
 - Technical Data, 67
- Technical Data, 67
 - Diagram, dimensioning compressor speed, 69
 - Working range heat pump, 69
- Temperature limiter, 17
 - Resetting, 17
- Temperature sensor, cooling/heating, 23
- Temperature sensor, external flow line, 20
- Temperature sensor data, 58
- The heat pump design, 8
 - Component list cooling section, 11
 - Component list electrical cabinets, 10
 - Component location cooling section, 11
 - Component location electrical cabinets, 10

- Component locations, 8
- List of components, 8
- Transport, 5
- Troubleshooting, 62

U

- USB service outlet, 60
- Use the virtual keyboard, 33

W

- Working range heat pump, 69

NIBE AB Sweden
Hannabadsvägen 5
Box 14
SE-285 21 Markaryd
info@nibe.se
www.nibe.eu



231531