

**3. WALL MOUNTED TYPE
ROOM AIR-CONDITIONER
(Split system, Air cooled)
cooling only type**

SRK501CENF-L, SRK561CENF-L

CONTENTS

- 3.1 GENERAL INFORMATION 95**
 - 3.1.1 Specific features 95**
 - 3.1.2 How to read the model name 95**
- 3.2 SELECTION DATA 96**
 - 3.2.1 Specifications 96**
 - 3.2.2 Range of usage & limitations 98**
 - 3.2.3 Exterior dimensions 99**
 - 3.2.4 Piping system 100**
- 3.3 ELECTRICAL DATA 101**
 - 3.3.1 Electrical wiring 101**
- 3.4 FUNCTIONS 101**
- 3.5 APPLICATION DATA 101**
- 3.6 MAINTENANCE DATA 101**

3.1 GENERAL INFORMATION

3.1.1 Specific features

The “Mitsubishi Daiya” room air conditioner: **SRK series** are of split and wall mounted type and the unit consists of indoor unit and outdoor unit with refrigerant precharged in factory. The indoor unit is composed of room air cooling or heating equipment with operation control switch and the outdoor unit is composed of condensing unit with compressor.

(1) Remote control flap

The flap can be automatically controlled by operating wireless remote control.

- AUTO (Natural flow) : Flap operation is automatically controlled.
- Swing : This will swing the flap up and down.
- Memory flap : Once the flap position is set , the unit memorizes the position and continues to operate at the same position from the next time.

(2) Automatic Operation

When the remote control switch is set on “ auto ”, it will either automatically decide operation mode such as cooling, heating and thermal dry, or operate in the operation mode before it has been turned to automatic control.

(3) Self diagnosis Function

We are constantly trying to do better service to our customers by installing such judges that show abnormality of operation as follows.

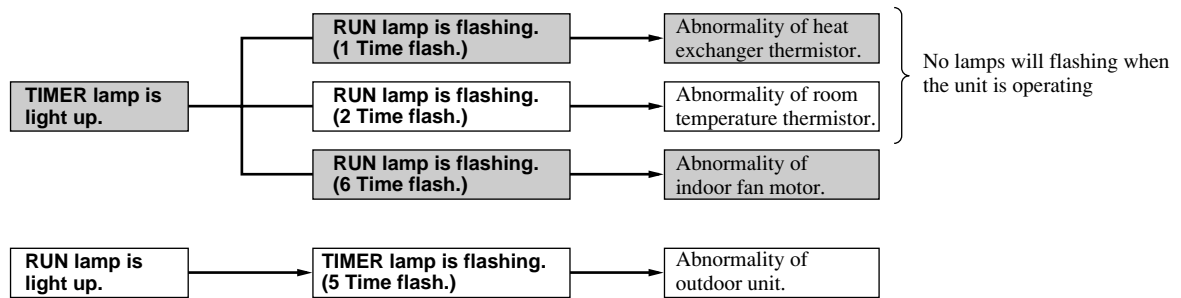

3.1.2. How to read the model name

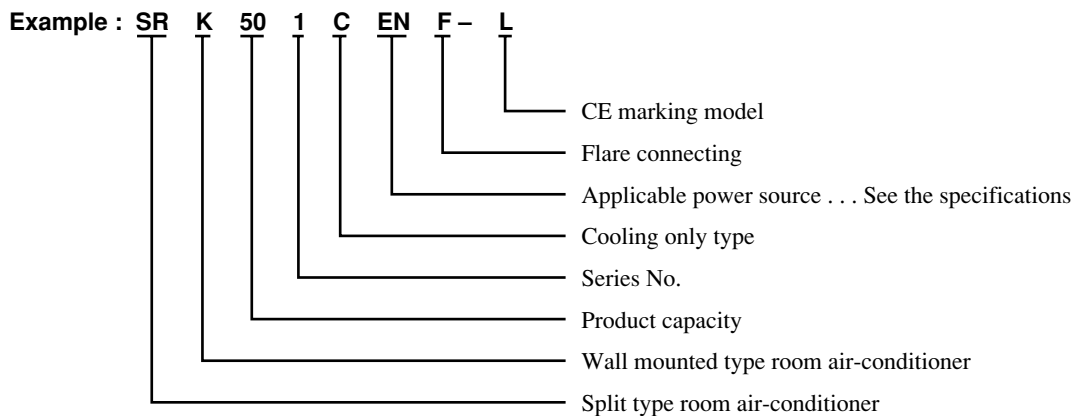

3.2 SELECTION DATA

3.2.1 Specifications

Model SRK501CENF-L (Indoor unit)
SRC501CENF-L (Outdoor unit)

Item		Model	SRK501CENF-L	SRC501CENF-L	
Cooling capacity ⁽¹⁾		W	4500/4500		
Power source			1 Phase, 220/240V, 50 Hz		
Operation data ⁽¹⁾	Cooling input	kW	1.78/1.88		
	Running current (Cooling)	A	8.4/8.2		
	Inrush current	A	39/42		
	COP (In cooling)		2.53/2.39		
	Noise level ⁽⁵⁾	dB (A)	44/44	50/51	
Exterior dimensions Height × Width × Depth		mm	275 × 790 × 189	615 × 850 × 290 + 30	
Color			Ivory white	Polar white	
Net weight		kg	9	52	
Refrigerant equipment Compressor types & Q'ty			–	RM5523GNE4 (Rotary type) × 1	
Motor		kW	–	1.7	
Starting method			–	Line starting	
Heat exchanger			Louver fins & tubing		
Refrigerant control			Capillary tubes		
Refrigerant ⁽⁴⁾		kg	R22 1.28		
Refrigerant oil		ℓ	0.7 (BARREL FREEZE 32SAM)		
Air handling equipment Fan type & Q'ty			Tangential fan × 1	Propeller fan × 1	
Motor		W	23	40	
Air flow (at High)		CMM	11/11	34/34	
Air filter, Q'ty			Polypropylene net (washable) × 2		
Shock & vibration absorber			–	Cushion rubber (for compressor)	
Electric heater			–	–	
Operation control Operation switch			Wireless-Remote controller		
Room temperature control			MC. Thermostat		
Pilot lamp			RUN (Green), TIMER (Yellow), ECONO (Orange), HI POWER (Green)		
Safety equipment			–	Dome mounted protector (for compressor) Internal thermostat (for fan motor)	
Refrigerant piping	O.D	mm (in)	Liquid line: φ6.35 (1/4") Gas line: φ12.7 (1/2")		
	Connecting method		Flare connecting		
	Attached length of piping		Liquid line: 0.4m Gas line : 0.35m	–	
	Insulation		Necessary (Both sides)		
Drain hose		Connectable			
Power source cord		2.5 m (3 cores with Earth)			
Connection wiring	Size × Core number	1.5 mm ² × 3 cores (Including earth cable)			
	Connecting method	Terminal block (Screw fixing type)			
Accessories (included)		Mounting kit			
Optional parts		–			

Notes (1) The data are measured at the following conditions.

Operation	Item	Indoor air temperature		Outdoor air temperature		Standards
		DB	WB	DB	WB	
Cooling		27°C	19°C	35°C	24°C	JIS C9612, ISO-T1

(2) The operation data are applied to the 220 V or 240 V districts respectively.

(3) Limitation of Voltage application

Minimum: 198 V Maximum: 264 V

(4) The refrigerant quantity to be charged includes the refrigerant in 7.5 m connecting piping.

(Purging is not required even in the short piping.)

If the piping length is longer, (when it is less than 10 m, add 10 g refrigerant per meter and when it is 10 to 15 m, add 30 g refrigerant per meter.)

(5) Expressed in sound pressure level.

**Model SRK561CENF-L (Indoor unit)
SRC561CENF-L (Outdoor unit)**

Item		Model	SRK561CENF-L	SRC561CENF-L	
Cooling capacity ⁽¹⁾		W	5000/5000		
Power source			1 Phase, 220/240V, 50 Hz		
Operation data ⁽¹⁾	Cooling input	kW	2.08/2.18		
	Running current (Cooling)	A	10.2/9.53		
	Inrush current	A	44/48		
	COP (In cooling)		2.40/2.29		
	Noise level ⁽⁵⁾	dB (A)	45/45	53/54	
Exterior dimensions		mm	275 × 790 × 189	615 × 850 × 290 + 30	
Height × Width × Depth					
Color			Ivory white	Polar white	
Net weight		kg	9	52	
Refrigerant equipment					
Compressor types & Q'ty			–	RM5526GNE4 (Rotary type) × 1	
Motor		kW	–	1.9	
Starting method			–	Line starting	
Heat exchanger			Louver fins & tubing		
Refrigerant control			Capillary tubes		
Refrigerant ⁽⁴⁾		kg	R22 1.35		
Refrigerant oil		ℓ	0.7 (BARREL FREEZE 32SAM)		
Air handling equipment					
Fan type & Q'ty			Tangential fan × 1	Propeller fan × 1	
Motor		W	23	40	
Air flow (at High)		CMM	12/12	34/34	
Air filter, Q'ty			Polypropylene net (washable) × 2	–	
Shock & vibration absorber			–	Cushion rubber (for compressor)	
Electric heater			–	–	
Operation control					
Operation switch			Wireless-Remote controller	–	
Room temperature control			MC. Thermostat	–	
Pilot lamp			RUN (Green), TIMER (Yellow), ECONO (Orange), HI POWER (Green)	–	
Safety equipment			–	Dome mounted protector (for compressor) Internal thermostat (for fan motor)	
Refrigerant piping	O.D	mm (in)	Liquid line: φ6.35 (1/4") Gas line: φ12.7 (1/2")		
	Connecting method		Flare connecting		
	Attached length of piping		Liquid line: 0.4m Gas line : 0.35m	–	
	Insulation		Necessary (Both sides)		
Drain hose			Connectable		
Power source cord			2.5 m (3 cores with Earth)		
Connection wiring	Size × Core number		1.5 mm ² × 3 cores (Including earth cable)		
	Connecting method		Terminal block (Screw fixing type)		
Accessories (included)			Mounting kit		
Optional parts			–		

Notes (1) The data are measured at the following conditions.

Operation	Item	Indoor air temperature		Outdoor air temperature		Standards
		DB	WB	DB	WB	
Cooling		27°C	19°C	35°C	24°C	JIS C9612, ISO-T1

(2) The operation data are applied to the 220 V or 240 V districts respectively.

(3) Limitation of Voltage application

Minimum: 198 V Maximum: 264 V

(4) The refrigerant quantity to be charged includes the refrigerant in 7.5 m connecting piping.

(Purging is not required even in the short piping.)

If the piping length is longer, (when it is less than 10 m, add 10 g refrigerant per meter and when it is 10 to 15 m, add 30 g refrigerant per meter.)

(5) Expressed in sound pressure level.

3.2.2 Range of usage & limitations

(1) Inlet air temperature range

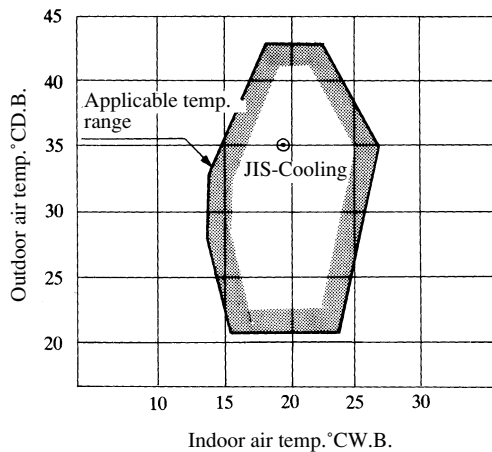

Note: The chart is the result from the continuous operation under constant air temperature conditions, however, excludes the initial pull-down stage.

(2) Total one way piping length and vertical height difference.

Item		Models	All models
Total one way piping length (m)			15
Vertical height difference (m)	Outdoor unit is higher		5
	Outdoor unit is lower		5

(3) Voltage application

Item		Models	All models
Minimum (V)			198
Maximum (V)			264

3.2.3 Exterior dimensions

(1) Indoor unit

Models **SRK501CENF-L, 561CENF-L**

Unit: mm

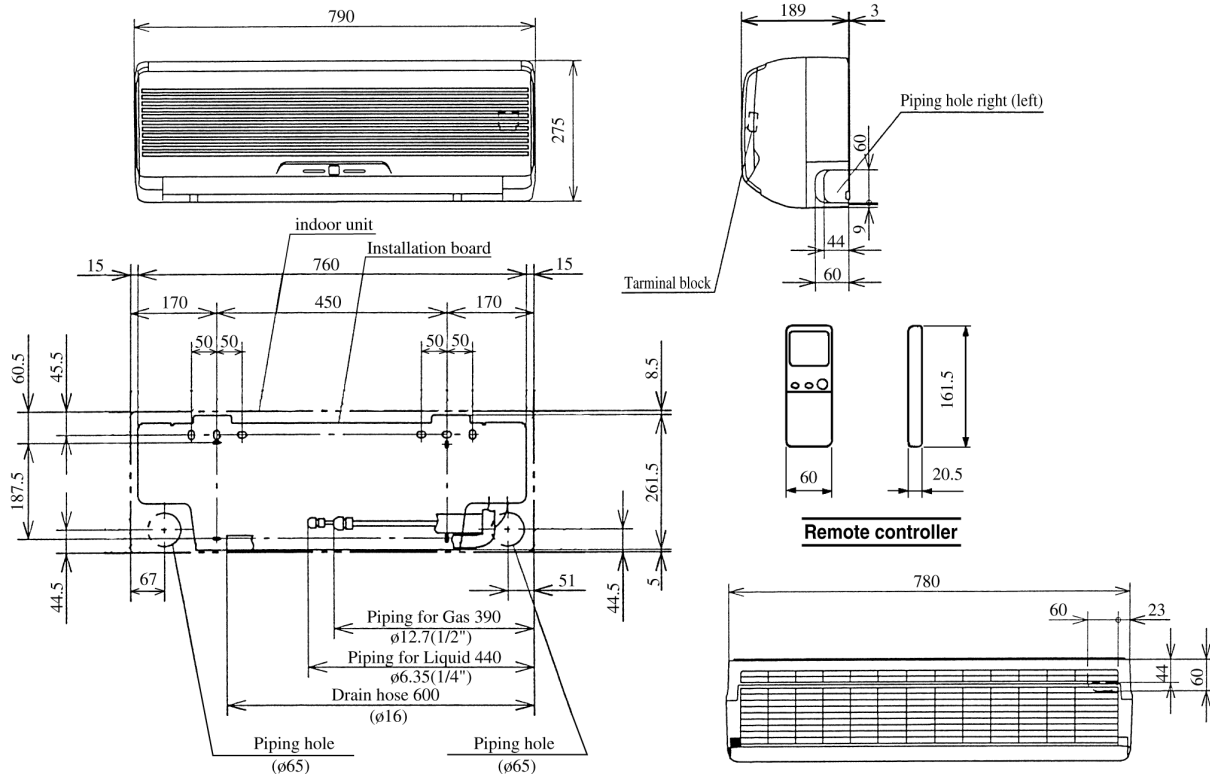

(2) Outdoor unit

Models **SRC501CENF-L, 561CENF-L**

Unit: mm

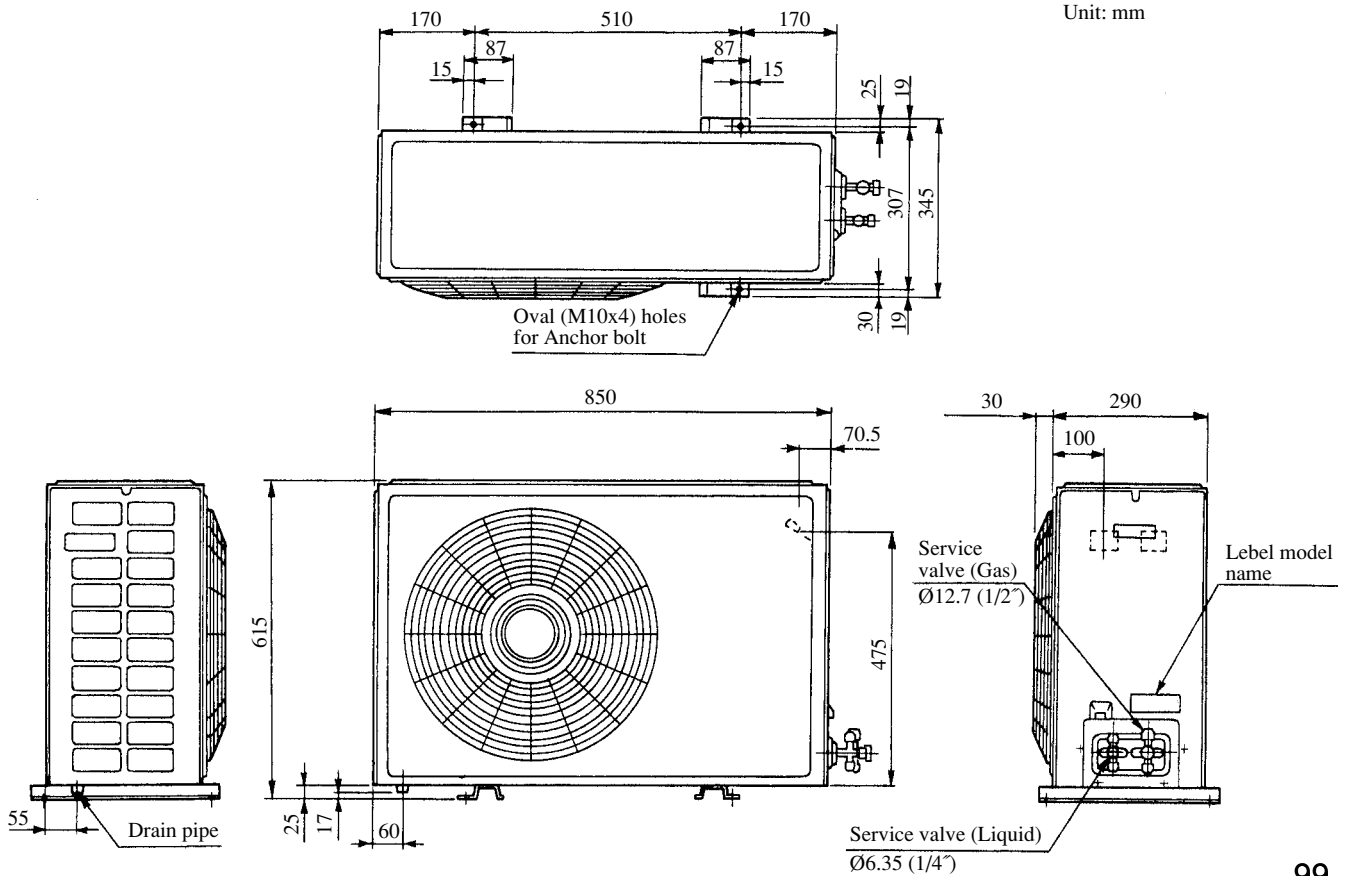

3.2.4 Piping system

Models SRK501CENF-L, 561CENF-L

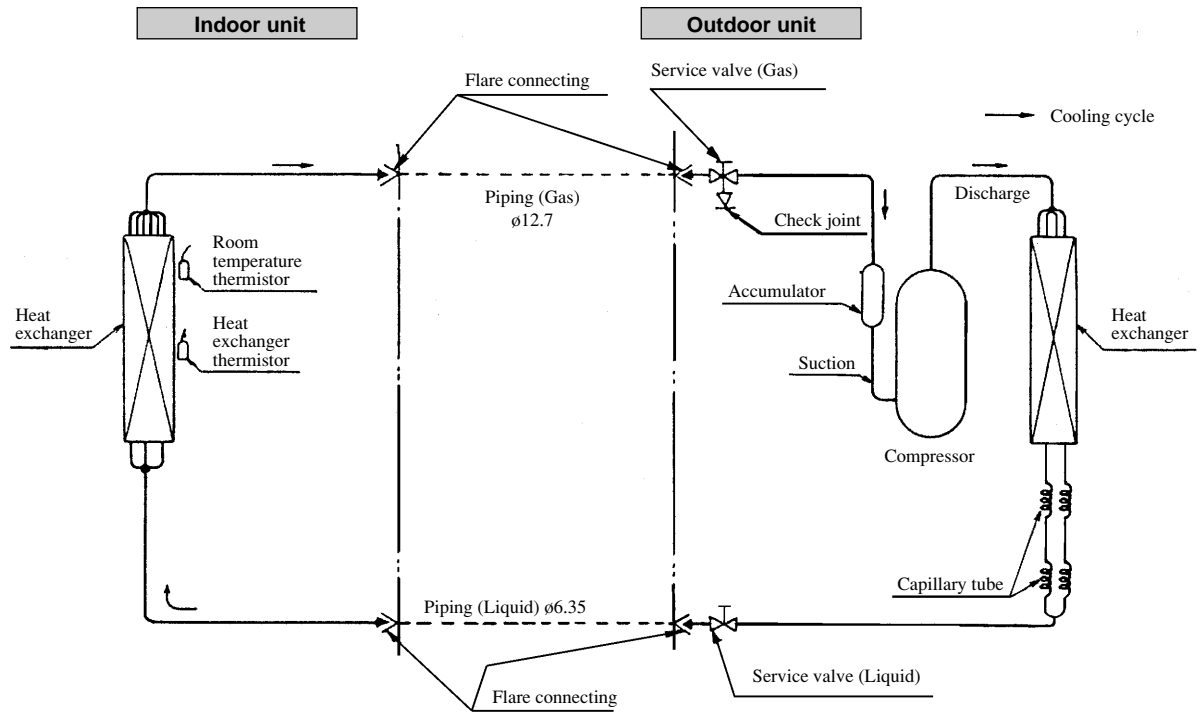

3.3 ELECTRICAL DATA

3.3.1 Electrical wiring

Models SRK501CENF-L, 561CENF-L

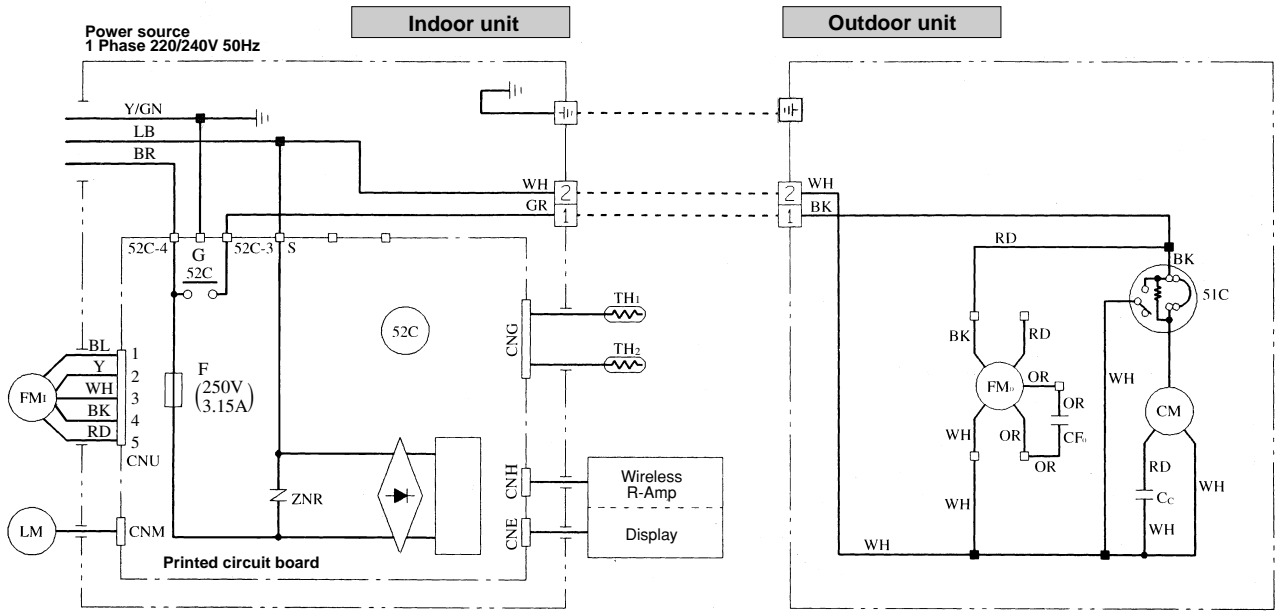

BK	Black
BL	Blue
BR	Brown
RD	Red
OR	Orange
WH	White
Y	Yellow
LB	Light blue
Y/GN	Yellow/Green

Symbol	Parts name	Symbol	Parts name
C _c	Capacitor for CM	LM	Louver motor
CF _o	Capacitor for FM _o	Th _{1, 2}	Thermistor
CM	Compressor motor	ZNR	Varistor
F	Fuse	51C	Motor protector for CM
FM _i	Fan motor (Indoor unit)	52C	Magnetic contactor for CM
FM _o	Fan motor (Outdoor unit)		

Relay symbol	Operation	
	Control part	Cooling
52C	CM	○

Notes (1) ○ : denotes magnetized relay ×: denotes demagnetized relay
 (2) Th₁ is room temperature thermistor. Th₂ (the heat exchanger thermistor) is frost prevention thermistor.
 (for details, refer to pages 74)

3.4 FUNCTIONS

Except for function relating to heating, same at the for SRK heat pump models, See Page 65.

3.5 APPLICATION DATA

The application data for the cooling only models are similar to those for the heat pump models. See Page 77.

3.6 MAINTENANCE DATA

Some at the cooling/heating equipment SRK heat pump models. See Page 85.