



Atrium H & C Loggia

Installation instruction
Installationsvejledning
Montageanvisning
Asennusohje
Montageanweisung
Istruzioni di montaggio
Instruction de montage



Content

Delivery control
View
Mounting
Water connection
False ceiling adaptation

Page

2
2
3
4
5



Atrium H & C/Loggia

Delivery control

Control the delivery!

Example of delivery code:

Atrium H & C/Loggia - 60 - 10 - 1 - 4,8 m.

Width, cm _____
 Water connection, mm _____
 Pipe connection type _____
 Length, m. _____

Way of mounting	Included mounting details
Free mounted	4-6 adjustable pendulums (alternative chains) 4-6 angle brackets panel
Direct to ceiling	4-6 angle brackets outer

4 wire springs included for all panels with vertical water connections.

There are also included support sleeves that must be used in every connection pipe. The amount of pendulums/angle brackets panel or outer depends on the length. Up to 4,0 m. are 4 pieces included of each. At lengths above 4,0 m. are 6 pieces of each included.

View

Atrium H/C and Loggia could be mounted either direct to the concrete or hanging in pendulums. Atrium C and Loggia could also be integrated into false ceilings.

Direct to concrete



Free hanging

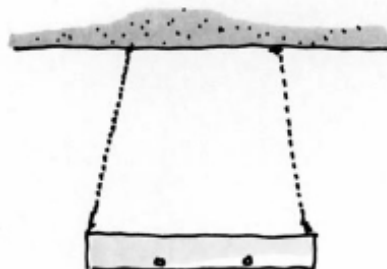

Integrated into false ceilings

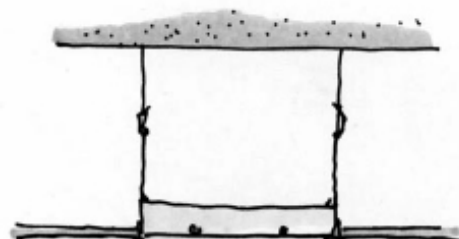



Atrium H & C/Loggia

Mounting with adjustable pendulums

1.- Measure and drill into the ceiling for the strips/panels brackets. 4 pieces for lengths up to 4,0 m., 6 pieces for longer units.

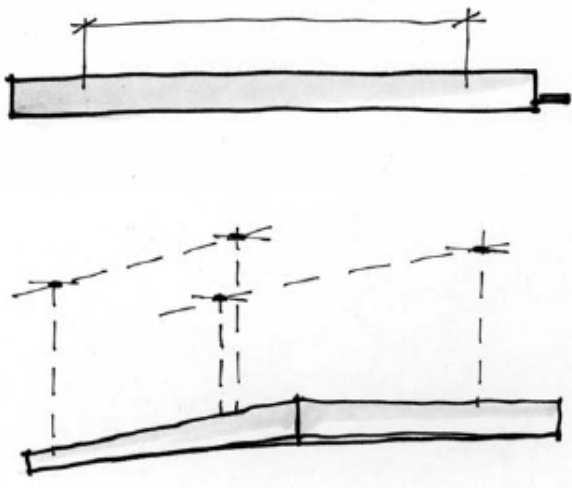

2.- Screw up the brackets into the ceiling

3.- Hang up the pendulums into these brackets.

4.- Hang up the strips/panel with the angle brackets panel into the edge of the panel and connect the pendulums into these.

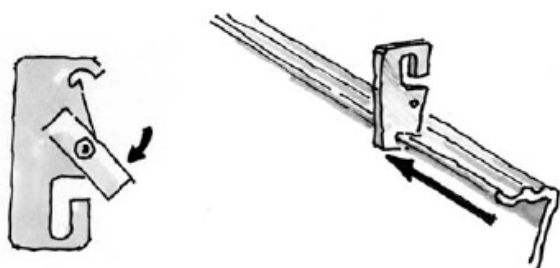

5.- Adjust the length of the pendulums. Also adjust after the false ceiling height if it's mounted into this.

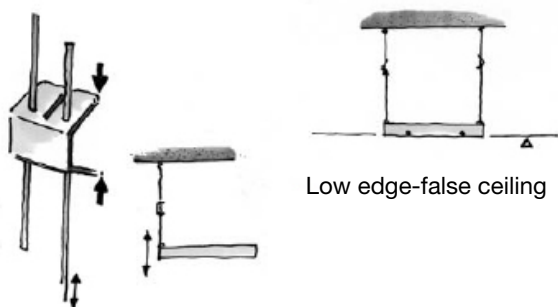

Mounting in chains

1.- Measure and drill into the ceiling for the strips/panels brackets. 4 pieces for lengths up to 4,0 m., 6 pieces for longer units. Observe that the chains must be angled inwards so the angle brackets will be secured.

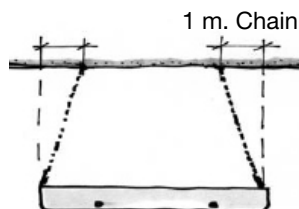

2.- Screw up the brackets for the chains into the ceiling.

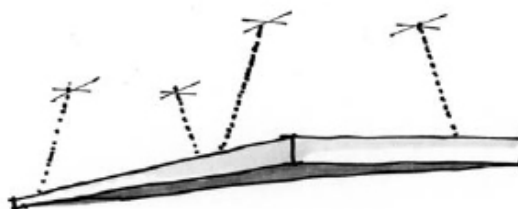

3.- Hang up the strips/panel with the angle brackets panel into the edge of the panel.

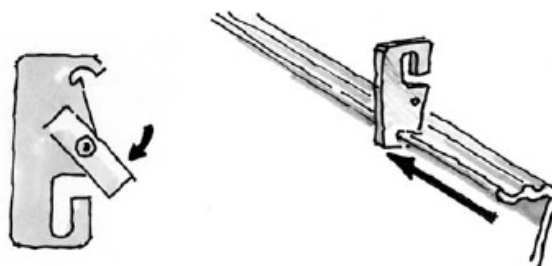

4.- Adjust the length of the chains as you see of the drawing.

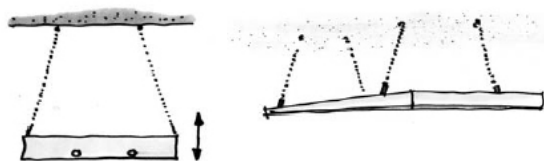

Mounting direct to concrete

1.- Measure and drill into the concrete for angle brackets outer. Use 6 pieces with lengths above 4,0 m.

20 mm.



2.- Screw up the strips/panel against the concrete.

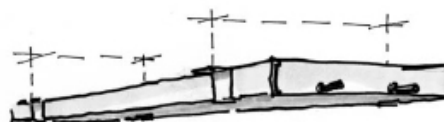



Atrium H & C/Loggia

Water connection

Connection alternatives

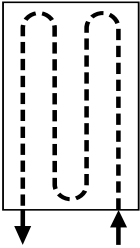
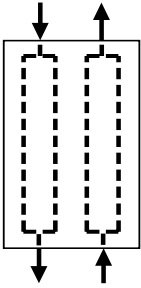
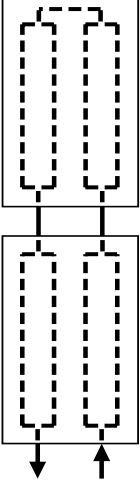
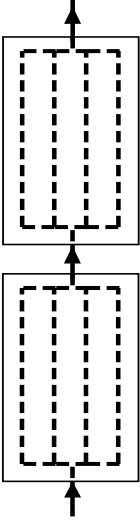
			
<p style="text-align: center;">1 (1 connected)</p> <p>The supply and return for this model are located in the same end-piece.</p> <p>This coupling is only available with one pipe dimension per panel width.</p> <p>Width 33: Ø10 mm Width 60: Ø10 + Ø12 mm Width 87: Ø10 + Ø15 mm</p>	<p style="text-align: center;">13 (double circuit)</p> <p>This model has the supply in one end-piece and the return in the other one.</p> <p>This coupling is only available with one pipe dimension per panel width.</p> <p>Width 33: Ø10 mm Width 60: Ø12 mm Width 87: Ø15 mm</p>	<p style="text-align: center;">1+13 (1 connected + double circuit)</p> <p>This model is a combination of 1 connected panel + 1 double circuit.</p> <p>This coupling is available with only one pipe dimension per panel width.</p> <p>Width 33: Ø10 mm Width 60: Ø12 mm Width 87: Ø15 mm</p>	<p style="text-align: center;">13+13 (straight through)</p> <p>This model has the supply in one end-piece and the return in the other one.</p> <p>This coupling is only available with one pipe dimension per panel width.</p> <p>Width 33: Ø12 mm Width 60: Ø15 mm Width 87: Ø22 mm</p>



Connect water with compression coupling or similar. Use the support sleeves. Do not solder!



Atrium H & C/Loggia

False ceiling adaptation (Atrium H/C)

It is best if the false ceiling installer mount some head profiles before the beams will be mounted. This is to make it easier for the beam installer. If the head profiles already are mounted is it very important that you use a line/wire to have the beams in the right position.

1. Fix the head profiles against the panel with pop rivets or screws.



2. Mount the secondary profiles around the panel. Cut of the steering pins and fix with pop rivets.

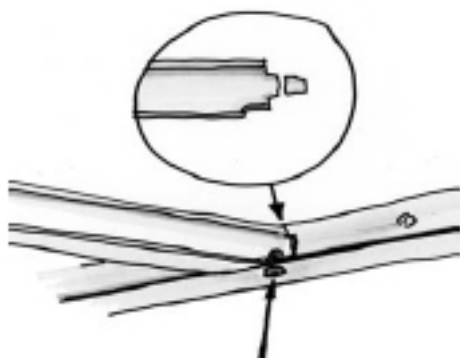

3. One of false ceiling plates and one secondary profile must be cut out, to make room for pipe connections (only with horizontal connection pipes.)

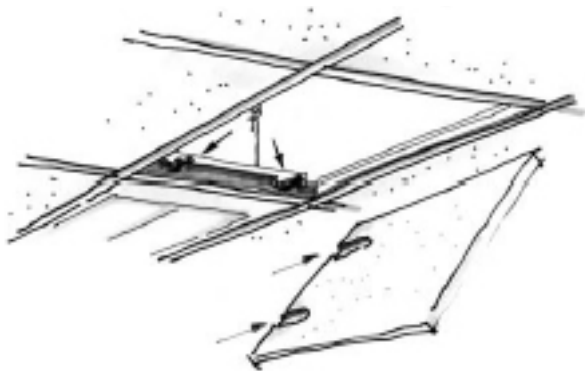

Mounting wire spring

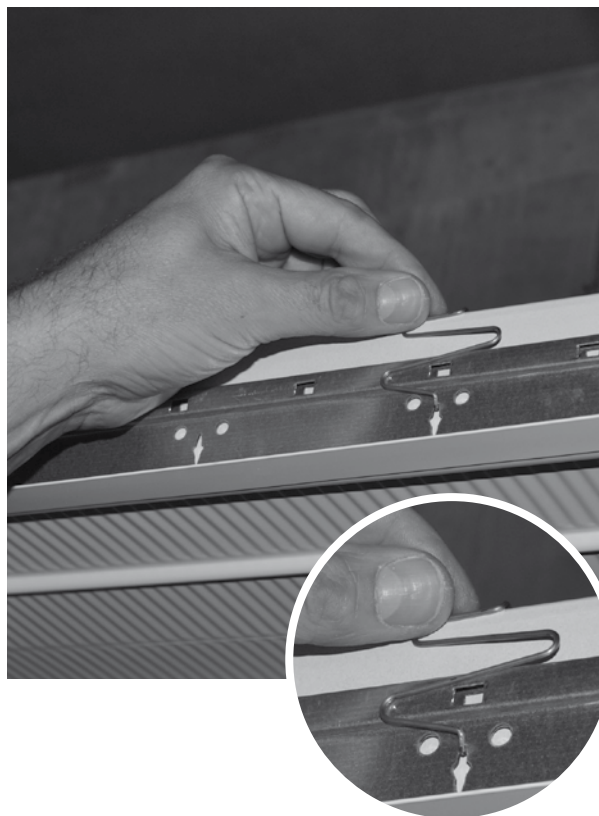

- 1.- Attach the spring into the ceiling grid.
- 2.- Press it over the top of the panel.
- 3.- Secure that the wire spring is attached between the ceiling grid and the heating panel.

Support
Hjælp
Hjälp
Tuotetuki
Unterstützung
Supporto
Support

UK - Here you can find product updates/mounting instructions and support telephone number/mail.

www.lindab.com

Right to alterations reserved.

DK - Her kan du finde seneste produkt opdateringer/ montagevejledninger samt support tlf. nr/mail.

www.lindab.dk

Ret til ændringer forbeholdes.

SE - Här kan du alltid hitta senaste produktuppdateringarna/montageanvisningarna samt support tel. /e-mail.

www.lindab.se

Rätt till ändringar förbehålles.

FI - Täältä löydät uusimmat tuotetiedot ja asennusohjeet sekä tuotetuen yhteystiedot.

www.lindab.fi

Oikeus muutoksiin pidätetään.

DE - Hier finden Sie aktuelle Produktinformationen/ Montageanleitungen und Telefonnummer/ E-Mail-Adressen der Ansprechpartner.

www.lindab.de

Änderungen vorbehalten.

IT - Qui potete trovare istruzioni di montaggio, informazioni sul prodotto ed un supporto tecnico qualificato
Tel. 011 9952099 - e-mail: lindab@lindab.it

www.lindab.it

Soggetto a modifica senza obbligo di preavviso.

FR - Vous trouverez les fiches produits ou de montage actualisées ainsi que les coordonnées du support téléphonique à l'adresse suivante :

www.lindab.fr

Toutes modifications réservées.

Do you have trouble finding your local contacts please go to:

www.lindab.com

Atrium/Loggia - 17092013



www.lindab.com