



Dampers

DRU, DSU, DTU, DTHU, DTH1U, DTH2U, DTBU



DTBCU, DTFU, DTBLU, DSUSN, DSVUSN, DTPU, PSDRU, TDRU, TDSU



TASU, TATU, TATBU, LKSR



DAU, DA2EU, DAVU, CARU, CAR, MBU, MBFU



FMU, FMDRU, FMDU, DIRU, DIRBU, DIRVU





Dampers

DRU, DSU, DTU, DTHU, DTH1U, DTH2U, DTBU, DTBCU, DTFU, DTBLU, DSUSN, DSVUSN, DTPU, PSDRU, TDRU, TDSU, TASU, TATU, TATBU

Assembly

In order to fulfil the requirements for air-tightness class D, the dampers must be installed as per 'Assembly Instruction Lindab Safe'.

For certain manual dampers, there is the option of adding a motor later on.

The dampers allow 50 mm duct insulation without the knob being hidden. For 100 mm duct insulation, there is an insulation cup, IK, for DRU, DSU, DTU, TASU and TATU.

PSDRU, TDRU and TDSU

The dampers are installed by inserting the two guide pins on the T-piece or saddle into the L-shaped slots on the dampers. The dampers are then locked by turning them slightly clockwise.

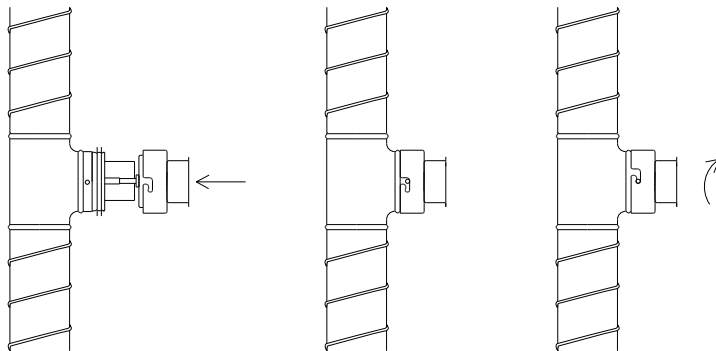

Balancing

On DRU, PSDRU and TDRU the damper blade is stepless adjustable through 0–90° (0°=fully open, 90°=completely closed) using the knob in the cup. Locking is performed using screws for Pozidrive (PZD2) and the damper angle can be read off a stamped grade on the edge of the cup. Other types of damper normally only work in the fully open or completely closed positions.

On motorized shut-off dampers and dampers adapted for a motor, the shaft end for the motor is equipped with a notch showing the position of the damper blade.

Manual dampers $\varnothing < 355$ can be supplemented with a sturdy handle to facilitate adjustment. Larger dimensions are equipped with a handle as standard.

Maintenance

Dampers and motors normally don't require any maintenance.

CE marking

Our dampers with electrical actuator are regarded as a component in the duct system and does not need to be CE marked separately.

Their electrical actuators on the other hand are part of the electrical system and are CE marked. Declaration of compliance with the essential requirements can be found at www.belimo.ch.



Dampers

DRU, DSU, DTU, DTHU, DTH1U, DTH2U, DTBU, DTBCU, DTFU, DTBLU, DSUSN, DSVUSN, DTPU, PSDRU, TDRU, TDSU, TASU, TATU, TATBU

GM 24 F
 Power supply..... AC 19,2–28,8 V, 50/60 Hz
 DC 19,2–28,8 V
 Power consumption 0,5 W
 For wire sizing 1 VA
 Connection Cable 1 m, 3x0,75 mm²
 Operating angle..... Continuously rotating
 Torque at rated voltage..... Min. 2 Nm
 Direction of rotation..... -L or -R
 Position indication Mechanical, removable
 Running time for 95° 75 s
 Sound power level..... Max. 35 dB (A)
 Protection class..... III Safety extra-low voltage
 Protection type..... IP 54
 Ambient temperature range -30 to +50°C
 Ambient moisture 95 % RF

GM 230 F
 Power supply..... AC 65–265 V, 50/60 Hz
 Power consumption 1,5 W
 For wire sizing 3 VA
 Connection Cable 1 m, 3x0,75 mm²
 Operating angle..... Max. 95°, adjustable 0–100%
 Torque at rated voltage..... Min. 2 Nm
 Direction of rotation..... -L or -R
 Position indication Mechanical, removable
 Running time for 95° 75 s
 Sound power level..... Max. 35 dB (A)
 Protection class..... II Safety insulated
 Protection type..... IP 54
 Ambient temperature range -30 to +50°C
 Ambient moisture 95 % RF

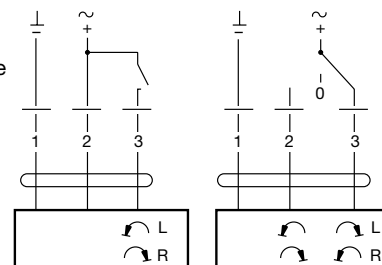

GM 24 A
 Power supply..... AC 19,2–28,8 V, 50/60 Hz
 DC 19,2–28,8 V
 Power consumption 4,5 W
 For wire sizing 7 VA
 Connection Cable 1 m, 3x0,75 mm²
 Operating angle..... Max. 95°, adjustable 0–100%
 Torque at rated voltage..... Min. 40 Nm
 Direction of rotation..... Switch selectable
 0 or 1
 Position indication Mechanical
 Running time for 95° 150 s
 Sound power level..... Max. 45 dB (A)
 Protection class..... III Safety extra-low voltage
 Protection type..... IP 54
 Ambient temperature range -30 to +50°C
 Ambient moisture 95 % RH

GM 230 A
 Power supply..... AC 85–265 V, 50/60 Hz
 Power consumption 4,5 W
 For wire sizing 7 VA
 Connection Cable 1 m, 3x0,75 mm²
 Operating angle..... Max. 95°, adjustable 0–100%
 Torque at rated voltage..... Min. 40 Nm
 Direction of rotation..... Switch selectable
 0 or 1
 Position indication Mechanical
 Running time for 95° 150 s
 Sound power level..... Max. 45 dB (A)
 Protection class..... II Safety insulated
 Protection type..... IP 54
 Ambient temperature range -30 to +50°C
 Ambient moisture 95 % RH

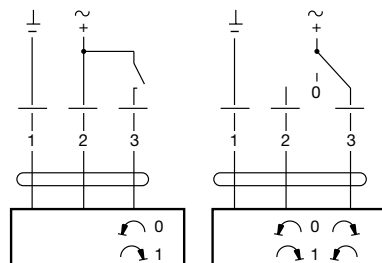

LF 24
 Power supply..... 2AC 19,2–28,8 V, 50/60 Hz
 DC 21,6–28,8 V
 Power consumption
 – during opening..... 5 W
 – stand-by 2,5 W
 For wire sizing 7 VA
 Connection Cable 1 m, 2x0,75 mm²
 Operating angle, adjustable Mech. limited to 95°
 Torque at rated voltage
 – motor Min. 4 Nm
 – return spring Min. 4 Nm
 Direction of rotation..... Optional through right or left-hand installation L/R
 Position indication Mechanical
 Running time
 – motor 40–75 s (0–4 Nm)
 – return spring app. 20 s
 Sound power level
 – motor max 50 dB (A)
 – return spring app. 62 dB (A)
 Degree of protection..... IP 54
 Ambient temperature range -30 to +50°C

LF 230
 Power supply..... AC 198–264 V, 50/60 Hz
 Power consumption
 – during opening..... 5 W
 – stand-by 3 W
 For wire sizing 7 VA
 Connection Cable 1 m, 2x0,75 mm²
 Operating angle, adjustable Mech. limited to 95°
 Torque at rated voltage
 – motor Min. 4 Nm
 – return spring Min. 4 Nm
 Direction of rotation..... Optional through right or left-hand installation L/R
 Position indication Mechanical
 Running time
 – motor 40–75 s (0–4 Nm)
 – return spring app. 20 s
 Sound power level
 – motor max 50 dB (A)
 – return spring app. 62 dB (A)
 Degree of protection..... IP 54
 Ambient temperature range -30 to +50°C

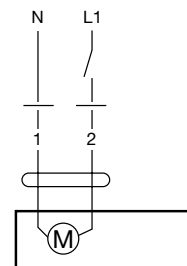



Dampers

DRU, DSU, DTU, DTHU, DTH1U, DTH2U, DTBU, DTBCU, DTFU, DTBLU, DSUSN, DSVUSN, DTPU, PSDRU, TDRU, TDSU, TASU, TATU, TATBU

Power supply.....	LM 24 A-F AC 19,2–28,8 V, 50/60 Hz DC 19,2–28,8 V	LM 230 A-F AC 65–265 V, 50/60 Hz
Power consumption	1 W	1,5 W
For wire sizing	2 VA	4 VA
Connection	Cable 1 m, 3×0,75 mm ²	Cable 1 m, 3×0,75 mm ²
Operating angle.....	Max. 95°, adjustable 0–100%	Max. 95°, adjustable 0–100%
Torque at rated voltage.....	Min. 5 Nm	Min. 5 Nm
Direction of rotation.....	Switch selectable 0 ↺ or 1 ↻	Switch selectable 0 ↺ or 1 ↻
Position indication.....	Mechanical	Mechanical
Running time for 95°	150 s	150 s
Sound power level.....	Max. 35 dB (A)	Max. 35 dB (A)
Protection class.....	III Safety extra-low voltage	II Safety insulated
Protection type	IP 54	IP 54
Ambient temperature range	-30 to +50°C	-30 to +50°C
Ambient moisture	95 % RH	95 % RH

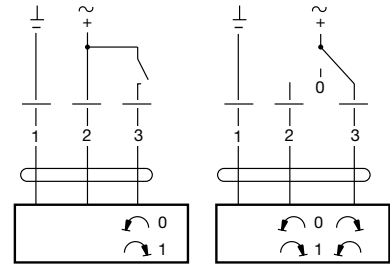

Power supply.....	LM 24-SR AC 19,2–28,8 V, 50/60 Hz DC 19,2–28,8 V	LM 230-SR AC 230 V, 50/60 Hz
Power consumption	1 W	1,8 W
For wire sizing	2 VA	4 VA
Connection	Cable 1 m, 4×0,75 mm ²	Cable 1 m, 2×0,75 mm ²
Operating angle.....	Max. 95°, adjustable	Max. 95°, adjustable
Torque at rated voltage.....	Min. 5 Nm	Min. 5 Nm
Direction of rotation.....	Switch selectable 0 ↺ or 1 ↻	Switch selectable 0 ↺ or 1 ↻
Position indication.....	Mechanical	Mechanical
Running time for 95°	150 s	150 s
Sound power level.....	35 dB (A)	35 dB (A)
Protection class.....	III Safety extra-low voltage	II
Protection type	IP 54	IP 54
Ambient temperature range	-30 to +50°C	-30 to +50°C
Ambient moisture	95 % RH	95 % RH

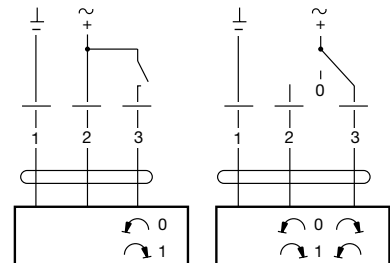

Power supply.....	LM 24 A-SR AC 24 V, 50/60 Hz DC 24 V
Power consumption	1 W
For wire sizing	2 VA
Connection	Cable 1 m, 4×0,75 mm ²
Operating angle.....	Max. 95°, adjustable 0–100%
Torque at rated voltage.....	Min. 5 Nm
Direction of rotation.....	Switch selectable 0 ↺ or 1 ↻
Position indication.....	Mechanical
Running time for 95°.....	150 s
Sound power level.....	Max. 35 dB (A)
Protection class.....	III Safety extra-low voltage
Protection type	IP 54
Ambient temperature range	-30 to +50°C
Ambient moisture	95 % RF

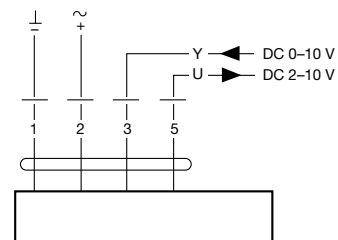



Dampers

DRU, DSU, DTU, DTHU, DTH1U, DTH2U, DTBU, DTBCU, DTFU, DTBLU, DSUSN, DSVUSN, DTPU, PSDRU, TDRU, TDSU, TASU, TATU, TATBU

	LM 24 A-SX
Power supply.....	AC 19,2–28,8 V, 50/60 Hz
DC 21,6–28,8 V	
Power consumption	2 W
For wire sizing	4 VA
Connection	Cable 1 m, 4x0,75 mm ²
Operating angle.....	Max. 95°, adjustable 0–100 %
Torque at nominal voltage.....	Min. 5 Nm
Direction of rotation.....	Switch selectable 0/1
Position at Y=0 V.....	Switch selectable 0 or 1
Position indication.....	Mechanical
Running time for 90°	150 s
Sound power level.....	35 dB (A)
Protection class.....	III Safety extra-low voltage
Protection type	IP 54
Ambient temperature range	-30 to +50 °C
Ambient humidity	95 % RH

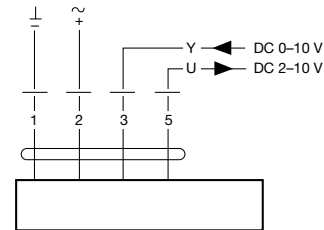

	LMQ 24A	LMQ-SR 24A
Power supply.....	AC 19,2-28,8 V, 50/60 Hz	AC 19,2-28,8 V, 50/60 Hz
.....	DC 21,6-28,8 V	DC 21,6-28,8 V
Power consumption	13 W	12 W
For wire sizing	23 VA	23 VA
Connection	Cable 1 m, 3x0,75 mm ²	Cable 1 m, 4x0,75 mm ²
Operating angle.....	Max. 95°, adjustable 0-100 %	Max. 95°, adjustable 0-100 %
Torque at rated voltage.....	Min. 4 Nm	Min. 4 Nm
Direction of rotation.....	Switch selectable 0 or 1	Switch selectable 0 or 1
Position indication.....	Mechanical	Mechanical
Running time for 90°	2,5 s	2,5 s
Sound power level.....	52 dB (A)	52 dB (A)
Protection class.....	III Safety extra-low voltage	II Safety insulated
Protection type	IP 54	IP 54
Ambient temperature range	-30 to +40°C	-30 to +40°C
Ambient moisture	95 % RH	95 % RH

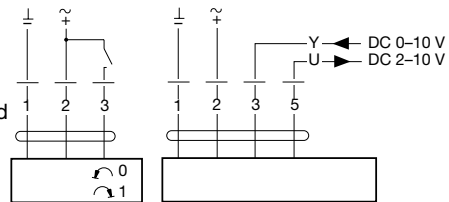

	NM 24 A-F	NM 230 A-F
Power supply.....	AC 19,2–28,8 V, 50/60 Hz	AC 85–265 V, 50/60 Hz
.....	DC 19,2–28,8 V	
Power consumption	1,5 W	2,5 W
For wire sizing	3,5 VA	6 VA
Connection	Cable 1 m, 3x0,75 mm ²	Cable 1 m, 3x0,75 mm ²
Operating angle.....	Max. 95°, adjustable 0–100%	Max. 95°, adjustable 0–100 %
Torque at rated voltage.....	Min. 10 Nm	Min. 10 Nm
Direction of rotation.....	Switch selectable 0 or 1	Switch selectable 0 or 1
Position indication.....	Mechanical	Mechanical
Running time for 95°	150 s	150 s
Sound power level.....	Max. 35 dB (A)	Max. 35 dB (A)
Protection class.....	III Safety extra-low voltage	II Safety insulated
Protection type	IP 54	IP 54
Ambient temperature range	-30 to +50°C	-30 to +50°C
Ambient moisture	95 % RH	95 % RH

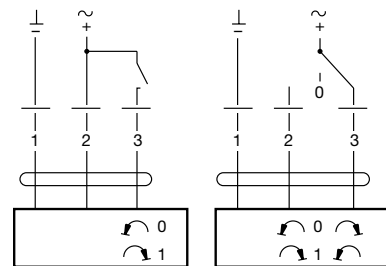



Dampers

DRU, DSU, DTU, DTHU, DTH1U, DTH2U, DTBU, DTBCU, DTFU, DTBLU, DSUSN, DSVUSN, DTPU, PSDRU, TDRU, TDSU, TASU, TATU, TATBU

	SF 24A	SF 230A
Voltage range	AC 19,2–28,8 V, 50/60 Hz DC 21,6–28,8 V	AC 195–264 V, 50/60 Hz
Power consumption		
– during operation	5 W	6,5 W
– stand-by	2,5 W	3,5 W
For wire sizing	7,5 VA	18 VA
Connection	Cable 1 m, 2x0,75 mm ²	Cable 1 m, 2x0,75 mm ²
Operating angle, adjustable	Mech. limited to 95°	Mech. limited to 95°
Torque at rated voltage		
– motor	Min. 20 Nm	Min. 20 Nm
– spring bias	Min. 20 Nm	Min. 20 Nm
Direction of rotation	Optional through right or	Optional through right or
left-hand installation L/R		left-hand installation L/R
Position indication	Mechanical	Mechanical
Running time		
– motor	≤ 75 s	≤ 75 s
– return spring	≤ 20 s	≤ 20 s
Sound power level		
– motor	≤ 45 dB (A)	≤ 45 dB (A)
– return spring	≤ 62 dB (A)	≤ 62 dB (A)
Degree of protection	IP 54	IP 54
Ambient temperature range	-30 to +50 °C	-30 to +50 °C
Ambient temperature range	-30 to +50 °C	-30 to +50 °C

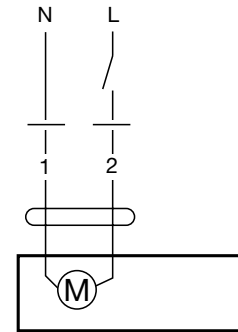

	SM 24 A	SM 230 A
Power supply	AC 19,2–28,8 V, 50/60 Hz DC 19,2–28,8 V	AC 85–265 V, 50/60 Hz
Power consumption	2 W	2,5 W
For wire sizing	4 VA	6 VA
Connection	Cable 1 m, 3x0,75 mm ²	Cable 1 m, 3x0,75 mm ²
Operating angle	Max. 95°, adjustable 0–100%	Max. 95°, adjustable 0–100%
Torque at rated voltage	Min. 20 Nm	Min. 20 Nm
Direction of rotation	Switch selectable 0 ↺ or 1 ↻	Switch selectable 0 ↺ or 1 ↻
Position indication	Mechanical	Mechanical
Running time for 95°	150 s	150 s
Sound power level	Max. 35 dB (A)	Max. 35 dB (A)
Protection class	III Safety extra-low voltage	II Safety insulated
Protection type	IP 54	IP 54
Ambient temperature range	-30 to +50 °C	-30 to +50 °C
Ambient moisture	95 % RH	95 % RH

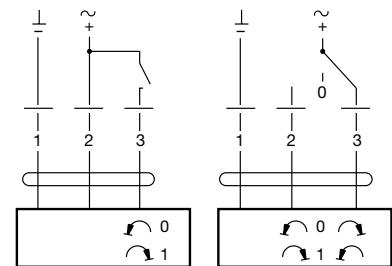



Dampers

DRU, DSU, DTU, DTHU, DTH1U, DTH2U, DTBU, DTBCU, DTFU, DTBLU, DSUSN, DSVUSN, DTPU, PSDRU, TDRU, TDSU, TASU, TATU, TATBU

	TF 24	TF 230
Voltage range	2AC 19,2–28,8 V, 50/60 Hz DC 21,6–28,8 V	AC 85–265 V, 50/60 Hz
Power consumption		
– during opening	2,5 W	2,5 W
– stand-by	1,5 W	1,5 W
For wire sizing	5 VA	5 VA
Connection	Cable 1 m, 2x0,75 mm ²	Cable 1 m, 2x0,75 mm ²
Operating angle, adjustable	Mech. limited to 95°	Mech. limited to 95°
Torque at rated voltage		
– motor	Min. 2 Nm	Min. 2 Nm
– return spring	Min. 2 Nm	Min. 2 Nm
Direction of rotation	Optional through right or	Optional through right or
left-hand installation L/R		left-hand installation L/R
Position indication	Mechanical	Mechanical
Running time		
– motor	< 75 s (0–2 Nm)	< 75 s (0–2 Nm)
– return spring	< 25 s	< 25 s
Degree of protection	IP 42	IP 42
Ambient temperature range	-30 to +50°C	-30 to +50°C

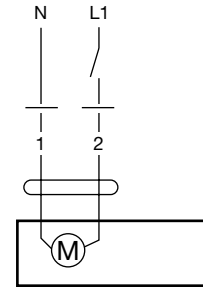

	CM 24	CM 230
Power supply	AC 24 V, 50/60 Hz DC 24 V	AC 100–240 V, 50/60 Hz
Power consumption	0,5 W	1,5 W
For wire sizing	1 VA	3 VA
Connection	Cable 1 m, 3x0,75 mm ²	Cable 1 m, 3x0,75 mm ²
Torque at rated voltage	Min. 2 Nm	Min. 2 Nm
Direction of rotation	Switch selectable 0 or 1	Switch selectable 0 or 1
Running time for 95°	75 s	75 s
Sound power level	Max. 35 dB (A)	Max. 35 dB (A)
Protection class	III Safety extra-low voltage	II
Protection type	IP 54	IP 54
Ambient temperature range	-30 to +50°C	-30 to +50°C
Ambient moisture	95 % RH	95 % RH

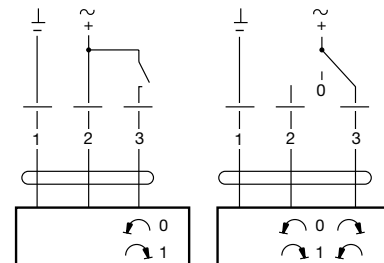

	CM 24 SR
Power supply	AC 24 V, 50/60 Hz DC 24 V
Power consumption	0,5 W
For wire sizing	2 VA
Connection	Cable 1 m, 4x0,75 mm ²
Torque at rated voltage	Min. 2 Nm
Direction of rotation	Switch selectable 0 or 1
Running time for 95°	75 s
Sound power level	Max. 35 dB (A)
Protection class	III Safety extra-low voltage
Protection type	IP 54
Ambient temperature range	-30 to +50°C
Ambient moisture	95 % RH

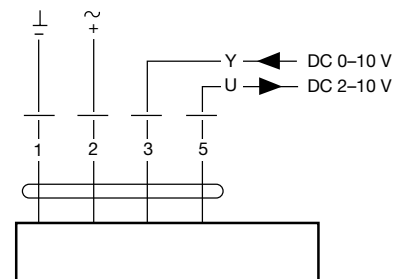



Dampers

LKSR

Assembly

In order to fulfil the requirements for air-tightness class C, the damper must be installed as per 'Assembly Instruction Rectangular air duct systems'.

For the damper, there is the option of adding a motor later on.

The damper allows a 50 mm duct insulation without the knob being hidden. For 100 mm insulation, an insulation cup, IK, is available.

Balancing

On LKSR the damper blade is adjusted through 0–90° (0° = fully open, 90° = completely closed) using the knob in the cup. Locking is performed using screws for Pozidrive (PZD2) and the damper angle can be read off a stamped grade on the edge of the cup.

Manual damper can be supplemented with a sturdy handle to facilitate adjustment.

Maintenance

The damper and motor normally don't require any maintenance.



Constant/variable flow dampers

DAU, DA2EU, DAVU

Assembly

In order to fulfil the requirements for air-tightness class D, the devices must be installed as per 'Assembly Instruction Lindab Safe'.

The devices must be installed with the air flow in the direction of the arrow.

The devices allow 50 mm duct insulation without the scale or any motor being hidden.

Pressure range

50–1000 Pa over the unit.

Interference sensitivity

In order to achieve stated precision for the set flow, a straight duct of at least 3×d before and 1.5×d after the devices is required. A assembly close to a source of interference (bend, saddle, etc.) reduces control accuracy and the flow can deviate from the set value.

Changes in direction

The units are independent of their direction of installation; you can deviate from the projected direction and install them in any direction you like without affecting accuracy.

Systematic error

Control accuracy

The devices are calibrated within their entire operating range at the factory. This means the devices keep the flow constant to within approx. ± 5 to ± 10 % of the set flow. Larger deviations occur at lower flows, especially with small sizes.

Maintenance

The devices normally don't require any maintenance, but should be protected from contaminated air wherever possible.

CE marking

Our dampers with electrical actuator are regarded as a component in the duct system and does not need to be CE marked separately.

Their electrical actuators on the other hand are part of the electrical system and are CE marked. Declaration of compliance with the essential requirements can be found at www.belimo.ch.

Balancing

DAU

The flow is adjusted by loosening the central nut and using the knob to turn the scale arrow so that it points to the desired flow on the scale. The nut is then locked.

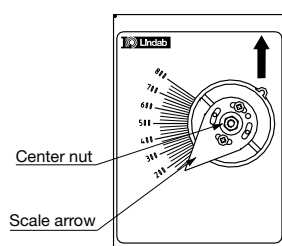



Constant/variable flow dampers

DAU, DA2EU, DAVU

DA2EU

Setting of flows

The two flows are set by moving the end stops. At delivery the stops are set at largest possible distance. If you want to limit the flow span proceed in the following way:

1. The one flow is set by turning the spindle so that the scale arrow points at the desired flow and thereafter move one of the end stops close up to the clamp's one heel and lock the stop there.
2. The other flow is set by turning the spindle so that the scale arrow points at this flow and thereafter move the other end stop close up to the clamp's other heel and lock this stop there.

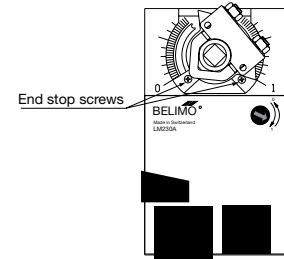

Choice of flows

The one flow is chosen by feeding an operating voltage. This voltage, 24 or 230 V, turns the motor to one of the stops.

The other flow is chosen by breaking the operating voltage. The motor then goes to the other stop.

Technical data for the motors

	LM 24 A	LM 230 A
Power supply.....	AC 19,2–28,8 V, 50/60 Hz DC 19,2–28,8 V	AC 65–265 V, 50/60 Hz
Power consumption	1 W	1,5 W
For wire sizing	2 VA	4 VA
Connection	Cable 1 m, 3×0,75 mm ²	Cable 1 m, 3×0,75 mm ²
Operating angle	Max. 95°, adjustable 0–100%	Max. 95°, adjustable 0–100%
Torque at rated voltage.....	Min. 5 Nm	Min. 5 Nm
Direction of rotation.....	Switch selectable 0 ↺ or 1 ↻	Switch selectable 0 ↺ or 1 ↻
Position indication	Mechanical	Mechanical
Running time for 95°	150 s	150 s
Sound power level.....	Max. 35 dB (A)	Max. 35 dB (A)
Protection class.....	III Safety extra-low voltage	II Safety insulated
Protection type.....	IP 54	IP 54
Ambient temperature range	-30 to +50°C	-30 to +50°C
Ambient moisture	95 % RH	95 % RH

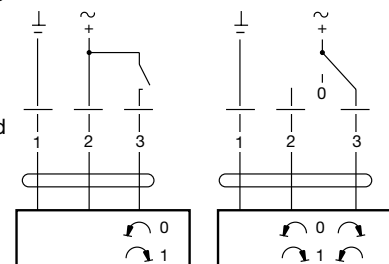



Constant/variable flow dampers

DAU, DA2EU, DAVU

DAVU

Setting of flow limits

The two flow limits are set by moving the end stops. At delivery the stops are set at largest possible distance. If you want to limit the flow span proceed in the following way:

1. The one flow limit is set by turning the spindle so that the scale arrow points at the desired flow and thereafter move one of the end stops close up to the clamp's one heel and lock the stop there.
2. The other flow limit is set by turning the spindle so that the scale arrow points at this flow and thereafter move the other end stop close up to the clamp's other heel and lock this stop there.
3. The motor shall then be adapted so that the regulating span 2–10 V adapts to the thus set flow span. This is done by a push on the "gear disengagement" button. The motor then automatically performs a stroke between the flow limits.

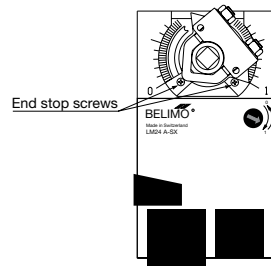

Choice of flow

The flow is chosen by feeding a control signal. This signal, 2–10 V, sets the motor in a proportional position between the flow limits.

Technical data for the motor

	LM 24 A-SX
Power supply.....	AC 19,2–28,8 V, 50/60 Hz DC 21,6–28,8 V
Power consumption	2 W
For wire sizing	4 VA
Connection	Cable 1 m, 4x0,75 mm ²
Operating angle.....	Max. 95°, adjustable 0–100 %
Torque at nominal voltage	Min. 5 Nm
Direction of rotation.....	Switch selectable 0/1
Position at Y=0 V.....	Switch selectable 0 or 1
Position indication	Mechanical
Running time for 90°	150 s
Sound power level.....	35 dB (A)
Protection class.....	III Safety extra-low voltage
Protection type.....	IP 54
Ambient temperature range	-30 to +50 °C
Ambient humidity	95 % RH

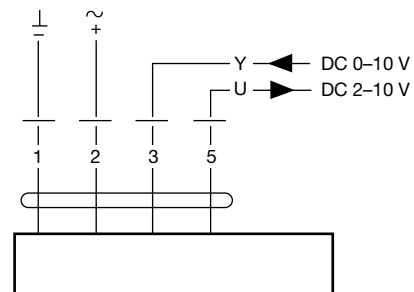



Air stream operated dampers

CARU, CAR

Assembly

CARU

In order to fulfil the requirements of tightness class D the damper must be installed as per 'Assembly Instruction Lindab Safe'.

CAR

The damper is installed by simply placing it inside a duct.

Measurement

The dampers normally don't need any maintenance.



Measuring bends

MBU, MBFU

Assembly

In order to fulfil the requirements for air-tightness class D, the bends must be installed as per 'Assembly Instruction Lindab Safe'.

The bends allow 50 mm duct insulation without the measuring points being hidden. For 100 mm insulation, an insulation cup, IK, is available.

Measurement

By measuring the pressure difference Δp in Pa at the measuring points, you can achieve a flow q in l/s using the equation on the devices.

The specified flows only apply for air with a density of 1.2 kg/m^3 . For air of another density (ρ_{other}) the flow ($q_{\text{other_density}}$) is achieved as per the formula:

$$q_{\text{other_density}} = q_{\text{equation}} \times \sqrt{\frac{1,2}{\rho_{\text{other}}}}$$

Device	Dimension mm	k-factor
MBU	100	6.85
	125	10.3
	160	17.0
	200	26.3
	250	41.7
MBFU	315	65.0
	400	115
	500	179
	630	283

Systematic error

Straight stretches are required in order to achieve flows as per equations with specified accuracy. The systematic error m_2 is 5% and 10% below the minimum requirements for straight stretches as specified.

Maintenance

The measuring bends normally don't require any maintenance.

Cleaning

The device does not limit cleaning opportunities.



Flow meters

FMU, FMDRU

Assembly

In order to fulfil the requirements for air-tightness class D, the devices must be installed as per 'Assembly Instruction Lindab Safe'.

FMDRU must be installed with the air flow in the direction of the arrow.

The devices allow 100 mm duct insulation without sticker or measuring points being hidden. The cup around FMDRU's damper knob allows 50 mm duct insulation without the knob being hidden. For 100 mm insulation, an insulation cup, IK, is available.

For optimum readability (regardless of the installation position), the plate with the sticker can be turned, folded up to prevent it disappearing in any insulation or to be easily removed and positioned separately from the device.

Measurement

By measuring the pressure difference Δp in Pa at the measuring points, you can achieve a flow q in l/s using the equation on the devices.

With FMDRU you can set the desired flow, as the damper blade is adjustable through 0–90° (0°=fully open, 90°=completely closed) using the knob in the cup. Locking is performed using screws for Pozidrive (PZD2) and the damper angle can be read off a stamped grade on the edge of the cup.

The specified flows only apply for air with a density of 1.2 kg/m³. For air of another density (ρ_{other}) the flow ($q_{\text{other_density}}$) is achieved as per the formula:

$$q_{\text{other_density}} = q_{\text{equation}} \times \sqrt{\frac{1,2}{\rho_{\text{other}}}}$$

Dimension mm	k-factor
80– 63	4.40
100– 80	7.32
125–100	11.2
160–125	18.0
200–160	29.4
250–200	45.7
315–250	73.3
400–315	116
500–400	191
630–500	283

Systematic error

Straight stretches are required in order to achieve flows as per equations with specified accuracy. The systematic error m_2 is 5% and 10% below the minimum requirements for straight stretches as specified. For these minimum straight requirements – do not install measuring points in line with the nearest bend's inside radius.

Maintenance

The devices normally don't require any maintenance.

Cleaning

FMU does not limit cleaning opportunities.



Flow meters

FMDU

Assembly

In order to fulfil the requirements for air-tightness class D, the device must be installed as per 'Assembly Instruction Lindab Safe'.

The device must be installed with the air flow in the direction of the arrow.

The device allows 50 mm duct insulation without sticker or measuring points being hidden.

The cup around the damper knob allows 50 mm duct insulation without the knob being hidden. For 100 mm insulation, an insulation cup, IK, is available.

For optimum readability (regardless of the installation position), the plate with the sticker can be turned or easily removed and positioned separately from the device.

Measurement

By measuring the pressure difference Δp in Pa at the measuring points, you can achieve a flow q in l/s using the equation on the device.

You can set the desired flow, as the damper blade is adjustable through 0–90° (0°=fully open, 90°=completely closed) using the knob in the cup. Locking is performed using screws for Pozidrive (PZD2) and the damper angle can be read off a stamped grade on the edge of the cup.

The specified flows only apply for air with a density of 1.2 kg/m³. For air of another density (ρ_{other}) the flow ($q_{\text{other_density}}$) is achieved as per the formula:

$$q_{\text{other_density}} = q_{\text{equation}} \times \sqrt{\frac{1,2}{\rho_{\text{other}}}}$$

Dimension mm	k-factor	Colour coding for measuring points
80	2.99	transparent
100	4.90	red
125	7.95	green
160	13.8	yellow
200	21.3	blue
250	34.6	black
315	57.8	white
400	88.8	transparent
500	146	red
630	234	green

Systematic error

Straight stretches are required in order to achieve flows as per equations with specified accuracy. The systematic error m_2 is 5% and 10% below the minimum requirements for straight stretches as specified.

Maintenance

The device normally doesn't requires any maintenance.



Damper with flow meter

DIRU

Assembly

Mount the dampers according to “Assembly Instructions Lindab Safe” to meet with the requirements for tightness class C.

Consider required straight distance after or before disturbance, as mentioned on the card attached to the measurement nozzles, to obtain accurate flow measurement. Dampers with dimension 400, 500 and 630 are provided with transport protections. Remove these before assembly.

The damper may not be loaded with weight from connected ducts, specially when assembled vertically.

Measuring

Measuring pressure Δp_m

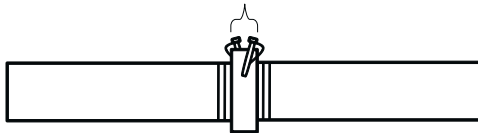

The balancing graphs show the flow, q , as a function of the measured pressure, Δp_m , in the measure nozzles.

$$q = k \cdot \sqrt{\Delta p_m}$$

The formula is only accurate for air with the density 1,2 kg/m³. For air with other density, (ρ_{other}), the flow, (q_{other}), is given according to the formula.

$$q_{other} = q_{equation} \times \sqrt{\frac{1,2}{\rho_{other}}}$$

The balancing graphs should only be used to balance the system. They should not be used to calculate the pressure drop in the system, in those cases the dimensioning graphs should be used.

Measurement accuracy

Consider required straight distance after or before disturbance, as mentioned on the card attached to the measurement nozzles, to obtain accurate flow measurement.

Balancing

Connect the measuring hoses to the damper measuring nozzles.

Loosen the locking screws (3), which have Philips slot no.1. adjust the handle so that requisited pressure drop receives. Fasten the screws (3) and remount the tightness screws (2), so that the slot gets airtight.

For dimension 400,500 and 630 - remove the tightness screws (2). Then loosen the locking screws (3), which have Philips slot no. 2. Adjust the handle so that requisited pressure drop receives. Fasten the screws (3) and remount the tightness screws (2), so that the slot gets airtight.

Disconnect the hoses and plug the nozzles.

Maintenance

The product normally doesn't requires any maintenance.

Cleaning

By fully open the damper, one get access to the duct. Do not forget to readjust the damper after cleaning.



Damper with flow meter

DIRU, DIRBU, DIRVU

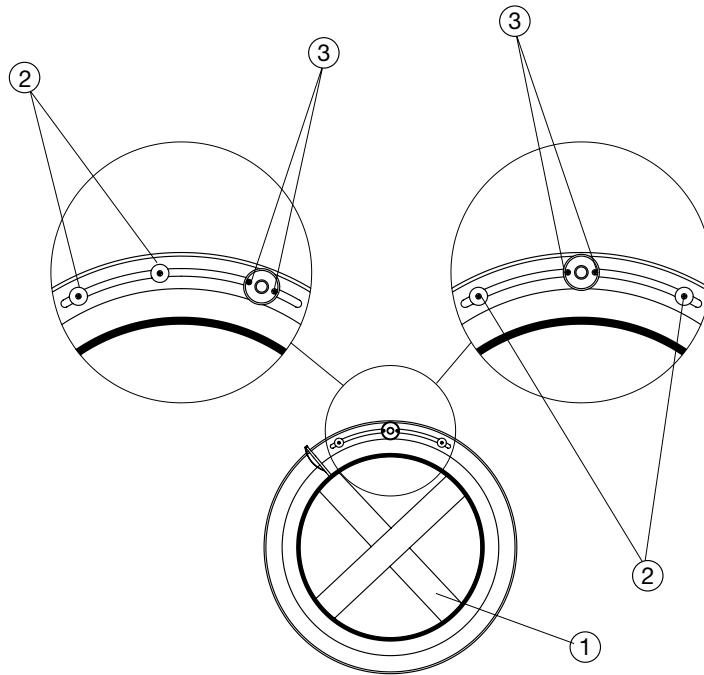

To set the air flow (method 1):

- Determine the k factor on the scale on the damper, k
- Measure the pressure difference by connecting a measuring device to the damper nozzles, Δp_m
- Calculate the flow by using the formula, $q = k \cdot \sqrt{\Delta p_m}$
- Compare the calculated flow to the required
- Adjust the damper if necessary and recalculate the pressure difference

To set the air flow (method 2):

- Calculate the pressure difference by using the formula, $\Delta p_m = \left(\frac{q}{k}\right)^2$
- Measure the pressure difference by connecting a measuring device to the dampers nozzles, Δp_m
- Compare the measured pressure difference to the required
- Adjust the damper

Don't forget to plug the nozzles after measuring.

When using this method you will have to recalculate until you receive the required flow. By using a different method you will only have to do one calculation.



Damper with flow meter

DIRU, DIRBU, DIRVU

Pressure drop graphs with noise generation for dimensioning

The dimensioning graphs show the pressure drop over the damper with flow meter, Δp_t . They should be used to determine the pressure drop and to provide information about sound power levels at different settings.

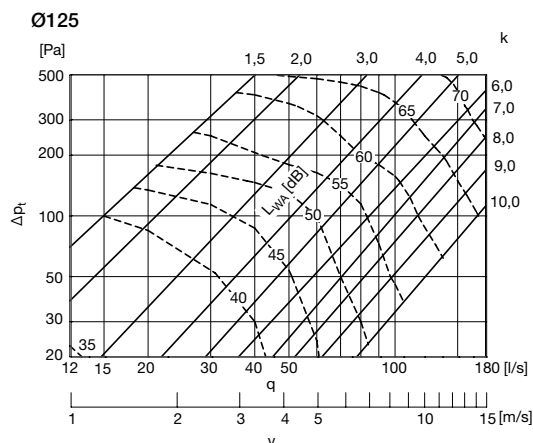
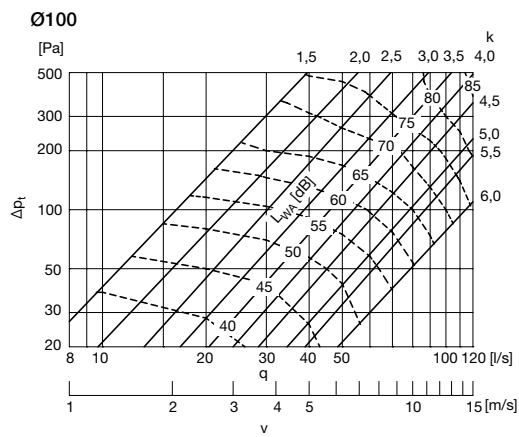
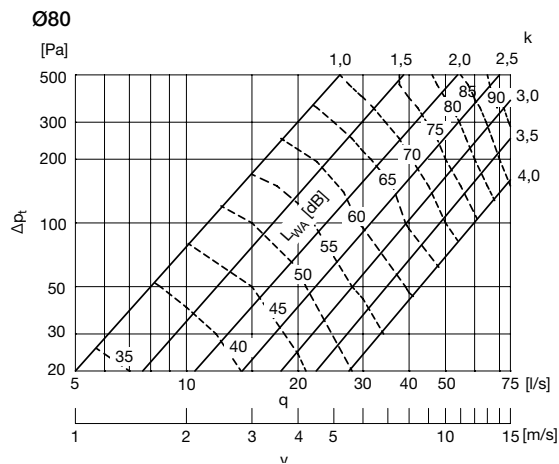

Flow graphs for balancing

The balancing graphs show the flow as a function of the measured pressure, Δp_m . These graphs should be used to balance the system.

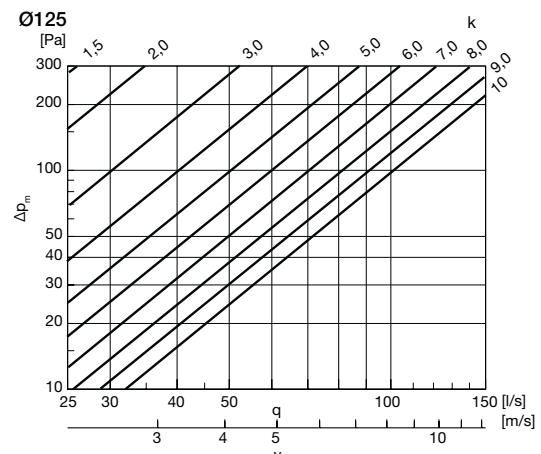
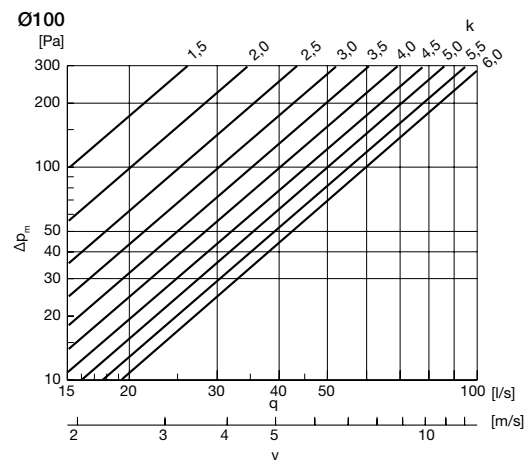
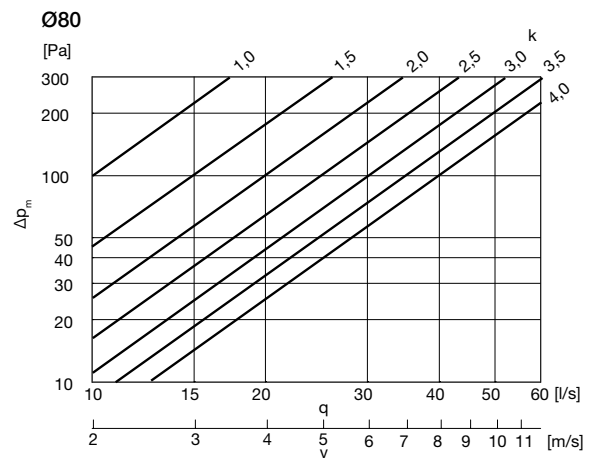



Damper with flow meter

DIRU, DIRBU, DIRVU

Pressure drop graphs with noise generation for dimensioning

Flow graphs for balancing

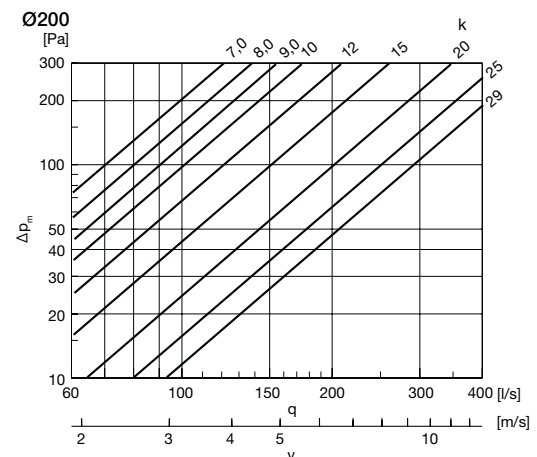
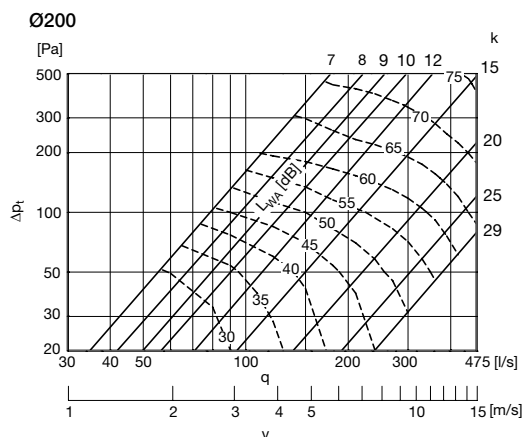
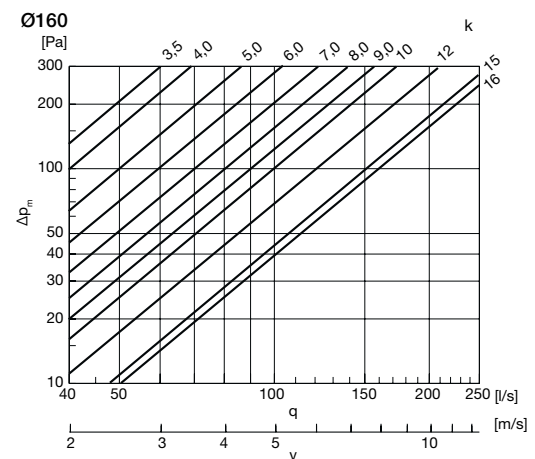
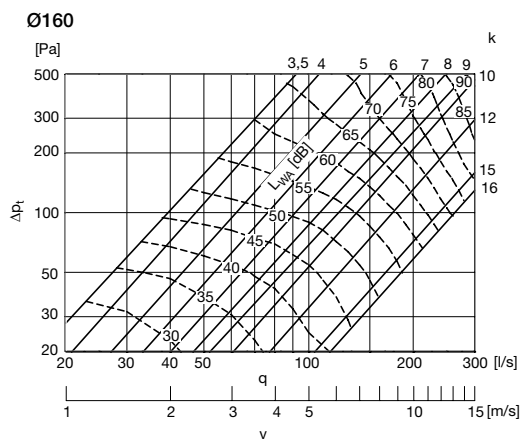
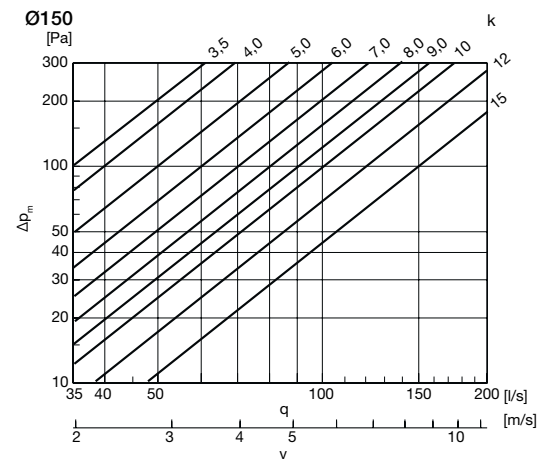
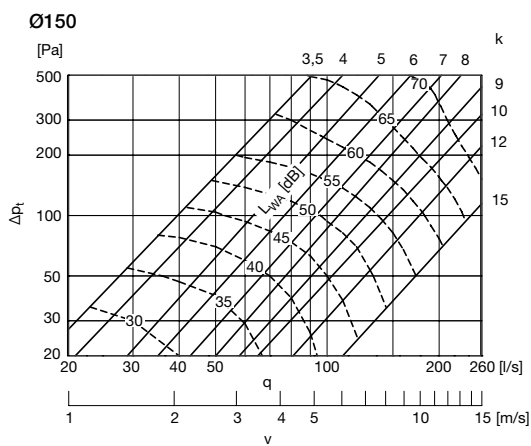



Damper with flow meter

DIRU, DIRBU, DIRVU

Pressure drop graphs with noise generation for dimensioning

Flow graphs for balancing

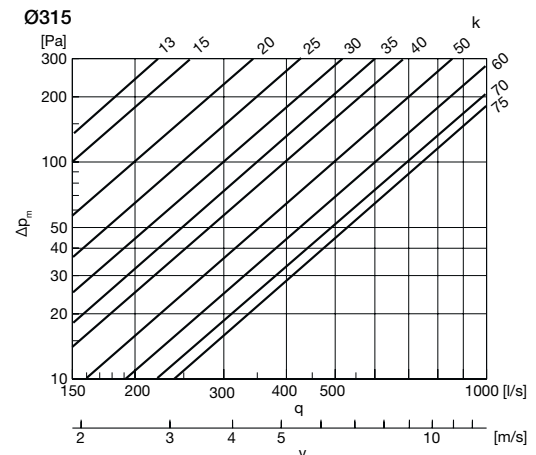
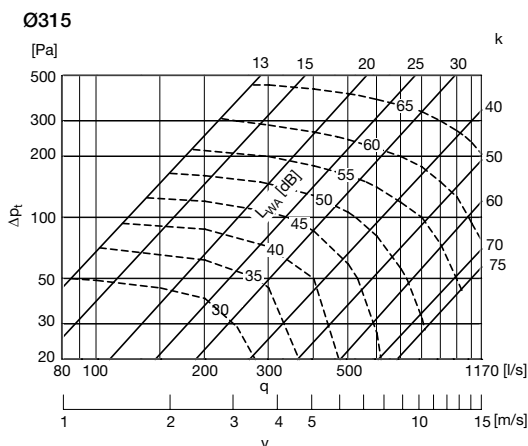
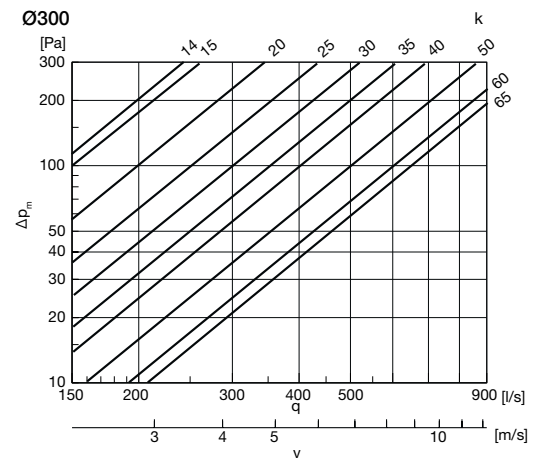
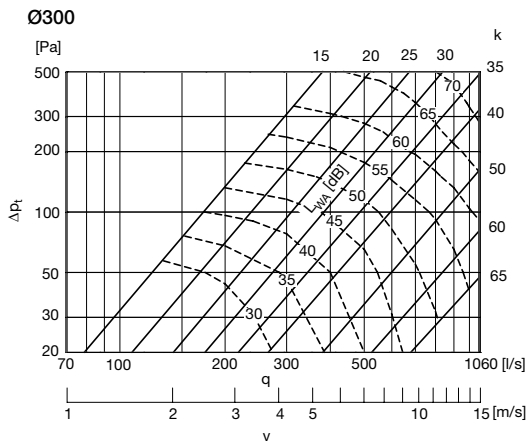
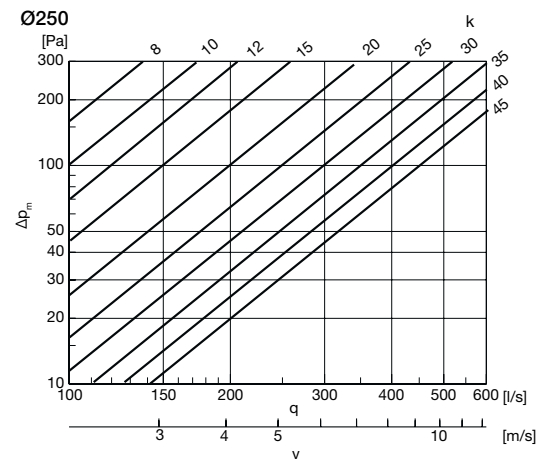
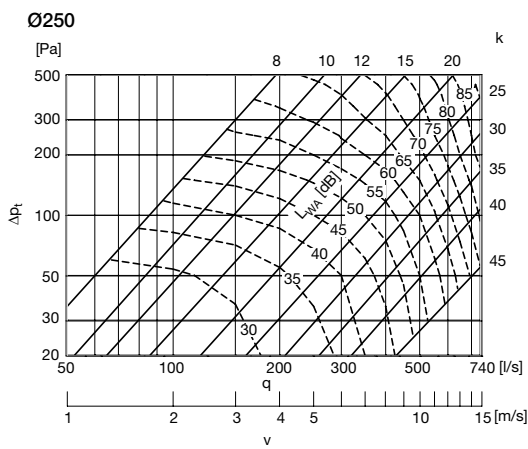



Damper with flow meter

DIRU, DIRBU, DIRVU

Pressure drop graphs with noise generation for dimensioning

Flow graphs for balancing

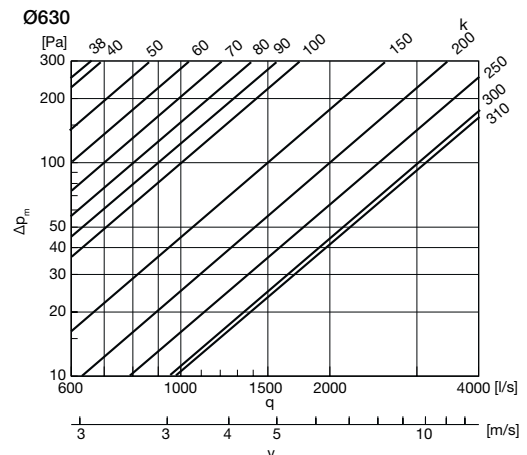
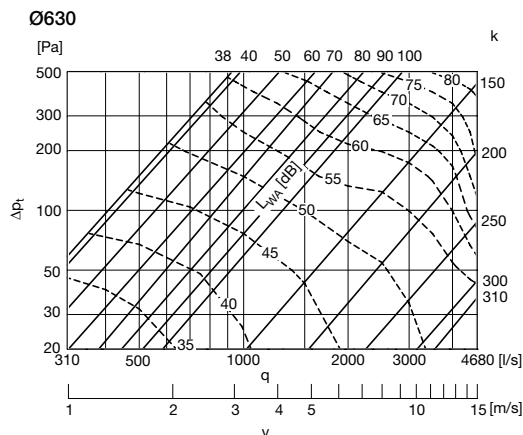
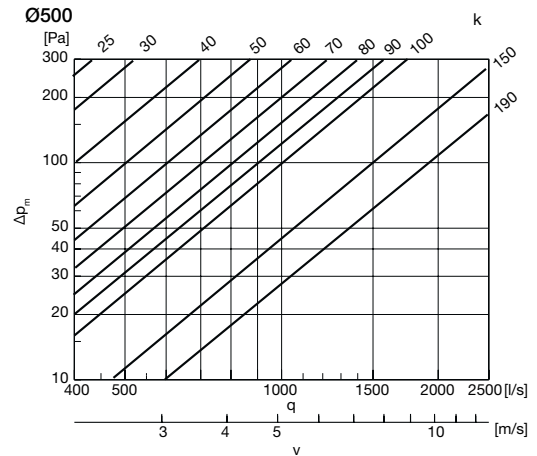
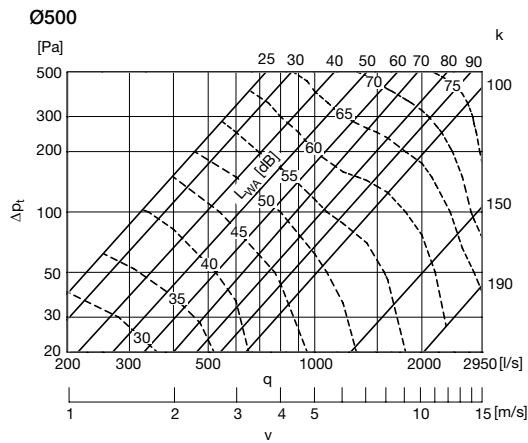
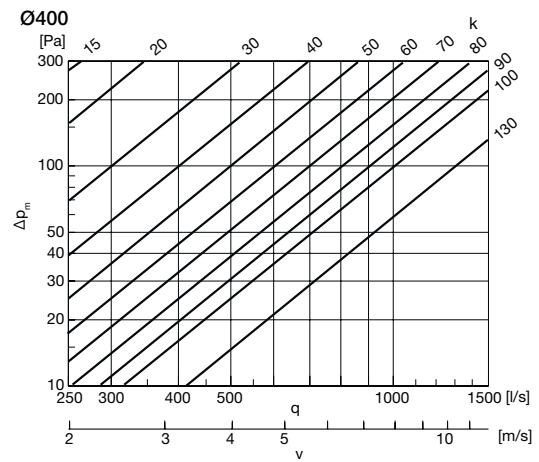
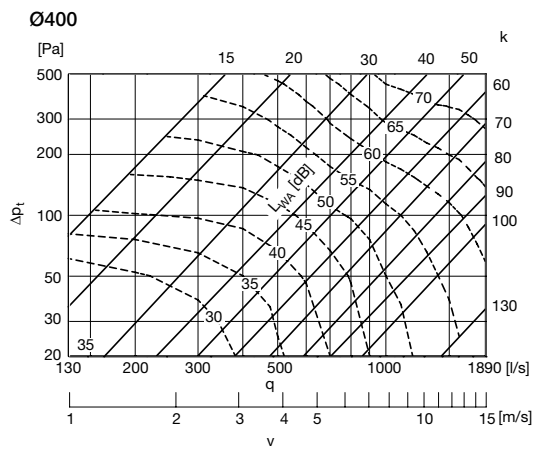



Damper with flow meter

DIRU, DIRBU, DIRVU

Measurement accuracy

If the velocity profile is asymmetric, the measurement values can differ from the ideal values. For this reason, the flow meter should never be located right up to any flow disturbance. The method error in the table below will differ, depending on the distance to the flow disturbance.

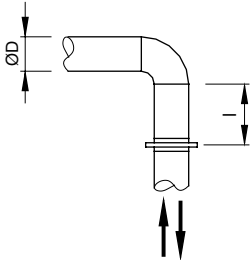
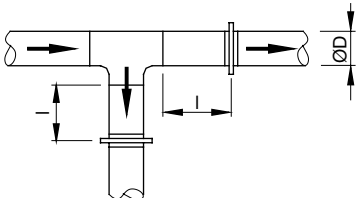
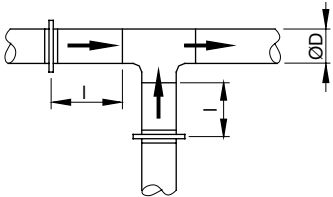
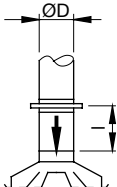
l = straight distance before and after disturbances	Method error $\pm 7\%$
	$l \geq 1 D$
	$l \geq 1 D$
	$l \geq 3 D$
	$l \geq 3 D$



Damper with flow meter

DIRBU, DIRVU

Assembly

The damper which is considered as a component (not ready-to-use-product) are only to be put into operation after it has been built into machines or duct systems and when the system is found to be in conformity with all relevant regulations.

Mount the damper according to "Assembly Instructions Lindab Safe" to meet the requirements for tightness class C.

Dampers with dimension 400, 500 and 630 are provided with transport protections. Remove these before assembly. Consider required straight distance after or before disturbance, as mentioned on the card attached to the measurement nozzles, to obtain accurate flow measurement.

The damper may not be loaded with weight from connected ducts, specially when assembled vertically. Make sure that there is enough free space for moving parts.

Installation, electrical connection and commissioning are only to be performed by authorised personnel and in accordance with the requirements of the installation.

Electrical connection shall be done according to the wiring diagram on the motor, in the catalogue and the markings on the cable.

The damper must not be used in an explosive atmosphere or connected to flue ducts.

The damper can have sharp edges and corners which may cause injuries. It also has moving parts.

Do not lift the dampers by the electric cable.

Before initial operation, check the following:

- electrical connection has been properly completed.
- Safety devices are in place.
- Leftover installation materials and foreign materials have been removed from the casing.
- Make sure the damper is functional by checking the end positions: press the button on the motor and move the lever to each end.

When putting in operation, check the following:

- Smoothness of motor operation and no abnormal noises.

Measuring

By measuring the pressure difference Δp in Pa between the measure nozzle, you can through the equation $q = k \cdot \sqrt{\Delta p_m}$ on the damper derive the flow q [l/s]. Do not forget to plug the nozzles after measuring.

$$q_{\text{other density}} = q_{\text{equation}} \times \sqrt{\frac{1,2}{\rho_{\text{other}}}}$$

Balancing

The damper is delivered fully open. Set the maximum and minimum flow by connecting hoses to the measurement nozzles. Press the button on the motor and move the lever until required pressure for maximum flow receives. Fasten the left screw on the motor. Repeat the procedure to set the minimum flow and fasten the right screw.

Measurement accuracy

Consider required straight distance after or before disturbance, as mentioned on the card attached to the measurement nozzles, to obtain accurate flow measurement. The accuracy is $\pm 7\%$ when required distance is complied.

Maintenance



Damper with flow meter

DIRBU, DIRVU

The product normally doesn't require any maintenance but before maintenance, service or repair make sure that:

- power supply is interrupted (all-pole circuit breaker)
- observe personnel safety regulations

Do not use high-pressure cleaner when cleaning the damper. Care must be taken during cleaning so the motor is not damaged.

Cleaning

By fully opening the damper, one gets access to the duct. Do not forget to readjust the damper after cleaning.

CE-marking

Our dampers with electrical actuators are considered as ductwork components and do not need to be separately marked. Their electrical actuators however are a part of the electrical system and are consequently marked. Declaration of Conformity is to be found at www.belimo.com.

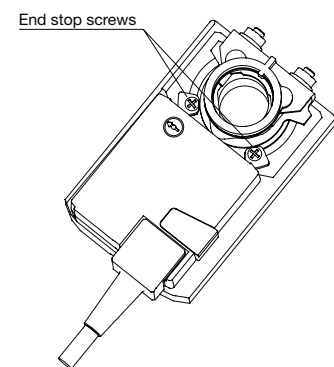



Damper with flow meter

DIRBU, DIRVU

DIRBU

Technical data for the motors

	LM 24 A	LM 230 A
Power supply.....	AC 19,2–28,8 V, 50/60 Hz DC 19,2–28,8 V	AC 85–265 V, 50/60 Hz
Power consumption	1 W	1,5 W
For wire sizing	2 VA	4 VA
Connection	Cable 1 m, 3x0,75 mm ²	Cable 1 m, 3x0,75 mm ²
Operating angle.....	Max. 95°, adjustable 0–100%	Max. 95°, adjustable 0–100%
Torque at rated voltage.....	Min. 5 Nm	Min. 5 Nm
Direction of rotation.....	Switch selectable 0 ↺ or 1 ↻	Switch selectable 0 ↺ or 1 ↻
Position indication	Mechanical	Mechanical
Running time for 95°	150 s	150 s
Sound power level.....	Max. 35 dB (A)	Max. 35 dB (A)
Protection class.....	III Safety extra-low voltage	II Safety insulated
Protection type	IP 54	IP 54
Ambient temperature range	-30 to +50°C	-30 to +50°C
Ambient moisture	95 % RH	95 % RH

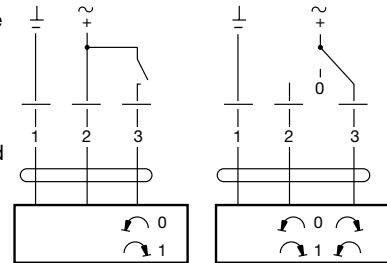

DIRVU

Technical data for the motor

	LM 24 A-SR
Power supply.....	AC 24 V, 50/60 Hz DC 24 V
Power consumption	1 W vid nominellt vridmoment
For wire sizing	2 VA
Connection	Cable 1 m, 4x0,75 mm ²
Operating angle.....	Max. 95°, adjustable 0–100%
Torque at rated voltage.....	Min. 5 Nm
Direction of rotation.....	Switch selectable 0 ↺ eller 1 ↻
Position indication	Mechanical
Running time for 95°	150 s
Sound power level.....	Max. 35 dB (A)
Protection class.....	III Safety extra-low voltage
Protection type	IP 54
Ambient temperature range	-30 till +50°C
Ambient moisture	95 % RF

