



website <http://www.lgservice.com>

LG

AC Manager

Installation/Owner's Manual

*Advanced Central Control Manager
(PQCSS520A0E)*

ENGLISH

ITALIANO

ESPAÑOL

FRANÇAIS

DEUTSCH

CHINESE

Caution

- Before installation, be sure to read this manual.
- This device should be installed by a qualified technician.
- Even after reading this manual, be sure to keep it for reference during its operation.

Manual contents

1. AC MANAGER OVERVIEW 1-1

AC Manager function	1-2
AC Manager Overall system diagram.....	1-4
• AC Manager is connected to one ACP	1-4
• AC Manager is connected to several ACP's	1-6
What are included in AC Manager	1-7
AC Manager hardware specification	1-8

2. AC MANAGER INSTALLATION 2-1

Hardware Installation.....	2-2
• AC Manager is connected to one ACP	2-2
• AC Manager is connected to several ACP's	2-3
AC Manager software installation	2-4
• Installation of USB Hard Lock key driver.....	2-4
• AC Manager program installation.....	2-7
• Connecting lock key to AC Manager	2-9
• AC Manager log in.....	2-10
• AC Manager program deletion.....	2-13

3. AC MANAGER OPERATION 3-1

What's in menu.....	3-2
Installation before using.....	3-3
• AC Manager main screen	3-3
• AC Manager setting before using	3-5
Basic control	3-19
Peak control.....	3-27
• Installation of peak exception	3-31
Schedule	3-33
• Weekly schedule edit screen description	3-35
• Weekly schedule setting screen description.....	3-38
• Special schedule edit screen description.....	3-40

• Special schedule setting screen setting	3-43
• Using weekly schedule function.....	3-45
• Creating the schedule and specifying the schedule group to operate	3-45
• Applying the pattern for the schedule group to operate	3-45
• Applying the operation period of the schedule group which the pattern was applied to	3-45
• By creating the schedule, specifying the schedule group to operate	3-46
• Applying the patter for the specified schedule group to operate.....	3-47
• Applying the operation period for the schedule group that the pattern was applied to	3-50
• Using the special schedule function	3-53
• By creating the schedule, specifying the schedule group to operate.....	3-53
• Applying the pattern for the specified group to operate	3-53
• Applying the period for the schedule group to which the pattern was applied, to operate	3-53
• Specifying the schedule group to operate by creating the schedule	3-54
• Applying the pattern for the schedule group to operate	3-55
• Applying the operation period of the schedule group to which the pattern was applied	3-58
• Using the function to stop entire schedule	3-60
• Using the function to send the current schedule.....	3-60
History management.....	3-62
• Selecting specific equipment.....	3-64
Integrated power	3-67
Pleasant control	3-69
• Auto switch operation.....	3-69
• Temperature limit operation.....	3-70
Device connection control	3-73
• Pattern management.....	3-75
Monitor	3-79

4. NOTE

4-1

TCP/IP setting guide4-1

1. AC Manager Overview

AC Manager function

AC Manager overall system diagram

What are included in AC Manager

AC Manager hardware specification

AC Manager stands for Advanced Central Control Manager, which is a PC control controller for monitoring and controlling of air conditioner and ventilation in each room of the building from one spot like control room.

AC Manager can specifically check the operation of each air conditioner and give control orders like the air conditioner operation, wind strength, user lock, temperature setting and etc. AC Manager can maintain the outdoor ventilator of the air conditioner up to 4096 rooms.

AC Manager can be connected to RMTS(Remote Total Management System) and if necessary, the entire system operation can be monitored through the Internet from outside.

In addition to basic function control like the operation control of AC Manager, if the schedule control and peak operation rate control function are used, unnecessary use of air conditioner can be avoided, saving energy and it is convenient to use.

GUI(Graphical User Interface) has been applied to all functions and settings provided in AC Manager, and clicking buttons on the screen with mouse enables you to use the program conveniently.

AC Manager can easily control the added or replaced air conditioner if new customer wants to add or replace it or additionally purchase it.

AC Manager Function

Individual/Integrated Operation Monitoring

AC Manager can check the operation status, operation mode, wind strength, wind direction, lock, setting temperature, error and etc. of the air conditioner by selecting it individually, by group or entirely. The manager of the building with lots of air conditioners installed can simply control them from the central location if he has AC Manager installed in the control room.

Group management

The installed AC Manager can be managed by group. If you divide the air conditioners into groups by character, location and size, you can use them conveniently. In addition, you can provide easily identifiable names for setting groups and more intuitively manageable.

Self-diagnosis function

The air conditioner with AC Manager can self-diagnose the error status of 31 air conditioners and send it to central controller. Users can take care of its malfunction promptly making its maintenance easy. This function has a merit that extend the life of the air conditioner.

Reducing maintenance cost

When there is no AC Manager, the central control program of the air conditioner, the manager used to manage lots of air conditioners by himself. However, with AC Manager program, all functions of the air conditioner can be controllable from the control room, so it takes only one manager to easily control all air conditioners.

Convenient GUI

Users don't have to take special lessons to use AC Manager and he can use the program only by clicking buttons on the screen using the mouse. You can easily understand AC Manager using intuitive pictogram. In particular, in case of setting schedule, unlike prior version that required more than 30 times of button-clicks in order to enter one schedule, by applying the patent technology, simply moving the mouse and dragging the indicated period enables schedule setting.

Schedule auto operation maintenance / Saving energy

The schedule auto operation function of AC Manager can be set yearly, weekly and daily. The air conditioner can be on and off only when necessary, which brings excellent energy-saving effect. In particular, for the institutions with specific schedule for each semester, such as elementary, middle and high school and universities, this function maximizes the effect.

Remote control through the Internet

When using ACP as a server, using the Internet enables the control over all air conditioners through connection to ACP. If you control the air conditioner using web browser, you can use only basic control and monitoring function, not all functions of AC Manager.

Note : ACP

ACP(Advanced Control Platform) is a central controller that up to 256 of air conditioners can be controlled in a space. ACP can be used to monitor the air conditioner and ventilation device installed in each room of a building in a place like control room or school administration room or control the operation.

Security function using the authentication key

AC Manager program is executed only when the authentication key is installed in PC. Therefore, AC Manager blocks user's access without the key, so that the air conditioner can be safely controlled.

AC Manager Overall System Diagram

AC Manager is connected to one ACP

In case that one ACP is connected to AC Manager without hub, the connection should be made as following network structure.

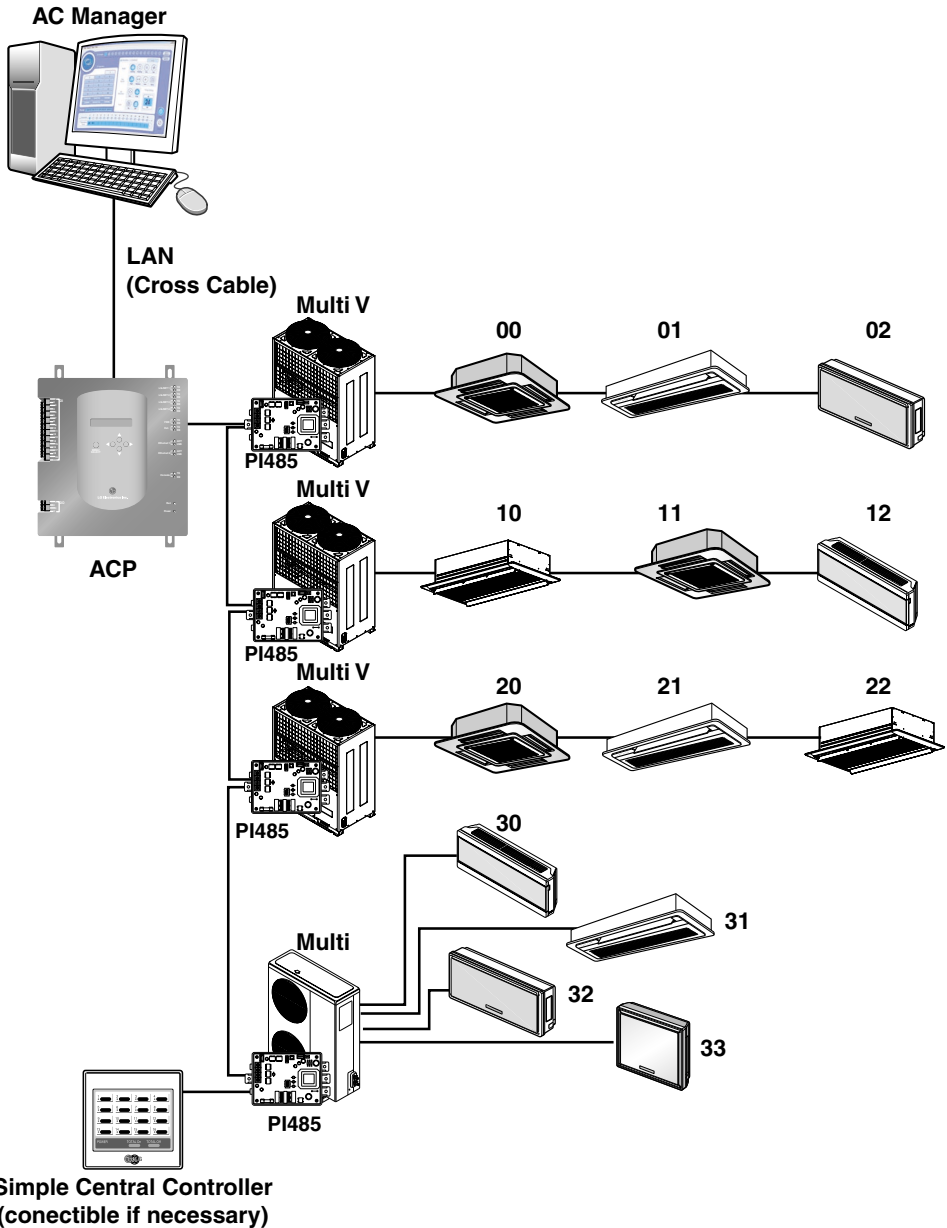

Below is an example of the connection of AC Manager to ACP using hub.

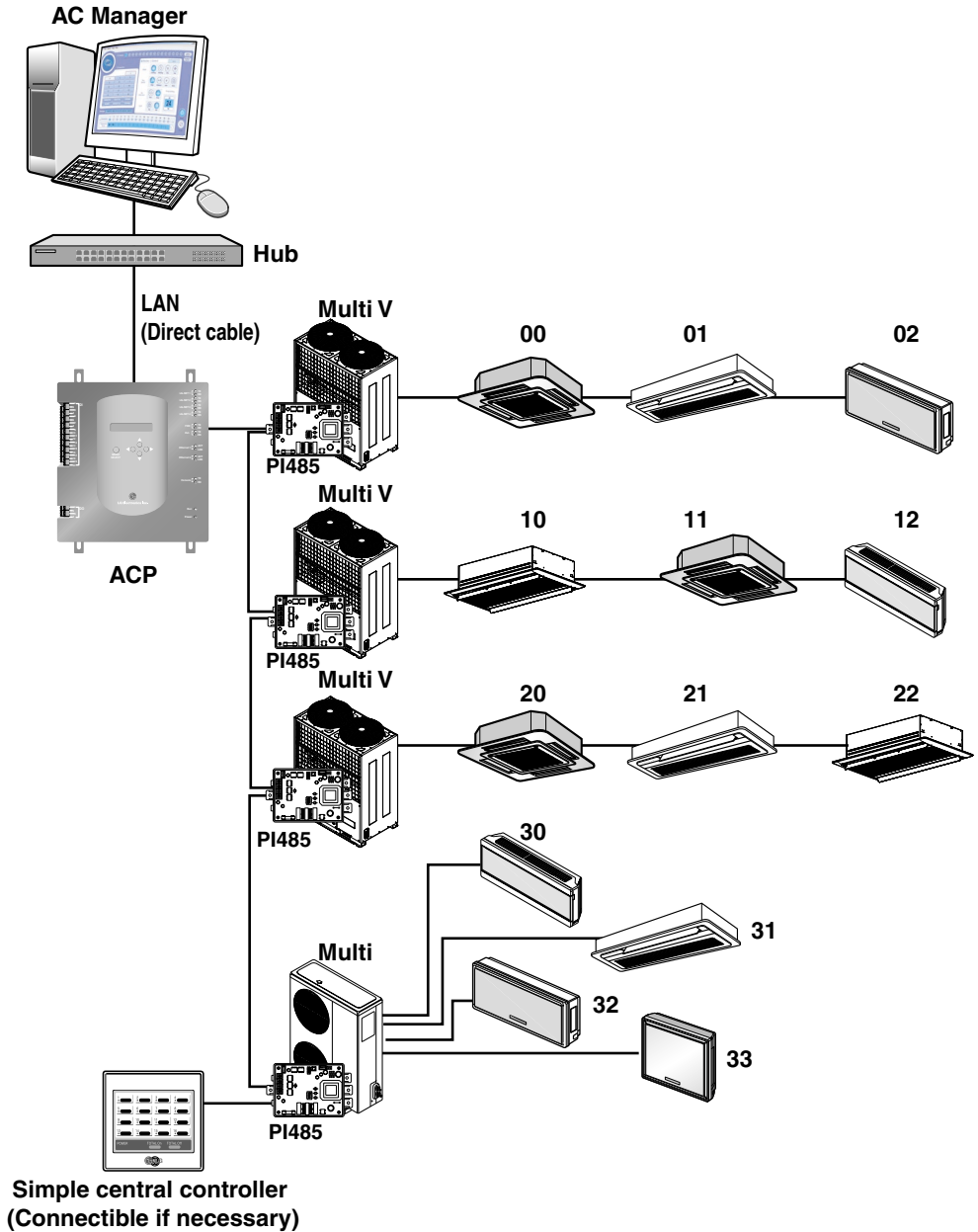

AC Manager is connected to several ACP's

In case that several ACP's are connected to AC Manager using hub, the network structure should be connected as shown in below example.

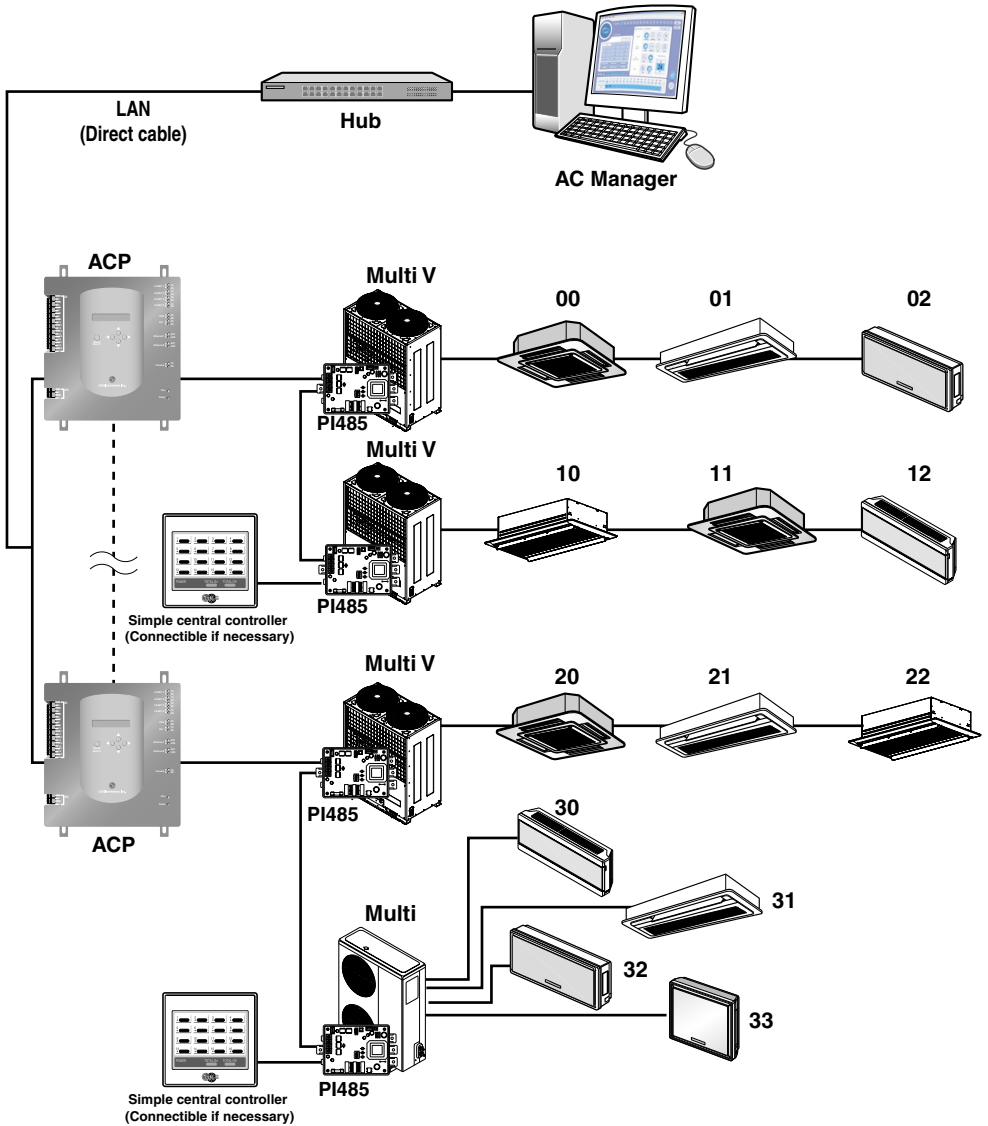

What are included in AC Manager

Following items are included in AC Manager package. After opening the AC manager box, please check if all the items are included.

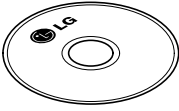

AC Manager installation CD

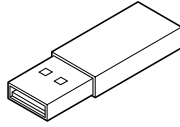

USB Hard Lock key

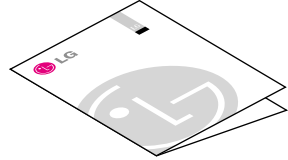

Installation/Owner's manual

AC Manager hardware specification

AC Manager requires a special PC for AC Manager that user purchased. AC Manager is a Windows program, and requires 50 Mbytes in its installation.

The recommended system specification for AC Manager installation is as follows;

Item	Description
CPU	Over Pentium_ 2.2GHz
Main memory	Over 256MB
OS	Windows NT/ 2000/ XP
Hard disk	Min. 600MB of margin (during operation, over 600MB)
Web browser	Over Internet Explorer 5.0

Caution: Operation system

Windows XP is recommended.



Caution: Use standard product

We don't take responsibility when the user used an adapter other than our standard product and this caused any problem. Therefore, do not use other product. For the applicable products, please contact LG system air conditioner support department.



2. AC Manager installation

Please install the program in the order below, in order to use AC Manager.

Step 1 : Hardware Installation

Step 2 : Hard Lock Key driver installation

Step 3 : AC Manager software installation

Step 4 : Log-on to AC Manager

Hardware Installation

AC Manager is connected one ACP

This is the case that AC Manager is installed in separate PC and PC is directly connected to ACP. In this case, the Ethernet cable should be connected through the cross cable.

Using Ethernet cable(cross cable), Connect Ethernet 1 port of APC to PC.

In this case, you can connect PC(AC Manager) to ACP using cross cable without hub.

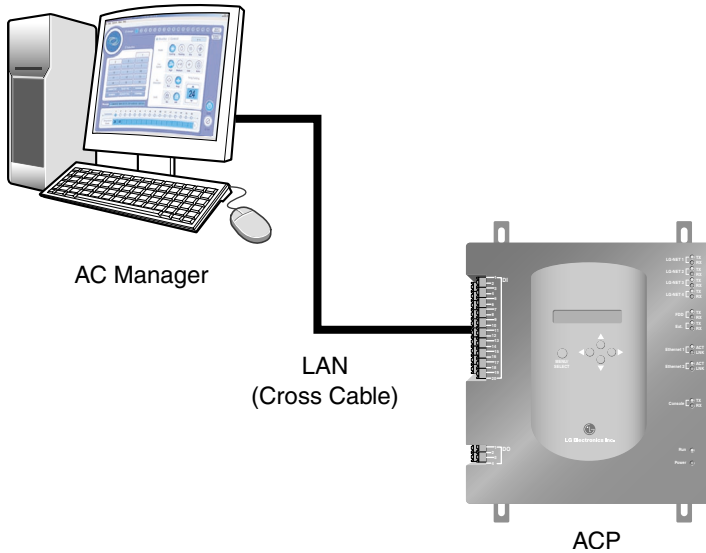

Enlarged figure of ACP Ethernet terminal is as shown below.

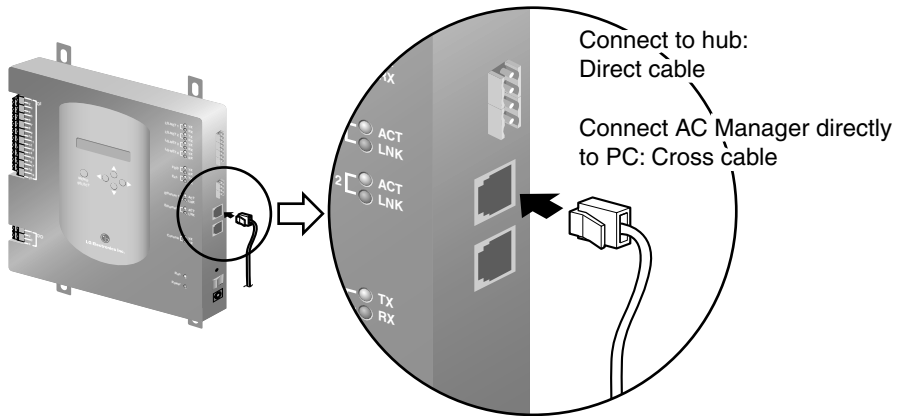

Reference : Cable

Be sure to identify that Ethernet cable is direct cable or cross cable. In addition, after checking if the cable is ok using lan tester, connect it.

Ethernet 2 is a reserved port and not used for the connection to hub and AC manager. Check the location of Ethernet 1 port and Ethernet 2 port to correctly connect it.

AC Manager is connected to several ACP's

When AC Manager is connected to several ACP's, hub is used. When using hub, connect it to hub with direct cable.

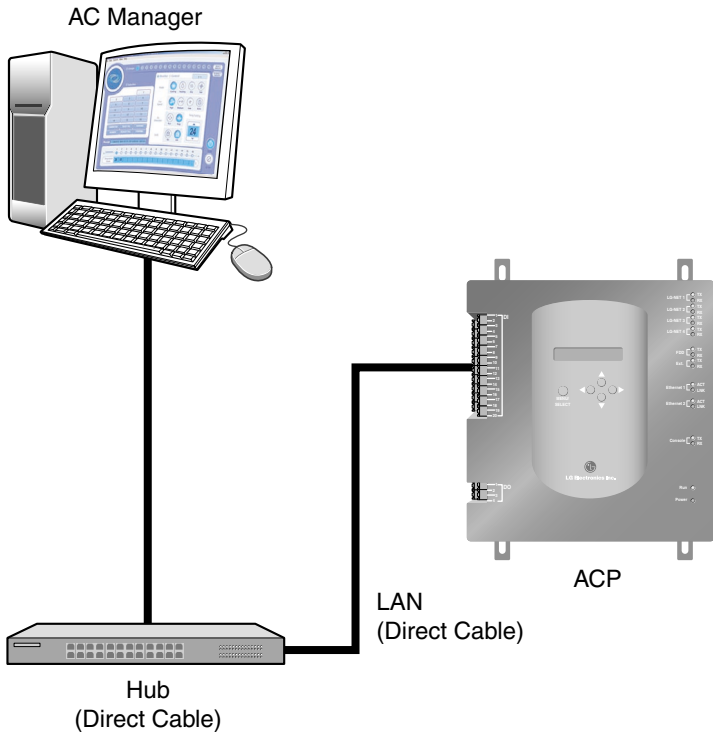

AC Manager Software installation

USB Hard Lock key driver installation

Note: Lock key

When installing AC Manager program, the lock key shouldn't be connected to the computer.

1. Insert the AC Manager installation CD into CD-ROM. AC Manager installation program is automatically executed. If the program isn't automatically executed, execute the Autorun.exe file in CD. The initial screen appears as below.

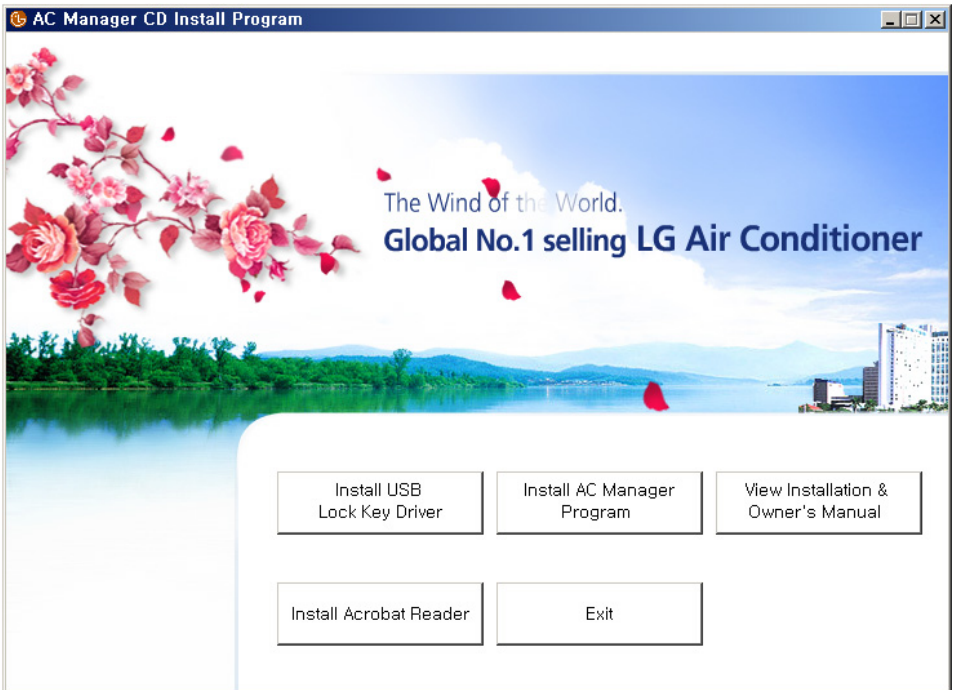

As shown in the order of the button in this screen, the user installs the Lock Key driver and then installs the AC Manager program. In this screen, you can see installation/user manual and install Acrobat Reader program in order to check the manual. If you want to exit the installation, please press exit button.

Click lock key driver installation button.

2. Driver installation screen appears.

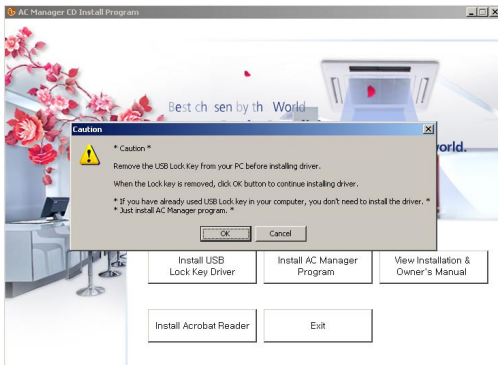

Please read caution when installing driver and press OK button.

3. Select language window appears.

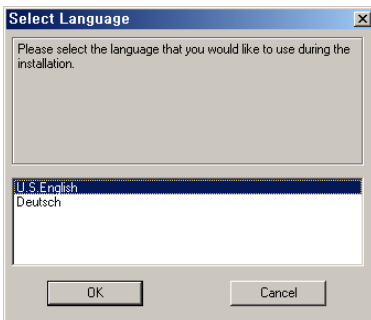

Select U.S English and click OK button.

4. Welcome message window appears.



Press Next button

5. Accept the license agreement window appears.

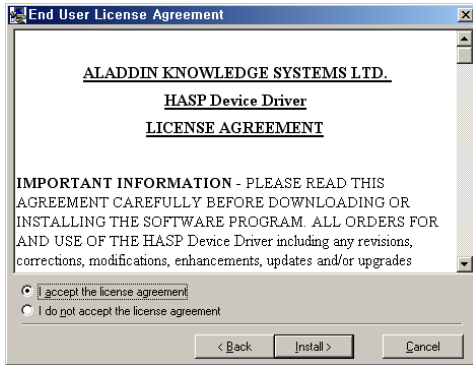

Check Accept the license agreement box and click install button. Now installation begins. Driver installation can take from a few minutes to tens of minutes. If below window appears, the driver installation is completed.

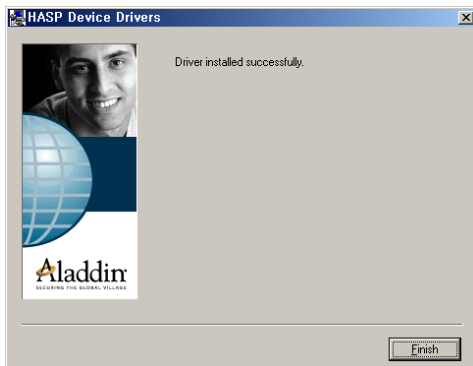

Click Finish button, and then AC Manager program installation is completed.

AC Manager Program Installation

1. Insert AC Manager installation CD into CD-ROM. AC Manager program is automatically executed. If the program isn't automatically executed, execute

Autorun.exe file in CD. Below initial screen appears.

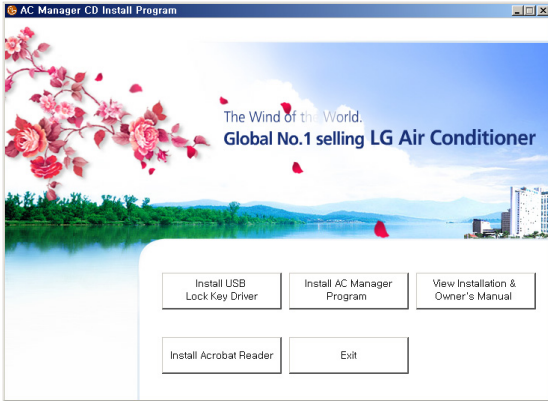

The order of menu as shown in this figure, user will install lock key driver and then AC Manager program. In this screen, you can read installation/user's manual and install Acrobat Reader program to check the manual. If you complete the installation, press Exit button.

Click AC Manager program

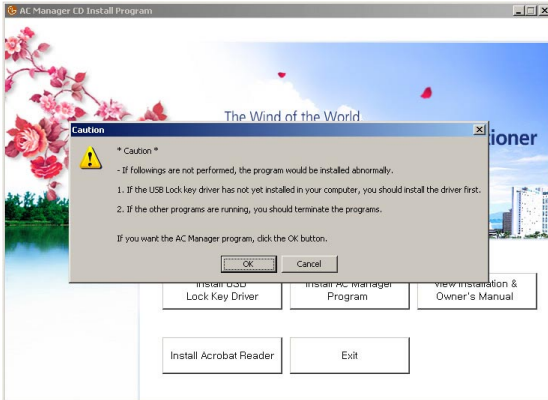

2. The following precautions will be displayed. Check the content and then click on the OK button.

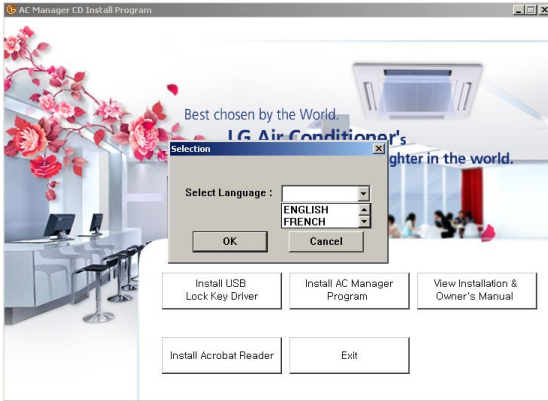

3. Select the language to install

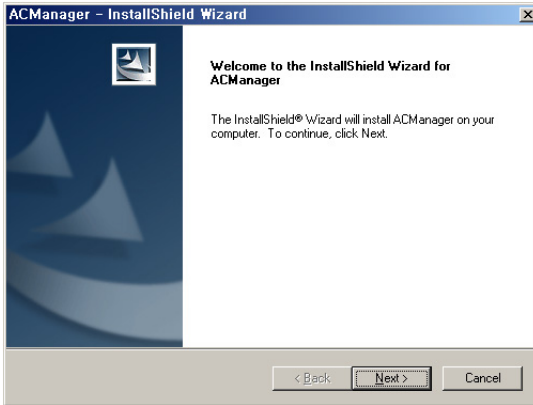

4. Shortly after the installation program is executed, the initial installation screen appears.

Press Next button.

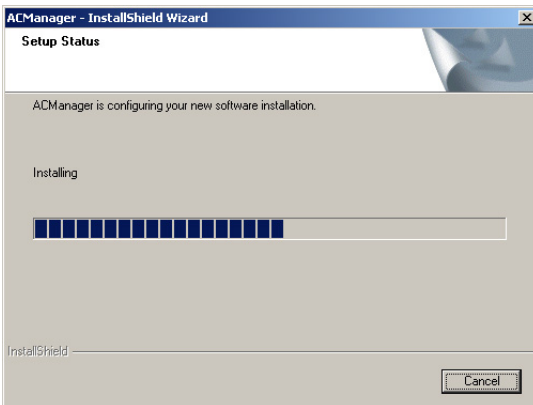

5. The program is installed in “C: \ Program Files \ LG Electronics”.

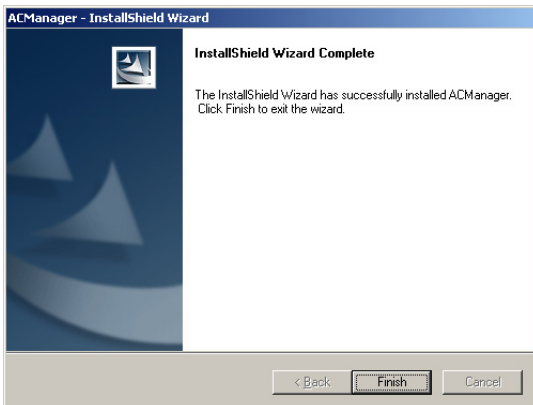

This screen indicating the installation is completed appears.

Click Complete button.

Now AC Manager program installation is completed.

Connecting Lock key to AC Manager



Insert Hard Lock key into USB port of AC Manager PC. All functions of AC Manager will be determined by the authentication key.

While using AC Manager, this key should be kept inserted in PC.

AC Manager Log-in

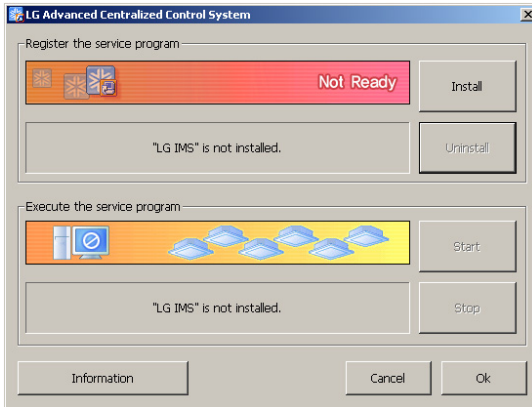

Click Install button in above screen and click Start button. As shown below, it will change to “Service status: Running”.

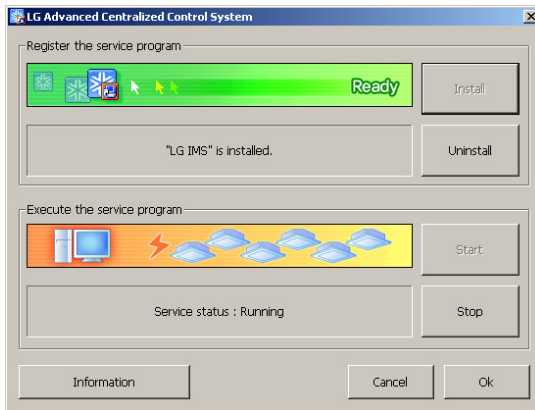

1. Execute AC Manager engine program. Click [Start] → [Program] → [LG Electronics inc] → [AC Manager] → [ACMSvcManager] to execute this screen.

Or, you can double-click ACMSvcManager direct link icon as shown on the right.



If it changes to “Service status: Running”, this means the program begins normally.

Press OK button and exit this window.

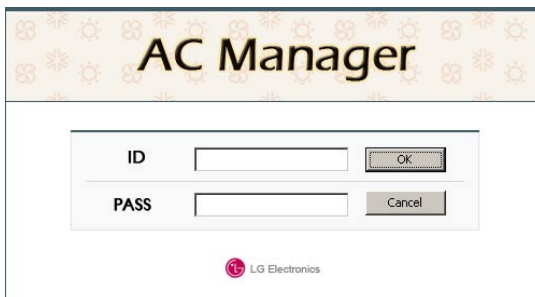

2. Execute AC Manager program. Click [Start] → [Program] → [LG Electronics inc] → [AC Manager] → [AC Manager] to execute the below screen.

Or, if you double-click AC Manager direct link icon as shown in the right figure, this screen will be executed.



If the program is executed, the program initial screen appears after the loading screen.

Note : ID

The manager ID of AC Manager is as follows;

ID : admin , Password : digital21

Use this when you first log in and after log-in, we recommend another ID and password.

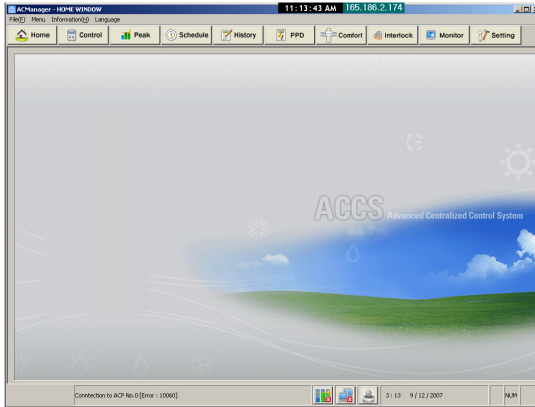

3. Log in

After entering ID and password in log-in window, click the button.

For administration, enter ID and password. (ID : admin , Password : digital21)

① Log-in succeed

When log-in succeed, the loading screen appears at the bottom and a message appears.

② Log-in failed

Loading screen doesn't appear and the fail message appears at the bottom.

- Wrong Password: Wrong Password. (Identify upper and lower case letters.)
- Wrong ID: Unregistered ID. (Identify upper and lower case letters.)

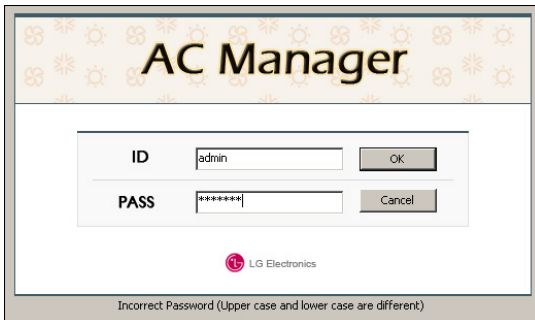

4. AC Manager program is always executed while the authentication key is inserted. When the program is executed without the authentication key inserted, following warning message appears. You should click OK and re-execute after inserting the key.

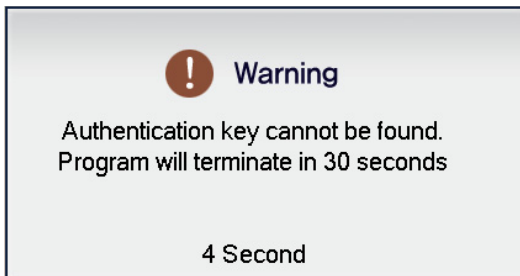
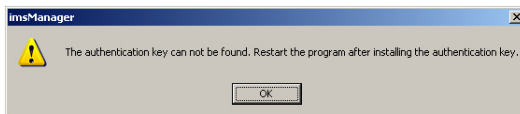

If the authentication key comes out or the user takes it out, the warning message below appears. If you insert the authentication key within 30 seconds, the warning window disappear, the program will normally operate.

Warning



The authentication key cannot be found! If this isn't solved within 30 minutes, this program automatically shut down.

Note : Lock key

When using AC Manager, keep Hard Lock key inserted in the USB port of AC Manager PC. All functions of AC Manager will be determined by the authentication key.

AC Manager program deletion

For reference, let's find out how to delete AC Manager program. This description is based on Window XP.

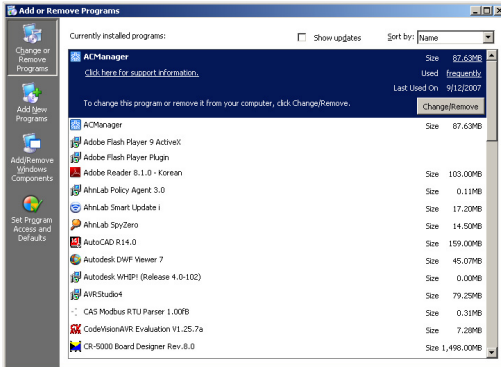

1. Click [Start] → [Control board] → [Add/delete program].

Find imsManager program in this window and click modify/delete button.

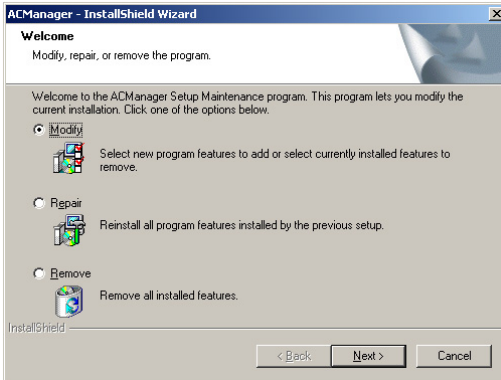

2. The window that you can delete program appears.

After checking the delete menu in this window, click next.

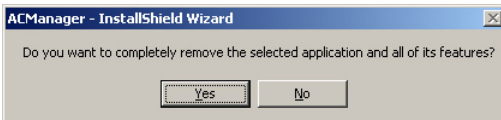

3. The window that confirms the program deletion appears.
Click Yes.

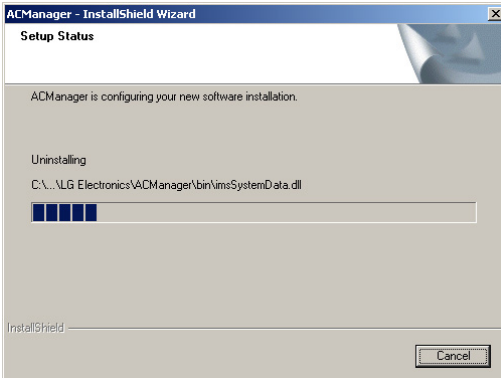

The window that confirms the program deletion appears.

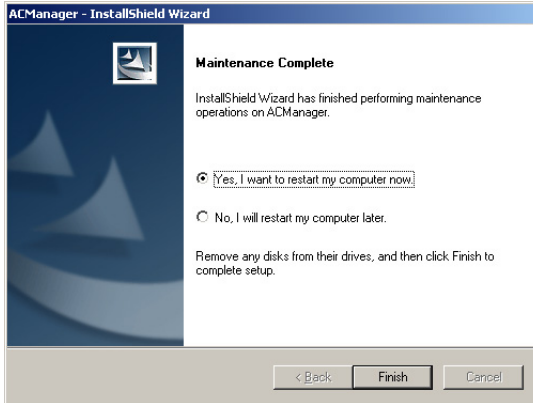

4. The window indicating the program deletion is completed appears. Click Complete.

Caution: Restart the computer



After removing AC Manager program, you should restart the computer immediately.

3. AC Manager Operation

If AC Manager program is installed, following menu and functions are available.

- What is in menu
- Preset
- Default control
- Peak control
- Schedule
- History management
- Accumulated power
- Pleasant control
- Device connected control
- Monitor

Let's find out screen descriptions and how to use each function.

What is in menu

Below is the entire menu construction of AC Manager.

Home	Main screen	Decide display content from the top menu	
Basic control	Air conditioner control	Ventilator control	
Peak control	Desired power consumption display and control	Current power consumption display	Set/Cancel peak operation
Schedule	Edit/Set weekly schedule	Edit/Set special schedule	Set lock schedule
	Set all stop schedule	Transmit current schedule	
Manage history	Save operating status information for all air conditioners		
Accumulative power	Power consumption distribution for each room		
Fresh control	Auto changeover operation	Temperature limit operation	
Device interface control	Operation setting according to product condition		
Monitor	Indoor unit status information monitor	Error status monitor	
System setting	Setting before using AC Manager	Schedule group setting	Control group setting

Preset

Let's find out more details on most basic menu and button functions of the main screen of AC Manager. Before using AC Manager, we will find out preset items. The description will be based on the screen of which menu is set in English.

AC Manager Main Screen

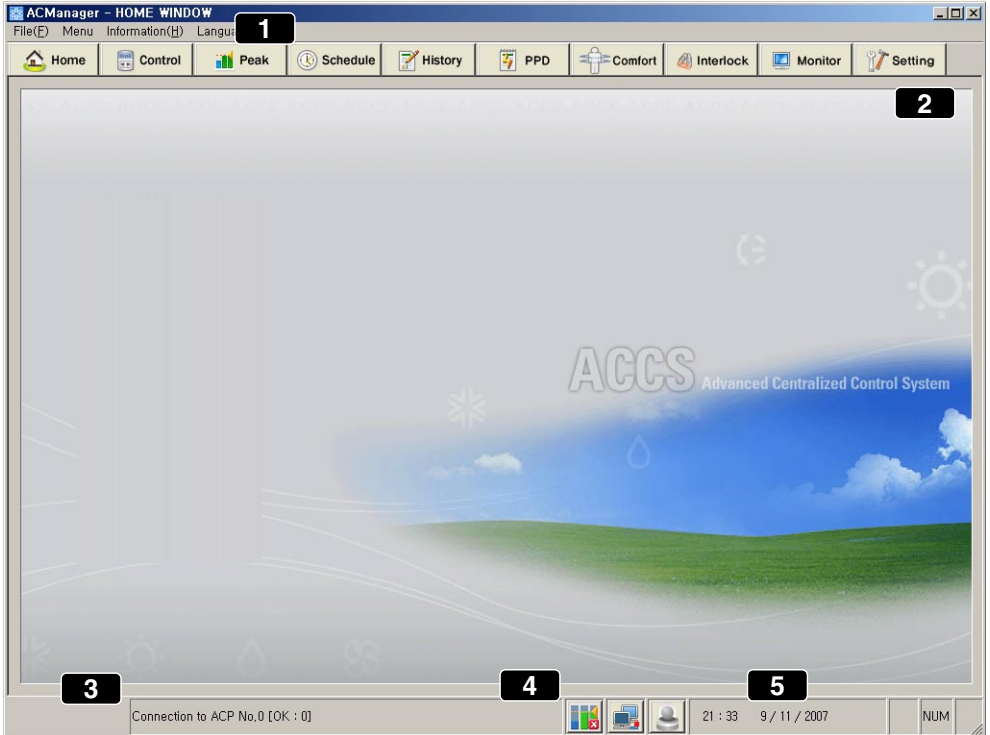

1 Basic menu

In file menu, below sub menu is dropped down.



User title setting: You can set user's name.

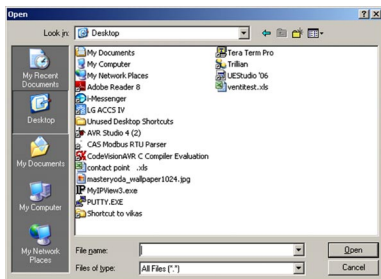

User screen setting: You can set the screen to be placed into main image.

Default screen : You can set default main image.

Exit : You can exit this menu.

- Menu

Sub menu like Home, Default control, Peak control, Schedule, History Management, Accumulated power, Pleasant control, Device connected control, Monitor and System setting is dropped down. Click each sub menu to display the function. You can see the same screen as the one that appears when clicking each menu of (2).

- Program information

Shows current version and program information in AC Manager information.

- Language

The language to be used in AC Manager can be set in English, Korean, Spanish, Chinese, French, Italian and German.





2 Menu selection button

Select the menu to carry out tasks like default control, peak control, schedule, history management, accumulated power, pleasant control, device connected control, monitor and system setting.

3 Message window

Summarizes the operation details and shows the message when problems occur.

4 Indicates peak operation rate control, network connection status and fire alarm.

Item	Description
	Executing peak operation rate control mode
	Stopping peak operation rate control mode
	Network error (NE)
	Network normal connection

5 Indicates current year, month, date and hour.

AC Manager Preset Items

If you select the system setting in menu selection, the information setting window as shown in below figure appears. You can use AC Manager only when you preset the name of indoor unit, using functions, user register and control group, schedule group.

Caution :ID



If you log in not with manager ID, but with ordinary ID, you can set this part.

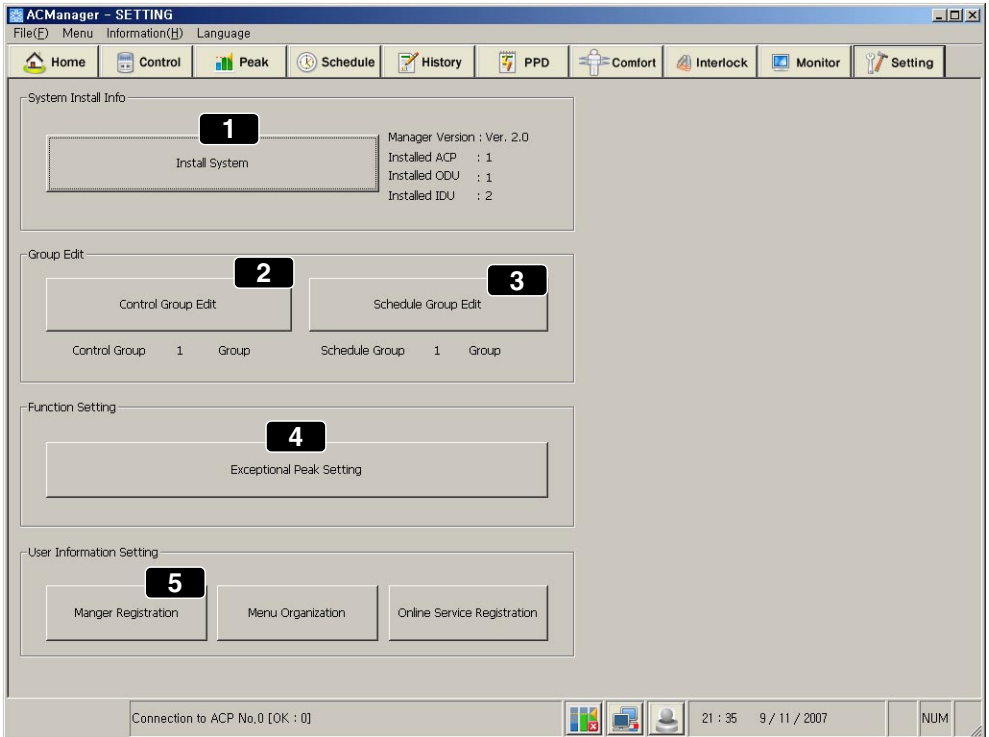

Let's find out each button on above screen.

(1) System installation

Registers indoor unit and sets its name.

(2) Edit control group

Edits the control group.

(3) Edit schedule group

Edits the schedule control group.

(4) Peak exception setting

Sets the indoor unit for peak operation exception.

(5) User information setting

Registers the manager and menu construction and on-line service.

Specific description on each menu is as follows;

1 System Installation

Click system installation button and you can see the below window.

PHY SETTING

ACP Default IP: 192 . 168 . 123 . 100

Outdoor Unit: Print Info

Nu...	ACP Name	IP Address	PORT	Outdoo...	Indoor ...
0	ACP [0]	165.186.63.192	9100	1	16

ACP Nu...	ODU Number	ODU Name	Model	Power Con...	Number of ...
0	0	ODU [0-0]	DEFAULT	9400	16

Edit Basic Input Add Delete Edit Basic Input Add Delete

Indoor Unit

ACP Num...	ODU Number	IDU Number	IDU Name	Type	Model	Power Consum...
0	0	0	UNIT [0-0-0]	UAC	DEFAULT	200
0	0	1	UNIT [0-0-1]	UAC	DEFAULT	200
0	0	2	UNIT [0-0-2]	UAC	DEFAULT	200
0	0	3	UNIT [0-0-3]	UAC	DEFAULT	200
0	0	4	UNIT [0-0-4]	UAC	DEFAULT	200
0	0	5	UNIT [0-0-5]	UAC	DEFAULT	200
0	0	6	UNIT [0-0-6]	UAC	DEFAULT	200
0	0	7	UNIT [0-0-7]	UAC	DEFAULT	200
0	0	8	UNIT [0-0-8]	UAC	DEFAULT	200
0	0	9	UNIT [0-0-9]	UAC	DEFAULT	200
0	0	10	UNIT [0-0-10]	UAC	DEFAULT	200
0	0	11	UNIT [0-0-11]	UAC	DEFAULT	200
0	0	12	UNIT [0-0-12]	UAC	DEFAULT	200
0	0	13	UNIT [0-0-13]	UAC	DEFAULT	200
0	0	14	UNIT [0-0-14]	UAC	DEFAULT	200
0	0	15	UNIT [0-0-15]	UAC	DEFAULT	200

Edit Basic Input Add Delete

PORT Usage Edit

Register an outdoor unit

Outdoor Unit location setting

All Basic input

Save

Close

Note: Calling for installation professionals

- Since entering ACP information and the outdoor unit information is basic information for system operation, wrong amendment may cause trouble in using AC manager. If amendment is necessary, please call for installation professionals.
- The address other than the indoor unit name in entering the indoor unit information may also cause trouble in using AC Manager. If amendment is necessary, please call for installation professionals.
- In order to use the system safely, it is recommended for user not to amend anything but indoor unit name in entering the indoor unit information.
- If the information of the system installation is amended, the schedule information is all gone, so please be careful in use.

From above screen, this is description on ACP basic IP information setting.

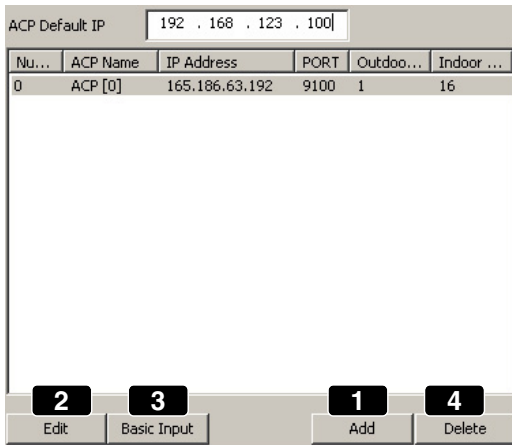

Nu...	ACP Name	IP Address	PORT	Outdoor...	Indoor ...
0	ACP [0]	165.186.63.192	9100	1	16

1. Enter (1) add button on the bottom of ACP basic IP information description screen.

2. Using (2) edit button, you can see below pop-up window.

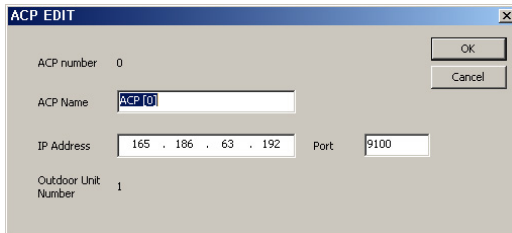

After entering the IP of the installed ACP, click OK button and then, the settings are stored and this window is closed.

3. If there are many ACP's, click (3) basic entering button and then, 16 ACP's are set all at the same time.

ACP Default IP: 192 . 168 . 123 . 100

Nu...	ACP Name	IP Address	PORT	Outdoo...	Indoor ...
0	ACP [0]	165.186.63.192	9100	1	16
1	ACP [1]	192.168.123.101	9100	0	0
2	ACP [2]	192.168.123.102	9100	0	0
3	ACP [3]	192.168.123.103	9100	0	0
4	ACP [4]	192.168.123.104	9100	0	0
5	ACP [5]	192.168.123.105	9100	0	0
6	ACP [6]	192.168.123.106	9100	0	0
7	ACP [7]	192.168.123.107	9100	0	0
8	ACP [8]	192.168.123.108	9100	0	0
9	ACP [9]	192.168.123.109	9100	0	0
10	ACP [10]	192.168.123.110	9100	0	0
11	ACP [11]	192.168.123.111	9100	0	0
12	ACP [12]	192.168.123.112	9100	0	0
13	ACP [13]	192.168.123.113	9100	0	0
14	ACP [14]	192.168.123.114	9100	0	0
15	ACP [15]	192.168.123.115	9100	0	0

Edit Basic Input Add Delete

Except the installed Quantity of ACP's, when you delete rest of them, use (4) delete button.

Below is description on the outdoor unit information description.

Outdoor Unit Print Info

ACP Nu...	ODU Number	ODU Name	Model	Power Con...	Number of ...

3 Edit 2 Basic Input 1 Add 4 Delete

In this part, the outdoor unit information is added.

1. If you press (1) add button, the outdoor unit information is added to below the selected ACP's.

2. Click (2) basic entering button, and then the information on up to 16 outdoor units that can be set as below is set at the same time.

ACP Nu...	ODU Number	ODU Name	Model	Power Con...	Number of ...
15	0	ODU [15-0]	DEFAULT	9400	0
15	1	ODU [15-1]	DEFAULT	9400	0
15	2	ODU [15-2]	DEFAULT	9400	0
15	3	ODU [15-3]	DEFAULT	9400	0
15	4	ODU [15-4]	DEFAULT	9400	0
15	5	ODU [15-5]	DEFAULT	9400	0
15	6	ODU [15-6]	DEFAULT	9400	0
15	7	ODU [15-7]	DEFAULT	9400	0
15	8	ODU [15-8]	DEFAULT	9400	0
15	9	ODU [15-9]	DEFAULT	9400	0
15	10	ODU [15-10]	DEFAULT	9400	0
15	11	ODU [15-11]	DEFAULT	9400	0
15	12	ODU [15-12]	DEFAULT	9400	0
15	13	ODU [15-13]	DEFAULT	9400	0
15	14	ODU [15-14]	DEFAULT	9400	0
15	15	ODU [15-15]	DEFAULT	9400	0

Click (3) edit button.

3. Select (3) Edit, and then you can edit basic information in below window. In this window, you can edit the name, model and etc. of the outdoor unit you want.

Edit an Outdoor Unit

ACP number: 15

Outdoor Unit: 15

Outdoor Unit Name: ODU [15-15]

Outdoor Unit Model: DEFAULT

Maximum Power: 9400 W

Number of indoor units: 0

Buttons: OK, Cancel

After setting, click OK button and exit this window.

The outdoor unit that isn't installed can be deleted using (4) Delete button in the default screen.

Below is description on setting the information on the indoor unit.

Indoor Unit

ACP Num...	ODU Number	IDU Number	IDU Name	Type	Model	Power Consum...

3 Edit 2 Basic Input 1 Add 4 Delete

1. Click (1) Add and then one indoor unit information is added to under the outdoor unit at a time. You can add the list by clicking as many as the number of the indoor unit.
2. After selecting the outdoor unit, click (2) Input default button, and then the entire indoor unit information that can be set will be input.

Indoor Unit

ACP Num...	ODU Number	IDU Number	IDU Name	Type	Model	Power Consum...
15	15	0	UNIT [15-15-0]	UAC	DEFAULT	200
15	15	1	UNIT [15-15-1]	UAC	DEFAULT	200
15	15	2	UNIT [15-15-2]	UAC	DEFAULT	200
15	15	3	UNIT [15-15-3]	UAC	DEFAULT	200
15	15	4	UNIT [15-15-4]	UAC	DEFAULT	200
15	15	5	UNIT [15-15-5]	UAC	DEFAULT	200
15	15	6	UNIT [15-15-6]	UAC	DEFAULT	200
15	15	7	UNIT [15-15-7]	UAC	DEFAULT	200
15	15	8	UNIT [15-15-8]	UAC	DEFAULT	200
15	15	9	UNIT [15-15-9]	UAC	DEFAULT	200
15	15	10	UNIT [15-15-10]	UAC	DEFAULT	200
15	15	11	UNIT [15-15-11]	UAC	DEFAULT	200
15	15	12	UNIT [15-15-12]	UAC	DEFAULT	200
15	15	13	UNIT [15-15-13]	UAC	DEFAULT	200
15	15	14	UNIT [15-15-14]	UAC	DEFAULT	200
15	15	15	UNIT [15-15-15]	UAC	DEFAULT	200

Edit Basic Input Add Delete

3. Select the indoor unit and click (3) Edit button, and then below window appears. In this window, you can edit the name, type and etc. of the indoor unit you want.

Edit an Indoor Unit

ACP number 15

Outdoor Unit Number 15

Indoor Unit Number 15

Indoor unit Name UNIT [15-15-15]

Device Type JAC

Indoor Unit Model DEFAULT

Maximum Power 200 W

OK

Cancel

After setting, click OK to exit this window. The outdoor unit that isn't installed can be deleted using (4) Delete button in the default screen.

4. Click Edit port use button and then below window appears.

PORT Setting

ACP 15

DI PORT

Being Used or...	PORT	Use	Name
Not being Used	1	SIGNAL IN	PORT 15-1
Not being Used	2	SIGNAL IN	PORT 15-2
Not being Used	3	SIGNAL IN	PORT 15-3
Not being Used	4	SIGNAL IN	PORT 15-4
Not being Used	5	SIGNAL IN	PORT 15-5
Not being Used	6	SIGNAL IN	PORT 15-6
Not being Used	7	SIGNAL IN	PORT 15-7
Not being Used	8	SIGNAL IN	PORT 15-8
Not being Used	9	SIGNAL IN	PORT 15-9
Not being Used	10	SIGNAL IN	PORT 15-10
Not being Used	11	SIGNAL IN	PORT 15-11
Not being Used	12	SIGNAL IN	PORT 15-12
Not being Used	13	SIGNAL IN	PORT 15-13
Not being Used	14	SIGNAL IN	PORT 15-14
Not being Used	15	SIGNAL IN	PORT 15-15
Not being Used	16	SIGNAL IN	PORT 15-16
Not being Used	17	SIGNAL IN	PORT 15-17
Not being Used	18	SIGNAL IN	PORT 15-18
Not being Used	19	SIGNAL IN	PORT 15-19
Not being Used	20	SIGNAL IN	PORT 15-20

DO PORT

Being Used or...	PORT	Use	Name
Not being Used	1	EXT. CONTROL	PORT 15-1
Not being Used	2	EXT. CONTROL	PORT 15-2
Not being Used	3	EXT. CONTROL	PORT 15-3
Not being Used	4	EXT. CONTROL	PORT 15-4

Edit

Edit

Save

Close

You can check and edit port information in this screen.

5. Click Edit button and below window will appear.

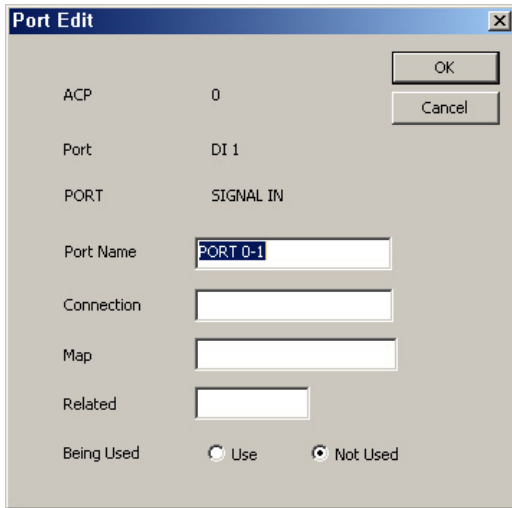

ACP	0	OK
Port	DI 1	Cancel
PORT	SIGNAL IN	
Port Name	PORT 0-1	
Connection		
Map		
Related		
Being Used	<input type="radio"/> Use	<input checked="" type="radio"/> Not Used

Set port name, connection device, drawing information, connected port, use and etc. and then, click OK button to save the contents.

2 Edit control group

After system setting, the group should be edited. There are 2 types of groups, the control group with main functions of control and monitoring and the schedule group operating according to the same schedule as that of the control group. All indoor unit can normally operate only when it is included in the control group and the schedule group by the group edit.

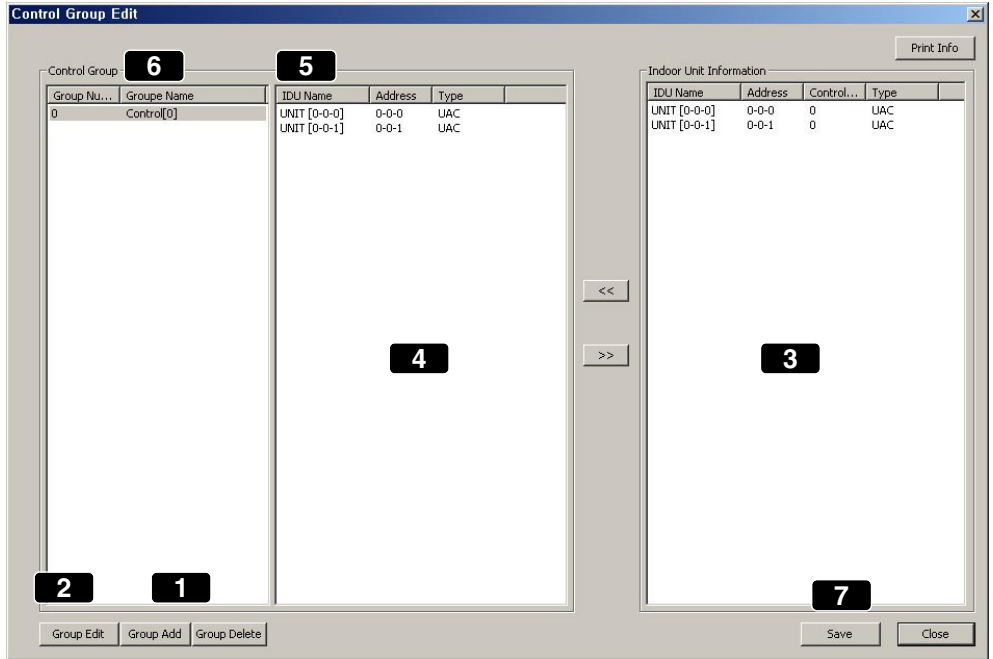

Let's find out how to add the control group.

1. Using (1) Add group button, add the group.
2. After selecting the group, using (2) Edit group button, you can change the name of group in below window.

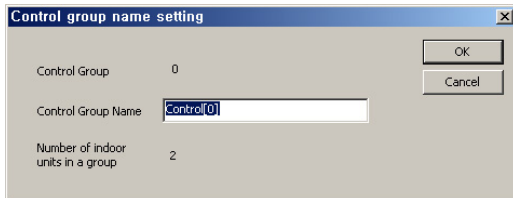

After inputting the group name, click OK button.

Let's find out how to select the indoor unit.

1. Select the desired indoor unit of the indoor unit information in (3) and click << button and then, this indoor unit moves to (4). Now this indoor unit will be contained in the selected group.
2. When you want to exclude a indoor unit from the group, select the indoor unit and click >> button.
3. Click (5) Indoor unit name, address and control group button and you can sort the indoor unit for each item in ascending order. If you move and set the selected indoor unit in this way, the selected/moved device will have the number of the group in the control group of the indoor unit as (6).
4. Using Save button in (7), save the information.

Note: Key selection

- Using information print-out button, you can print out the information in excel or by printer.
- When selecting the indoor unit, while pressing Ctrl key, select one device and then, it is added. While pressing Shift key, select one device, and then the entire indoor units from previous one to current one are selected.

3 Edit schedule group

A group setting function to carry out schedule function. After system setting, the schedule group should be edited. The schedule group can be set in the same way as the control group.

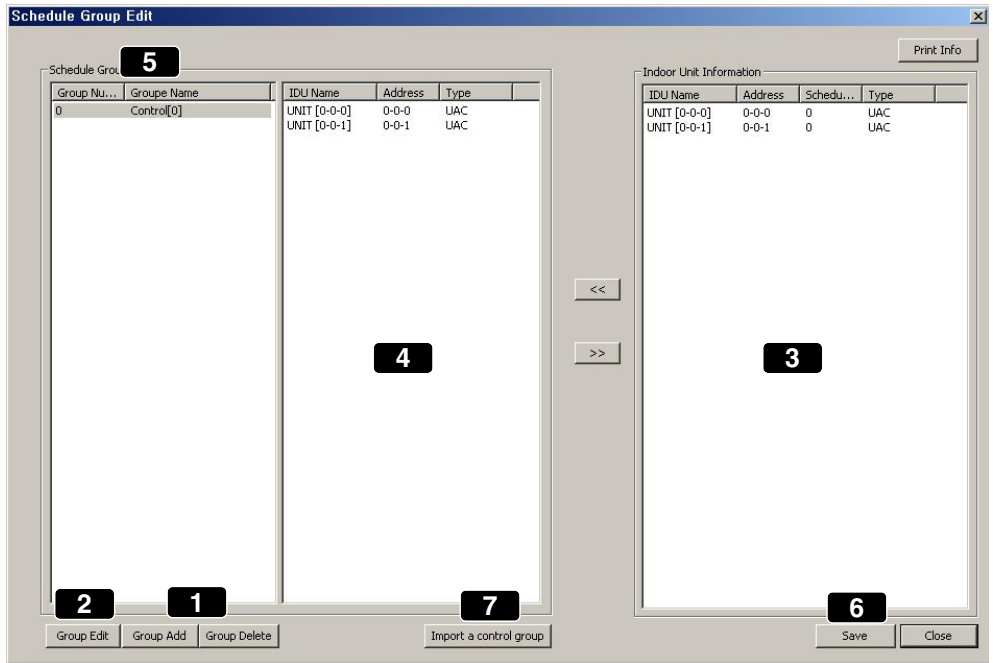

Let's look over how to add the schedule group.

- Using (1) Add group button to add the group. Click Add group button and the group name automatically appears in (5) area.
- After selecting the group from the control group, using (2) Edit group, you can change the name of the group. In this way, the desired group can be added and deleted.

Let's find out how to select the indoor unit.

- If you select the indoor unit you want from the indoor unit information in (3) and click << button, the indoor unit can be set in the selected group. If you want to exclude the indoor unit from the group, while selecting the device, click >> button. Click (7) Import control group button, and you can import the control group settings that you set with System setting button on the top.
- If you click the indoor unit name, address and control group button, you can sort the indoor units in ascending order for each item. If you move the indoor unit using >> and << button, the selected/moved indoor unit will have the number of its group in the control group of the indoor information as (5).
- Using (6) Save button, save the information.

Note: Information Print-out button

- You can print out the information in Excel or by printer using Information print-out button.
- When selecting the indoor unit, while pressing Ctrl key, select one indoor unit and then this will be added.
- While pressing Shift key, select one indoor unit, and the entire devices from previous

4 Peak exception setting**Note: Peak**

Details on Peak will be explained in the description on each menu after the description on the main screen.

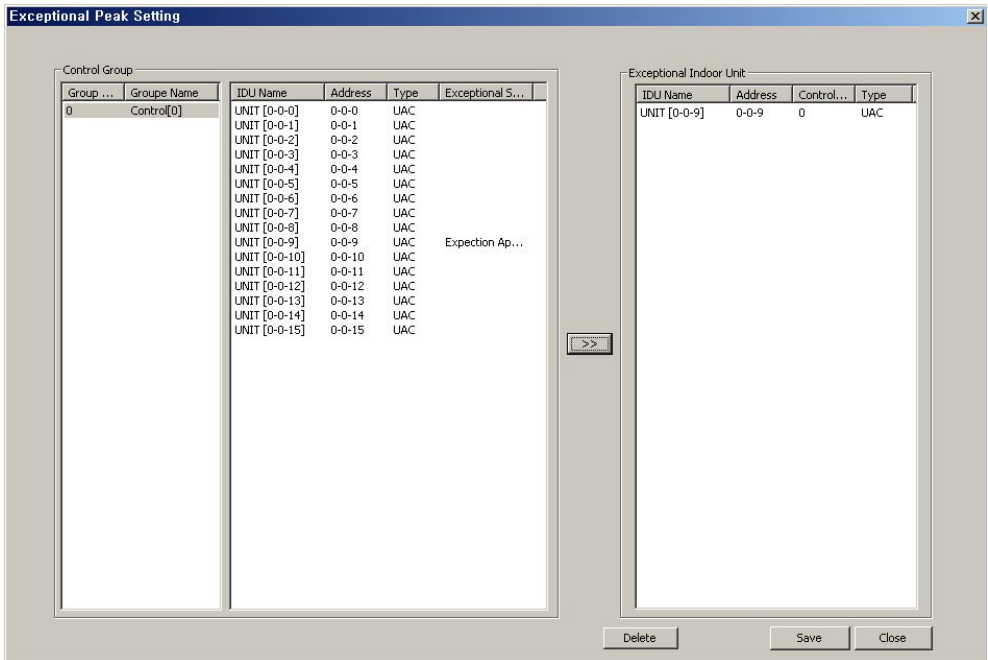

1. After selecting the indoor unit that peak isn't applied in (1), click >> button and then, peak "isn't applied to" the device, which is reflected to (2).
2. Click (3) Save button to save current status.

5 User I information setting

You can set the information on the user of AC Manager.

1. Click Register manager button in user information setting, and then below window appears.

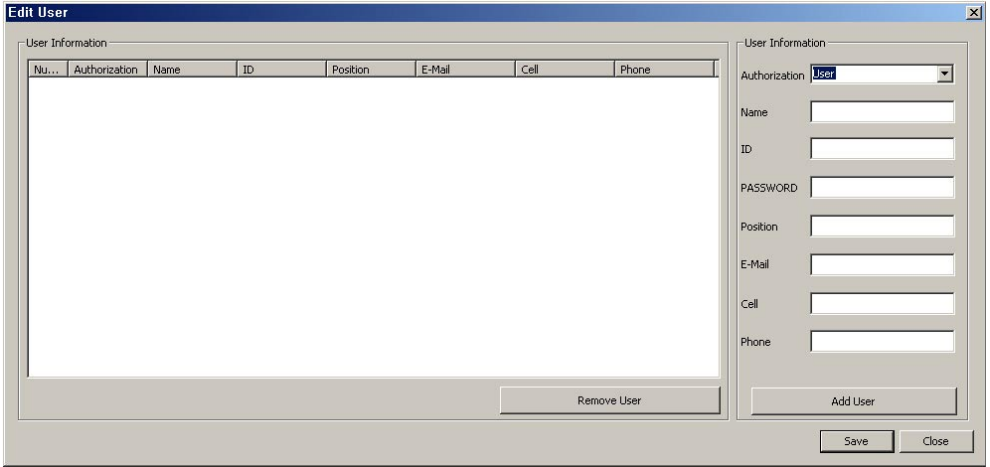

2. Click Menu button and below window appears.



Select Menu button to be shown in the main menu of AC Manager. If you check all menu, all menu in the main screen of AC Manager will be checked. If you check basic menu, some menu initially set will appear in the main screen. After checking the menu you want, click OK button. If you click Cancel button, you can exit current window.

3. If you click on-line service register button, below window will appear.

Online Service Setting

Remote Service Info

Service Server

Service

Remote Monitoring Sec

History Update Cycle Sec

Field Information

Field Name

Field Code

Use

If you want to register to web site as an AC Manager user, enter service server and field information. After entering what you want, click OK button. Click Cancel button to exit current window.

Basic Control

Basic control means functions like selection of group and air conditioner by AC Manager, operation mode, wind strength, wind direction, all lock, individual lock(temperature lock, mode lock, wind lock), desired temperature setting, operation and stop and etc. Click basic control button and below window appears.

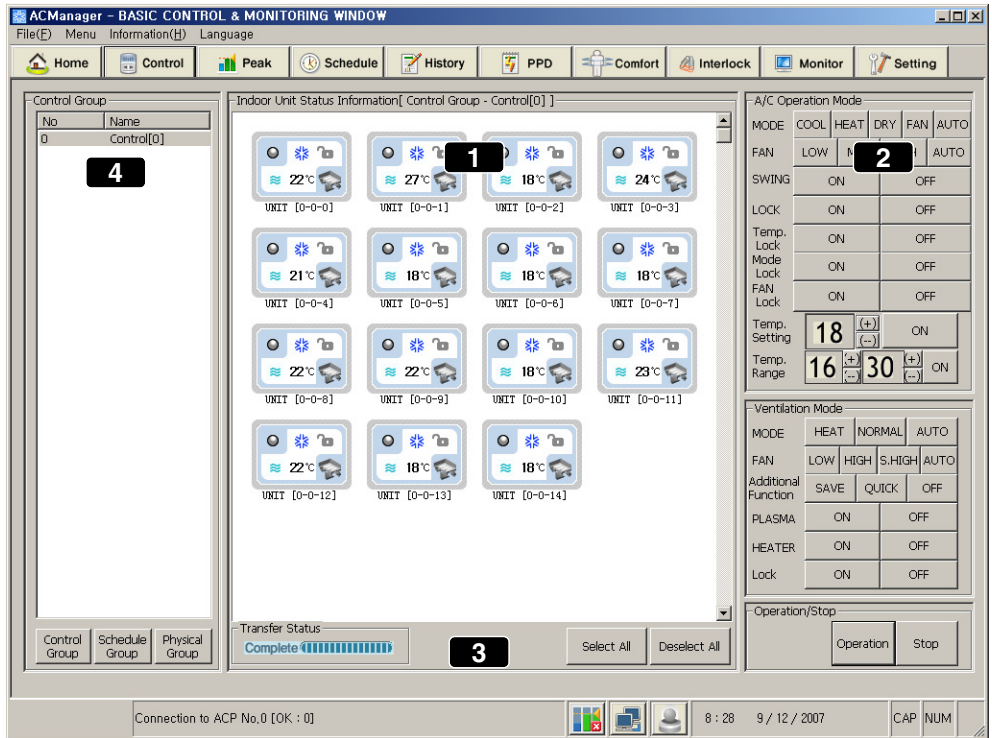

Above menu is the control program with central control method which manages the air conditioner using computer screen. Using above buttons, you can easily operate and monitor the status of air conditioner and integrately maintain the groups.

- (1) Indoor unit operation status indication and selection window
- (2) Control button
- (3) Selection button and transmission status indication
- (4) Group selection window



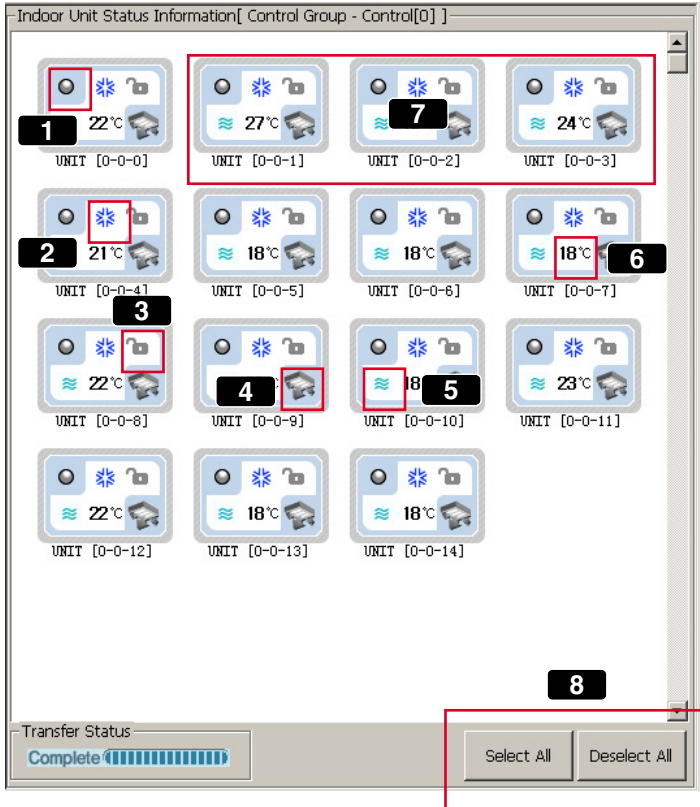

Let's find out how to use each part.

Indoor unit operation status indication and selection window



Let's find out the description on each part indicated on above menu.













1 Operation status lamp

Lamp color	Description
	Operation status indication
	Error indication
	Stop indication
	Indication that the control details are being transmitted







2 Operation mode lamp

The mode being operated is indicated as an icon.

<Air conditioner>



Operation mode	Description
	Cooling operation indication
	Cooling operation stop indication
	Moist-removing operation indication
	Moist-removing operation stop indication
	Wind operation indication
	Wind operation stop indication
	Heating operation indication
	Heating operation stop indication
	Auto operation indication
	Auto operation stop indication
	Peak power control operation indication
	Error indication of Indoor unit
	Error indication of network error

<Air conditioner>



Operation mode	Description
	Electric heating indication Ventilation mode of air supply/discharge through electric heating Exchanger. In summer/winter when temperature and humidity difference between indoor and outdoor is big, use electric heating exchange mode.
	Electric heating operation stop indication
	Normal indication Ventilation mode of discharged air not passing through electric exchanger. Used in spring/fall when temperature and humidity difference between indoor and outdoor is small.
	Normal operation stop indication
	Auto indication Optimally operated in order to keep the balance of indoor air by measuring indoor and outdoor temperature and auto-controlling supplied and discharged air. When connected to Multi V, other than indoor and outdoor temperature, the operation is determined by operation speed setting temperature.
	Auto operation stop indication

3 All lock





A function that the operation of air conditioner cannot be controlled individually. In All lock, the air conditioner can be controlled only from AC Manager.

Lock	Description
	Activate All lock
	Deactivate all lock

4 Kind of unit

Icon	Description
	Activate All lock
	Deactivate all lock

5 Wind strength

Icon	Description
	Weak wind strength
	Weak medium wind strength
	Strong wind strength
	Auto wind

6 Desired temperature

Indicates desired temperature for each air conditioner. In error status, this isn't indicated.

7 The selected indoor unit has thick blue background screen.**8 Select all and deactivate all**

- Select all : All air conditioners of currently set group are selected.
- Deactivate all : All the selected air conditioners are deactivated.

Control button

The control button includes air conditioner control button and ventilation control button. Operation/stop button is used for both air conditioner and ventilation.

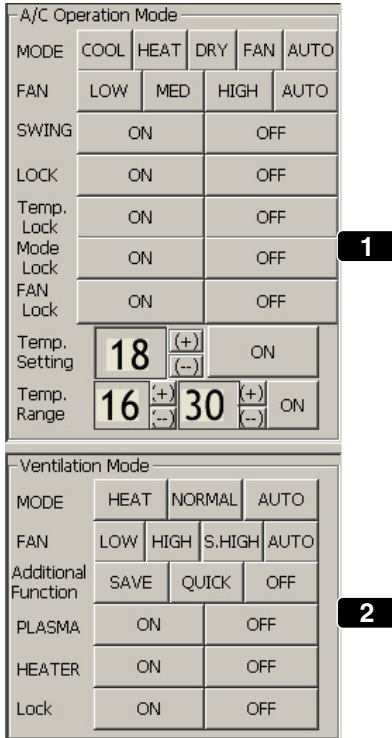

1 Air conditioner operation mode

Button	Description
Cool	The desired temperature can be selected between 18°C and 30°C. Excessive cooling isn't good for your health, therefore we recommend to set appropriate desired temperature. The temperature difference between indoor and outdoor is about 5°C.
Heat	The desired temperature can be selected between 18°C and 30°C. Excessive heating isn't good for your health, so please set appropriate desired temperature. The temperature difference between indoor and outdoor is about 5°C.
Dry	If you use this function in rainy season or in high humidity, you can remove humidity effectively. If you select removing humidity, the desired temperature cannot be set.
Fan	Air purification operation provides pleasant wind. In spring and fall, you may use only air purification. If you select wind, the desired temperature cannot be set.
Auto	It evaluates the indoor condition and maintains the optimal condition automatically.

Wind strength

A function adjusting the wind strength to weak, medium, strong and auto.

Wind direction

The wind direction of air conditioner can be set.

Lock

There are All lock, temperature lock, Mode lock and Wind strength lock. temperature lock is for locking temperature setting function, Mode lock is for mode setting function, wind strength lock is for wind strength function. All lock is for locking all functions. Once lock is set, wire or wireless remote control isn't possible.

Caution: Temperature lock

If the temperature lock command is sent at the temperature out of the desired temperature range, the device may not normally operate for the setting temperature, so be sure to set temperature lock at the temperature within the desired temperature range.

Caution: Individual lock setting(Temperature, wind strength lock)

Individual lock setting(Temperature, wind strength lock)

When 2-pin connector of PI485 is inserted, changing mode from wire remote controller may change to previous mode during temperature and Wind Lock setting. In this case, if you set temperature lock and Mode lock at the same time, you can solve this problem. If 2-pin connector of PI485 is connected, we recommend you to use Temp lock and Mode lock at the same time.

Desired temperature

Using (+), (-) button set the desired temperature. The desired temperature can be set between 18 and 30°C when cooling and heating, and if you press setting button, the temperature setting command is sent to the indoor unit. If you preset the desired temperature setting range, the temperature can be set within that range. When removing humidity or Wind is selected in operation mode, temperature cannot be set.

2 Air conditioner ventilation mode

- Operation mode

Icon	Description
Electric heating	Ventilation mode of supplied/discharged air through electric heating exchanger. In summer/winter when temperature and humidity difference between indoor and outdoor is big, use electric heating mode.
Normal	Ventilation mode of supplied/discharged air not through electric heating exchanger. Used in spring/fall when temperature and humidity difference between indoor and outdoor is small

Icon	Description
Auto	Measures indoor and outdoor temperature and automatically adjusts supplied and discharged air and optimally operates to keep the balance of indoor air. ※ When connected to Multi V, other than indoor/outdoor temperature, this find optimum condition by the operation speed and setting temperature.

Wind strength

The wind strength can be selected from weak, strong, ultra strong and auto.

Additional function

Icon	Description
Saving electricity	This operation is made by finding the most ventilation-efficient point and saving the consumed power. The contaminated air can be easily emitted by increasing the emission amount more than the supplying amount.
High Speed	This operation is intended to prevent the indoor contaminated air or humidity from spreading to other rooms. You can use the high speed ventilation function when the indoor contamination is severe. Saving electricity mode and High speed mode cannot be selected at the same time.
Deactivate	Deactivate the additional function.

Plasma

Air purification function that negative ion comes out and make you feel better. This function purifies virus, mold in the house and influenza, which is the most famous cold virus, considering environment and health.

Heater

A function that warms the air in winter when outdoor air is very cold.

Lock

Lock setting function. If you set the lock, it is impossible to control with wire or wireless remote controller.

Operation/stop

If you select operation, the selected ventilation is operated. If you select stop, the selected ventilation under its operation stops.

Select all button and transmission status indication

Transmission status indication bar

Transmitting : If AC Manager is executed for the first time, when you try its operation while it is stops or stops it while it is operated or the control setting is changed, it flickers due to data processing.

Select all

All the air conditioners/ventilation products in currently selected group are selected. If all in the current group are selected, at this time, Select all means all air conditioners/ventilation products of all groups are selected

Deactivate all

Deactivates all the air conditioners/ventilation products currently selected. This works in the same way as Select all button.

Group selection window

Group name	Description
Control group	Logically identifies the group. For example, this identifies, such as lobby on the 1st floor and meeting room on the 2nd floor.
Schedule group	The unit group of schedule setting. Each schedule group has the same schedule.
Physical group	Physical group is divided by ACP unit. For example, there are 3 ACP's and then, 3 groups are constructed.

Select/Deactivate all group

Select all : While pressing Shift key, you can select the group you want. For example, in order to select all, click "0" and while pressing Shift key, select "5".

If you select all groups and click Select all button, then all indoor units in all groups are selected. On the contrary, if you click Deactivate all button, all groups are deactivated.

Select individual group

Click the group you want, to select this function. At this time, if you select all or deactivate all, all the indoor units in the group is selected and deactivated.

Peak control

Peak control is a function managing the maximum consumed power. Peak control can use peak operation rate control or demand control function depending on the specification of installed field.

Main functions of peak control are as follows;

- Managing all the installed air conditioners (Central control method)
- 24 hour peak operation rate monitoring / control
- Easy control/monitoring
- Peak power (kW) / possibly set as operation rate (%)
- Possibly adjust operation switch cycle (5~15 minutes)
- Possibly set an air conditioner not controlled by peak operation rate

The air conditioner forced to operate due to the peak operation rate control function is operating in Wind mode if it is in cooling operation mode and if it is in heating operation mode, the operation stops. However, even if the forced operation changes the air conditioner's operation, this operates for user not to feel the change in the aspect of cooling or heating effect.

If the air conditioner is in the forced operation due to peak operation rate control function, the auto control of the central control method is used, so the air conditioner cannot be controlled individually. However, if the current operation status only consumes the power under the operation rate setting value, the air conditioner can be controlled individually.

Caution: If AC Manager is connected to ACP



If ACP is operated in the connection with AC Manager, do not use the operation rate control function using ACP. ACP operates depending on the peak operation rate setting.

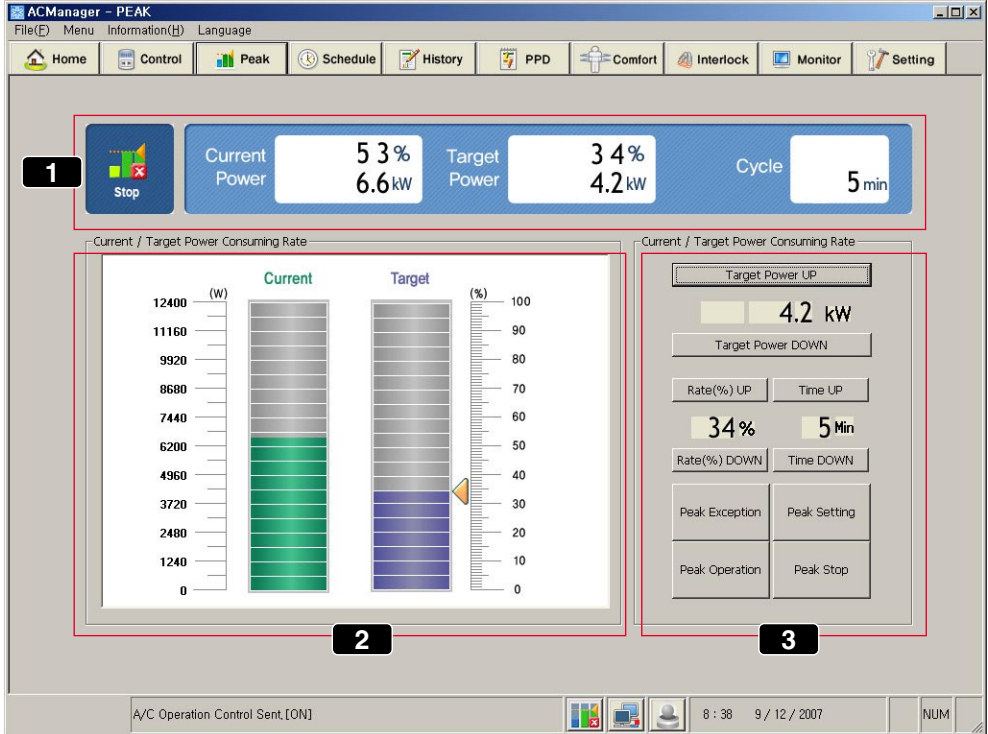

(1) Current operation status & power control setting

(2) Power using amount monitor

(3) Power control setting

From now on, we will find out the using method for each part.

1 Current operation status & power control setting



Current power indicates what percentage the operation rate of current air conditioner reaches compared to total operation rate. In addition, it shows how many kW current using power is.

Current power





Desired power indicates what percentage the operation rate of desired air conditioner reaches compared to total operation rate of air conditioner. In addition, it shows how many kW per hour the desired using power is.

Desired power



This indicates the cycle of the forced operation stop. For example, if it is set to 5 minutes, you should change the air conditioner that is forced to stop every 5 minutes so that the stop time of every air conditioner is the same. The operation switch cycle can be adjusted within 5~15 minutes.

The facility manager checks concurrently power value when all of the currently installed air conditioners are operated and it sets the goal power value. It shows current operation status in graph and numbers at the same time and when setting the goal, it is constructed to enable the method of using graphs and using numbers.

Group name	Description
	Appears when forced operation and forced stop is on.
	Indicates that peak operation rate control function stops.

2 Power using amount monitor

Drag with mouse to set the goal power value. Below power control use appears as bar shape. (Figure. Current operation status/power control setting)

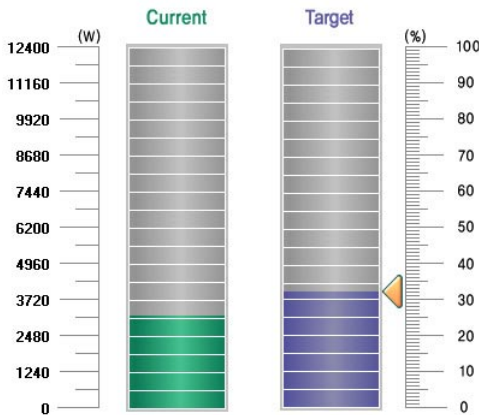

The graph indicating current operation status exists. With this graph, the facility manager can check the power value and the goal power value set when 100% of currently installed air conditioners are operated.

Power setting can be made between 0% and 100%. The power set value set in graph appears linked as the value in power control setting in (3).

For example, the peak operation rate of above screen is set to 32%.

3 Power control setting

There are 2 kinds of power control settings, adjusting the desired power using amount in kW and adjusting it percentage to be operated. If air conditioner operation power exceeds the goal setting value, peak operation rate control will force the air conditioner to operate in certain cycle according to peak operation rate operation rule. The air conditioner forced to stop is operated in Wind mode, so user cannot feel the change due to the forced operation in the aspect of cooling/heating effect.

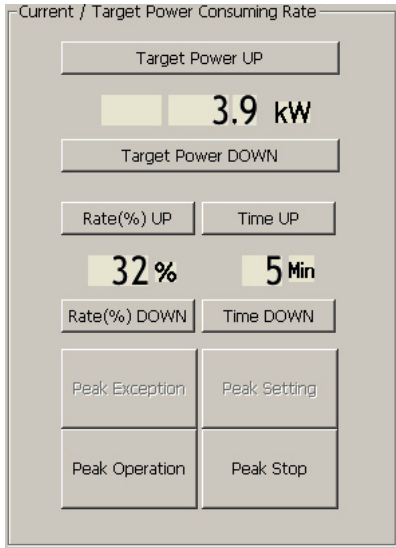

Below is description on each item of above menu.

Button	Description
Desired power	Can be set by 0.1 kW.
Power rate	Can be set between 0% and 100% of maximum available power and adjusted by 1%.
Switch time	Meaning a cycle that stops the forced operation. Can be set between 5 and 15 minutes and can be adjusted by 1 minute.
Peak not applied	According to setting, the minimum value of the desired power and desired power rate changes. This is because the minimum value changes depending on the number of peak not applied air conditioner. The more the number of peak not applied air conditioner, the more the number of operated air conditioner and the power consumed, so the minimum value of desired power and desired operation rate changes.
Peak operation	Peak control is applied to the indoor unit.

Setting peak not applied

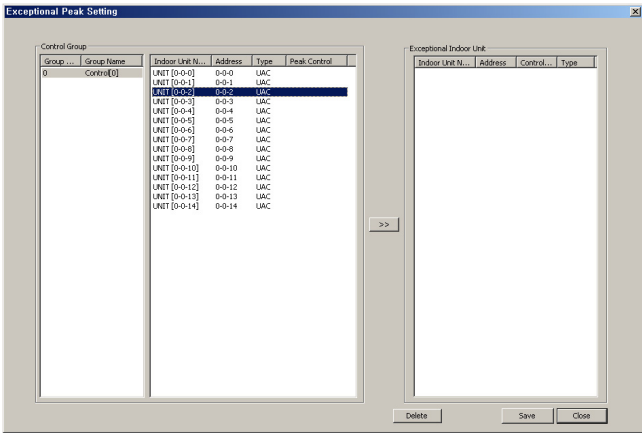

1. The air conditioner not to be affected by peak operation rate control can be registered. Click peak not applied button and this window appears.

After selecting the indoor unit you want, click >> button.

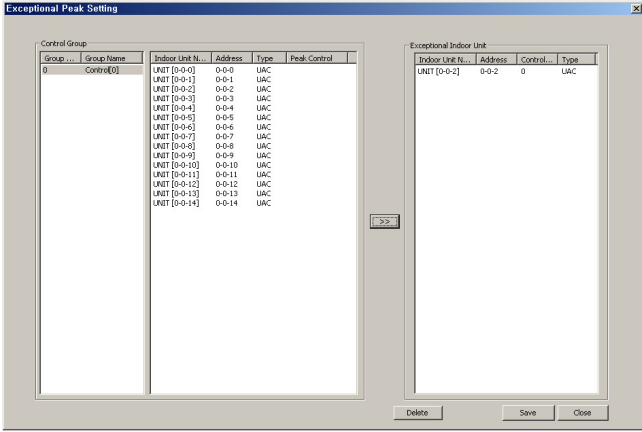

2. The selected indoor unit moves to right panel as shown in this screen.

If you want to set this device to peak control again, while selecting the device, click Delete button.

3. Click Save button to exit this window.

Caution: Peak operation



You shouldn't force to change the indoor unit being controlled by Wind during peak operation rate operation to cooling or heating. Peak operation rate operation problem may occur.

Note: Changing the desired power and the setting value of the desired operation rate

Depending on the setting of peak-not-applied air conditioner, the desired power and the setting value of the desired operation rate may change. The more the number of peak-not-applied air conditioner, the more the number of the air conditioner operated by user's individual control may become. Due to this, the power consumption increases, so the setting value of the desired power and desired operation rate may vary.

Caution: Initialization of peak-not-applied air conditioner

Please note that in system setting menu, if you set the system menu in the system setting menu and then save it, prior information of peak-not-applied

Schedule

Schedule is a function that the operation of air conditioner is preset so that the air conditioner can carry out the preset operation at certain time. Schedule function means that if the air conditioner should be controlled according to certain schedule, user doesn't have to set the operation status every time, and only the press schedule enables the air conditioner to be automatically operated. The period can be set by week, day and 10 minutes and 1 year of schedule can be registered. Using this function, the air conditioner isn't unnecessarily operated, but automatically operated when necessary by controlling from the center, giving excellent energy-saving effect.

Below is the default screen of schedule menu.

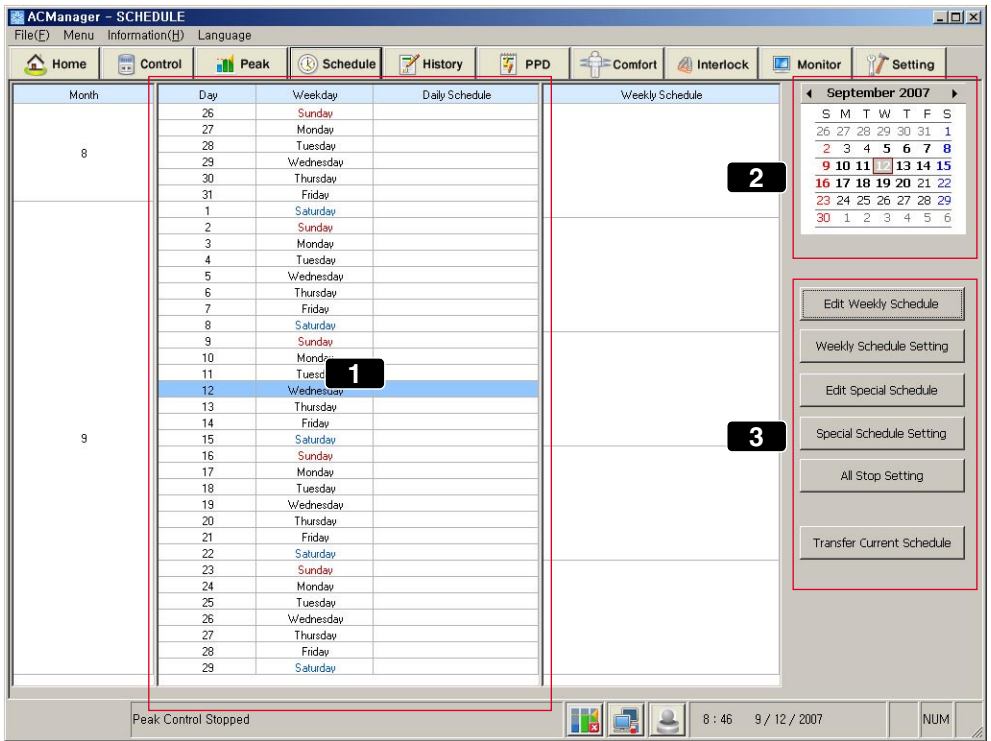

(1) Weekly/Daily schedule calendar

With table-type calendar, you can check current date and set schedule.

(2) Monthly calendar

With basic calendar, this shows the dates of currently selected month and using upper buttons, you can move to the period you want. If you select certain date of the calendar in the above screen, the set schedule of the selected date is updated to appear in the screen.

(3) Schedule function

By creating and editing weekly and special schedule, you can set schedule for your desired period. In addition, using Send current schedule button, you can send currently set schedule to ACP and actually apply it to the air conditioner system.

Note: As for schedule function, we explain on the menu first and then, scenario.

Let's find out each button on the schedule function screen and the screen for display. User can follow the scenario and practice functions like Using weekly schedule function, Using special schedule function, Using entire suspension schedule function, and Sending current schedule in following description.

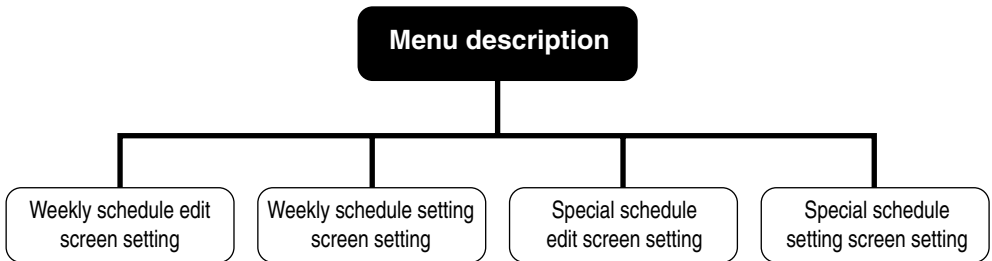

Description on Edit weekly schedule screen

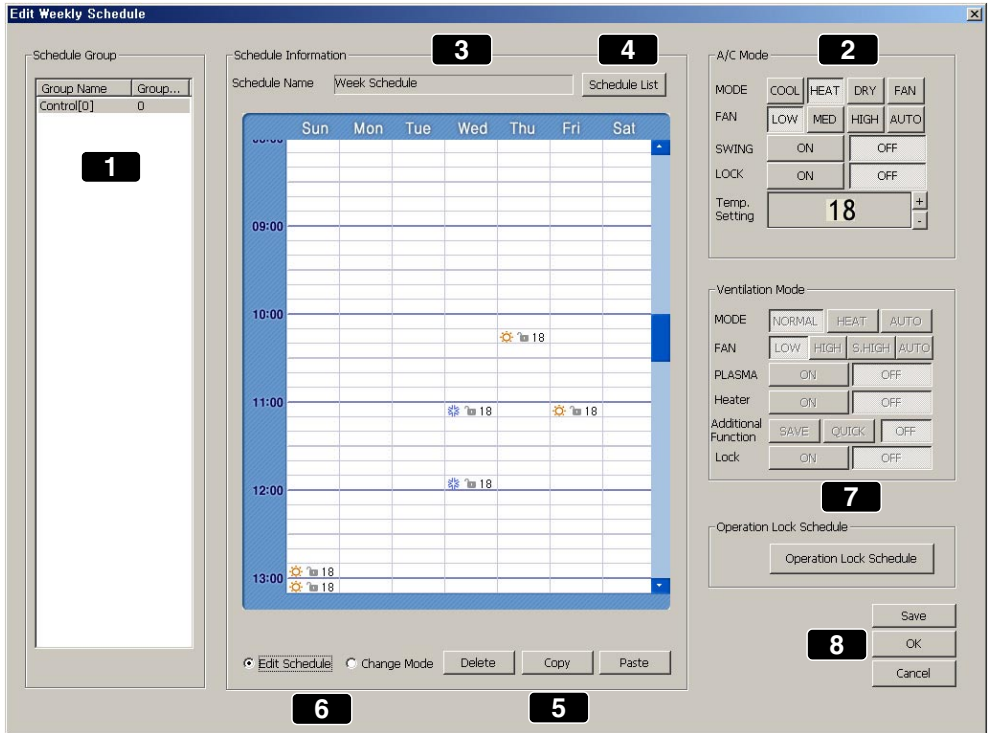

Let's find out about each menu on above screen.

1 Schedule group selection window

The schedule function can be set in such way that the same or unique operation can be made for each schedule group. For currently set group, the group name and group number appear in the list. Among them, you can select the schedule group you want with mouse. If you want to edit the schedule group like add/delete and etc. refer to Edit group menu of the system setting.

2 Control setting window

When the selected schedule group is operated according to the schedule, the operation mode to operate, wind strength, wind direction, lock and desired temperature can be set. The function of control setting button is the same as that of air conditioner control setting button. In addition, the schedule control setting for the selected schedule group can be controlled in many ways for all days and hours. You can click the button to easily switch functions.

3 Weekly operation schedule

In order to set weekly operation schedule for the selected schedule group, drag the mouse and select the desired hour. If you set many hours, draw the desired hour vertically dragging it. This can be set by 10 minutes and the hour can be set by moving the scroll bar up and down. In the area corresponding to the setting hour, the bitmap image showing the selected mode through control setting is shown. If

the setting is wrong or you want to change this, you can drag the hour you want to delete in the above way. By dragging with mouse, the bitmap image that appears in the schedule setting area will show mode, lock and temperature information.

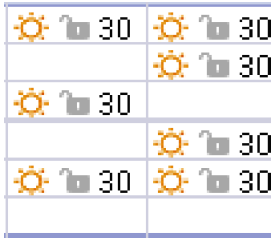

The figure on the right is an image that appears in case of heating, deactivating lock and 30_ setting.

1 Schedule list

This can be used when you want to create/delete or select new weekly schedule.

2 Delete, copy and paste

You can use Delete button when you want to delete the currently displayed schedule. If you want to set the schedule in the way of making schedule hour or control setting information and etc. identical, without any need of repeatedly editing, you can use copy/paste function. Firstly, select the schedule group and check the schedule editing status and then, click Copy button. In addition, select the schedule group you want to apply again and then, click Paste button. Then, you can see the same schedule information has been set.

Note: Delete

Click Delete button to delete previously saved schedule information.

6 Change mode



If you want to change the control information like temperature, wind strength, lock and etc. while keeping the hour in the previously setting schedule information, you can use Change schedule mode function. Depending on your selection on this function, the operation in the weekly schedule operation window varies.

- Edit schedule hour : Checked and selected as default. When dragging with mouse, select/delete operation is made.
- Change mode : When Change mode is checked, the hour isn't selected even if you drag with mouse and operation information isn't deleted.

In case of editing schedule hour, when you click, the area turns grey and becomes selected. If you want to change the schedule temperature, mode and etc. previously edited in the control setting, select Change mode and click the hour area in weekly schedule and click the control setting button.

7 Operation lock schedule

A function that limits(Lock setting) the operation/stop function of the wire remote controller according to weekly schedule(day setting/hour setting) and controls operation on/off at certain time(operation setting).

Button	Description
Day setting	Sets the day weekly(Monday ~ Sunday).
Hour setting	Sets control starting time.
Lock setting	Sets lock or deactivate the wire remote controller.
Operation setting	Sets operation start or operation stop of the indoor unit.

Note: For example, lock schedule is as follows.

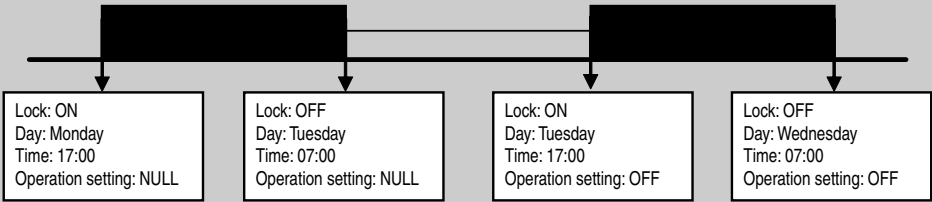
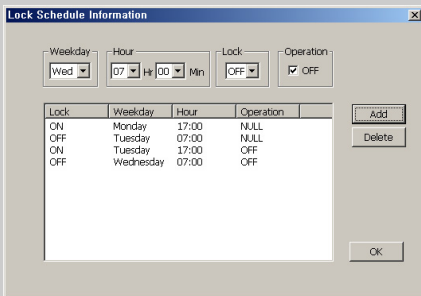

8 Save, OK and Cancel

Saves and confirms current setting status. Click cancel and current input isn't saved.

Description on weekly schedule setting screen

In this screen, you can check weekly schedule status set within recent 2 months basically. You can set/deactivate the desired schedule in certain week from all weekly schedules currently saved.

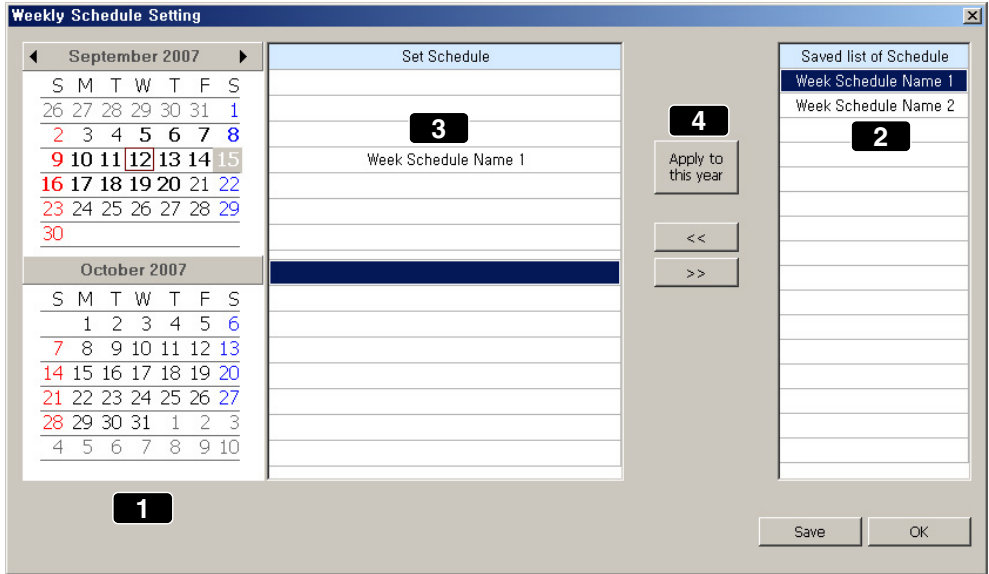

Let's find out about above menu.

1 Schedule calendar

The initial screen is the calendar of current month and click left and right button image on top and you can move to past or future date you want. The schedule status changed according to this is shown.

2 Weekly schedule list

All of the currently created and saved weekly schedule are shown in a list.

3 Weekly setting schedule

This shows the setting status of weekly schedule list. For example, in the setting screen of above weekly schedule, the weekly schedule of "Week Schedule Name 1" is set on 3th week of September. If you want to set the schedule, click this schedule and press << button in (4) and if you want to cancel this schedule, click >> cancel button.

4 Set/Cancel setting schedule button

This can be used when you want to set the weekly schedule on the desired week. Firstly, select the desired schedule from (2) Weekly schedule list and click with mouse and select the desired week from (3) Weekly setting schedule list and click << button and Save button. Now, you can check the setting schedule appears in the desired period. When canceling the schedule, click >> button.

Caution: Schedule setting



When setting the schedule, 1~3 minute schedule setting is maintained for time the actual schedule is set.

For example, when you set the schedule for the unit to be turned off at 5:00, the operation is turned off from 5:00 to 5:03. Therefore even when you try to operate the unit with the wired remote controller, it may be turned off.

Description on Special schedule edit screen

The screenshot shows the 'Edit Special Schedule' interface. It is divided into several sections:

- 1**: Schedule Group list showing 'Control[0]'.
- 2**: A/C Mode settings including MODE (COOL, HEAT, DRY, FAN), FAN (LOW, MED, HIGH, AUTO), SWING (ON, OFF), LOCK (ON, OFF), and Temp. Setting (18).
- 3**: Schedule Information section with 'Schedule Name' set to 'Holiday schedule' and a 'Schedule List' button.
- 4**: The main schedule grid showing a time range from 09:00 to 13:00. It includes icons for snow (18) and sun (18) at 11:00 and 12:00 respectively.
- 5**: Action buttons: Delete, Copy, and Paste.
- 6**: Radio buttons for 'Edit Schedule' (selected) and 'Change Mode'.
- 7**: Operation Lock Schedule section with 'Lock Information Setting'.
- 8**: Final action buttons: Save, OK, and Cancel.

Let's find out about the description on above screen menu.

Caution: Delete

Basically, editing and function is the same as that of weekly schedule edit. Please note that if you click Delete button, previously saved schedule information is deleted.

1 Selecting schedule group and indoor unit

Schedule function can be set in such way that the same or unique operation can be made for each schedule group. The group name and group number appears in the list for currently setting groups. Among them, you can select the schedule group using mouse. If you want to edit(add/delete) the schedule group, please refer to the group edit menu in the system setting.

2 Control setting window

You can set the operation mode, wind strength, wind direction, lock and desired temperature. for operation during the scheduled operation of the air conditioner. The function of the control setting button is the same as the function of air conditioner control setting button.

In addition, the schedule control setting of the schedule group can be controlled for each hour.

3 Special operation schedule information

In order to set daily operation schedule for the selected schedule group, drag the mouse and select the desired hour. If you set many hours, drag and draw the desired hour vertically. This can be set by 10 minutes and the hour can be set by moving the scroll bar up and down. In the area corresponding to the setting hour, the bitmap image that shows the selected modes by (2) control setting appears. If you made wrong setting or want to modify it, drag the same hour you want to delete and then, it is deleted.

4 Schedule list

This can be used if you want to create/delete or select new weekly schedule.

5 Delete, copy and paste

If you want to delete the currently displayed schedule, you can use Delete button.

If you want to set the schedule by making the schedule hour or control setting information and etc., you don't have to repeatedly edit them and you can use Copy and Paste function. Firstly, select the schedule group and check the schedule edit status and then, click Copy button. Then, select the schedule group you want to apply and click Paste button. Thereafter, you can see the same schedule information has been set.

Note: Delete

When executing Delete, previously saved schedule information is deleted.

6 Change mode

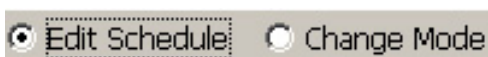

If you want to change the control information like temperature, wind strength, lock and etc. while maintaining the time among previously setting schedule information, you can use the schedule mode change function. Depending on your selection of this function, the operation in weekly schedule operation window varies.

- Edit schedule hour : Checked and selected as a default value. Drag mouse for select/delete operation.
- Change mode : When Change mode is checked, the hour isn't selected even if you drag the mouse and the operation information isn't deleted.

In case of editing schedule hour, when clicking mouse, the area turns grey and becomes selected. If you want to change temperature, mode and etc. in the edited schedule of previous control setting, select Change mode, click the desired hour area in weekly schedule and then, click the control setting button.

7 Operation lock schedule

A function that limits the operation/stop function of wire remote controller depending on the schedule and control the operation On/Off(operation setting) at certain time.

Button	Description
Time setting	Sets control start time.
Lock setting	Sets or cancels wire remote controller lock.
Operation setting	Sets start or stop the operation of the indoor unit.

Note: For example, Lock schedule is as follows;

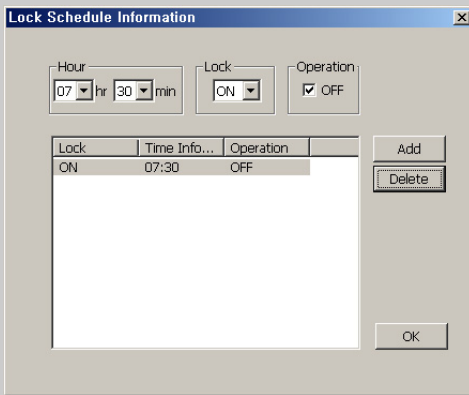

8 Save, OK and Cancel

Saves and confirm current setting status. Click Cancel and current status isn't saved.

Special schedule setting screen setting

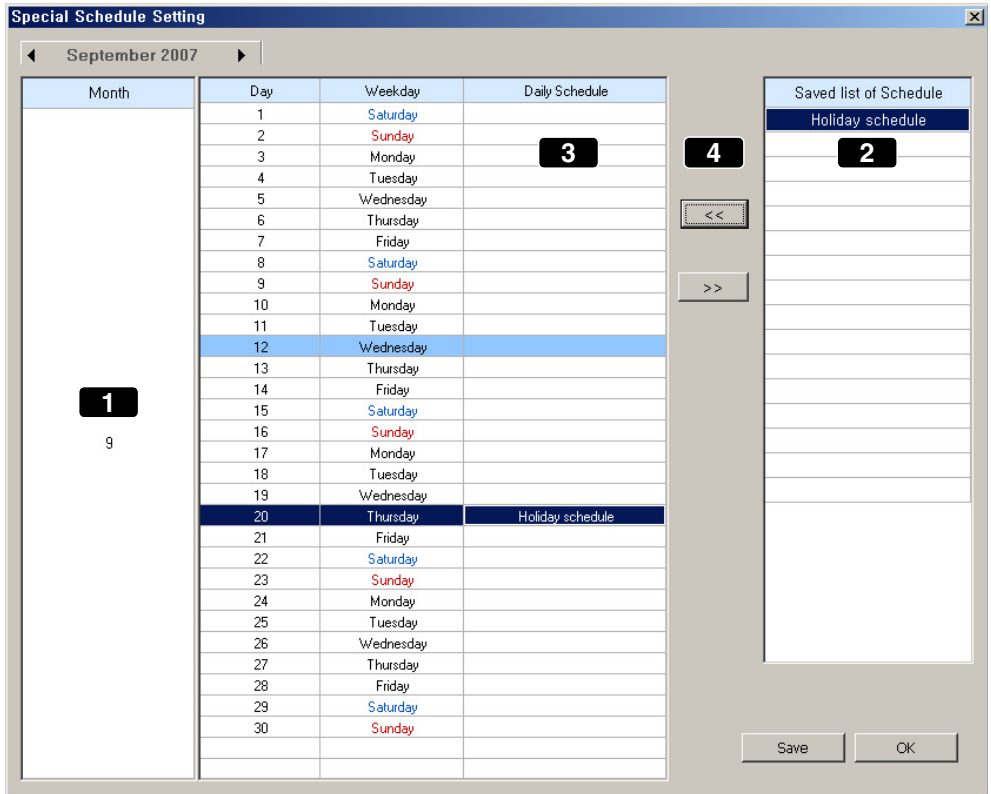

Let's find out about above screen menu.

1 Special schedule calendar

At first, the calendar of current date appears as a default and clicking right/left button image on the top of the calendar enables you to move past or future desired date. Thereby, the daily schedule status set in (3) varies.

2 Special schedule list

All of the currently created and saved special schedule is shown in the list. If you want to add the schedule other than this, you can additionally use the schedule list in the special schedule edit.

3 Special daily schedule

Shows the setting status of special schedule list.

4 Special schedule setting button

If you want to set the special schedule on the desired date, you can use << button. Firstly, select the desired schedule in the special schedule list in (2) with mouse, and select the desired date from the special setting schedule list in (3) and then click << button.

You can use >> button when you want to cancel the schedule set on specific date. Select the date you want to cancel from the special setting schedule list with mouse and click >> button. You can see the setting schedule is cancelled.

Until now, the menu of the schedule function has been described. Now, we provides you with the scenario practically using the schedule function. User may follow this order and use the schedule function easily and conveniently. We introduce virtual scenario on using weekly schedule function, using special schedule function, using Suspend entire schedule function and using Send current schedule function.

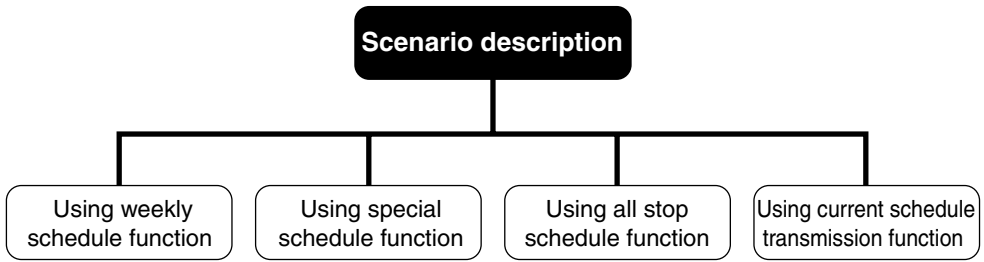

User will use general weekly schedule function as below order.

Using weekly schedule function

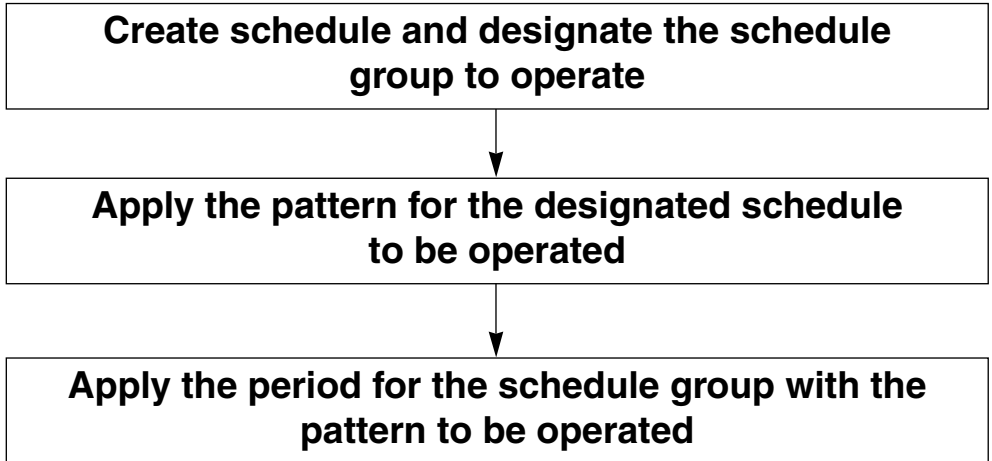

We will introduce the virtual scenario that user takes this process. Follow this scenario and you can use the schedule function.

Satisfying the schedule group to operate by creating the schedule

1. In AC Manager main screen, click system setting button → Edit schedule group, and then following screen appears.

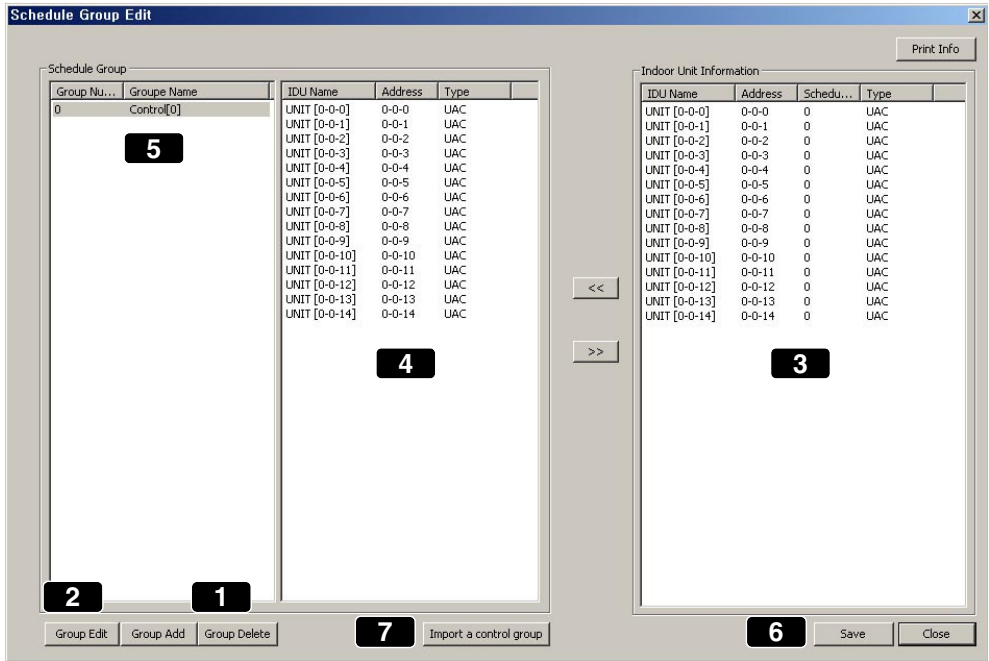

1. Using (1) Add group button, Add group. Click Add group button and the, the group name automatically appears in (5).
2. After selecting the group from the control group, using (2) Edit group, you can change the name. In this way, you can add and delete the desired group.
3. Select the desired indoor unit of the indoor unit information in (3) and click << button and then they move to (4). They can be set as an indoor device in the selected group. If you want to exclude an indoor unit in this group, while selecting the indoor unit, you can click >> button.
4. Click the indoor unit name, address and control group button to select the indoor unit for each item in ascending order. Move the indoor unit using >> and << button, and the selected/moved indoor unit will have the group number as (5) in the control group of the indoor unit information.
5. Use (6) Save button to save the information set.

Applying the pattern for the schedule group to operate

1. Click Edit weekly schedule button in the schedule main screen and below window appears.

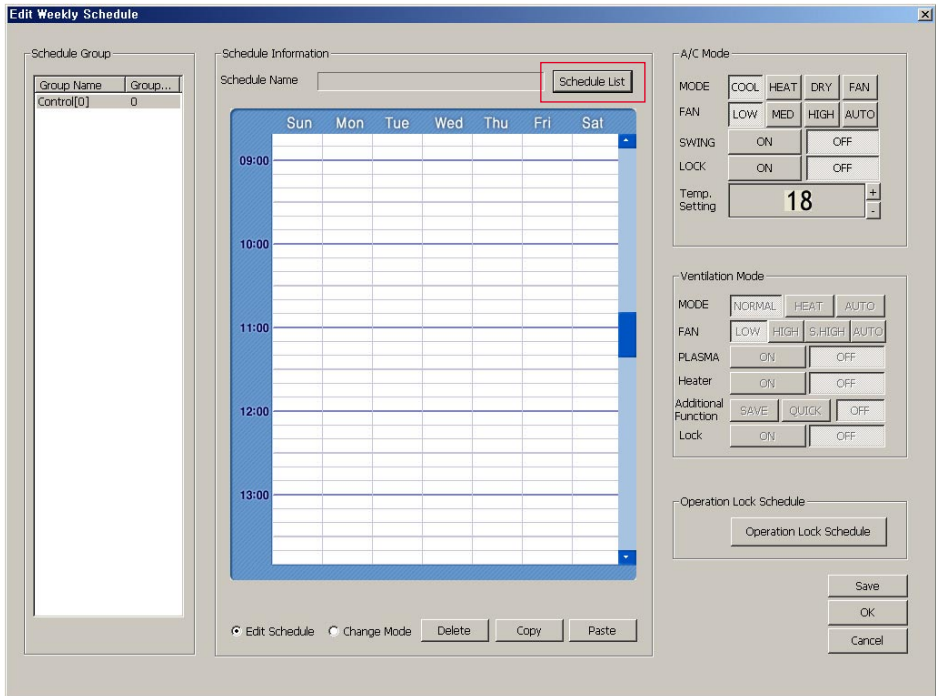

Click the bordered schedule list button on the top.

2. The window that the schedule information can be added appears.

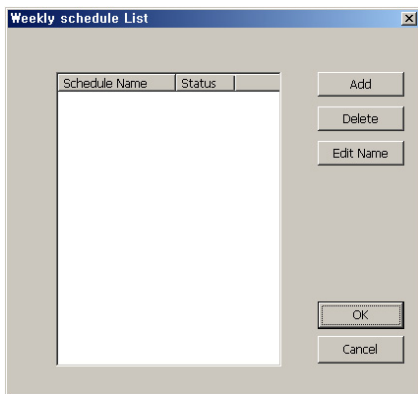

Click Add button to input and save weekly schedule name. This name can be edited and deleted later. Enter the name and click OK button.

The schedule name just entered appears in weekly operation schedule window. Now, you are ready to start the schedule setting.

3. The schedule name appears as below. For example, "Drama club" is set.

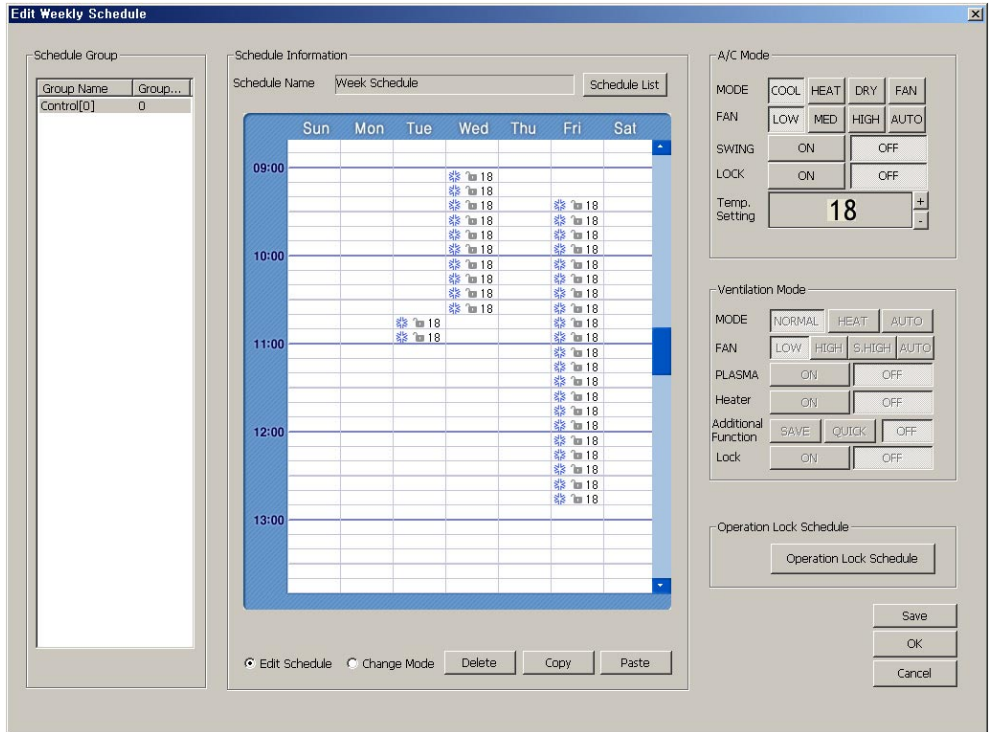

Drag the hour on the desired date and then, set the desired mode, wind strength, wind direction, temperature, all lock and etc. in air conditioner. If you get the mouse off, the settings appear in the schedule window.

4. If you want to change the items in previously selected area, check "Change mode" instead of "Edit schedule time. In Change mode, change the operation information.

Caution: Warning window



When you set the schedule at first, select Edit schedule time and when changing only mode form the previously selected are, select Change mode. If you want to change previous area while Edit schedule time is checked, below window appears and you cannot edit it. Figure. Overlapped with already edited schedule time. Please edit again. OK))

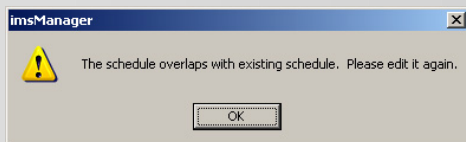

After setting, click Save button.

5. Click Copy button, and below window appears.

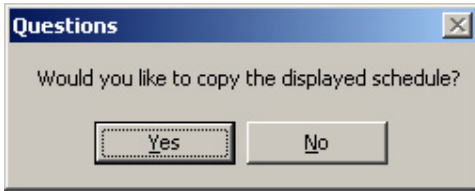

If you click Yes, current Week Schedule(0) is copied and may be applied to another area.

6. After selecting the group name that you want to paste this copied schedule from the schedule group and select Paste button, the schedule of the schedule[0] will be copied here.

After setting, click Save and click OK to go back to the schedule main screen.

Applying the operation period of the schedule group to which the pattern was applied

1. Creates the schedule group and sets the air conditioner operation schedule to apply to this group and applies the period to operate. In schedule main screen, click weekly schedule setting button, and below window appears.

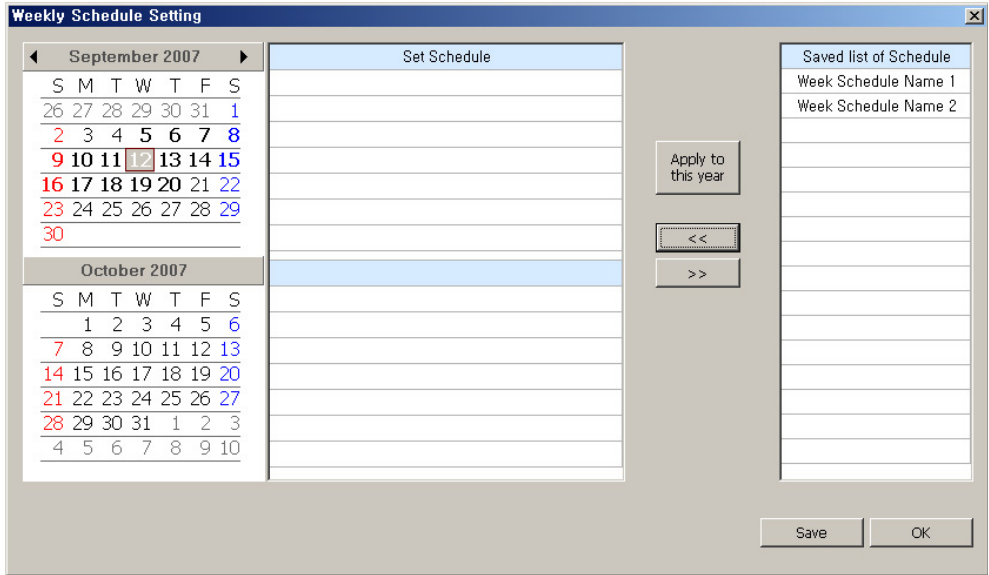

Weekly schedule setting/setting schedule/Apply for a year/Saved schedule list/Drama club/Save/OK

Click the desired group name from the saved schedule list. If you apply this for a year, click Apply for a year button. If you want specific period, click the desired week on the left calendar. If you click the week, the week turns blue. At this time, click << button.

2. Click << button, and the schedule name is reflected and shown as below.

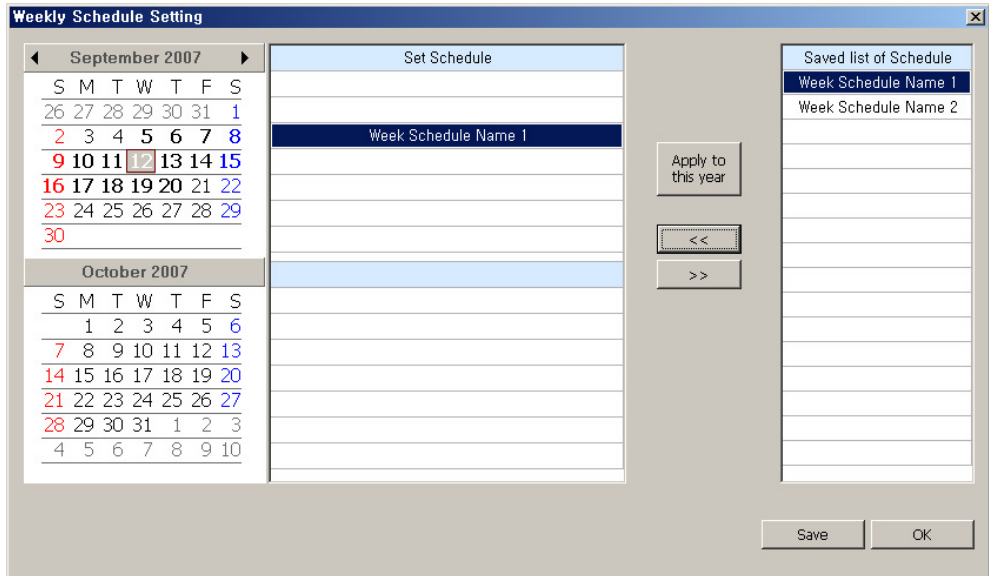

Now, click Save button. If you want to delete the schedule, select the schedule name and click >> button.

3. Click Save button and the confirmation message on the saving appears.

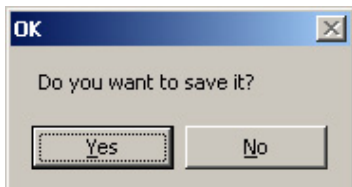

Click Yes, and below confirmation message appears.

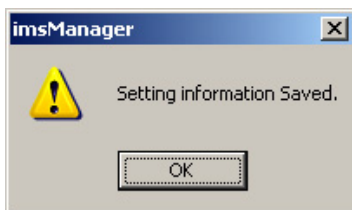

Click OK.

4. Now, you can see the schedule is reflected as bordered part below in the schedule main screen.

The screenshot displays the 'ACManager - SCHEDULE' application window. The interface includes a menu bar (File, Menu, Information, Language) and a toolbar with various function buttons. The main workspace is organized into columns for 'Month', 'Day', 'Weekday', 'Daily Schedule', and 'Weekly Schedule'. A calendar for September 2007 is positioned on the right side, with the 12th of the month highlighted. Below the calendar, there are several control buttons: 'Edit Weekly Schedule', 'Weekly Schedule Setting', 'Edit Special Schedule', 'Special Schedule Setting', 'All Stop Setting', and 'Transfer Current Schedule'. The bottom status bar indicates 'Peak Control Stopped' and shows the current time as 9:33 on 9/12/2007.

Using special schedule function

User will use the special schedule function in the order as below.

Create the schedule and specify the schedule group to operate



Apply the pattern for the specified schedule to be operated



Apply the schedule group with the pattern applied to operate

We introduce the virtual scenario that user takes these steps as an example. Following this scenario, you can easily use the schedule function.

Create the schedule and specify the schedule group to operate

1. In AC Manager main screen, click system setting button
Edit schedule group, and below screen appears.

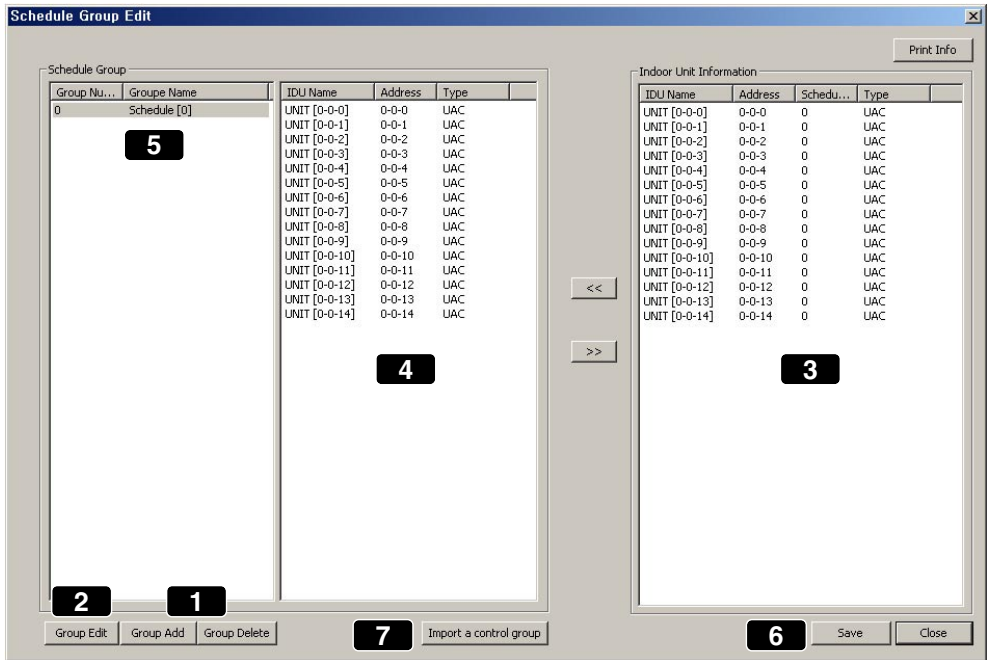

Using (1) Add group button, add group. Click Add group button and the group name automatically appears in (5).

2. Select the group from the control group and use (2) Edit group to change the group name. In this way, you can add and delete the desired group.
3. Select the desired indoor unit of the indoor unit information in (3) and click << button and they move to (4). They can be set as the indoor units in the selected group. If you want to exclude certain indoor unit, with the device selected, click >> button.
4. Click the indoor unit name, address and control group button and the indoor units are sorted for each item in ascending order. Using >> and << button to move the indoor unit, the group number of the selected and moved indoor unit appears in the control group of the indoor unit information as (5).
5. Use (6) Save button to save the setting information.

Applying the pattern for the specified group to be operated

1. In schedule main screen, click Edit special schedule button and below screen appears.

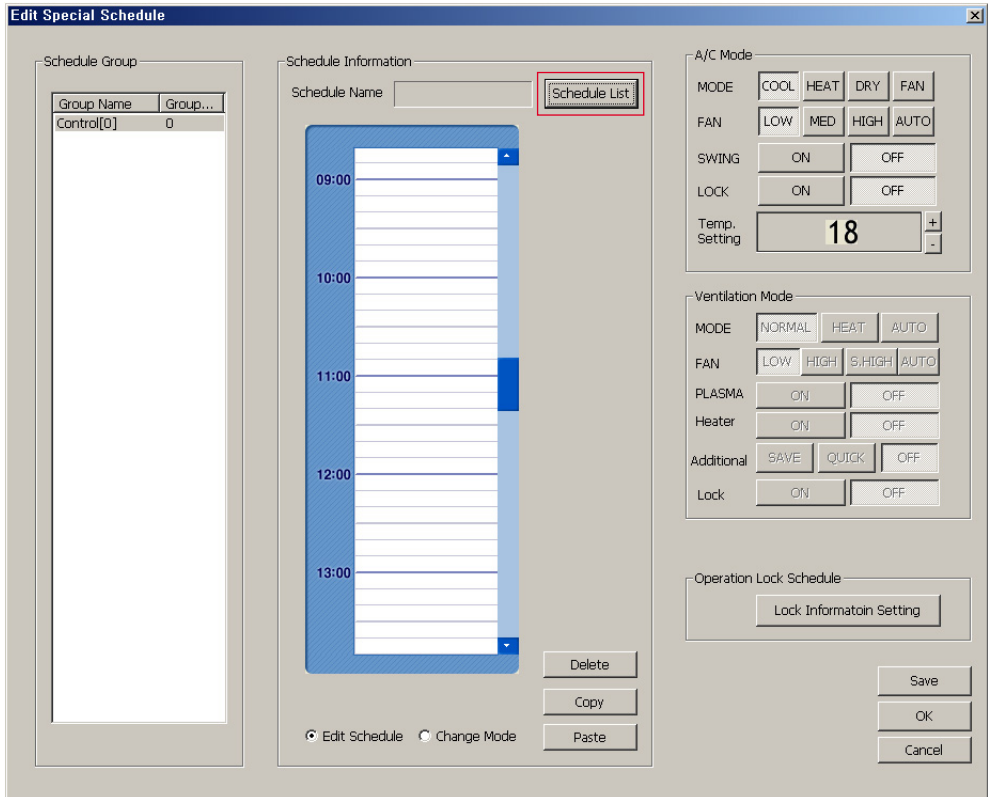

Click the bordered schedule list button on the top.

2. The window that the schedule information can be added appears.

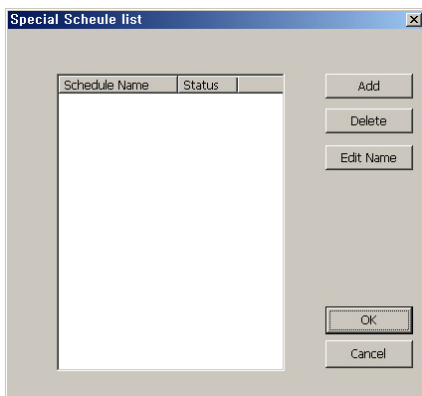

Click Add button and enter and save weekly schedule name. This name can be edited and deleted later. Enter the name and click OK button. In the special operation schedule window, the schedule name just entered will be reflected. Now, it is ready for the schedule setting to begin.

3. Schedule name appears as below. For example, "Holiday" is set.

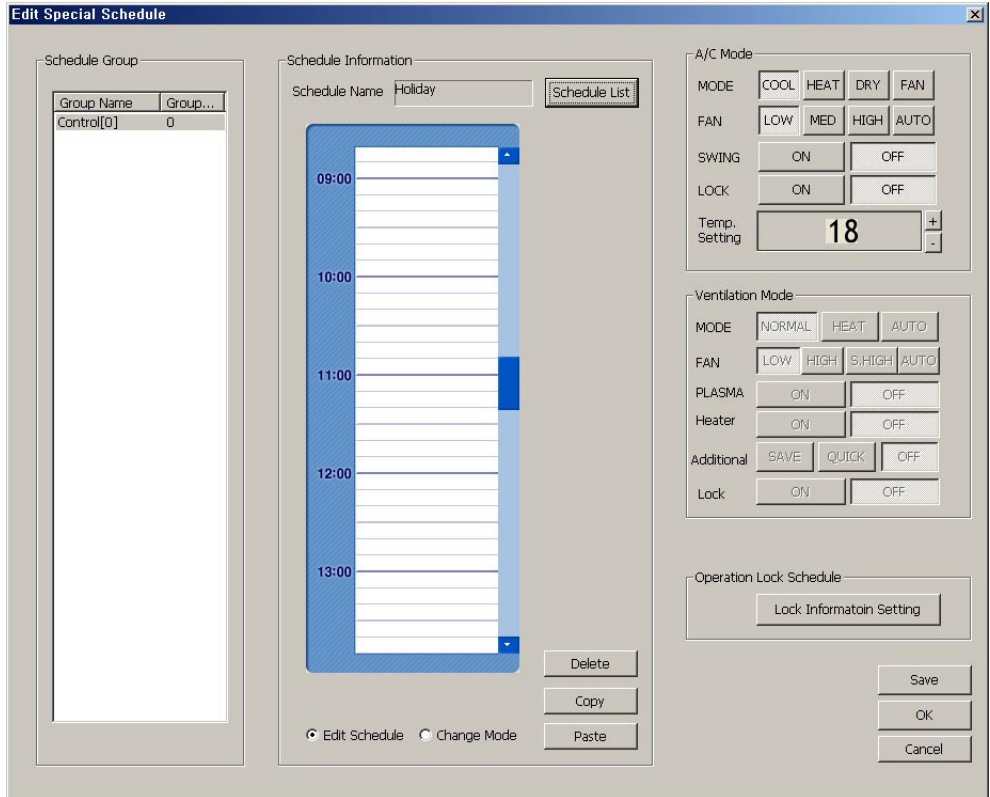

Drag time on the desired date and set the desired mode, wind strength, wind direction, temperature, all lock and etc. from air conditioner. Get the mouse off and then the setting appears in the schedule window.

4. If you want to change the information of the previously selected area, check "Change mode" instead of "Edit schedule time". In Change mode, change the operation information.

Note:

When setting the schedule at first, select Edit schedule time and select Change mode when you only change mode in the previously selected area. If you want to change the mode of previous area with Edit schedule time checked, below window appears and you cannot edit.

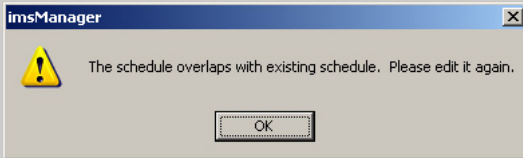

After setting, click Save button and below window appears.

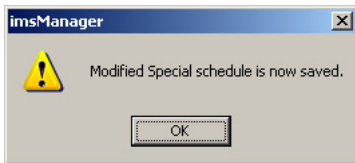

Click OK button.

5. Click Copy button and below window appears.

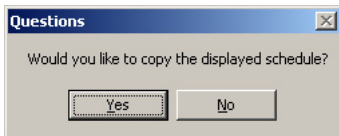

If you click Yes, current Holiday schedule(0) is copied and applied to another schedule.

6. Select the group name that you want to paste this copied schedule from the schedule group and select Paste button and then, the schedule of Schedule[0] will be copied here.

After setting, click OK button to go back to main screen.

Applying the operation period of the schedule group with the pattern applied

1. Creates the special schedule group and sets the air conditioner operation schedule to apply this group and applies the operation period. In the schedule main screen, click the special schedule setting button and then below window appears.

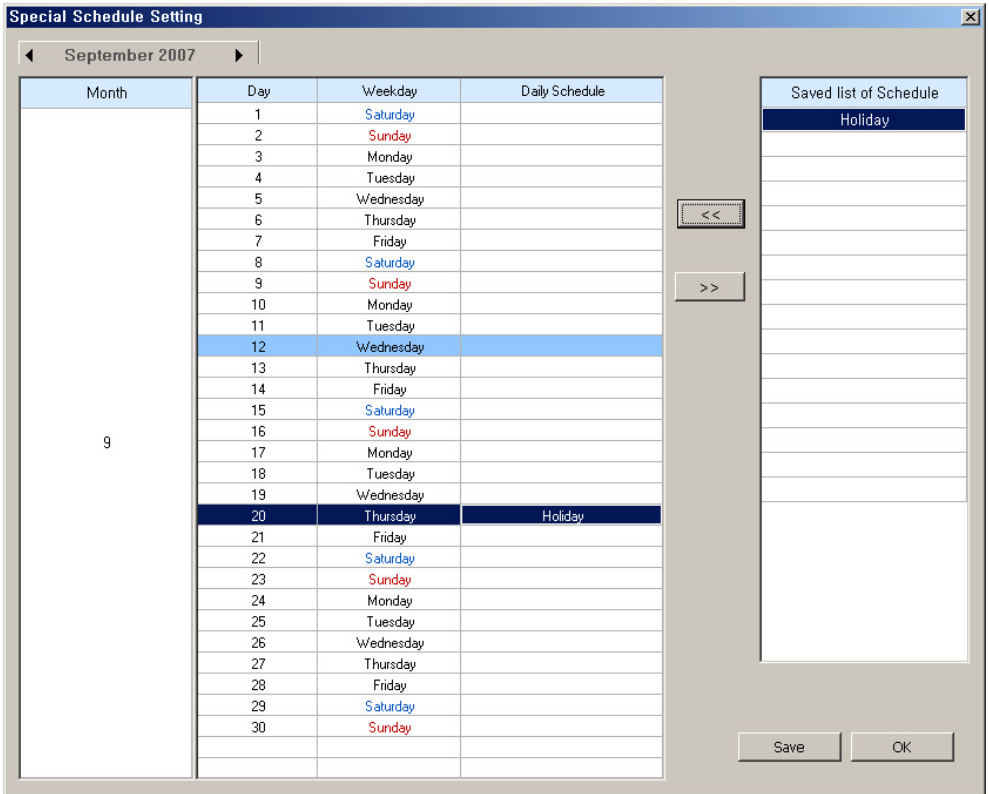

Click the group name from the saved schedule list. Click the date you want to set the schedule. Click the date and click << button. Click << button and the schedule list name is reflected to the schedule period set as above screen. After setting, click Save button. If you want to delete the schedule, select the schedule name and click >> button.

2. Click Save button and below Confirmation pop-up appears.

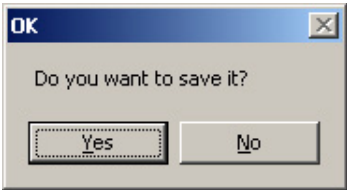

Click Yes and below pop up appears.

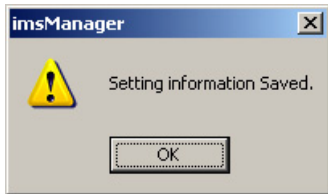

Click OK to exit this window.

3. Now you can see the schedule is reflected in the schedule main screen as below.

The screenshot shows the 'ACManager - SCHEDULE' interface. At the top, there is a menu bar with 'File(E)', 'Menu', 'Information(H)', and 'Language'. Below the menu is a toolbar with icons for Home, Control, Peak, Schedule, History, PPD, Comfort, Interlock, Monitor, and Setting. The main area is divided into several sections:

- Month:** A vertical column on the left showing the months '8' and '9'.
- Day:** A column listing days from 26 to 29 for month 8, and 1 to 29 for month 9.
- Weekday:** A column listing the corresponding weekdays (e.g., Sunday, Monday, Tuesday, etc.).
- Daily Schedule:** A column for daily settings, with 'Holiday' listed for Thursday, 20th of month 9.
- Weekly Schedule:** A large area for weekly settings, currently displaying 'Week Schedule Name 1'.
- Calendar:** A small calendar for 'September 2007' on the right, with dates 1 through 30. The 11th is highlighted.
- Buttons:** A vertical stack of buttons on the right: 'Edit Weekly Schedule', 'Weekly Schedule Setting', 'Edit Special Schedule', 'Special Schedule Setting', 'All Stop Setting', and 'Transfer Current Schedule'.
- Status Bar:** At the bottom, it shows 'Connection to ACP No.0 [OK : 0]', system icons, the time '12 : 59', the date '9 / 12 / 2007', and a 'NUM' indicator.

Above screen is an example that "Holiday" has been added to the special schedule group and "Week Schedule Name 1" has been added to weekly schedule group. In this way, user can manage and adjust various schedule he wants.

Using the function to suspend entire schedule

Click Suspend entire schedule button and below window appears.



As a default, this function is checked as Deactivate. If you check Activate, you can stop the air conditioner operation for certain period. This is a convenient function when controlling the air conditioner at a time. After setting, click OK button.

Using the function to send the current schedule

1. Click Send current schedule button and below window appears.

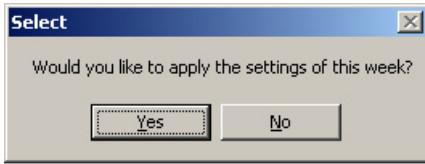

Click Yes button and currently set schedule is applied.

2. As in the box in the bottom of below main screen, it is indicated that the schedule is being sent and applied.

Now, we have looked over managing and adjusting weekly schedule and special schedule using the schedule menu function,

History management

In the history management menu, the control and error status of air conditioner/ventilation/other system is record and shown. You can see the status like date, time, address of air conditioner, operation mode, operation status, error code and etc. at a glance. Basically, the history on all the device status of current system is updated and shown.

The screenshot shows the 'ACManager - HISTORY' window. The main area displays a table of history data. Below the table are three panels: 'History Period' (2), 'Select History Unit' (3), and 'History Data' (4). A 'Usage Info.' panel (5) is on the right. The status bar at the bottom shows 'A/C Operation Control Sent, [OFF]' and the date '9 / 12 / 2007'.

Date	Time	Name	Mode	Fan	Swing	Lock	Temp.	Oper...	Error	Owner
2007/09/12	08:15	Not Defined Name	COOL	LLOW	OFF	OFF	18	ON	0	NONE
2007/09/12	08:22	Not Defined Name	COOL	HIGH	OFF	OFF	27	ON	0	NONE
2007/09/12	08:32	Not Defined Name	COOL	HIGH	OFF	OFF	24	ON	0	NONE
2007/09/12	08:37	UNIT [0-0-0]	COOL	HIGH	OFF	OFF	22	ON	0	USER
2007/09/12	08:37	UNIT [0-0-1]	COOL	HIGH	OFF	OFF	27	ON	0	USER
2007/09/12	08:37	UNIT [0-0-2]	COOL	HIGH	OFF	OFF	18	ON	0	USER
2007/09/12	08:37	UNIT [0-0-3]	COOL	HIGH	OFF	OFF	24	ON	0	USER
2007/09/12	08:37	UNIT [0-0-4]	COOL	HIGH	OFF	OFF	21	ON	0	USER
2007/09/12	08:37	UNIT [0-0-5]	COOL	HIGH	OFF	OFF	18	ON	0	USER
2007/09/12	08:37	UNIT [0-0-6]	COOL	HIGH	OFF	OFF	18	ON	0	USER
2007/09/12	08:37	UNIT [0-0-7]	COOL	HIGH	OFF	OFF	18	ON	0	USER
2007/09/12	08:40	UNIT [0-0-4]	COOL	HIGH	OFF	OFF	21	OFF	0	USER
2007/09/12	08:40	UNIT [0-0-5]	COOL	HIGH	OFF	OFF	18	OFF	0	USER
2007/09/12	08:40	UNIT [0-0-6]	COOL	HIGH	OFF	OFF	18	OFF	0	USER
2007/09/12	08:40	UNIT [0-0-7]	COOL	HIGH	OFF	OFF	18	OFF	0	USER
2007/09/12	09:52	UNIT [0-0-0]	COOL	HIGH	OFF	OFF	22	OFF	0	USER
2007/09/12	09:52	UNIT [0-0-1]	COOL	HIGH	OFF	OFF	27	OFF	0	USER
2007/09/12	09:52	UNIT [0-0-2]	COOL	HIGH	OFF	OFF	18	OFF	0	USER
2007/09/12	09:52	UNIT [0-0-3]	COOL	HIGH	OFF	OFF	24	OFF	0	USER

- (1) History data display
- (2) History period selection
- (3) History device selection
- (4) History data selection
- (5) Inquiry, update

On above menu, let's find out each item.

1 History data display

A window displaying history data. The history of the devices connected to air conditioner, ventilation and external input port can be displayed separately. By selecting AC, VENT and ETC on the left top of the display window, the device history is displayed.

- AC : Data on air conditioner, indicating the information on date, time, address, mode, wind strength, lock, temperature, operation, error and controller.
- VENT : Data on ventilation device, indicating the information on date, time, address, mode, wind strength, filter, plasma, heater, additional function, lock operation, error and controller.
- ETC : Data on the external input port and devices connected to fire alarm and etc., indicating the information on date, time, address, status and controller.

2 History period selection

Selection on present or past period, possibly checking the data on the desired history period.

As a default, Present period is selected.

- Present : If Present is selected, the history data is updated and displayed in real time whenever the system status of air conditioner changes.
- Period selection : Check Period selection and click the button to select a specific date or period in the past by the calendar and click Update button and the history of the selected period is shown.

3 History device selection

Basically, this function is used to save and show the history data of all devices, however, depending on user's selection, this can be used to show only the history of specific device.

- All devices : The data on all devices of the system when selecting all devices is shown.
- Specific devices : The data on specific device is shown. Let's find out an example of the scenarios of the specific device selection.

Selecting specific device

1. Click Select button and below Select history device window appears.

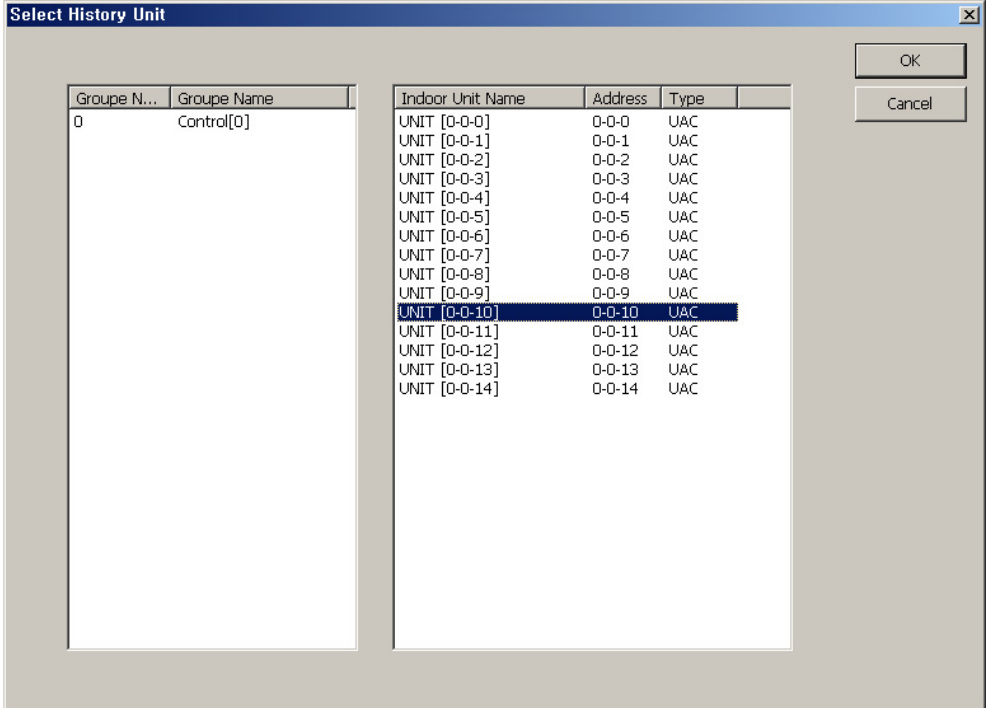

Select the desired device on above screen and click OK button. The settings are determined and the window is closed.

2. Click Update button in main screen. Only the history data of the selected device is displayed as below.

The screenshot shows the 'ACManager - HISTORY' window. The main area contains a table with the following data:

Date	Time	Name	Mode	Fan	Swing	Lock	Temp.	Oper...	Error	Owner
2007/09/12	08:37	UNIT [0-0-2]	COOL	HIGH	OFF	OFF	18	ON	0	USER
2007/09/12	09:52	UNIT [0-0-2]	COOL	HIGH	OFF	OFF	18	OFF	0	USER

Below the table are three control panels:

- History Period:** Radio buttons for 'Present' and 'Select the period'. The 'Select the period' panel has two date dropdowns (both set to 2007-09-12) and two time dropdowns (both set to 00 Hour and 24 Hour).
- Select History Unit:** Radio buttons for 'All devices' and 'Select a device'. The 'Select a device' panel has a dropdown menu showing 'UNIT [0-0-2]' and a 'Select' button.
- History Data:** Checkboxes for 'Status Information' and 'Error Information', both of which are checked.

On the right side of the control panels are three buttons: 'Usage Info.', 'Print', and 'Update'. The 'Update' button is highlighted.

The status bar at the bottom shows 'A/c Operation Control Sent, [OFF]', system icons, the time '9:55', the date '9/12/2007', and a 'NUM' indicator.

4 Select history data

Shows all kinds of data on the air conditioner/ventilation/external input device of the system and these are divided into "Status information data" and "Error data". If you want to check error history, don't check the status information, but check the error information. After checking, you should click the update button on main screen to allow the information on the current status to appear on the screen.

5 Inquiry, update

1. Click using time inquiry button and below screen appears.

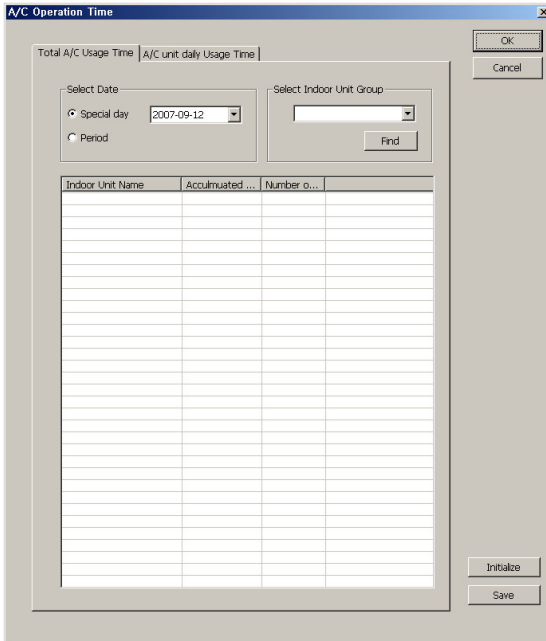

You can inquire total using time of air conditioner and using time of specific air conditioner per date respectively. Click Initialize operation time button, and you can initialize previous using time and accumulate the period again.

2. Click Print button on main screen and below window appears.

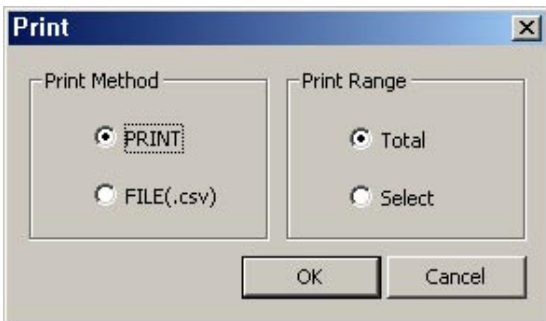

If you want to print out, you can print out entire area or the selected area in many ways. Click OK button to print out the data.

3. Click Update button on main screen.

Current setting items appears on main screen. User can see all settings only when clicking Update button.

Accumulated power

Accumulated power is a function that indicates the used power for each indoor unit or maintains this efficiently when the outdoor unit is commonly used, such as studio apartment, condo and etc. Main functions are as follows;

- Using ACP and AC Manager, distributing consumed power to each room
- Saving and printing function of distributed power data
- Remote inspection function without necessity of separate inspection program

Below is the main screen of accumulated power menu.

The screenshot shows the 'ACManager - Integration PowerConsumption' software interface. The main window displays a table of power consumption data for various indoor units. The table has four columns: Group..., Group Name, Indoor Unit Name, and Indoor U... (likely Indoor Unit ID). The data shows 15 units, each with a current power of 0 and an accumulated power of 0.0 kWh. The interface also includes a 'Total Usage' section showing 0.0 kWh, a 'Group Usage' section showing 0.0 kWh, and a 'Period' section with 'Current' selected and a date range of 2007-09-12 to 2007-09-12. There are 'Print' and 'Save as file' buttons at the bottom right. The status bar at the bottom indicates 'A/C Operation Control Sent, [OFF]' and the date/time '9:58 9/12/2007'.

Group...	Group Name	Indoor Unit Name	Indoor U...	Current Power(...)	Accumulated Po...
0	Control(0)	UNIT [0-0-0]	0	0	0.0
		UNIT [0-0-1]	1	0	0.0
		UNIT [0-0-2]	2	0	0.0
		UNIT [0-0-3]	3	0	0.0
		UNIT [0-0-4]	4	0	0.0
		UNIT [0-0-5]	5	0	0.0
		UNIT [0-0-6]	6	0	0.0
		UNIT [0-0-7]	7	0	0.0
		UNIT [0-0-8]	8	0	0.0
		UNIT [0-0-9]	9	0	0.0
		UNIT [0-0-10]	10	0	0.0
		UNIT [0-0-11]	11	0	0.0
		UNIT [0-0-12]	12	0	0.0
		UNIT [0-0-13]	13	0	0.0
		UNIT [0-0-14]	14	0	0.0

Let's find out each information on above screen.

1 Power information

Shows the current using power for each indoor unit. Displays the name, address, current consumed power and accumulated consumed power of the indoor unit in the group for each indoor unit group.

2 Using Power

Shows total using power currently being used. You can check total using power and using power for the group.

3 Period

You can check the power amount based on current level and certain period.

4 Print

You can print out the current details or save as file.

Pleasant control

AC Manager can automatically control the indoor unit and ventilator connected through the network based on current temperature and setting temperature. Therefore, this can provide user with optimum and pleasant cooling function.

In pleasant control menu, following 2 functions are provided as these auto control functions.

Auto-Change Over operation

Auto-change over operation function is a function that maintains the optimum indoor temperature not manually, but by auto-change over of air conditioner operation mode (cooling and heating). For example, if in heating operation, the indoor temperature rapidly increases due to the increase of the number of people, AC Manager auto-changes over the operation of air conditioner indoor unit from heating to cooling in order to fit into changing indoor temperature and maintain the indoor temperature within certain range.

Use inputs the temperature difference from the standard temperature for the auto-change over operation function. AC Manager will be operated based on the input as follows;

- If the indoor temperature increases more than the difference based on the standard temperature, this cools the indoor temperature by cooling operation.
- If the indoor temperature decreases below the difference based on the standard temperature, this warms the indoor temperature by heating operation.

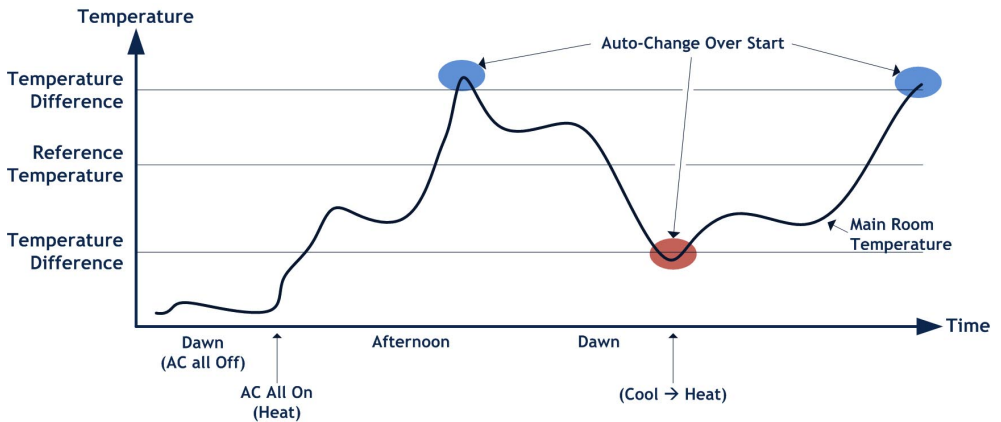

Temperature limit operation

Temperature limit operation is a function that keeps the temperature of the place with the air conditioner installed within certain range(+4°C ~ -4°C).

In order to execute the temperature limit operation function, user will input maximum and minimum temperature as follows and AC Manager operates based on the input as follows;

- If the indoor temperature increases higher than the setting temperature, the cooling function of the air conditioner is operated and decreases the temperature. lower than the setting temperature. The available setting temperature ranges within 35°C~45°C.
- If the indoor temperature. decreases lower than the setting temperature, the heating function of the air conditioner is operated and increases the temperature higher than the setting temperature. The available setting temperature ranges within 1°C~12°C.

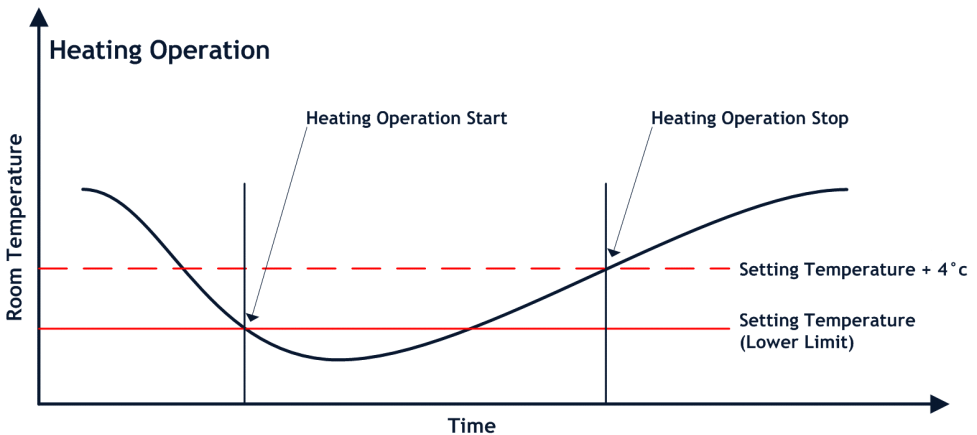
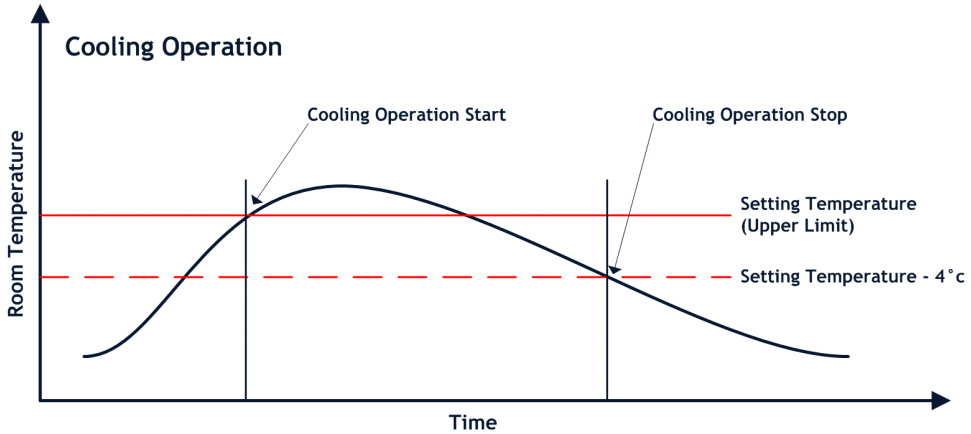

In this chapter, using the pleasant control menu, we will explain how to operate AC Manager function in the order.

Below is the default screen of the pleasant control menu.

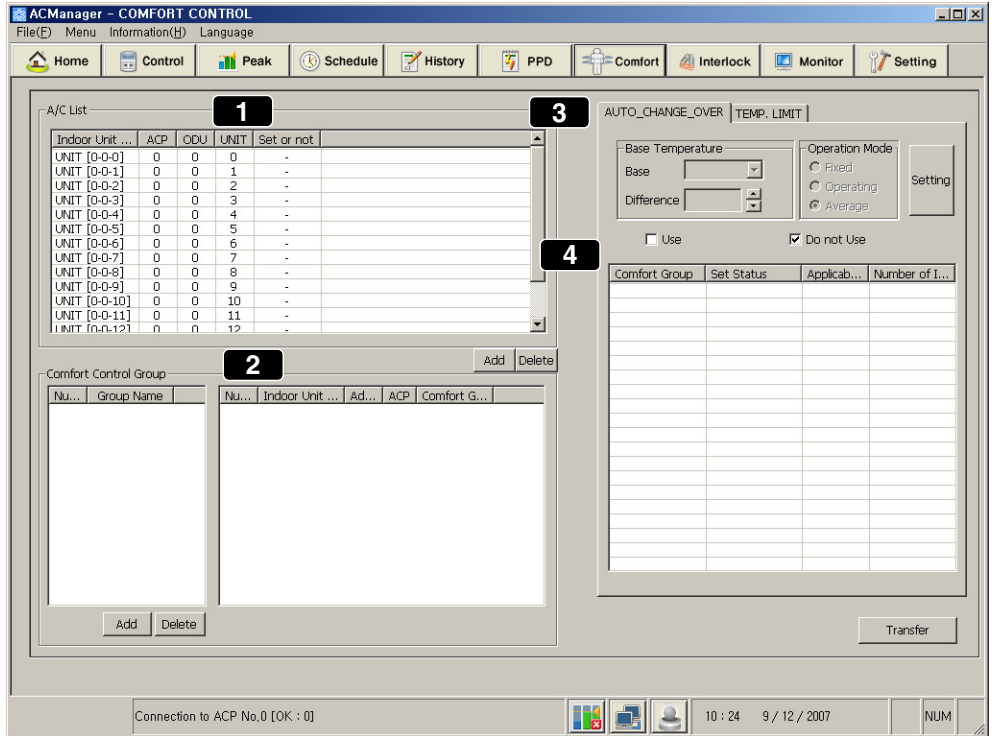

The description on each menu on above screen is as follows.

1 Air conditioner list

Shows the name of the operating indoor unit and whether the pleasant control function is set or not.

2 Comfort control group

Can add, edit and delete the control group. If you edit and delete the group, this will be automatically reflected to (4).

1. If you want to edit the group in comfort control group area, put mouse on the group name as shown above and click its right button.
2. The window that the pleasant group name can be edited appears.



Enter the group name in this window and click OK button to edit the name.

3 Auto-change over operation, temperature limit operation Tab

Auto-change over operation tab is as follows;

- Standard temperature : Current standard temperature. The measurement method of the indoor temperature is as below table.
- Temperature difference : The temperature width that can change current temperature.

Item	Description
Average	The indoor unit being operated in the group operates auto-change over operation function at the average temp of the detected temperature.
Operation	Auto-change over operation function is operated based on the fastest searched indoor unit among the indoor units being operated within the group.
Fixed	Auto-change over operation function is operated depending on the detected temp based on the firstly registered indoor unit in the group.

Temperature limit operation tab is as below.

Max and Min temperature can be set. Whether the pleasant control of comfort group is applied or not is divided into applied and not applied.

Item	Description
Enable	Use auto-change over operation function in currently specified group.
Disable	Not use auto-change over operation function in currently specified group.

After setting, click Set button and click Send button.

Device connected control

Emergency Stop Interlocking, the device connected control, is a function that stops all indoor units and ventilation units in case of fire and other emergency. The summary on this function is as follows.

- Save current setting status function

The indoor units and ventilation units being currently monitored is data-based and saved.

- Operation setting function

If you set the external device and product status in the operation setting, the setting operation shall be carried out when the device recognizes DI signal.

- Emergency stop function

When external signal is detected, this function is used to save current setting status and stop the operation of all indoor device and ventilation product. Once the external signal is recognized, the operation status of the product isn't recovered even if the external signal doesn't last.

Below is the main screen of device connected control.

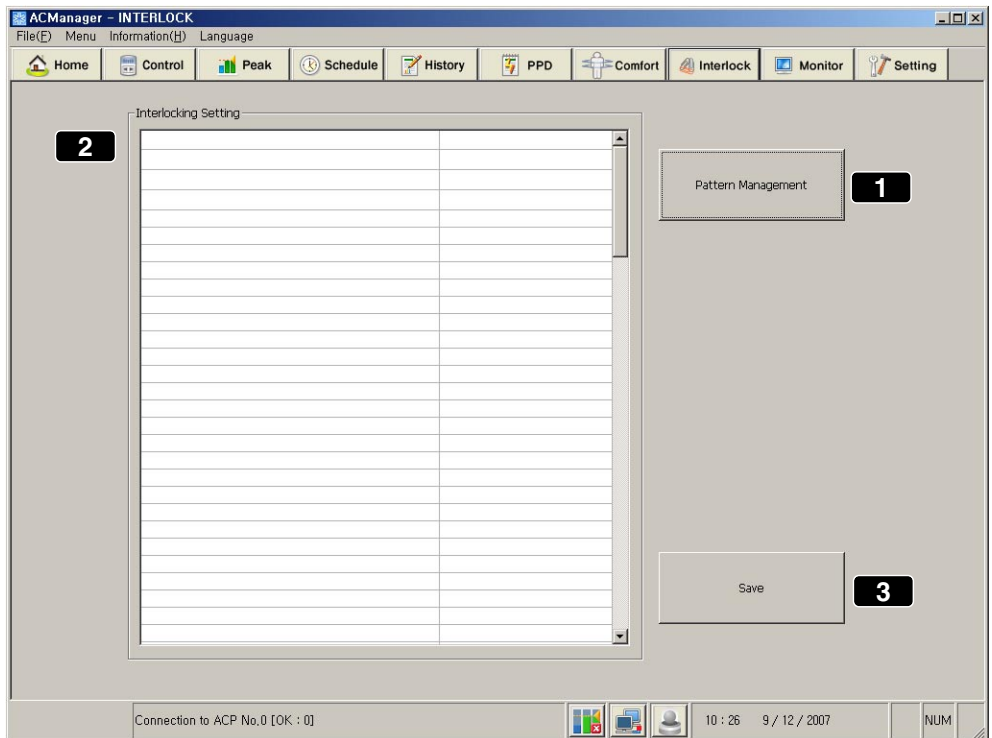

Below is the description on each menu on above screen.

1 Pattern management

A button to manage the pattern for device connected control.

2 Device connected control setting

Current setting pattern is reflected to device connected setting list.

3 Save

Saves current setting.

Pattern management

Let's find out steps of managing the pattern for device connected control.

Click pattern management button and below window appears.

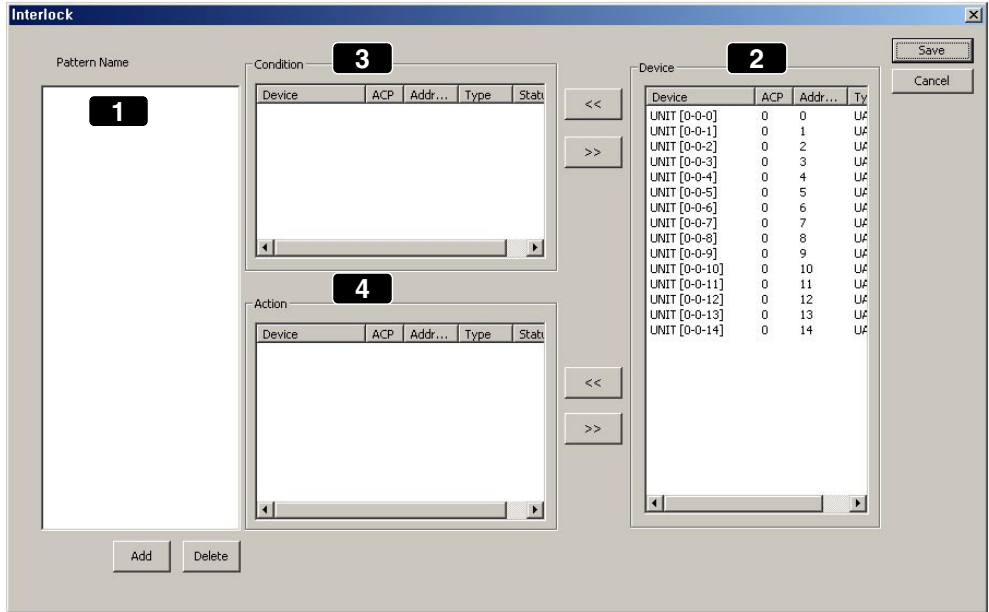

Below is the description on above menu.

1 Pattern name

Creates and deletes the pattern.

2 Device list

Selects the condition details of device.

3 Condition

Lists up the device in accordance with the condition.

4 Action

Lists up the device in accordance with the action.

Let's look over the order of example scenario.

1. Click Create button and below window appears.

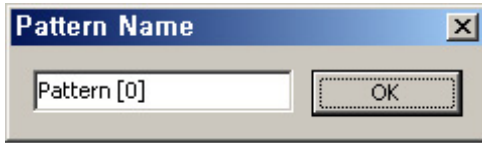

Enter the pattern name and click OK button. Now, specific device that operates under this pattern or air conditioner's condition and its action are set.

2. Specific operation of the indoor unit and device can be set as input conditions. Select a device in (2) and click << button to reflect it to (3). The input condition could be air conditioner or inputting DI port. Let's assume DI that detects fire in this example.

Select a device in (2) and click << button to reflect it to (3) as below.

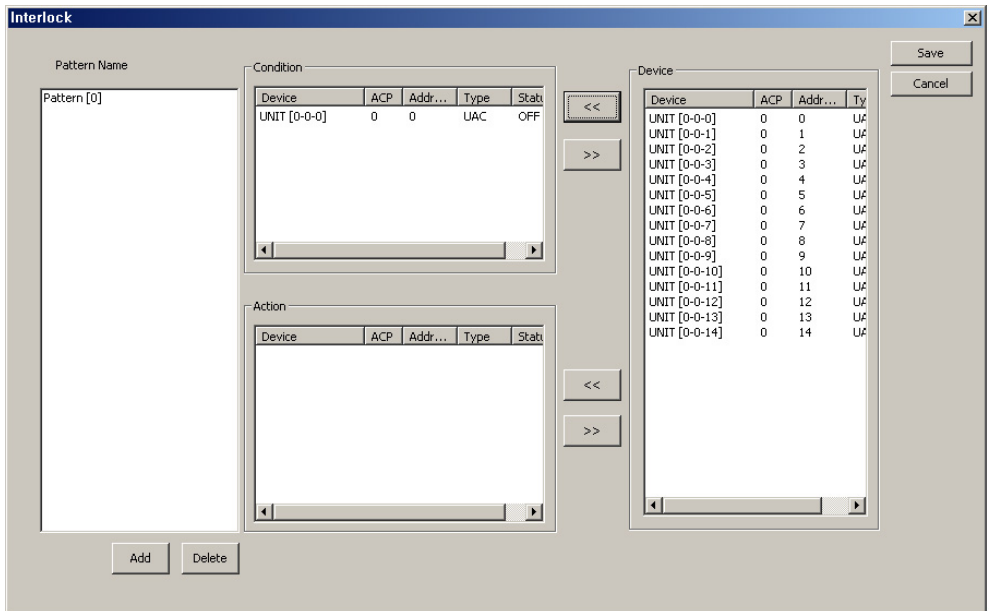

Indicate its status On when fire is detected in DI of port5-1, reflected in (3). The status of DI can be determined to be On or Off by double-clicking the device. In this case, the air conditioner connected to ACP5 should be Off as responsive action. Select air conditioner for the responsive action in (2) and click << button to reflect it to (4) action area. Now, the screen appears as below.

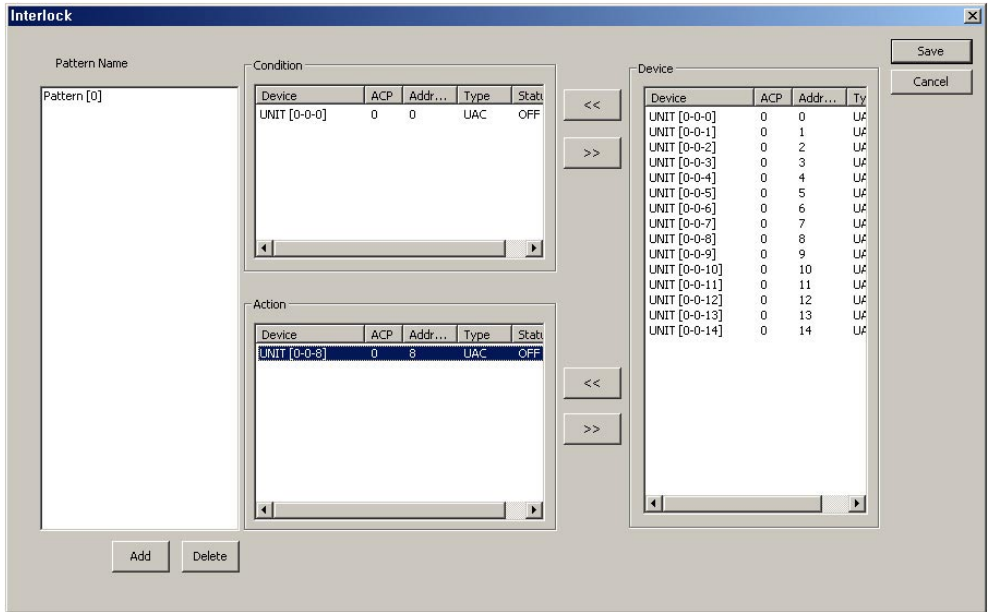

3. Now, set the operation status of air conditioner corresponding to the responsive print-out for the condition. Double-click the device reflected in (4) and below window appears.

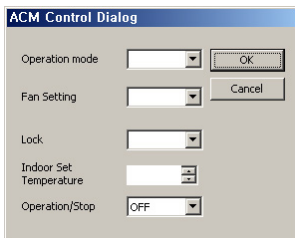

- Operation mode : Sets COOL, HEAT, FAN, AUTO and etc..
- Setting wind strength : Sets Fan speed. Sets LOW, HIGH, MID and etc.
- Lock : Determines whether to lock all.
- Indoor setting temperature : Means indoor temperature. Sets the temperature range to control. Using >> and <<, provide the condition of temperature below the specific temperature.
- Operation/Stop : Determines whether to turn On or Off.

Monitor

Monitor is a function that inquires the status information of the indoor device, monitor the error status and guarantee the operation of air conditioner. In addition, this monitor function is a function that helps user respond promptly when emergency and critical error occurs.

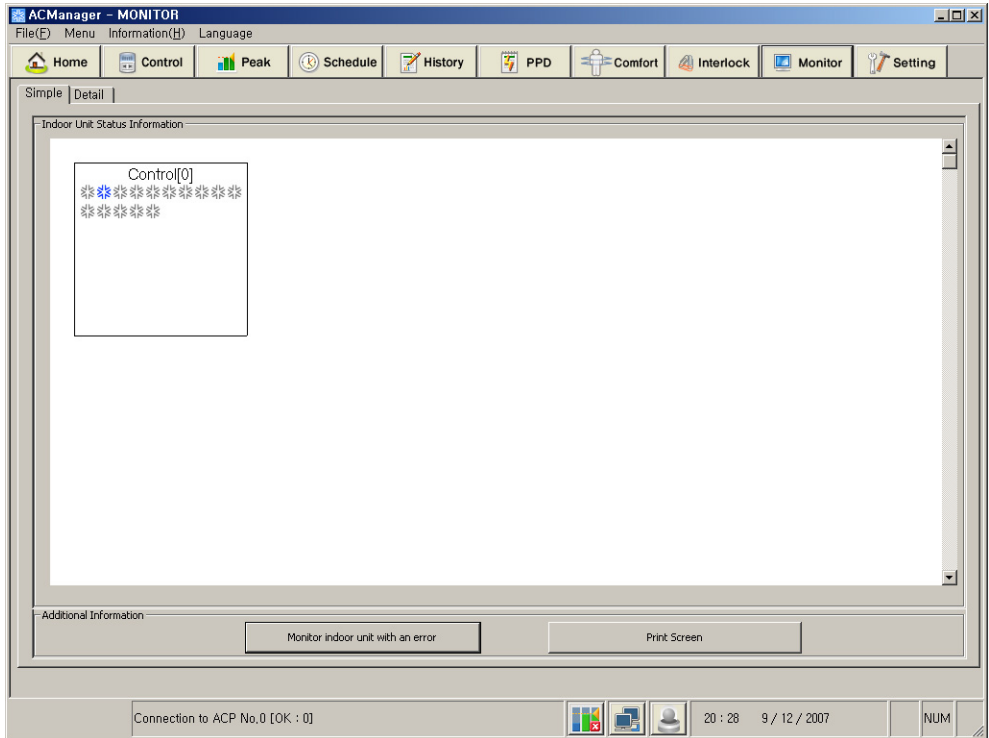











Let's find out the scenario order using above menu.

1. Click "Brief" tab and above default screen appears. This shows the operation status of the indoor unit belonging to the current control group. Using below icon, for air conditioner, you can check cooling, heating, wind, removing humidity, On/Off status of auto mode and error status. For ventilation, you can check auto, electric heating, On/Off status and error status of normal mode.







Reference: Print screen

When you press the Print screen button, you can output the screen currently displayed on the monitor. When you set the print page to Landscape, you can see the information more easily.

<Air conditioner>

Operation mode	Description
	Cooling
	Stop Cooling
	Removing humidity
	Stop Removing humidity
	Wind
	Stop wind
	Heating
	Stop Heating
	Auto operation
	Stop auto operation
	Error indication

<Ventilation>

Operation mode	Description
	Electric heating Ventilation mode of supplied/emitted air through electric heating exchanger. Used as electric exchange mode in summer/winter when the difference of temperature and humidity between indoor and outdoor is big.
	Stop Electric heating operation
	Normal indication Ventilation mode of supplied/emitted air not through electric heating exchanger. Used as electric exchange mode in spring/summer when the difference of temperature and humidity between indoor and outdoor is small.
	Stop Normal operation
	Auto indication By measuring indoor and outdoor temperature, automatically adjusts supplied/emitted air, and operates in optimum status in order to keep the balance of indoor air. When connected to Multi V, the operation has been determined by the operation speed setting temperature of the air conditioner besides indoor and outdoor temperature.
	Stop Auto operation

- Click "Detail" tab, and the address of all air conditioners, operation mode, status, indoor temperature, setting temperature, all lock and etc. are listed up as shown below.

The screenshot shows the ACManager - MONITOR software interface. The 'Detail' tab is selected, displaying a table of air conditioner status information. The table has columns for A/C Name, Address, Operation Mode, Operation Status, Indoor Temperature, Setting Temperature, All Lock, Temp. Lock, Mode Lock, and Fan Lock. The data is as follows:

A/C Name	Addr...	Operatio...	Operatio...	Indoor T...	Setting T...	All Lock	Temp. Lock	Mode Lock	Fan Lo
UNIT [0-0-0]	0	COOL	OFF	22	25	OFF	OFF	OFF	OFF
UNIT [0-0-1]	1	COOL	ON	23	25	OFF	OFF	OFF	OFF
UNIT [0-0-2]	2	COOL	OFF	24	25	OFF	OFF	OFF	OFF
UNIT [0-0-3]	3	COOL	OFF	21	25	OFF	OFF	OFF	OFF
UNIT [0-0-4]	4	COOL	OFF	24	25	OFF	OFF	OFF	OFF
UNIT [0-0-5]	5	COOL	OFF	24	25	OFF	OFF	OFF	OFF
UNIT [0-0-6]	6	COOL	OFF	25	25	OFF	OFF	OFF	OFF
UNIT [0-0-7]	7	COOL	OFF	22	25	OFF	OFF	OFF	OFF
UNIT [0-0-8]	8	COOL	OFF	22	25	OFF	OFF	OFF	OFF
UNIT [0-0-9]	9	COOL	OFF	22	25	OFF	OFF	OFF	OFF
UNIT [0-0-10]	10	COOL	OFF	24	25	OFF	OFF	OFF	OFF
UNIT [0-0-11]	11	COOL	OFF	18	25	OFF	OFF	OFF	OFF
UNIT [0-0-12]	12	COOL	OFF	21	25	OFF	OFF	OFF	OFF
UNIT [0-0-13]	13	COOL	OFF	24	25	OFF	OFF	OFF	OFF
UNIT [0-0-14]	14	COOL	OFF	24	25	OFF	OFF	OFF	OFF

Below the table, there are controls for 'Indoor Unit Type' (radio buttons for A/C and Ventilation), and buttons for 'Monitor All A/C', 'Monitor indoor unit with an error', and 'Save File'. The status bar at the bottom shows 'Connection to ACP No.0 [OK : 0]', system icons, and the time '20 : 28 9 / 12 / 2007'.

Above details reflect the air conditioner information being operated in the default control in real time. Let's find out the menu on above screen.

Following information appears on the monitoring screen.

<Air conditioner>

Item	Description
Name of Air conditioner	Shows currently registered air conditioner name.
Operation mode	Shows the operation mode of the air conditioner set.
Operation status	Shows the wind strength of the air conditioner set.
Operation lock	Shows whether to set the temperature lock function or not.
Indoor temp	Shows the indoor temperature with the air conditioner.
Setting temp	Shows the desired temperature for indoor temperature.
All lock	Prevents the operation status of air conditioner from changing.
Temperature lock	Prevents the temperature of air conditioner from changing.
Mode lock	Prevents the mode of air conditioner from changing.
Wind lock	Prevents the wind strength of air conditioner from changing.
Wind strength	Shows the wind strength of air conditioner.
Wind direction	Shows the wind direction of air conditioner.
Temp setting range	Shows the temperature range of air conditioner.
Error	Shows the error status of air conditioner.

<Ventilation>

Item	Description
Ventilation name	Shows the ventilation name registered in current system.
Address	Shows the ventilation address.
Operation mode	Shows the operation mode of ventilation.
Operation status	Shows the operation status of ventilation.
All lock	Prevents the operation status of ventilation from changing.
Additional function	Shows the additional function of ventilation.
Plasma	Shows the plasma function of ventilation.
Heater	Shows the heater function of ventilation.
Wind strength	Shows the wind strength of ventilation.
Error	Shows the error status of ventilation.

4. Note

TCP/IP setting guide

Below description is based on Window XP.

1. Click [Start] → [Control board] on user's PC, and below window appears.

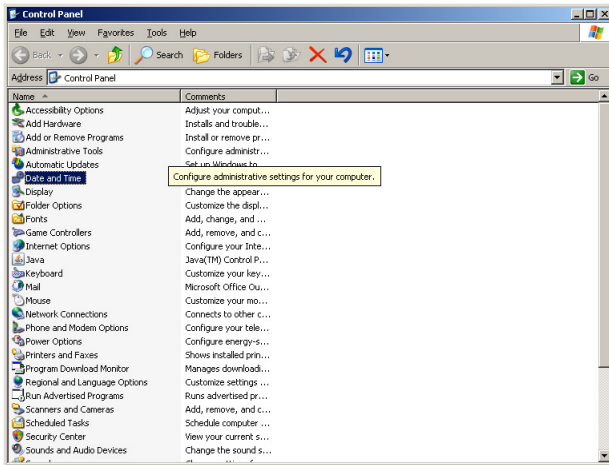

Click “Connect network” with border on above screen.

2. The window that local area connection can be set appears.

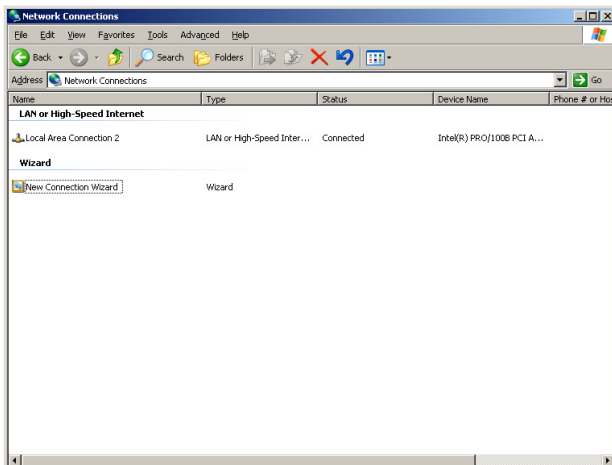

Put the mouse on local area connection and right-click the mouse to select “property”.

3. The window of local area property appears.

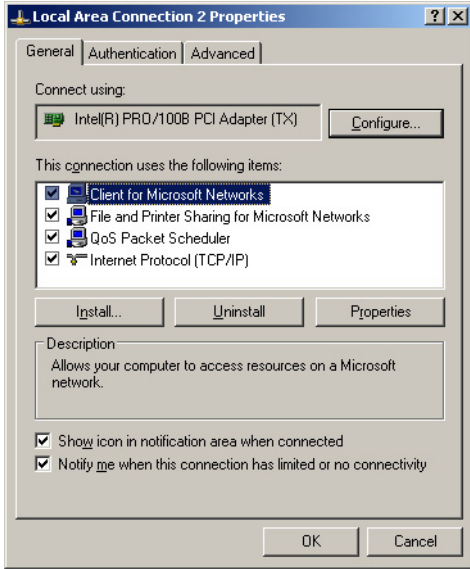

Double-click the Internet protocol (TCP/IP).

Figure. Local area connection 2 property

4. IP setting window appears.

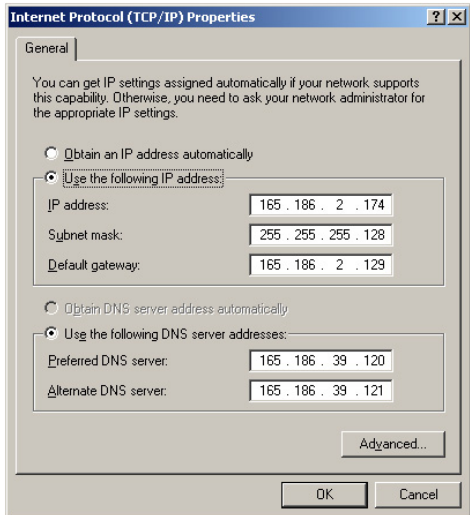

Select Use next IP address and enter IP to add and click OK. When adding private IP, receive IP from the network administrator and enter this.

5. You can additionally enter IP for AC Manager in IP of existing PC. Click Advanced button on above screen, and you can add IP. Click Advanced button and below window appears.

The screenshot shows the 'Advanced TCP/IP Settings' dialog box with the following content:

IP address	Subnet mask
165.186.2.174	255.255.255.128

Gateway	Metric
165.186.2.129	Automatic

Buttons: Add..., Edit..., Remove (under both tables); Automatic metric (checked); Interface metric: []; OK, Cancel.

Enter additional IP here and while using existing IP, you can use AC Manager.

After setting, click “OK” button.

Note: LAN Line

The additional IP in Advanced button will disappear when user remove LAN from PC. When LAN is plugged again, this IP should be entered again. When using Manger, insert Hard_Lock key into USB port of AC Manager PC. All functions of AC Manager are determined by authentication key.

