



©2001 Lennox Industries Inc.
Dallas, Texas, USA

504,391M
7/2001
Supersedes 503,901M

USER'S INFORMATION MANUAL

G32V SERIES

GAS FURNACE

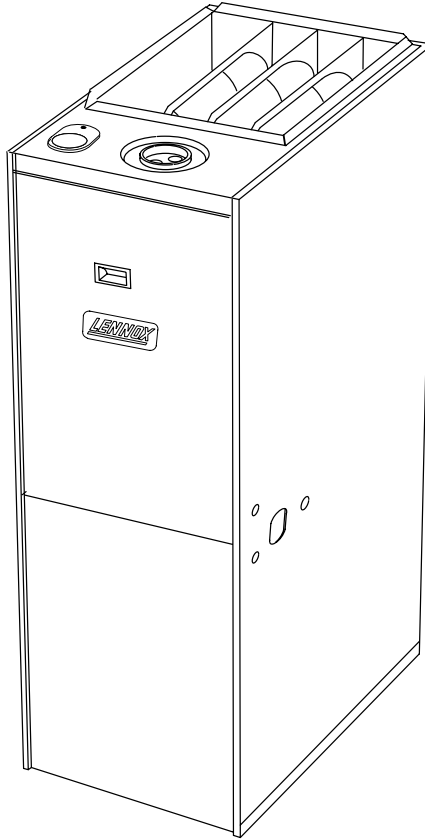

TPD Technical
Publications

Litho U.S.A.

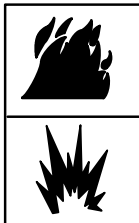

⚠ WARNING

If the information in this manual is not followed exactly, a fire or explosion may result causing property damage, personal injury or loss of life.



Do not store or use gasoline or other flammable vapors and liquids in the vicinity of this or any other appliance.

Installation and service must be performed by a qualified installer, service agency or the gas supplier.

WHAT TO DO IF YOU SMELL GAS:

- Do not try to light any appliance.
- Extinguish any open flames.
- Do not touch any electrical switch; do not use any phone in your building.
- Immediately call your gas supplier from a neighbor's phone. Follow the gas supplier's instructions.
- If you cannot reach your gas supplier, call the fire department.

07/01

504,391M



G32V Parts Identification

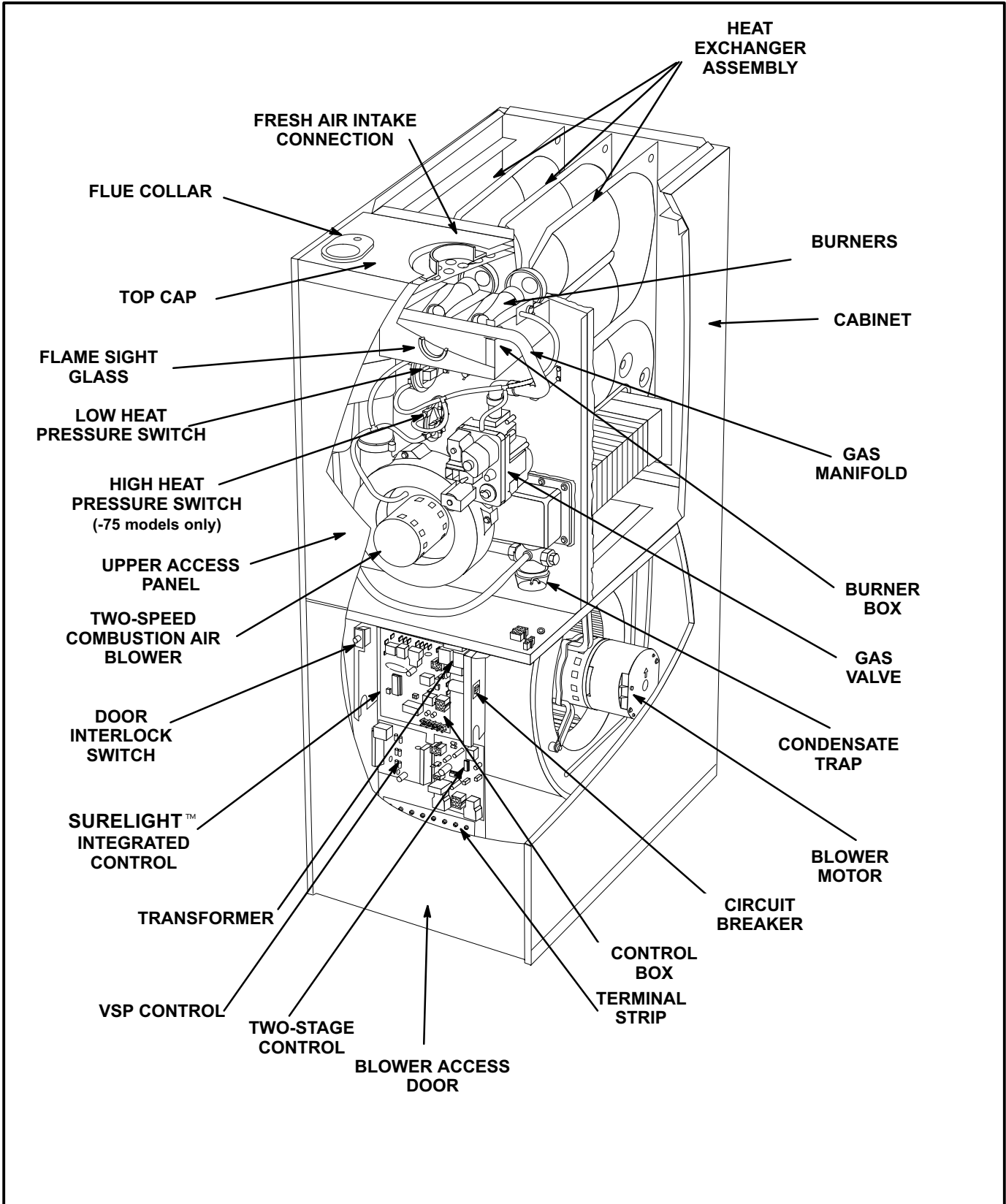

Figure 1

WARNING

Product contains fiberglass wool.

Disturbing the insulation in this product during installation, maintenance, or repair will expose you to fiberglass wool dust. Breathing this may cause lung cancer. (Fiberglass wool is known to the State of California to cause cancer.)

Fiberglass wool may also cause respiratory, skin, and eye irritation.

To reduce exposure to this substance or for further information, consult material safety data sheets available from address shown below, or contact your supervisor.

Lennox Industries Inc.

P.O. Box 799900

Dallas, TX 75379-9900

WARNING

Do not set thermostat below 60°F (16°C) in heating mode. Setting thermostat below 60°F (16°C) reduces the number of heating cycles. Damage to the unit may occur that is not covered by the warranty.

WARNING

If overheating occurs or if gas supply fails to shut off, shut off the manual gas valve to the appliance before shutting off electrical supply.

WARNING

Do not use this furnace if any part has been under water. Immediately call a qualified service technician to inspect the furnace and to replace any part of the control system and any gas control which has been under water.

CAUTION

Before attempting to perform any service or maintenance, turn the electrical power to unit OFF at disconnect switch.

IMPORTANT

Any additions, changes, or conversions required in order for the appliance to satisfactorily meet the application needs must be made by a Lennox service technician using factory specified and approved parts.

Important Directions

- 1 - Keep the furnace area clear and free of combustible material, gasoline, and other flammable vapors and liquids. If installed in an insulated area, furnace must be kept free of insulating material. Insulating material may be combustible.
- 2 - DO NOT obstruct air flow to unit. Unit must receive an unobstructed flow of combustion and ventilating air.
- 3 - DO NOT store chlorine or fluorine products near unit or introduce these products into the combustion air. These products can cause furnace corrosion.
- 4 - **DO NOT draw the return air from a room where another gas appliance (ie., a water heater) is installed.** Even though this furnace draws its combustion air from outside of the structure, other gas appliances that share a utility room may not. When return air is drawn from a room, a negative pressure is created in the room. If a gas appliance is operating in a room with negative pressure, the flue products can be pulled back down the vent pipe and into the room. This reverse flow of the flue gas may result in incomplete combustion and the formation of carbon monoxide gas. This toxic gas might then be distributed through the house by the furnace duct system.

Your furnace is a gas appliance. It is critical that the gas supplied to the unit be completely burned to avoid the production of carbon monoxide gas. Complete combustion of the gas requires, but is not limited to, correct gas pressure and gas flow rate, adequate combustion, air, and proper venting.

WARNING

Carbon monoxide gas is invisible, odorless, and toxic.

Exposure to this gas can cause personal injury and even death to all occupants, including pets. Any item that is powered by or gives off heat from a combustion process (including lawn mowers, automobiles, and fireplaces) has the potential to produce carbon monoxide gas. Because of this, **Lennox recommends the use of a carbon monoxide detector in your home, even if you do not own gas appliances.** Reliable detectors are available at reasonable retail prices. Contact your independent Lennox dealer for more details about this investment in your safety.

Your furnace is designed to meet standards set by national agencies, and to operate safely when properly installed and maintained. However, the unit's performance can be

greatly impacted by the individual installation and the operating environment. It is your responsibility to ensure that this appliance is maintained. Proper maintenance is critical for your safety and the satisfactory operation of the product. **Lennox strongly recommends annual inspection and maintenance of this appliance.** Contact your independent Lennox dealer for an inspection by a qualified service technician.

Lighting and Operating Information

! WARNING
If you do not follow these instructions exactly, a fire or explosion may result causing property damage, personal injury or loss of life.

BEFORE LIGHTING smell all around the appliance area for gas. Be sure to smell next to the floor because some gas is heavier than air and will settle on the floor.

The unit is equipped with a gas control knob. Use only your hand to move the gas control knob. Never use tools. If the knob will not move by hand, do not try to repair it, call a qualified service technician. Force or attempted repair may result in a fire or explosion.

Placing the G32V furnace into operation:

G32V units are equipped with a SureLight™ ignition system. Do **not** attempt to manually light these furnaces. Each time thermostat calls for heat, the burners will be automatically lit by the ignitor. The ignitor does not get hot when there is no call for heat.

Operating the Gas Valve (Figure 3)

- 1 - **STOP!** Read the safety information at the beginning of this section.
- 2 - Set thermostat to lowest setting. See figure 2.

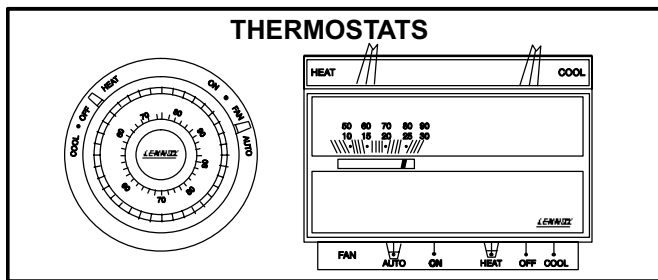

Figure 2

- 3 - Turn **OFF** all electrical power to appliance.
- 4 - This appliance is equipped with an ignition device which automatically lights the burners. Do **not** try to light the burners by hand.
- 5 - Remove upper access panel.
- 6 - Turn the gas valve knob to **OFF**. Do not force. See figure 3.

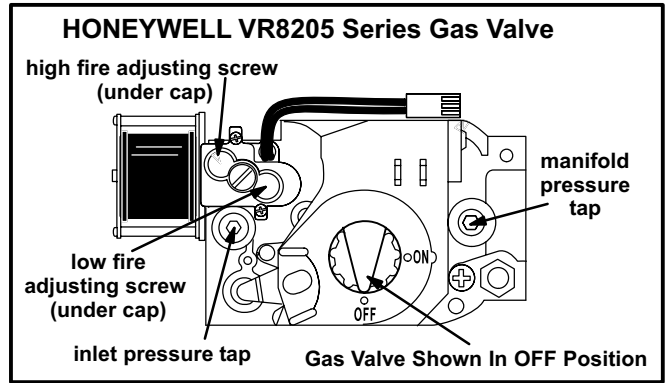

Figure 3

- 7 - Wait fifteen (15) minutes to clear out any gas. If you then smell gas, **STOP!** Immediately call your gas supplier from a neighbor's phone. Follow the gas supplier's instructions. If you do not smell gas go to next step.
- 8 - Turn the gas valve knob to **ON**.
- 9 - Replace upper access panel.
- 10 - Turn on all electrical power to unit.
- 11 - Set thermostat to desired setting.
- 12 - If the appliance still will not operate, follow the instructions "To Turn Off Gas To Unit" and call your service technician or gas supplier.

Turning Off Gas To the Unit

- 1 - Set thermostat to lowest setting.
- 2 - Turn off all electrical power to unit if service is to be performed.
- 3 - Remove upper access panel.
- 4 - Turn the gas valve knob to **OFF**. **Do not force.**
- 5 - Replace upper access panel.

Filters

A filter must be in place any time the unit is operating. Factory-installed filters are provided with the unit. Ask your dealer to show you where the filter is located. The filter should be inspected monthly and cleaned when necessary to assure proper furnace operation.

The foam filters supplied with the unit may be cleaned for reuse. If replacement is necessary, order Lennox part no. 31J81 for 14 X 25 inch filter used in G32V-75 units or P-8-7831 for 20 X 25 inch filter used in G32V-100 and -125 units. Use the following procedure to clean filter.

Bottom Return Air Filter Installation (Figure 4)

- 1 - Turn off electric power to furnace.
- 2 - Remove blower access panel.
- 3 - Remove filter by pressing side filter clips and pulling filter up and out. See figure 4.

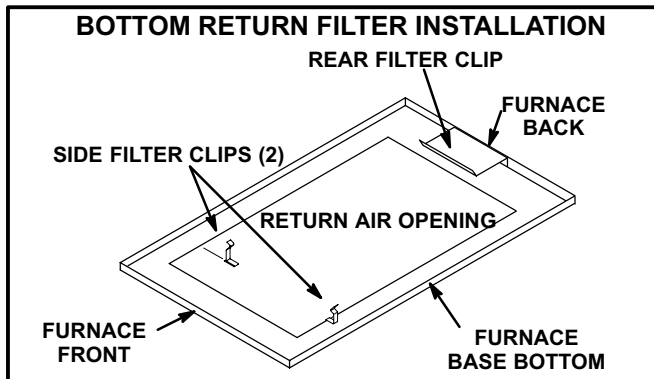

Figure 4

- 4 - Clean filter with cold water and a mild soap. Direct water through filter in the opposite direction of air flow. Remove all soap residue.
- 5 - Allow filter to dry then spray with filter handicoater prior to reinstallation. Filter handicoater is available from your Lennox dealer as P-8-5069.
- 6 - Place filter in bottom of blower compartment beneath rear filter clip. Press down on filter sides. Filter clips flex, allowing filter to snap into place.
- 7 - Replace blower access panel.

⚠ WARNING

Blower door must be securely in place when blower and burners are operating. Gas fumes, which could contain carbon monoxide, can be drawn into living space resulting in personal injury or death.

Side Return Air Filter Installation (Figure 5)

- 1 - Turn off electric power to furnace.
- 2 - Locate the filter door of the filter rack assembly.
- 3 - Using the filter door pins, pull filter door, with filter attached, out of filter rack assembly. Remove filter door from filter by pulling up on securing tabs.
- 4 - Clean filter with cold water and a mild soap. Direct water through filter in the opposite direction of air flow. Allow filter to dry, then spray with filter handicoater prior to reinstallation. Filter handicoater is available from your Lennox dealer as P-8-5069.
- 5 - Position filter door on end of filter so that the thumb tab side of the filter door is away from the furnace. Check for correct air flow position. Squeeze thumb tabs to secure filter to door.
- 6 - Guide filter and filter door into the filter rack installed on side of furnace. Push door into filter rack until secure.

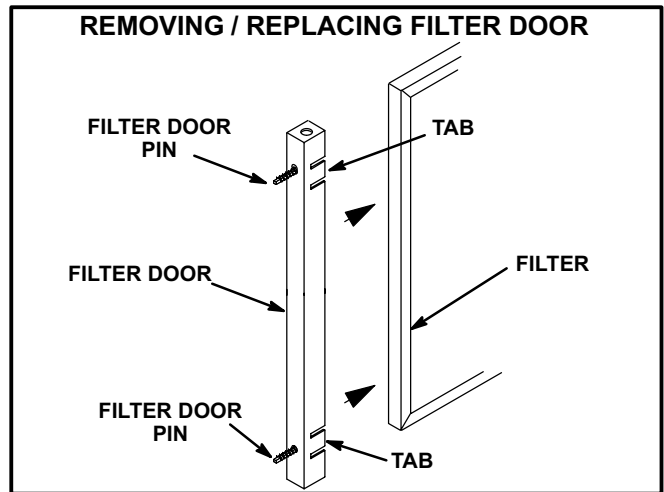

Figure 5

Seasonal Inspections

A qualified service technician should inspect the complete system each season (heating and cooling). The following maintenance procedures should be conducted by a qualified service technician. **Do not attempt to service the unit in any way.**

During a seasonal check the service technician will inspect the indoor blower, the burner flame and the venting system.

Venting System

Annually (before heating season) inspect furnace venting system, heat exchanger and burners for corrosion, deterioration, or deposits of debris. Remove any obstructions.

Inspect furnace venting system to make sure it is in place, physically sound, and without holes, corrosion, or blockage. Vent connector must be in correct position, sloped upward and be physically sound without holes or excessive corrosion.

Inspect furnace return air duct connection to ensure duct is sealed to the furnace and terminates outside the space containing the furnace.

Inspect the physical support of the furnace to guarantee that it is sound without sagging, cracks or gaps around base and it maintains seal between base and support.

Inspect and clean the condensate traps and drain.

Blower

Check and clean blower wheel for any debris. Blower motor is pre-lubricated for extended bearing life. No further lubrication is needed.

Burner Flame

Burner Flame - Start burner and allow to operate for a few minutes to establish normal burning conditions. Check burner flame by observation. Flame should be predominantly blue in color and strong in appearance.

CAUTION

Periodically look through the flame sight glass to check the burner flame.

Contact your Lennox dealer for a periodic unit inspection by a qualified service technician.

Service Reminders

Call your Lennox service technician if unit is inoperative. Before calling, always check the following to be sure service is required.

- 1 - Check that electrical disconnect switches are **ON**.
- 2 - Check room thermostat for proper setting.
- 3 - Replace any blown fuses or reset circuit breakers. Investigate reason for blown fuses or tripped breakers.
- 4 - Make sure gas valve is in **ON** position.
- 5 - Air filter should not be plugged limiting air flow.
- 6 - Is gas turned on at meter?
- 7 - Is manual main shut-off valve open?

Safety Precautions

If you discover any of the following, shut down your unit, and contact an independent Lennox dealer for an inspection by a qualified technician.

- If you repeatedly hear any new or unfamiliar sounds while your unit is operating, there may be a problem. For example, poorly performing burners can produce unfamiliar noises.
- If you smell any unusual odors, your unit may be operating improperly. For example, units can give off unfamiliar odors if components are required to operate in abnormal conditions.
- Look for visible signs of a malfunctioning unit. Examples include unusual amounts of condensate on windows inside your house, visibly burnt components or unusual dirt or rust accumulations on the vent pipe or in the unit.
- If you experience headache, nausea, fatigue, or dizziness,

the cause could be exposure to carbon monoxide gas. This is often misdiagnosed as the flu because symptoms are similar. If you suffer from flu-like symptoms that are exaggerated at home, but seem to subside while you are away from the house, exposure to carbon monoxide could be the cause.

Your vigilance may pay off in early detection of a problem before either personal injury or property damage occurs. Do not hesitate to contact a qualified service technician as an investment in your well being.

Planned Service

You should expect a service technician to check the following items during an annual inspection. Power to the unit must be shut off for the service technician's safety.

Fresh air grilles and louvers (on the unit and in the room where the furnace is installed) - Must be open and unobstructed to provide combustion air.

Burners- Must be inspected for rust, dirt, or signs of water.

Vent pipe - Must be inspected for dirt, signs of water, damaged or sagging unsupported pipe, or disconnected joints.

Unit appearance - Must be inspected for rust, dirt, signs of water, burnt or damaged wires, or components.

Blower access door - Must be properly in place and provide a seal between the return air and the room where the furnace is installed.

Return air duct - Must be properly attached and provide an airtight seal to the unit.

Operating performance - Unit must be observed during operation to monitor proper performance of the unit and the vent system.

Combustion gases - Flue products must be analyzed and compared to the unit specifications.

Problems detected during the inspection may make it necessary to temporarily shut down the furnace until the items can be repaired or replaced.

Pay attention to your furnace. Situations can arise between annual furnace inspections that may result in unsafe operation. For instance, items innocently stored next to the furnace may obstruct the combustion air supply. This could cause incomplete combustion and the production of carbon monoxide gas.