

SERVICE UNIT INFORMATION

HS7

Litho U.S.A

HS7 SERIES UNITS

I - INTRODUCTION

HS7 condensing units are designed for industrial commercial applications. The 1853V size has one L6 (15 ton) two speed compressor. The 2753V size has two independent refrigerant circuits with L2 (11 ton) compressors. The units mate to CB3 blower coils with 50/50 split evaporators. Figure 1 shows a cutaway of unit.

A safety circuit, "stick" function, keeps indoor blower and outdoor fan motors running in the event a compressor contactor welds closed.

A Low Ambient Control Kit (LB-80249BA) is available. Hot Gas By-Pass Kits are also available: HS7-1853V (LB-26017BB) and HS7-2753V (LB-26017BA).

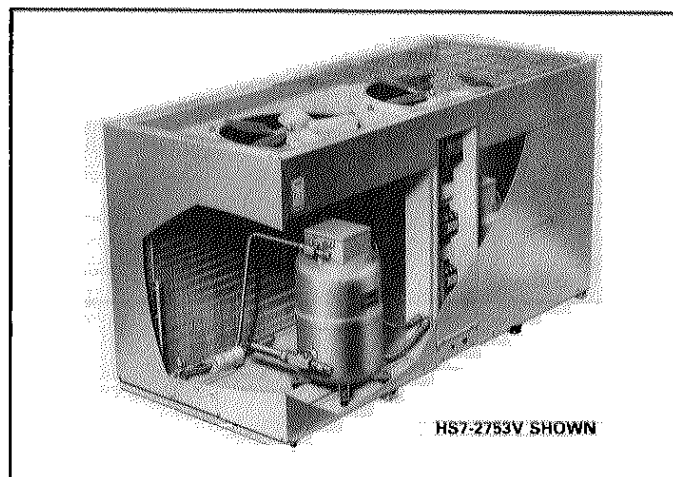

FIGURE 1

II - UNIT INFORMATION

A - Specifications

Model No.		HS7-1853V	HS7-2753V
Condenser	Net face area (sq. ft.)	25.4	25.4
	Tube diameter (in.) & No. of rows	3/8 — 4	3/8 — 6
	Fins per inch	18	18
Condenser	Diameter (in.) & No. of blades	26 — 5	26 — 5
	Motor hp	(2) — 1 hp	(2) — 1 hp
Fan (2)	Air volume (cfm) (factory setting)	14,500	13,500
	Fan speed (rpm) (factory setting)	1110	1100
	Motor watts (factory setting)	2000	2600
Refrigerant 22 charge furnished		holding charge	holding charge
Liquid line connection (O.D. in.) sweat		5/8	5/8
Suction line connection (O.D. in.) sweat		1-5/8	1-3/8
Net weight (lbs.) (1 Package)		1500	1910
Electrical characteristics (60hz — 3ph)		208V, 230V, 460V, 575V	208/230v, 460v, 575v

B - Electrical Data

Model No.		HS7-1853V				HS7-2753V		
Line voltage data (60 hertz — 3 phase)		208v	230v	460v	575v	208/230v	460v	575v
Compressor	Rated load amps	62.3	56.6	27.9	22.3	†82.2	†41.2	†31.4
	Power factor	.85	.85	.85	.85	†.85	†.85	†.85
	Locked rotor amps	412.0	375.0	188.0	150.0	†480.0	†256.0	†184.0
Condenser fan motors (2)	Full load amps (total)	9.6	8.6	4.4	3.4	9.6	4.4	3.4
	Locked rotor amps (total)	47.8	43.2	21.6	17.2	47.8	21.6	17.2
*Minimum circuit ampacity		87.5	79.4	39.3	31.3	102.1	50.8	38.7

*Refer to National Electrical Code manual to determine wire, fuse and disconnect size requirements.

†Data shown is with both compressors operating.

NOTE — Extremes of operating range are plus and minus 10% of line voltage.

C - Pressure Curves

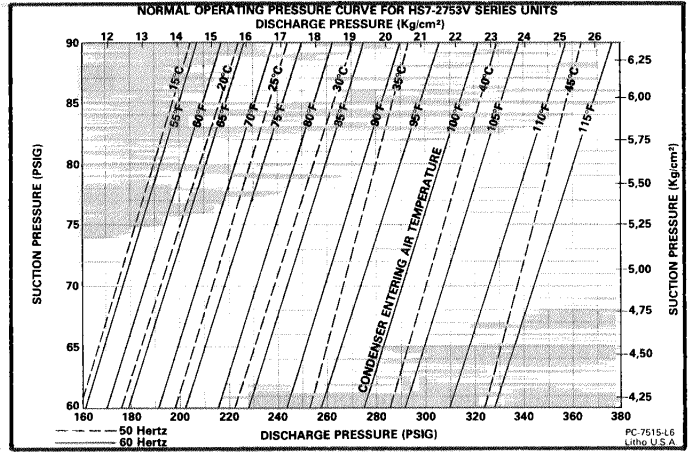
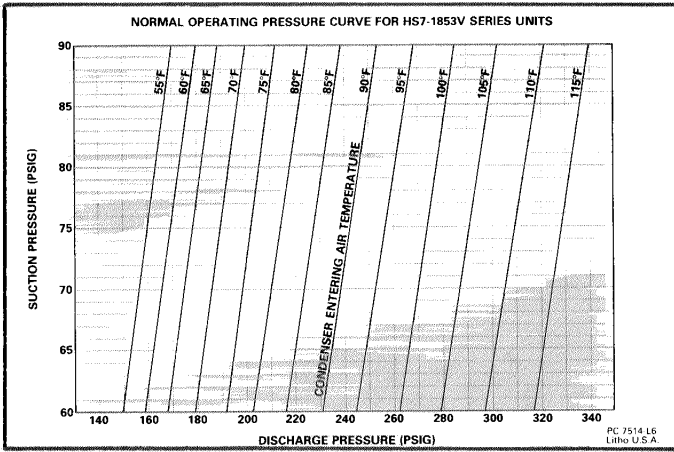

D - Dimensions

Dimensions	A	B	C	D	E	F	G	H
inches	93-1/4	48-7/8	92	5/8	2	23-3/4	36-1/2	40

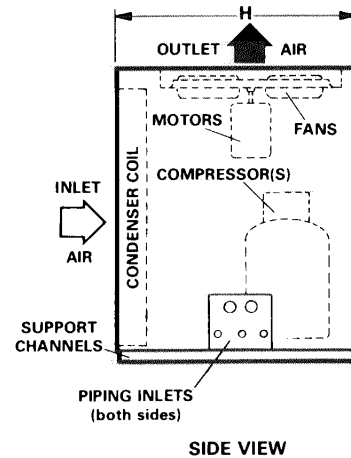
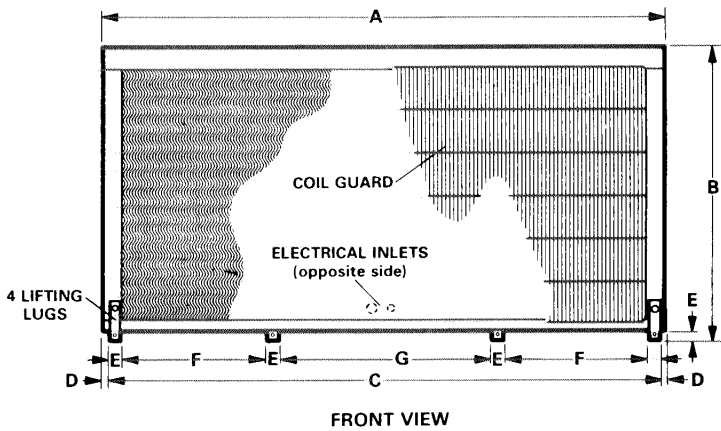
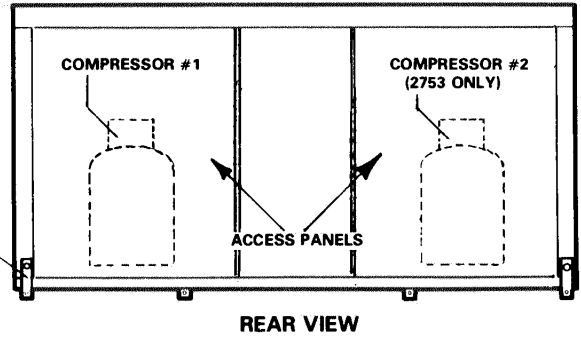
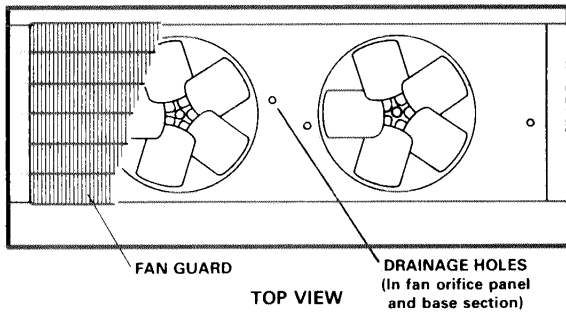

E - Field Wiring

1 - 1853V -

The first stage cooling bulb initiates low speed operation while the second stage bulb switches to high speed. A field installed solenoid valve opens on high speed demand to allow full use of the evaporator coil. Two field

installed blower relays are needed to incorporate the "stick" function. Figure 2 illustrates the field wiring.

2 - 2753V -

Each compressor is controlled by a cooling bulb at the thermostat. Figure 3 illustrates the field wiring.

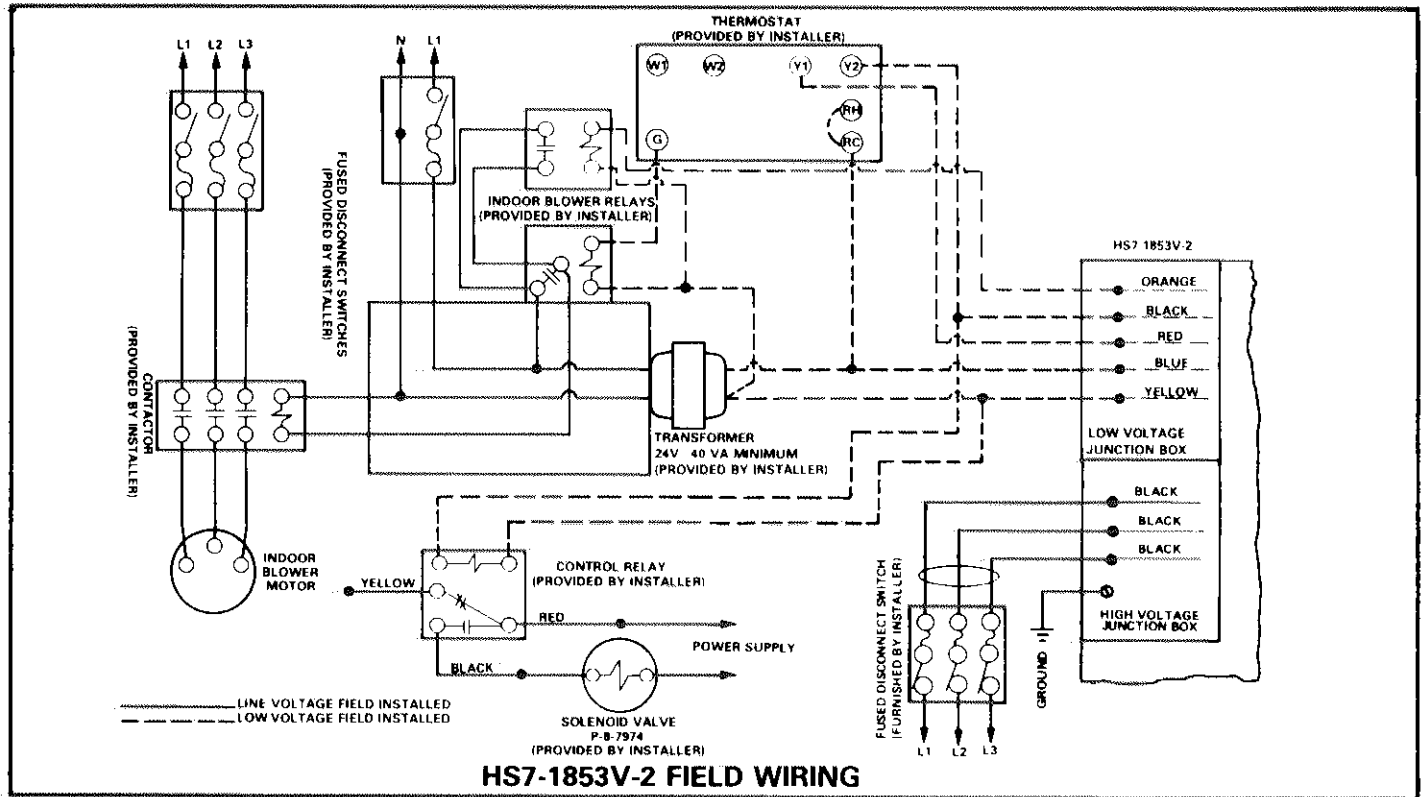

FIGURE 2

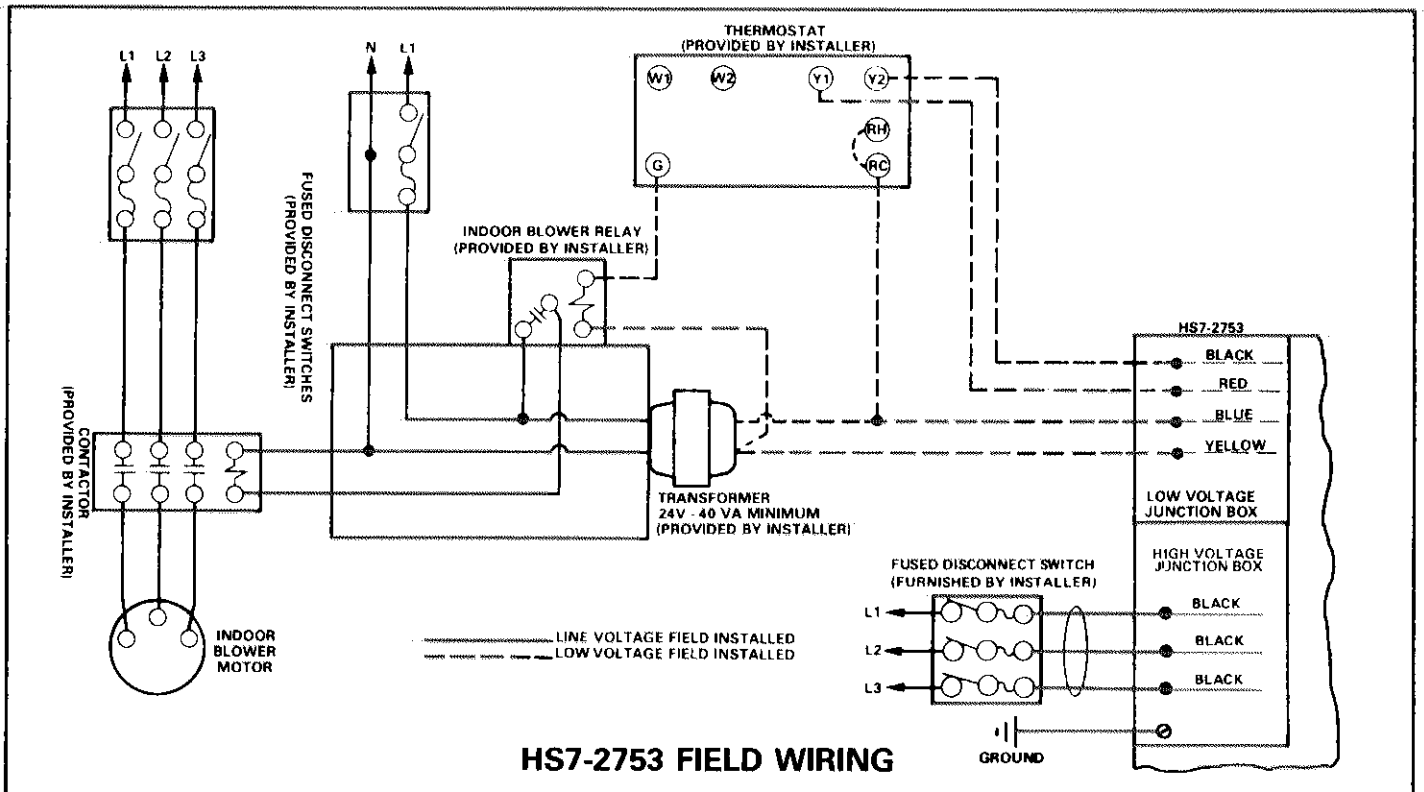

FIGURE 3

III - REFRIGERANT SYSTEM

The service valves and gauge ports are located inside the cabinet. Figure 4 identifies valves and ports for an HS7-1853V. The gauge ports on service valves can be shut off by backseating the valves. Open valve one turn off backseat to record pressure at gauge manifold.

Each refrigerant circuit in the evaporator coil has its own expansion valve. On 1853V applications a solenoid valve field installs in one of the evaporator coil circuits; the evaporator thus responds to the cooling demand. The HS7-1853V must be running at high speed when checking the refrigerant charge. The pressure curve for HS7-2753V units applies to each refrigerant circuit.

Each unit is furnished with a normal operating pressure curve. The curve uses suction pressure, discharge pressure and outdoor temperature comparison. To use the chart, first check suction pressure, then move over to the outdoor temperature and finally down to the discharge pressure. If the discharge pressure is within five pounds of this reading, the unit is properly charged, providing the three conditions meet in the unshaded area of the chart. If they meet in the shaded area, there is something wrong with the system and further checks are needed.

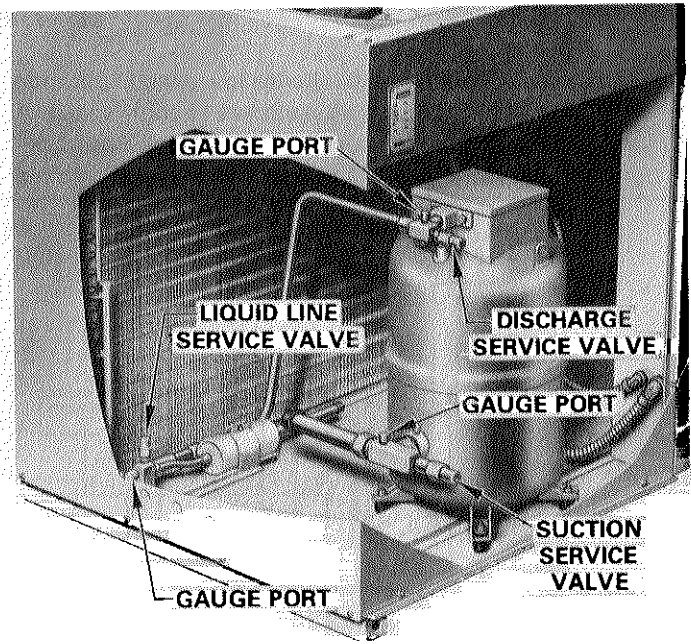

FIGURE 4

IV - COMPONENTS

Figure 5 shows an exploded view of the HS7.

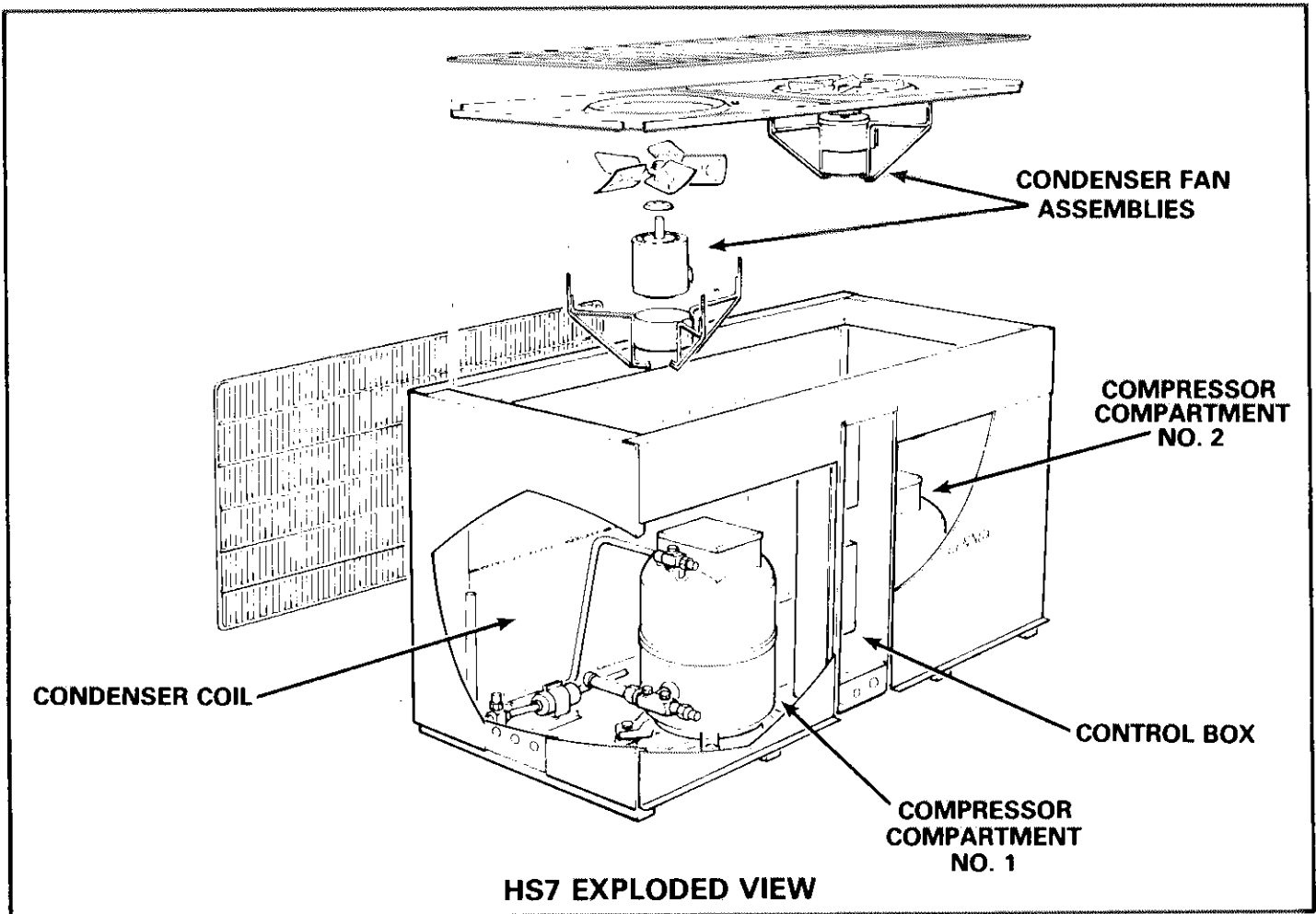

FIGURE 5

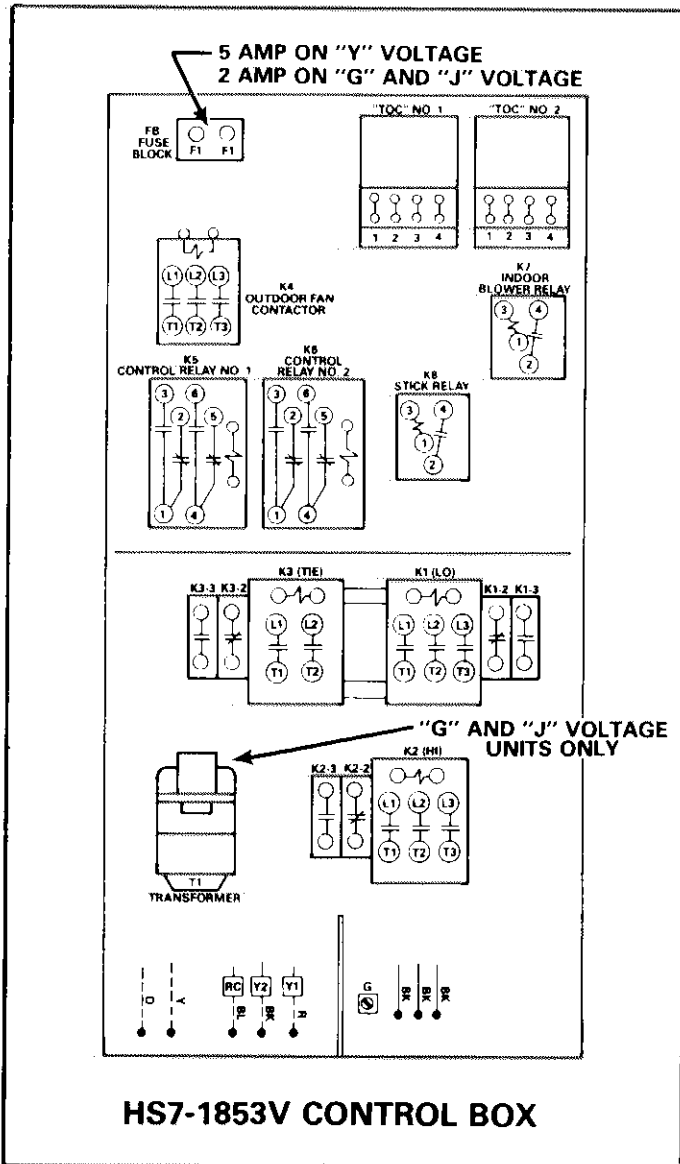

FIGURE 6

A - Control Box (Figures 6 & 7)

- 1 - Transformer
On 460V & 575V applications, this transformer provides 220V for the control circuit.
- 2 - Timed Off Controls
Prevents compressor short cycling and allows time for system pressures to equalize. Initially the control delays compressor operation for 20 seconds. It must run through a 5 minute cycle before it resets. If the compressor operates less than 5 minutes, the Timed Off Control will run through the remaining time plus 20 seconds on the next demand.
- 3 - Control Relays
Used in 24 volt control circuit for first and second stage cooling.
- 4 - Indoor Blower Relay (K7-1853V)
Energizes indoor blower operation during "stick" function.
Fan Control Relay (K7-2753V)
Energizes the fan contactor.

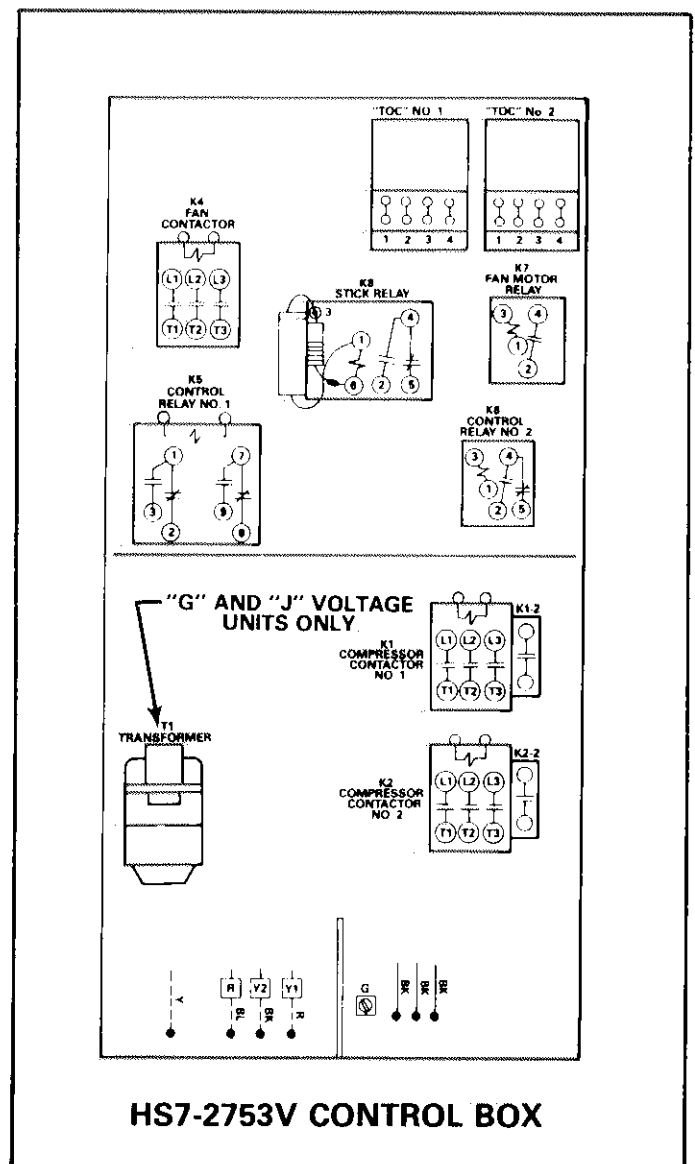

FIGURE 7

- 5 - Fan Contactor (K4)
Energizes condenser fan motors.
- 6 - Compressor Contactors (K1 & K2)
Energizes low and high speed operation on L6 compressor or initiates individual L2 compressors.
- 7 - Tie Contactor (K3-1853 only)
Provides a positive interlock between high and low speeds on L6 to prevent both speeds from being energized simultaneously.
- 8 - Stick Relay (K8)
Initiates "stick" function to operate blower motor and condenser fans should either compressor contactor weld.

**B - Compressors
L2 (HS7-2753V)**

The compressor is protected by a series of controls, located in the compressor make-up box, which monitor the system. They shut down the compressor during abnormal operating conditions.

1 - Compressor Overloads (3)

These protectors are current sensitive and protect the compressor motor from single phasing (loose wiring) and locked rotor conditions.

2 - High Pressure Switch

Opens control circuit at 410 psig head pressure. Automatically resets.

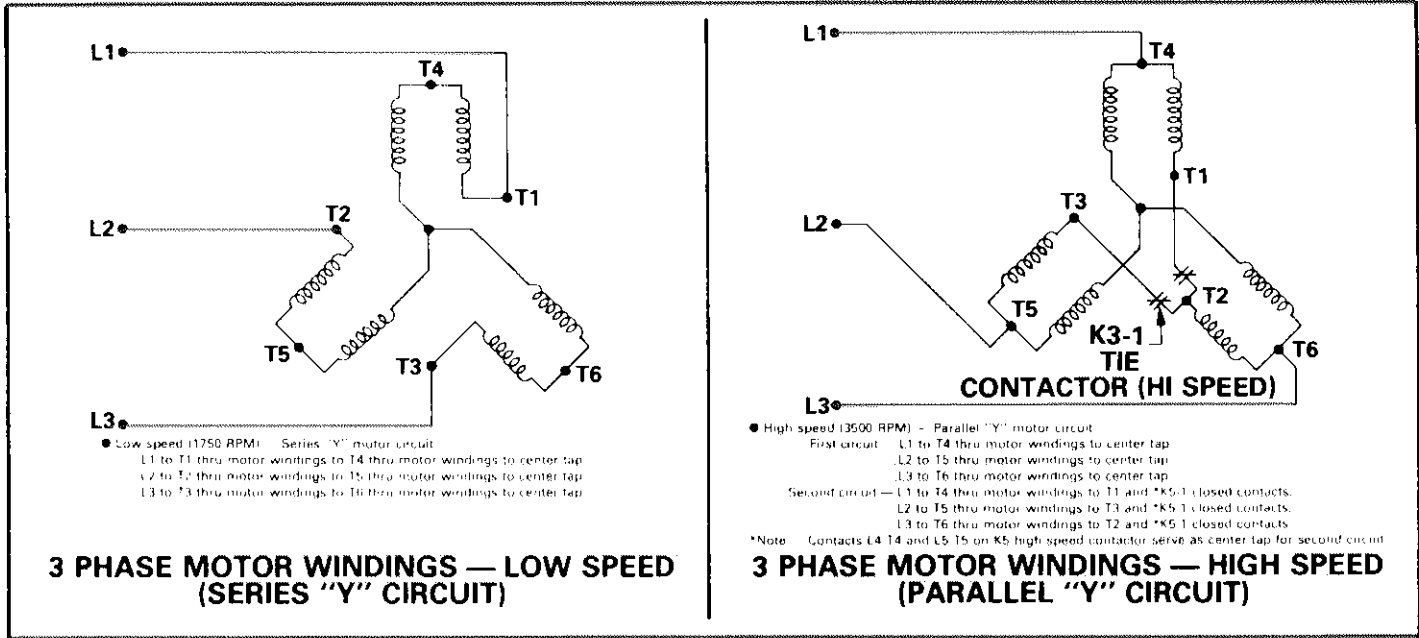

FIGURE 8

ROBERTSHAW SOLID STATE COMPRESSOR PROTECTION

SENSOR RESISTANCE VERSUS TEMPERATURE

TEMPERATURE	RESISTANCE	TEMPERATURE	RESISTANCE
50° F (10° C)	70.1 ± 2.7 OHM	160° F (71.7° C)	92.2 ± 2.4 OHM
55° F (12.8° C)	71.1 ± 2.7 OHM	170° F (76.7° C)	94.3 ± 2.3 OHM
60° F (15.6° C)	72.1 ± 2.7 OHM	180° F (82.2° C)	96.5 ± 2.3 OHM
65° F (18.3° C)	73.1 ± 2.7 OHM	190° F (87.8° C)	98.5 ± 2.3 OHM
70° F (21.1° C)	75.0 ± 2.6 OHM	200° F (93.3° C)	100.8 ± 2.3 OHM
75° F (23.9° C)	75.0 ± 2.6 OHM	210° F (98.8° C)	103.0 ± 2.2 OHM
80° F (26.7° C)	76.0 ± 2.6 OHM	220° F (104.4° C)	105.1 ± 2.2 OHM
85° F (29.4° C)	77.0 ± 2.6 OHM	230° F (110.4° C)	107.2 ± 2.1 OHM
90° F (32.2° C)	78.0 ± 2.6 OHM	240° F (115.5° C)	109.5 ± 2.0 OHM
95° F (35° C)	79.0 ± 2.6 OHM	250° F (121.1° C)	111.6 ± 2.0 OHM
100° F (37.8° C)	80.0 ± 2.6 OHM	260° F (126.6° C)	114.0 ± 2.0 OHM
110° F (43.3° C)	82.0 ± 2.5 OHM	270° F (132.2° C)	116.4 ± 2.1 OHM
120° F (48.9° C)	84.0 ± 2.5 OHM	280° F (137.7° C)	118.7 ± 2.2 OHM
130° F (54.4° C)	86.0 ± 2.5 OHM	290° F (143.3° C)	121.1 ± 2.0 OHM
140° F (60° C)	88.0 ± 2.5 OHM	300° F (148.8° C)	123.6 ± 2.3 OHM
150° F (65.6° C)	90.2 ± 2.4 OHM	310° F (154.4° C)	126.1 ± 2.3 OHM

230° F MODULE CUT-OUT POINT
180° F MODULE CUT-IN POINT (RESET)

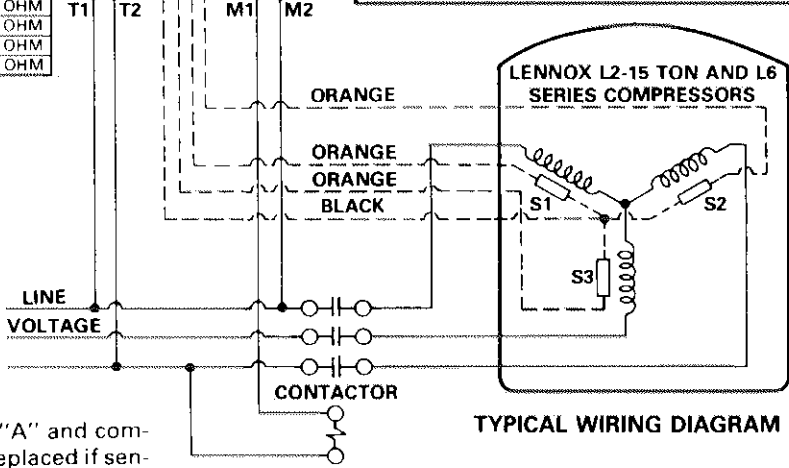
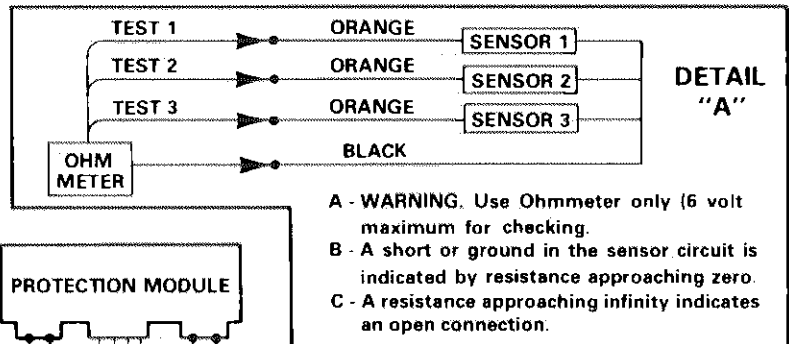

- 1 - Jumper M1 to M2 to bypass the control circuit. If compressor does not run, trouble is not in module. If compressor operates, the module is open.
- 2 - Check thermal sensors according to Detail "A" and compare values to table. Compressor must be replaced if sensors are defective.
- 3 - If the sensors are OK and compressor runs when module is jumpered, the protection module must be replaced.

- 4 - If sensor indicates a compressor temperature over 230° F, allow compressor enough time to cool before condemning it. Check the cause of overheating.

FIGURE 9

3 - Ambient Thermostat

This thermostat opens control circuit at 22°F ambient and automatically resets at 32°F.

4 - Low Pressure Switch

Opens control circuit at 20 psig suction pressure and automatically resets at 50 psig.

5 - Fuses (2)

The 3 amp fuses protect the inwinding thermostat from damage.

6 - Internal Thermostat

Consists of 2 inwinding devices which protect the motor windings from overheating. It may take up to an hour for reset once tripped.

L6 (HS7-1853)

The compressor runs at 1750 RPM on low speed and 3500 RPM on high speed. Figure 8 shows the motor winding circuits for high and low speed. The compressor is protected by a series of controls, located in the compressor make-up box, which monitor the system. They shut down the compressor during abnormal operation.

1 - Protection Module

Three thermal sensors embedded within the compressor windings change resistance in direct relationship to

temperature change. The resistance readings of the sensors are calibrated to trip the control module at unsafe temperatures. The module will remain locked out until the resistance drops below the cut-in value. The module locks out at 107 ohms (230°F) and resets at 96 ohms (180°).

To check module, provide a cooling demand and jumper the control circuit to bypass M1 and M2. If compressor operates, the module is open. Check resistance of thermal sensors and compare to table. If compressor does not run, another component is open. See Figure 9.

2 - Low Pressure Switch (S3)

Opens control circuit at 20 psig suction pressure and automatically resets at 50 psig.

3 - High Pressure Switch (S5)

Opens control circuit at 410 psig head pressure. Automatically resets.

4 - Ambient Thermostat (S6)

This thermostat opens control circuit at 22°F ambient and automatically resets at 32°F.

C - Condenser Coil

Air draws through the coil and is discharged through the top of unit. For fan service access, remove the bolts securing fan assembly. Figure 10 illustrates the condenser fan and motor assemblies.

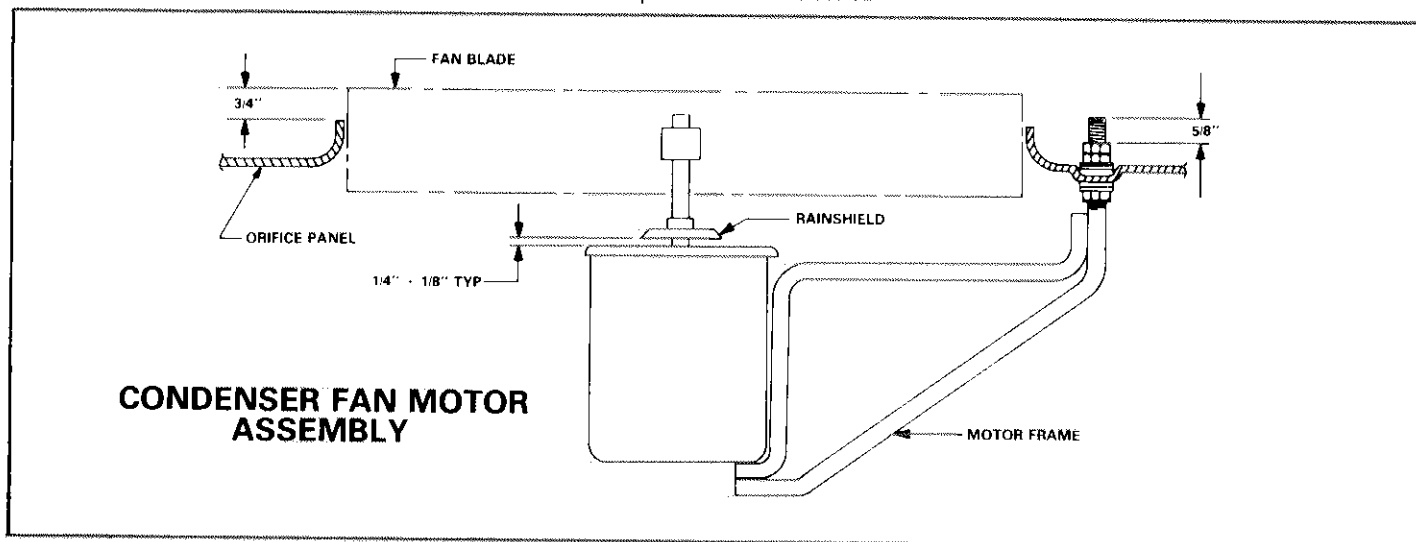

FIGURE 10

V - CHECKING L6 COMPRESSOR WINDINGS

Turn off power to unit and remove all wiring from compressor terminals. Using an ohm meter set on scale R x 10K, check windings for grounds and open circuits. Refer to Figure 11.

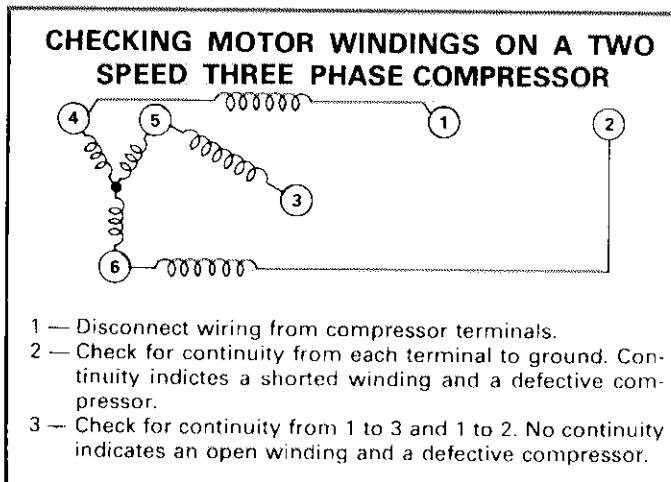
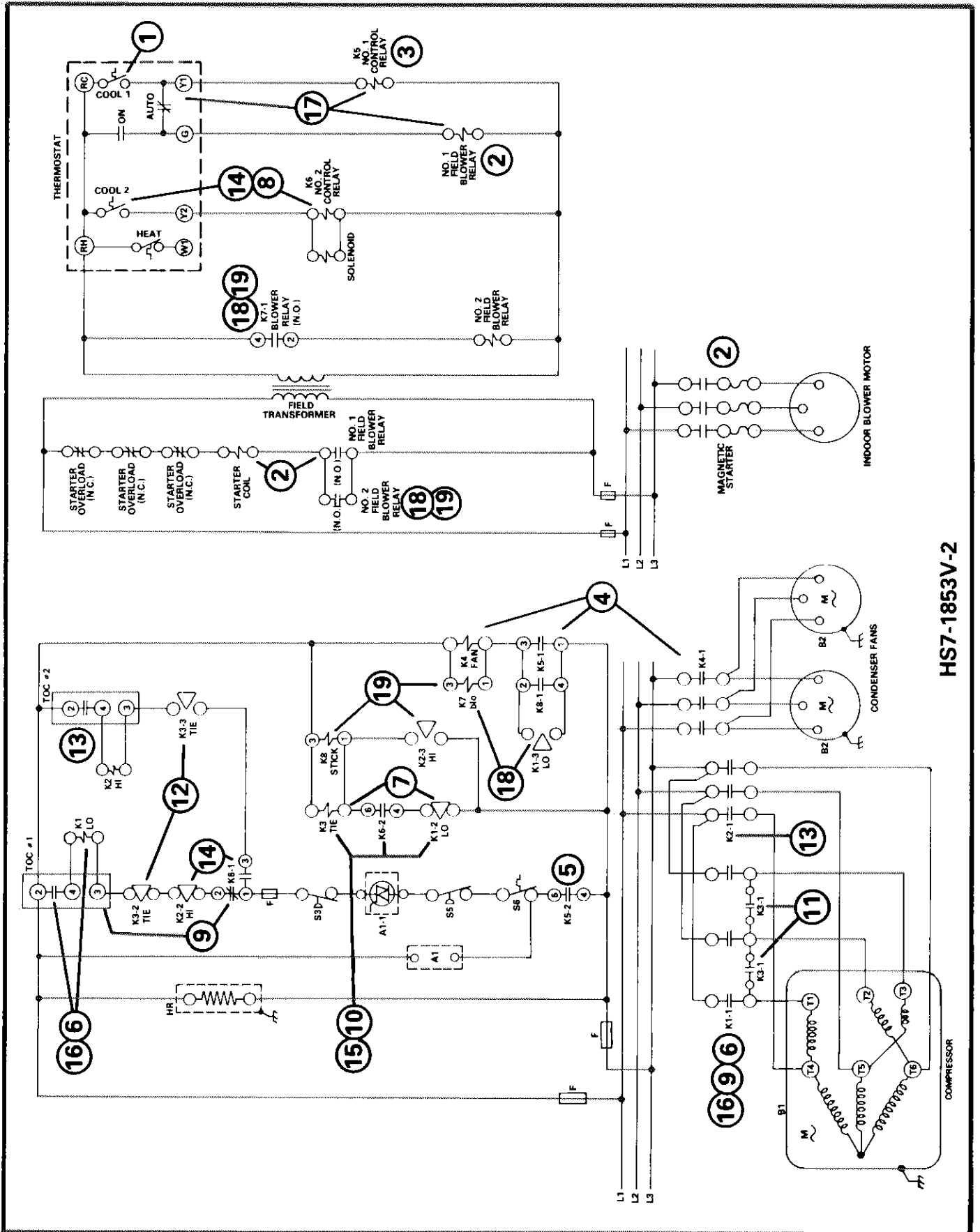

FIGURE 11

VI - SCHEMATIC WIRING DIAGRAM OPERATING SEQUENCE

A-HS7-1853 Operation (Figure 12)

- 1 - On a demand the first stage cooling bulb makes at the thermostat initiating a call for cooling.
 - 2 - If the thermostat is set on "Auto", the No. 1 Field Blower Relay is energized. This relay closes its N.O. contacts to then energize the Magnetic Starter Coil. The Magnetic Starter closes its N.O. contacts to power the Indoor Blower Motor.
 - 3 - As the first stage cooling bulb makes, it also energizes K5 (No. 1 Control Relay).
 - 4 - K5-1 N.O. contacts close to energize K4 (Fan contactor). The Fan Contactor then energizes the condenser fans.
 - 5 - K5 also closes its K5-2 (N.O.) contacts to complete a circuit to the No. 1 Timed Off Control through:
Compressor Protection Circuit — (S6,S5,A1,S3,F)
K6-1 (N.C.) — No. 2 Control Relay
K2-2 (N.C.) — K2 Mechanical Interlock
K3-2 (N.C.) — Tie Mechanical Interlock
 - 6 - 20 Seconds after the No. 1 Timed Off Control is powered, it energizes K1 (Low Speed Compressor Contactor).
K1-1 N.O. contacts close to energize compressor on low speed. The compressor windings form a series "y" circuit.
 - 7 - The K1-2 N.C. interlock opens to prevent K3 (Tie Contactor) from being energized and trying to switch compressor to high speed.
 - 8 - On an increased cooling demand, the second stage cooling bulb makes to energize K6 (No. 2 Control Relay) and solenoid valve at evaporator.
 - 9 - K6-1 N.C. contacts open to de-energize No. 1 Timed Off Control, K1 and compressor. The N.O. contacts close.
 - 10 - K6-2 N.O. contacts close to energize K3 (Tie Contactor) through N.C. K1-2 interlock.
 - 11 - K3-1 N.O. contacts close to form a parallel "y" circuit through the compressor windings.
 - 12 - N.C. K3-2 interlock opens to lock out low speed circuit.
K3-3 N.O. interlock closes to complete the circuit to the No. 2 Timed Off Control through:
K5-2 (N.O.) — No. 1 Control Relay (still energized)
- Compressor Protection Circuit
- K6-1 (N.O.) — No. 2 Control Relay (energized in step 9)
- 13 - 20 Seconds after the No. 2 Timed Off Control is powered, it energizes K2 (High Speed Compressor Contactor).
K2-1 N.O. contacts close to energize compressor on high speed. K2-2 N.C. interlock also opens to insure that the low speed compressor circuit remains de-energized.
 - 14 - As the second stage cooling demand is satisfied, the thermostat breaks the circuit to K6. K6-1 returns to normal position to de-energize K2. K2-1 opens circuit to compressor. K2-2 interlock returns to its N.C. position. K2-3 interlock returns to its N.O. position.
 - 15 - K6-2 also returns to its N.O. position to de-energize K3. K3-1 contacts open to again form a series "y" circuit through compressor windings. K3-2 interlock returns to its N.C. position. K3-3 interlock returns to its N.O. position.
 - 16 - With K6-1 contacts in the N.C. position, a circuit is completed to the No. 1 Timed off Control. If the original cycle was less than 5 minutes, the control will wait the remaining time. 20 seconds later K1 is again energized to power the compressor on low speed.
 - 17 - When the cooling demand is satisfied, the thermostat de-energizes K5 and No. 1 Field Blower Relay to shut down the equipment.
- WELDED CONTACTS
- 18 - Should K1-1 contacts weld, K1-3 interlock remains closed. This energizes K4 to keep condenser fan motors running. It also energizes K7 (Blower Relay). K7-1 N.O. contacts close to then energize No. 2 Field Blower Relay. This energizes the indoor blower motor circuit.
 - 19 - Should K2-1 contacts weld, K2-3 interlock remains closed. This energizes K8 (stick Relay). K8-1 N.O. contacts close energizing K4 to keep condenser fan motors running. K8-1 also energizes K7. K7-1 N.O. contacts close to then energize the No. 2 Field Blower Relay. This energizes the indoor blower motor circuit.



HS7-1853V-2

FIGURE 12

B-HS7-2753 Operation (Figure 13)

- 1 - On a demand the first stage cooling bulb makes at the thermostat initiating a call for cooling.
 - 2 - If the thermostat is set on "Auto", the Field Blower Relay is energized. This relay closes its N.O. contacts to then energize the Magnetic Starter coil. The Magnetic Starter closes its N.O. contacts to power the Indoor Blower Motor.
 - 3 - As the first stage cooling bulb makes, it also energizes K7 (Fan Control Relay) and K5 (No. 1 Control Relay through N.C. K8-1 contacts.
 - 4 - K7-1 N.O. contacts close to energize K4 (Fan Contactor). The Fan Contactor then energizes the Condenser Fans.
 - 5 - K5-1 N.O. contacts close to allow second stage cooling operation.
 - 6 - K5-2 N.C. contacts open to prevent K8 (Stick Relay) from being energized. K5-2 N.O. contacts close to complete a circuit to the No. 1 Timed Off Control through the L2 compressor protection:
 - Compressor Overloads
 - High Pressure Switch
 - Ambient Thermostat
 - Low Pressure Switch
 - Fuses
 - Internal Thermostats
 - 7 - 20 Seconds after the No. 1 Timed Off Control is powered it energizes K1 (No. 1 Compressor Contactor). K1-1 N.O. contacts close to power No. 1 compressor. K1-2 N.O. interlock closes.
 - 8 - On an increased cooling demand, the second stage cooling bulb makes to energize K6 (No. 2 Control Relay) through K5-1. This assures that Compressor 2 will not come on unless compressor 1 control circuit is energized.
 - 9 - K6-2 N.C. contacts open to prevent K8 from being energized. K6-2 N.O. contacts close to complete a circuit to the No. 2 Timed Off Control through the L2 compressor protection.
 - 10 - 20 Seconds after the No. 2 Timed Off Control is powered it energizes K2 (No. 2 Compressor Contactor). K2-1 N.O. contacts close to power No. 2 Compressor. K2-2 N.O. interlock closes.
 - 11 - As the second stage cooling demand is satisfied, the thermostat breaks the circuit to K6. K6-1 returns to N.O. position to de-energize K2 and Compressor 2.
 - 12 - When the cooling demand is completely satisfied, the thermostat de-energizes K5, K7 and Field Blower Relay to shut down the equipment.
 - 13 - If the original cycle was less than 5 minutes, the timed off control will wait the remaining time plus 20 seconds on the next demand.
- WELDED CONTACTS**
- 14 - Should K1-1 contacts weld, K1-2 interlock remains closed to energize K8 through K5-2 N.C. contacts. Should K2-1 contacts weld, K2-2 interlock remains closed to energize K8 through K6-1 N.C. contacts.
 - 15 - K8-1 N.C. contact opens to lock out the compressor control circuits. K8-1 N.O. contacts close to energize K7 to keep the condenser fans operating.

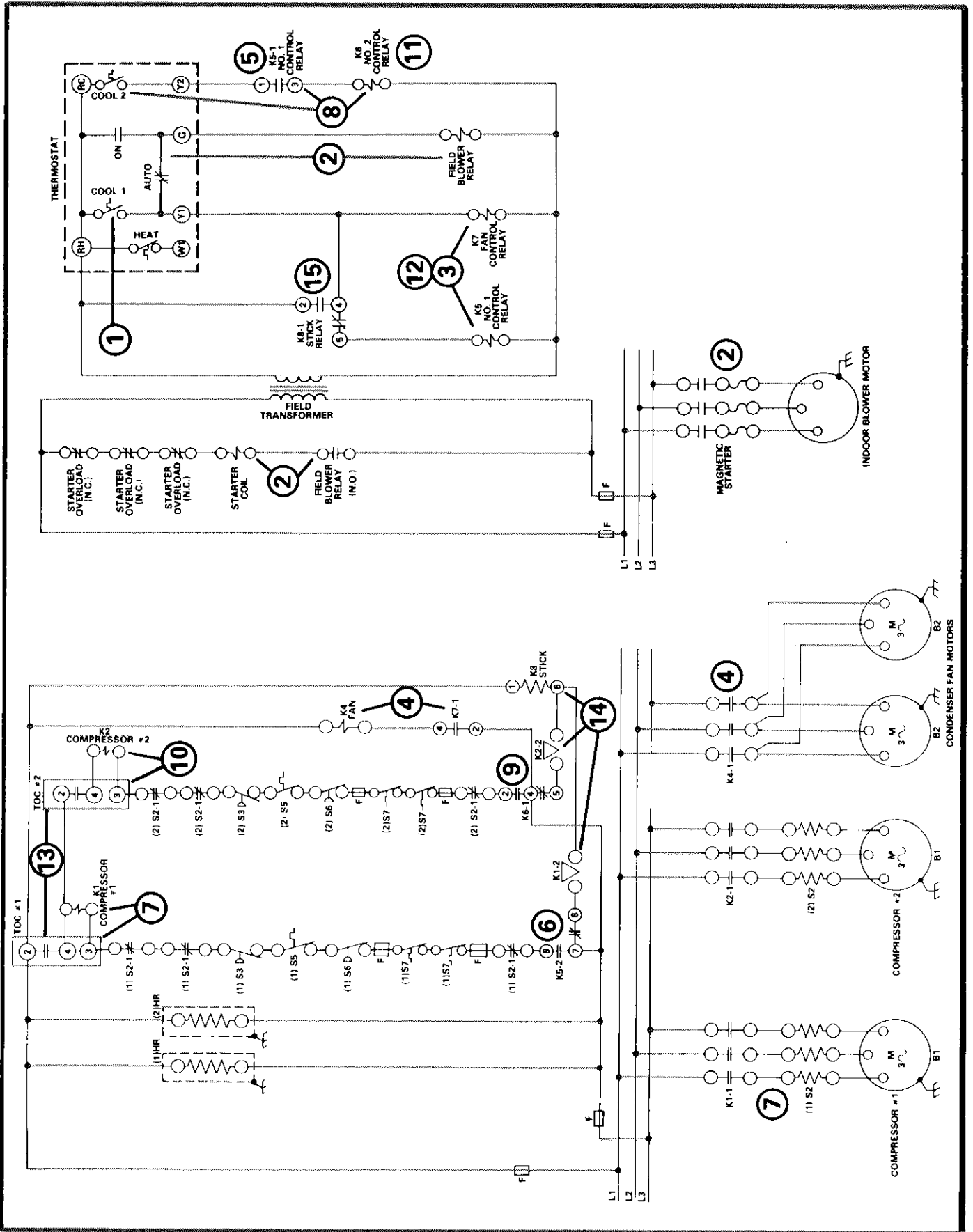

FIGURE 13