

DSS1 SERIES SINGLEZONE SYSTEM

operation and maintenance manual

Unit Models: 180 and 260

LENNOX *Industries Inc.*

Price \$3.00

ROOFTOP UNITS
501,312 M
6/79

INTRODUCTION

This manual is written as a guide for sales, service and maintenance personnel involved in the operation and maintenance of the DSS1 Singlezone Unit. We recommend all personnel utilize this manual to become familiar with the operation of the unit so basic service and maintenance can be capably performed.

TABLE OF CONTENTS

I - GENERAL INFORMATION

| | |
|--|--------|
| A - BASIC DSS1 SEQUENCE OF OPERATION | PAGE 2 |
| B - GENERAL SCHEMATIC WIRING INFORMATION | PAGE 5 |
| C - START-UP AND PERFORMANCE CHECK LIST | PAGE 7 |
| D - DSS1 PREVENTIVE MAINTENANCE GUIDE | PAGE 8 |

II - ELECTRONIC SYSTEM CONTROL

III - HEATING

| | |
|---|---------|
| A - ELECTRIC HEAT | PAGE 21 |
| B - HOT WATER HEAT | PAGE 23 |
| C - SUPERMARKET HEAT RECLAIM (ON COOLING UNITS ONLY)..... | PAGE 25 |

IV - COOLING

| | |
|------------------------------|---------|
| A - POWER SAVER..... | PAGE 26 |
| B - REFRIGERANT COOLING..... | PAGE 29 |

V - HEAT PUMP

VI - BLOWERS

| | |
|--|---------|
| A - FIRE STATS AND AIR VOLUME ADJUSTMENT..... | PAGE 38 |
| B - GENERAL INFORMATION FOR LENNOX BLOWER ASSEMBLIES | PAGE 44 |

VII - FILTERS

VIII - SERVICE FLOW CHARTS

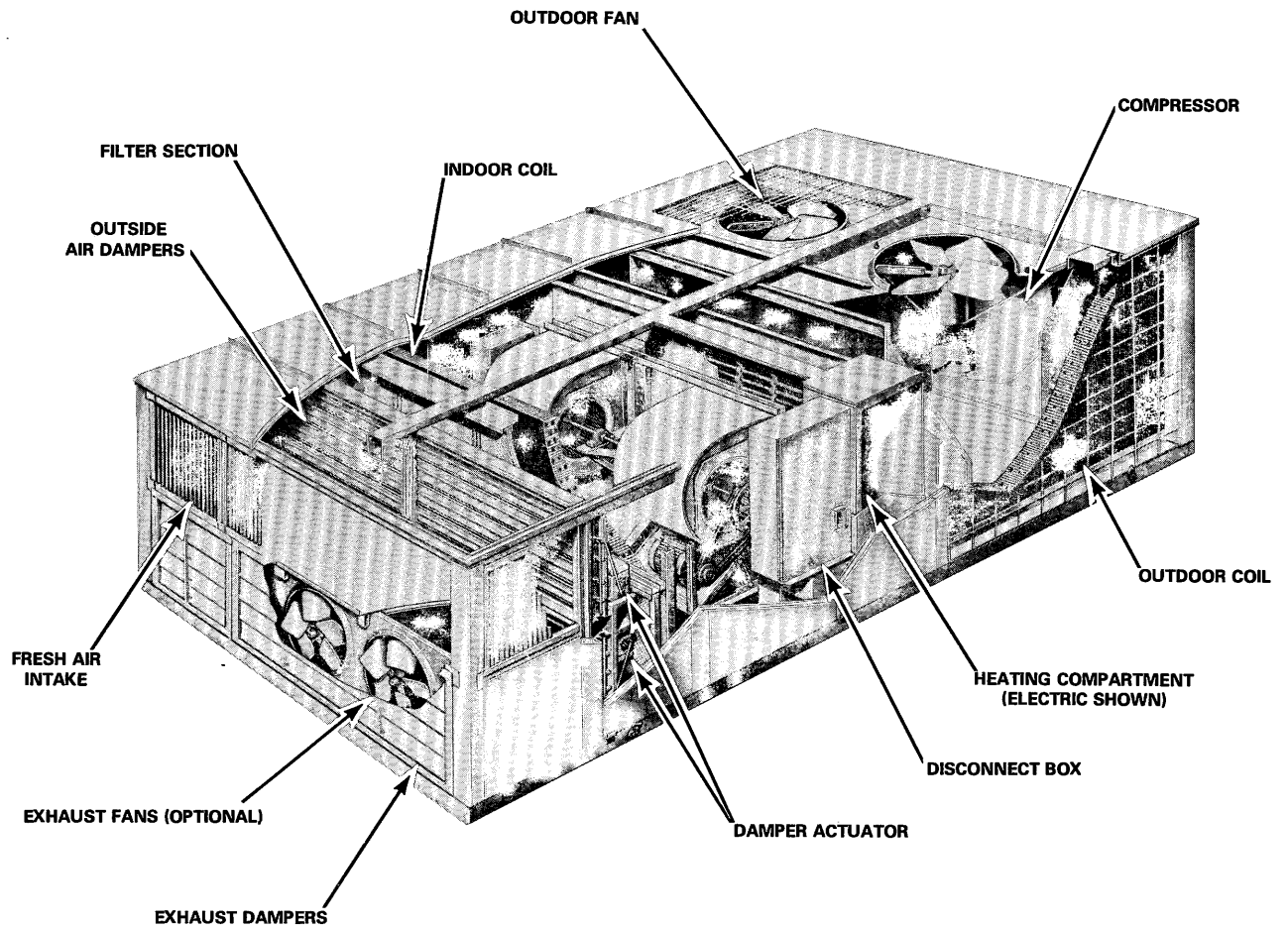

DSS1—180/260 (176'')

BASIC DSS1 SEQUENCE OF OPERATION

I - BLOWER OPERATION

- 1 - Supply blower runs continuously under normal operation. The optional nite setback controls cycle blower in response to heating demands during night operation. When heat demand is satisfied, a time delay relay allows blower to run until all useable heat dissipates.
- 2 - Return air blower (optional) runs whenever the supply blower is operating. Exhaust fans (optional) run only when main blower is on and return air dampers are closed.
- 3 - Fire protection thermostat is located in the blower compartment downstream of evaporator coil and air filters. A second thermostat is also located in the return air compartment. If an abnormal temperature occurs in either of these locations, all unit operation will terminate. Firestats omitted in units with smoke detection.
- 4 - All other systems are dependent upon blower operation. The air proving switch (not used on heat pump units), is located on main blower housing. This senses any blower failure and shuts down all systems within the unit.
- 5 - Sensing the presence of smoke, the supply and return smoke detection systems (optional) terminate heating and cooling functions and provide 2 options of controlling blower and damper operation. See Figure 1.

Option 1 - "Shutdown"

- a - Supply blower stops
- b - Return blower or exhaust fans stop
- c - Outside dampers close
- d - Return dampers close

Option 2 - "Exhaust"

- a - Supply blower stops
- b - Return blower or exhaust fans run
- c - Outside dampers close
- d - Return dampers close

Upon power failure or anytime unit is shut down, blowers stop and the return and outside dampers close. An optional remote smoke detector test station simulates smoke conditions to check performance of each smoke detector. When smoke detector is reset or anytime unit is started, a time delay relay in the blower circuit allows time for dampers to open before supply blower begins operation. A direct acting actuator drives outside dampers while a reverse acting actuator drives return air dampers.

II - THE LENNOX ELECTRONIC ENERGY SAVING SYSTEM

DSS1 units are equipped with a solid state control system which cycles the unit to match its output to load requirements.

Two air temperature sensors are used: one located in the conditioned space (room sensor) and one mounted in unit discharge opening (discharge sensor). A solid-state electronic circuit compares temperatures at room sensor and discharge air sensor with the desired room temperature set point to control unit heating and cooling functions. Refer to Figure 2.

As room temperature changes from room sensor set point, unit will respond to satisfy the demand. On a change in discharge air temper-

GENERAL

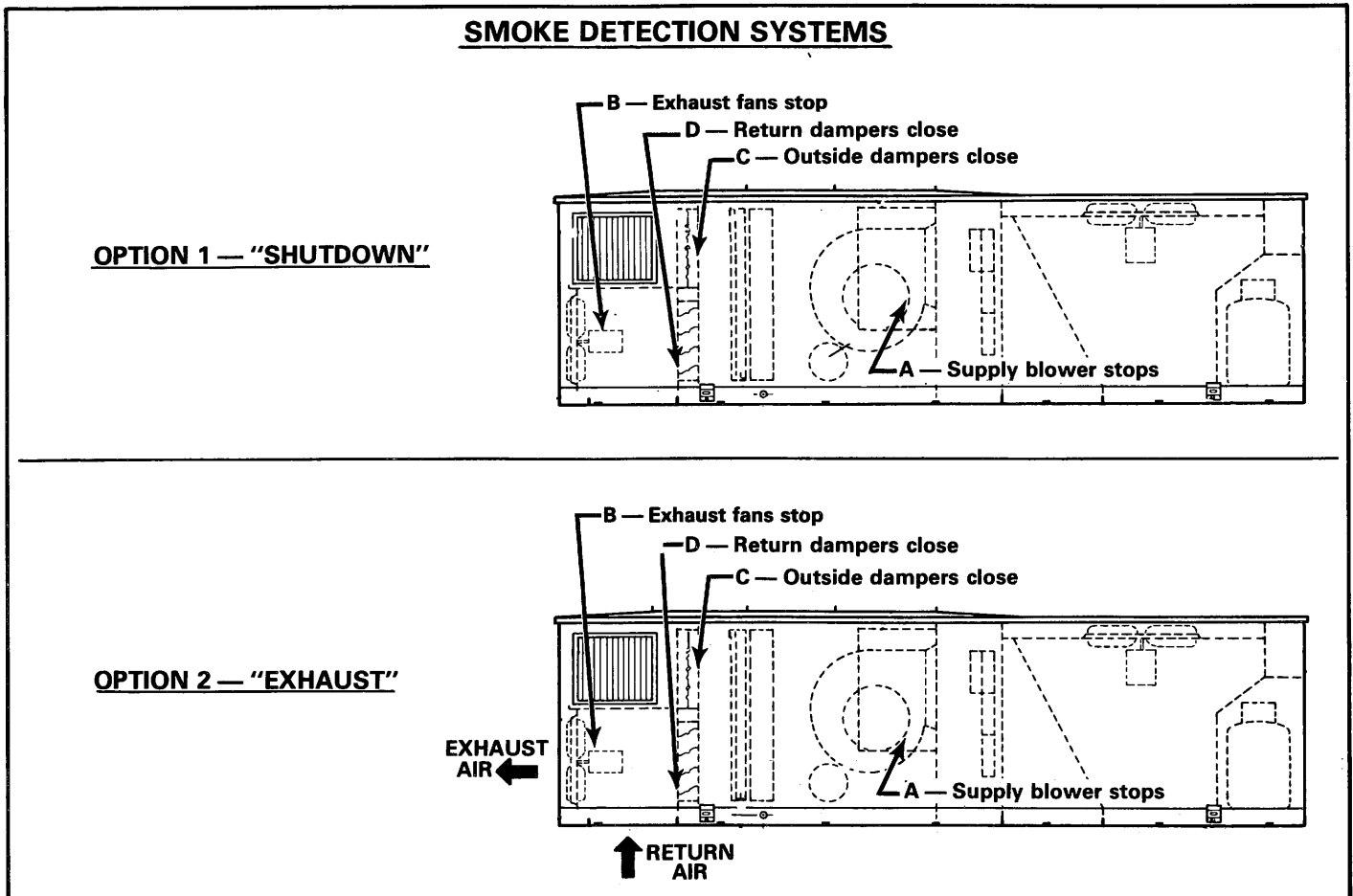

FIGURE 1

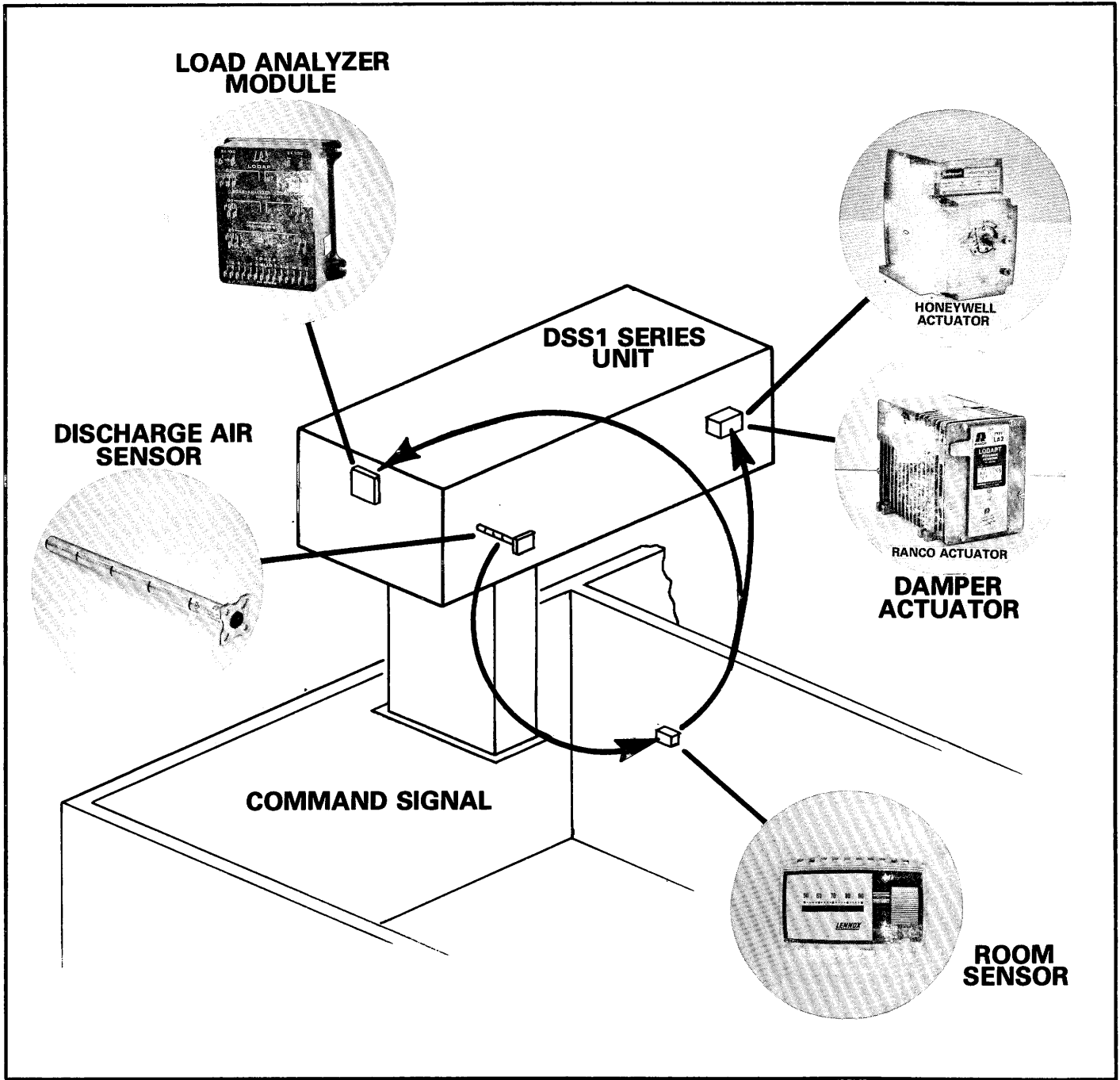

FIGURE 2

ature, electronic circuit will readjust in anticipation of the effect on room temperature. If demand from the conditioned space is not of sufficient magnitude to actuate either heating or cooling functions, systems will coast with only the blowers running.

III - ELECTRIC HEAT

Electric heaters range in size from 30 to 120 KW. Each element has a 15 KW capacity. Electric heat sequence time delay relays control stepping of elements to satisfy heating demand. A lockout relay de-energizes compressor circuits to prevent overloading main switch when electric heat is on. Two high temperature limit switches in the airstream and thermal safety devices for each element guard against over-heating. A time delay circuit guards against short-cycling.

IV - HOT WATER HEAT

An optional motorized valve is used to control hot water flow in the system.

- 1 - The motorized three way valve is used to direct hot water through coil or to by-pass coil.
 - a - A heating demand will open the valve in proportion to the load.
- 2 - Coil is equipped with an air bleed valve and a drain valve.
- 3 - A freeze protection thermostat monitors coil manifold temperature and opens valve at a set point to prevent coil freezing during a no-demand condition. Also outside air dampers (if used) will close.
- 4 - A manual balancing valve is provided for balancing the pressure drop of the by-pass line to the coil pressure drop.

V - LENNOX POWER SAVER ®

- 1 - The power saver consists of outside and return air dampers. These dampers open and close in reverse relationship to each other. A cooling demand modulates outside dampers open. If fresh air cannot satisfy demand, mechanical cooling will be engaged.
- 2 - Power saver actuator has a minimum air adjustment for setting a specific amount of continuous fresh air when desired.
- 3 - The enthalpy control senses both temperature and humidity (heat content) of outdoor air. When heat content rises above control set point, outside dampers close to minimum position.
- 4 - Morning warm-up control, in units with night setback, holds outside dampers at the closed position until return air temperature has risen above set point of control.
- 5 - Any time unit is shut down, outside air dampers are in the fully closed position. Units with smoke detection also close return air dampers when unit is shut down.
- 6 - The sandstorm switch (optional) is a manual switch located remote from the unit which closes outside dampers.

VI - REFRIGERANT COOLING AND HEAT PUMP

Operating sequence functions vary according to unit size and options. For a detailed operating sequence, refer to "Function Chart" section on page 10.

- 1 - Units are equipped with two single speed compressors. Each compressor has an individual refrigerant circuit.
- 2 - The large casing, spring loaded discharge valve, high suction intake ports and crankcase heater result in effective "slugging" protection. On heat pump units a belly band crankcase heater is furnished for extra slugging protection at low ambients.
- 3 - Twin internally mounted motor in-winding temperature sensing thermostats provide safe operation. On straight cooling units, a low ambient sensor (located in compressor terminal box) allows no compressor operation below 22°F. High and low pressure controls (automatic reset) are furnished in compressor terminal box.
- 4 - On units equipped with power saver, the compressor monitor locks out compressors when outdoor air falls below set point of monitor. Cooling units without powersaver option can be

ordered with a low ambient kit to extend compressor operation down to 0°F.

- 5 - On heat pump units, each refrigerant circuit is equipped with a reversing valve to change the refrigerant flow circuit for heating and cooling modes. The reversing valve is energized during the cooling and defrost cycles and de-energized during the heating cycle.

VII - DEHUMIDIFICATION/REHEAT OPTION (NOT USED ON HEAT PUMP UNITS)

This factory installed option (first stage only) provides a reheat coil, installed downstream from evaporator coil, which utilizes condenser heat to prevent overcooling during dehumidification. An adjustable humidistat, located in return air stream, senses relative humidity level and activates refrigerant system when relative humidity exceeds humidistat setting. The reheat coil temperature is controlled by staging the condenser fan. If space cooling is required, the reheat coil is deactivated by solenoid valves.

VIII - SUPERMARKET HEAT RECLAIM (NOT USED ON HEAT PUMP UNITS)

The refrigerant heat reclaim coil is a factory installed option located downstream from the evaporator coil. This option serves as a condenser coil for the supermarket coolers and the heat rejected from it is utilized for space heating the installation. The supermarket reclaim coil capacities range from 162,000 to 455,000 BTUH. Actual capacity will vary with unit design and application.

Operation of the reclaim coil is controlled by the load analyzer module. When a heating demand is received the reclaim coil is activated. If additional heating is required the load analyzer module starts the primary heat source.

NOTE – The load analyzer will control two stages of reclaim and one stage of primary heat source. Part of the electric heat will be locked out above the setting of the thermostat in the return air stream.

Units equipped with supermarket heat reclaim option are designed to use the reclaim coil and unit refrigerant cooling system as a dehumidification/reheat system also.

GENERAL SCHEMATIC WIRING INFORMATION

- 1 - The DSS1 schematic wiring diagram format incorporates horizontal power lines which separate the line voltage circuit (motors-compressors-electric elements) from controlling circuit. Motors, compressors and electric elements are located below power lines with controlling circuit directly above the line.
- 2 - The graphic symbols for components and code lettering conforms to the "IEEE Standard and American National Standard" of graphic symbols for electrical diagrams. All symbols and code lettering used are approved by the International Electrotechnical Commission (IEC). Refer to Figure 3 for code and symbol identification.
- 3 - Terminal numbers on jacks and plugs are located by a ridge on the corner of the plug called the "Key." Refer to Figure 4 for proper numbering sequence.

- 4 - A component index chart is provided on each diagram which includes -
 - Code numbers (Key).
 - Description of component.
 - Location of component. See Example A in Figure 5.
 - Cross reference to other diagram sections. See Example B in Figure 5.
- 5 - Jacks and plugs are shown in the schematic circuit by both jack-plug number and terminal number. In Example C of Figure 5, JP3-12 indicates jack-plug number 3 and terminal number 12.
- 6 - Optional circuits are shown with arrow connections. See Example D of Figure 5.
- 7 - Solid lines around a control indicate a complete control — Example E. Dashed lines around a control indicates only a part of a control — Example F.

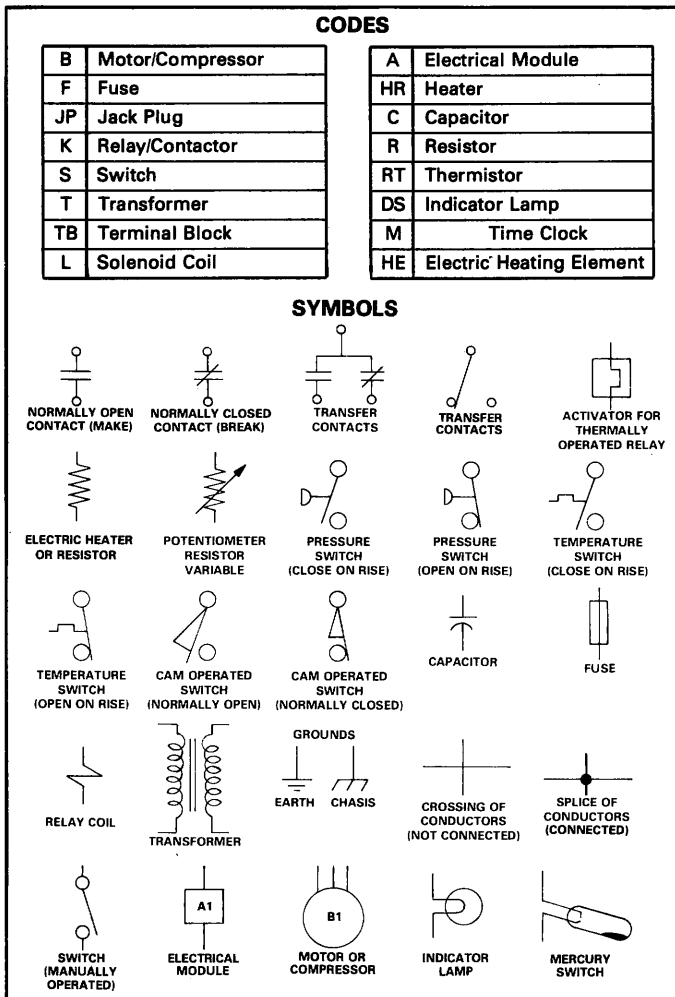

FIGURE 3

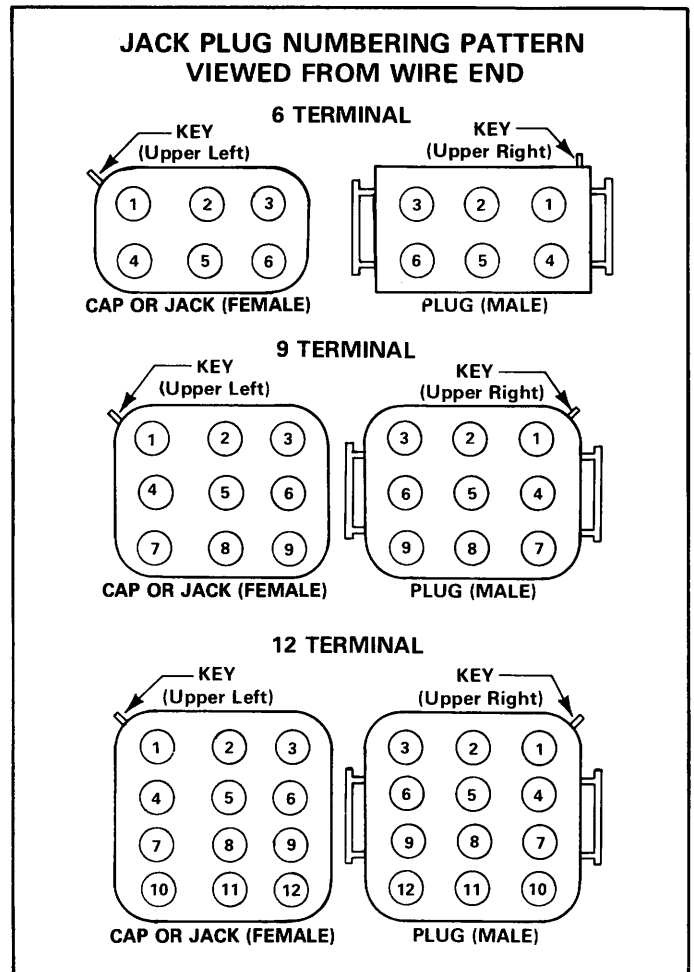
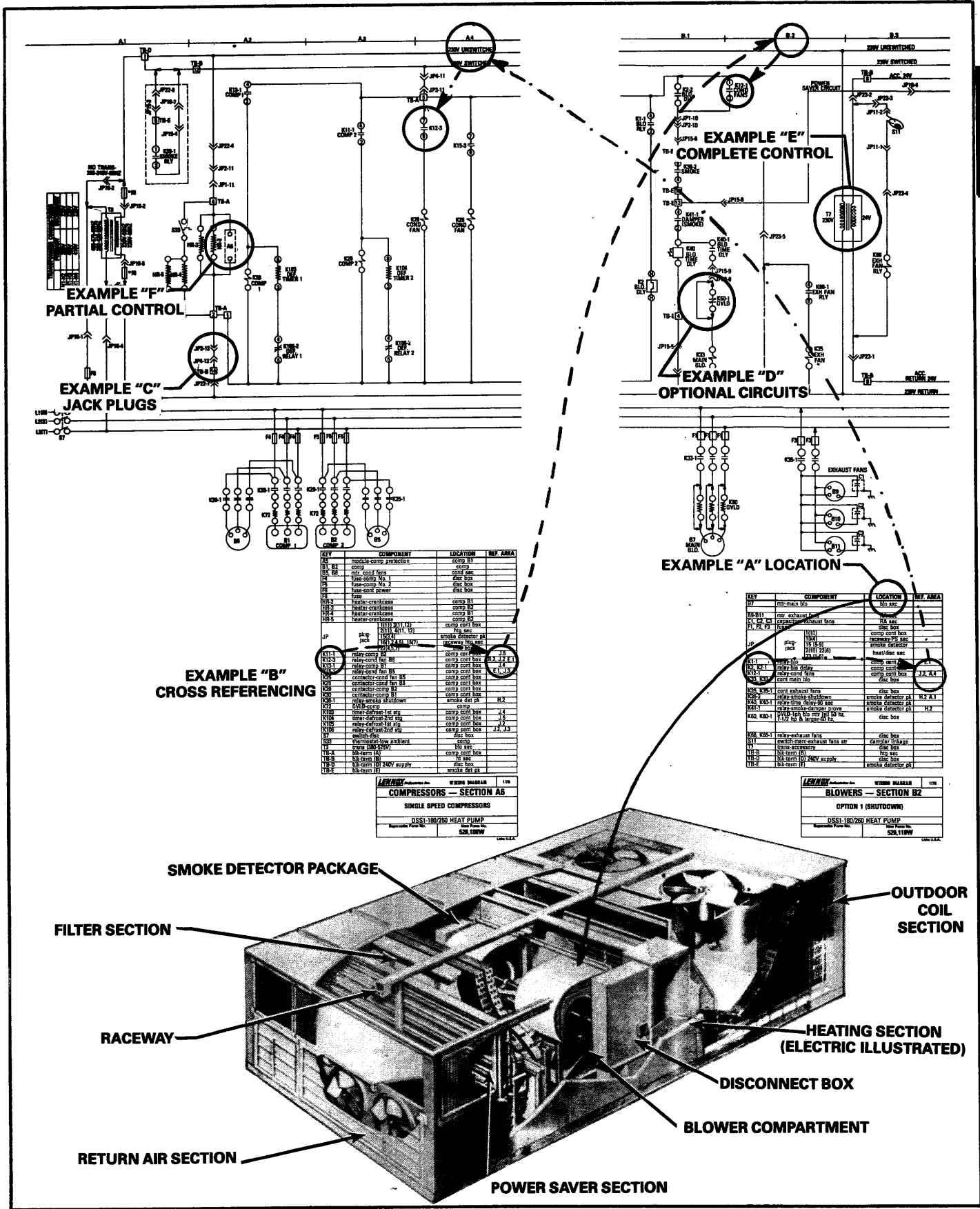

FIGURE 4



| KEY | COMPONENT | LOCATION | REF. AREA |
|-----|-------------------------|-------------------|-----------|
| 12 | module-comp. protection | comp. B1 | |
| 13 | comp. | comp. | |
| 14 | oil comp. fans | disc box | |
| 15 | trans-comp. No. 1 | disc box | |
| 16 | trans-comp. No. 2 | disc box | |
| 17 | trans-comp. power | disc box | |
| 18 | fan | | |
| 19 | heater-crankcase | comp. B1 | |
| 20 | heater-crankcase | comp. B2 | |
| 21 | heater-crankcase | comp. B3 | |
| 22 | heater-crankcase | comp. B4 | |
| 23 | heater-crankcase | comp. B5 | |
| 24 | plug | 11111, 1111, 1121 | |
| 25 | plug | 11211, 1111, 1121 | |
| 26 | plug | 11211, 1111, 1121 | |
| 27 | relay-comp. B1 | comp. cont. box | |
| 28 | relay-comp. B2 | comp. cont. box | |
| 29 | relay-comp. B3 | comp. cont. box | |
| 30 | relay-comp. B4 | comp. cont. box | |
| 31 | relay-comp. B5 | comp. cont. box | |
| 32 | contactor-comp. fan B1 | comp. cont. box | |
| 33 | contactor-comp. fan B2 | comp. cont. box | |
| 34 | contactor-comp. fan B3 | comp. cont. box | |
| 35 | contactor-comp. fan B4 | comp. cont. box | |
| 36 | contactor-comp. fan B5 | comp. cont. box | |
| 37 | relay-merch. shut-down | disc. box | |
| 38 | DUV-comp. | comp. cont. box | H.2 |
| 39 | temp-sensor-1st stg. | comp. cont. box | H.2 |
| 40 | temp-sensor-2nd stg. | comp. cont. box | H.2 |
| 41 | temp-sensor-3rd stg. | comp. cont. box | H.2 |
| 42 | temp-sensor-4th stg. | comp. cont. box | H.2 |
| 43 | temp-sensor-5th stg. | comp. cont. box | H.2 |
| 44 | temp-sensor-6th stg. | comp. cont. box | H.2 |
| 45 | temp-sensor-7th stg. | comp. cont. box | H.2 |
| 46 | temp-sensor-8th stg. | comp. cont. box | H.2 |
| 47 | temp-sensor-9th stg. | comp. cont. box | H.2 |
| 48 | temp-sensor-10th stg. | comp. cont. box | H.2 |
| 49 | temp-sensor-11th stg. | comp. cont. box | H.2 |
| 50 | temp-sensor-12th stg. | comp. cont. box | H.2 |
| 51 | temp-sensor-13th stg. | comp. cont. box | H.2 |
| 52 | temp-sensor-14th stg. | comp. cont. box | H.2 |
| 53 | temp-sensor-15th stg. | comp. cont. box | H.2 |
| 54 | temp-sensor-16th stg. | comp. cont. box | H.2 |
| 55 | temp-sensor-17th stg. | comp. cont. box | H.2 |
| 56 | temp-sensor-18th stg. | comp. cont. box | H.2 |
| 57 | temp-sensor-19th stg. | comp. cont. box | H.2 |
| 58 | temp-sensor-20th stg. | comp. cont. box | H.2 |
| 59 | temp-sensor-21st stg. | comp. cont. box | H.2 |
| 60 | temp-sensor-22nd stg. | comp. cont. box | H.2 |
| 61 | temp-sensor-23rd stg. | comp. cont. box | H.2 |
| 62 | temp-sensor-24th stg. | comp. cont. box | H.2 |
| 63 | temp-sensor-25th stg. | comp. cont. box | H.2 |
| 64 | temp-sensor-26th stg. | comp. cont. box | H.2 |
| 65 | temp-sensor-27th stg. | comp. cont. box | H.2 |
| 66 | temp-sensor-28th stg. | comp. cont. box | H.2 |
| 67 | temp-sensor-29th stg. | comp. cont. box | H.2 |
| 68 | temp-sensor-30th stg. | comp. cont. box | H.2 |
| 69 | temp-sensor-31st stg. | comp. cont. box | H.2 |
| 70 | temp-sensor-32nd stg. | comp. cont. box | H.2 |
| 71 | temp-sensor-33rd stg. | comp. cont. box | H.2 |
| 72 | temp-sensor-34th stg. | comp. cont. box | H.2 |
| 73 | temp-sensor-35th stg. | comp. cont. box | H.2 |
| 74 | temp-sensor-36th stg. | comp. cont. box | H.2 |
| 75 | temp-sensor-37th stg. | comp. cont. box | H.2 |
| 76 | temp-sensor-38th stg. | comp. cont. box | H.2 |
| 77 | temp-sensor-39th stg. | comp. cont. box | H.2 |
| 78 | temp-sensor-40th stg. | comp. cont. box | H.2 |
| 79 | temp-sensor-41st stg. | comp. cont. box | H.2 |
| 80 | temp-sensor-42nd stg. | comp. cont. box | H.2 |
| 81 | temp-sensor-43rd stg. | comp. cont. box | H.2 |
| 82 | temp-sensor-44th stg. | comp. cont. box | H.2 |
| 83 | temp-sensor-45th stg. | comp. cont. box | H.2 |
| 84 | temp-sensor-46th stg. | comp. cont. box | H.2 |
| 85 | temp-sensor-47th stg. | comp. cont. box | H.2 |
| 86 | temp-sensor-48th stg. | comp. cont. box | H.2 |
| 87 | temp-sensor-49th stg. | comp. cont. box | H.2 |
| 88 | temp-sensor-50th stg. | comp. cont. box | H.2 |
| 89 | temp-sensor-51st stg. | comp. cont. box | H.2 |
| 90 | temp-sensor-52nd stg. | comp. cont. box | H.2 |
| 91 | temp-sensor-53rd stg. | comp. cont. box | H.2 |
| 92 | temp-sensor-54th stg. | comp. cont. box | H.2 |
| 93 | temp-sensor-55th stg. | comp. cont. box | H.2 |
| 94 | temp-sensor-56th stg. | comp. cont. box | H.2 |
| 95 | temp-sensor-57th stg. | comp. cont. box | H.2 |
| 96 | temp-sensor-58th stg. | comp. cont. box | H.2 |
| 97 | temp-sensor-59th stg. | comp. cont. box | H.2 |
| 98 | temp-sensor-60th stg. | comp. cont. box | H.2 |
| 99 | temp-sensor-61st stg. | comp. cont. box | H.2 |
| 100 | temp-sensor-62nd stg. | comp. cont. box | H.2 |
| 101 | temp-sensor-63rd stg. | comp. cont. box | H.2 |
| 102 | temp-sensor-64th stg. | comp. cont. box | H.2 |
| 103 | temp-sensor-65th stg. | comp. cont. box | H.2 |
| 104 | temp-sensor-66th stg. | comp. cont. box | H.2 |
| 105 | temp-sensor-67th stg. | comp. cont. box | H.2 |
| 106 | temp-sensor-68th stg. | comp. cont. box | H.2 |
| 107 | temp-sensor-69th stg. | comp. cont. box | H.2 |
| 108 | temp-sensor-70th stg. | comp. cont. box | H.2 |
| 109 | temp-sensor-71st stg. | comp. cont. box | H.2 |
| 110 | temp-sensor-72nd stg. | comp. cont. box | H.2 |
| 111 | temp-sensor-73rd stg. | comp. cont. box | H.2 |
| 112 | temp-sensor-74th stg. | comp. cont. box | H.2 |
| 113 | temp-sensor-75th stg. | comp. cont. box | H.2 |
| 114 | temp-sensor-76th stg. | comp. cont. box | H.2 |
| 115 | temp-sensor-77th stg. | comp. cont. box | H.2 |
| 116 | temp-sensor-78th stg. | comp. cont. box | H.2 |
| 117 | temp-sensor-79th stg. | comp. cont. box | H.2 |
| 118 | temp-sensor-80th stg. | comp. cont. box | H.2 |
| 119 | temp-sensor-81st stg. | comp. cont. box | H.2 |
| 120 | temp-sensor-82nd stg. | comp. cont. box | H.2 |
| 121 | temp-sensor-83rd stg. | comp. cont. box | H.2 |
| 122 | temp-sensor-84th stg. | comp. cont. box | H.2 |
| 123 | temp-sensor-85th stg. | comp. cont. box | H.2 |
| 124 | temp-sensor-86th stg. | comp. cont. box | H.2 |
| 125 | temp-sensor-87th stg. | comp. cont. box | H.2 |
| 126 | temp-sensor-88th stg. | comp. cont. box | H.2 |
| 127 | temp-sensor-89th stg. | comp. cont. box | H.2 |
| 128 | temp-sensor-90th stg. | comp. cont. box | H.2 |
| 129 | temp-sensor-91st stg. | comp. cont. box | H.2 |
| 130 | temp-sensor-92nd stg. | comp. cont. box | H.2 |
| 131 | temp-sensor-93rd stg. | comp. cont. box | H.2 |
| 132 | temp-sensor-94th stg. | comp. cont. box | H.2 |
| 133 | temp-sensor-95th stg. | comp. cont. box | H.2 |
| 134 | temp-sensor-96th stg. | comp. cont. box | H.2 |
| 135 | temp-sensor-97th stg. | comp. cont. box | H.2 |
| 136 | temp-sensor-98th stg. | comp. cont. box | H.2 |
| 137 | temp-sensor-99th stg. | comp. cont. box | H.2 |
| 138 | temp-sensor-100th stg. | comp. cont. box | H.2 |

| LEWIS | | WINDS HALLWAY | 179 |
|------------------------------------|--|---------------|-----|
| COMPRESSORS — SECTION A3 | | | |
| SINGLE SPEED COMPRESSORS | | | |
| DSS1-180/260 HEAT PUMP | | | |
| Refrigerant Piping Size: 5/8" 120W | | | |

| KEY | COMPONENT | LOCATION | REF. AREA |
|-----|----------------|------------|-----------|
| 10 | blow-chain box | blow. sec. | |
| 11 | blow. chain | blow. sec. | |
| 12 | blow. chain | blow. sec. | |
| 13 | blow. chain | blow. sec. | |
| 14 | blow. chain | blow. sec. | |
| 15 | blow. chain | blow. sec. | |
| 16 | blow. chain | blow. sec. | |
| 17 | blow. chain | blow. sec. | |
| 18 | blow. chain | blow. sec. | |
| 19 | blow. chain | blow. sec. | |
| 20 | blow. chain | blow. sec. | |
| 21 | blow. chain | blow. sec. | |
| 22 | blow. chain | blow. sec. | |
| 23 | blow. chain | blow. sec. | |
| 24 | blow. chain | blow. sec. | |
| 25 | blow. chain | blow. sec. | |
| 26 | blow. chain | blow. sec. | |
| 27 | blow. chain | blow. sec. | |
| 28 | blow. chain | blow. sec. | |
| 29 | blow. chain | blow. sec. | |
| 30 | blow. chain | blow. sec. | |
| 31 | blow. chain | blow. sec. | |
| 32 | blow. chain | blow. sec. | |
| 33 | blow. chain | blow. sec. | |
| 34 | blow. chain | blow. sec. | |
| 35 | blow. chain | blow. sec. | |
| 36 | blow. chain | blow. sec. | |
| 37 | blow. chain | blow. sec. | |
| 38 | blow. chain | blow. sec. | |
| 39 | blow. chain | blow. sec. | |
| 40 | blow. chain | blow. sec. | |
| 41 | blow. chain | blow. sec. | |
| 42 | blow. chain | blow. sec. | |
| 43 | blow. chain | blow. sec. | |
| 44 | blow. chain | blow. sec. | |
| 45 | blow. chain | blow. sec. | |
| 46 | blow. chain | blow. sec. | |
| 47 | blow. chain | blow. sec. | |
| 48 | blow. chain | blow. sec. | |
| 49 | blow. chain | blow. sec. | |
| 50 | blow. chain | blow. sec. | |
| 51 | blow. chain | blow. sec. | |
| 52 | blow. chain | blow. sec. | |
| 53 | blow. chain | blow. sec. | |
| 54 | blow. chain | blow. sec. | |
| 55 | blow. chain | blow. sec. | |
| 56 | blow. chain | blow. sec. | |
| 57 | blow. chain | blow. sec. | |
| 58 | blow. chain | blow. sec. | |
| 59 | blow. chain | blow. sec. | |
| 60 | blow. chain | blow. sec. | |
| 61 | blow. chain | blow. sec. | |
| 62 | blow. chain | blow. sec. | |
| 63 | blow. chain | blow. sec. | |
| 64 | blow. chain | blow. sec. | |
| 65 | blow. chain | blow. sec. | |
| 66 | blow. chain | blow. sec. | |
| 67 | blow. chain | blow. sec. | |
| 68 | blow. chain | blow. sec. | |
| 69 | blow. chain | blow. sec. | |
| 70 | blow. chain | blow. sec. | |
| 71 | blow. chain | blow. sec. | |
| 72 | blow. chain | blow. sec. | |
| 73 | blow. chain | blow. sec. | |
| 74 | blow. chain | blow. sec. | |
| 75 | blow. chain | blow. sec. | |
| 76 | blow. chain | blow. sec. | |
| 77 | blow. chain | blow. sec. | |
| 78 | blow. chain | blow. sec. | |
| 79 | blow. chain | blow. sec. | |
| 80 | blow. chain | blow. sec. | |
| 81 | blow. chain | blow. sec. | |
| 82 | blow. chain | blow. sec. | |
| 83 | blow. chain | blow. sec. | |
| 84 | blow. chain | blow. sec. | |
| 85 | blow. chain | blow. sec. | |
| 86 | blow. chain | blow. sec. | |
| 87 | blow. chain | blow. sec. | |
| 88 | blow. chain | blow. sec. | |
| 89 | blow. chain | blow. sec. | |
| 90 | blow. chain | blow. sec. | |
| 91 | blow. chain | blow. sec. | |
| 92 | blow. chain | blow. sec. | |
| 93 | blow. chain | blow. sec. | |
| 94 | blow. chain | blow. sec. | |
| 95 | blow. chain | blow. sec. | |
| 96 | blow. chain | blow. sec. | |
| 97 | blow. chain | blow. sec. | |
| 98 | blow. chain | blow. sec. | |
| 99 | blow. chain | blow. sec. | |
| 100 | blow. chain | blow. sec. | |

| LEWIS | | WINDS HALLWAY | 179 |
|------------------------------------|--|---------------|-----|
| BLOWERS — SECTION B2 | | | |
| OPTION 1 (SHUTDOWN) | | | |
| DSS1-180/260 HEAT PUMP | | | |
| Refrigerant Piping Size: 5/8" 120W | | | |

FIGURE 5

START-UP AND PERFORMANCE CHECK LIST

TEMPERATURE AT TIME OF INSPECTION

Outdoor air D.B. _____ Return Air _____
 Mixed Air _____ Discharge Air _____

SYSTEM TIME CLOCK

Normal _____ Setback _____

ELECTRICAL

Unit Nameplate Voltage _____
 Minimum Circuit Ampacity - Disconnect _____
 Maximum Fuse Size - Disconnect _____
 Wiring connections checked for tightness
 Supply Voltage (Unit Off) 1 & 2 _____ 1 & 3 _____ 2 & 3 _____
 Electronic circuit checked for shorts
 *Transformer Secondary Voltage T1 _____ T3 _____ T7 _____

SUPPLY BLOWER/FILTER

Motor HP _____ Make _____
 Shipping Blocks Removed Filters in place
 Lub & Bearings: Motor Blowers Pulleys Tight
 Belt Tension & Alignment Proper Blower Rotation
 Motor Amps: 1 _____ 2 _____ 3 _____
 Smoke Detector Operates
 *Transformer T5 Secondary Voltage _____
 Blower RPM _____ CFM _____

RETURN BLOWER

Motor Hp _____ Make _____
 Shipping Blocks Removed
 Lub & Bearings: Motor Fan Pulleys Tight
 Belt Tension & Alignment Proper Fan Rotation
 Motor Amps 1 _____ 2 _____ 3 _____

OUTSIDE-RETURN-EXHAUST DAMPERS

Enthalpy Control Setting _____
 Morning Warmup Thermostat Setting _____
 Damper Linkage Adjusted & Tight
 Minimum Air Adjusted (Blade opening) _____ " Outside Air _____ %
 *Transformer Secondary Voltage T4 _____ T6 _____
 Shipping screws removed from exhaust dampers
 Exhaust dampers open & close freely

REFRIGERANT COOLING & HEAT PUMP

Crankcase heater energized 24 hours before installing compressor fuses
 Refrigerant Lines Secure Service Valves Backseated
 Proper Condenser Fan Rotation Fan 1 2 3 4
 Hot Gas Bypass Valve Operating
 *Transformer Secondary Voltage T2 _____
 Voltage with compressors operating 1&2 _____ 1&3 _____ 2&3 _____
 Amps:
 Supply 1 _____ 2 _____ 3 _____
 Outdoor Fan Motor No. 1 1 _____ 2 _____ 3 _____
 Outdoor Fan Motor No. 2 1 _____ 2 _____ 3 _____
 Compressor No. 1 1 _____ 2 _____ 3 _____
 Compressor No. 2 1 _____ 2 _____ 3 _____
 Outdoor coil Air Temperature: In _____ Out _____
 Compressor Discharge Pressure 1 _____ 2 _____
 Compressor Suction Pressure 1 _____ 2 _____
 Refrigerant Charge O.K. 1 2

ELECTRIC HEAT

Model No. _____ Serial No. _____
 Voltage 1 & 2 _____ 1 & 3 _____ 2 & 3 _____
 Amps 1 _____ 2 _____ 3 _____
 Sequencer Properly Air Temperature Rise _____
 Connections Tight

HOT WATER

*Transformer Secondary Voltage T8 _____ T9 _____
 Valve Operating Valve Shipping Bolts Removed
 Lines Tight
 Valve Adjusted Air Bled from system

REMOTE READOUT PANEL

Switches operative: System Condensing Unit
 Manual Over-ride Timer
 Lights function properly: System Comb. Lockout
 Cond. Unit Inoperative Dirty Filter

*Refer to wiring diagrams legend for location of transformers

DSS1 PREVENTIVE MAINTENANCE GUIDE

The general climatic conditions and specific application will affect service frequency.

- 1 - For climates with a heavy heat demand, an additional heating check should be made about midway through the heating season. For climates with a heavy cooling demand, an additional cooling check should be made about midway through the cooling season.
- 2 - Equipment operating under industrial or heavy duty conditions

(shopping centers, factories, etc.) will require four or more inspections per year.

- 3 - Parts should be replaced if they are found defective or show sufficient wear to indicate imminent failure.
- 4 - Filter service will vary according to the type of filter used. The frequency of filter service will vary with each unit, but must be often enough to protect the equipment and the conditioned space.

GENERAL

| SECTION | SERVICE CHECK | PRE-HEATING SEASON | PRE-COOLING SEASON |
|---------------------------------|---|--------------------|--------------------|
| Electrical | Tighten all wire connections | X | X |
| | Check for proper fusing | X | X |
| | Contacts of compressor and motor starters | X | X |
| | Supply voltage - unit off | X | X |
| | Supply voltage - unit on | X | X |
| | Supply voltage - compressors on | ---- | X |
| | Supply voltage - electric heat on | X | ---- |
| | Voltage at transformer secondaries (system operating) | X | X |
| Indoor Blower | Shaft alignment | X | X |
| | Shaft or bearing wear | X | X |
| | Bearing locking collars | X | X |
| | Belt tension and wear | X | X |
| | Filters | X | X |
| | Motor amps | X | X |
| | Smoke detector test | X | X |
| | Lubricate | X | ---- |
| Outdoor & Return Air Dampers | Clean enthalpy control | X | X |
| | Linkage adjusted and tight | X | X |
| | Minimum air setting | X | X |
| | Exhaust damper operation | X | X |
| System Operation | Load analyzer module operates properly | X | X |
| | Perform heating function test with load simulator & compare with function chart | X | ---- |
| | Room sensor operation | X | X |
| | Perform cooling function test with load simulator & compare with function chart | ---- | X |
| Electric Heat | Check for broken elements | X | ---- |
| | Tighten all wire connections | X | ---- |
| | Safety controls operate | X | ---- |
| | Heater amps | X | ---- |
| Hot Water | System pump operates | X | ---- |
| | Valve motor operates | X | ---- |
| | Leaks in system | X | X |
| | Water temperature | X | ---- |
| Refrigerant Cooling & Heat Pump | Discharge pressure/ Suction pressure/ Refrigerant charge | ---- | X |
| | Hot gas bypass | ---- | X |
| | Super heat setting | ---- | X |
| | Outdoor fans operate | ---- | X |
| | Outdoor heat operates | ---- | X |
| | Compressor timed interlock | ---- | X |
| | Clean indoor coil if required | ---- | X |
| | Clean condensate pans and drains | ---- | X |
| | Compressor amps | ---- | X |
| | Outdoor coil motor amps | ---- | X |
| | Crankcase heaters | ---- | X |
| Optional Controls | Time clock settings | X | X |
| | Nite setback operation | X | X |
| | Read-out panel function | X | X |

ELECTRONIC SYSTEM CONTROL

I - COMMAND SIGNAL

A - Room And Discharge Sensors

Basic operation of the control system is dependent upon a voltage command signal generated by the room transmitter. The transmitter generates voltage based on room setpoint, room temperature sen-

sor and discharge air temperature sensor. This means a 20° temperature change at discharge air sensor has the same effect as a 1° change at room sensor. See Figure 6 for identification of room transmitter, subbases and discharge sensor.

ELECTRONIC
SYSTEM
CONTROL

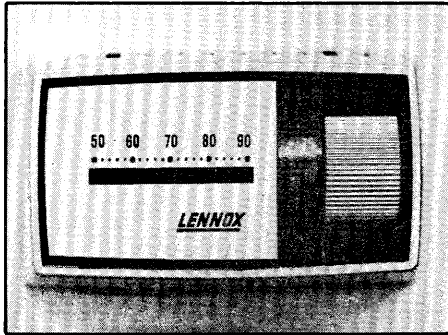

ROOM TRANSMITTER

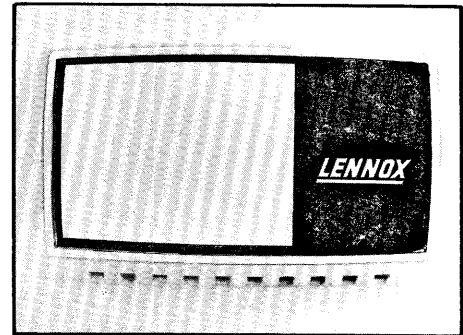

ENCLOSED COVER

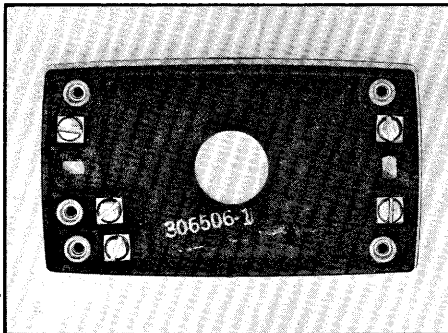

NON-SWITCHING WIRING SUBBASE

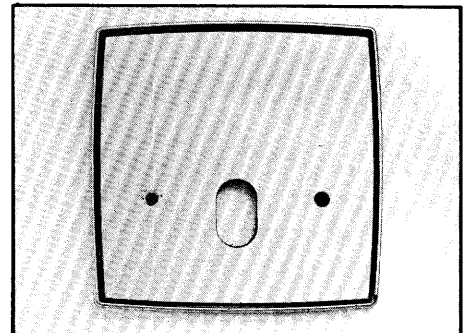

DECORATOR WALL PLATE

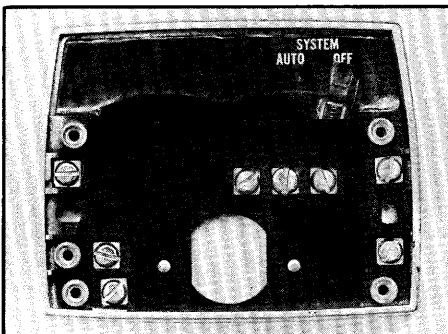

SINGLE SWITCH SUBBASE

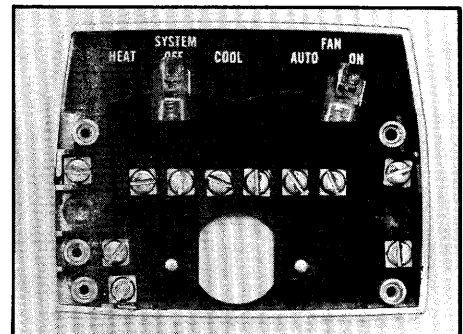

DOUBLE SWITCH SUBBASE

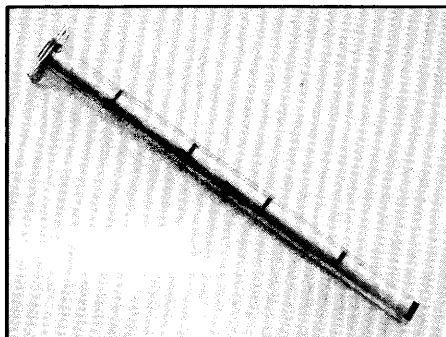

DISCHARGE AIR SENSOR

FIGURE 6

B - Load Analyzer Module

The load analyzer module provides 24 VDC power supply to room sensor. It monitors the command signal to control heating and cooling process. These signals range from 2 VDC to 24 VDC. A 4° change at the discharge air sensor or a 0.2° change at the room sensor causes a one volt change. Internal logic relays in the load analyzer module are programmed to close at specific voltages. The command signal is also used to control Power Saver damper modulation for cooling and hot water valve modulation for heating. Figure 7 identifies all switches and terminals on the load analyzer module.

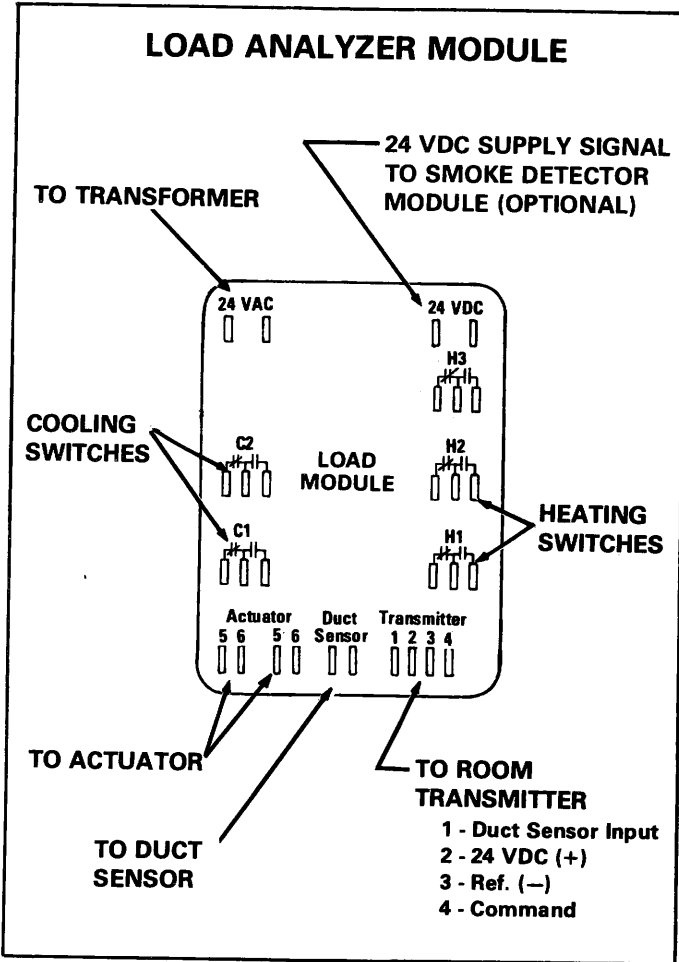

FIGURE 7

II - FUNCTION CHARTS

The correlation between command signal voltage and DSS1 sequence of operation is illustrated in chart form. A basic function chart is provided on page 20. Adjacent is a gummed back page of individual function charts. Cut out proper chart, moisten and adhere to basic function chart. Refer to decision tree on page 19 to select charts that apply to unit. The following sections explain sequence and operation of each function chart.

A - Chart ① DX Cool - Single Speed Lead Compressor

- 1 - At 18.5 volts, Switch "C1" closes and compressor #1 operates. Switch opens at 13.5 volts to shut off compressor.
- 2 - At 20 volts, Switch "C2" closes and compressor #2 operates. Switch opens at 15 volts to shut off compressor.

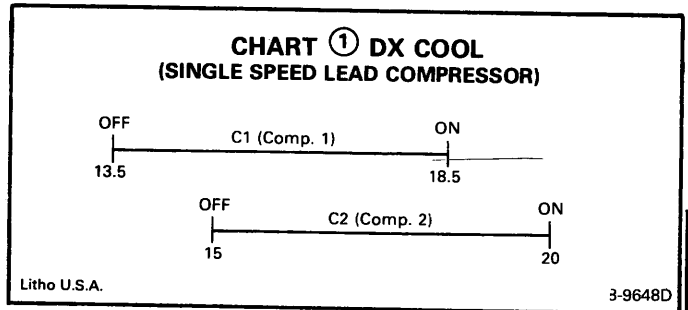

Litho U.S.A.

3-9648D

ELECTRONIC SYSTEM

B - Chart ② Electric Heat

- 1 - At 8 volts, Switch "H1" closes to bring on first stage of electric heat. Switch opens at 11 volts to de-energize first stage of electric heat. First stage may contain up to two steps.
- 2 - At 6.5 volts, Switch "H2" closes to bring on second stage of electric heat. Switch opens at 9.5 volts to de-energize second step of electric heat. Second stage may contain up to four steps.

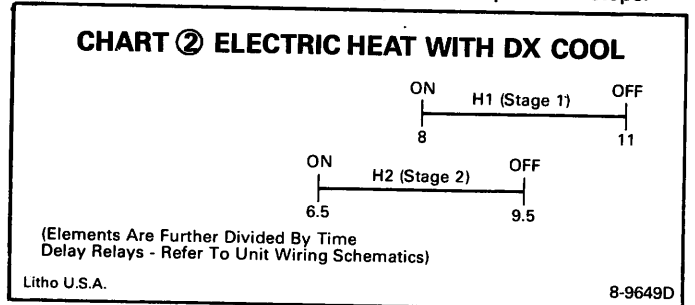

(Elements Are Further Divided By Time Delay Relays - Refer To Unit Wiring Schematics)

Litho U.S.A.

8-9649D

C - Chart ③ Hot Water

- 1 - The command signal from terminals "5-6" on load analyzer module controls valve modulation. The valve modulates open on a voltage decrease.
- 2 - At 7 volts or higher there is no flow through hot water coil. (By-pass open)
- 3 - The valve starts to open at 7 volts and is fully open at 4 volts.

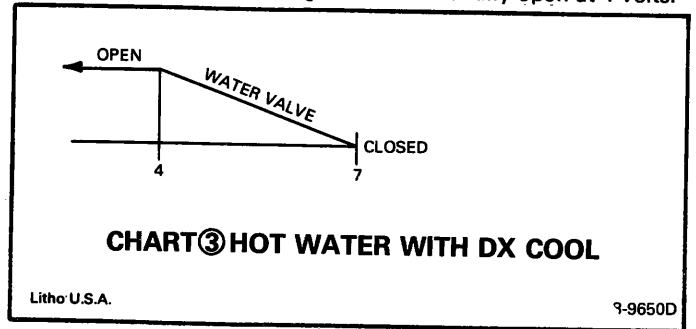

Litho U.S.A.

3-9650D

D - Chart ④ Heat Pump

- At 4.5 volts, Switch "H1" closes to bring on first stage of heat pump. Switch opens at 11.5 volts to de-energize first stage of heat pump.
- At 3.5 volts, Switch "H2" closes to bring on second stage of heat pump. Switch opens at 7.5 volts to de-energize second stage of heat pump.

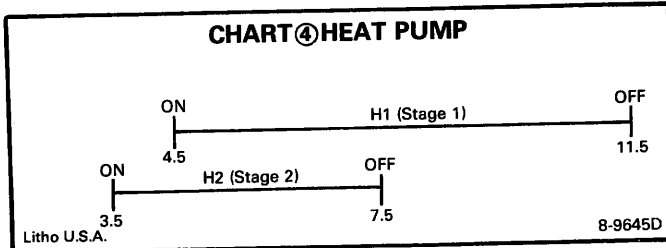

E - Chart ⑤ Electric Heat With Heat Pump

- At 4.5 volts, Switch "H1" closes to bring on first stage of heat pump. Switch opens at 11.5 volts to de-energize first stage of heat pump. See Chart 4.
- At 3.5 volts, Switch "H2" closes to bring on second stage of heat pump. Switch opens at 7.5 volts to de-energize second stage of heat pump. See Chart 4.
- At 2.5 volts, Switch "H3" closes to bring on electric heat. Switch opens at 6.5 volts to de-energize electric heat.

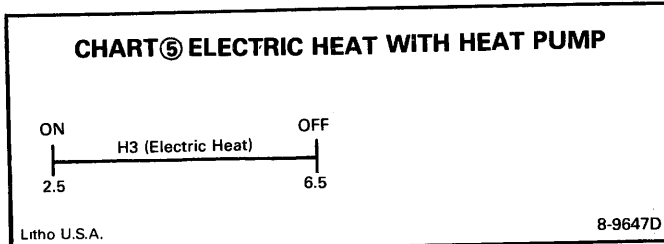

F - Chart ⑥ Hot Water Heat With Heat Pump

- At 4.5 volts, Switch "H1" closes to bring on first stage of heat pump. Switch opens at 11.5 volts to de-energize first stage of heat pump. See Chart 4.
- At 3.5 volts, Switch "H2" closes to bring on second stage of heat pump. Switch opens at 7.5 volts to de-energize second stage of heat pump. See Chart 4.
- Switch "H3" controls the hot water pump and valve modulation. Hot water pump starts at 2.5 volts and stops at 6.5 volts. The valve modulates open on a voltage decrease. At 7 volts or higher there is no flow through hot water coil. The valve starts to open at 7 volts and is fully open at 4 volts.

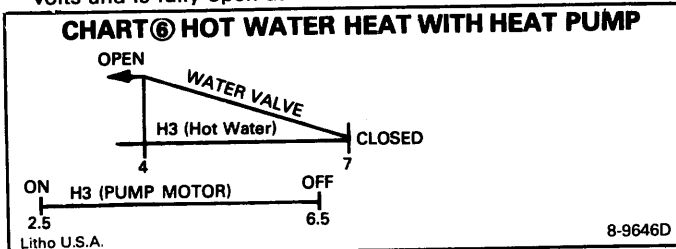

G - Chart ⑦ Power Saver

- The command signal from "5-6" terminals control actuator operation and subsequent damper modulation.
- At 14 volts, outdoor dampers are closed. As voltage increases dampers modulate and are fully open at 17 volts.

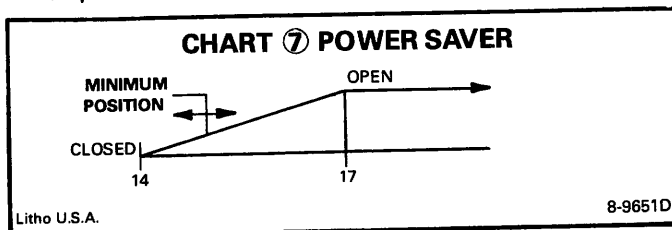

H - Chart ⑧ Supermarket Heat Reclaim With Electric Heat (Not Used On Heat Pump Units)

- At 4.5 volts, switch "H1" closes to open first stage heat reclaim coil valve. Switch opens at 11 volts to close valve.
- At 3.5 volts, switch "H2" closes to open stage two reclaim coil valve. Switch opens at 7.5 volts to close valve.
- At 2.5 volts, switch "H3" closes to bring on first stage of electric heat. Switch opens at 6.5 volts to de-energize first stage electric heat.
- An adjustable thermostat located in the return air compartment controls stage two electric heat. This thermostat, factory set at 60°F (15.6°C), has a range of 20°F to 90°F (-6.7°C to 32.2°C).

Note - In addition to load analyzer module and thermostat control of electric heat, the heating elements are further divided by time delay sequencers.

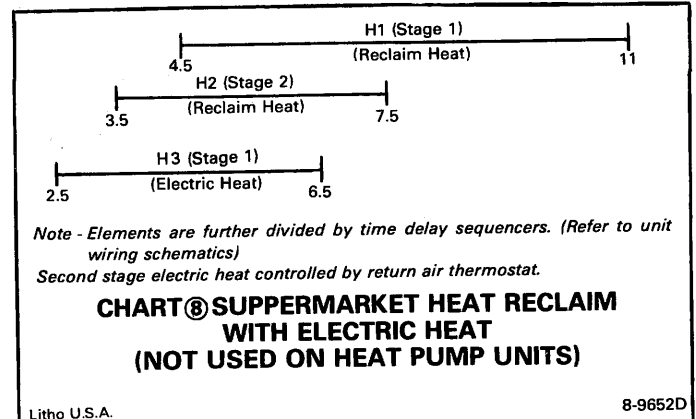

I - Chart ⑨ Supermarket Heat Reclaim With Hot Water Heat (Not Used On Heat Pump Units)

- At 4.5 volts, switch "H1" closes to open stage one heat reclaim coil valve. Switch opens at 11 volts to close valve.
- At 3.5 volts, switch "H2" closes to open stage two heat reclaim coil valve. Switch opens at 7.5 volts to close valve.
- Terminals "5-6" control hot water valve modulation. At 7 volts or higher there is no flow through hot water coil. The valve begins to open at 7 volts and is fully open at 4 volts. Hot water pump starts at 2.5 volts and stops at 6.5 volts.

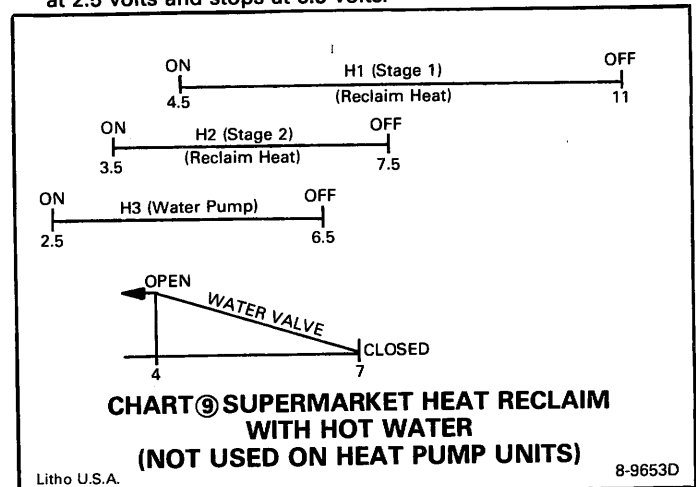

III - SYSTEM CHECK USING LOAD SIMULATOR

A Load Simulator (P-8-10532), test lights and a good DC voltmeter are recommended to check system operation. The Load Simulator simulates command signals in the electronic circuit. Unit functions are verified directly at load analyzer module.

NOTE - Load Simulator may cause a shift of ± 1 volt from settings on function charts. Any variation in starting points should be consistent.

A - Load Simulator Connections

- Turn off power to DSS1 unit.
- Connect load simulator as shown in Figure 8.

3 - Null the load simulator by aligning thumbwheel mark with null indicator. See Figure 8.
4 - Restore power to unit.

B - Heating Sequence Check

The following procedure will check heating logic relay.

- 1 - Connect DC voltmeter negative lead to 24 VDC (-) terminal and positive lead to "4" terminal to obtain command signal.
- 2 - Connect test lights or 24 VAC voltmeter to heating logic relays as shown in Figure 8.
- 3 - Refer to basic function chart. Slowly rotate load simulator while observing voltmeter. As the load simulator lowers heating command input voltage, the heating logic relays will respond according to function chart's sequence of operation on pages 11, 12 and 13. Observe test lights or voltmeter to verify switching action and checking mechanical operation of unit. Hot water valve will modulate in response to the demand.
- 4 - Slowly reverse rotation of load simulator until output voltage reaches 12. Heating logic relays will open according to the chart.

C - Cooling Sequence Check

The following procedure will check cooling logic relays.

NOTE - If unit is equipped with optional dehumidification/reheat condenser coil, turn humidistat to highest setting before checking cooling logic relays.

- 1 - Connect DC voltmeter negative lead to 24 VDC (-) terminal and positive lead to "4" terminal to obtain cooling command signal. Connect test lights to cooling logic relays. See Figure 8.
- 2 - Refer to basic function chart. Slowly rotate load simulator while observing voltmeter. As simulator raises cooling command input voltage, cooling logic relays will respond according to function chart's sequence of operation on pages 10 and 11. Observe test lights or voltmeter to verify switching action and checking mechanical operation of unit. Outdoor damper actuator will modulate in response to the demand.
- 3 - Slowly reverse rotation of load simulator until output voltage recedes to 12 VDC. Cooling logic relays will open according to the chart.
- 4 - Turn off power to unit. Disconnect load simulator, test lights and DC voltmeter from load analyzer module.
- 5 - Reconnect factory wire to correct terminal 4.

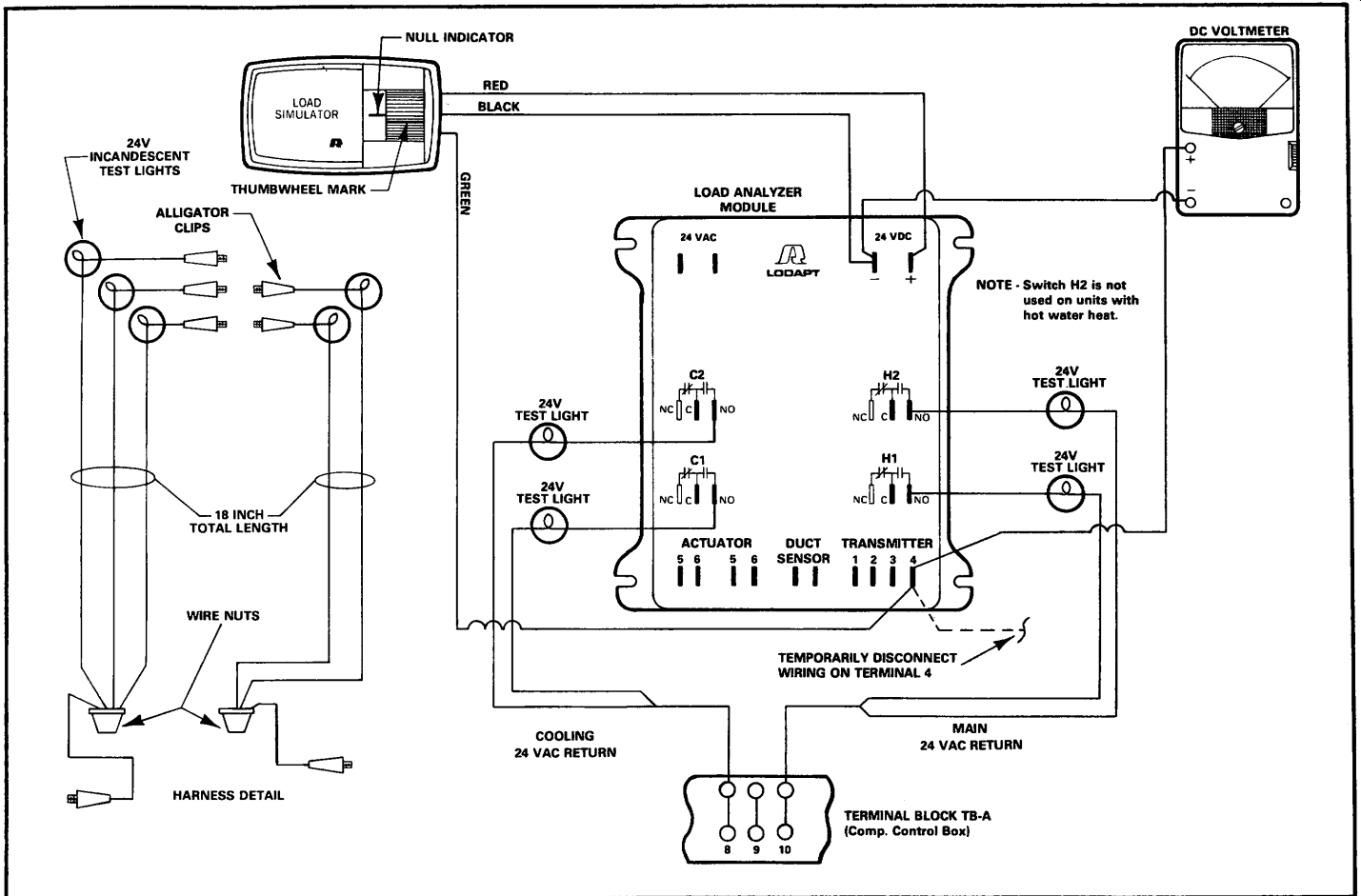

FIGURE 8

IV - ROOM SENSOR CHECKS

A - Voltage Signal

The command signal voltage is the algebraic sum of the room sensor and discharge air sensor. This sum reflects temperature deviations from set point. A 4° change across discharge air sensor or a 0.2° change across room sensor, will cause a one volt change. Figure 9 illustrates the correlation between temperature changes and voltage signal for both standard room sensor and "wide band" room sensor.

B - Performance Check

A DC voltmeter must be used for the following check.

CAUTION - The thermistor will change its resistance in response to changes in temperatures. When making set point adjustments, keep hands and other heat sources away from thermistor.

1 - Remove cover from room sensor. Connect voltmeter to terminals 3(-) and 4(+). See Figure 10.

NOTE - If the "wide band" room sensor is used, an additional 6 degrees must be added in the following checks.

- 2 - Slowly increase set point 2 degrees above room temperature. Voltage should decrease to approximately 2 VDC.
- 3 - Slowly decrease set point 2 degrees below room temperature. Voltage should increase to approximately 22 VDC.
- 4 - Refer to section "VI - Electronic Circuit Troubleshooting" if command voltage does not respond to set point adjustments.
- 5 - Table 1 lists voltage ranges that reflect conditions at room sensor. Refer to Figure 10 for meter connections.

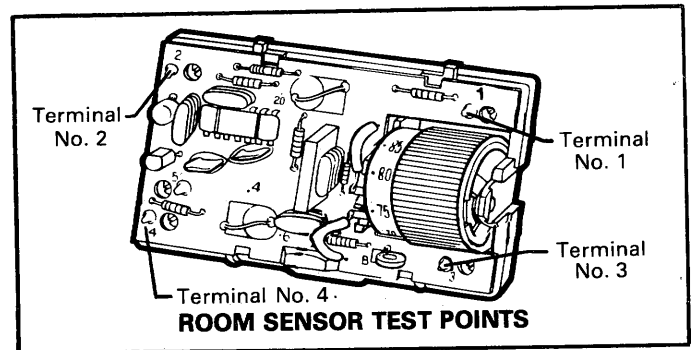

FIGURE 10

TABLE 1

| Room Sensor | Correct Voltage |
|---|--|
| DC Power Supply Terminals 2 (+) and 3 (-) | 24 VDC |
| Discharge Sensor (Adjust set point to room temperature) Terminals 1 (+) and 3 (-) | 6 VDC to 18 VDC (Depending on duct temperature) |
| Command Voltage Terminals 3 (-) and 4 (+) | 2 VDC to 22 VDC (Varies with difference between set point and room temperature) |

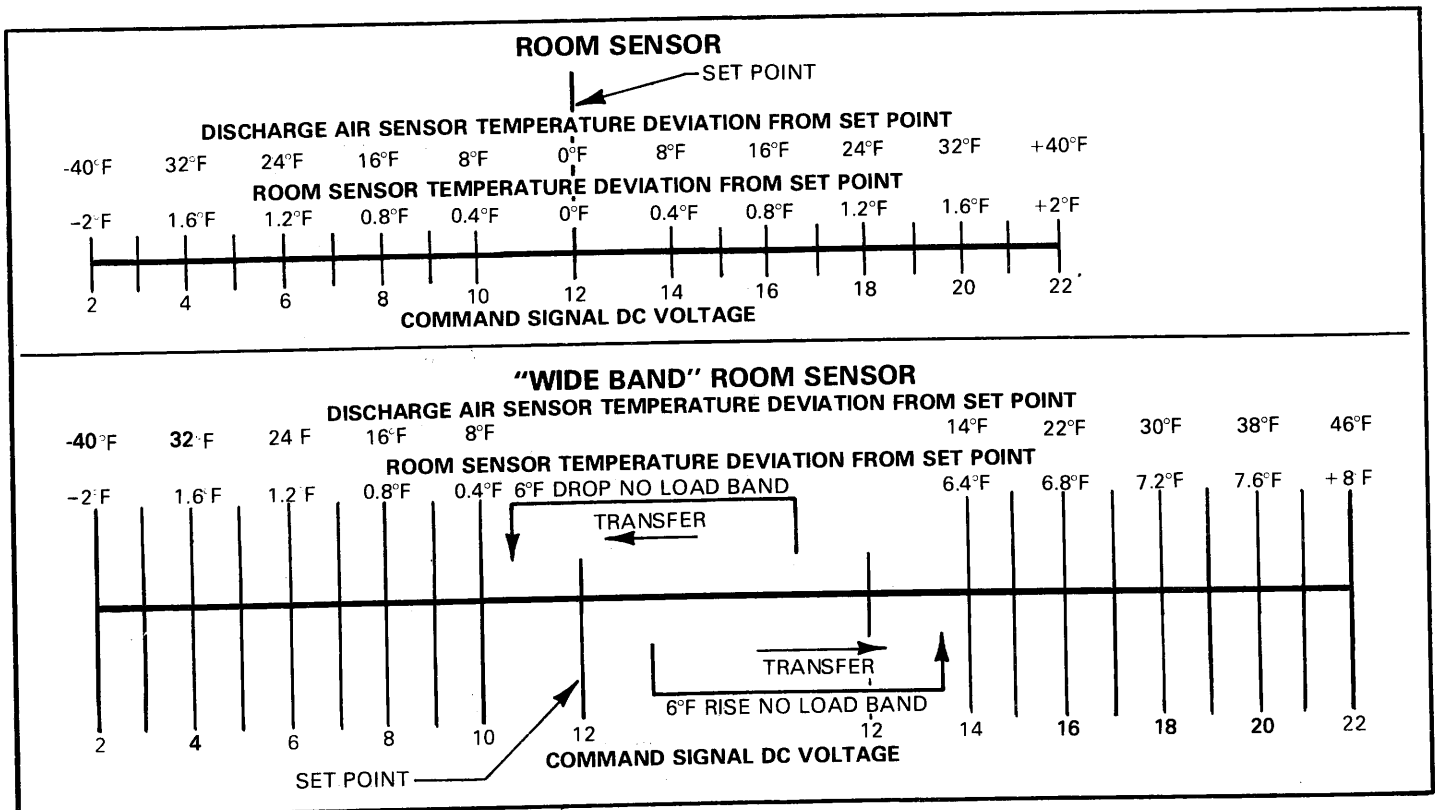

FIGURE 9

V - REMOTE CONTROL OPTIONS

A - Smoke Detectors Operation

Photo cell smoke detectors are designed to detect the presence of smoke within the system and terminate heating and cooling functions. Blowers and dampers are controlled by 1 of 2 options as described in "Blower Operation" section on page 2. Two unit detectors are used; one in the return air section and one in supply air section downstream from air filters. Each of the two detectors in the unit has a built-in key operated test feature as shown in Figure 11. In addition, two remote test stations may be used (one for each detector). Refer to Figure 11 for smoke detector description and test procedure.

Terminals are provided in the unit for connection of remote alarm and trouble circuits:

- 1 - The (2) orange leads are for a trouble circuit. Trouble relay contacts are normally open (closed during unit operation). A typical trouble circuit would be a green system light that would be "ON" during normal unit operation and would go "OFF" upon smoke detector malfunction
- 2 - The (2) black leads are for a remote alarm system. Alarm relay contacts are electrically normally closed (open during unit operation). An alarm bell, telephone or buzzer would be energized upon detection of smoke.

Maintenance

Cleaning of smoke detector sensing chamber should be performed when abnormal dust accumulations are noted on the outer filter, but should be done at least once a year.

Caution – Unit power should be disconnected before servicing or an alarm may be initiated. Cleaning should be performed in subdued light for minimum reset time.

Cleaning Instructions — See Figure 11

- 1 - Remove cover from detector.
- 2 - Disconnect wiring harness and light from sensing chamber.
- 3 - Remove chamber mounting screws and draw assembly straight out from detector.

- 4 - Remove chamber outer filter and rinse in a solution of warm water and mild detergent. Allow to air dry.
- 5 - Remove nuts and washers from front of chamber plate and draw cage straight out from plate using caution to avoid any damage to the assembly. Remove chamber plate gasket.
- 6 - Clean cage inner filter by vacuum or air pressure. This filter is cemented to the cage and must not be removed. If filter is loose contact cement may be used to resecure it.
- 7 - Clean the optical block and surrounding surfaces with air pressure, vacuum, or with a soft cloth if necessary. Clean all dust and lint from holes and lens in optical block as these could initiate a false alarm.
- 8 - Install gasket on cage and secure cage to chamber plate with the washers and nuts.
- 9 - Install outer filter on cage and install chamber assembly to detector base with the mounting screws.
- 10 - Connect wiring harness and light to sensing chamber.
Caution – The alarm photocell was exposed to light during the cleaning process and likely will cause an alarm unless the power was disconnected.
- 11 - Install detector cover and turn detector key switch to RESET position. Connect unit power.
Note – A reset period of up to one half hour may be required depending on the amount of light the photocell was exposed to during servicing.
- 12 - After resetting the detector, turn detector key switch to the NORMAL position.
- 13 - Allow detector to remain powered for one hour after resetting, then test detector using standard test procedure.
- 14 - Return system to normal operation.

Note – If unit is used for temporary heat during construction, smoke detector sensing chambers should be removed as large amounts of fine construction dust may cause a false alarm. A sensing chamber from one detector should not be placed in another detector, since they were each calibrated as a complete unit before leaving the factory.

SMOKE DETECTOR LOCATION

**RETURN AIR SECTION
(FRONT SIDE OF UNIT)**

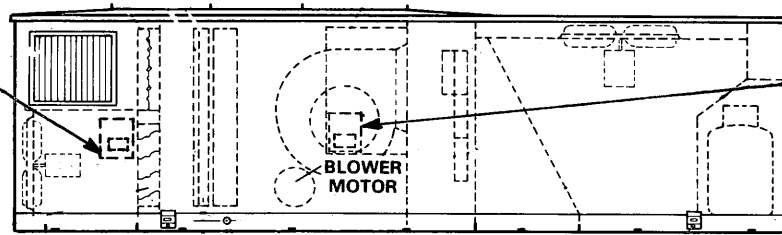

**SUPPLY AIR SECTION
(REAR OF UNIT
BEHIND BLOWER)**

UNIT SIDE VIEW

**ELECTRONIC
SYSTEM
CONTROL**

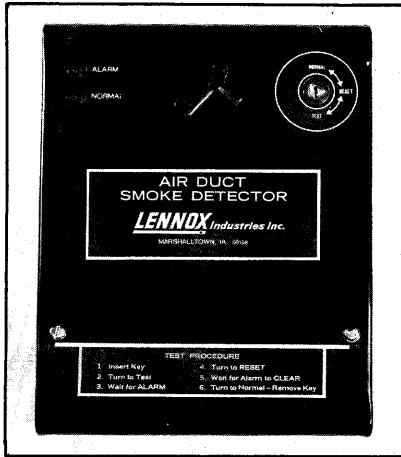

**SMOKE DETECTOR
(2 IN UNIT)**

TEST PROCEDURE

- 1 - Insert key, turn to TEST.
- 2 - Unit heating/cooling functions will terminate and blower/damper operation will respond.
- 3 - Turn to RESET, wait for unit blower to start.
- 4 - Turn to NORMAL (green light on), remove key.

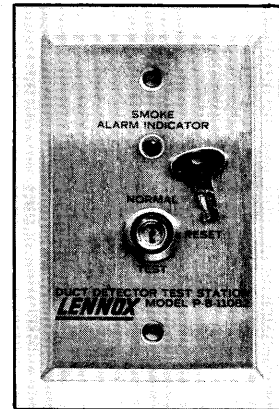

**REMOTE TEST STATION
(2 REQUIRED)**

TEST PROCEDURE

- 1 - Insert key, turn to TEST.
- 2 - Wait for indicator lamp (red) to light. Check that unit responds.
- 3 - Turn to RESET, wait for indicator lamp to go OFF and check that unit blower starts.
- 4 - Turn key to NORMAL, remove key.

NOTE - All key switches must be left in the "NORMAL" position.

**SMOKE DETECTOR ASSEMBLY
(MODEL 760)**

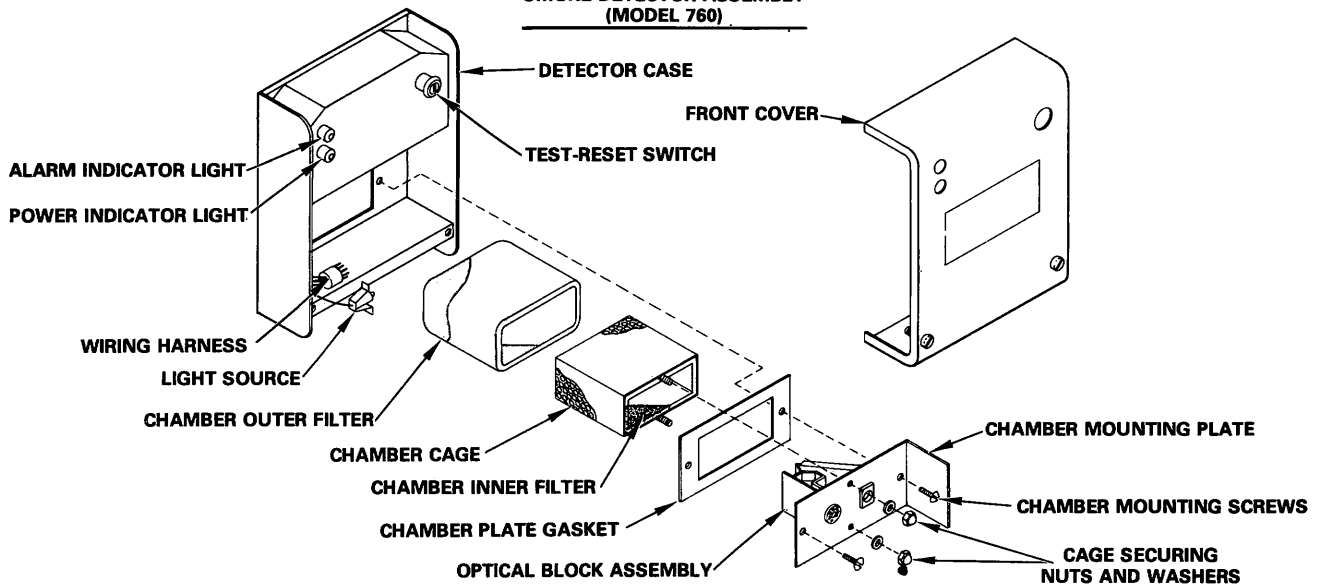

FIGURE 11

B - Night Setback Controls

Night setback potentiometer and override controls are designed for use in conjunction with a clock timer. When system clock timer shuts unit down for night operation, unit is controlled through the day thermostat which is shifted to a lower temperature by the night setback potentiometer in the unit.

Night setback kit with manual 12 hour timer will return system to normal daytime conditions by setting clock for length of time. When

clock runs back to initial set point, the system will return to nighttime control.

The optional clock timer may be ordered factory installed in the compressor compartment of the unit or ordered separately and field installed remote from the unit.

Night setback kit with switch works exactly the same as a manual timer except system switch must be manually switched to return system to nighttime control.

See Figure 12 for description of night setback controls.

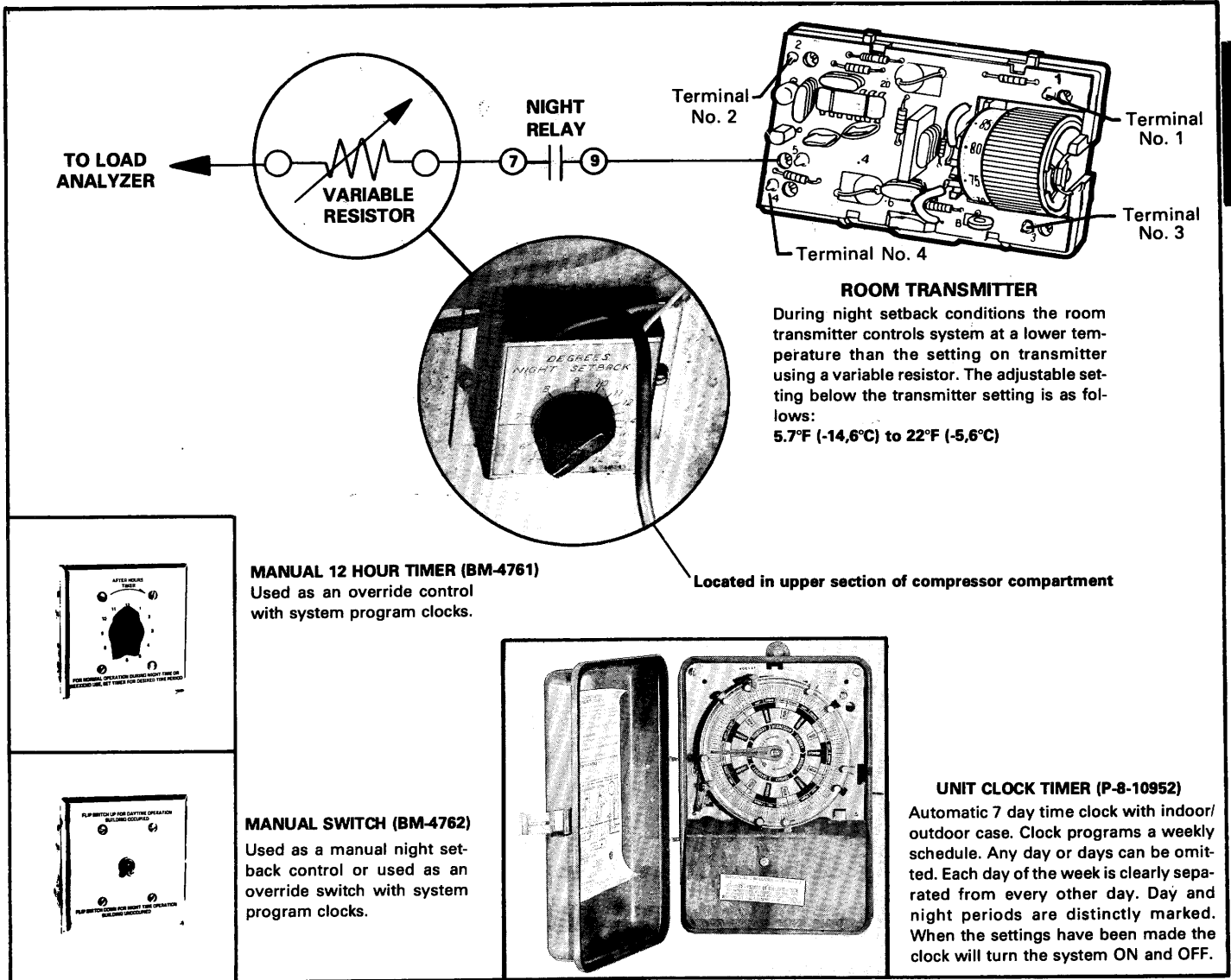

ELECTRONIC SYSTEM CONTROL

FIGURE 12

C - Lennox Remote Readout Panels

The RP2 and RP5 readout panels allow the operation of the DSSI to be checked at a glance. The RP2 remote readout panel is used on the DSSI units without heat pump. By use of signal lights, the RP2 indicates: System On, Combustion Lockout, Condensing Unit Inoperative and Dirty Filter. See Figure 13. The RP5 remote readout panel is used on the DSSI units with heat pump. By use of signal light, the RP5 indicates: System On, Heating Inoperative,

Condensing Unit Inoperative and Dirty Filter. In addition, the panels have a system switch for shutting down the equipment, a manual override timer switch for after hours occupancy and a switch for shutting off condensing unit of the system. Factory installed night setback controls (including a 7 day clock timer) are available for both the RP2 and RP5 readout panels but must be ordered extra.

ELECTRONIC
SYSTEM
CONTROL

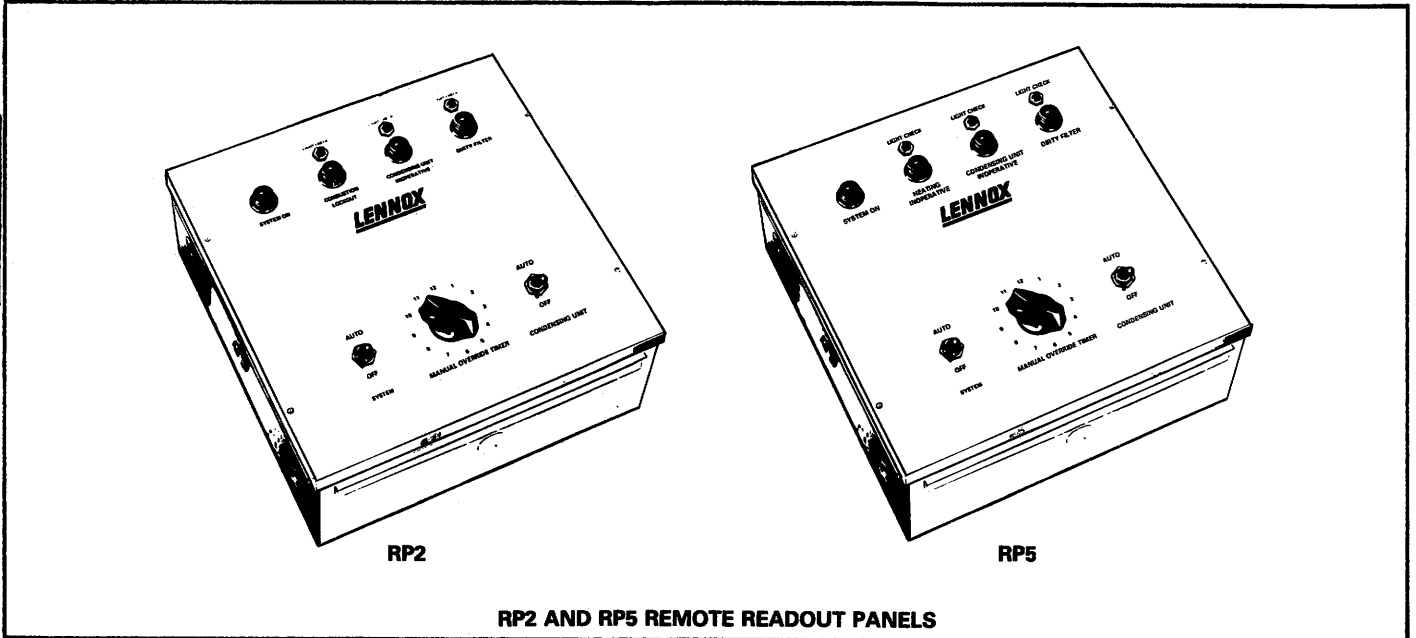

FIGURE 13

VI - ELECTRONIC CIRCUIT TROUBLESHOOTING

The following Troubleshooting Chart will assist the serviceman in locating possible wiring problems in the solid-state system. The recommended troubleshooting procedure is one of eliminating a

symptom by disconnecting a possible short until the symptom is eliminated. These checks are made at the load analyzer module.

NOTE - Make certain room sensor frame is snug against subbase.

| PROBLEM | POSSIBLE CAUSES | ELIMINATION PROCEDURE |
|--|---|--|
| No DC Power at terminals marked 24 VDC. | No AC Power. | Check T1 transformer. |
| | Room Sensor wires 2 and 3 shorted or reversed. | Correct short or reverse leads |
| DC Power reads constant low voltage (Approx. 2 to 6 Volts) at terminals marked 24 VDC. | Room Sensor wires 2 and 4 shorted or reversed. | Disconnect Room Sensor wire No. 3. If meter reads 24 Volts DC, then Room Sensor wires 3 and 4 are shorted. If meter reads a constant low voltage (2 to 6 Volts), then Room Sensor wires 2 and 4 are shorted. |
| | Room Sensor wires 3 and 4 shorted or reversed. | |
| | Power Saver Actuator terminals shorted or reversed. | Disconnect Actuator wires from terminals 5 and 6 on Load Analyzer Module. |
| | Room Sensor damaged. | Replace Room Sensor. |
| Load Module Output Voltages: Constant zero (0) Volts: Minus (-) DC terminal to 5 | Power Saver Actuator or wiring shorted. | Disconnect command wire from terminal marked 5 on Load Analyzer Module. If meter reads a command signal, then Power Saver Actuator or wiring is shorted. |
| Minus (-) DC terminal to 5 | Hot water valve wiring shorted. | Disconnect command wire from terminal marked 5 on Load Module. If meter reads a command signal, then valve or wiring is shorted. |
| Constant 2 to 6 Volts Minus (-) DC terminal to 5 | Room Sensor wire 2 open. | Check field wiring between Load Module and Room Sensor. |
| Constant 22 Volts Minus (-) DC terminal to 5 | Room Sensor wire 3 open. | Check field wiring between Load Module and Room Sensor. |
| Heating equipment does not operate when command voltage is (+) 2 Volts DC (full heating). Minus (-) DC terminal to 5 | Heating relays H1, H2 or H3 damaged. | Consecutively jumper H1 and H2 heating relays. If all heating functions operate, the appropriate relay is damaged. Replace Load Analyzer Module. |
| Cooling equipment does not operate when command voltage is (+) 22 Volts DC (full cooling). Minus (-) DC terminal to 5 | Cooling relays C1 or C2 damaged. | Consecutively jumper C1 and C2 cooling relays. If all cooling functions operate, the appropriate relay is damaged. Replace Load Analyzer Module. |
| Space temperature running approximately four (4) degrees below set point. | Transmitter wires 1 and 3 shorted. | Correct short. |
| | Duct Temperature Sensor shorted. | |
| Space temperature running approximately four (4) degrees above set point. | Room Sensor wire 1 open. | Connect lead. |
| | Room Sensor wires 1 and 2 shorted. | Correct short. |
| | Discharge Air Sensor open. | Connect lead. |

ELECTRONIC SYSTEM

DSSI SINGLE ZONE - FUNCTION DECISION TREE

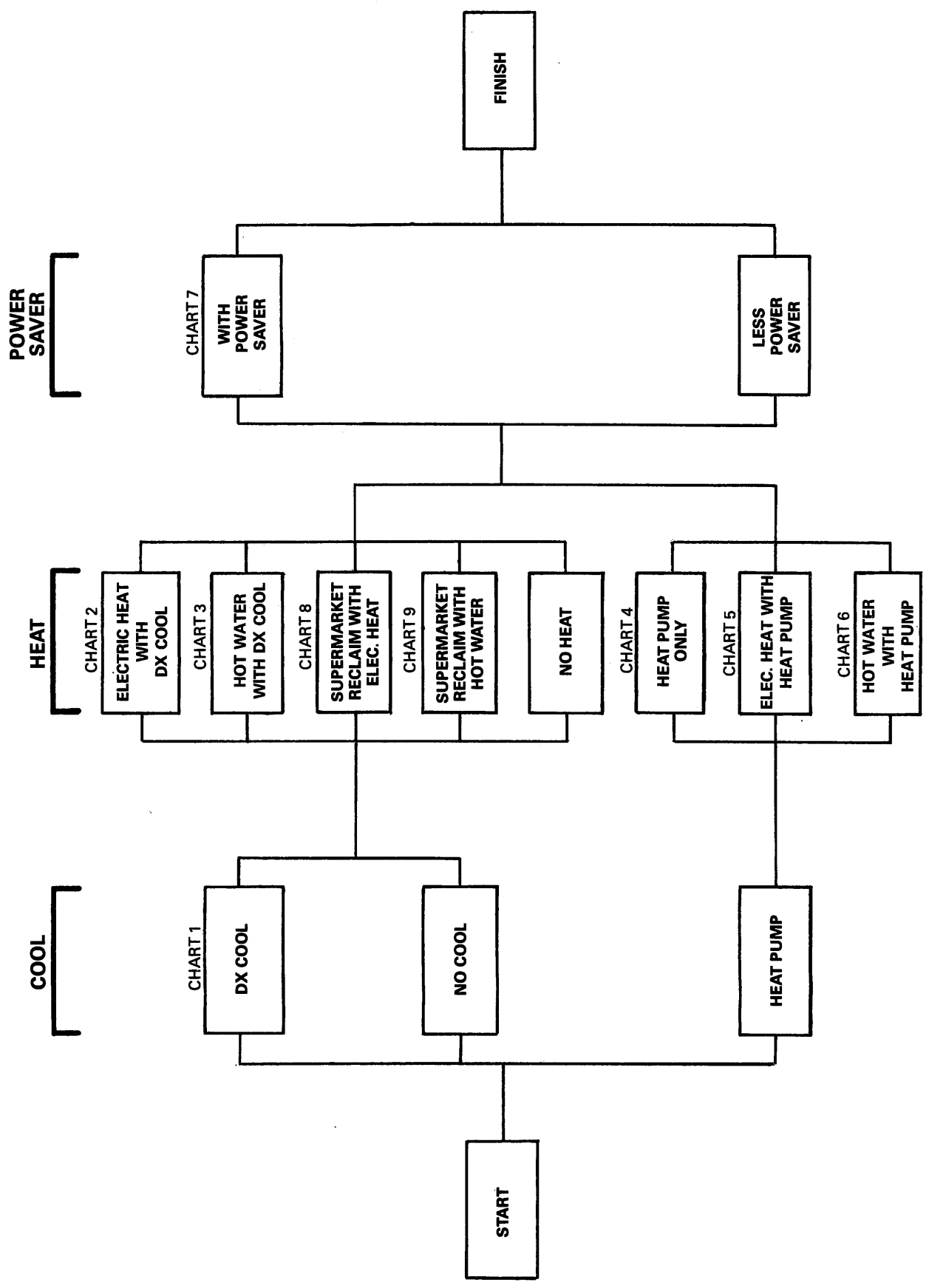

Cut out function charts on dotted line and adhere accordingly to Basic Function Chart on page 20.

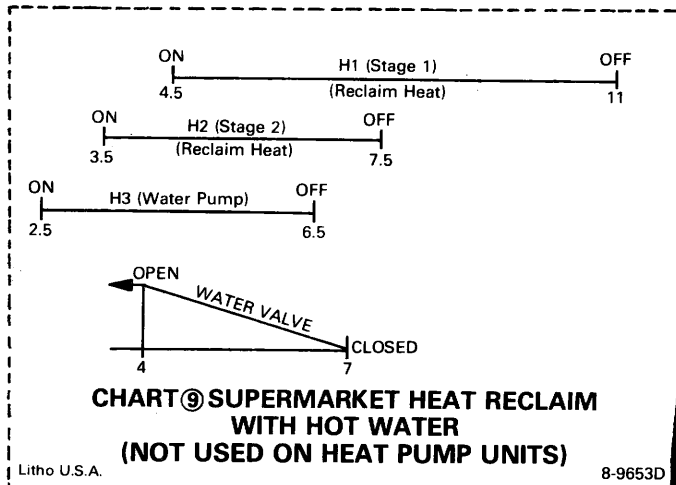
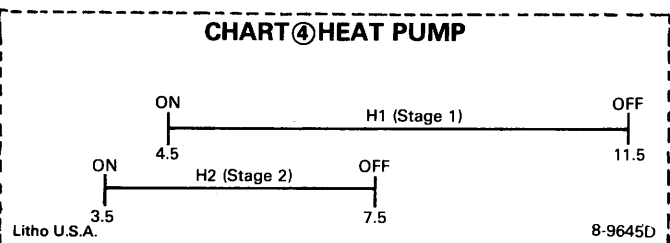
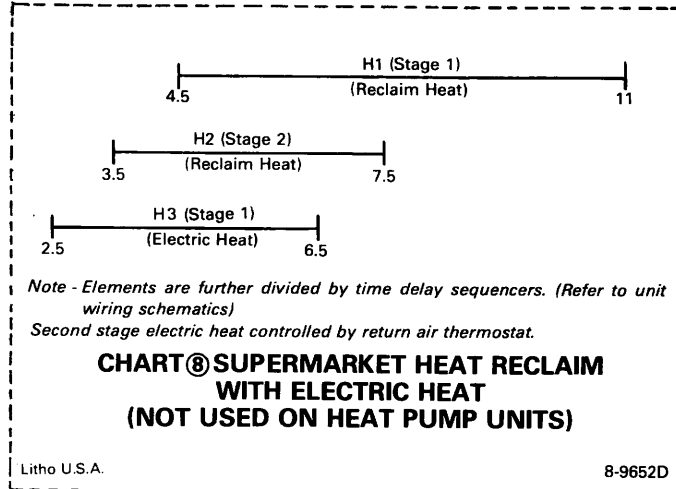
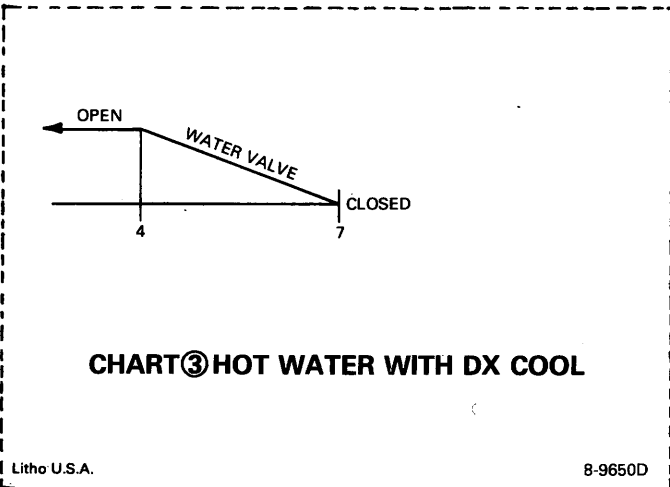
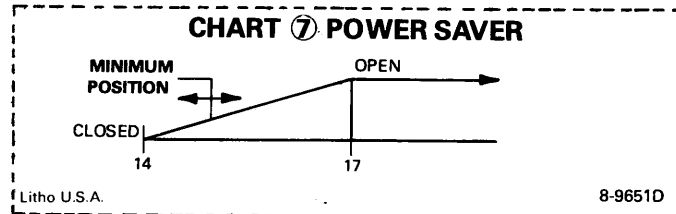
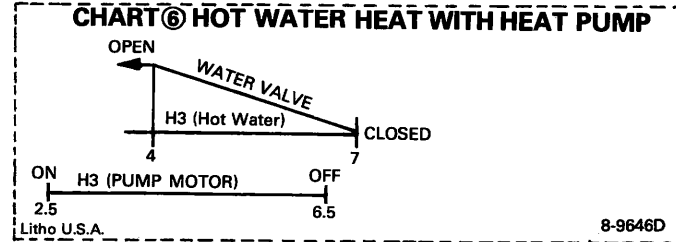
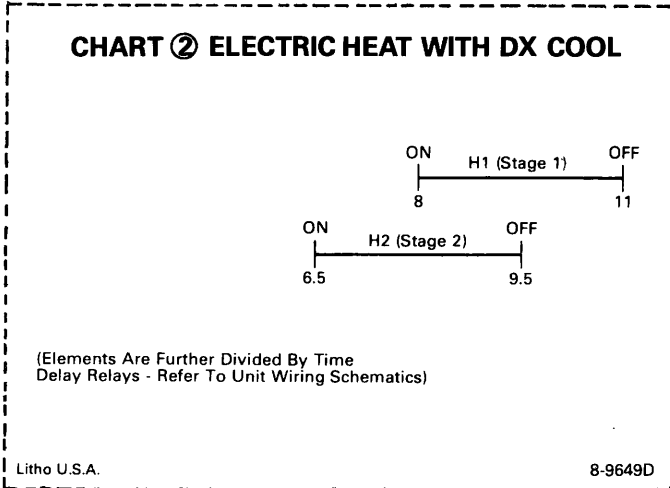
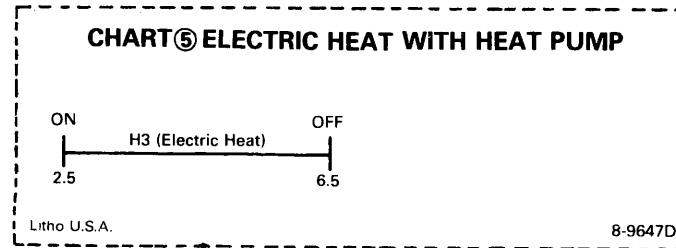
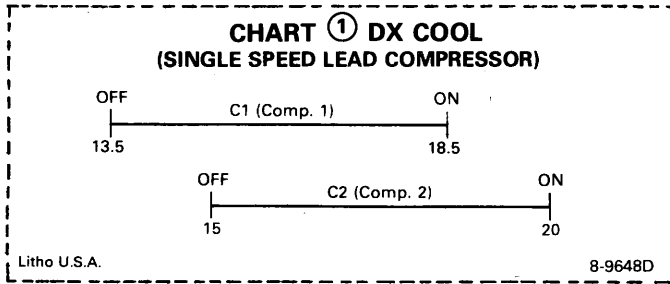

DSS1 SINGLE ZONE CONTROL BASIC FUNCTION CHART

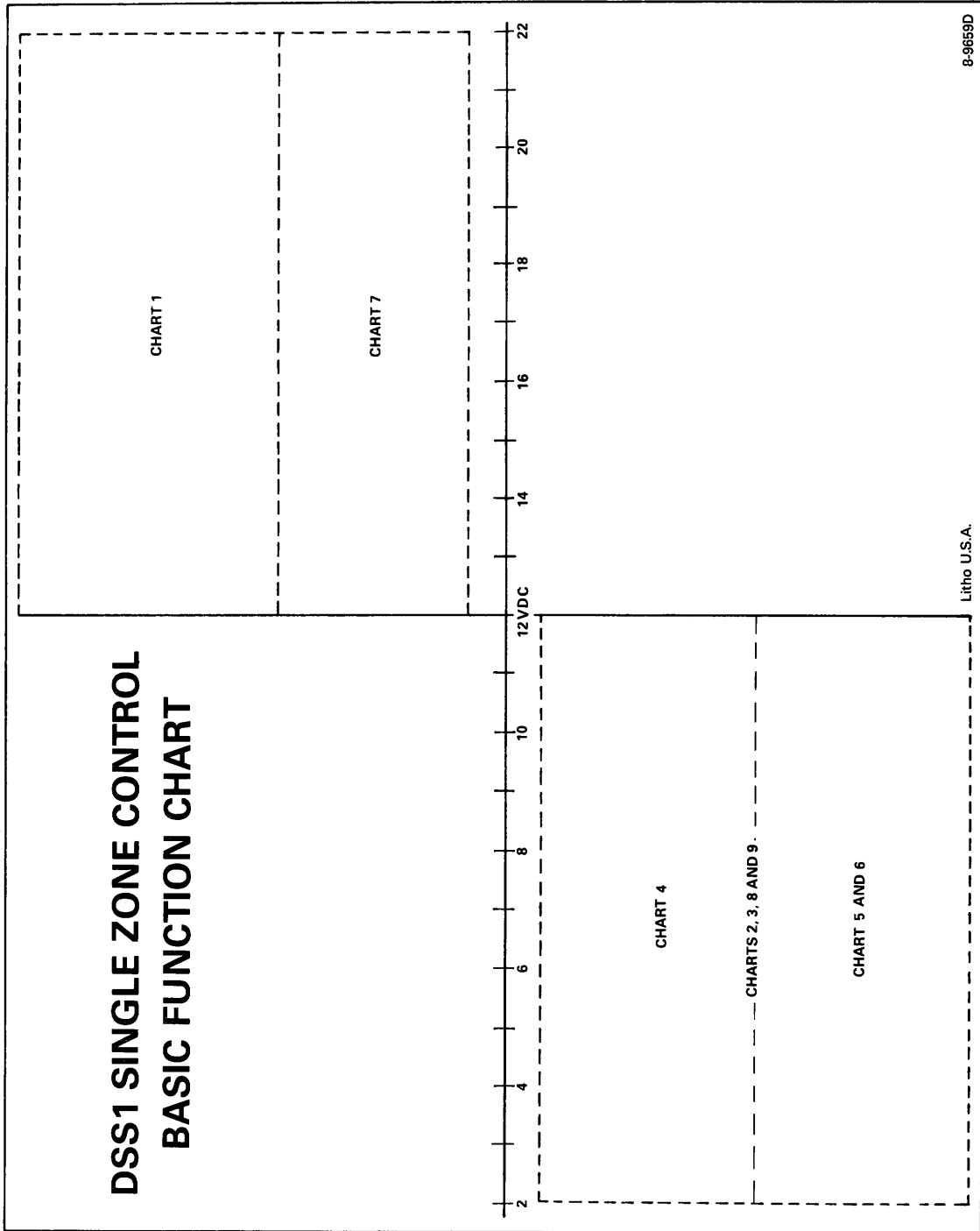

ELECTRIC HEAT

I - SEQUENCE OF OPERATION

Two stage electric heat is controlled by the Load Analyzer Module (H1 and H2 switches). Electric heat delay sequencers are used to step on electric elements. The first one-third of steps form first stage of heating. The next two-thirds of steps form second stage of heating. Table 2 lists electric heat ratings and the number of steps used to bring on elements.

NOTE: For units with supermarket heat reclaim option; switch H1 and H2 control reclaim coil, switch "H3" controls stage one of

electric heat and a thermostat in the return air compartment controls stage two electric heat.

An optional ambient thermostat (Figure 14) is used as a lockout for second stage heat. When temperature rises above set point, thermostat opens to lockout second stage heat during mild weather conditions.

The electric heat section is protected from overheating by two high temperature limit switches. The primary limit switch is located in the discharge opening of the unit as shown in Figure 15. The auxiliary limit switch is located at the top-rear of the electric heat elements.

TABLE 2

| No. of Elements | KW Input /Element | No. of Steps | Volts Input | 208V, 240V 480V, 600V | 220V 440V, 550V | 230V 560V, 575V |
|-----------------|-------------------|--------------|-------------|--------------------------|--------------------|--------------------|
| 2 | 2 @ 15 | 2 | KW Input | 30.0 | 25.2 | 27.6 |
| | | | Btuh Output | 102,000 | 86,000 | 94,000 |
| 3 | 3 @ 15 | 3 | KW Input | 45.0 | 37.8 | 41.4 |
| | | | Btuh Output | 154,000 | 129,000 | 141,000 |
| 4 | 4 @ 15 | 4 | KW Input | 60.0 | 50.4 | 55.1 |
| | | | Btuh Output | 205,000 | 172,000 | 188,000 |
| 5 | 5 @ 15 | 5 | KW Input | 75.0 | 63.0 | 68.9 |
| | | | Btuh Output | 256,000 | 215,000 | 235,000 |
| 6 | 6 @ 15 | 6 | KW Input | 90.0 | 75.6 | 82.7 |
| | | | Btuh Output | 307,000 | 258,000 | 282,000 |
| 7 | 7 @ 15 | 6 | KW Input | 105.0 | 88.2 | 96.5 |
| | | | Btuh Output | 358,000 | 301,000 | 329,000 |
| 8 | 8 @ 15 | 6 | KW Input | 120.0 | 100.8 | 110.3 |
| | | | Btuh Output | 410,000 | 344,000 | 376,000 |

HEATING

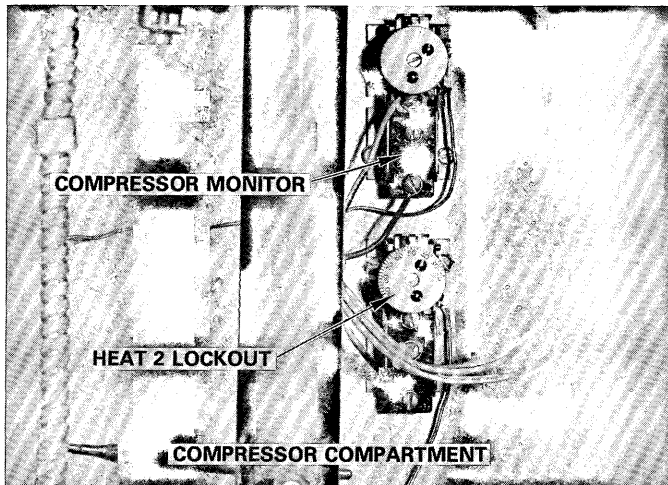

FIGURE 14

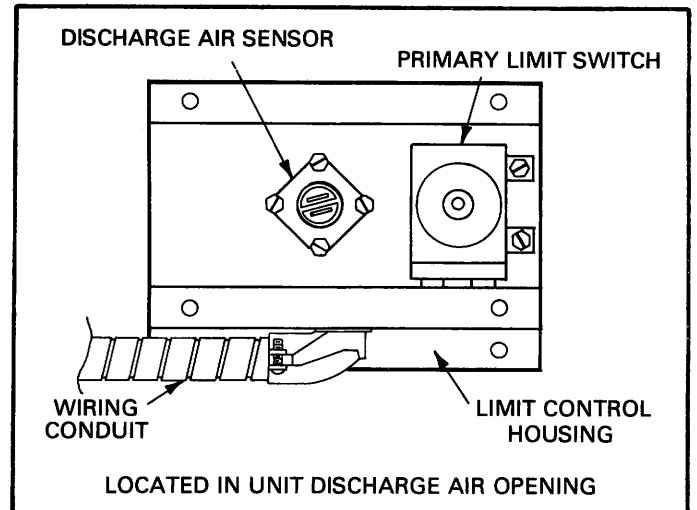

FIGURE 15

II - ELECTRIC HEAT SECTION

Parts arrangement and identification of electric section are shown in Figures 16 and 17. Refer to figure title for proper unit identification.

III - INITIAL ELECTRIC HEAT START-UP

- 1 - Close main disconnect switch(es). Indoor blower and return air blower should start after a time delay of approximately 30 seconds. Units with smoke detection will have an additional 90 seconds delay on main blower to allow dampers to open.
- 2 - Refer to section "System Check Using Load Simulator" on page 11 to verify proper sequencing and heating operation.

- 3 - Provide a full heating demand to energize all elements. Using a clamp-on ammeter, check amperage draw of each wiring lead from heater contactors to heater elements. All elements of the same KW rating should measure approximately the same amperage draw. If so, all heater elements are operating normally. If a wiring lead does not register a normal reading, it indicates that element is not operating properly and should be checked.
- 4 - If power is interrupted or heating demand is satisfied, a lockout circuit assures proper resequencing.

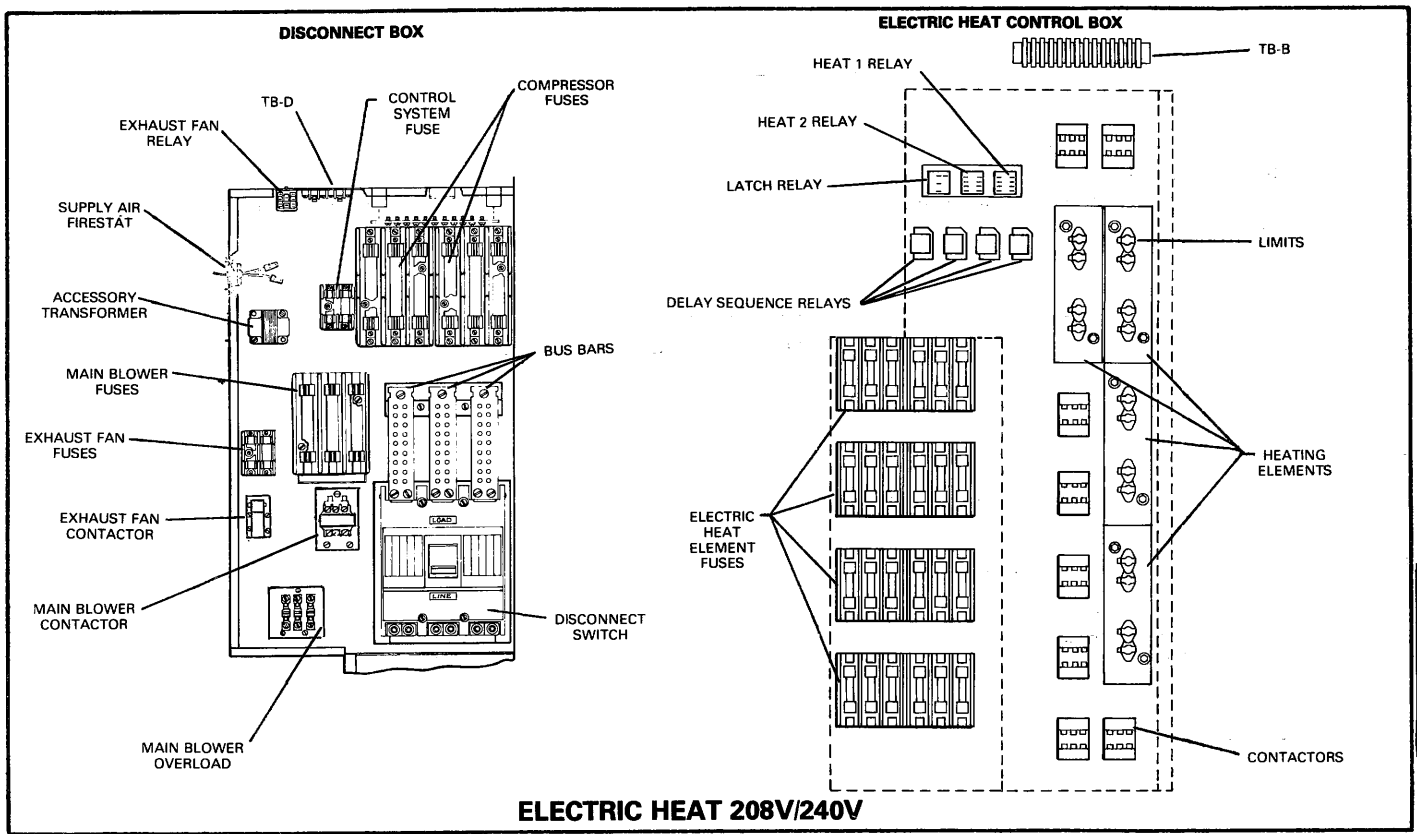

FIGURE 16

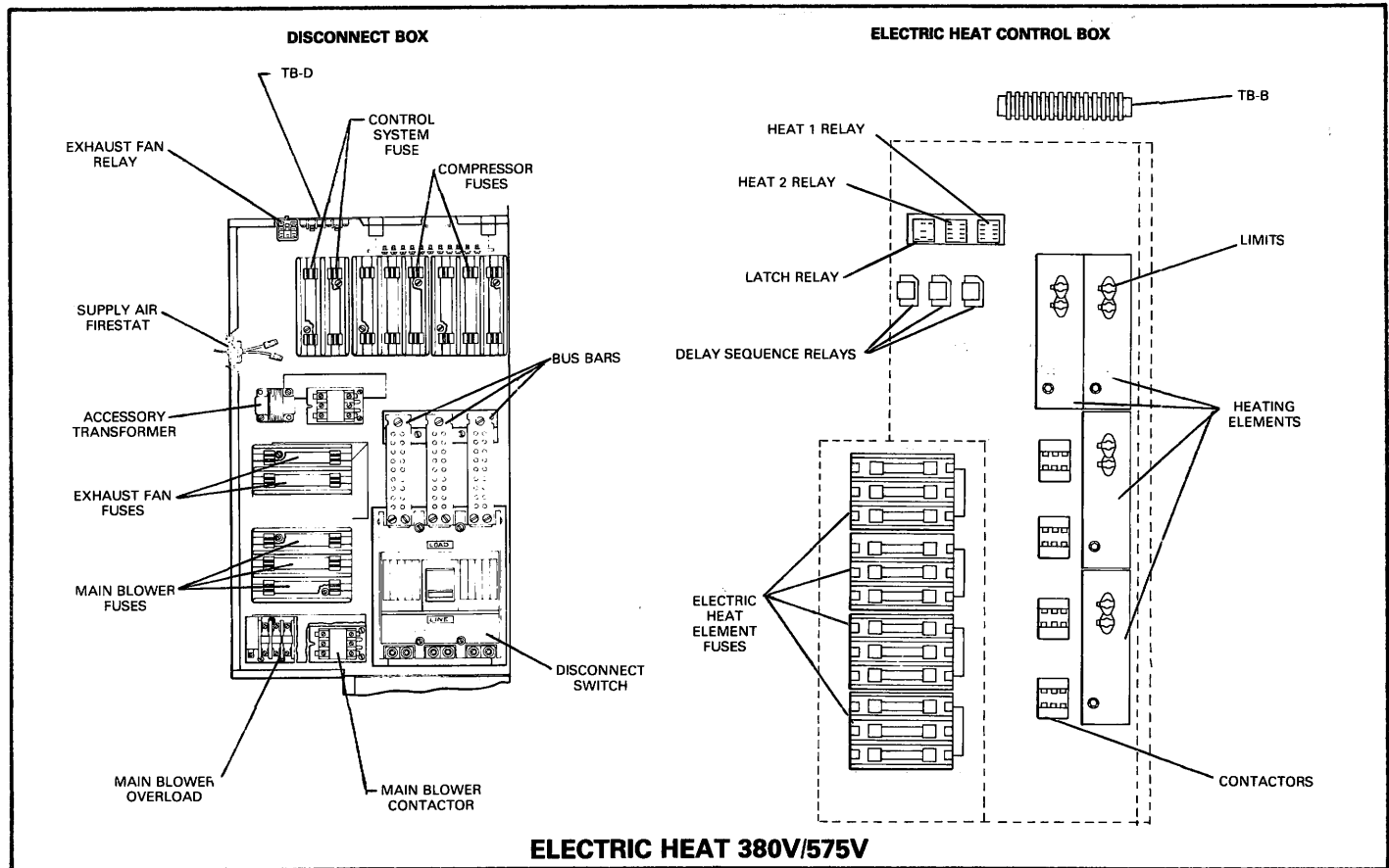

FIGURE 17

HEATING

HOT WATER HEAT

I - HOT WATER HEAT SECTION

Figure 18 shows DSS1 hot water heat section with optional motorized control valve.

NOTE - The valve is secured to the support bracket for shipping purposes only. Remove the two shipping bolts as shown.

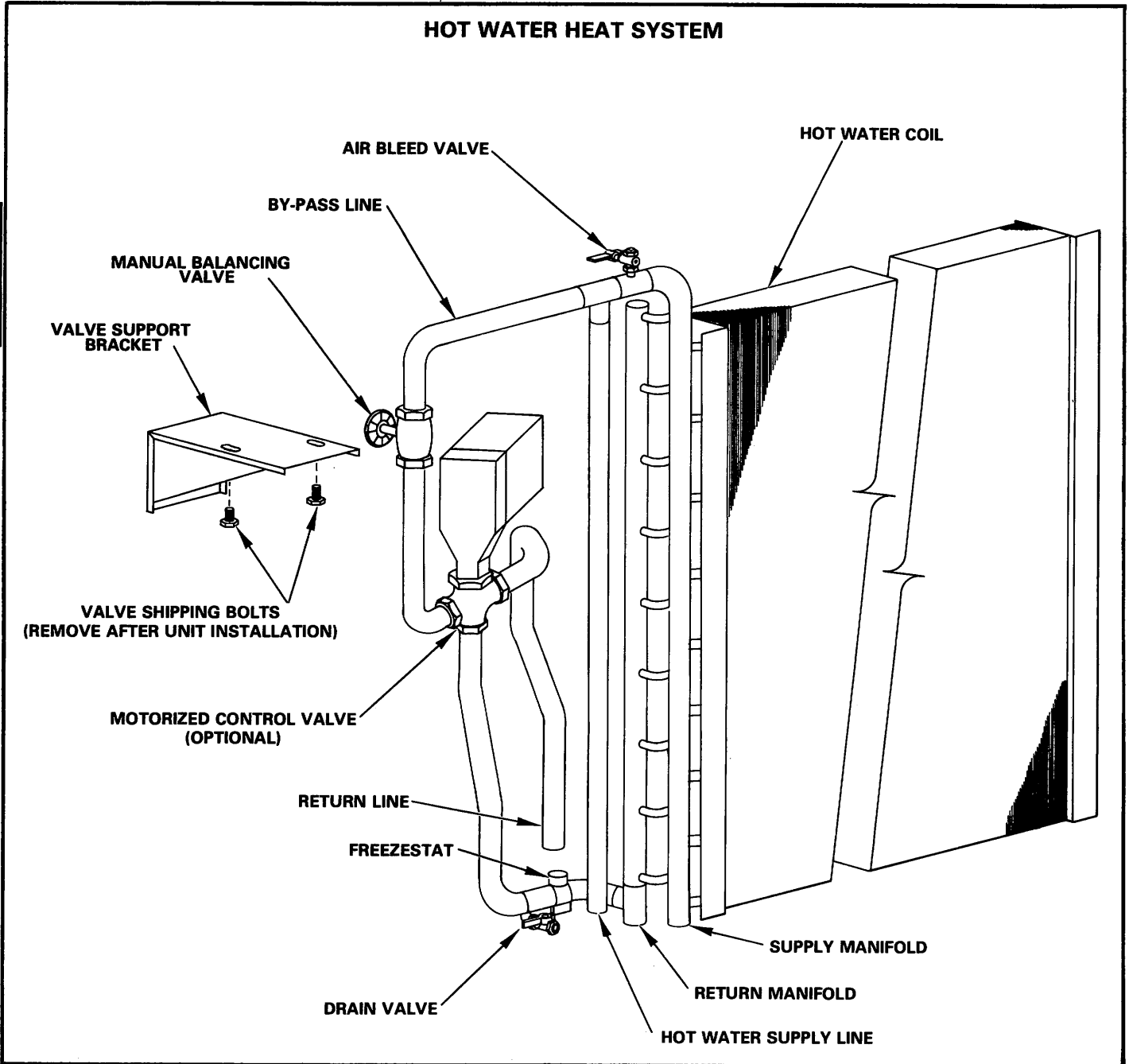

FIGURE 18

HEATING

II - CHECKING MOTORIZED CONTROL VALVE

- 1 - Close main disconnect switch(es).
- 2 - Using load simulator, set command voltage at 12 VDC (no heat). Refer to page 12 , section "III - System Check Using Load Simulator." Valve motor shaft should rotate counterclockwise lowering valve stem. Refer to Figure 19.
 - a - At end of stroke, notch in motor shaft should be up, at an angle 10° to right of vertical.
 - b - Motor should be free to run its complete stroke.
 - c - With valve in this position, by-pass line is open and water flow to coil is closed.

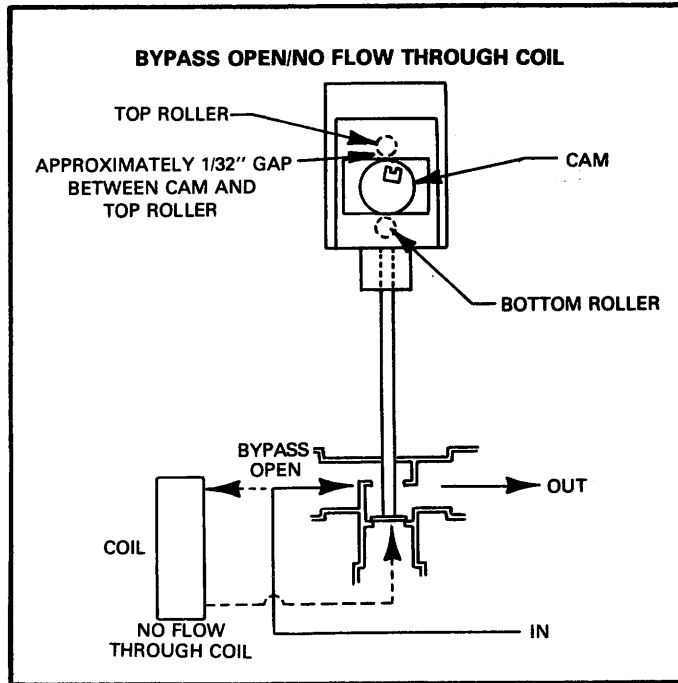

FIGURE 19

- 3 - Using load simulator, set command voltage to 2 VDC (full heat). Valve motor shaft should rotate clockwise, raising valve stem. Refer to Figure 20.
 - a - At end of stroke notch in motor shaft should be down, at an angle 10° to right of vertical.
 - b - With valve in this position, by-pass line is closed and water flow through coil is open.

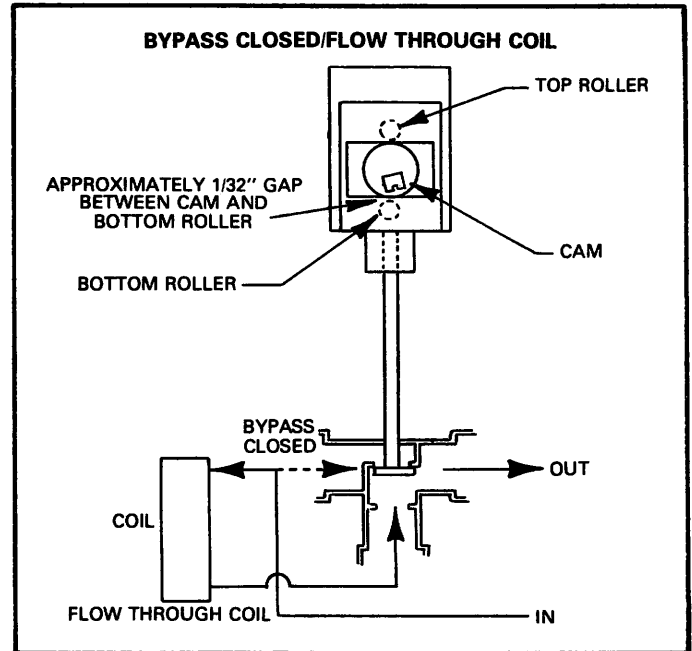

FIGURE 20

III - MANUAL BALANCING VALVE

The manual balancing valve is located in the by-pass line of the hot water system. This valve should be adjusted to obtain a pressure drop through the by-pass line equal to the pressure drop through the hot water coil.

HEATING

SUPERMARKET HEAT RECLAIM (NOT USED ON HEAT PUMP UNITS)

I - SUPERMARKET HEAT RECLAIM SECTION

The location and arrangement of the reclaim coil in the unit is shown in Figure 21.

II - APPLICATION

The consulting engineer, architect or dealer must determine the supermarket heat reclaim coil characteristics for the individual unit application. This includes coil size, coil manifold procedure, piping procedure and external control placement and operation.

III - OPERATION

Units equipped with supermarket heat reclaim option are also provided with the control system designed to operate the reclaim coil and unit cooling system as a dehumidification/reheat system.

The following is a brief description of heat reclaim and dehumidification/reheat operation. For a detailed supermarket reclaim sequence of operation refer to page 12, section "III - Function Charts"

Supermarket Heat Reclaim
Supermarket heat reclaim is controlled by the Load Analyzer Module (H1 & H2 switch). As a heat demand is received from the room transmitter switch H1 activates the first stage of the reclaim coil. If more heat is required, the second stage of the reclaim coil is activated by H2. If additional heat is required, H3 will energize the first stage of electric heat or the valve begins to open in proportion to the load on hot water heat units. A thermostat in the return air stream will energize the second stage of electric heat if the space is calling for full heat and the return air temperature is low.

Dehumidification/Reheat Option

The dehumidification/reheat system is controlled by the humidistat located in the unit return air compartment. When humidity rises above humidistat set point, compressor #1 and reheat system are energized. The supermarket heat reclaim coil is then energized to reheat the chilled air which provides dehumidification without overcooling.

Dehumidification/Reheat Option

The dehumidification/reheat system is controlled by the humidistat located in the unit return air compartment. When humidity rises above humidistat set point, compressor #1 and reheat system are energized. The supermarket heat reclaim coil is then energized to reheat the chilled air which provides dehumidification without overcooling.

HEATING

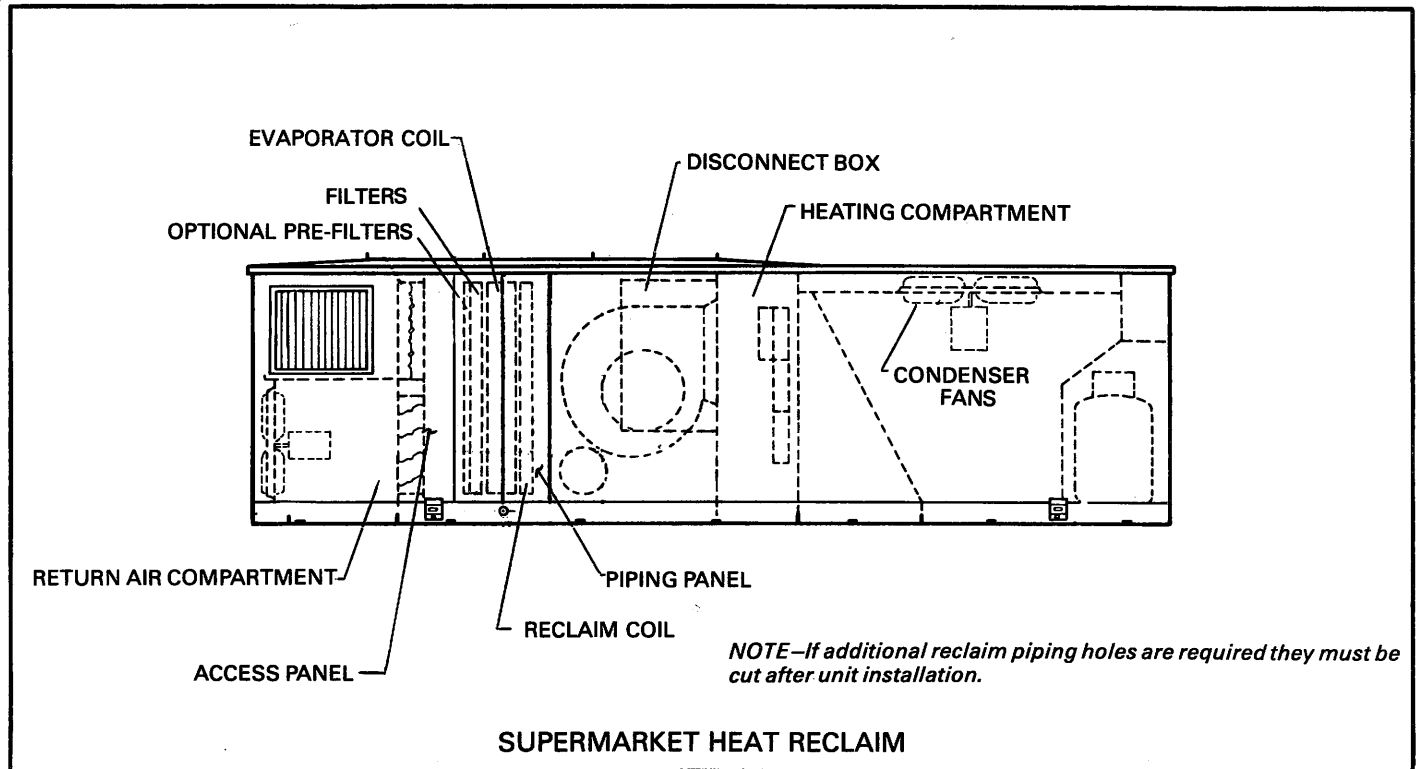

FIGURE 21

POWER SAVER

I - POWER SAVER ACTUATOR

DSS1 units are equipped with either Ranco LA2 or Honeywell M745 actuators. If unit is not equipped with a smoke detector system, only one actuator controls outdoor and return air damper operation. Refer to Figure 22. On units equipped with smoke detection, two

actuators control damper modulation. Refer to Figure 23. Outdoor damper actuator is direct acting. The shaft is retracted at 14 VDC and extended at 17 VDC. Return air damper actuator is reverse acting. The shaft is extended at 14 VDC and retracted at 17 VDC.

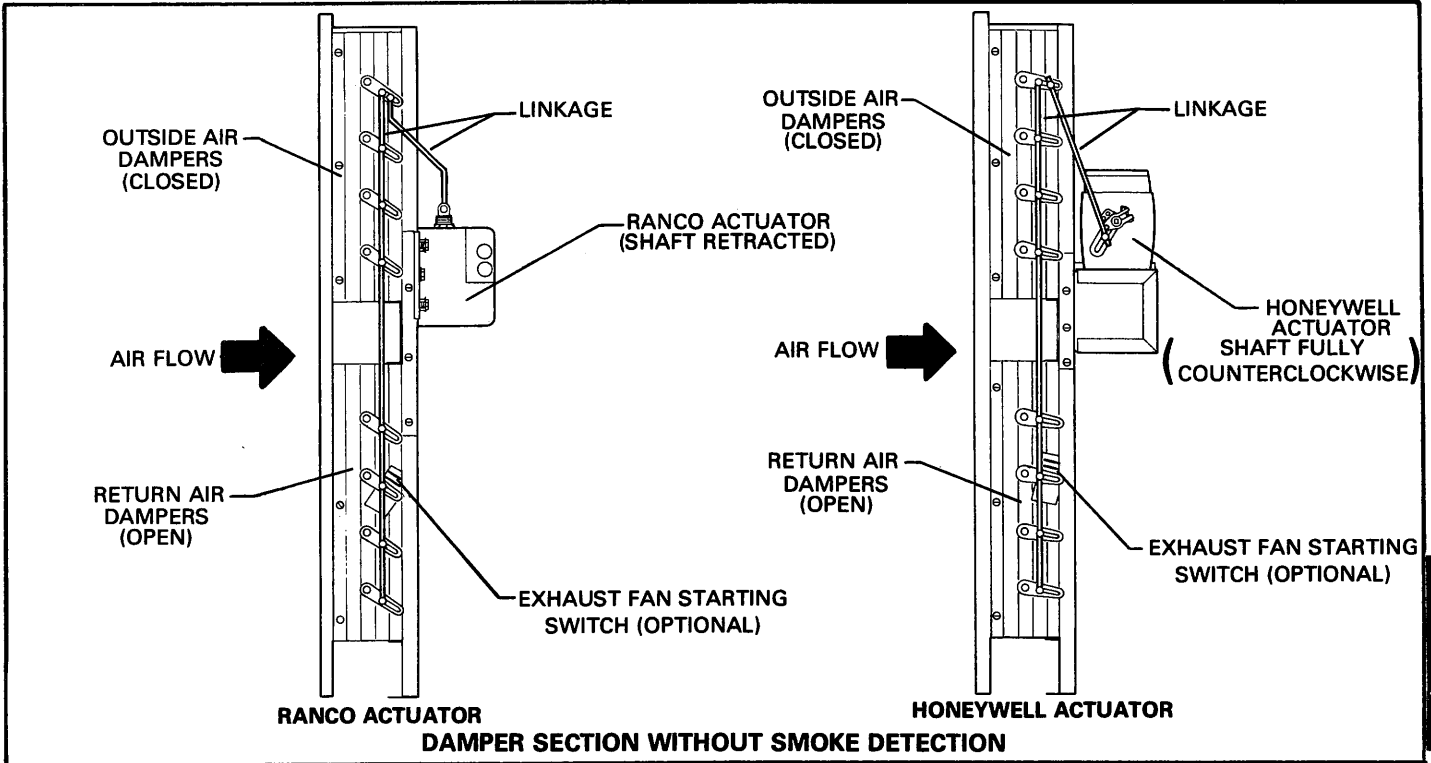

FIGURE 22

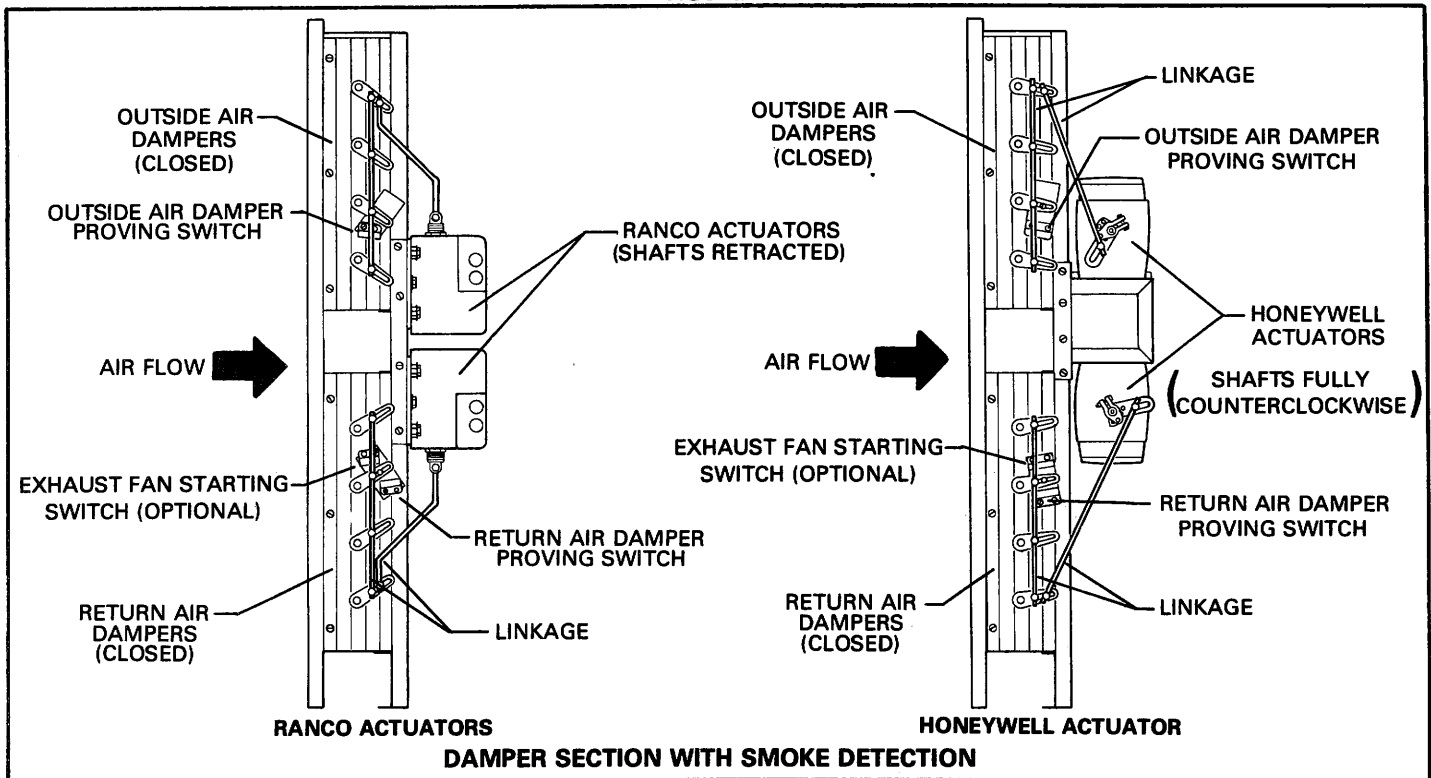

FIGURE 23

COOLING

II - CONTROL SETTING

Refer to Table 3 for location and setting of controls.

TABLE 3

| CONTROL | SETTINGS | LOCATION |
|-------------------------|-----------------------------|----------------------|
| Enthalpy Control | "A" Adjustable | Outside air inlet |
| Morning Warm-Up Control | 70°F (21.2°C) Adjustable | Power Saver |
| Minimum Air Control | 0-100% Adjustable | Outside Air Actuator |

III - INITIAL POWER SAVER START-UP

1 - Close main disconnect switch(es). After a time delay (approximately 30 seconds), return air blower and main blower will start.

NOTE - If unit has smoke detection, one set of dampers must open before main blower starts.

2 - See section "III - System Check Using Load Simulator" on page 12 to verify damper modulation. Refer to Table 3 for power saver control setting.

IV - ADJUSTMENTS

A - Damper Adjustment

Dampers are factory adjusted and should not require adjustment. If adjustment is necessary, use the following as a guide.

NOTE - Dampers are designed to rotate 67°. Do not try to obtain 90° travel.

Power Saver With Smoke Detector - Shut off power to unit. Both power saver actuators will spring return outside and return air dampers to the fully closed position. Check each damper blade and adjust individually as required.

Power Saver Less Smoke Detector - Fully open outdoor air dampers by setting load simulator above 17 VDC. Return air dampers should fully close. Check each damper blade and adjust individually if necessary.

Shut off power to unit. Damper actuator will spring return outside air dampers to the fully open position. Check each damper and adjust individually if necessary.

B - Enthalpy Control

The enthalpy control is located in outdoor air inlet of unit. See Figure 31. This control prevents excessive moisture laden outdoor air from entering the system by sensing total heat content of the outdoor air. The recommended set point is "A" shown in Chart A. If power saver is allowing air which is too warm or humid to enter system, control may be changed to a lower set point. Refer to Chart A.

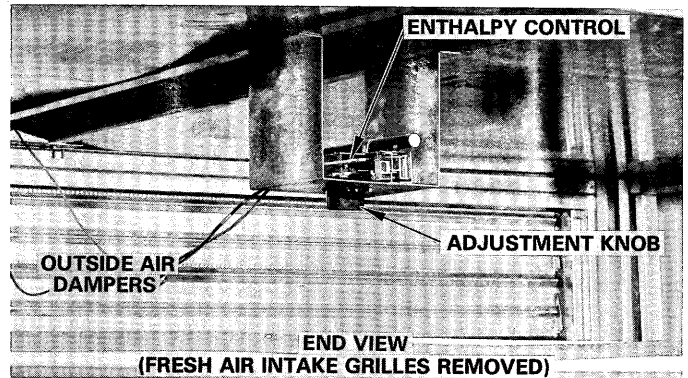
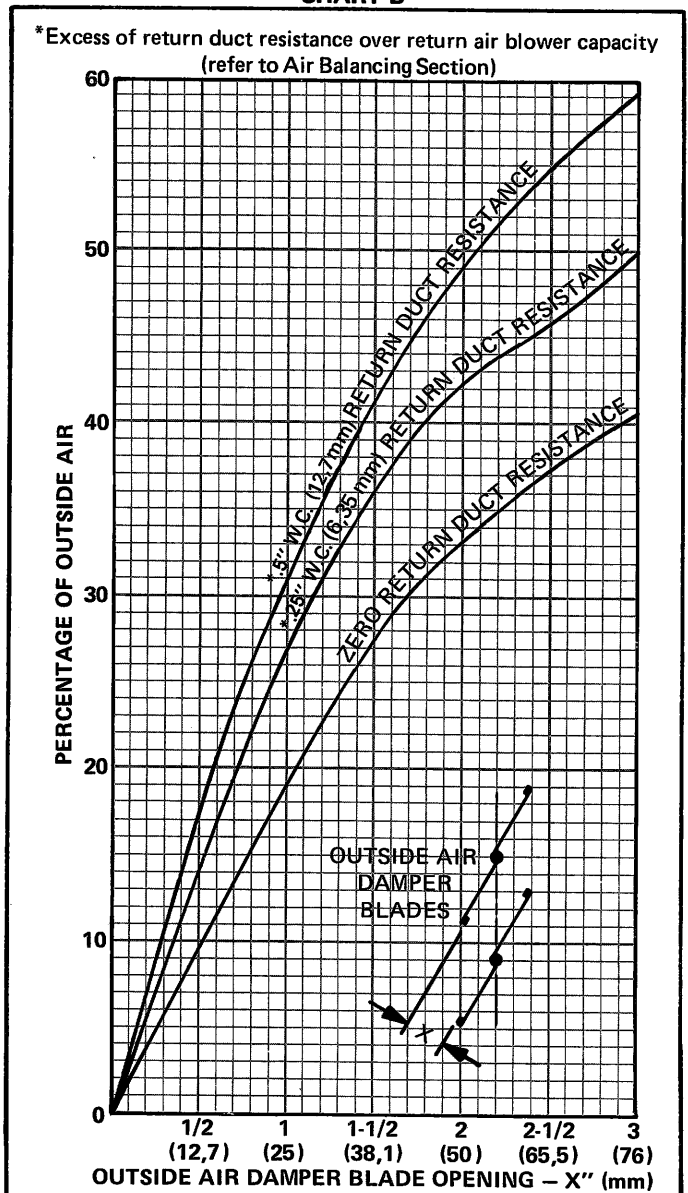

FIGURE 24

CHART B



COOLING

CHART A

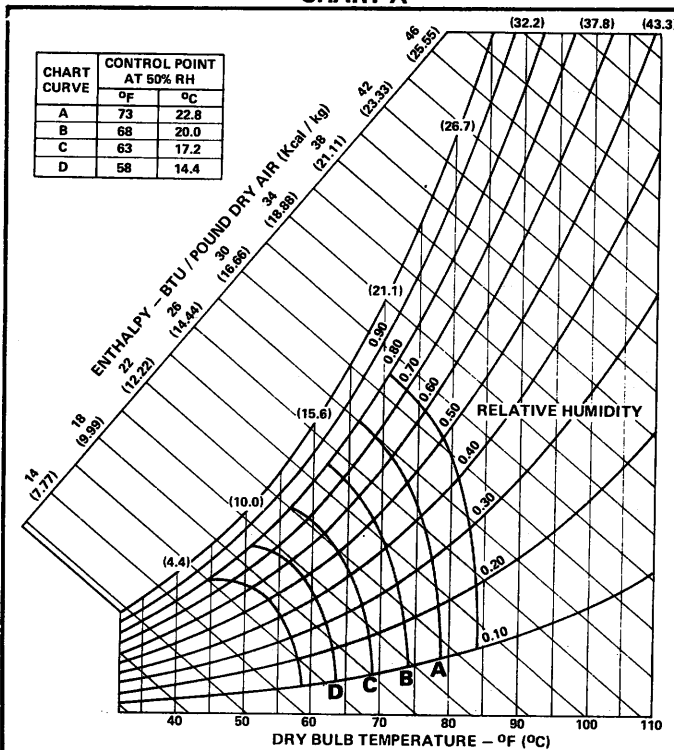

C - MINIMUM POSITIONER

Standard minimum positioner is located in the unit on the outside air damper actuator. Refer to Figure 25 for Ranco actuator or Figure 26 for Honeywell Actuator.

Adjust minimum positioner with outside dampers at minimum position. Turn setting on enthalpy control to "D" setting or use load simulator to drive dampers to minimum position. Rotate screw clockwise to open dampers or counterclockwise to close dampers. Refer to Figure 25 for Ranco actuator or Figure 26 for Honeywell actuator. See Chart B for percentage of fresh air versus dimensional opening of blade at system static pressure.

IMPORTANT - After adjustment is completed, return enthalpy control to its normal setting.

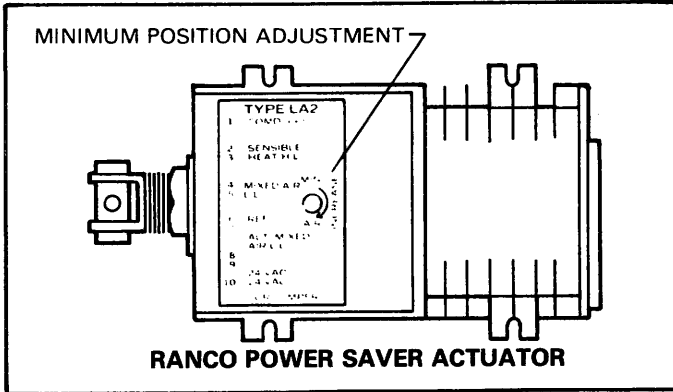

FIGURE 25

D - Damper Proving Switches

Damper proving switches are provided on all units equipped with smoke detectors. Mercury switches are mounted on the linkage of return and outside air dampers. Refer to Figure 23.

On unit start-up, either the return or outside air dampers must open before switch will prove the circuit allowing indoor blower operation.

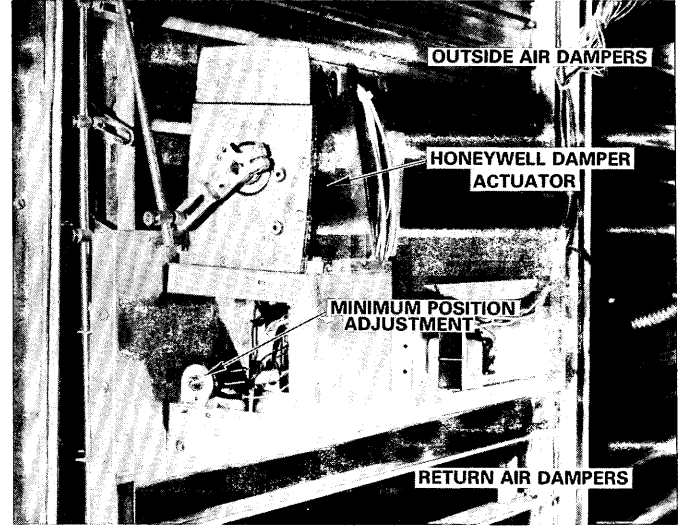

FIGURE 26

REFRIGERANT COOLING

I - COMPONENT LOCATION

Refer to Figure 28 for component location and identification in the compressor compartment. Figure 27 shows the location of the liquid line service valves in the blower compartment.

II - REFRIGERANT CIRCUITING

Units are equipped with two compressors which have individual refrigerant circuits for each compressor. These circuits are numbered for identification. Refer to Figure 29 for refrigerant circuit schematic.

III - REFRIGERANT CONTROLS

A - Protection Controls

Refrigerant circuits are internally protected with a high pressure control, low pressure control, discharge gas thermostat and low ambient cut-out thermostat. These controls are internal to the compressors and non-adjustable. Refer to Table 4. Table 4 also lists the optional cooling controls, their settings and locations.

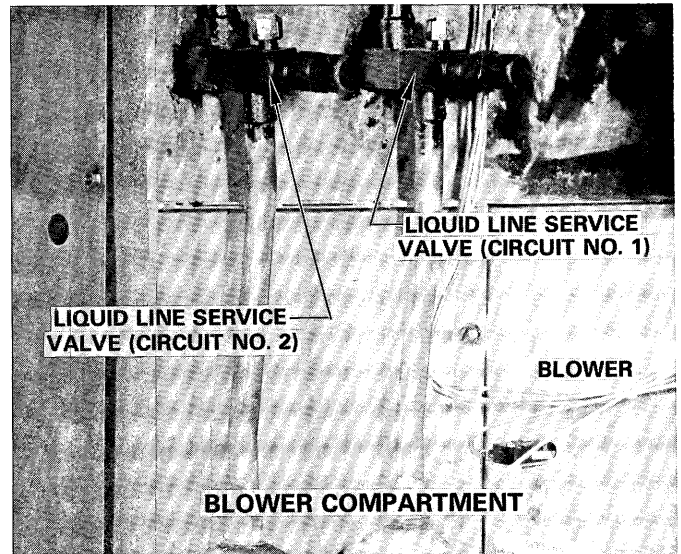

FIGURE 27

COOLING

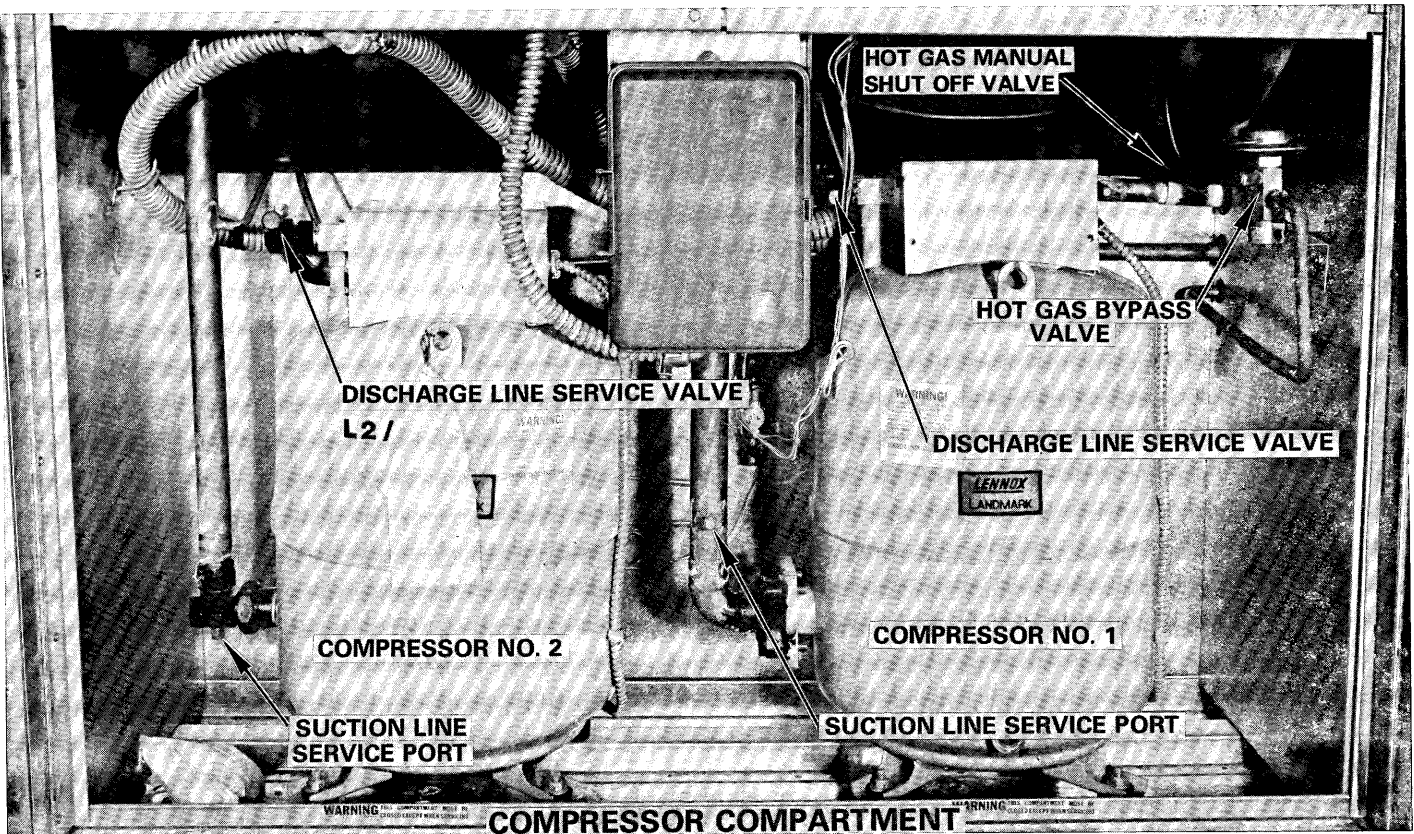

FIGURE 28

REFRIGERANT PIPING

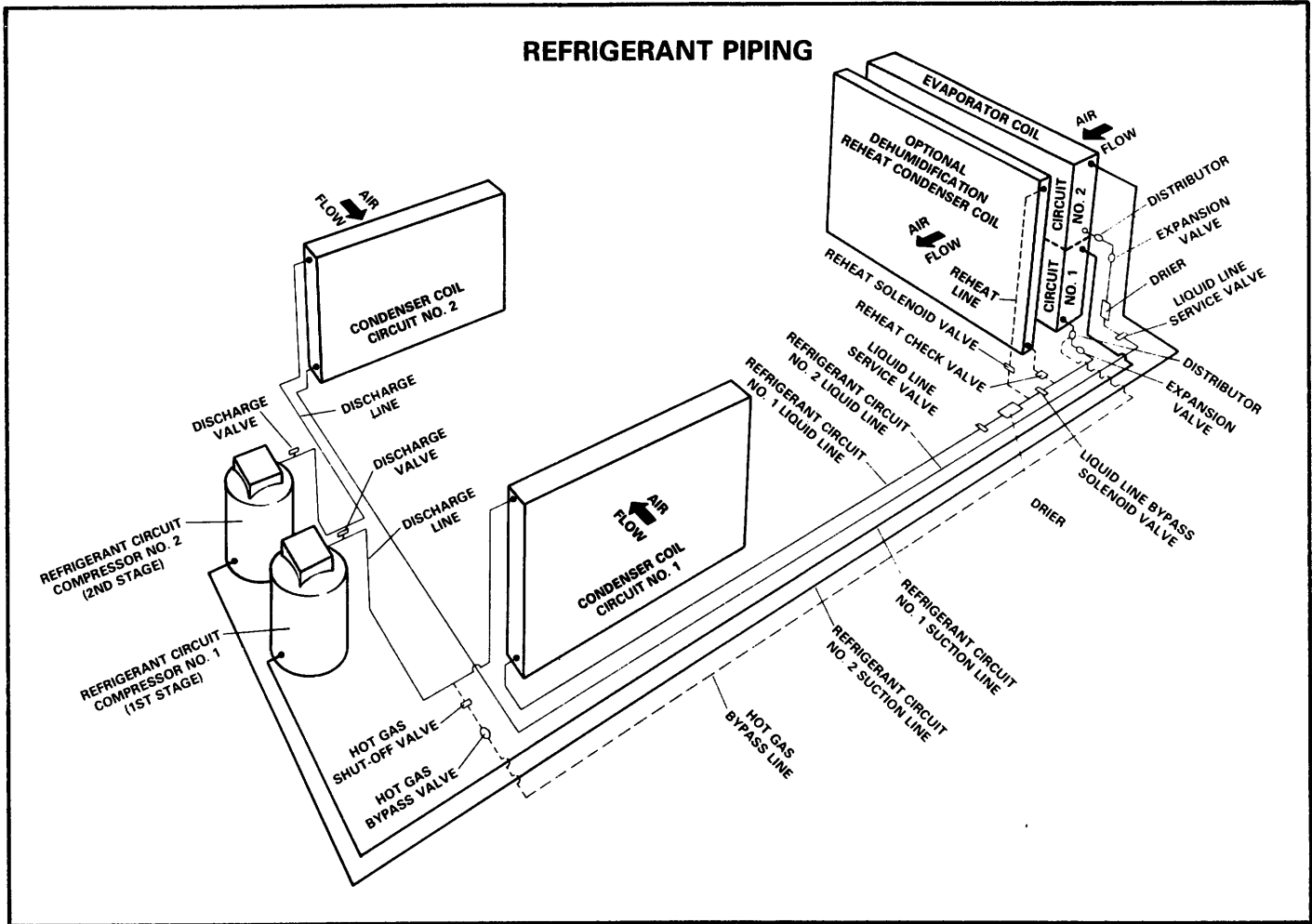

FIGURE 29

TABLE 4

| CONTROL | SETTING | LOCATION |
|---|--|------------------------|
| High Pressure Control (All Compressors) | 410 psi - out (28,8 Kg/cm ²) | Internal to Compressor |
| Discharge Thermostat | 300°F (149°C) | Internal to Compressor |
| Low Ambient Cut-out Thermostat | 22°F - opens (-5,5°C) 32°F - closes (0°C) | Internal to Compressor |
| Compressor Monitor | 57°F - opens (13,7°C) | Compressor Compartment |
| Hot Gas By-Pass Valve | 59 psi - opens (4,14 Kg/cm ²) | Compressor Compartment |
| Low Ambient Thermostat | 55°F - opens (12,6°C) | Compressor Compartment |
| Humidistat | Adjust for Unit Application | Return Air Compartment |

Note-If in-winding sensors lockout compressor allow one hour for protection to reset.

B - Compressor Monitor

Compressor monitor is provided on all units equipped with power saver. It is also used on units without power saver when optional low ambient kit is not used.

This control (located in compressor section) locks out compressors when outdoor air drops below adjustable set point. If compressors operate more than desired in cool weather, raise the control setting

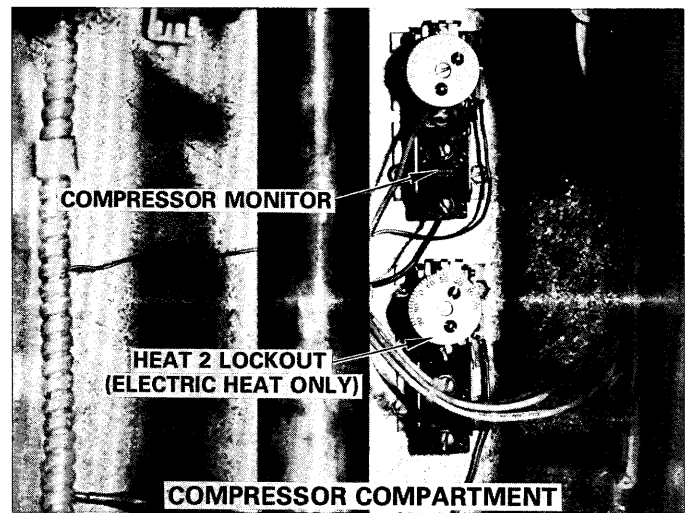

FIGURE 30

above the recommended setting of 57°F (13,7°C). See Figure 30 and Table 4.

C - Low Ambient Control

Second stage compressor is locked out by an adjustable thermostat, factory set at 55°. First stage condenser fan is controlled by a low pressure switch. Fan starts at 285 psig (20 kg/cm²) and stops at 140 psig (9,8 kg/cm²). These are factory settings, however the controls are adjustable. Refer to Figure 31 and Table 4.

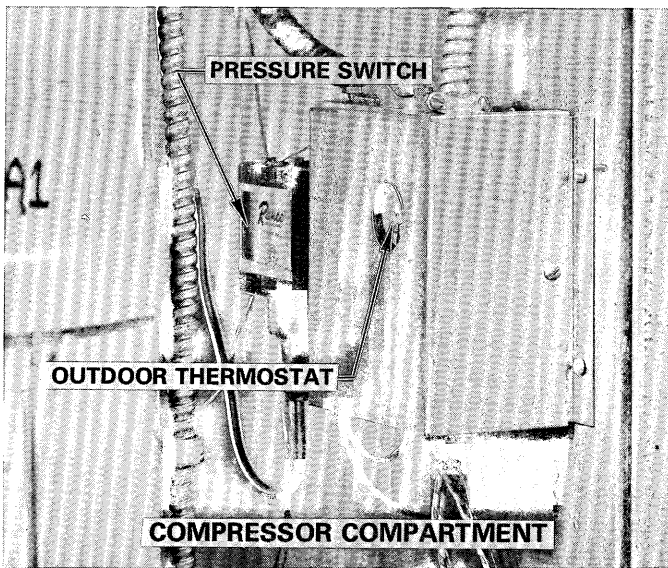

FIGURE 31

D - Humidistat

The humidistat (optional) is located in the return air compartment. It controls the dehumidification/reheat option.

This adjustable control has a range of 20% to 80% relative humidity. Refer to Figure 32 and Table 4. The set point will vary and should be adjusted to maintain desired humidity level in conditioned space.

NOTE - To conserve energy do not set humidistat too low. As the humidity set point is lowered, unit operation will increase to maintain desired conditioned levels.

Dehumidification/Reheat Option

When relative humidity rises above humidistat set point compressor #1 and reheat system are energized for dehumidification. When humidity falls below set point, system is de-energized.

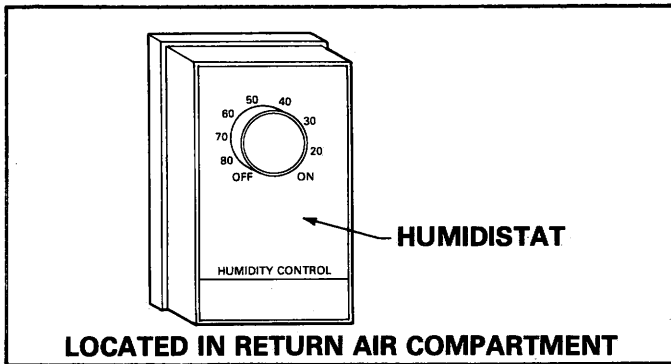

FIGURE 32

E - Hot Gas By-Pass

The optional hot gas by-pass valve is located in the compressor compartment. Refer to Figure 28 and Table 4.

This valve is regulated by the suction line pressure of compressor #1. It operates to maintain suction pressure of circuit #1 no lower than 58 psig (4,1 kg/cm²), which prevents evaporator coil freeze-up during reduced capacity operating conditions.

The hot gas system is also equipped with a manual main shutoff valve. See Figure 28. This valve should be closed during refrigerant circuit pumpdown and may be used for a manual shutoff of the hot gas system.

IV - INITIAL START-UP

NOTE - Crankcase heaters must be energized 24 hours before starting compressors. After 24 hours, install compressor fuses provided in cloth bag on compressor.

- 1 - Close main disconnect switch(es). After a time delay, return air blower and main blower should start.
- 2 - Refer to section "III - System Check Using Load Simulator" on page 12 to verify cooling operation.
- 3 - Compressor starting may be delayed by the compressor timed interlock. Timed-off period is 3 minutes.

NOTE - Compressor timed interlock may delay compressor operation when using load simulator.

V - REFRIGERANT CHECK

- 1 - Attach gauge manifold. Refer to Figure 28 for service valve identification.
- 2 - Check each circuit separately. Set room sensor or load simulator as low as possible to provide a full cooling demand.
- 3 - Allow system to run for a few minutes to stabilize system.
- 4 - Using a thermometer, find condenser entering air temperature. Read suction and discharge pressures on gauge manifold.
- 5 - Refer to correct normal operating pressure curve on pages 38 and 39. Find suction pressure in lefthand column. Follow across the curve to correct outdoor coil entering air temperature. Mark this point, then read discharge pressure directly below. If discharge reading is within 3 psig (0,21 Kg/cm²) of gauge manifold reading, system is properly charged.
- 6 - If there is a loss of charge in a circuit, remove compressor fuses from that circuit to prevent compressor from cycling on low pressure control. Refer to Lennox Service Manual for leak checking, evacuating and charging procedures.
- 7 - After charging is completed, disconnect gauge manifold and restore unit to operating condition.

NOTE - The No. 1 compressor circuit has an optional hot gas by-pass valve that must be closed (front seated) before charging the circuit. This prevents refrigerant from by-passing through hot gas circuit thus giving false charging values.

VI - COMPRESSOR OIL CHARGE

The L2 compressors carry a charge of 132 oz. (3, 74 kg) of oil. The oil type varies with the compressor model number. If any replacement oil is required, the proper oil must be used. The oil type used for the L2-09724, L2-12724, and L2-07223 compressors is Freezene 150.

VII - REFRIGERANT CHARGE

Each compressor is charged with R-22 refrigerant. All coils have 3/8" (5mm) tubing. Refer to the following for compressor charge.

DSSI-180 Compressor#1 — 15¼ lbs. (6,9 kg)

DSSI-180 Compressor#2 — 12 lbs. (5,4 kg)

DSSI-260 Compressor#1 — 21 lbs. (9,5 kg)

DSSI-260 Compressor#2 — 21 lbs (9,5 kg)

NOTE: The same compressor charge will be used with reheat and without reheat.

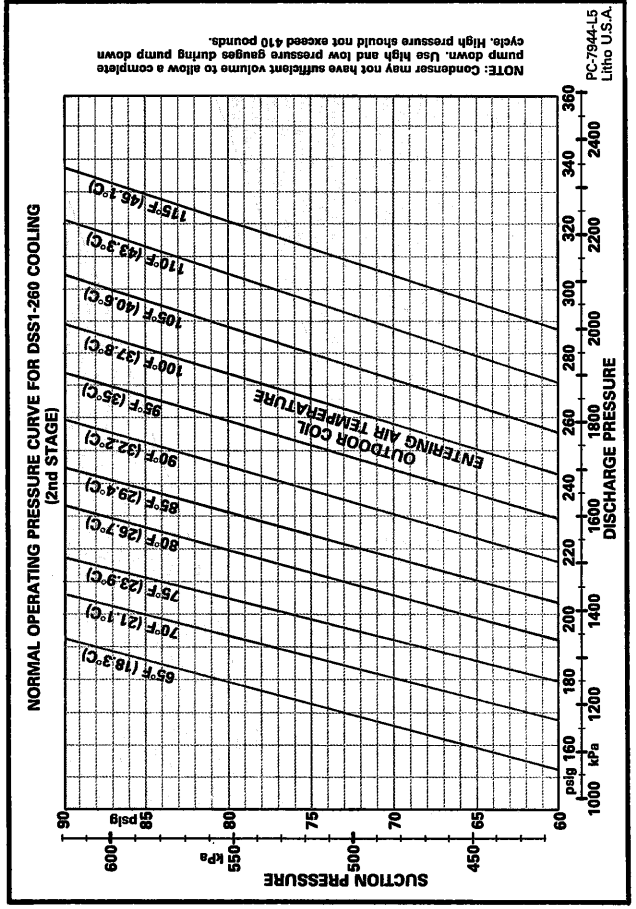
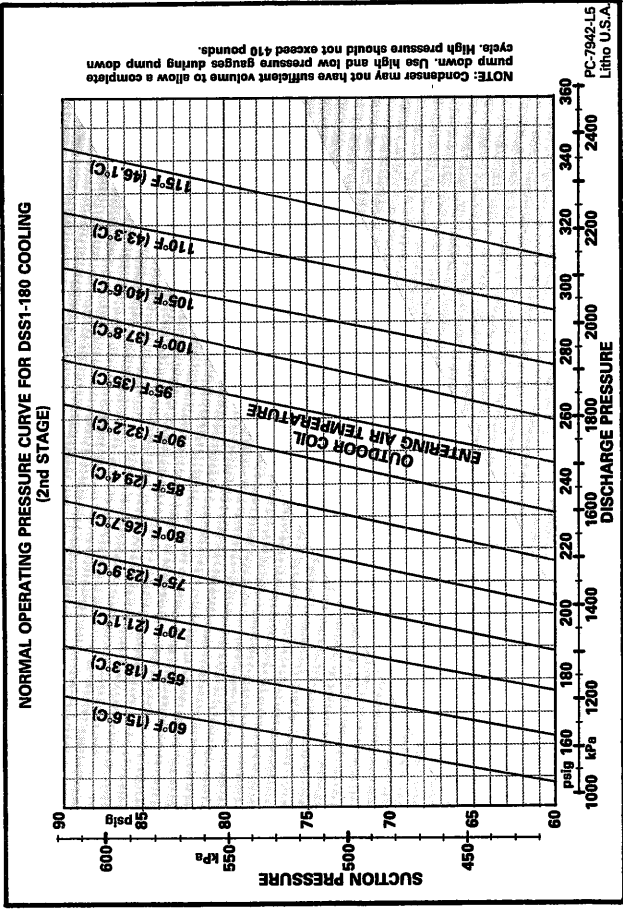
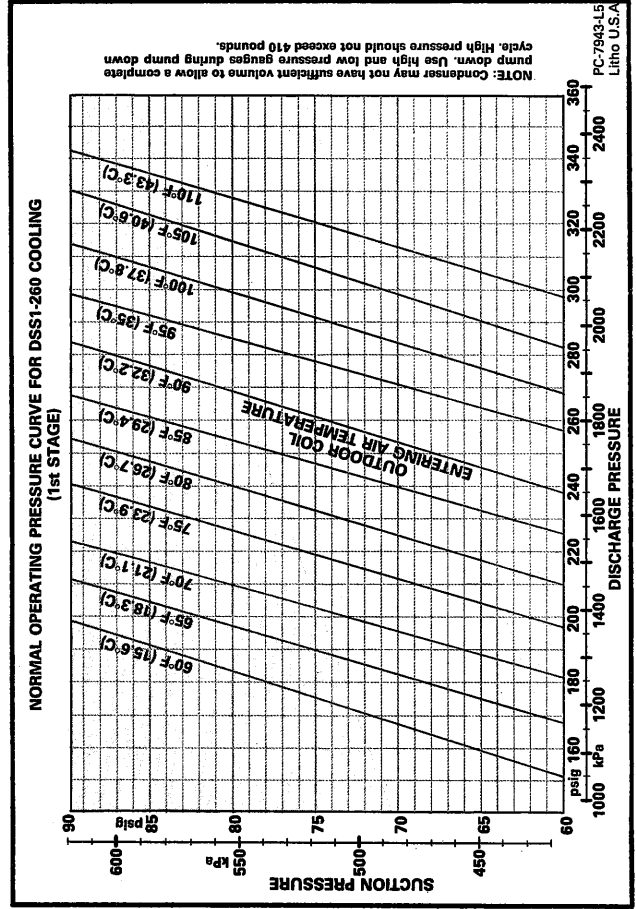
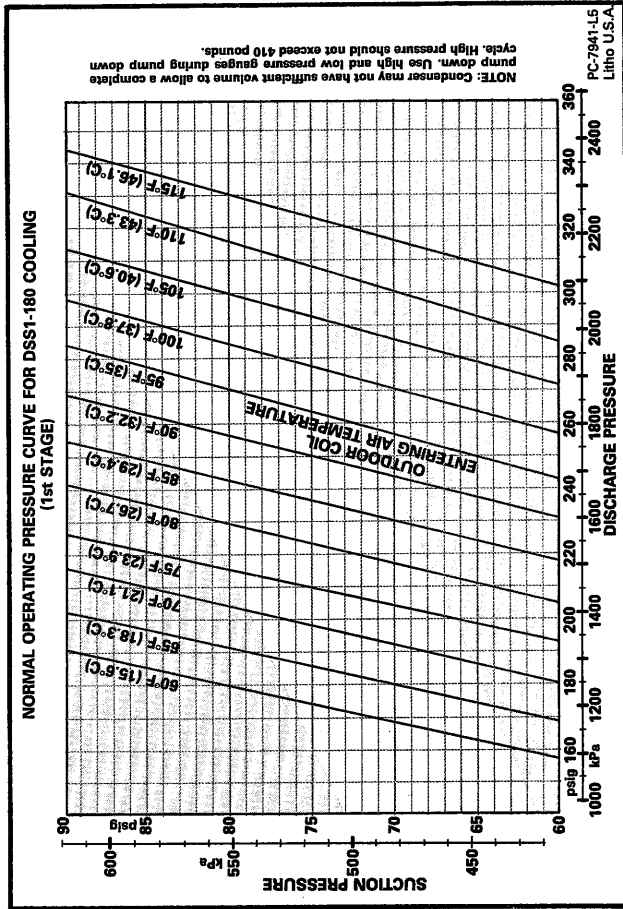

COOLING

HEAT PUMP

I - COMPONENT LOCATION

Refer to Figure 33 for component location and identification in the compressor compartment. Figure 34 shows the location of the liquid line service valves in the blower compartment.

II - REFRIGERANT CIRCUITING

Units are equipped with two compressors which have individual refrigerant circuits for each compressor. These circuits are numbered for identification. Refer to Figure 35 for refrigerant circuit schematic.

III - REFRIGERANT CONTROLS

A - Protection Controls

Refrigerant circuits are internally protected with a high pressure control, low pressure control, discharge gas thermostat and low ambient cut-out thermostat. These controls are internal to the compressors and non-adjustable. Refer to Table 5. Table 5 also lists the optional cooling controls, their settings and locations.

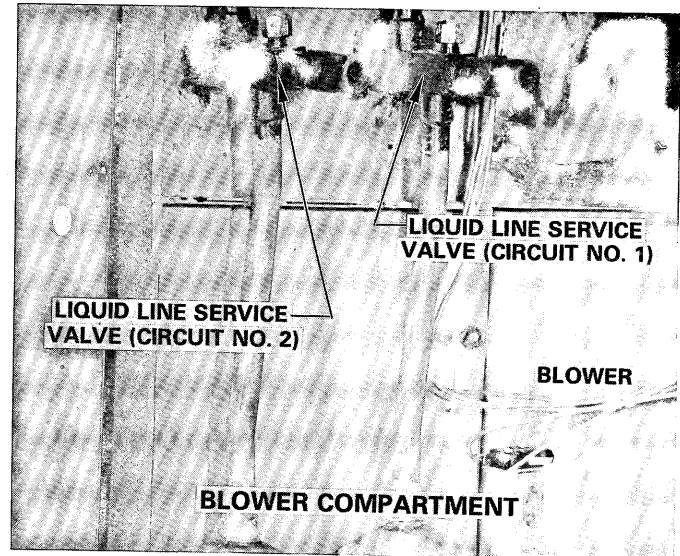

FIGURE 34

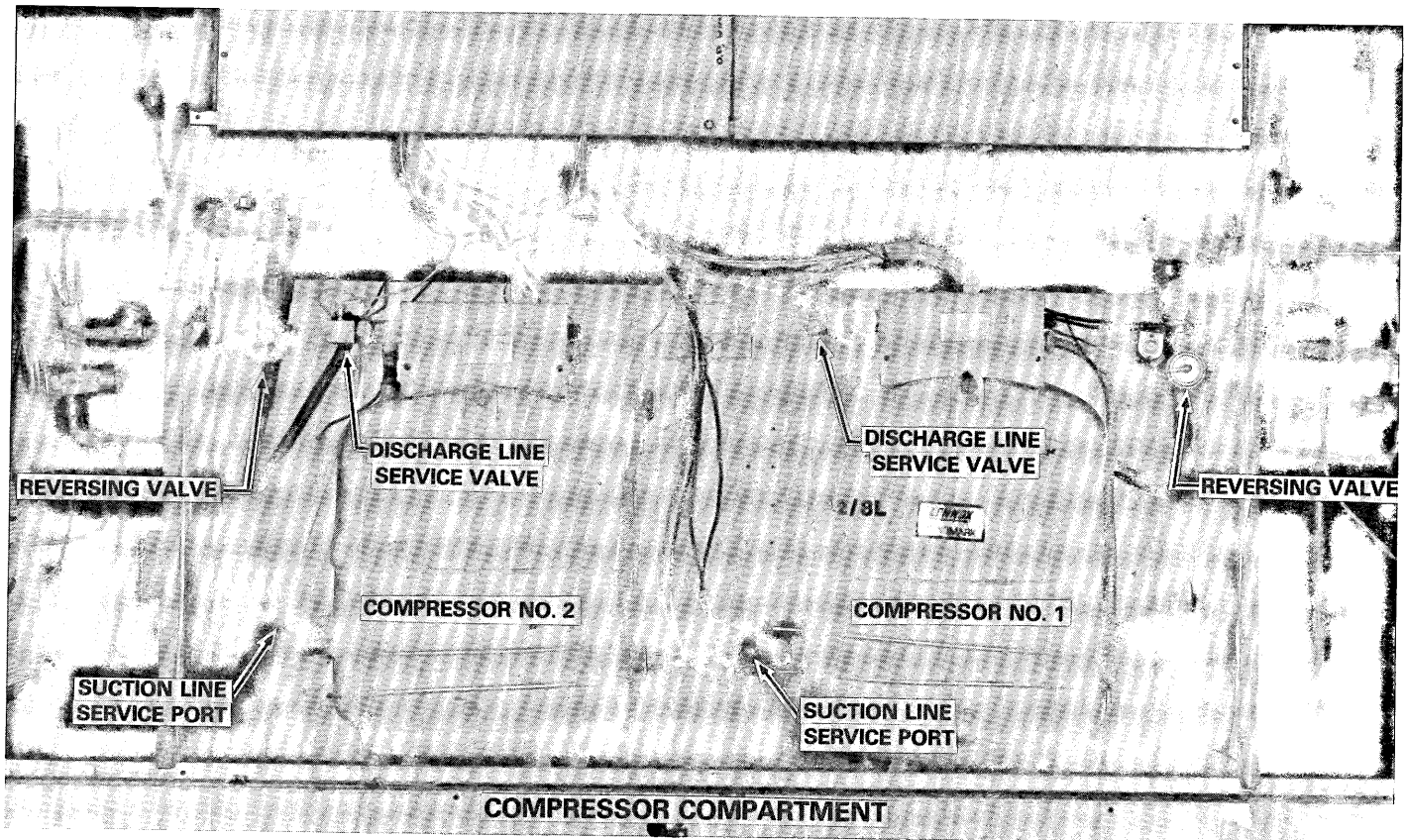

FIGURE 33

REFRIGERANT PIPING

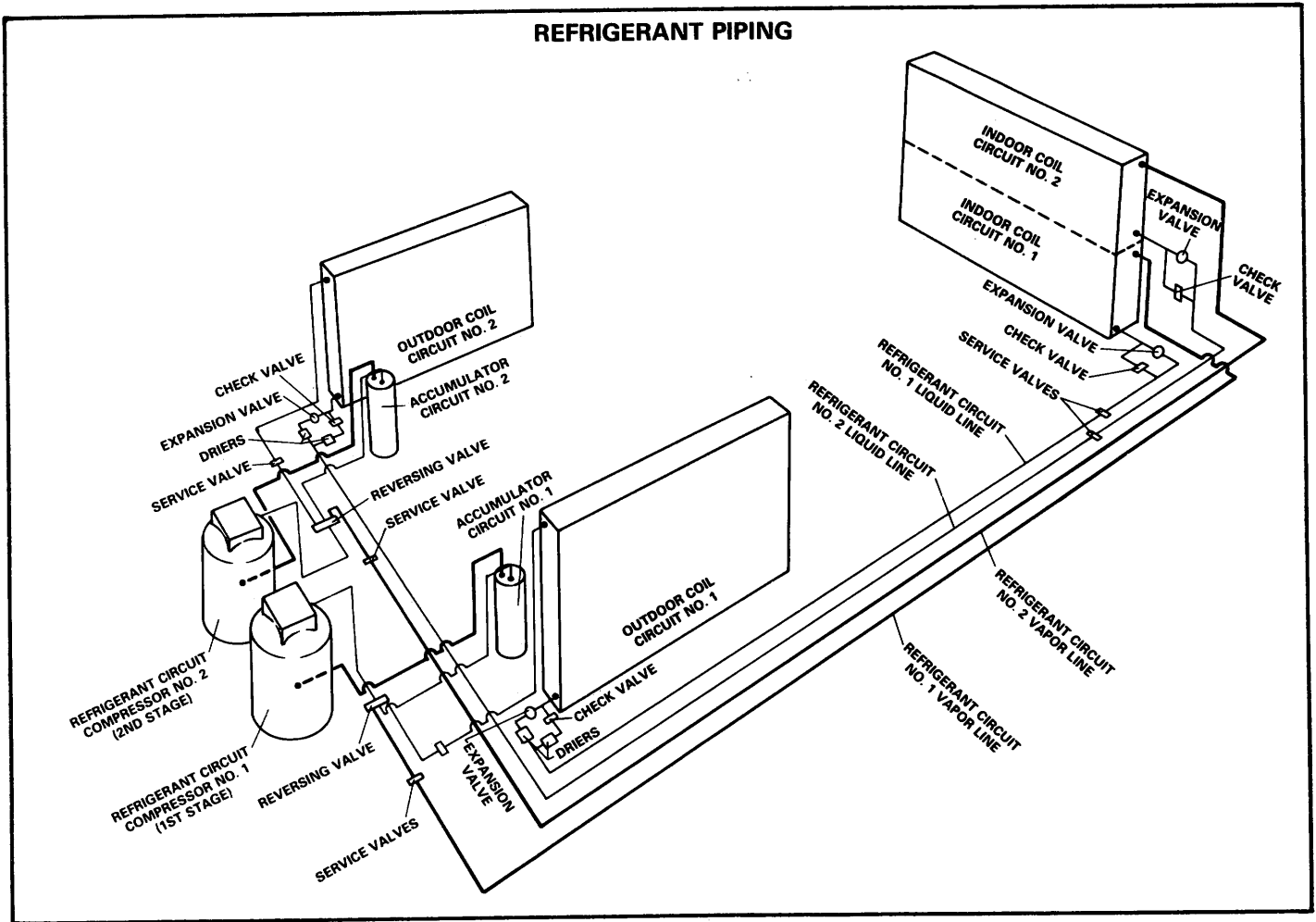

FIGURE 35

TABLE 5

| CONTROL | SETTING | LOCATION |
|---|--|------------------------|
| High Pressure Control (All Compressors) | 410 psi-out (28,8 kg/cm ²) | Internal to Compressor |
| Discharge Thermostat | 300°F (149°C) | Compressor Compartment |
| Low Ambient Cut-out Thermostat | 22°F - opens (-5,5°C) 32°F - closes (0°C) | Internal to Compressor |
| Low Ambient Thermostat | 55°F - opens (12,6°C) | Compressor Compartment |

B - DEFROST SYSTEM

The DSSI heat pump unit is equipped with a complete defrost system for both compressor 1 circuit and compressor 2 circuit. Each defrost system consists of a defrost relay, defrost clocktimer, outdoor thermostat and defrost pressure switch (Refer to Table 6 for settings and locations.) Each system will defrost as required, independent of the other system. This independent defrosting allows the other circuit to operate in the heat mode during defrost. The auxiliary strip heat or hot water can also function during the defrost cycle if initiated through the room and duct sensors.

- 1 - Defrost Relay is energized during defrost cycle. This relay stops the outdoor fan and energizes the reversing valve.
- 2 - Defrost Clocktimer, wired in parallel to the compressor contactor, is energized whenever compressor is operating. The clocktimer has (2) sets of contacts; first set closes every 90 minutes of compressor operation — second set closes every fourth time (every 6 hours).
- 3 - Outdoor Thermostat, wired in parallel to the 6 hour contacts of the clocktimer, is located in the compressor section of the unit. It is factory set for contacts to open at a temperature fall of 18°F (-7.8°C) and will reclose at 23°F (-5°C).
- 4 - Defrost Pressure Switch senses outdoor coil refrigerant pressure. The contacts close at 45 psig (approx. 24°F) and open at 200 psig (approx. 100°F). The pressure switch must be closed before the clocktimer can initiate a defrost cycle.

At outdoor temperatures above 22°F (-5.5°C), defrosting will occur every 90 minutes of compressor operation providing the defrost pressure switch contacts are closed (45 psig). The defrost circuit is through the 90 minute contacts, outdoor thermostat and pressure switch.

At outdoor temperatures below 22°F (-5.5°C), defrosting can occur every 360 minutes (6 hours) of compressor operation. The defrost circuit is through both sets of clocktimer contacts (90 minute and 360 minute) and the pressure switch.

TABLE 6

| CONTROL | SETTING | LOCATION |
|-------------------------|--|------------------------|
| Defrost Clocktimer | *1st contacts close every 90 minutes *2nd contacts close every 360 minutes (contacts close for 20 seconds) | Compressor Control Box |
| Defrost Relay | 24V coil—3 PT NO—Control Contacts Defrost Clocktimer NC—Control Outdoor Fan SPDT—Control Reversing Valve | Compressor Control Box |
| Outdoor Thermostat | Contacts open 22°F (-5,5°C) (temp. fall) Contacts close 23°F (-5°C) (temp. rise) | Compressor Section |
| Defrost Pressure Switch | Contacts close at 45 psig (Approx. 24°F) Contacts open at 200 psig (Approx 100°F) | Outdoor Coil |

* NOTE – The 90 minute defrost time cycle can be reduced to 30 minute cycle as follows: First, disconnect power, since clocktimer is line voltage. Remove the three screws on back plate of clocktimer and remove cover. Loosen lock-nut of Allen-head set screw while holding the top cam and remove. Remove bottom cam and replace top cam locking it centered on switch blade. Replace cover and screws.

HEAT PUMP

IV - INITIAL START-UP

NOTE - Crankcase heaters must be energized 24 hours before starting compressors. After 24 hours, install compressor fuses provided in cloth bag on compressor.

- 1 - Close main disconnect switch(es). After a time delay, return air blower and main blower should start.
- 2 - Refer to section "III—System Check Using Load Simulator" on page 13 to verify cooling operation.
- 3 - Compressor starting may be delayed by the compressor time interlock. Timed off period is 3 minutes.

NOTE – Compressor timed interlock may delay compressor operation when using load simulator.

V - REFRIGERANT CHECK

- 1 - Attach gauge manifold. Refer to Figure 33 for service valve identification.
- 2 - Check each circuit separately. Set room sensor or load simulator for a full cooling cycle or a full heating cycle, depending upon the season.
- 3 - Allow system to run for a few minutes to stabilize system.
- 4 - Using a thermometer, find condenser entering air temperature. Read suction and discharge pressures on gauge manifold.
- 5 - Refer to correct normal operating pressure curve on pages 36 and 37. Find suction pressure in lefthand column. Follow across the curve to correct outdoor coil entering air temperature. Mark this point, then read discharge pressure directly below. If discharge reading is within 3 psig (0,21 kg/cm²) of gauge manifold reading, system is properly charged.
- 6 - If there is a loss of charge in a circuit, remove compressor fuses from that circuit to prevent compressor from cycling on low pressure control. Refer to Lennox Service Manual for leak checking, evacuating and charging procedures.
- 7 - After charging is completed, disconnect gauge manifold and restore unit to operating condition.

VI - COMPRESSOR OIL CHARGE

The L2 compressors carry a charge of 132 oz. (3, 74 kg) of oil. The oil type varies with the compressor model number. If any replacement oil is required, the proper oil must be used. The oil type used for the L2-09724, L2-12724, and L2-07223 compressors is Freezeze 150.

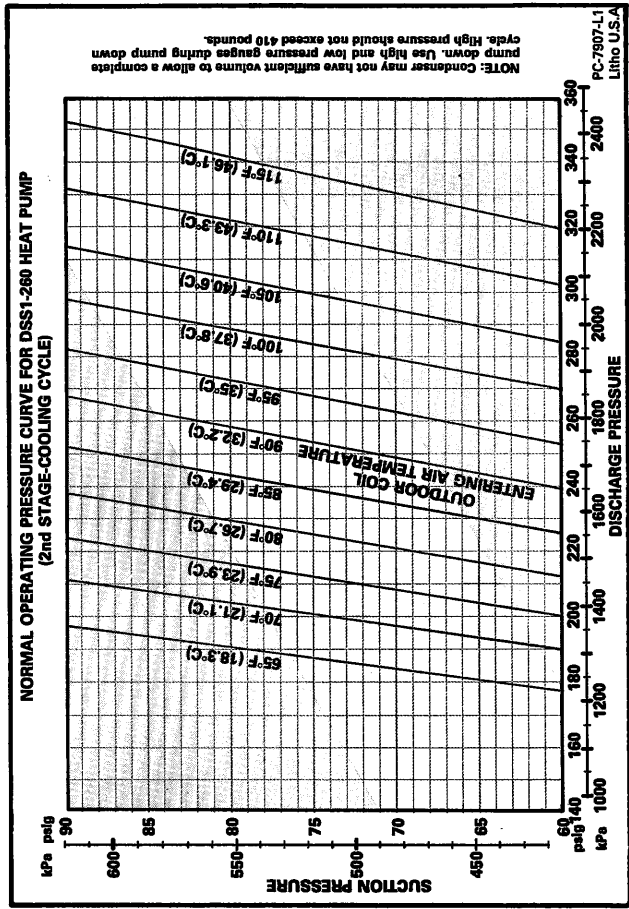
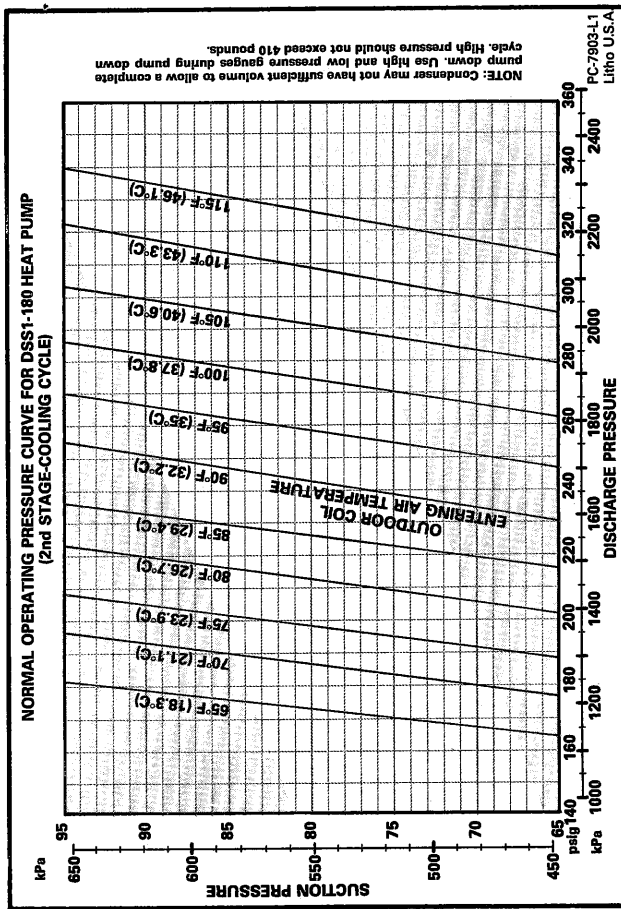
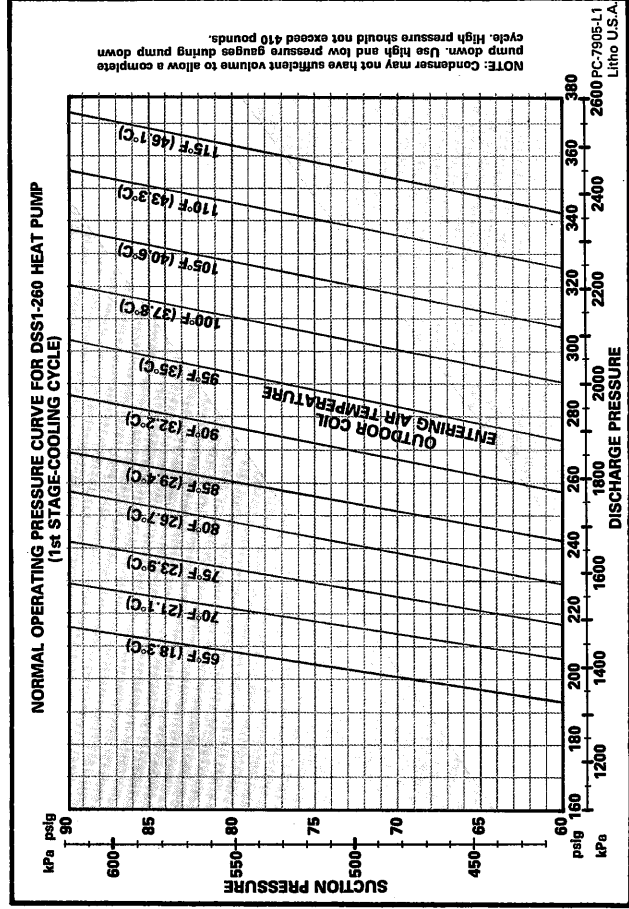
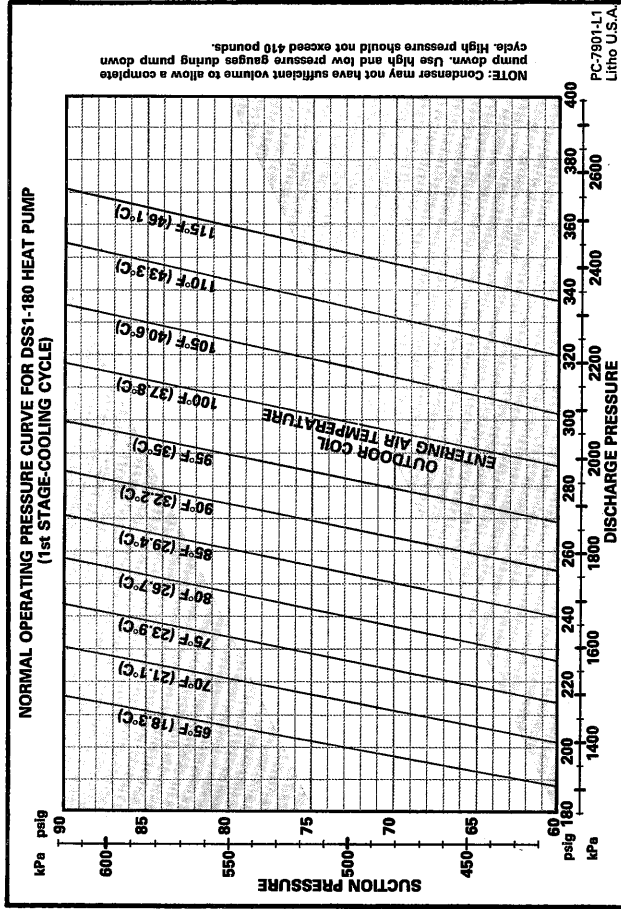

HEAT PUMP

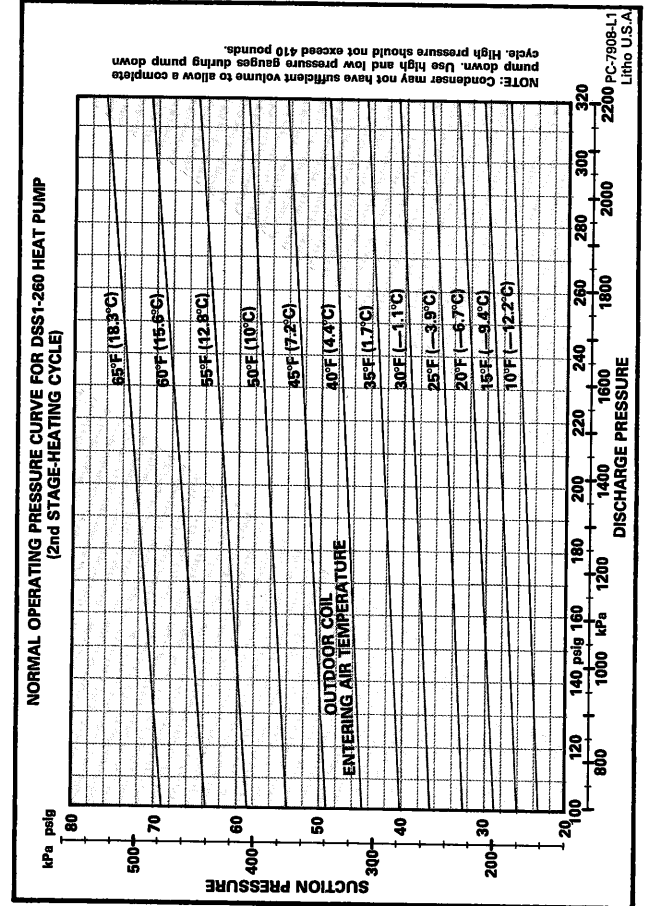
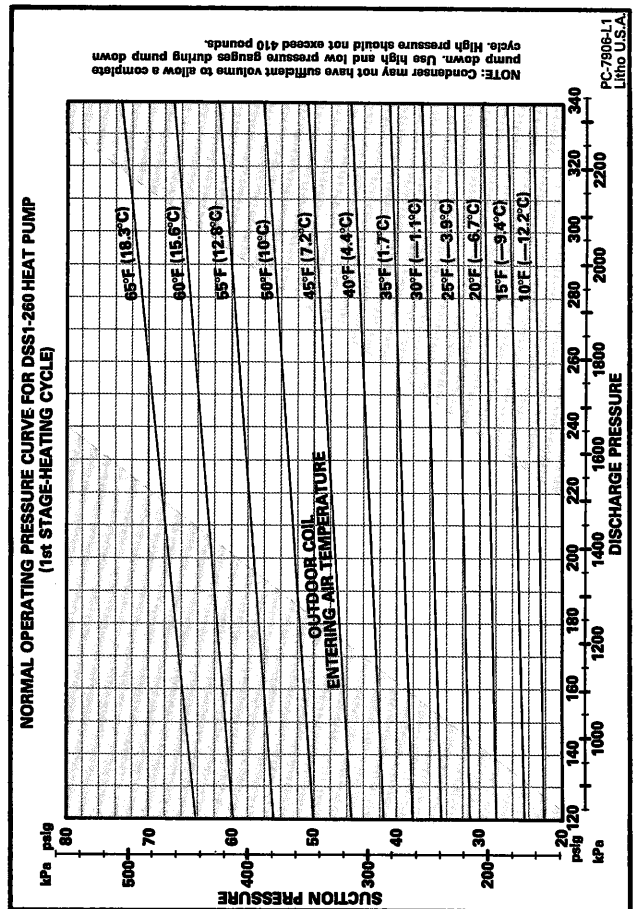
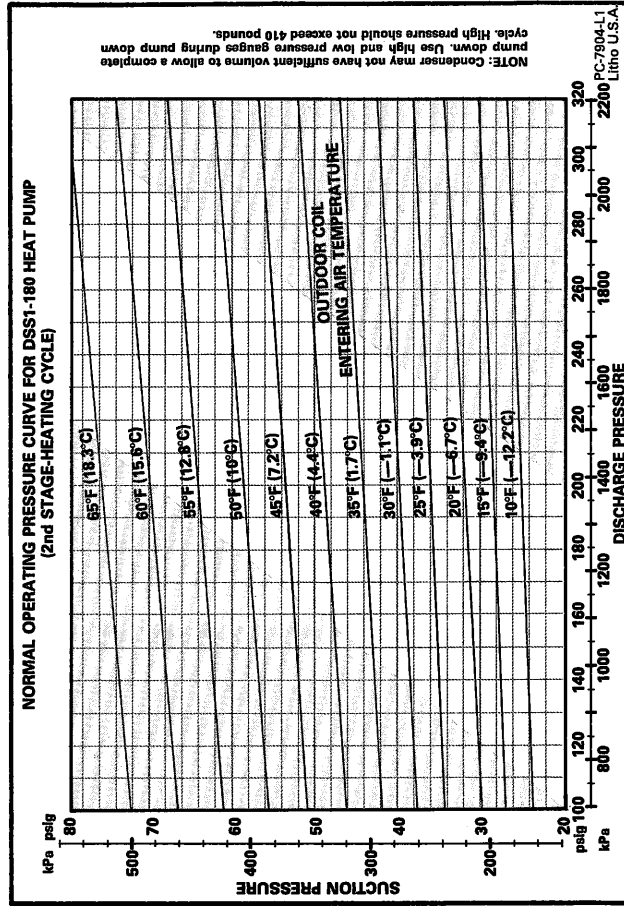
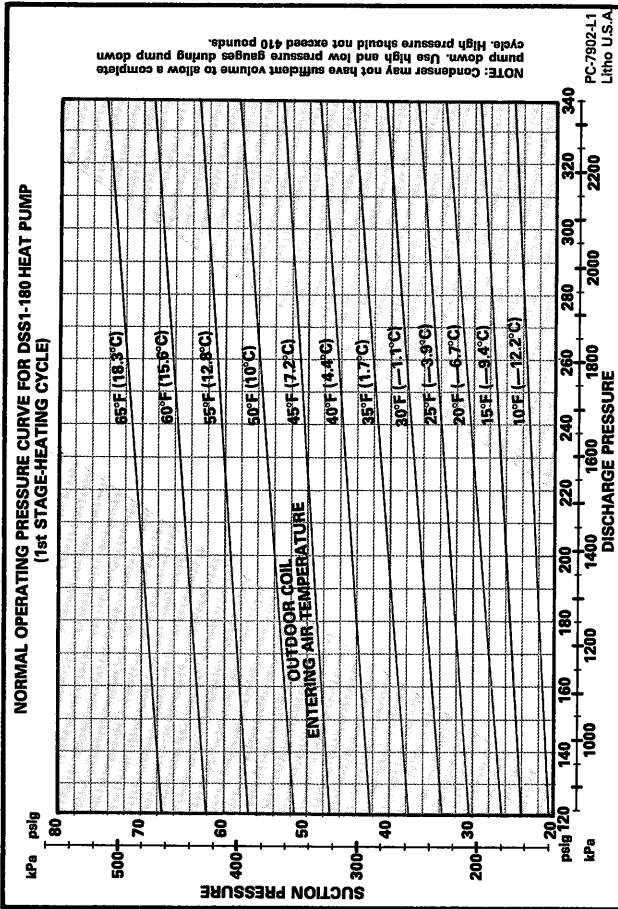

BLOWERS

FIRESTATS AND AIR VOLUME ADJUSTMENT

I - FIRESTAT IDENTIFICATION

Firestats are furnished as standard equipment except when optional smoke detector controls are specified with unit. Firestats (manual reset) are mounted in the return and supply air stream as shown in Figures 36 and 37. They will completely shut off the unit when either firestat senses temperature in excess of 136°F (57.8°C).

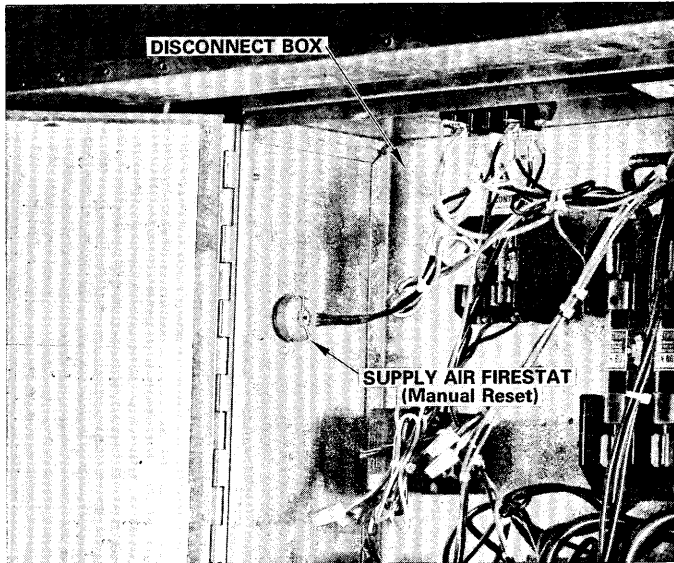

FIGURE 36

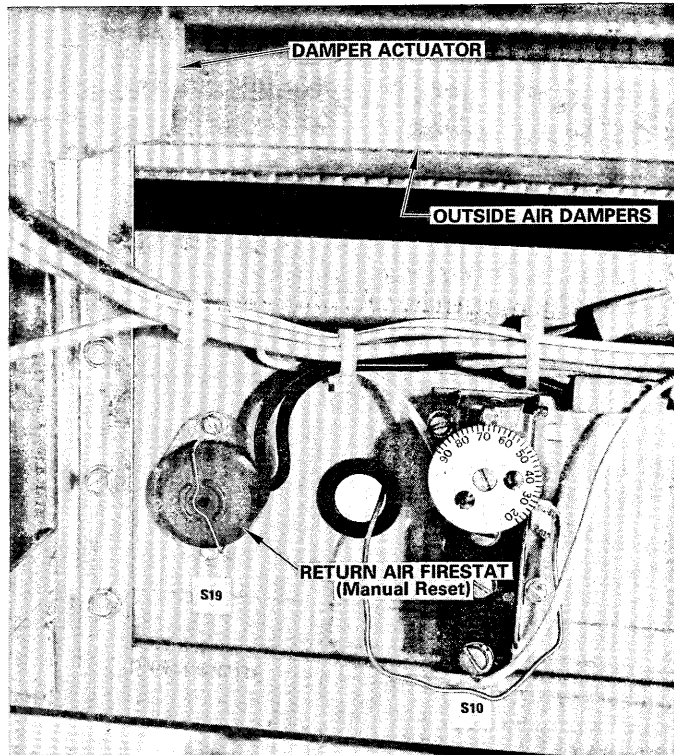

FIGURE 37

II - BLOWER DRIVE SELECTION

Refer to Table 7 for maximum usable horsepower and drive selection for supply air blower used on DSS1 180/260 units.

TABLE 7

| SUPPLY AIR BLOWER | | |
|-------------------|-------------------|--|
| Nominal Motor hp | Maximum Usable hp | *Rpm Range Of All Available Drive Setups @1720 Rpm Motor Speed |
| 3 | 3.45 | 566-720 |
| 5 | 5.75 | 750-905 |
| 7-1/2 | 8.63 | 890-1070 |
| 10 | 11.5 | †890, 950, 1010, 1070 |

†Fixed pulleys at rpm increments shown.

III - MINIMUM AIR FLOW

Minimum recommended air flow for units with air conditioning is 6000 CFM (DSS1-180) and 7500 (DSS1-260). Refer to Table 8.

Minimum air flow volumes for electric heat units are shown in Table 9.

Minimum air flow for units with supermarket heat reclaim coils is 6,000 CFM (10194 m³/hr).

TABLE 8

| AIR CONDITIONING - MINIMUM AIR FLOW | | | |
|-------------------------------------|--------------|------------------------|---------------------------------------|
| Unit Model No. | tons cooling | Minimum Air Flow (CFM) | Minimum Air Flow (m ³ /hr) |
| DSS1-180 | (15) | 6,000 | 10 195 |
| DSS1-260 | (22) | 7,500 | 12 743 |

TABLE 9

| ELECTRIC HEAT — MINIMUM AIR FLOW | | |
|----------------------------------|------------------------|--|
| Heating Capacity (KW) | Minimum Air Flow (CFM) | Minimum Air Flow (m ³ /hr.) |
| 30-90 | 6,000 | 10 195 |
| 105-120 | 7,000 | 11 893 |

IV - CHECKING INDOOR BLOWER CFM (m³/hr)

Either a watt or amp method can be used to determine indoor blower CFM (m³/hr).

CAUTION - Beware of moving parts, air suction and high voltage when making electrical measurements. Always disconnect all power to unit when connecting instruments.

A - Watt Method (Preferred Method)

Two measured factors are needed in determining indoor blower CFM (m³/hr), (1) blower motor watts, (2) blower RPM.

NOTE - Motor watts must be determined with a watt-hour meter (watt meter).

- Using blower wattage read at motor, refer to curve on page 43 to convert watts to HP.
- Using this HP rating, refer to curve on page 42 to convert HP and RPM to CFM (m³/hr).

Example - Readings at unit

8,000 measured blower motor watts
1050 measured blower RPM

- 3 - Curve on page 43 - 8000 watts = 9 HP.
- 4 - Curve on page 42 - 9 HP and 1050 RPM = 8,750 CFM (14866 m³/hr).

B - Amp Method

Four factors are needed to determine indoor blower CFM (m³/hr.), (1) measured blower RPM, (2) measured voltage, (3) blower motor amps, (4) motor manufacturer nameplate voltage and HP.

- 1 - Using blower amperage and voltage measured at unit, refer to correct Amps to Horsepower Curve on page 40 or 41 to convert to HP.
- 2 - Using this HP rating, refer to curve on page 42 to convert HP and RPM to CFM (m³/hr).

Example - Readings with a 10 HP, 230 volt rated General Electric Motor

25 amps
230 measured voltage
1050 measured blower RPM

- 3 - Curve on page 40 - 25 amps and 230 volts = 9 HP
- 4 - Curve on page 42 - 9 HP and 1050 RPM = 8,750 CFM (14 866 m³/hr)

V - DETERMINING INDOOR BLOWER SPEED

- 1 - To determine desired indoor blower speed, the actual blower CFM (m³/hr.) and blower RPM must be found as shown in section "IV - Checking Indoor Blower CFM (m³/hr.) can be made into a formula to calculate correct blower speed.

Example - 8,750 measured indoor blower CFM (14 866 m³/hr.) at 1050 blower RPM
7,500 specified indoor blower CFM (12 743 m³/hr.)

$$\frac{7,500 \text{ CFM} \times 1050 \text{ RPM}}{8,750 \text{ CFM}} = 900 \text{ RPM}$$

$$\frac{12 743 \text{ m}^3/\text{hr} \times 1050 \text{ RPM}}{14 866 \text{ m}^3/\text{hr}} = 900 \text{ RPM}$$

- 2 - Adjust blower drive to the speed (RPM), or replace the motor pulley, whichever is necessary.

VI - CHECKING INDOOR MOTOR AMPERAGE

It is mandatory that blower motor amperages be checked on each DSS1 unit to be sure motors are not overloaded.

- 1 - Open exterior panel exposing electrical box.
 - 2 - Turn "Off" interrupter (if used) and open electrical box.
- WARNING - Electrical box contains high voltage. Use extreme caution.**
- 3 - Attach amp meter and then turn "On" power.
 - 4 - Check amperage draw on each of the (3) wiring leads to the motor and compare with amps on motor nameplate. Refer to Figure 38.
- Caution - Motor life may be shortened if nameplate amps are exceeded.**

BLOWERS

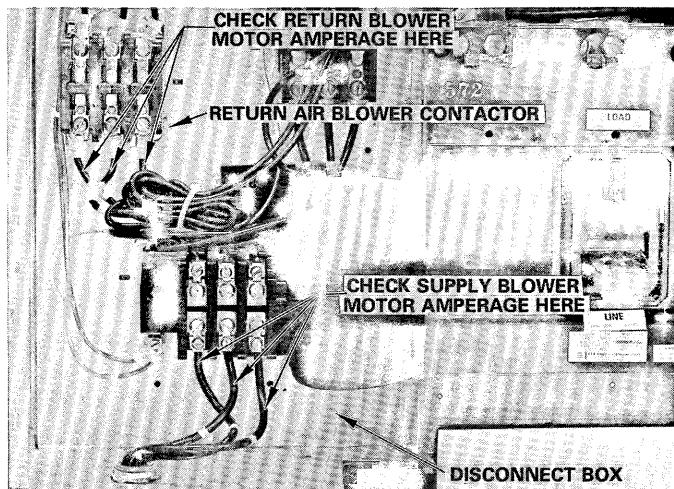

FIGURE 38

VII - EXTERNAL STATIC PRESSURE MEASUREMENTS

If desired, external static pressure can be taken as follows:
 1 - Assemble a static pressure probe as shown in Figure 39.

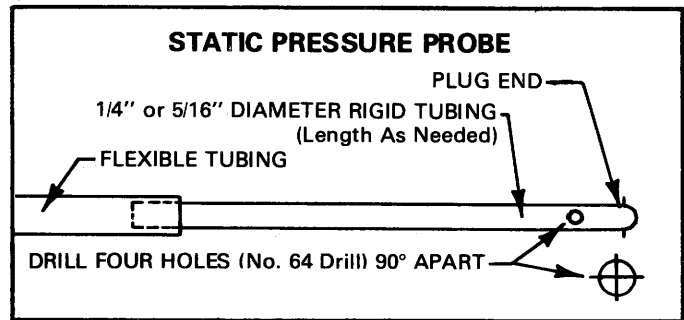

FIGURE 39

- 2 - Take external static pressures at the locations specified in Figure 40.

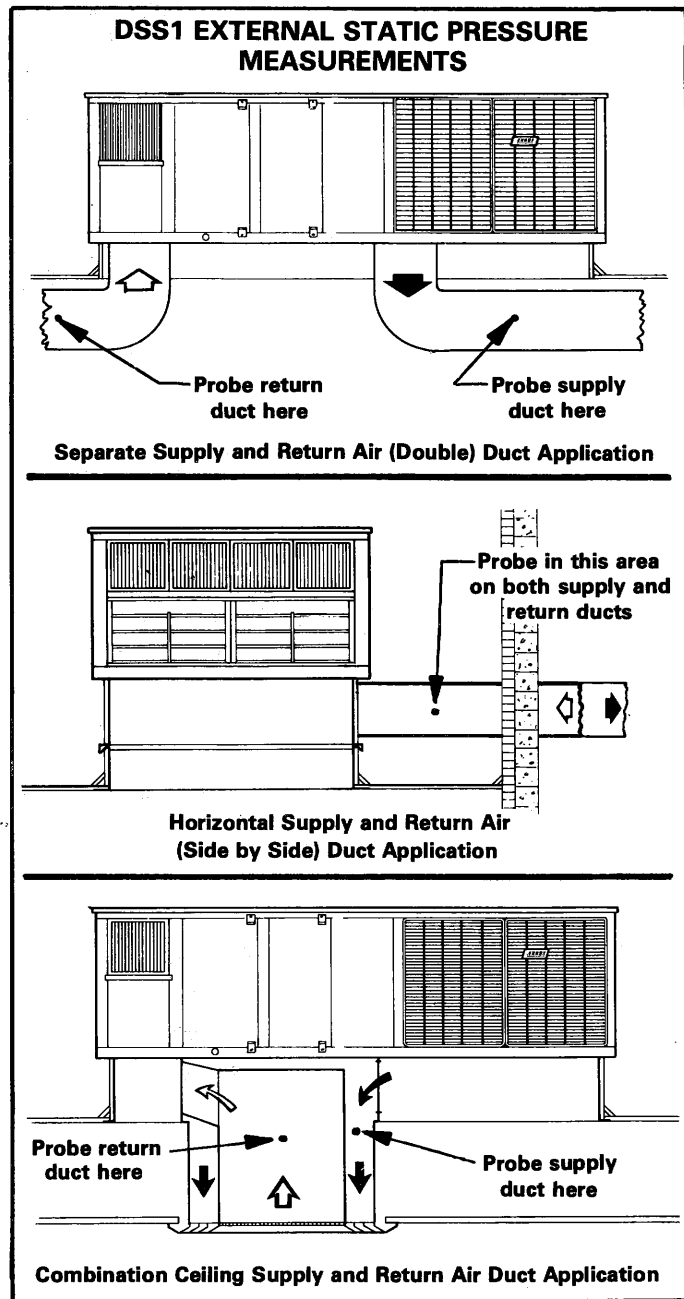
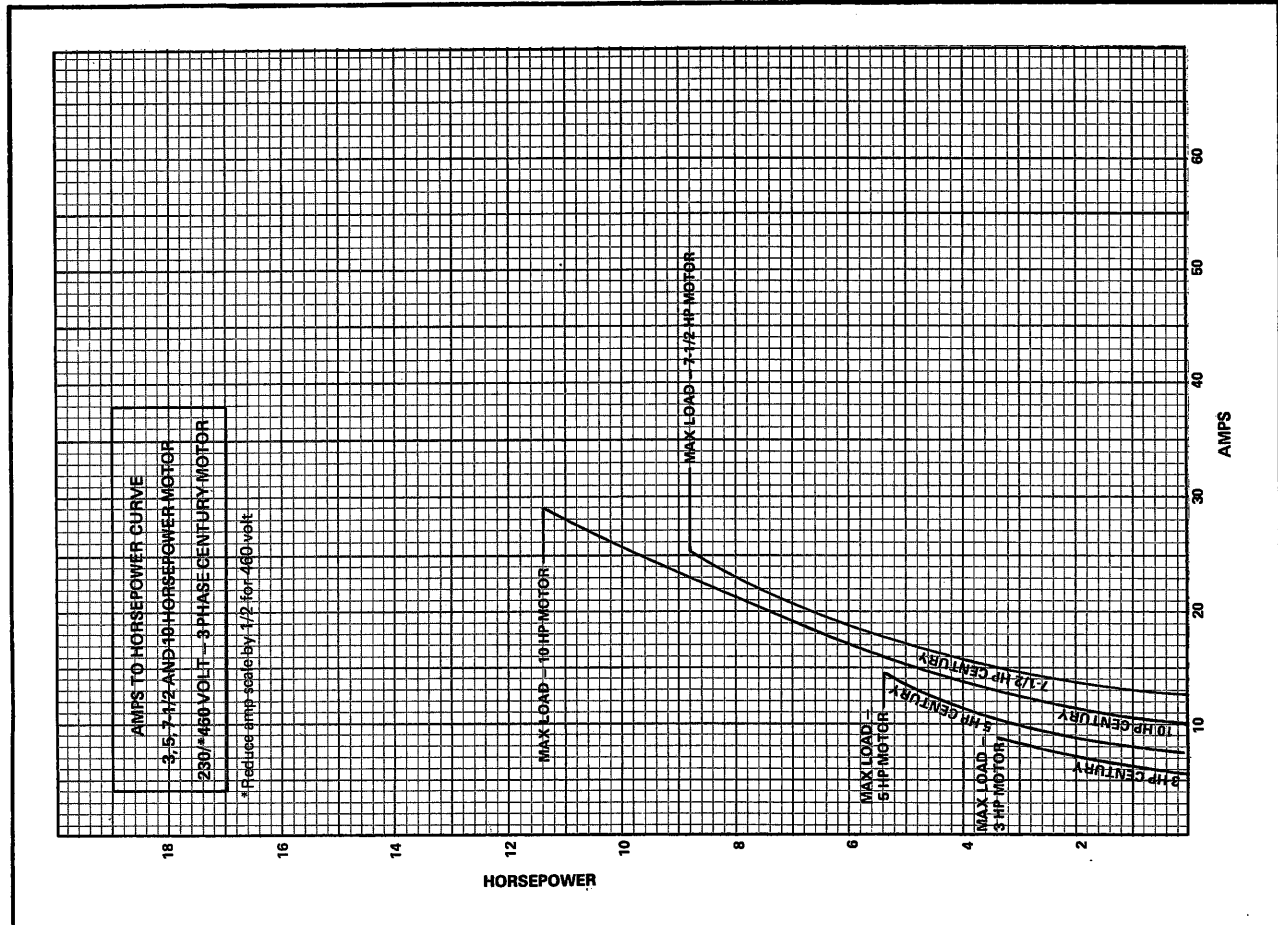
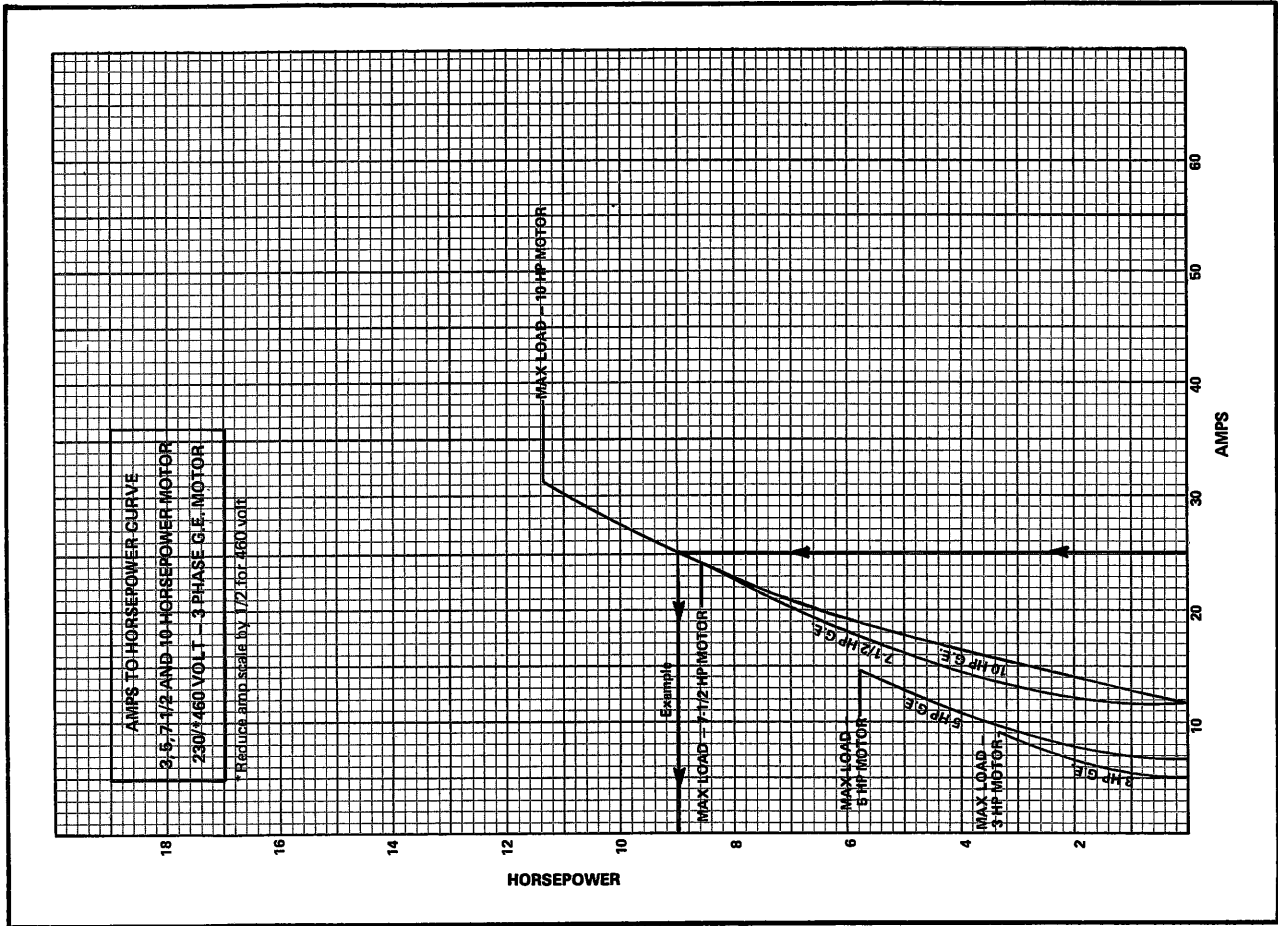
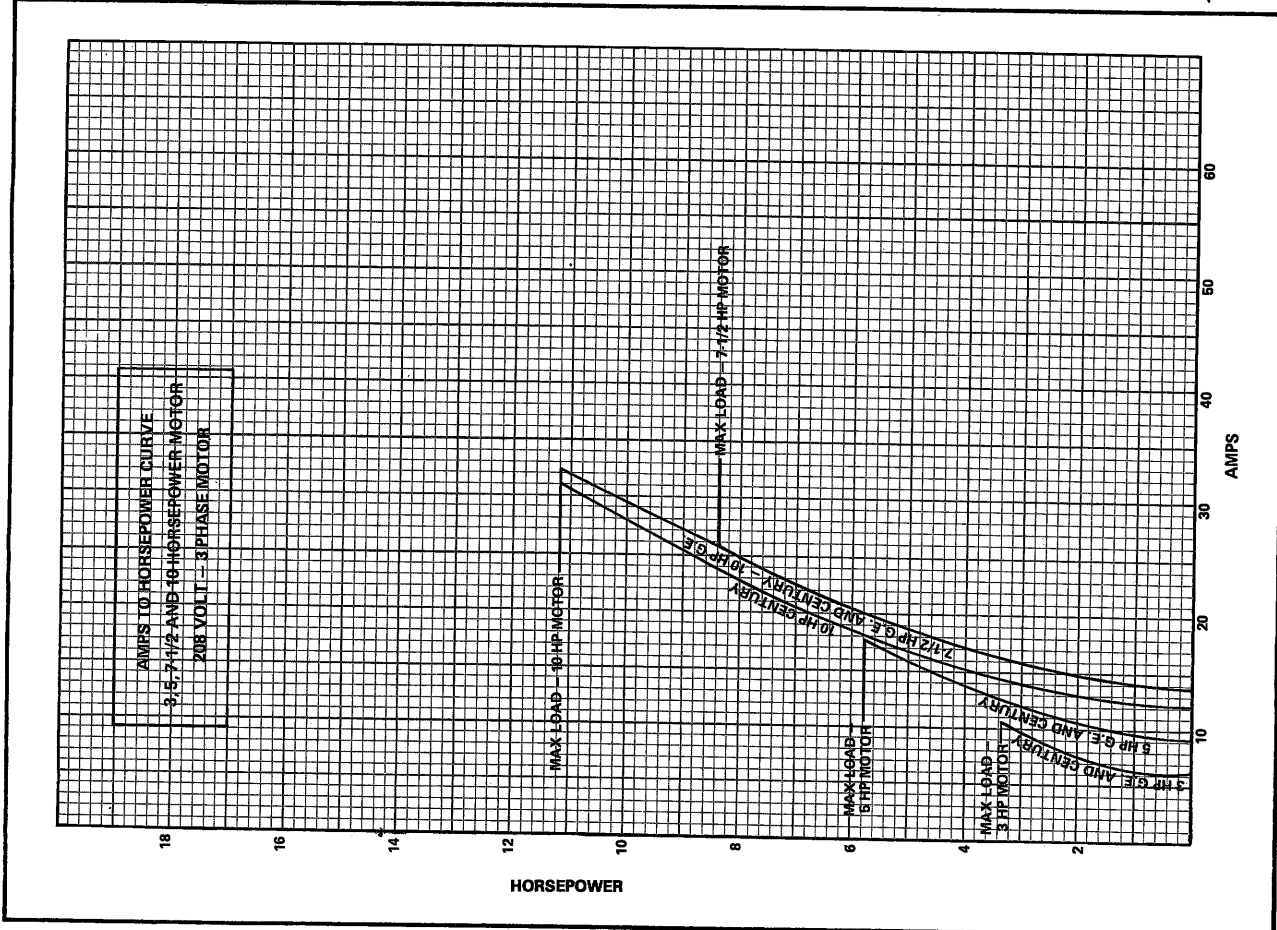
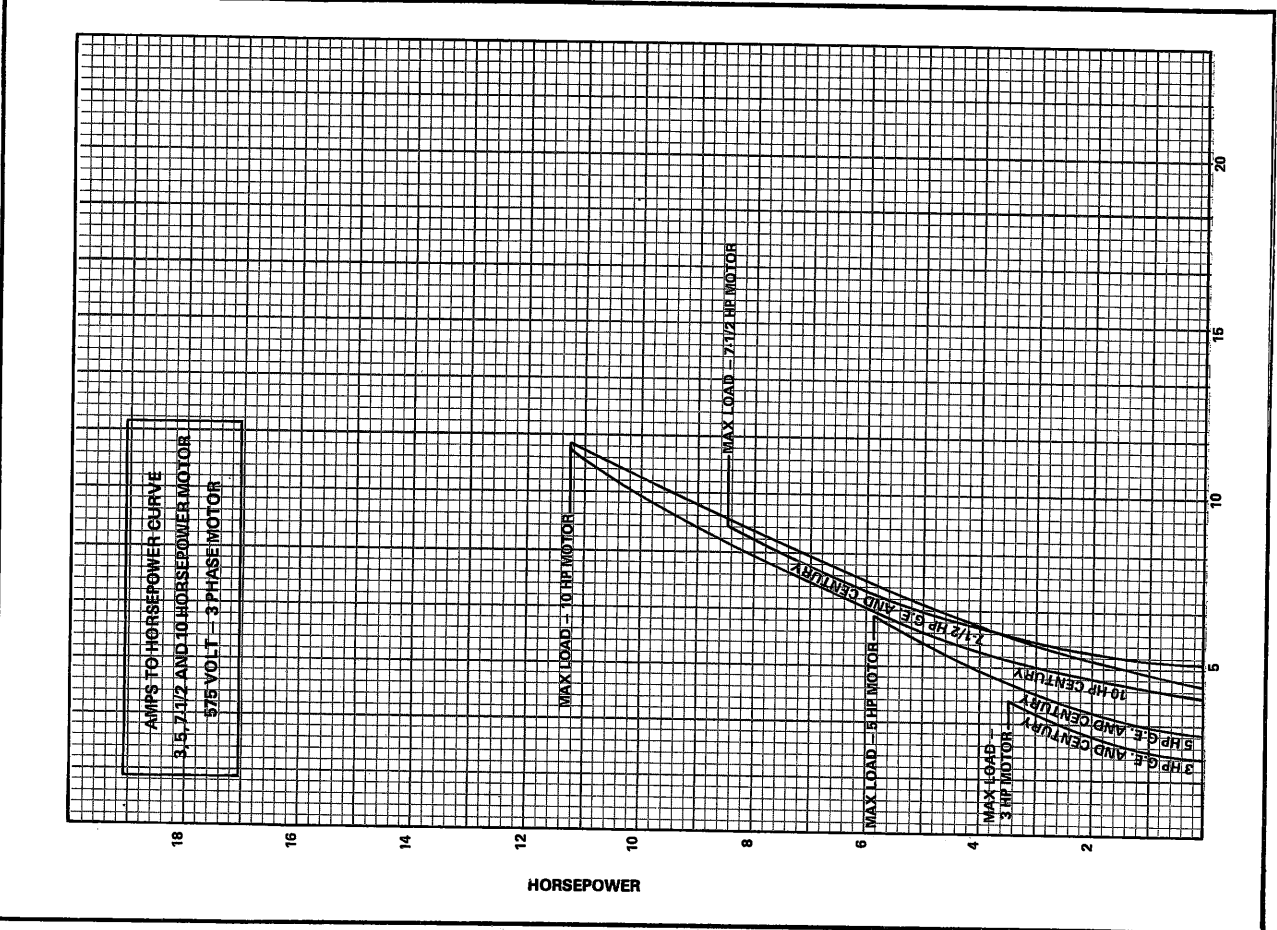
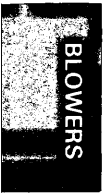
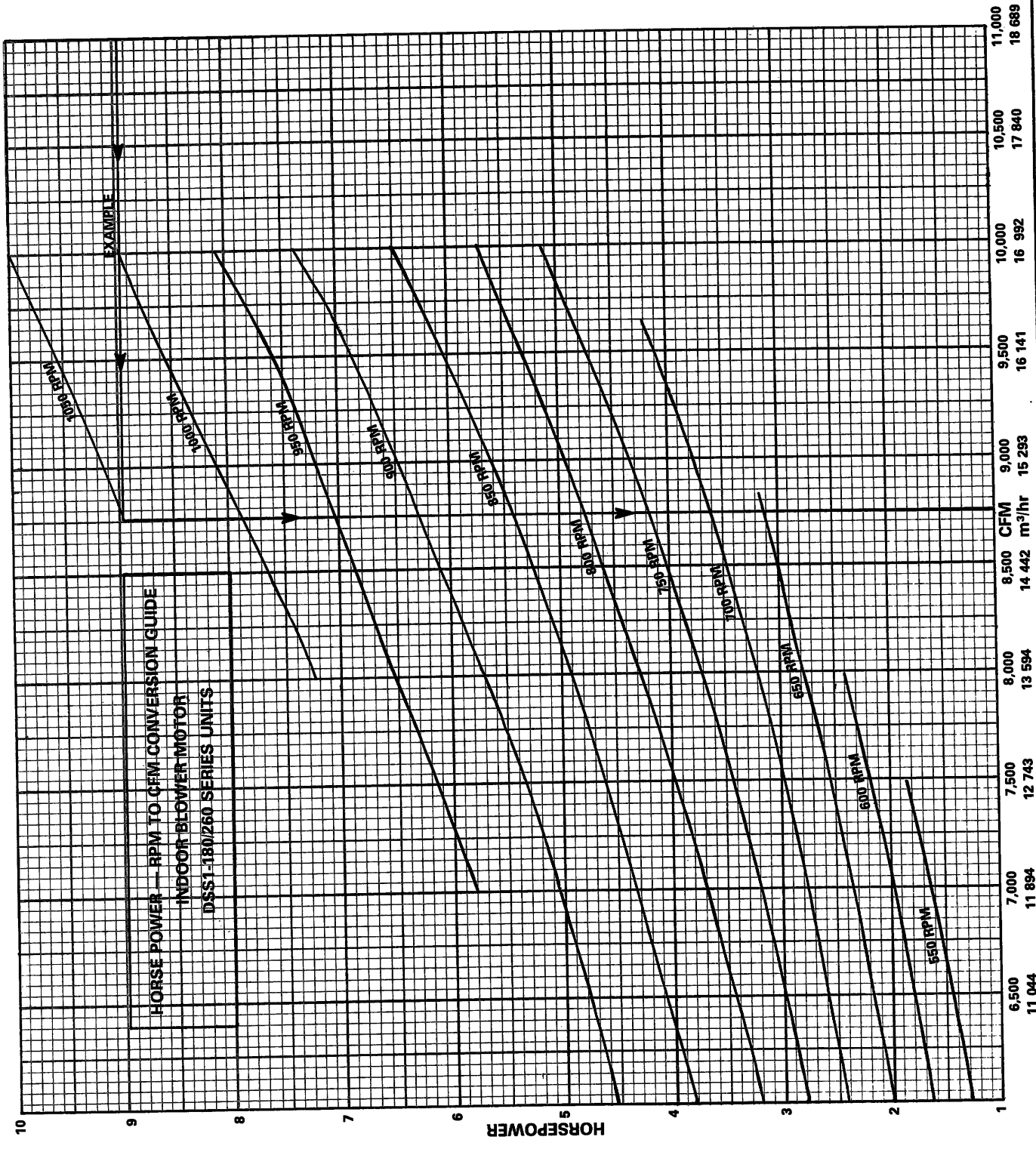

FIGURE 40







BLOWERS

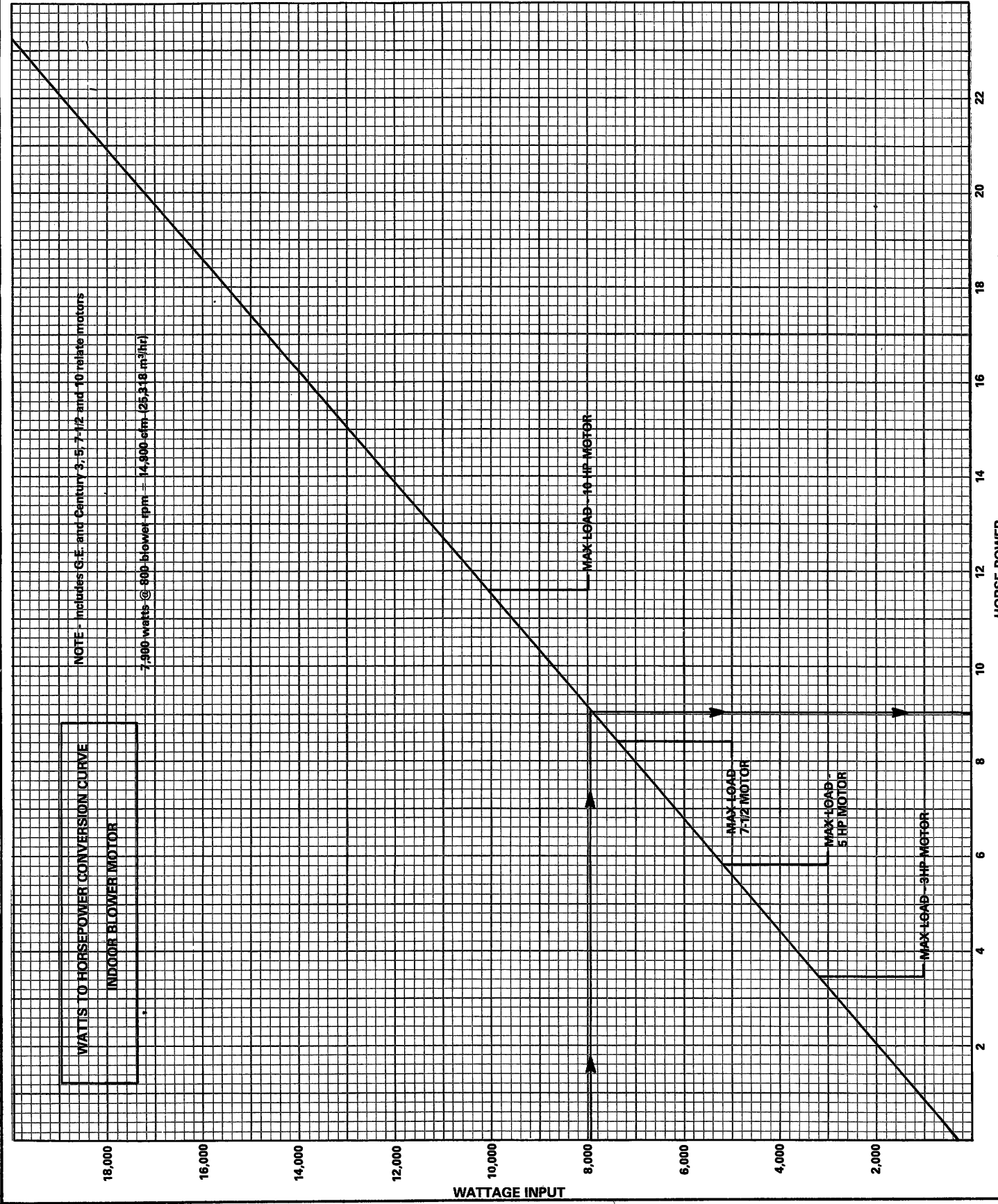

GENERAL INFORMATION FOR LENNOX BLOWER ASSEMBLIES

The following information should be used for belt adjustment, lubrication, checking and servicing blower assemblies or replacing parts.

I - ALIGNMENT OF BLOWER BEARINGS

Before installing blower bearings, the self-alignment feature of the bearing must be loose and free. Use the following procedure.

- 1 - Hold bearing stationary, such as in a vice.
- 2 - Insert a short length of blower shafting or wooden mallet handle into bearing to serve as a lever. **Do not use a tool that will score or gouge the inside surface of the bearing.**
- 3 - Move lever side to side and up and down until bearing rotates free and easy in the housing. A small amount of light weight oil between the outer race and the bearing housing may aid in loosening the self-alignment feature.

IMPORTANT - If the self-alignment feature of the bearing can not be freed, do not use the bearing.

II - ASSEMBLY OF SHAFT, BEARINGS AND WHEELS

- 1 - Clean grease and dirt from blower shaft with solvent. **During assembly it is extremely important to keep shaft free of oil at the bearing locations since a bearing/shaft sealant will be used and oil will decrease the effectiveness of the sealant. However, a light coat of oil may be used on other areas of the shaft to aid in sliding shaft through blower wheels.**
- 2 - Assemble bearings, locking collars and blower wheels on the shaft.
- 3 - Proceed with securing bearing housings to frame. It is extremely important to properly align bearings to shaft. The bearing housing must be aligned so it will rest perfectly flat on the frame mounting arm. Tap lightly on the bearing housing with wooden mallet to obtain this alignment, then use slotted holes to center blower wheels in the housing orifice and secure bearing housings to frame.

IMPORTANT - There must be no mis-alignment between the bearing housing and frame since tightening down mis-aligned bearings will cause binding conditions and will result shortly in bearing and/or shaft failure.

- 4 - Now center the blower wheels side to side in housings and secure with woodruff keys and set screws.
- 5 - Check bearing and shaft alignment by sliding the shaft back and forth in the bearing. A properly aligned assembly should slide easily, not requiring over 40 lbs. (18 Kg) of force.

III - BEARING AND SHAFT SEALANT

It is recommended that a sealant (Loctite #601) be used between the bearing and shaft to take up clearance and aid in securing the inner race to the shaft. Loctite #601 is available from the Lennox Parts Center in 10 cc tubes, part number P-8-11211. An acceptable substitute is Stud, N Bearing Mount, Loctite #22, which is available at most automotive supply houses.

- 1 - Apply the sealant sparingly to the shaft on each side of the bearings. Slide the shaft back and forth until sealant is thoroughly worked into the shaft and bearing contact area.

NOTE - Loctite sealants remain liquid outside the joint. Remove excess. Sealant will partially cure in 10 minutes and fully cure in 1 hour.

- 2 - Position shaft to center blower wheels side to side in housings.

IV - LOCKING COLLARS

If "Shwezloc" Sealmaster bearings are used, install locking collars immediately. Torque the set screws on collars by bending hex wrench. If bearings with eccentric locking collars are used, allow approximately 10 minutes for sealant to cure before locking collars in place. Lock as follows:

- 1 - Mate cam of collar with cam of bearing inner ring.
- 2 - Press collar lightly against inner ring, then turn collar in direction

of shaft rotation until engaged. Refer to Figure 41.

- 3 - With draft pin in collar hole, strike in direction of shaft rotation to lock. See Figure 42.

- 4 - Tighten set screw in collar.

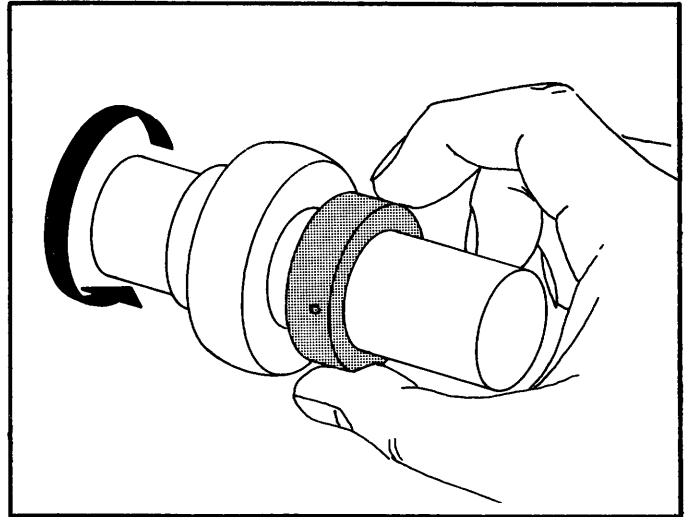

FIGURE 41

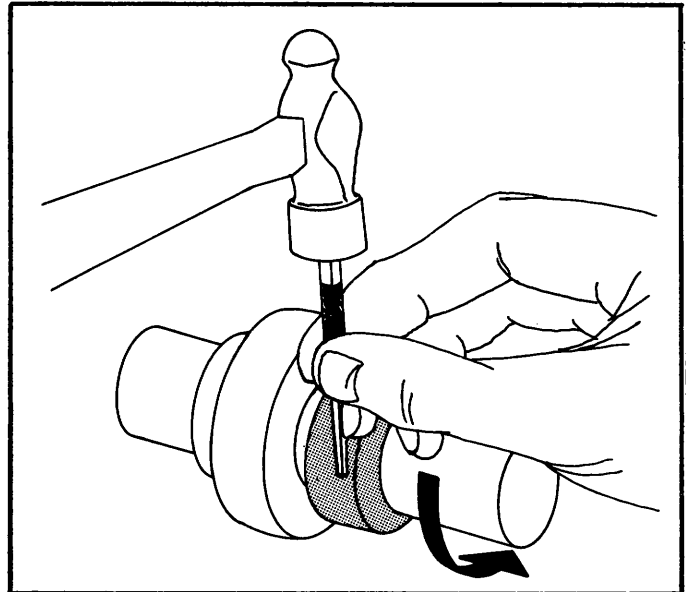

FIGURE 42

V - LUBRICATION

A - Motor Bearings

NOTE - Always relubricate motors according to manufacturer's lubrication instructions on each motor. If no instructions are provided, use the following as a guide:

- 1 - **Indoor and Return Air Blower Motor Bearings** - Bearings are pre-lubricated. For extended bearing life, relubricate at least once every two years with a lithium base grease, such as Westinghouse 53701RW, Chevron BRB2 (Standard Oil) or Andok 260 (Humble Oil). To relubricate, replace top plugs with standard grease fittings. Remove lower outlet plugs and add grease with handgun until new grease appears at bottom outlets. Run motor

for a short time before replacing bottom plugs. Refer to Figure 43.

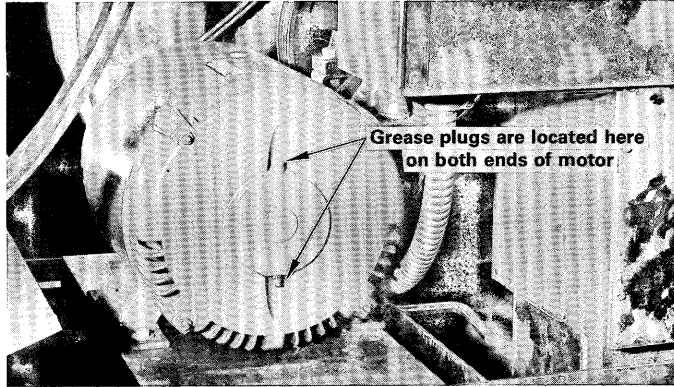

FIGURE 43

2 - Condenser Fan Motors - Prelubricated and sealed. No further lubrication required.

B - Blower Bearings

Indoor and Return Air Blower Bearings - Bearings are prelubricated. For extended bearing life, relubricate at least once every two years with a lithium base grease, such as Alvania 3 (Shell Oil), Chevron BRB2 (Standard Oil) or Regal AFB2 (Texas Oil). Use hand grease gun for relubrication. Add only enough grease to purge through the bearings so that a bead of grease appears at the seal lip contacts. Refer to Figure 44.

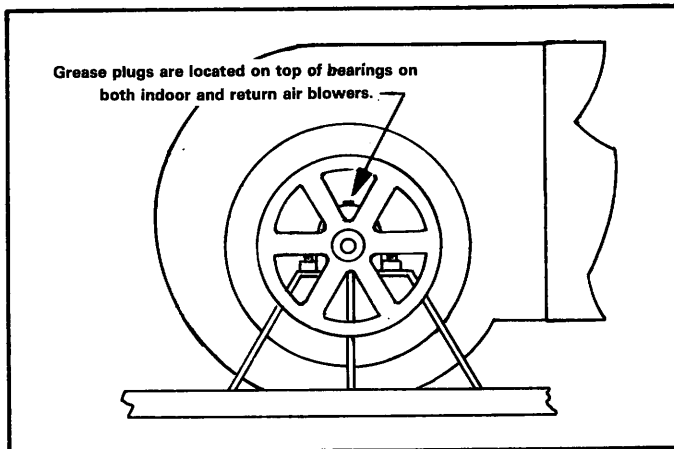

FIGURE 44

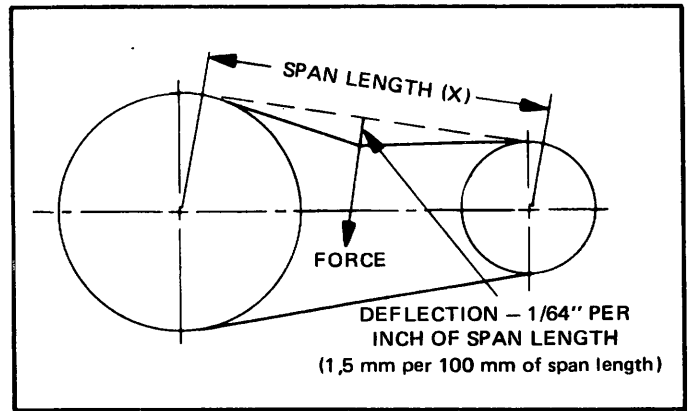

FIGURE 45

2 - At center of span length (X) apply a force perpendicular to span large enough to deflect 1/64" for every inch of span length (deflection 1,5 m per 100 mm of span length).

Example - Deflection force of a 40" span would be 40/64 or 5/8".

Example - Deflection force of a 1000 mm span would be 15 mm.

3 - Compare the applied force with the value given in Table 10. If the force is between the minimum and maximum range shown, the drive tension should be satisfactory. A force below minimum value indicates an undertensioned belt. A force that exceeds maximum value indicates an overtensioned belt. Adjust the belt tension as shown in Figure 46.

TABLE 10

| Belt Cross Section (Marked on Belt) | Motor Pulley Pitch Diameter | | Deflection Force | | | |
|--|-----------------------------|---------------|------------------|---------------|-----------------|---------------|
| | in. | mm | Minimum lbs. | Maximum Kg | Minimum lbs. | Maximum Kg |
| A | 3.0 - 3.6 | 76,2 - 91,4 | 2-5/8 | 1,19 | 3-1/4 | 1,47 |
| | 3.8 - 4.8 | 96,5 - 121,9 | 3 | 1,36 | 4 | 1,81 |
| | 5.0 - 7.0 | 127,0 - 177,8 | 3-1/4 | 1,47 | 5 | 2,27 |
| B | 3.4 - 4.2 | 86,3 - 106,6 | 3 | 1,36 | 5 | 2,27 |
| | 4.4 - 5.6 | 111,7 - 142,2 | 4 | 1,81 | 5-7/8 | 2,66 |
| | 5.8 - 8.6 | 147,7 - 218,4 | 5-1/4 | 2,38 | 7-7/8 | 3,57 |

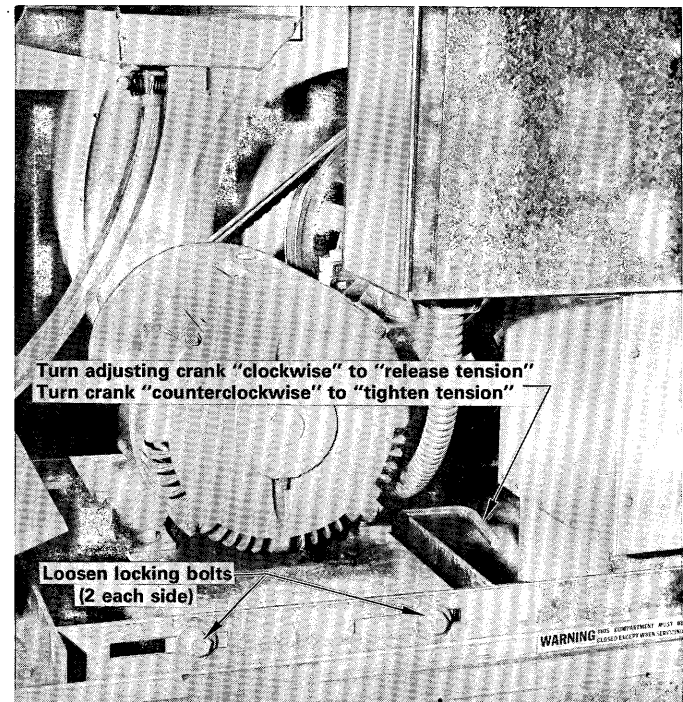

FIGURE 46

BLOWERS

VI - BELT ADJUSTMENT

Maximum life and wear can be obtained from belts only if proper pulley alignment and belt tension are maintained.

Initially, tension new belt(s) at the maximum deflection force recommended, then re-tension belt(s) after a run in period of 24-48 hours. This allows belt(s) to stretch and seat in the grooves.

A - Points For Installing Belts

- 1 - Use a matched set of belts.
- 2 - Clean oil and grease from the grooves, also remove any rust or burrs from the sheave grooves.
- 3 - Shorten the center distance of the drive until the belts can be put on the sheaves without forcing.
- 4 - Make sure that the sheaves are correctly aligned, that the shafts are parallel, that there is clearance for the drive to run and that the bearings have oil.
- 5 - On multigroove pulleys, be sure all are set at same pitch diameter.

B - Tensioning Belts

Ideal tension is the lowest tension at which the belt(s) will not slip under peak load conditions. Over-tensioning shortens belt and bearing life. Following is a recommended procedure for tension belts.

- 1 - Measure the span length, X. Refer to Figure 45.

FILTERS

DSS1-180/260 series units are available with the following filter options:

- Standard frame filters (permanent or throwaway)
- Frame pre-filters

I - STANDARD FRAME FILTERS

Standard frame filters are available with either 2" thick throwaway frame filters or washable aluminum frame filters.

- 1 - Remove access panel from damper/filter section to expose banks of filters.
- 2 - To clean permanent type filter, flush regularly with water and recoat with RP Super Filter Coat Adhesive (298016026 or 298016027).
- 3 - Replace throwaway filters with Farr 30/30 or equivalent filters.
- 4 - Replace filters in unit noting arrangement and air flow direction as shown in Figure 47.

II - FRAME PRE-FILTERS

These filters are aluminum framed 1" thick air filters with polyurethane (cleanable) filter media. Pre-filters are optional equipment with either bag type filters or standard frame filters.

- 1 - To clean filter, vacuum or wash with mild soap and water. For increased efficiency, coat filters with water soluble oil (P-8-5069) available from Lennox dealers. When pre-filters are used with bag type filters, they must be cleaned regularly to extend the life of the bag filters.

CAUTION - Some detergents have an adverse effect on filter media, causing it to loose flexibility or become soft. It is recommended that dish washing liquid be used. Do not use enzyme detergents or pre-soakers. When cleaning, leave filters in cleaner only as long as it takes to clean them.

- 2 - Replace filters in unit. Refer to Figure 47 for pre-filter arrangement when used with standard frame filters.

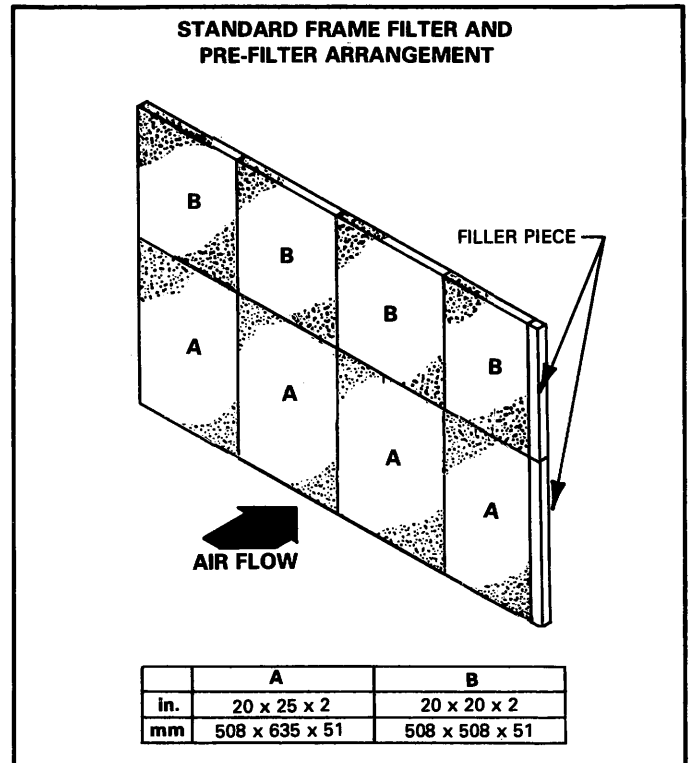

FIGURE 47

SERVICE FLOW CHARTS

With equipment as sophisticated as the DSS1 unit, it can often be difficult to locate the source of trouble from a given set of conditions. The following service flow charts are designed for direction to the likely source of trouble from certain observed or readily determined conditions.

When going through the following service flow charts always start with "Supply Air Blower Operation". Once the indoor air blowers are running, go to the flow charts for heating or cooling sections. The schematic wiring diagrams provided on the unit are to assist you in understanding the various circuits.

SERVICE FLOW CHART FOR INDOOR AIR BLOWER

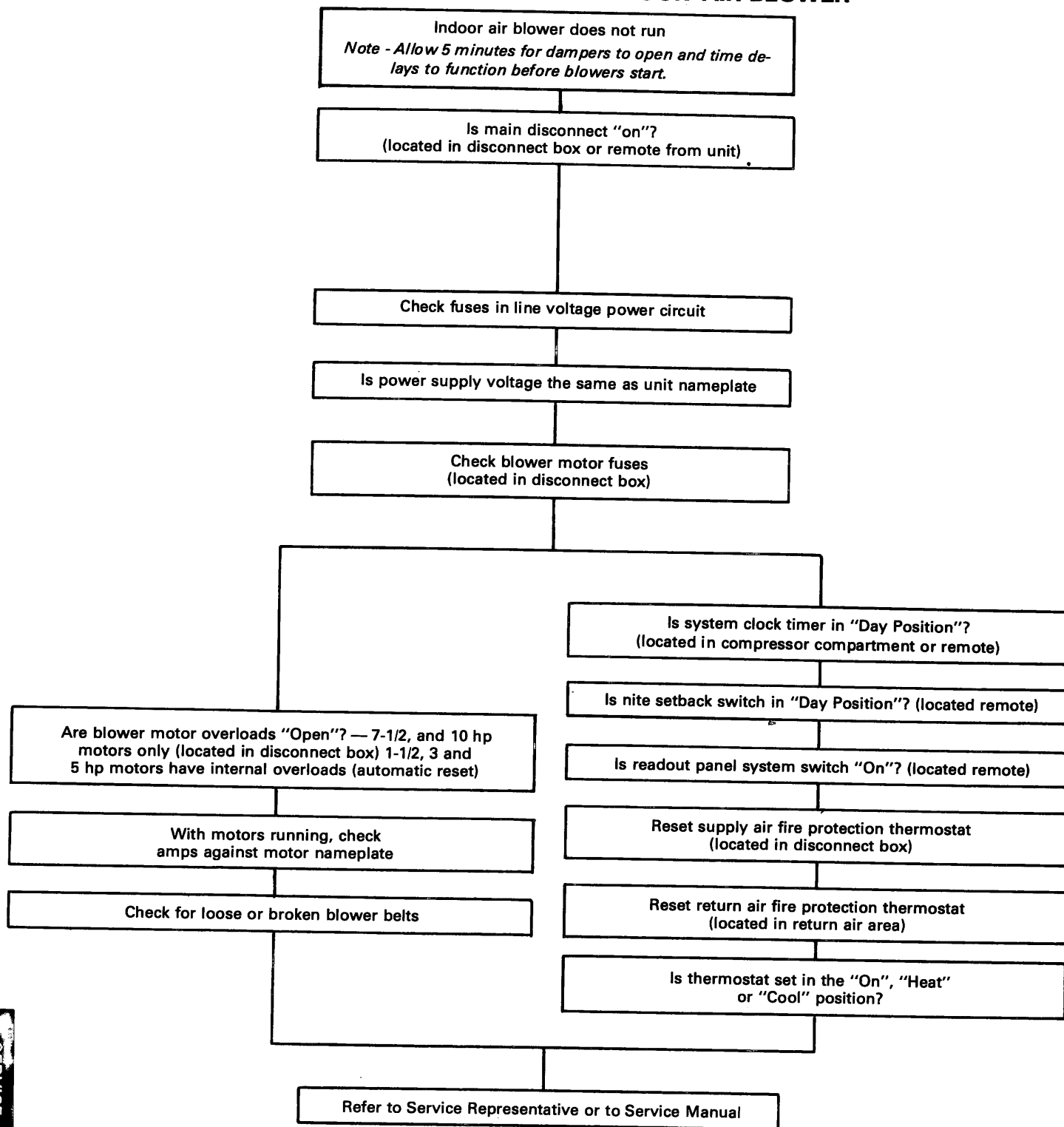

SERVICE FLOW CHART FOR HEATING SECTIONS

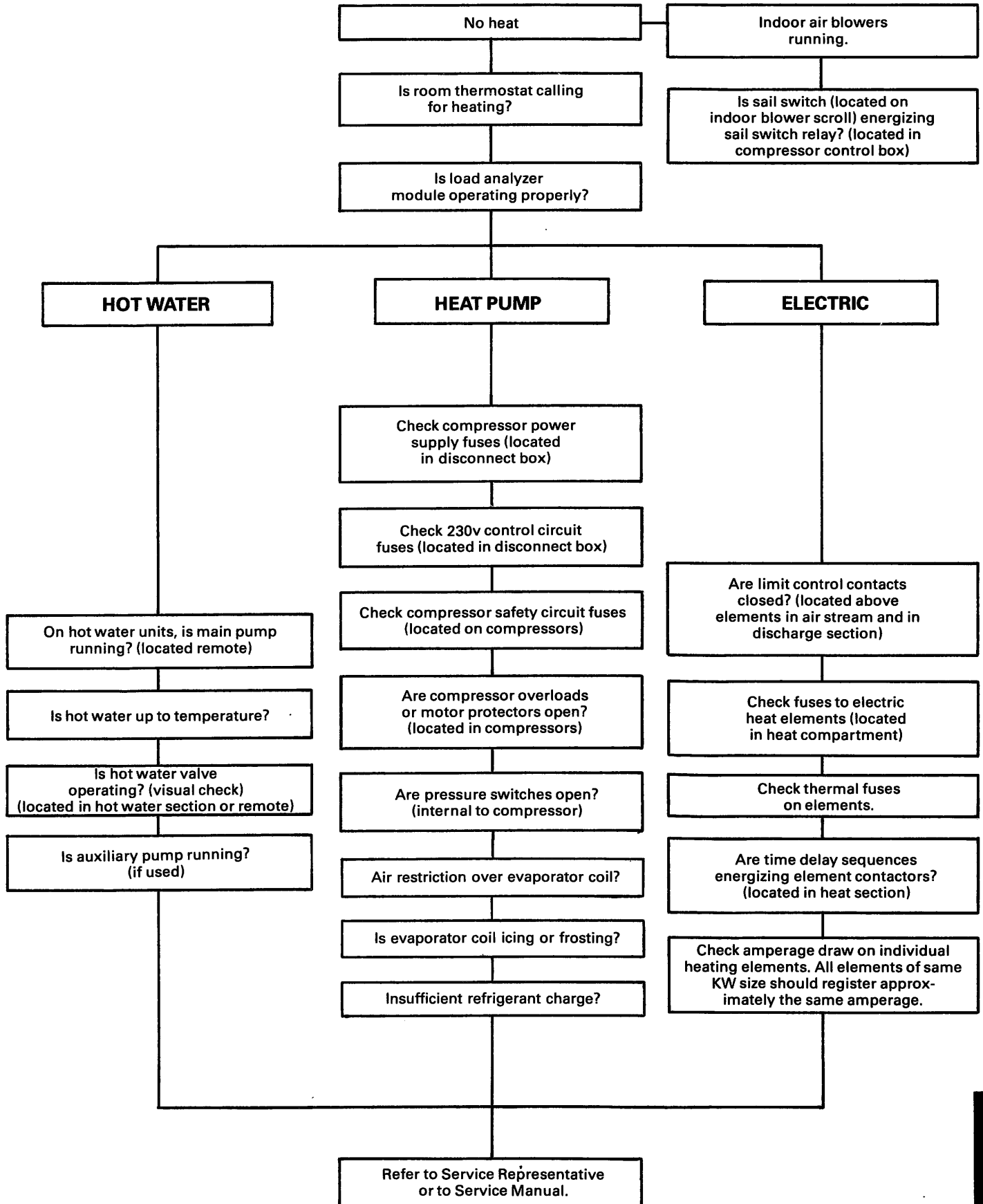

SERVICE FLOW CHART FOR REFRIGERANT SECTIONS

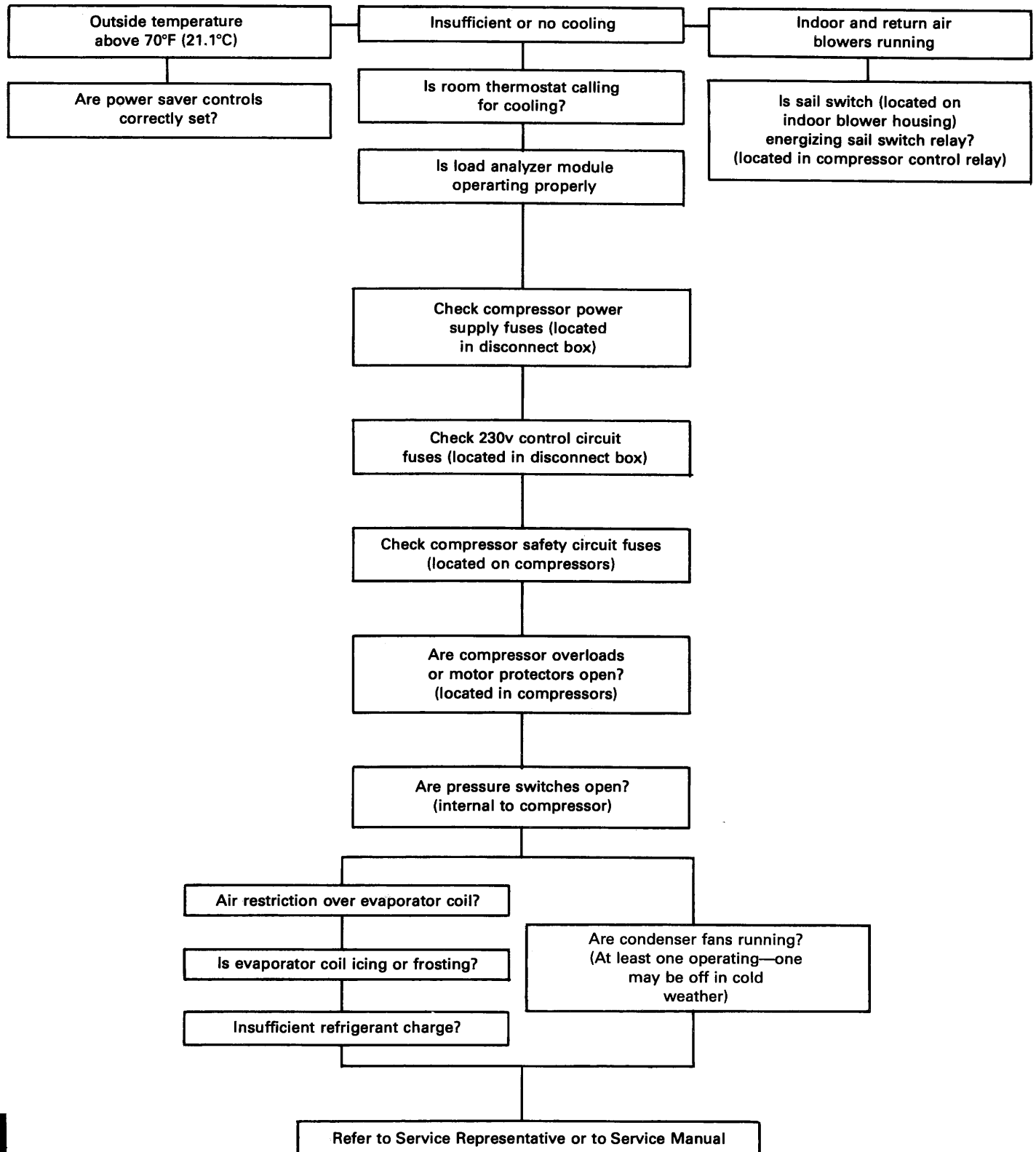



LENNOX

AN INTERNATIONAL ORGANIZATION TO SERVE YOU

United States
LENNOX INDUSTRIES INC.

Canada
LENNOX INDUSTRIES (CANADA) LTD.

France
LENNOX S.A.R.L.

United Kingdom
LENNOX INDUSTRIES LTD.

Netherlands
LENNOX B.V.

West Germany
LENNOX GmbH

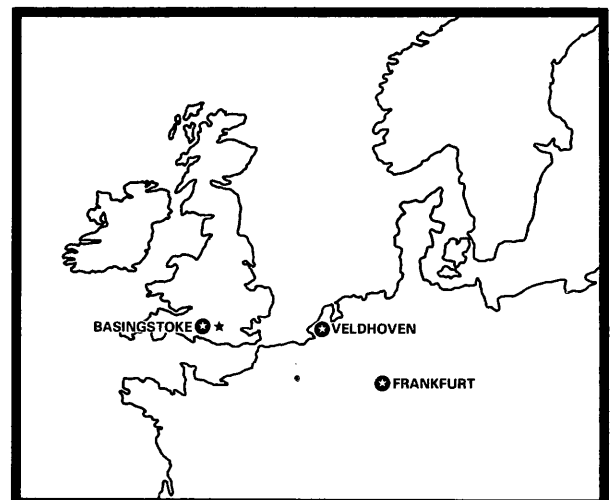

Litho U.S.A.

IF ADDITIONAL INFORMATION SHOULD BE NEEDED, CONTACT INSTALLING CONTRACTOR OR LENNOX TERRITORY MANAGER