

INSTALLATION OPERATING & MAINTENANCE MANUAL



PROVIDING GLOBAL SYSTEM SOLUTIONS

ROOFTOP
FLEXY[™]

English
September 2003



INSTALLATION OPERATION MAINTENANCE MANUAL

Ref. FLEXY_IOM/0903-E

The present manual applies to the following ROOFTOP versions :

FCA 60 - FCA 70 - FCA 85 - FCA 100 - FCA 120 - FCA 140 - FCA 160 - FCA 190
FCK 60 - FCK 70 - FCK 85 - FCK 100 - FCK 120 - FCK 140 - FCK 160 - FCK 190
FHA 60 - FHA 70 - FHA 85 - FHA 100 - FHA 120 - FHA 140 - FHA 160 - FHA 190
FHK 60 - FHK 70 - FHK 85 - FHK 100 - FHK 120 - FHK 140 - FHK 160 - FHK 190
FDA 60 - FDA 70 - FDA 85 - FDA 100 - FDA 120 - FDA 140 - FDA 160 - FDA 190
FDK 60 - FDK 70 - FDK 85 - FDK 100 - FDK 120 - FDK 140 - FDK 160 - FDK 190
FGA 60 - FGA 70 - FGA 85 - FGA 100 - FGA 120 - FGA 140 - FGA 160 - FGA 190
FGK 60 - FGK 70 - FGK 85 - FGK 100 - FGK 120 - FGK 140 - FGK 160 - FGK 190

FXA 25 - FXA 30 - FXA 35 - FXA 40 - FXA 55 - FXA 70 - FXA 85 - FXA 100 - FXA 110 - FXA 140 - FXA 170
FXK 25 - FXK 30 - FXK 35 - FXK 40 - FXK 55 - FXK 70 - FXK 85 - FXK 100 - FXK 110 - FXK 140 - FXK 170

NOTES FOR UNIT FITTED WITH GAS BURNER :

THE UNIT MUST BE INSTALLED IN ACCORDANCE WITH LOCAL SAFETY CODES AND REGULATIONS AND CAN ONLY BE USED IN WELL VENTILLATED AREA.

PLEASE READ CAREFULLY THE MANUFACTURER'S INSTRUCTIONS BEFORE STARTING THIS UNIT.

THIS MANUAL IS ONLY VALID FOR UNITS DISPLAYING THE FOLLOWING CODES:

GB	IR	GR	DA	NO	FI	IS
----	----	----	----	----	----	----

In case these symbols are not displayed on the unit, please refer to the technical documentation which will eventually detail any modifications required to the installation of the unit in a particular country.



CONTENTS

IMPORTANT NOTICE	3
INSTALLATION	
TRANSPORT - HANDLING	4
INSTALLATION	12
INSTALLATION ON A ROOF MOUNTING FRAME	13
INSTALLATION ON POSTS	15
COMMISSIONING	16
OPERATION	
VENTILATION	21
AIR FLOW BALANCING	23
FILTERS	39
FANSTART OPERATION	40
FX AIR FLOW BALANCING	41
HOT WATER COILS	44
GAS BURNERS	45
CONTROL FUNCTIONS	
USING THE KP 17 COMFORT DISPLAY	57
USING THE KP02 MAINTENANCE DISPLAY	58
USING THE KP07 REMOTE GRAPHICAL DISPLAY	72
BMS CONTACTS KIT	81
CLIMATIC™ PARAMETERS	82
CONTROL INTERFACE CLIMALINK/CLIMALOOK	88
WIRING DIAGRAMS	
ELECTRICAL WIRING DIAGRAMS LIST OF ITEMS	96
ELECTRICAL WIRING DIAGRAMS	100
TROUBLESHOOTING	
SAFETY AND ERROR CODES	117
MAINTENANCE DIAGNOSTIC	123
MAINTENANCE PLAN	126
WARRANTY	129
CERTIFICATES	
ISO 9001 CERTIFICATION	130
PED CERTIFICATION OF CONFORMITY	131
GLAS WOOL FIRE CLASS	132
33 KW GAS BURNER CE CERTIFICATION OF CONFORMITY	133
60 KW GAS BURNER CE CERTIFICATION OF CONFORMITY	134
120 KW GAS BURNER CE CERTIFICATION OF CONFORMITY	135
180 kW GAS BURNER CE CERTIFICATION OF CONFORMITY	136
INSULATION FIRE CLASS	137



IMPORTANT NOTICE

All work on the unit must be carried out by a qualified and authorised employee.

Non-compliance with the following instructions may result in injury or serious accidents.

Work on the unit:

- The unit shall be isolated from the electrical supply by disconnection and locking using the main isolating switch.
- Workers shall wear the appropriate personal protective equipment (helmet, gloves, glasses, etc.).

Work on the electrical system:

- Work on electric components shall be performed with the power off (see below) by employees having valid electrical qualification and authorisation.

Work on the refrigerating circuit(s):

- Monitoring of the pressures, draining and filling of the system under pressure shall be carried out using connections provided for this purpose and suitable equipment.
- To prevent the risk of explosion due to spraying of coolant and oil, the **relevant circuit shall be drained and at zero pressure** before any disassembly or unbrazing of the refrigerating parts takes place.
- There is a residual risk of pressure build-up by degassing the oil or by heating the exchangers after the circuit has been drained. **Zero pressure shall be maintained** by venting the drain connection to the atmosphere on the low pressure side.
- The brazing shall be carried out by a qualified brazier. The brazing shall comply with standard NF EN1044 (minimum 30% silver).

Replacing components:

- In order to maintain CE marking compliance, replacement of components shall be carried out using spare parts, or using parts approved by Lennox.
- Only the coolant shown on the manufacturer's nameplate shall be used, to the exclusion of all other products (mix of coolants, hydrocarbons, etc.).

CAUTION:

In the event of fire, refrigerating circuits can cause an explosion and spray coolant gas and oil.



DELIVERY CHECKS

On receipt of a new equipment please check the following points. It is the customer's responsibility to ensure that the products are in good working order:

- The exterior has not been damaged in any way.
- The lifting and handling equipment are suitable for the equipment and comply with the specifications of the handling instructions enclosed here-in.
- Accessories ordered for on site installation have been delivered and are in good working order.
- The equipment supplied corresponds to the order and matches the delivery note.

If the product is damaged, exact details must be confirmed in writing by registered post to the shipping company within 48 hours of delivery (working days). A copy of the letter must be addressed to Lennox and the supplier or distributor for information purposes. Failure to comply will invalidate any claim against the shipping company.

RATING PLATE

The rating plate provides a complete reference for the model and ensures that the unit corresponds to the model ordered. It states the electrical power consumption of the unit on start-up, its rated power and its supply voltage. The supply voltage must not deviate beyond +10/-15 %. The start-up power is the maximum value likely to be achieved for the specified operational voltage. The customer must have a suitable electrical supply. It is therefore important to check whether the supply voltage stated on the unit's rating plate is compatible with that of the mains electrical supply. The rating plate also states the year of manufacture as well as the type of refrigerant used and the required charge for each compressor circuit.

LENNOX		CE 0062		Usine Lyon S.I.L. LONGVIC 21600 LONGVIC FRANCE	
TYPE	FHK070	Usage Climatisation			
UNIT TYPE					
N° SERIE	220891_1 / 1	ANNEE	2000		
SERIAL NUMBER		YEAR			
ALIMENTATION	400	V	3	50	Hz
ELEC. SUPPLY					
I. MAXI	55.9	I. DEMARR.	143	A	C. COMMANDE
MAX AM ²		START UP AMF.			CONTRO. CIR.
					24 V
REFRIGERANT	R407C	Kg / CIRCUIT			
FLUIDE Groupe 2		12.1	12.1	0	0
		C1	C2	C3	C4
Date d'épreuve	Pression max (PT) déclenchement: pressostat HP				29.3 bar
27/01/2000	Maximum working pressure (FT)				
Temp maxi stockage	50 °C	Temp mini stockage	-35 °C		
Maximum storage temp		Min mum storage temp	NO: FKH070_1		

Figure 1

STORAGE

When units are delivered on site they are not always required immediately and are sometimes put into storage. In the event of medium to long-term storage, we recommend the following procedures :

- Ensure that there is no water in the hydraulic systems.
- Keep the heat exchanger covers in position (AQUILUX cover).
- Keep protective plastic film in position.
- Ensure the electrical panels are closed.
- Keep all items and options supplied in a dry and clean place for future assembly before using the equipment.

MAINTENANCE KEY

On delivery we recommend that you keep the key which is attached to an eyebolt in a safe and accessible place. This allows you to open the panels for maintenance and installation work.

The locks are ¼ turn + then tighter (figure 2).

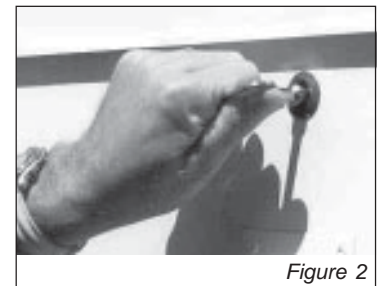

Figure 2

CONDENSATE DRAINS

The condensate drains are not assembled when delivered and are stored

in the electrical panel with their clamping collars.

To assemble them, insert them on the condensate tray outlets and use a screwdriver to tighten the collars (figure 3).



Figure 3



DIMENSIONS AND WEIGHTS

Condensation		Airflow configuration								LENGTH (mm)	WIDTH (mm)	HEIGHT (mm)	HOOD (mm)	WEIGHT (kg)			SLING		
Standard	Centrifugal	1	2	3	4	5	6	7	8					std	std gas	high gas	1	2	3
FC/FH 060 - Cooling only and heat pump																			
X	-	X	-	-	-	-	-	-	X	2825	2255	1470	630	1060	-	-	2210	-	-
X	-	-	-	-	X	-	-	X	-	2825	2255	1470	630	1090	-	-	2210	-	-
X	-	-	X	X	-	X	X	-	-	2825	2285	1470	630	1090	-	-	2210	-	-
-	X	X	-	-	-	-	-	-	X	2875	2255	2070	630	1230	-	-	2590	1855	-
-	X	-	-	-	X	-	-	X	-	2875	2255	2070	630	1260	-	-	2590	1855	-
-	X	-	X	X	-	X	X	-	-	2875	2285	2070	630	1260	-	-	2590	1855	-
FG 060 - GAS																			
X	-	X	-	-	-	-	-	-	X	2825	2255	1470	630	-	1210	1280	2210	-	-
-	X	X	-	-	-	-	-	-	X	2875	2255	2070	630	-	1380	1450	2590	1855	-
FC/FH 070 - Cooling only and heat pump																			
X	-	X	-	-	-	-	-	-	X	2825	2255	1470	630	1075	-	-	2210	-	-
X	-	-	-	-	X	-	-	X	-	2825	2255	1470	630	1100	-	-	2210	-	-
X	-	-	X	X	-	X	X	-	-	2825	2285	1470	630	1100	-	-	2210	-	-
-	X	X	-	-	-	-	-	-	X	2875	2255	2070	630	1245	-	-	2590	1855	-
-	X	-	-	-	X	-	-	X	-	2875	2255	2070	630	1270	-	-	2590	1855	-
-	X	-	X	X	-	X	X	-	-	2875	2285	2070	630	1270	-	-	2590	1855	-
FC/FH 070 - GAS																			
X	-	X	-	-	-	-	-	-	X	2825	2255	1470	630	-	1230	1300	2210	-	-
-	X	X	-	-	-	-	-	-	X	2875	2255	2070	630	-	1400	1470	2590	1855	-
FC/FH 085 - Cooling only and heat pump																			
X	-	X	-	-	-	-	-	-	X	3785	2255	1495	630	1220	-	-	2830	2330	-
X	-	-	-	-	X	-	-	X	-	3785	2255	1495	630	1270	-	-	2830	2330	-
X	-	-	X	X	-	X	X	-	-	3785	2285	1495	630	1275	-	-	2830	2330	-
-	X	X	-	-	-	-	-	-	X	3835	2255	2080	630	1435	-	-	3230	2430	1870
-	X	-	-	-	X	-	-	X	-	3835	2255	2080	630	1485	-	-	3230	2430	1870
-	X	-	X	X	-	X	X	-	-	3835	2285	2080	630	1490	-	-	3230	2430	1870
FC/FH 085 - GAS																			
X	-	X	-	-	-	-	-	-	X	3785	2255	1495	630	-	1320	1390	2830	2330	-
-	X	X	-	-	-	-	-	-	X	3835	2255	2080	630	-	1535	1605	3230	2430	1870
FC/FH 100 - Cooling only and heat pump																			
X	-	X	-	-	-	-	-	-	X	3785	2255	1495	630	1280	-	-	2830	2330	-
X	-	-	-	-	X	-	-	X	-	3785	2255	1495	630	1320	-	-	2830	2330	-
X	-	-	X	X	-	X	X	-	-	3785	2285	1495	630	1320	-	-	2830	2330	-
-	X	X	-	-	-	-	-	-	X	3835	2255	2080	630	1495	-	-	3230	2430	1870
-	X	-	-	-	X	-	-	X	-	3835	2255	2080	630	1545	-	-	3230	2430	1870
-	X	-	X	X	-	X	X	-	-	3835	2285	2080	630	1545	-	-	3230	2430	1870
FC/FH 100 - GAS																			
X	-	X	-	-	-	-	-	-	X	3785	2255	1495	630	-	1380	1450	2830	2330	-
-	X	X	-	-	-	-	-	-	X	3835	2255	2080	630	-	1595	1665	3230	2430	1870



DIMENSIONS AND WEIGHTS

Condensation		Airflow configuration								LENGTH (mm)	WIDTH (mm)	HEIGHT (mm)	CASQUETTE (mm)	WEIGHT (kg)			SLING		
Standard	Centrifugal	1	2	3	4	5	6	7	8					std	std gas	high gas	1	2	3
FC/FH 120 - Cooling only and heat pump																			
X	-	X	-	-	-	-	-	-	X	3585	2255	1470	630	1530	-	-	2700	-	2080
X	-	-	-	-	X	-	-	X	-	3585	2255	1470	630	1580	-	-	2700	-	2080
X	-	-	X	X	-	X	X	-	-	3585	2285	1470	630	1600	-	-	2700	-	2080
-	X	X	-	-	-	-	-	-	X	3635	2255	1930	630	1805	-	-	3000	2410	1880
-	X	-	-	-	X	-	-	X	-	3635	2255	1930	630	1855	-	-	3000	2410	1880
-	X	-	X	X	-	X	X	-	-	3635	2285	1930	630	1875	-	-	3000	2410	1880
FG 120 - GAS																			
X	-	X	-	-	-	-	-	-	X	4035	2255	1470	630	-	1840	1890	3000	-	2310
-	X	X	-	-	-	-	-	-	X	4085	2255	1930	630	-	2115	2165	3300	2700	2080
FC/FH 140 - Cooling only and heat pump																			
X	-	X	-	-	-	-	-	-	X	3585	2255	1470	630	1630	-	-	2700	-	2080
X	-	-	-	-	X	-	-	X	-	3585	2255	1470	630	1680	-	-	2700	-	2080
X	-	-	X	X	-	X	X	-	-	3585	2285	1470	630	1700	-	-	2700	-	2080
-	X	X	-	-	-	-	-	-	X	3635	2255	1930	630	1905	-	-	3000	2410	1880
-	X	-	-	-	X	-	-	X	-	3635	2255	1930	630	1955	-	-	3000	2410	1880
-	X	-	X	X	-	X	X	-	-	3635	2285	1930	630	1975	-	-	3000	2410	1880
FG 140 - GAS																			
X	-	X	-	-	-	-	-	-	X	4035	2255	1470	630	-	1920	1970	3000	-	2310
-	X	X	-	-	-	-	-	-	X	4085	2255	1930	630	-	2000	2050	3300	2700	2080
FC/FH 160 - Cooling only and heat pump																			
X	-	X	-	-	-	-	-	-	X	3595	2255	2070	900	2050	-	-	2700	-	2090
X	-	-	-	-	X	-	-	X	-	3595	2255	2070	900	2120	-	-	2700	-	2090
X	-	-	X	X	-	X	X	-	-	3595	2285	2070	900	2140	-	-	2700	-	2090
-	X	X	-	-	-	-	-	-	X	3645	2255	2070	900	2275	-	-	2700	-	2090
-	X	-	-	-	X	-	-	X	-	3645	2255	2070	900	2345	-	-	2700	-	2090
-	X	-	X	X	-	X	X	-	-	3645	2285	2070	900	2365	-	-	2700	-	2090
FG 160 - GAS																			
X	-	X	-	-	-	-	-	-	X	4045	2255	2070	900	-	2410	2460	3000	-	2320
-	X	X	-	-	-	-	-	-	X	4095	2255	2070	900	-	2635	2685	3000	-	2320
FC/FH 190 - Cooling only and heat pump																			
X	-	X	-	-	-	-	-	-	X	3595	2255	2070	900	2175	-	-	2700	-	2090
X	-	-	-	-	X	-	-	X	-	3595	2255	2070	900	2245	-	-	2700	-	2090
X	-	-	X	X	-	X	X	-	-	3595	2285	2070	900	2265	-	-	2700	-	2090
-	X	X	-	-	-	-	-	-	X	3645	2255	2070	900	2400	-	-	2700	-	2090
-	X	-	-	-	X	-	-	X	-	3645	2255	2070	900	2470	-	-	2700	-	2090
-	X	-	X	X	-	X	X	-	-	3645	2285	2070	900	2490	-	-	2700	-	2090
FG 190 - GAS																			
X	-	X	-	-	-	-	-	-	X	4045	2255	2070	900	-	2540	2600	3000	-	2320
-	X	X	-	-	-	-	-	-	X	4095	2255	2070	900	-	2765	2825	3000	-	2320



DIMENSIONS AND WEIGHTS

MODELS	LENGTH mm	HEIGHT mm	WIDTH mm	AUVENT		WEIGHT (kg) standard kg
				lateral mm	ventil mm	
FX 025	4070	1635	1055	490	600	950
FX 030	4070	1635	1055	490	600	980
FX 035	4750	2255	1290	490	600	1400
FX 040	4750	2255	1290	490	600	1450
FX 055	4750	2255	1290	490	600	1600
FX 070	5050	2255	1725	890	600	1800
FX 085	5050	2255	1725	890	600	1900
FX 100	5050	2255	1725	890	600	2000
FX 110	5650	2255	2000	860	-	2620
FX 140	5650	2255	2000	860	-	2620
FX 170	5650	2255	2000	860	-	2650

HANDLING

The equipment can be moved using the lifting holes on the top of the unit.
The "sling" length is the value that we recommend for safe handling of the equipment.

Some units can only be supported by four slings at right-angles. Others require different lengths (see figures 4). It is essential that all lifting holes are used and that the slings are all of the same size to avoid damaging the equipment.

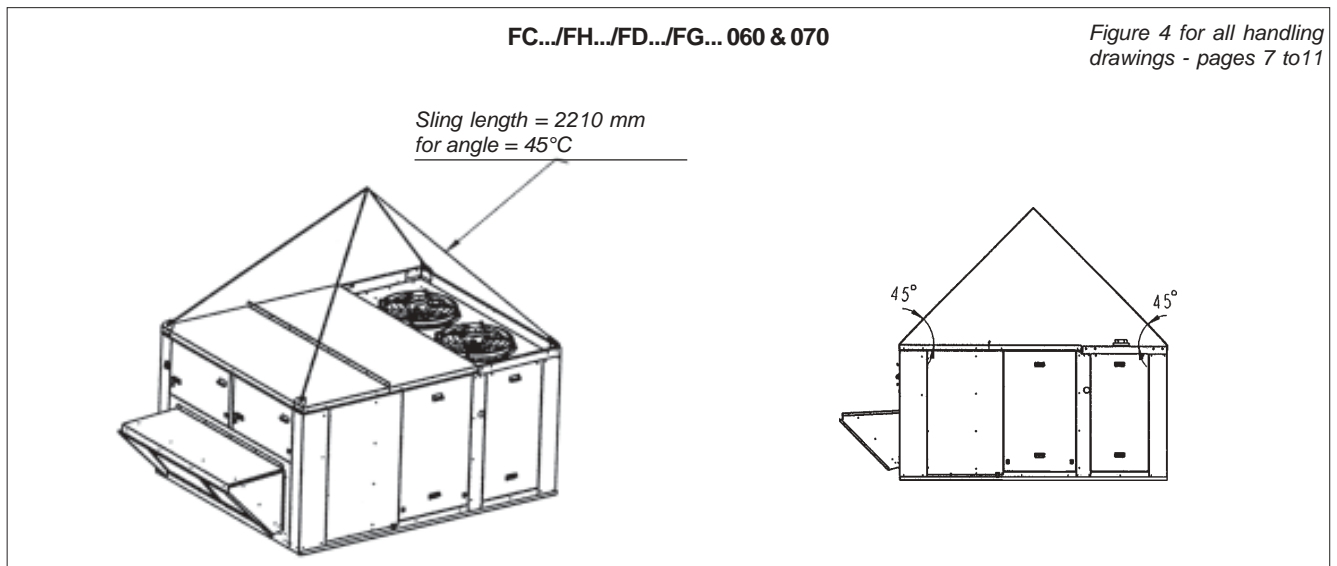
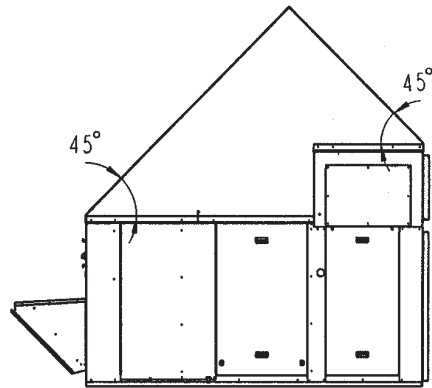
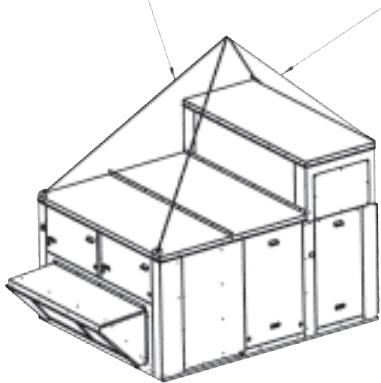



Figure 3 for all handling drawings - pages 7 to 11

FC.../FH.../FD.../FG... 060 & 070 with centrifugal fans

Sling length = 2590 mm
for angle = 45°C



FC.../FH.../FD.../FG... 085 & 100

Sling length = 2830 mm
for angle = 45°C

Sling length = 2330 mm
for angle = 64,5°C

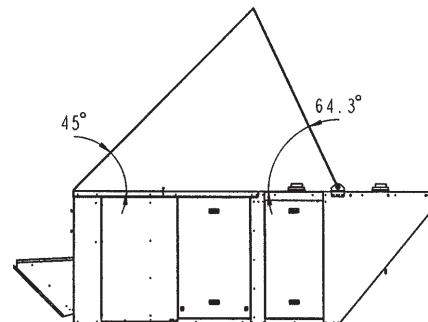
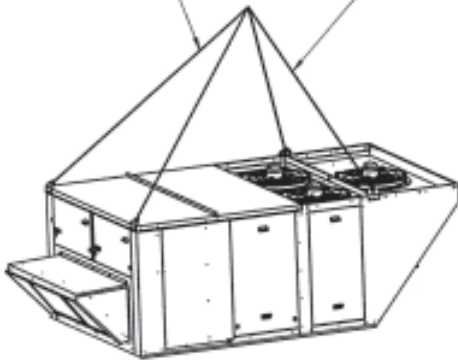

FC.../FH.../FD.../FG... 085 & 100 with centrifugal fans

Sling length = 3230 mm
for angle = 45°C

Sling length = 2430 mm
for angle = 45°C

Sling length = 1870 mm
for angle = 45°C

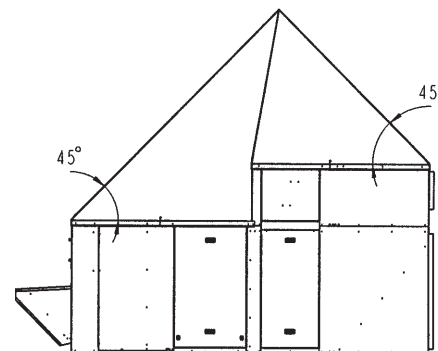
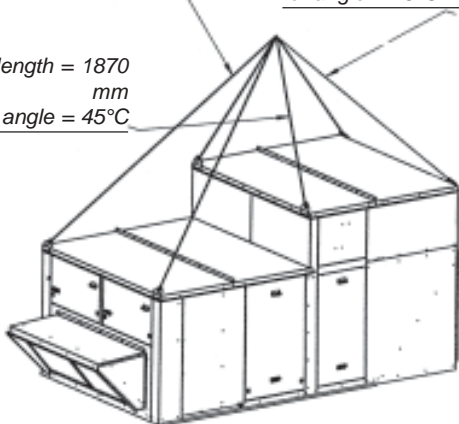

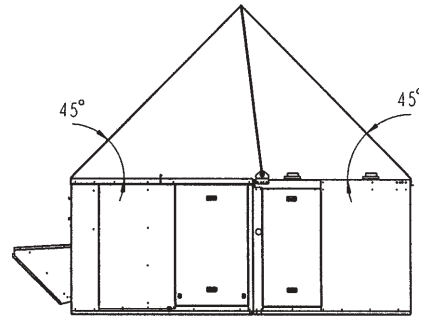
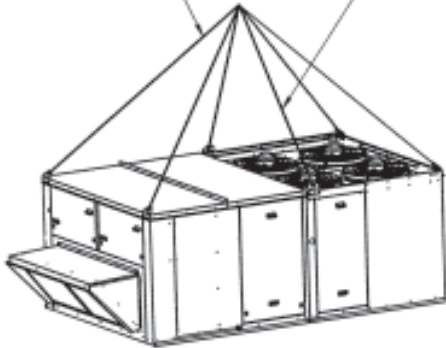

Figure 3 for all handling drawings - pages 7 to 11

FC.../FH.../FD... 120 & 140

Sling length = 2700 mm
for angle = 45°C

Sling length = 2080 mm
for angle = 45°C



FC.../FH.../FD... 120 & 140 with centrifugal fans

Sling length = 3000 mm
for angle = 45°C

Sling length = 2410 mm
for angle = 45°C

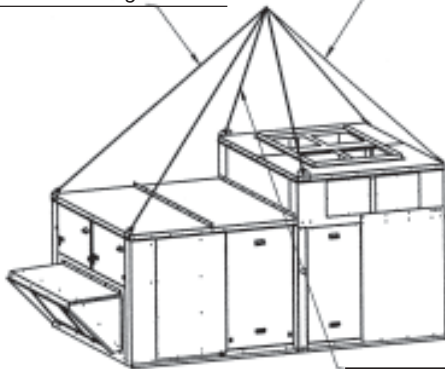

Sling length = 1880 mm
for angle = 45°C

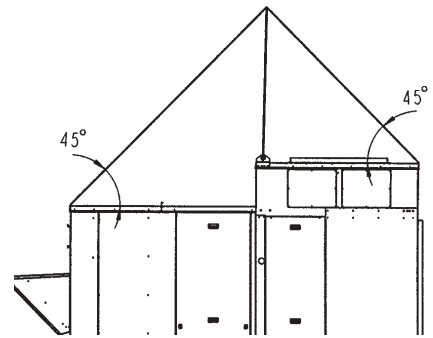

FG... 120 & 140 with gas burner

Sling length = 2700 mm
for angle = 45°C

Sling length = 2080 mm
for angle = 45°C

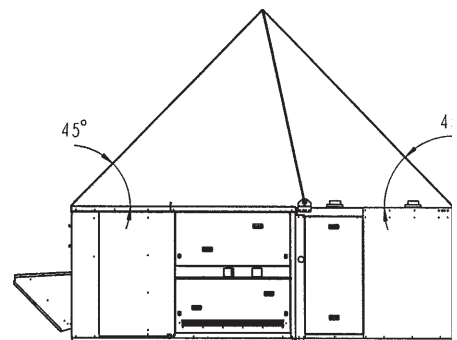
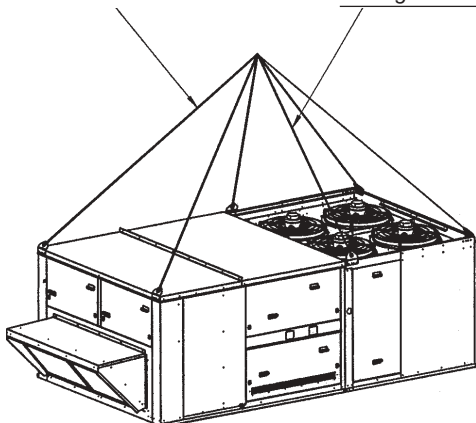
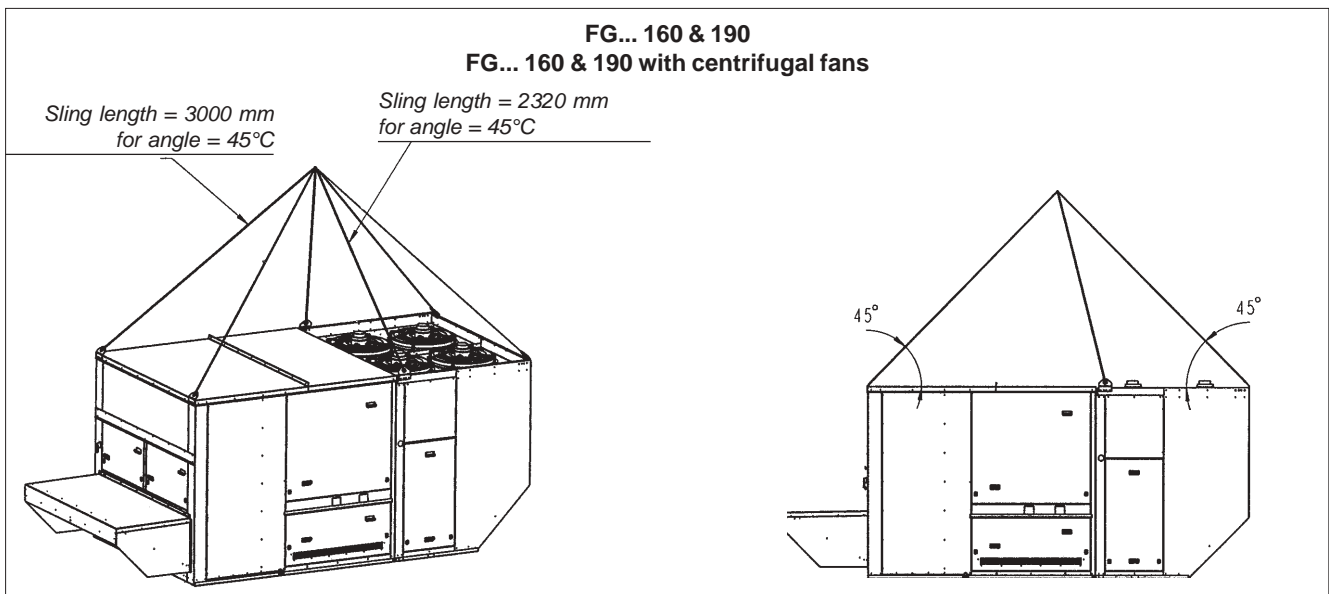
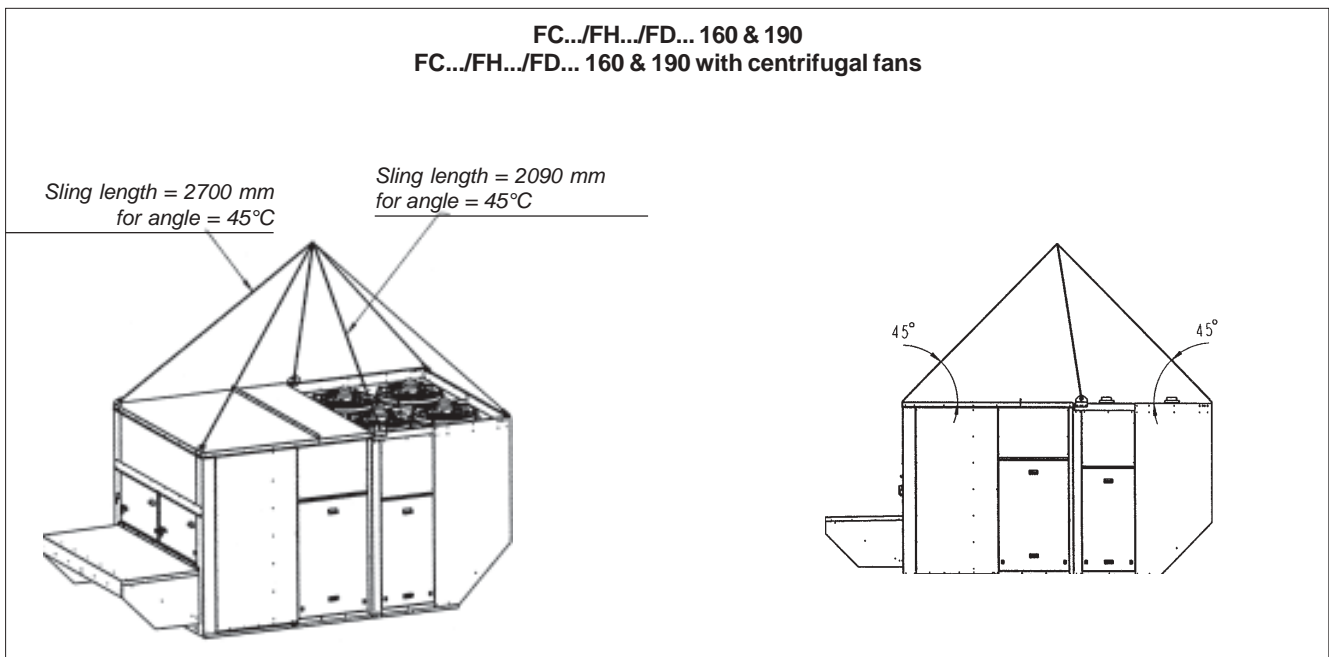
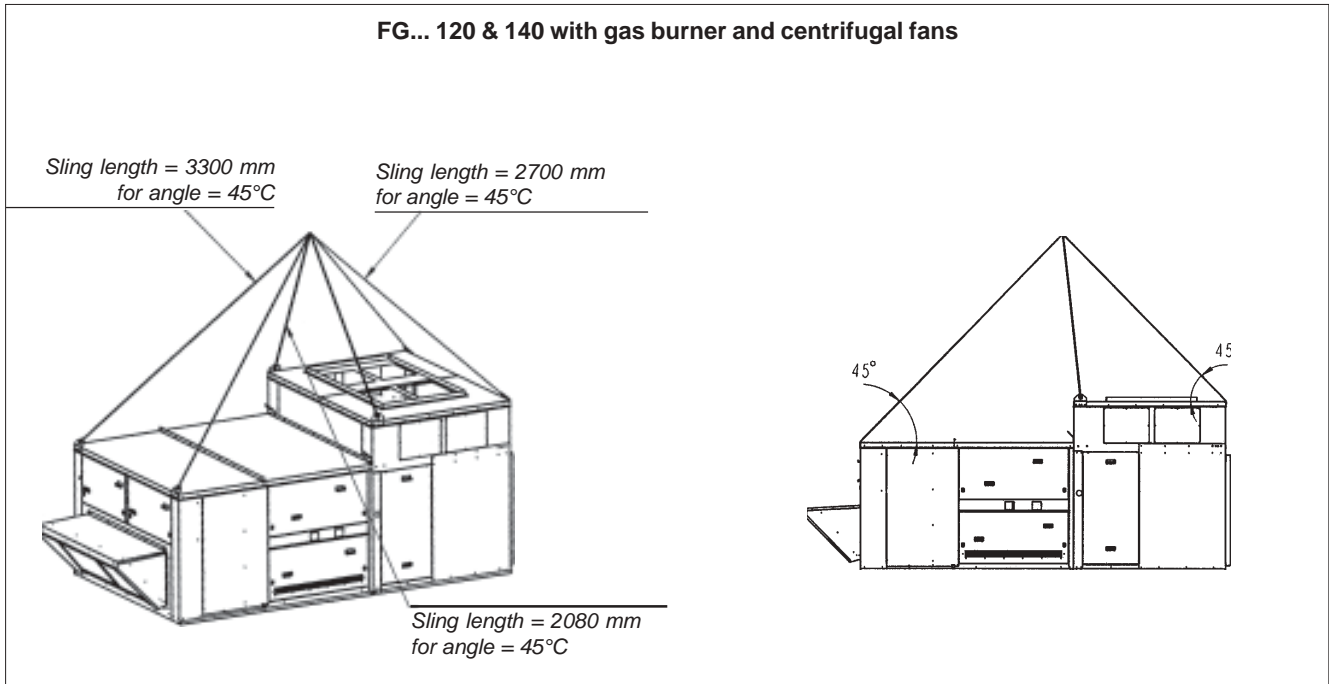



Figure 3 for all handling drawings - pages 7 to11





FX 25 & 30

Sling length 1 = 3000 mm
Sling length 2 = 2350 mm

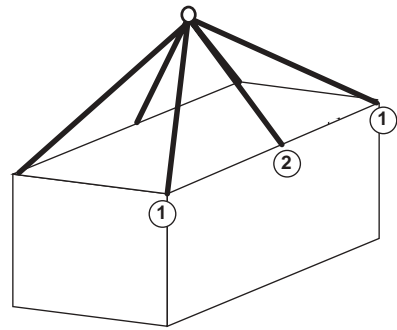

FX 35 - 40 - 55

Sling length 1 = 3700 mm
Sling length 2 = 2850 mm

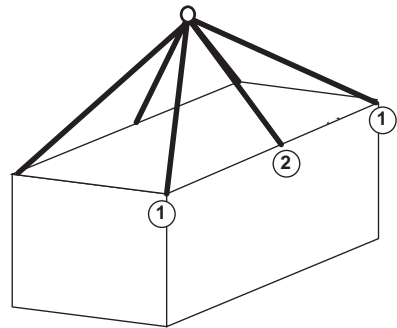

FX 70 - 85 - 100

Sling length 1 = 3900 mm
Sling length 2 = 3000 mm

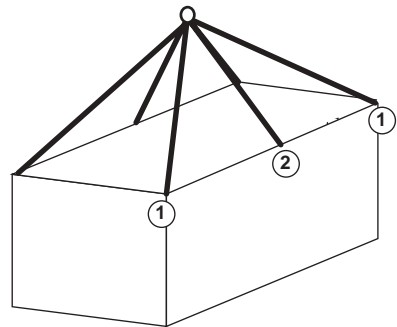

FX 110 - 140 - 170

Sling length 1 = 4300 mm
Sling length 2 = 3250 mm

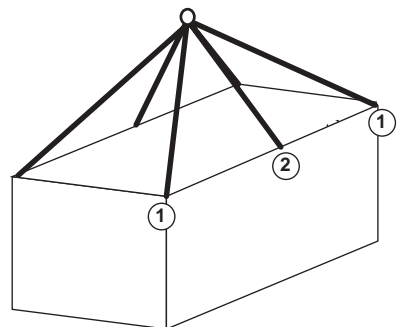



PRELIMINARY CHECK

Before installing the equipment, the following items **MUST** be checked :

- Is there sufficient space for the equipment?
- Is the surface on which the equipment is to be installed sufficiently solid to withstand its weight ? A detailed study of the frame must be made beforehand.
- Do the supply and return ductwork openings excessively weaken the structure?
- Are there any obstructing items which could hinder the operation of the equipment?
- Does the electrical power available correspond to the equipment's electrical specifications?
- Is drainage provided for the condensate?
- Is there sufficient access for maintenance?
- Installation of the equipment could require different lifting methods which may vary with each installation (helicopter or crane). Have these been evaluated ?
- Ensure that the unit is installed in accordance with the installation instructions and applicable codes.
- Check to ensure that the refrigerant lines do not rub against the cabinet or against other refrigerant lines.

In general, make sure no obstacles (walls, trees or roof ledges) are obstructing the duct connections or hindering assembly and maintenance access.

INSTALLATION REQUIREMENTS

The surface on which the equipment is to be installed must be clean and free of any obstacles which could hinder the flow of air to the condensers:

- Avoid uneven surfaces
- Avoid installing two units side by side or close to each other as this may restrict the airflow to the condensers.

Before installing a packaged rooftop unit it is important to understand :

- The direction of prevailing winds.
- The direction and position of air flows.
- The external dimensions of the unit and the dimensions of the supply and return air connections.
- The arrangement of the doors and the space required to open them to access the various components.

Figure 5 shows the required clearances and dimensions.

CONNECTIONS

- Ensure that all the pipework crossing walls or roofs are secured and insulated.
- To avoid condensation problems, be sure all pipes are insulated according to temperatures of fluids and type of rooms.

NOTE : The AQUILUX protection sheets fitted to the finned surfaces must be removed prior to start up.

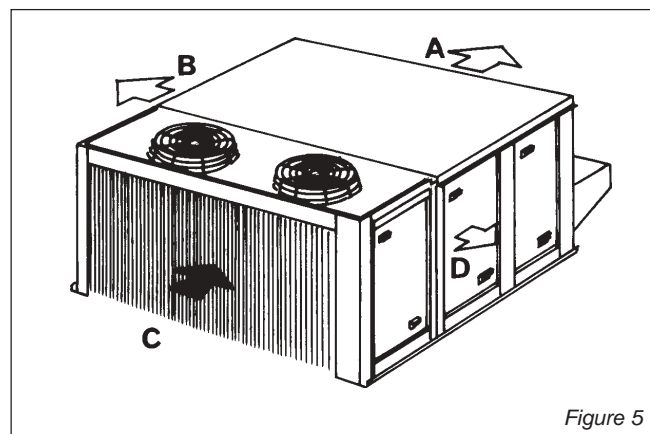

Figure 5

MODELS	A	B	C	D
FC/FH/FG/FD				
60 → 140	1400	2000	1400	2300
160 & 190	2000	2000	2000	2300
FX				
25 & 30	*	1100	*	1700
35 → 55	*	1300	*	2300
70 → 100	*	1700	*	2300
110 → 170	*	2000	*	2300

* : according to connection



As levels are adjustable, observe the following recommendations for correct installation of the equipment.

Above all, ensure that all the adjustable returns are facing outward (1 - figure 6). They are usually turned inside-out for transport.

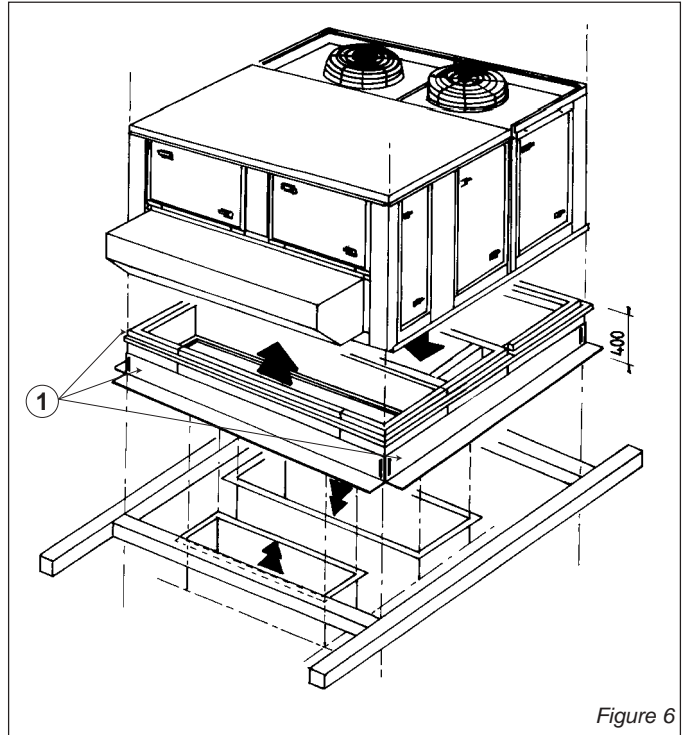

Figure 6

Place the roof mounting frame on the trimmer beam by first lining up the inlet and then the outlet. (2 - figure 7).

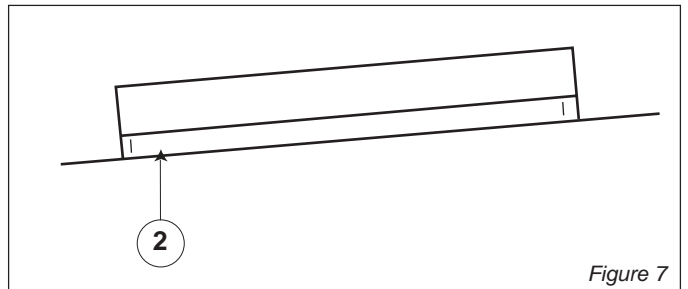

Figure 7

After levelling the frame, fix the surface flaps onto the trimmer.

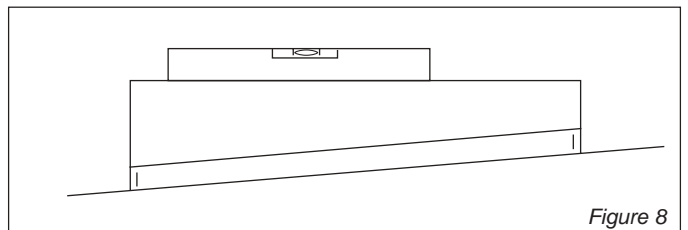
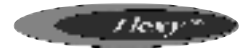

Figure 8



When the frame is correctly positioned, it is essential to secure the assembly with welding seam (20 to 30 mm for every 200 mm) along the outside, or by using an alternative method (1 - figure 9).

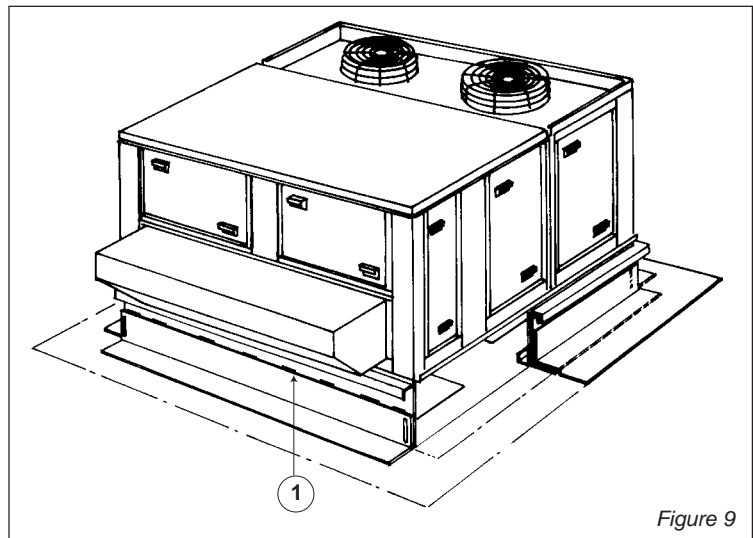

Figure 9

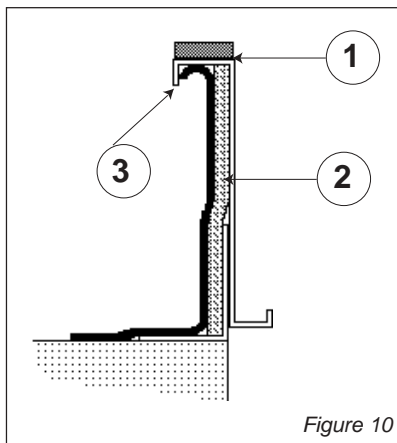

Figure 10

Assembly joint (1 - figure 10)

Insulate the frame before installation. We recommend the minimum application of 25 mm thick insulation.

Check that the covering is continuous and watertight (2 - figure 10).

CAUTION : To be effective, it must finish behind the lip (3 - figure 10)

Before installing the equipment, make sure that the assembly seal is not damaged. Once in position, the bottom of the equipment must be horizontal and against the roofcurb as shown on figure 11.

The installer must comply to local authority standards and specifications.

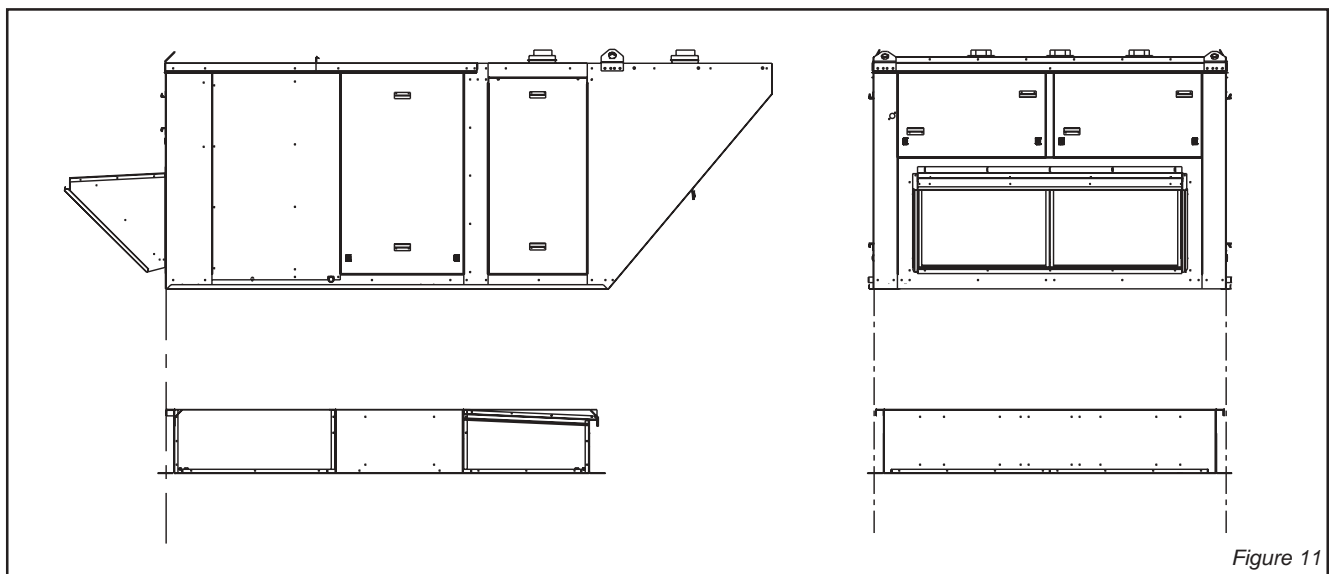

Figure 11



The unit can be fitted on corner posts using the frame provided. The minimum height of the posts should be 400mm.

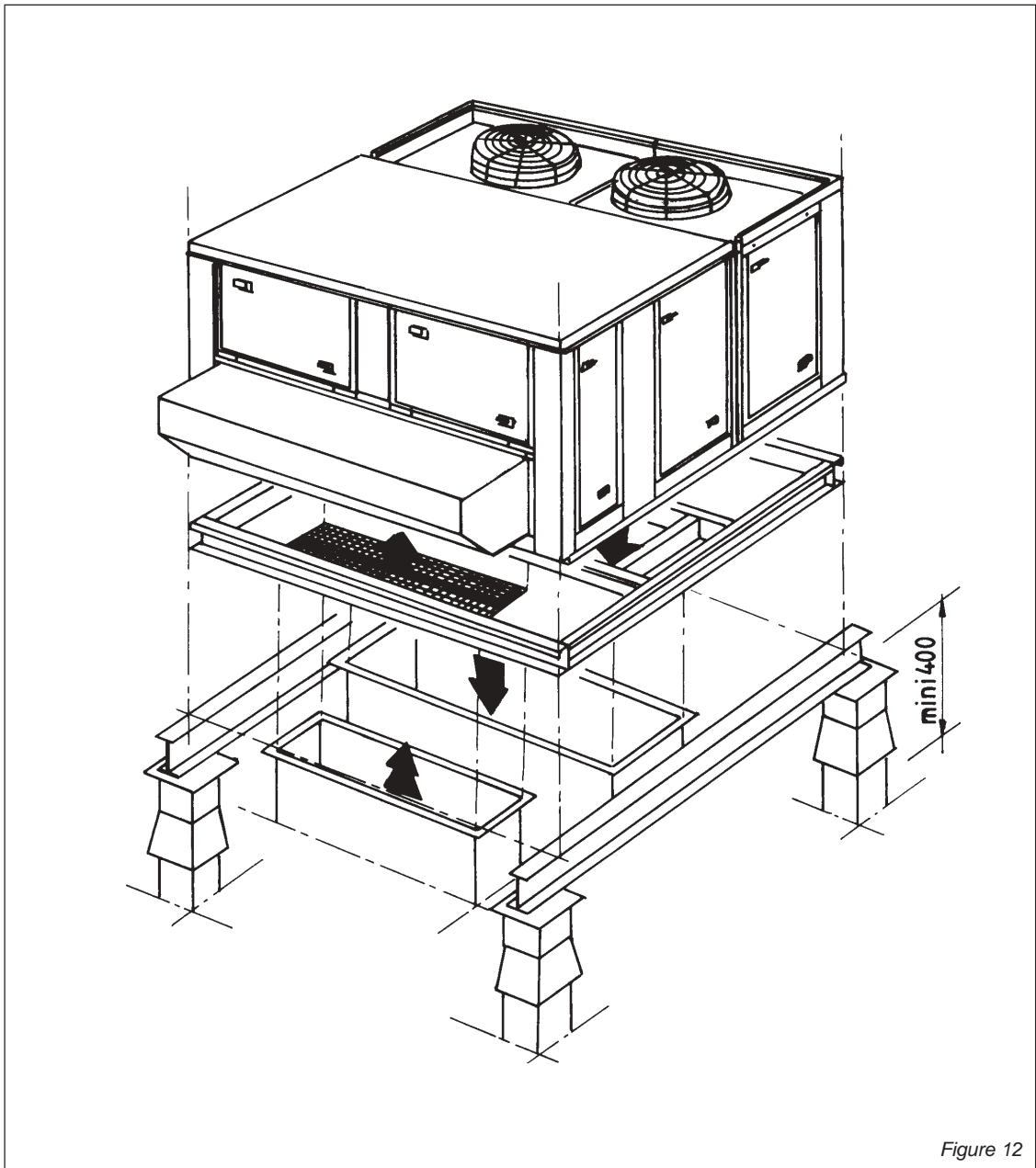

Figure 12



THIS WORK MUST ONLY BE CARRIED OUT BY TRAINED REFRIGERATION ENGINEERS

Before connecting the power :

- Ensure that the power supply between the building and the unit meets local authority standards and that the cable specification satisfies the start-up and operating conditions.
- Ensure that the electrical connections in the control panel and on the motors are secure.
- Ensure that all drive motors are secure.
- Ensure that the adjustable pulley blocks are secure and that the belt is tensioned with the transmission correctly aligned.
- Using the electrical wiring diagram, check the conformity of the electrical safety devices (circuit breaker settings, presence and rating of fuses).

At this point attach the manometers to the refrigerant circuit

Powering up the system with the unit isolating switch

- Close the blower circuit breaker and the 24V control.
- Power up the unit by closing the isolator switch. At this point the blower should start unless the CLIMATIC™ does not energise the contactor. In this particular case the blower can be forced by bridging the COM and NO wires on the connector J1 on the CLIMATIC controller. Once the fan is running check the rotation direction. Refer to the rotation arrow on the fan.
- The fan and other components direction of rotation is checked during an end of line test. They should therefore all turn in the same direction.
- If they run in the opposite direction, disconnect the power supply to the machine at the building's mains switch, reverse two phases of the incoming supply to the machine and try again.

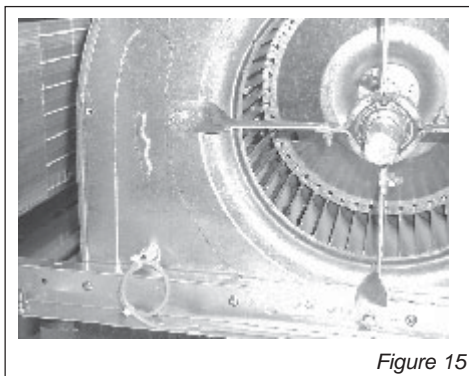

Figure 15

Using CLIMATIC™

- Check the voltages recorded against the rated values, in particular on the system supply fans.
- If the readings on the fans are outside the limits, this indicates excessive air flow which will affect the thermodynamic performance. Refer to the "Air flow balancing" section.

1. Check the configuration

- You will need a KP02 maintenance controller or CLIMALOOK with KP 14 interface.

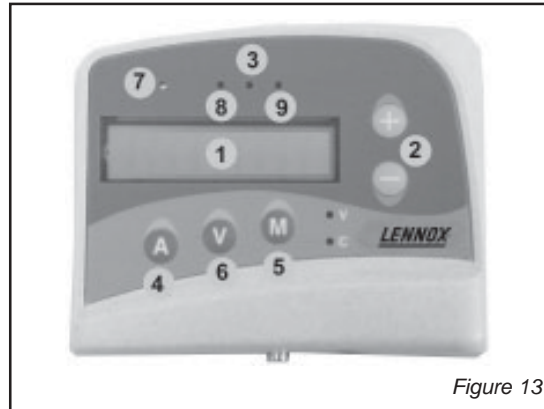

Figure 13

- 1 Liquid crystal display
- 2 Raise/lower keys
- 3 "FILTER" Led (flashing red)
- 4 "ADDRESS" key
- 5 "MODE" key
- 6 "VALUE" key
- 7 "UNIT RUNNING" led
- 8 "MODE" led
- 9 "GENERAL ALARM" led.

- The jumpers are factory set and the configuration switches are adjusted depending on the option selection and the type of unit.

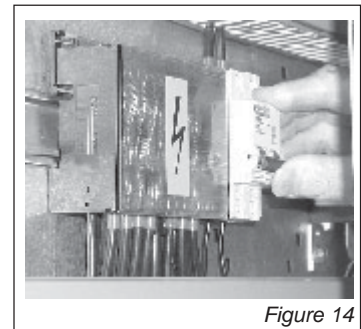

Figure 14

- Close the 24V control circuit breakers
- The CLIMATIC™ is starting. Wait for 30 seconds.

1.1 Check and adjust the factory configuration

- Reset the DAD smoke detector (if fitted)

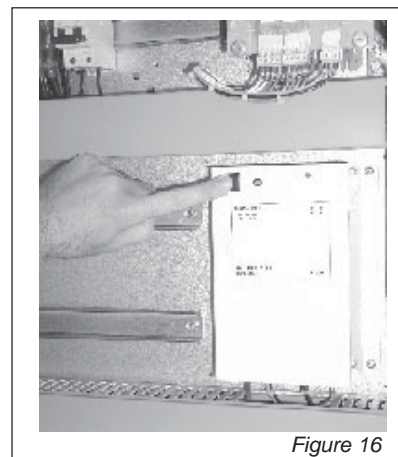

Figure 16



Check the setpoints on CLIMATIC™ (LF 20).

C0	Password technician Level	63
C98	Type of Unit	Refer to configuration table LF20
C99	Type of Unit [off] Flexy [on] Linea	On or OFF
C103	Humidity and enthalpy management Option	[off] LINEA [on] only Flexy with Advanced Pack
C77	(Linea) Authorisation of defrost. Threshold of temperature of refrigerant fluid (in°C)	1.0°C for R407c -3.0°C for R22
C79	Defrost cycle end value indicating the nr of Start-ups of the condenser fan to signify the end of defrost	Linea set to1 Flexy set to 3
C101	Activation of all seasons control option	[ON] / [OFF] if fitted
C73	All seasons control option on FLEXY - Otherwise – unloading 50% of the compressors in cooling mode	Set to 20.0°C for Linea Set to 12°C for Flexy
C74	If option all seasons control – shut down condenser fans - Otherwise - 100% unloading of compressors in cooling mode -	Set to 12.0°C for Linea Set to 5.0°C for Flexy
C49	Threshold of activation of the power exhaust fan according to the position of the economiser damper (in %)	Set to 50%
C46	Number of minutes of anticipation per degrees. This allows an anticipated start-up in the morning mode depending on the outside temperature.	Set to 0
C83	Maximum usable power for electric heat (in %)	
C90	Choice of operating mode for KP17	[ON] = KP17 in ON / OFF mode
C91	Identification number for the J-Bus connections	
C93	Identification number for the connections link between boards	
C94	Number of boards linked on the bus	
C95	Selection of the operating mode for KP017	
C96	Selection of exchange mode for room temperature and humidity-	
C97	Selection of exchange mode for outdoor temperature and humidity	
C100	Activation of the dual-speed option for fan supply (Flexy)	
C101	Activation of the all seasons control option	
C102	Activation of the optimised defrost option	
C05	Fault reset	Set to ON
C06	Remote control, On / Off Unit	Set to ON (the unit should start)



Configuration table LF20

F.A050	11	FXA025	20	F.K050	111	FXK025	120
F.A060	12	FXA030	21	F.K060	112	FXK030	121
F.A070	13	FXA035	22	F.K070	113	FXK035	122
F.A085	14	FXA040	23	F.K085	114	FXK040	123
F.A100	15	FXA055	24	F.K100	115	FXK055	124
F.A120	16	FXA070	25	F.K120	116	FXK070	125
F.A140	17	FXA085	26	F.K140	117	FXK085	126
F.A160	18	FXA100	27	F.K160	118	FXK100	127
F.A190	19	FXA110	28	F.K190	119	FXK110	128
		FXA140	29			FXK140	129
		FXA170	30			FXK170	130

Switches on KP01

- 1 = on Option : pressure pick-up on air 500 pa (on FLEXY™ off = sensor 1000 pa)
- 2 = on | 3 = off Option : hot water coil
- 2 = off | 3 = on Option : electrical heater
- 2 = on | 3 = on Option : gas burner
- 4 = on Option : cycle reversing valve, compressors (heat pump)
- 5 = on Option : heating of great power / or / pump (except freezing of the hot water coil)
- 6 = on Option : fresh air, economiser
- 7 = on Option : fresh air, all fresh air
- 8 = on Option : KP02 / KP17

POWERING THE UNIT

- Power up the unit by closing the isolator switch (if fitted).
- Close all circuit breakers and power up the unit, remove the bridge on connector J14 if fitted.
- If now only one of the components rotates in the wrong direction, disconnect the power supply at the machine's isolator switch (if fitted) and reverse two of the component's phases on the terminal within the electrical panel.
- Check the current drawn against the rated values, in particular on the supply fan.
- If the readings on the fan are outside the specified limits, this usually indicates excessive air flow which will affect the life expectancy and the thermodynamic performances of the unit. This will also increase the risks of water ingress into the unit. Refer to the "air flow balancing" section to correct the problem.

At this point attach the manometers to the refrigerant circuit.

RUN TEST

Start unit in cooling mode

Thermodynamic readings using manometers and prevailing environmental conditions.

No rated values are given here. These depend on the environmental conditions both outside and inside the building during operation. However, an experienced refrigeration engineer will be able to detect any abnormal machine operation.

Safety test

- "Dirty filter" detection test : vary the set-point value in respect to the air pressure value. Observe the response of the CLIMATIC™.
- Same procedure for detecting "Missing filter" or "Air flow detection".
- Check the smoke detection function (if fitted).
- Check the Firestat by pressing the test button (if fitted).
- Disconnect the circuit breakers of the outdoor fans and check the high pressure cut-out points on different refrigerant circuits.

Reverse cycle test

This test is designed to check the good operation of the 4-way reversing valves on heat pump reversible systems. Start the reverse cycle by adjusting the cold or hot temperature threshold data according to the indoor and outdoor conditions at the time of test.



Site details / Informations site		Controller/ Contrôleur
Site / Site		Model/Modele
Unit Ref/ N° Affaire		Serial No/ No Série
Installer/ Installateur		Refrigerant / Réfrigérant

(1) ROOF INSTALLATION / INSTALLATION SUR LE TOIT

Sufficient Access OK / Accès Suffisants Yes/Oui <input type="checkbox"/> No/ Non <input type="checkbox"/>	Condensate drain fitted / Drainage condensats Installé Yes/Oui <input type="checkbox"/> No/ Non <input type="checkbox"/>	Roofcurb / Costière OK <input type="checkbox"/> Not OK/PasOK <input type="checkbox"/>
--	---	--

(2) CONNECTIONS CHECK / VERIFICATIONS DE RACCORDEMENTS

Phase check/ Vérification des Phases Yes / Oui <input type="checkbox"/> No / Non <input type="checkbox"/>	Voltage between Phases Tension entre Phases	1 / 2	2 / 3	1 / 3
--	--	----------------	----------------	----------------

(3) CLIMATIC CONFIGURATION CHECK / VERIFIER LA CONFIGURATION CLIMATIC

CLIMATIC 50 Configured according to the Options and Specifications / CLIMATIC 50 configuré en fonction des options et des spécifications: Yes/Oui <input type="checkbox"/> No/ Non <input type="checkbox"/>
--

(4) SUPPLY BLOWER SECTION / VENTILATION TRAITEMENT

Type / Type:		N°1	N°2
Power displayed on plate / Puissance affichée sur la plaque:	KW
Voltage displayed on plate / Tension affichée sur la plaque:	V
Current displayed on plate / Intensité affichée sur la plaque:	A
Fan Type / Type de Ventilateur:		Forward / Action <input type="checkbox"/>	Forward / Action <input type="checkbox"/>
		Backward / Réaction <input type="checkbox"/>	Backward / Réaction <input type="checkbox"/>
Displayed Belt Length / Longueur Courroie affichée:	mm
Tension Checked/ Tension Vérifiée:		Yes/Oui <input type="checkbox"/> No/ Non <input type="checkbox"/>	Yes/Oui <input type="checkbox"/> No/ Non <input type="checkbox"/>
Alignment Checked / Alignement Vérifié:		Yes/Oui <input type="checkbox"/> No/ Non <input type="checkbox"/>	Yes/Oui <input type="checkbox"/> No/ Non <input type="checkbox"/>
Motor Pulley Dia/ Poulie Moteur Dia: D _M	mm
Fan Pulley Dia/ Poulie Ventilateur Dia: D _P	mm
Fan Speed / Vitesse rotation Ventilateur = Motor rpm x D _M / D _P	rpm
Averaged Measured Amps / Intensité Mesurée moyenne:	A
Shaft Mechanical Power (Refer to airflow balancing) Puissance Mécanique à l'Arbre (Voir section réglage débit)	W
Operating point checked / Vérif. Point de fonctionnement:		Yes/Oui <input type="checkbox"/> No/ Non <input type="checkbox"/>	Yes/Oui <input type="checkbox"/> No/ Non <input type="checkbox"/>
Estimated Airflow / Estimation Débit d'Air	m ³ /h

(5) AIRFLOW PRESS. SENSOR CHECK / VERIF. DES SECURITES PRESSOSTATS D'AIR

Measured pressure drop / Pertes de charge au pressostat mbar	Set Points Adjusted / Changement des consignes: Yes/Oui <input type="checkbox"/> No/ Non <input type="checkbox"/> If Yes enter new values/ Si oui noter les nouvelles consignes: 3410: 3411: 3412:
---	--

(6) EXTERNAL SENSOR CHECKS / VERIFICATION DES CAPTEURS EXTERNES

Check electrical connections / Vérification des connections électriques: Yes/Oui <input type="checkbox"/> No/ Non <input type="checkbox"/>	Check and record temp. in menu 2110 / Vérifier et mesurer les températures. Dans menu 2110 : Yes/Oui <input type="checkbox"/> No/ Non <input type="checkbox"/>	
	100% Fresh Air / 100% Air neuf	100% return Air / 100% Air repris
Supply Temperature / Température Soufflage°C°C
Return Temperature / Température reprise°C°C
Outdoor Temperature / Température extérieure°C°C

(7) MIXING AIR DAMPERS CHECKS / VERIFICATIONS VOILETS DE MELANGE

Dampers open & close freely/ Volets s'ouvrent et se ferment OK Yes/Oui <input type="checkbox"/> No/ Non <input type="checkbox"/>	% Minimum FA: %minimum Air Neuf:%	Power exhaust checked/ Ventilateur extraction Yes/Oui <input type="checkbox"/> No/ Non <input type="checkbox"/>	Enthalpy sensor(s) checked/ Control enthalpie installé Yes/Oui <input type="checkbox"/> No/ Non <input type="checkbox"/>
--	---	---	--



(8) REFRIGERATION SECTION / SECTION REFRIGERATION

Outdoor Fan Motor Current / Intensité Moteurs Batterie externe:				Check Rotation		Compressor Voltage/ Tension Compresseur.	
Motor 1 / Moteur 1	L1A	L2A	L3A	Yes/Oui <input type="checkbox"/>	No/ Non <input type="checkbox"/>	Comp1: V	
Motor 2 / Moteur 2	L1A	L2A	L3A	Yes/Oui <input type="checkbox"/>	No/ Non <input type="checkbox"/>	Comp2: V	
Motor 3 / Moteur 3	L1A	L2A	L3A	Yes/Oui <input type="checkbox"/>	No/ Non <input type="checkbox"/>	Comp3: V	
Motor 4 / Moteur 4	L1A	L2A	L3A	Yes/Oui <input type="checkbox"/>	No/ Non <input type="checkbox"/>	Comp4: V	
Compressor Amps COOLING / Intensité Compresseur MODE FROID				Pressures & Temperatures / Pressions & températures			
	Phase 1	Phase 2	Phase 3	Temperatures / Temperatures		Pressures / Pressions	
				Suction/ Asp	Disch / refoul	LP/ BP	HP / HP
Comp 1 A A A °C °C Bar Bar
Comp 2 A A A °C °C Bar Bar
Comp 3 A A A °C °C Bar Bar
Comp 4 A A A °C °C Bar Bar
Check Reversing valves./ Vérifier vannes d'inversion:		Valve1/Vanne1: Yes/Oui <input type="checkbox"/> No/ Non <input type="checkbox"/>		Valve3/Vanne3: Yes/Oui <input type="checkbox"/> No/ Non <input type="checkbox"/>		Valve4/Vanne4: Yes/Oui <input type="checkbox"/> No/ Non <input type="checkbox"/>	
		Valve2/Vanne2: Yes/Oui <input type="checkbox"/> No/ Non <input type="checkbox"/>					
Compressor Amps HEATING / Intensité Compresseur en Pompe à Chaleur				Pressures & Temperatures / Pressions & températures			
	Phase 1	Phase 2	Phase 3	Temperatures / Temperatures		Pressures / Pressions	
				Suction/ Asp	Disch / refoul	LP/ BP	HP / HP
Comp 1 A A A °C °C Bar Bar
Comp 2 A A A °C °C Bar Bar
Comp 3 A A A °C °C Bar Bar
Comp 4 A A A °C °C Bar Bar
HP cut out / Coupure HP				LP cut out / Coupure sécurité BP			
Refrigerant charge / Charge réfrigérant				C1 :kg	C2 :kg	C3 :kg	C4 :kg

(9) ELECTRIC HEATER SECTION / SECTION RECHAUFFEUR ELECTRIQUE

Type / Type:	Serial No/ No Série:.....
AMPS 1 st stage (Baltic) / Intensité 1 ^{er} étage (Baltic)	AMPS 2 nd stage (Baltic) / Intensité 2 ^e étage (Baltic)
1	2
2	3
3	1
1	2
2	3

(10) HOT WATER COIL SECTION / SECTION BATTERIE EAU CHAUDE

Check Three Way Valve Movement / Vérification Mouvement Vanne trois voies: Yes/Oui No/ Non

(11) GAS HEATING SECTION / RAMPE GAZ

Gas Burner N°1 / Brûleur gaz N°1				Gas Burner N°2 / Brûleur gaz N°2			
Size / Taille:		Valve type / Type vanne:		Size / Taille:		Valve type / Type vanne:	
Pipe size/ tuyauterie:		Gas type / Type gas : G		Pipe size/ tuyauterie		Gas type / Type gas : G	
Line press./ press. ligne :		Drop test / test pression Yes/Oui <input type="checkbox"/> No/ Non <input type="checkbox"/>		line press./ press. ligne :		Drop test / test pression Yes/Oui <input type="checkbox"/> No/ Non <input type="checkbox"/>	
Check manifold pressure/ Pression injection: High fire/Grande allure.....Low fire/Petite allure.....				Check manifold pressure/ Pression injection: High fire/Grande allure..... Low fire/Petite allure.....			
Pressure cut out airflow press switch / Pression coupure pressostat débit d'air :mbar /Pa				Pressure cut out airflow press switch / Pression coupure pressostat débit d'air :mbar /Pa			
Motor amps l moteur:	Flue temp / temp fumées	CO2 %:	CO ppm:	Motor Amps l Moteur:	Flue temp / temp fumées	CO2 %:	CO ppm:
.....A °C%%A °C%%

(12) REMOTE CONTROL BMS CHECK / VERIFICATIONS BMS CONTROL A DISTANCE

Type / Type:	Sensor type / Type Capteur:	KP07 KP/17 checked/ vérifiées: Yes/Oui <input type="checkbox"/> No/ Non <input type="checkbox"/>	Interconnect wiring checked: Yes/Oui <input type="checkbox"/> No/ Non <input type="checkbox"/>
--------------	-----------------------------	--	--

Comments.....



BELT TENSION

On delivery, the drive belts are new and correctly tensioned. After the first 50 operating hours check and adjust the tension. 80% of the total elongation of belts is generally produced during the first 15 hours of operation.

Before adjusting the tension, make sure that the pulleys are correctly aligned. To tension the belt, set the height of motor support plate by moving the plate adjustment screws.

This recommended deflection is 16 mm per metre from centre to centre.

Check that according to the diagram below (figure 18), the following ratio remains the same.

$$\frac{P \text{ (mm)}}{A \text{ (m)}} = 20$$



Figure 17

The belts should always be replaced when :

- the disk is set to maximum,
- the belt rubber is worn or the wire is visible.

Replacement belts must have the same rated size as the ones they are replacing. If a transmission system has several belts, they must all be from the same manufacturing batch (compare serial numbers).

NOTE :

An under-tensioned belt will slip, heat and wear prematurely. On the other hand, if a belt is over-tensioned, the pressure on the bearings will cause them to over-heat and wear prematurely. Incorrect alignment will also cause the belts to wear prematurely.

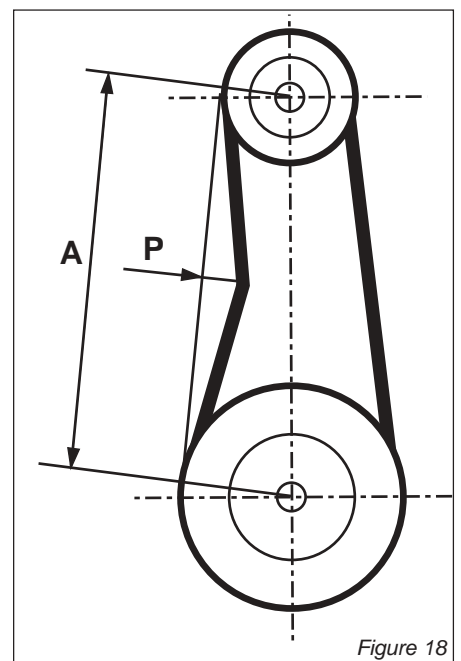

Figure 18



MOUNTING AND ADJUSTING PULLEYS

Fan pulley removal

Remove the 2 screws and put one of them in the extraction threaded screw.

Screw in fully. The hub and the pulley will separate from each other.

Remove the hub and the pulley by hand without damaging the machine.

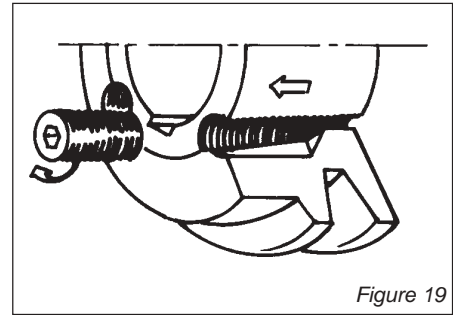

Figure 19

Fan pulley installation

Clean and de-grease the shaft, hub and conical bore of the pulley. Lubricate the screws and install the hub and pulley. Position the screws without turning them.

Place the assembly on the shaft and screw in the screws alternatively and evenly. Using a mallet or a hammer with a wooden wedge, tap on the face of the hub to keep the assembly in place. Torque the screws to 30 Nm.

Take the pulley in both hands and shake it vigorously to make sure everything is in place. Fill the holes with grease for protection.

NOTE : During installation, the key should never protrude out of its groove. After 50 operating hours, check that the screws are still in place.

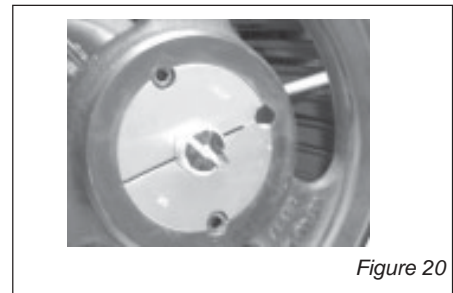

Figure 20

Motor pulley installation and removal

The pulley is held in position by the key and a screw located in the groove. After unlocking, removing this screw by pulling against the shaft spindle (if necessary, use a mallet and tap uniformly on the hub to remove it).

To assemble, proceed in the reverse order after having cleaned and de-greased the motor shaft and the pulley bore.

Pulleys alignment

After adjusting one or both of the pulleys, check the transmission alignment using a ruler placed on the inner face of the two pulleys.

NOTE : The warranty may be affected if any major modification is made to the transmission without obtaining our agreement beforehand.

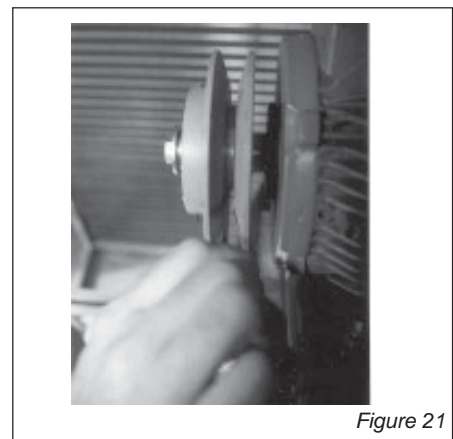

Figure 21



The actual resistance of ductwork systems is not always identical to the calculated theoretical values. To rectify this, it may be necessary to modify the pulley and belt setting. To this effect, the motors are fitted with variable pulleys.

Measure the absorbed amps

If the absorbed amps are greater than the rated values, the ventilation system has a lower pressure drop than anticipated. Reduce the flow by reducing the rpm. If the system resistance is significantly lower than design, there is a risk that the motor will overheat resulting in an emergency cut out.

If the absorbed amps are lower than the rated values, your system has a higher pressure drop than anticipated. Increase the flow by increasing the rpm. At the same time you will increase the absorbed power which may result in having to increase the motor size.

To carry out the adjustment and to avoid a time-consuming re-start, stop the machine and if necessary lock the main switch. First unscrew the 4 Allen screw(s) on the pulley (see figure 23).

Pulley type	Pulley external Ø	Min Ø / Min dist.	Max Ø / Max dist.	nr of turns from fully closed to fully open	Actual Ø (DM) or distance between faces for a given number of turns from fully closed with SPA belt in (mm)										
					0,5	1	1,5	2	2,5	3	3,5	4	4,5	5,0	5,5
8450 / D8450	120	95	116	5	113,9	111,8	109,7	107,6	105,5	103,4	101,3	99,2	97,1	95,0	-
		20,2	28,0	5	21,0	21,8	22,5	23,3	24,1	24,9	25,7	26,4	27,2	28,0	-
8550 / D8550	136	110	131	5	128,9	126,8	124,7	122,6	120,5	118,4	116,3	114,2	112,1	110,0	-
		20,6	31,2	5	21,6	22,7	23,8	24,8	25,9	26,9	28,0	29,1	30,1	31,2	-
8670 / D8670	171	145	166	5	163,9	161,8	159,7	157,6	155,5	153,4	151,3	149,2	147,1	145,0	-
		20,5	31,1	5	21,5	22,7	23,8	24,8	25,7	26,9	27,9	29,0	30,0	31,1	-

The easiest way to determine the fan rotation speed is to use a tachometer. If not available the fan rpm can be estimated using the following two methods.

1st Method with the pulley secured in place :

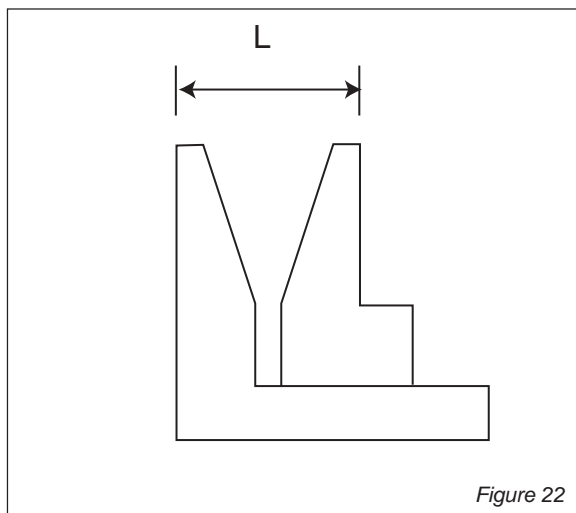

Figure 22

Measure the distance between the two outside faces of the pulley.

Using table 1 the motor pulley actual diameter can be estimated

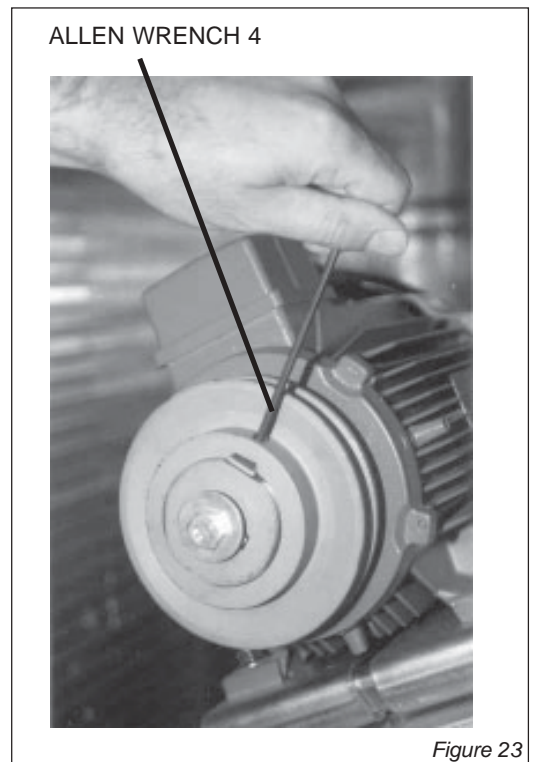

Figure 23



2nd method when adjusting the pulley :

- Close the pulley fully and count the number of turns from fully closed position. Using table 1 determine the motor pulley actual diameter.
- Record the fix fan pulley diameter.(DF)
- Determine the fan speed using the following formula:

$$\text{rpm FAN} = \text{rpm MOTOR} \times D_M / D_F$$

Where :

rpm MOTOR : from the motor plate or table 2

D_M : from table 1

D_F : from machine

Once the pulleys are adjusted and the belt checked and tensioned, start the fan motor and record the Amps and Voltage between the phases :

Using the measured data and table 2

- Theoretical mechanical power at the fan shaft :

$$P_{\text{meca fan}} = P_{\text{meca Motor}} \times \eta_{\text{Transmission}}$$

$$P_{\text{meca fan}} = P_{\text{elec}} \times \eta_{\text{meca motor}} \times \eta_{\text{Transmission}}$$

$$P_{\text{meca fan}} = V \times I \times \sqrt{3} \times \cos\phi \times \eta_{\text{meca motor}} \times \eta_{\text{Transmission}}$$

This formula can be approximated in this way

$$P_{\text{meca fan}} = V \times I \times 1.73 \times 0.85 \times 0.76 \times 0.9$$

With the fan "rpm" and the mechanical power at the fan shaft an operating point and the supplied airflow can be estimated using the fan curves.

CHECKING AIRFLOW AND ESP

Using the fan curves on page 25, 26, 27, the airflow, the total pressure available (P_{TOT}) and the corresponding dynamic pressure (Pd) can now be estimated, for a specific operating point;

The next step consist in estimating the pressure losses across the unit.

This can be achieved using the "dirty filter pressure sensor" and the accessories pressure drop table:

Also the pressure drop due to the duct inlet into the roof-top unit can be taken as 20 to 30 Pa.

$$\Delta P_{\text{INT}} = \Delta P_{\text{filter}} + \text{coil} + P_{\text{Inlet}} + \Delta P_{\text{Options}}$$

using the results from above, the external static pressure (ESP) can then be estimated:

$$\text{ESP} = P_{\text{TOT}} - P_d - \Delta P_{\text{INT}}$$

Table 2

Motor Size	Nom, Speed	Cos	meca motor
0,75 kW	1400 rpm	0,77	0,70
1,1 kW	1425 rpm	0,82	0,77
1,5 kW	1430 rpm	0,81	0,75
2,2 kW	1430 rpm	0,81	0,76
3,0 kW	1425 rpm	0,78	0,77
4 kW	1425 rpm	0,79	0,80
5,5 kW	1430 rpm	0,82	0,82

Table 5.52

SIZE	Air flow (m³/h)	Economiser 100% open (Pa)	EU7 Filter (Pa)	Hot water coil		Electric heater		Roofcurb Base frame (Pa)	Horizontal Roofcurb (Pa)	Gaz H (Pa)
				S (Pa)	H (Pa)	S (Pa)	H (Pa)			
60	Min. 10 000	4	67	12	14	5	8	10	41	22
	Nom. 12 000	6	93	16	19	8	8	11	59	26
	Max. 15 000	9	135	24	28	8	10	13	92	31
70	Min. 12 000	6	56	6	12	5	5	13	59	29
	Nom. 14 000	8	73	8	16	5	5	16	80	34
	Max. 18 000	12	113	13	25	8	8	22	132	47
85	Min. 14 000	8	73	8	16	5	8	18	44	7
	Nom. 16 000	10	113	13	25	8	8	26	57	10
	Max. 22 000	16	159	18	36	8	10	32	109	12
100	Min. 16 000	10	93	10	20	8	10	26	57	10
	Nom. 20 000	14	135	15	30	10	13	32	90	12
	Max. 22 000	16	159	18	36	13	15	38	109	15
120	Min. 18 000	12	113	13	25	10	13	32	33	29
	Nom. 22 000	16	159	18	36	13	15	38	49	35
	Max. 24 000	18	184	21	41	15	18	44	58	40
140	Min. 20 000	14	135	15	30	10	15	35	40	31
	Nom. 24 000	18	184	21	41	15	18	46	58	40
	Max. 25 000	19	197	22	44	15	20	50	63	43
160	Min. 22 000	16	87	9	18	8	8	24	49	45
	Nom. 28 000	22	132	13	27	8	10	30	79	56
	Max. 32 000	26	165	17	34	13	13	34	103	64
190	Min. 24 000	18	101	10	20	10	10	34	58	64
	Nom. 33 000	27	174	18	36	13	13	41	109	77
	Max. 36 000	30	201	21	41	13	15	48	130	89



EXAMPLE

The unit used for this example is a **FHK 060N** with standard supply and return airflow configuration. It is also fitted with an economiser and an electric heater type H.

It is fitted with a **AT 18-18** fan which curve is shown on page xxx and a 2.2 kW motor.

- Motor rpm : 1430 rpm
- $\cos \varphi = 0.81$
- Voltage = 400 V
- Current = 4,68A

$$P_{\text{mech fan}} = V \times I \times \sqrt{3} \times \cos \varphi \times \eta_{\text{mech motor}} \times \eta_{\text{Transmission}}$$

$$= 400 \times 4.68 \times \sqrt{3} \times 0.81 \times 0.76 \times 0.9 = \underline{1,79 \text{ kW}}$$

The unit is also fitted with a transmission kit 1

- Fixed Fan pulley : 250 mm
- Motor adjustable pulley type "8450" opened 1 turn from fully closed or measured distance between pulley end plates is 21,8 mm: from table xxx it can be determined that the motor pulley has a diameter of 111,8 mm

$$\text{rpm}_{\text{FAN}} = \text{rpm}_{\text{MOTOR}} \times D_M / D_F = 1430 \times 118,2 / 250 = \underline{640 \text{ rpm}}$$

Using the fan curve below the operating point can be located.

It can be determined that the fan is providing approximately **12 000 m³/h** with a total pressure $P^{\text{TOT}} = \underline{420 \text{ Pa}}$

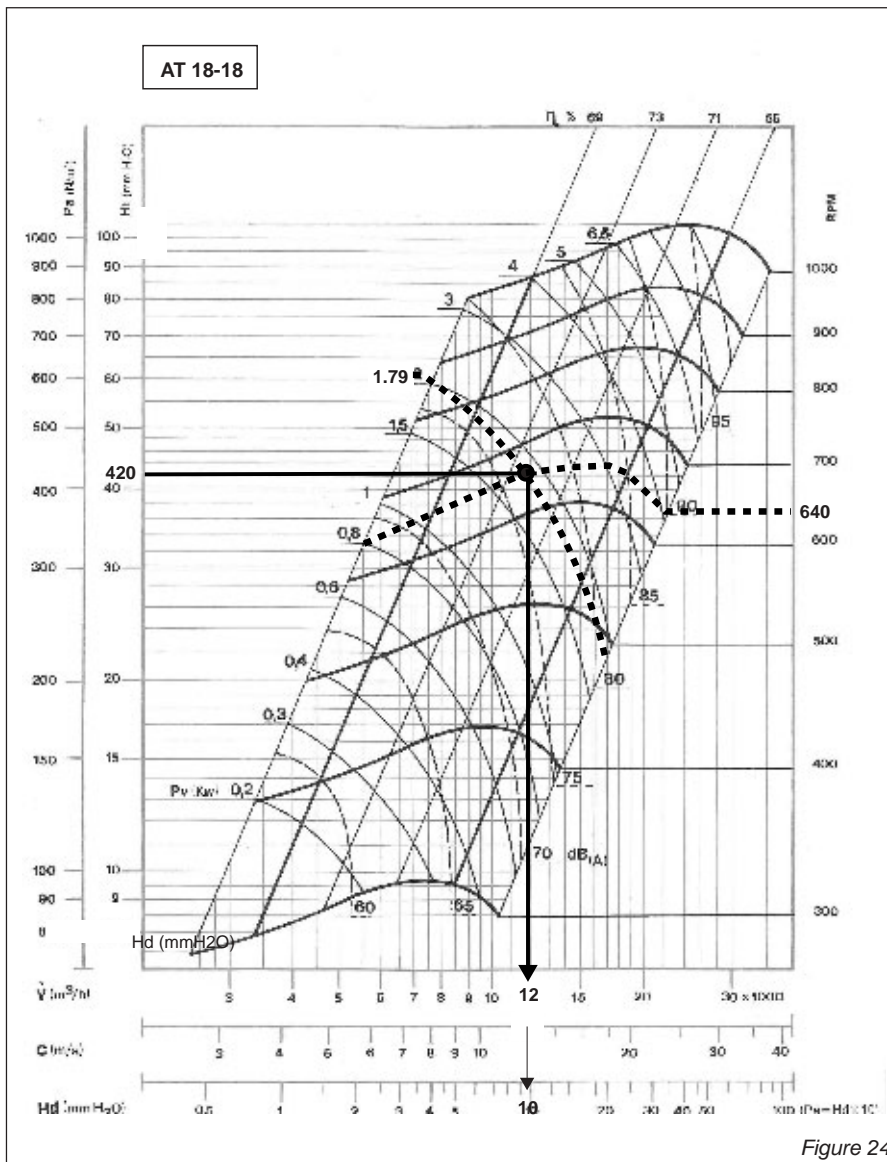

Figure 24

The pressure losses in the unit are the sum of all pressure drops across the different parts of a unit :

- Coil and filter (measured) = 105 Pa
- Options = 6 Pa for economiser and 8 Pa for electric heater H

$$\Delta P = 105 + 6 + 8 = \underline{119 \text{ Pa}}$$

The dynamic pressure at 1200m³/h is given at the bottom of the fan curve

$$P_d = \underline{100 \text{ Pa}}$$

The external static pressure available is therefore

$$\text{ESP} = P_{\text{TOT}} - P_d - \Delta P_{\text{INT}}$$

$$= 420 - 100 - 119 = \underline{201 \text{ Pa}}$$



KIT NR	FAN TYPE		CURVE PICTURE ON PAGE
	SINGLE	TWIN	
FC/FH/FD... 060 - Standard			
K1	AT 18-18 S	-	34
K2	AT 18-18 S	-	34
K3	AT 18-18 S	-	34
K4	AT 18-18 S	-	34
K5	AT 18-18 S	-	34
K6	AT 18-18 S	-	34
K7	AT 18-18 S	-	34
K8	AT 18-18 S	-	34
K9	AT 18-18 S	-	34
K10	AT 18-18 S	-	34
K11	AT 18-18 S	-	34
K12	AT 18-18 S	-	34
K13	AT 18-18 S	-	34
FC/FH/FD... 070 - Standard			
K1	AT 18-18 S	-	34
K2	AT 18-18 S	-	34
K3	AT 18-18 S	-	34
K4	AT 18-18 S	-	34
K5	AT 18-18 S	-	34
K6	AT 18-18 S	-	34
K7	AT 18-18 S	-	34
K8	AT 18-18 S	-	34
K9	AT 18-18 S	-	34
K10	AT 18-18 S	-	34
FC/FH/FD... 085 - Standard			
K1	AT 15-15 G2L	-	32
K2	AT 15-15 G2L	-	32
K3	AT 15-15 G2L	-	32
K4	AT 15-15 G2L	-	32
K5	AT 15-15 G2L	-	32
K6	AT 15-15 G2L	-	32
K7	AT 15-15 G2L	-	32
K8	AT 15-15 G2L	-	32
K9	-	AT 15-15 S	32
K10	AT 15-15 G2L	-	32
K11	-	AT 15-15 S	32
K12	AT 15-15 G2L	-	32
K13	-	AT 15-15 S	32
FC/FH/FD... 100 - Standard			
K1	AT 15-15 G2L	-	32
K2	AT 15-15 G2L	-	32
K3	AT 15-15 G2L	-	32
K4	AT 15-15 G2L	-	32
K5	AT 15-15 G2L	-	32
K6	-	AT 15-15 S	32
K7	AT 15-15 G2L	-	32
K8	-	AT 15-15 S	32
K9	AT 15-15 G2L	-	32

KIT NR	FAN TYPE		CURVE PICTURE ON PAGE
	SINGLE	TWIN	
FC/FH/FD... 120 - Standard			
K1	-	AT 18-18 S	34
K2	-	AT 18-18 S	34
K3	-	AT 18-18 S	34
K4	-	AT 18-18 S	34
K5	-	AT 18-18 S	34
K6	-	AT 18-18 S	34
K7	-	AT 18-18 S	34
K8	-	AT 18-18 S	34
K9	-	AT 18-18 S	34
FC/FH/FD... 140 - Standard			
K1	-	AT 18-18 S	34
K2	-	AT 18-18 S	34
K3	-	AT 18-18 S	34
K4	-	AT 18-18 S	34
K5	-	AT 18-18 S	34
K6	-	AT 18-18 S	34
K7	-	AT 18-18 S	34
K8	-	AT 18-18 S	34
K9	-	AT 18-18 S	34
FC/FH/FD... 160 - Standard			
K1	-	AT 18-18 S	34
K2	-	AT 18-18 S	34
K3	-	AT 18-18 S	34
K4	-	AT 18-18 S	34
K5	-	AT 18-18 S	34
K6	-	AT 18-18 S	34
K7	-	AT 18-18 S	34
K8	-	AT 18-18 S	34
K9	-	AT 18-18 S	34
K10	-	AT 18-18 S	34
FC/FH/FD... 190 - Standard			
K1	-	AT 18-18 S	34
K2	-	AT 18-18 S	34
K3	-	AT 18-18 S	34
K4	-	AT 18-18 S	34
K5	-	AT 18-18 S	34
K6	-	AT 18-18 S	34
K7	-	AT 18-18 S	34
K8	-	AT 18-18 S	34
K9	-	AT 18-18 S	34
K10	-	AT 18-18 S	34



KIT NR	FAN TYPE		CURVE PICTURE ON PAGE
	SINGLE	TWIN	
FC/FH/FD... 085 - Side discharge			
K14	-	AT 15-15 S	32
K15	-	AT 15-15 S	32
K16	-	AT 15-15 S	32
K17	-	AT 15-15 S	32
K18	-	AT 15-15 S	32
K19	-	AT 15-15 S	32
K20	-	AT 15-15 S	32
K21	-	AT 15-15 S	32
FC/FH/FD... 100 - Side discharge			
K10	-	AT 15-15 S	32
K11	-	AT 15-15 S	32
K12	-	AT 15-15 S	32
K13	-	AT 15-15 S	32
K14	-	AT 15-15 S	32
K15	-	AT 15-15 S	32
K16	-	AT 15-15 S	32
K17	-	AT 15-15 S	32
K18	-	AT 15-15 S	32
K19	-	AT 15-15 S	32
FC/FH/FD... 120 - Side discharge			
K10	-	AT 18-13 S	33
K11	-	AT 18-13 S	33
K12	-	AT 18-13 S	33
K13	-	AT 18-13 S	33
K14	-	AT 18-13 S	33
K15	-	AT 18-13 S	33
K16	-	AT 18-13 S	33
K17	-	AT 18-13 S	33
K18	-	AT 18-13 S	33
FC/FH/FD... 140 - Side discharge			
K10	-	AT 18-13 S	33
K11	-	AT 18-13 S	33
K12	-	AT 18-13 S	33
K13	-	AT 18-13 S	33
K14	-	AT 18-13 S	33
K15	-	AT 18-13 S	33
K16	-	AT 18-13 S	33
K17	-	AT 18-13 S	33



KIT NR	FAN TYPE		CURVE PICTURE ON PAGE
	SINGLE	TWIN	
FG... 060 - Gas			
K1	-	AT 15-15 S	32
K2	-	AT 15-15 S	32
K3	-	AT 15-15 S	32
K4	-	AT 15-15 S	32
K5	-	AT 15-15 S	32
K6	-	AT 15-15 S	32
K7	-	AT 15-15 S	32
K8	-	AT 15-15 S	32
K9	-	AT 15-15 S	32
K10	-	AT 15-15 S	32
FG... 070 - Gas			
K1	-	AT 15-15 S	32
K2	-	AT 15-15 S	32
K3	-	AT 15-15 S	32
K4	-	AT 15-15 S	32
K5	-	AT 15-15 S	32
K6	-	AT 15-15 S	32
K7	-	AT 15-15 S	32
K8	-	AT 15-15 S	32
K9	-	AT 15-15 S	32
K10	-	AT 15-15 S	32
K11	-	AT 15-15 S	32
FG... 085 - Gas			
K1	-	AT 15-15 S	32
K2	-	AT 15-15 S	32
K3	-	AT 15-15 S	32
K4	-	AT 15-15 S	32
K5	-	ADN 325L	36
K6	-	AT 15-15 S	32
K7	-	ADN 325L	36
K8	-	AT 15-15 S	32
K9	-	AT 15-15 S	32
K10	-	ADN 325L	36
K11	-	ADN 325L	36
FG... 100 - Gas			
K1	-	AT 15-15 S	32
K2	-	AT 15-15 S	32
K3	-	AT 15-15 S	32
K4	-	AT 15-15 S	32
K5	-	ADN 325L	36
K6	-	AT 15-15 S	32
K7	-	AT 15-15 S	32
K8	-	ADN 325L	36
K9	-	AT 15-15 S	32
K10	-	ADN 325L	36

KIT NR	FAN TYPE		CURVE PICTURE ON PAGE
	SINGLE	TWIN	
FG... 120 - Gas			
K1	-	ADN 370L	37
K2	-	ADN 370L	37
K3	-	ADN 370L	37
K4	-	ADN 370L	37
K5	-	ADN 370L	37
K6	-	ADN 370L	37
K7	-	ADN 370L	37
K8	-	ADN 370L	37
FG... 137 - Gas			
K1	-	ADN 370 L	37
K2	-	ADN 370 L	37
K3	-	ADN 370 L	37
K4	-	ADN 370 L	37
K5	-	ADN 370 L	37
FG... 160 - Gas			
K1	-	ADN 450 L	38
K2	-	ADN 450 L	38
K3	-	ADN 450 L	38
K4	-	ADN 450 L	38
K5	-	ADN 450 L	38
K6	-	ADN 450 L	38
K7	-	ADN 450 L	38
K8	-	ADN 450 L	38
K9	-	ADN 450 L	38
K10	-	ADN 450 L	38
FG... 190 - Gas			
K1	-	ADN 450 L	38
K2	-	ADN 450 L	38
K3	-	ADN 450 L	38
K4	-	ADN 450 L	38
K5	-	ADN 450 L	38
K6	-	ADN 450 L	38
K7	-	ADN 450 L	38
K8	-	ADN 450 L	38
K9	-	ADN 450 L	38
K10	-	RDN 450 K	35

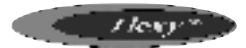

KIT NR	FAN TYPE		CURVE PICTURE ON PAGE
	SINGLE	TWIN	
FX... 025 Indoor			
K1	AT 12-12 S	-	31
K2	AT 12-12 S	-	31
K3	AT 12-12 S	-	31
K4	AT 12-12 S	-	31
K5	AT 12-12 S	-	31
K6	AT 12-12 S	-	31
K7	AT 12-12 S	-	31
K8	AT 12-12 S	-	31
K9	AT 12-12 S	-	31
K10	AT 12-12 S	-	31
FX.. 030 Indoor			
K1	AT 12-12 S	-	31
K2	AT 12-12 S	-	31
K3	AT 12-12 S	-	31
K4	AT 12-12 S	-	31
K5	AT 12-12 S	-	31
K6	AT 12-12 S	-	31
K7	AT 12-12 S	-	31
K8	AT 12-12 S	-	31
K9	AT 12-12 S	-	31
K10	AT 12-12 S	-	31
FX... 035 Indoor			
K1	AT 15-15 S	-	32
K2	AT 15-15 S	-	32
K3	AT 15-15 S	-	32
K4	AT 15-15 S	-	32
K5	AT 15-15 S	-	32
K6	AT 15-15 S	-	32
K7	AT 15-15 S	-	32
K8	AT 15-15 S	-	32
FX... 040 Indoor			
K1	AT 15-15 S	-	32
K2	AT 15-15 S	-	32
K3	AT 15-15 S	-	32
K4	AT 15-15 S	-	32
K5	AT 15-15 S	-	32
K6	AT 15-15 S	-	32
K7	AT 15-15 S	-	32
K8	AT 15-15 S	-	32
K9	AT 15-15 S	-	32
K10	AT 15-15 S	-	32
FX... 055 Indoor			
K1	AT 15-15 S	-	32
K2	AT 15-15 S	-	32
K3	AT 15-15 S	-	32
K4	AT 15-15 S	-	32
K5	AT 15-15 S	-	32
K6	AT 15-15 S	-	32
K7	AT 15-15 S	-	32
K8	AT 15-15 S	-	32
K9	AT 15-15 S	-	32
K10	AT 15-15 S	-	32

KIT NR	FAN TYPE		CURVE PICTURE ON PAGE
	SINGLE	TWIN	
FX... 070 Indoor			
K1	AT 18-18 S	-	34
K2	AT 18-18 S	-	34
K3	AT 18-18 S	-	34
K4	AT 18-18 S	-	34
K5	AT 18-18 S	-	34
K6	AT 18-18 S	-	34
K7	AT 18-18 S	-	34
K8	AT 18-18 S	-	34
K9	AT 18-18 S	-	34
K10	AT 18-18 S	-	34
K11	AT 18-18 S	-	34
FX... 085 Indoor			
K1	AT 18-18 S	-	34
K2	AT 18-18 S	-	34
K3	AT 18-18 S	-	34
K4	AT 18-18 S	-	34
K5	AT 18-18 S	-	34
K6	AT 18-18 S	-	34
K7	AT 18-18 S	-	34
K8	AT 18-18 S	-	34
K9	AT 18-18 S	-	34
FX... 0100 Indoor			
K1	AT 18-18 S	-	34
K2	AT 18-18 S	-	34
K3	AT 18-18 S	-	34
K4	AT 18-18 S	-	34
K5	AT 18-18 S	-	34
K6	AT 18-18 S	-	34
K7	AT 18-18 S	-	34
FX... 110 Indoor			
K1	-	AT 18-18 S	34
K2	-	AT 18-18 S	34
K3	-	AT 18-18 S	34
K4	-	AT 18-18 S	34
K5	-	AT 18-18 S	34
K6	-	AT 18-18 S	34
K7	-	AT 18-18 S	34
FX... 140 Indoor			
K1	-	AT 18-18 S	34
K2	-	AT 18-18 S	34
K3	-	AT 18-18 S	34
K4	-	AT 18-18 S	34
K5	-	AT 18-18 S	34
K6	-	AT 18-18 S	34
K7	-	AT 18-18 S	34
K8	-	AT 18-18 S	32
FX... 170 Indoor			
K1	-	AT 18-18 S	32
K2	-	AT 18-18 S	32
K3	-	AT 18-18 S	32
K4	-	AT 18-18 S	32
K5	-	AT 18-18 S	32
K6	-	AT 18-18 S	32
K7	-	AT 18-18 S	32



KIT NR	FAN TYPE		CURVE PICTURE ON PAGE
	SINGLE	TWIN	
FX... 025 Outdoor			
K1	AT 12-12 S	-	31
K2	AT 12-12 S	-	31
K3	AT 12-12 S	-	31
K4	AT 12-12 S	-	31
K5	AT 12-12 S	-	31
K6	AT 12-12 S	-	31
FX... 030 Outdoor			
K1	AT 12-12 S	-	31
K2	AT 12-12 S	-	31
K3	AT 12-12 S	-	31
K4	AT 12-12 S	-	31
K5	AT 12-12 S	-	31
FX... 035 Outdoor			
K1	AT 15-15 S	-	32
K2	AT 15-15 S	-	32
K3	AT 15-15 S	-	32
K4	AT 15-15 S	-	32
K5	AT 15-15 S	-	32
K6	AT 15-15 S	-	32
K7	AT 15-15 S	-	32
FX... 040 Outdoor			
K1	AT 15-15 S	-	32
K2	AT 15-15 S	-	32
K3	AT 15-15 S	-	32
K4	AT 15-15 S	-	32
K5	AT 15-15 S	-	32
K6	AT 15-15 S	-	32
K7	AT 15-15 S	-	32
FX... 055 Outdoor			
K1	AT 15-15 S	-	32
K2	AT 15-15 S	-	32
K3	AT 15-15 S	-	32
K4	AT 15-15 S	-	32
K5	AT 15-15 S	-	32
FX... 070 Outdoor			
K1	AT 18-18 S	-	34
K2	AT 18-18 S	-	34
K3	AT 18-18 S	-	34
K4	AT 18-18 S	-	34
K5	AT 18-18 S	-	34
K6	AT 18-18 S	-	34

KIT NR	FAN TYPE		CURVE PICTURE ON PAGE
	SINGLE	TWIN	
FX... 085 Outdoor			
K1	AT 18-18 S	-	37
K2	AT 18-18 S	-	37
K3	AT 18-18 S	-	37
K4	AT 18-18 S	-	37
K5	AT 18-18 S	-	37
FX... 100 Outdoor			
K1	-	AT 15-15 S	35
K2	-	AT 15-15 S	35
K3	-	AT 15-15 S	35
K4	-	AT 15-15 S	35
K5	-	AT 15-15 S	35
FX... 110 Outdoor			
K1	AT 18-18 S	-	37
K2	AT 18-18 S	-	37
K3	AT 18-18 S	-	37
K4	AT 18-18 S	-	37
K5	AT 18-18 S	-	37
K6	AT 18-18 S	-	37
FX... 140 Outdoor			
K1	AT 18-18 S	-	37
K2	AT 18-18 S	-	37
K3	AT 18-18 S	-	37
K4	AT 18-18 S	-	37
K5	AT 18-18 S	-	37
FX... 170 Outdoor			
K1	AT 18-18 S	-	37
K2	AT 18-18 S	-	37
K3	AT 18-18 S	-	37
K4	AT 18-18 S	-	37
K5	AT 18-18 S	-	37

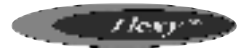

AT 12-12 FAN

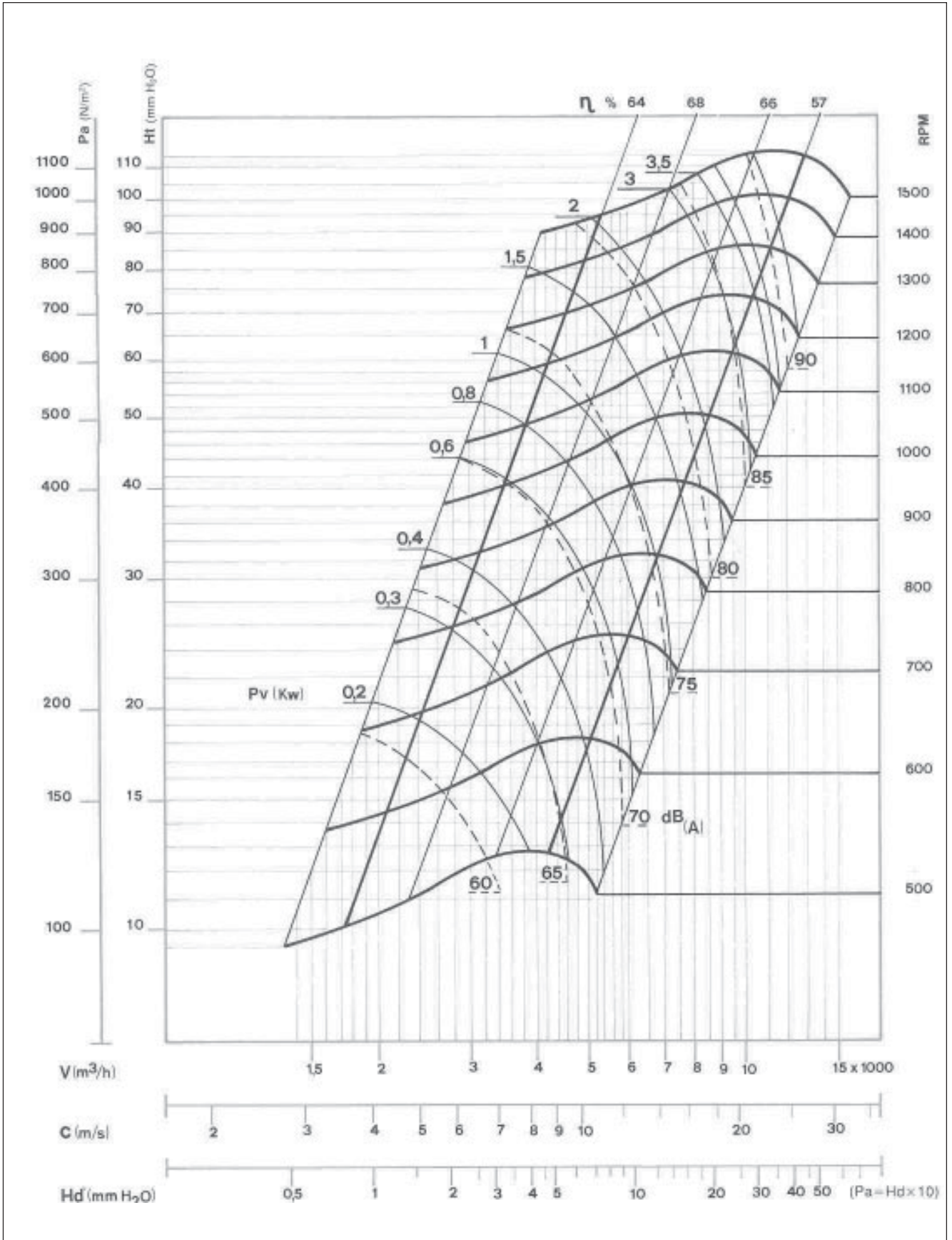



AT 15-15 FAN

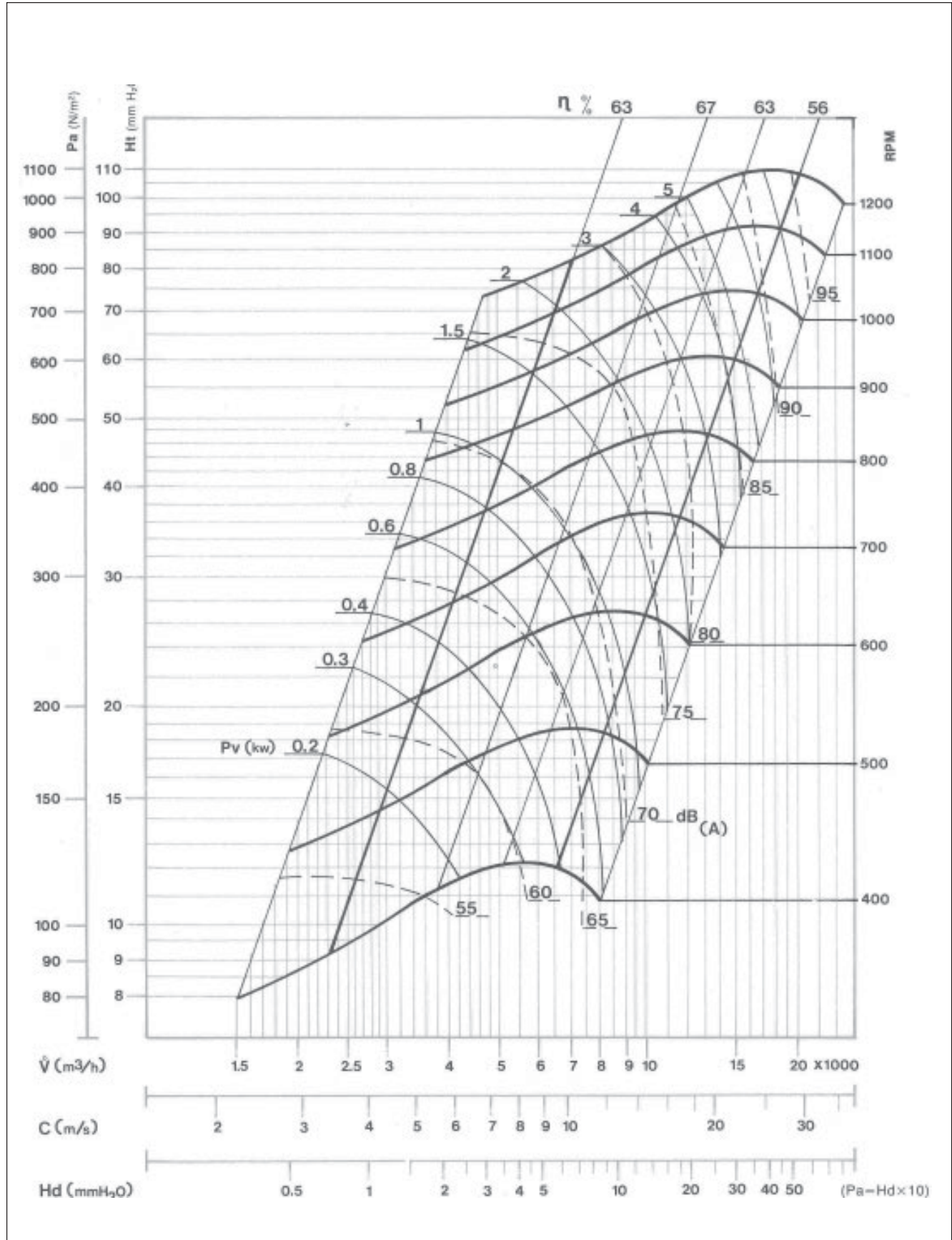

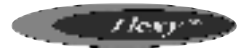

AT 18-13

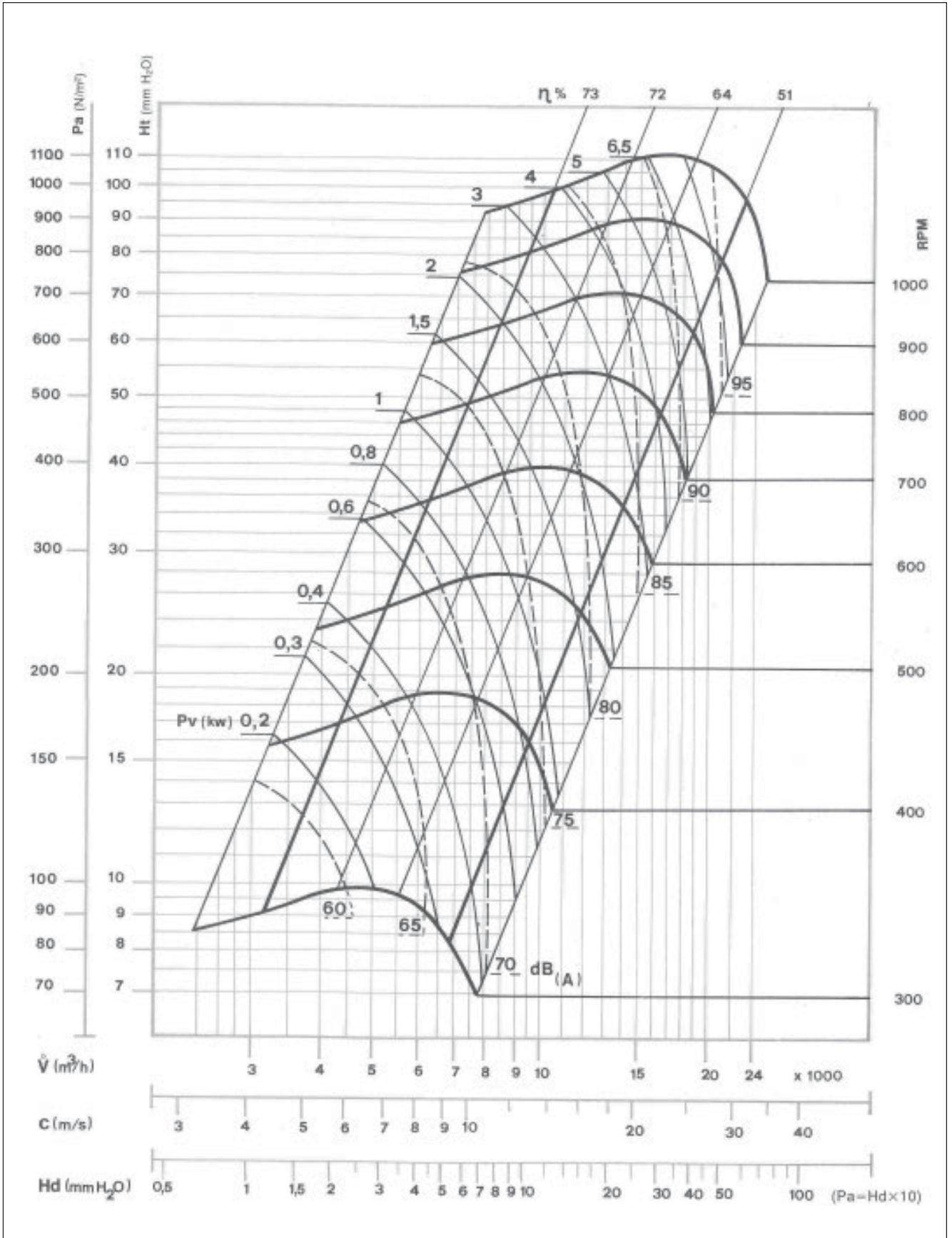



AT 18-18 FAN

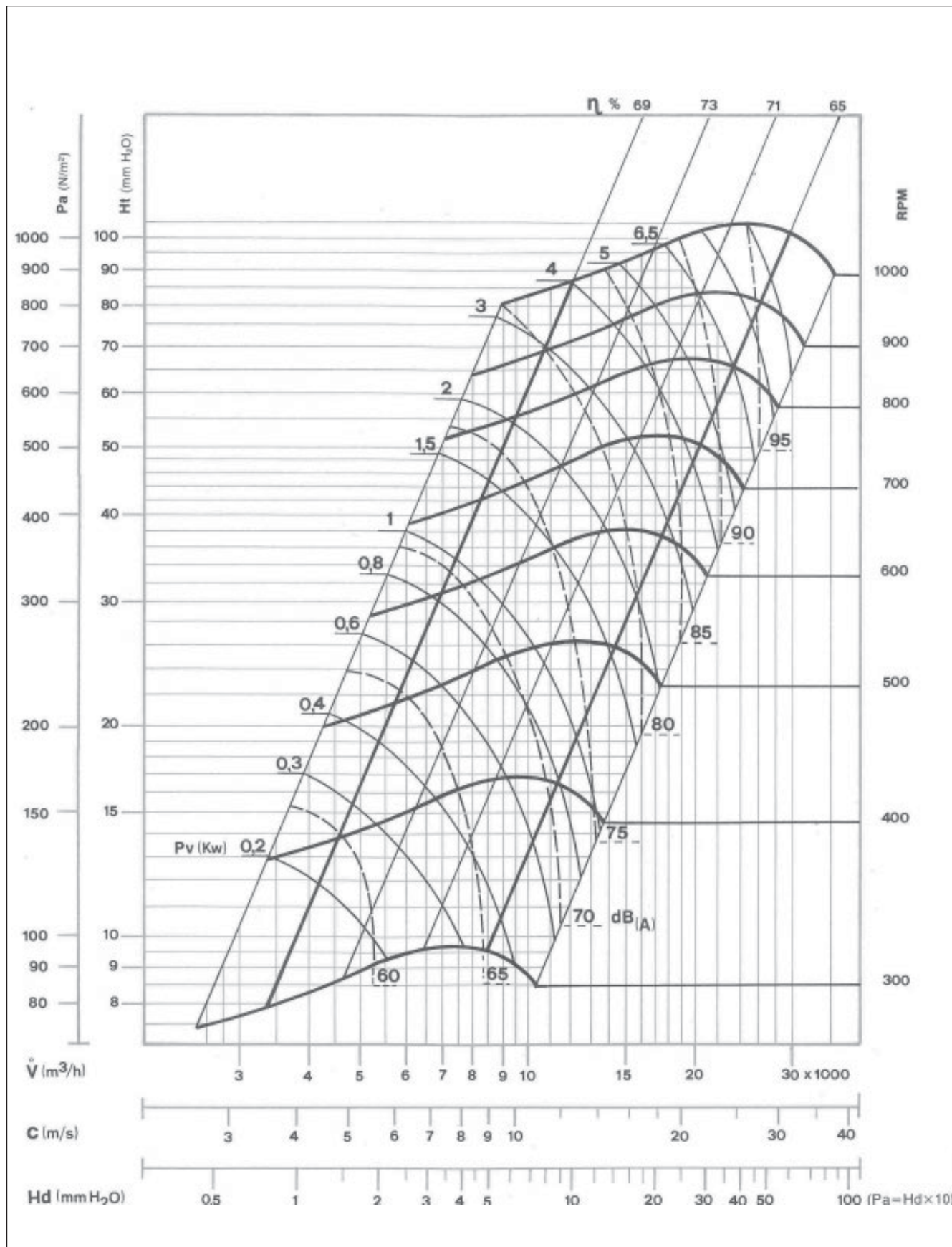



ADN 355 FAN

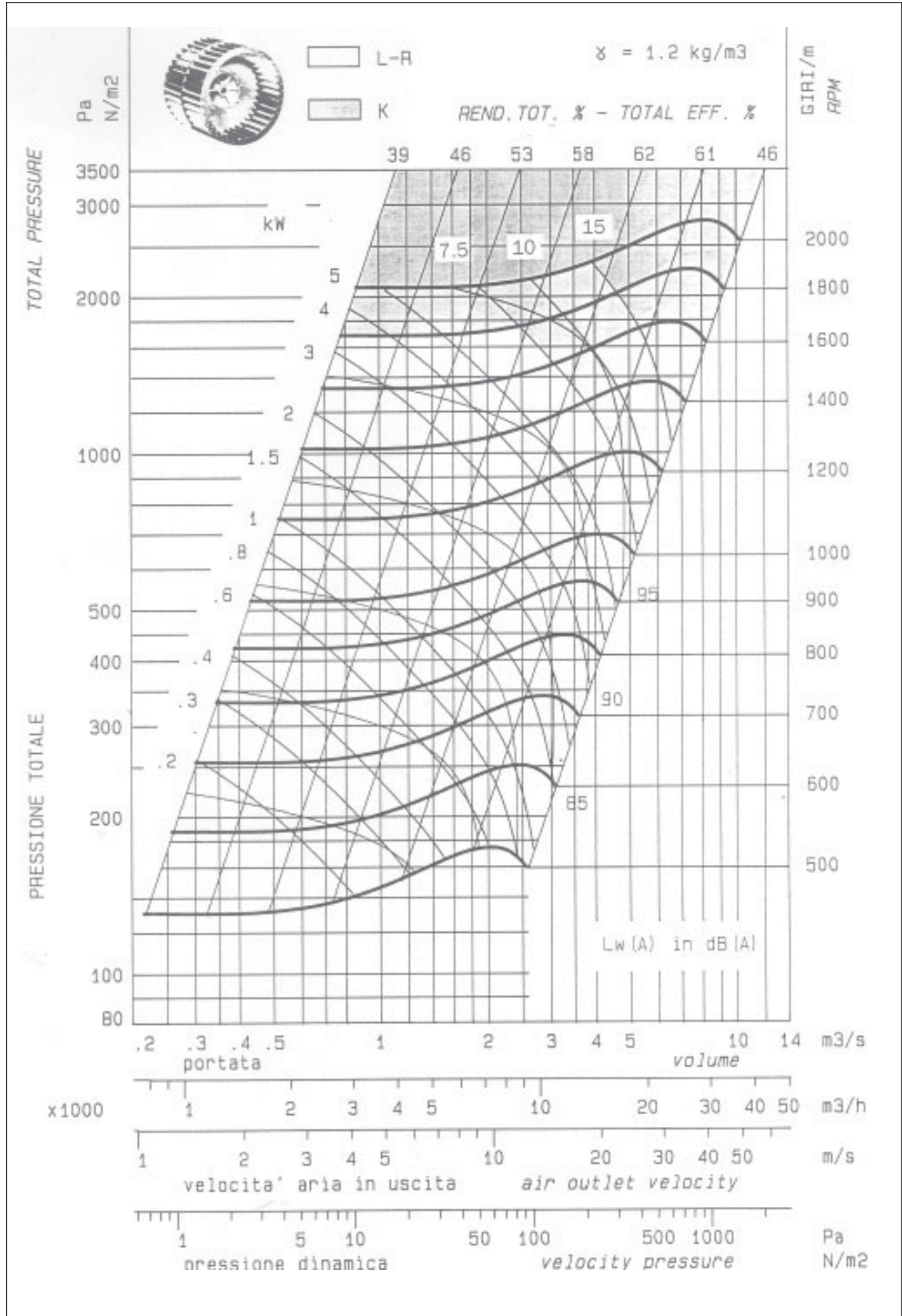



ADN 400 FAN

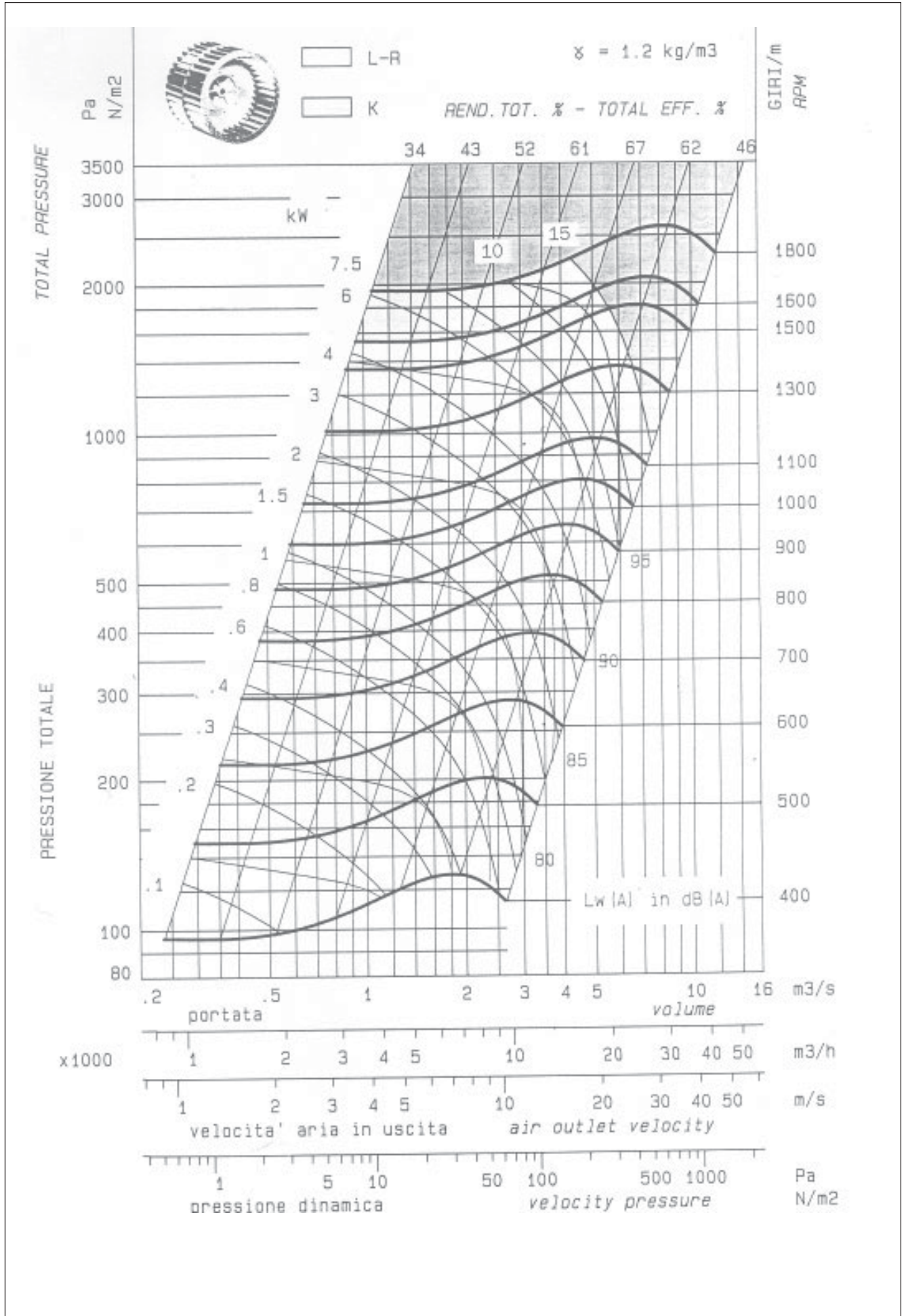



ADN 450 FAN

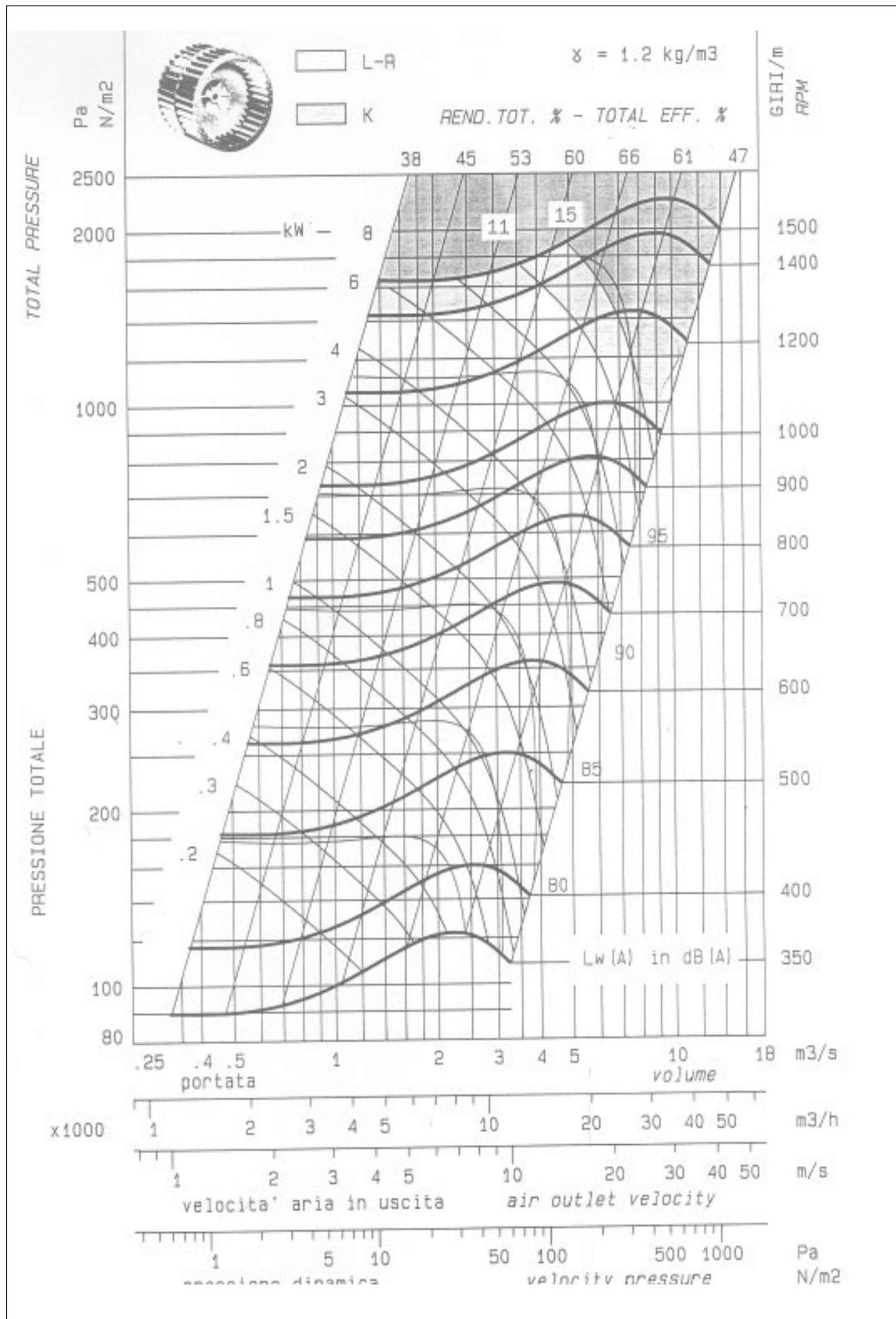



The CLIMATIC™ controls the filters. Two types of problems may occur :

1 - **004** error code (lit LED “filter”) or the following icon (for a

graphics screen - KP07) : 

Item 8 on KP 17 indicates that the filters must be changed. The unit has not stopped but the airflow is likely to be reduced due to increased pressure drop across the filters.

2 - **005** error code or the following icon

(for a graphics screen - KP07) : 

Item 9 on KP17 indicates that the filters are out of position : either they have been damaged or not been replaced during maintenance. In the latter case, the unit has not stopped but the increased flowrate may result in the motor overheating. It is important to check the filter immediately.

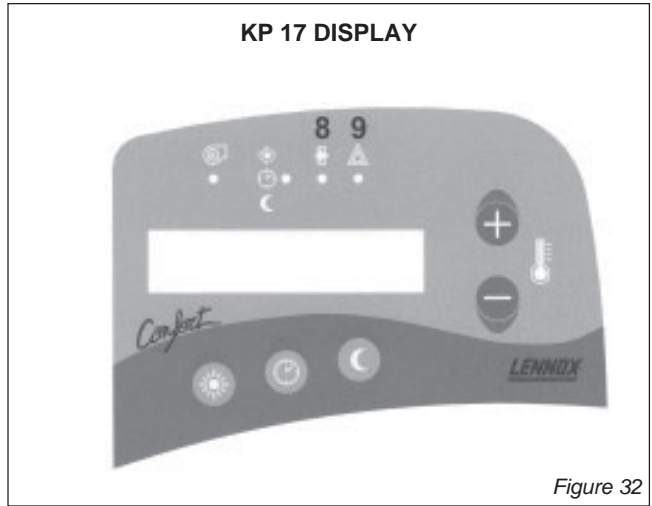

Figure 32

FILTER REPLACEMENT :

After opening the filter access panel, unscrew the butterfly nuts maintaining the filter support and remove it (figure 33).

Remove the cells that are slide-mounted (figure 34). Use the rod in the lower filter section to remove the cells at the bottom of the sliders.

Install new filters inside the sliders.



Figure 33



Figure 34

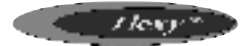

AIR SOCK CONTROL

The use of air socks for space conditioning allows high air volumes to be distributed at low velocity and is becoming a common feature in many applications. To accommodate this trend, Air-sock control is offered which allows the air socks to be progressively filled with air on start up. FLEXY™ has been enhanced with an electronic device to soft start the fan. It takes up to 1 minute to go from 0% of air to full air flow. This time can be divided in several stages :

- The aim of this first voltage input is to overcome the resistance of the transmission (Pulleys and belts) : 0.5s and up to 1000 rpm
- The second stage is to inflate the air sock : 5 to 30 s. and 600 to 900 rpm

Finally the air sock is gradually pressurised during the last 5 to 30 second. The motor reaches nominal speed and the controller is bypassed.

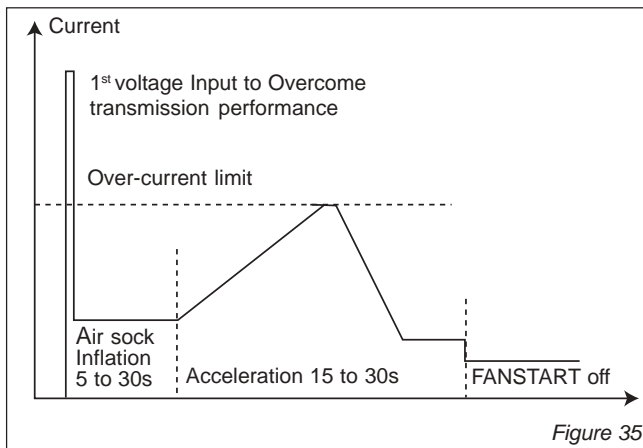

Figure 35

The motor speed control is achieved through a variation of the supply voltage of each phase at constant frequency.

The thermal overload limit on the motor imposes a current limitation during the acceleration stage. Hence if the selected slope is too steep, a predefined current limit can be reached (potentiometer adjustment) and the controller will automatically reduce the voltage set-point accordingly. Then once the current is back under the high current limit it carries on with the start up cycle.

Safety

Excessive "slow down" limit

The FANSTART will display a fault (red LED) and stop the motor, if the motor slows down excessively (voltage could reach 0V) because of the current limitation during the acceleration stage.

Missing phase safety

The FANSTART will display a fault (red LED) if the current in the third phase is too low or reaches 0 Amps (Three phase supply or motor problem)

Current protection of the Thyristor

The FANSTART will display a fault (red LED) if the current exceeds the thyristor current limits

125A during 0.4 s

87.4A during 2 s

75A during 6 s.

62.5A during 20 s.

Start up sequence too long

A fault (red LED) will appear if after 1min20s the FANSTART Control is not bypassed and the motor running from the mains.

Phase rotation check

If the phase rotation is incorrect the FANSTART Control will display a fault (Red LED). Two of the phases must then be inverted and the start up cycle resumed.

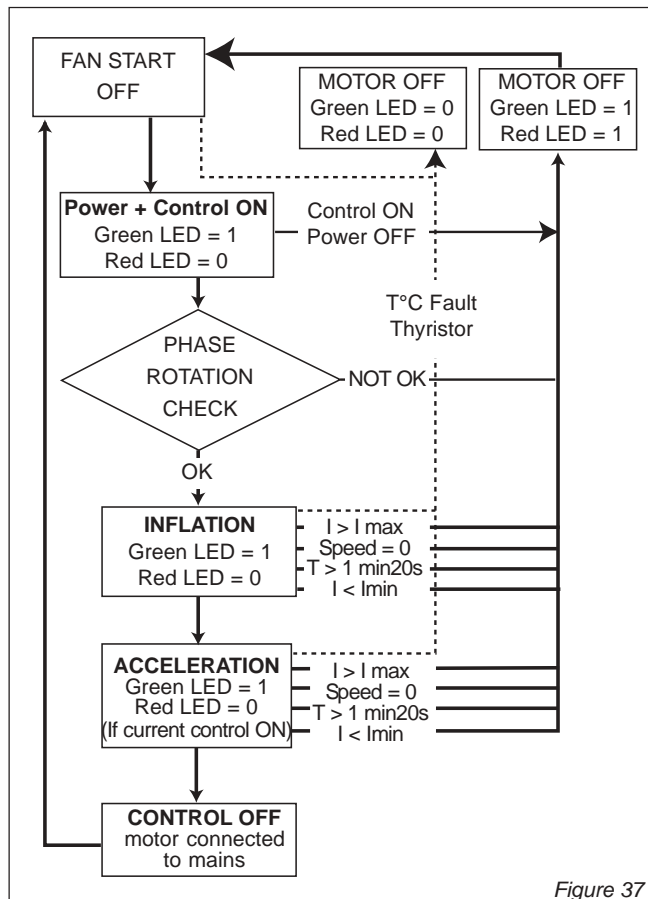

Figure 37



1. Operation of the grids

- Balancing grids are installed on fresh air side in order to compensate for the higher pressure drop on the ducted return air side.
- The aim is to avoid the pressure variations in the area to air conditioned (risk of doors opening in cinemas for example) but also to avoid a current surge on the motor when running 100% fresh air.
- The objective is to maintain constant airflow/pressure operating conditions with the supply air, regardless of the percentage of fresh air.
- Once adjusted the air treatment fans should not see the difference between the ducted return air and the fresh air.

2. Airside adjustment procedure for the FX with 4 dampers

- Adjust the machine with the 0% fresh air configuration, the grids are open to the maximum.
- Measure the Amps and Speed of the "treatment" fan motor. Determine the airflow and pressure using the Fan Curves.
- If the absorbed Amps are higher than the value on the motor plate, the supply and return ducts pressure drop is lower than the requested value at the time of order. Reduce the rpm, change the Pulleys if necessary.
- Once the airflow and pressure have been checked and confirmed, measure the static pressure at the 5 following points :
 - 1a : "Treatment " fan inlet (ex : -230 Pa)
 - 2a : "Treatment" expansion box (ex : -210 Pa)
 - 3a : Return air box (ex : -190 Pa)
 - 4a : Extraction expansion box (ex : -70 Pa)
 - 5a : Extraction fan inlet (ex : -120 Pa)

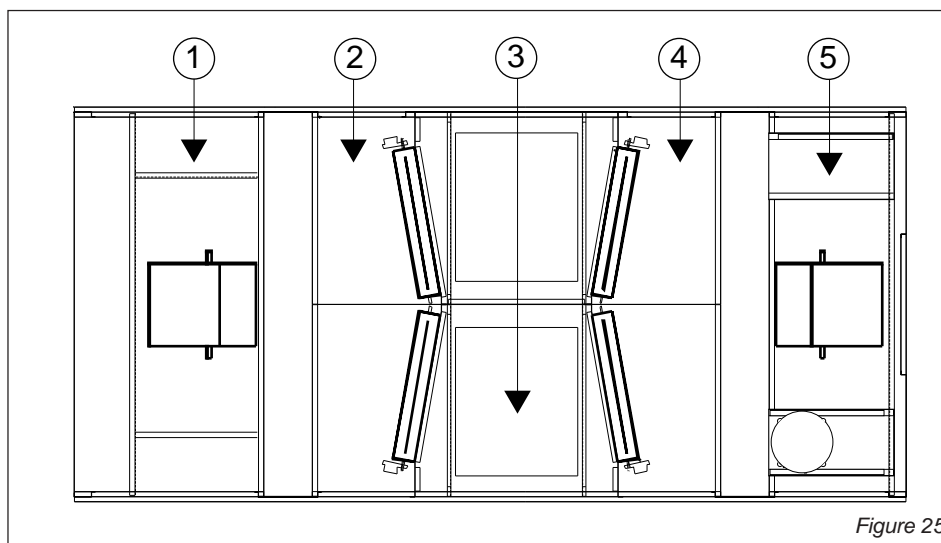
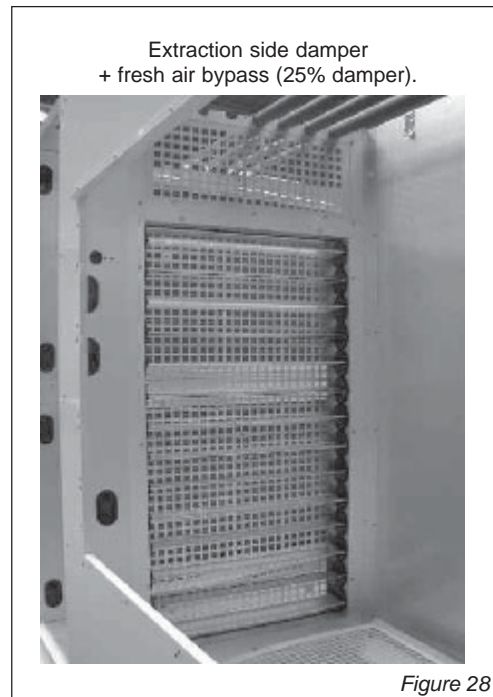
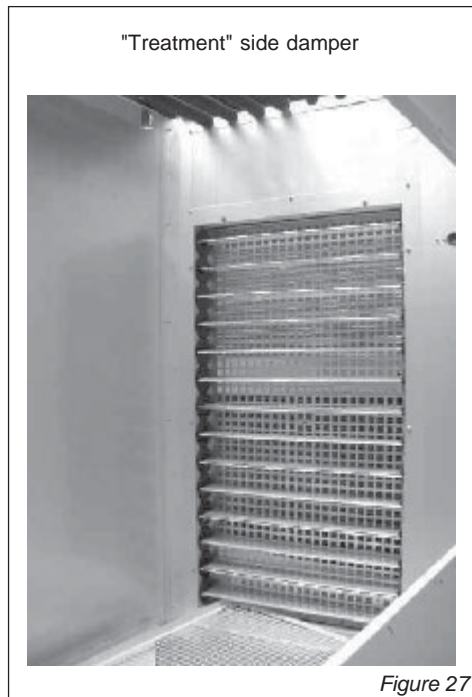
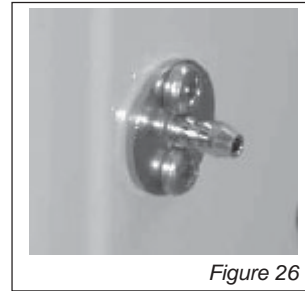

Figure 25

- Adjust the extraction grid to reach a pressure in 4 equal to the pressure in 2 (ex : reach -210 Pa when closing).
- Check the Amps absorbed by the extraction fan motor; It must be lower than the value on the plate otherwise reduce the fan speed.
- Reverse the fresh air percentage: 100 % fresh air at the treatment.
- Measure the Static pressure at the same 5 points
 - 1b : "Treatment " Fan Inlet (ex : -80 Pa)
 - 2b : "Treatment" expansion box (ex : -50 Pa)
 - 3b : Return air box (ex : -200 Pa)
 - 4b : Extraction expansion box (ex : -220 Pa)
 - 5b : Extraction fan inlet (ex : -250 Pa)
- Adjust the grid on the "treatment" side only to reach a pressure at point 2b identical to the pressure at 2a (reach -210 Pa when closing)
- Check that the pressure measured in the extraction expansion box 5b has not changed too much compared with the previous measurement 5a. Adjust the bypass grid to compensate any possible difference.



Example of pressure tapping point available on each box :





PRINCIPLE SKETCHES

0% FRESH AIR TREATMENT

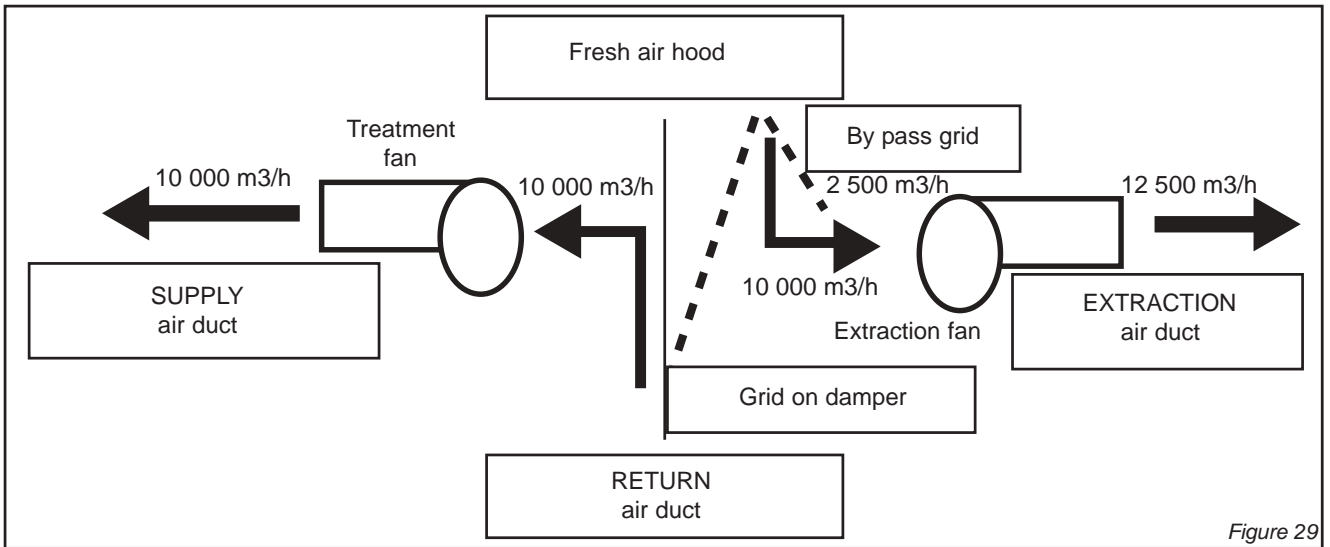

Figure 29

100% FRESH AIR TREATMENT

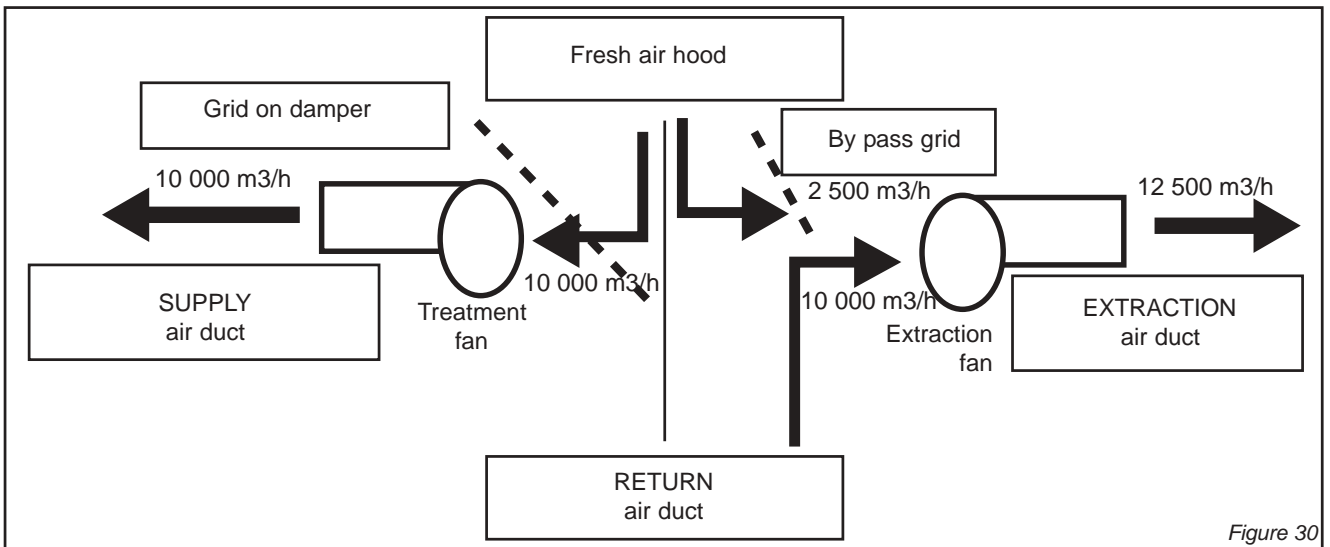

Figure 30

CONSTANT 25% BYPASS TO EXTRACTION

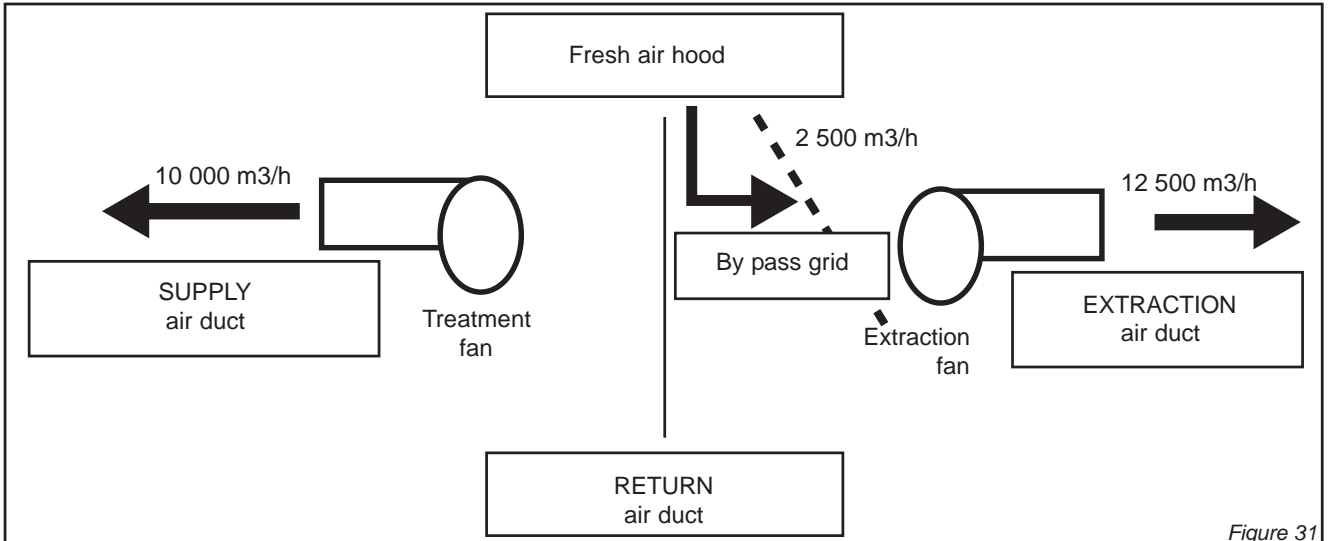

Figure 31



HYDRAULIC CONNECTIONS

The heating coil is connected to the isolating valves. Two keys must be used to tighten the connections, one of the keys maintains the valve body. Failure to use two keys may damage the pipes and invalidates the warranty.

Proceed as follows :

- Open the stop valves and set the 3-way valve to the intermediate position (manual position and turn the thumbwheel to a mid position).
- Fill the hydraulic system and bleed the battery using the air vent (figure 37).
- Check the connections for possible leaks.
- Reset the 3-way valve to automatic.

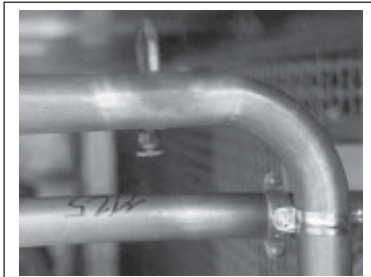

Figure 37

PROTECTION AGAINST FREEZING

- 1) Use glycol water

GLYCOL IS THE ONLY EFFECTIVE PROTECTION AGAINST FREEZING

The antifreeze must protect the unit and avoid icing under winter conditions.

Warning : monoethylene glycol-based antifreeze may produce corrosive agents when mixed with air.

- 2) Drain the installation

You must ensure that the manual or automatic air vents have been installed on all high points in the system. In order to drain the system check that all the drain cocks have been installed on all low points of the system.

To drain, open all the valves and remember to place the unit in air.

A HEATING COIL FROZEN DUE TO LOW AMBIENT CONDITIONS IS NOT COVERED BY THE WARRANTY.

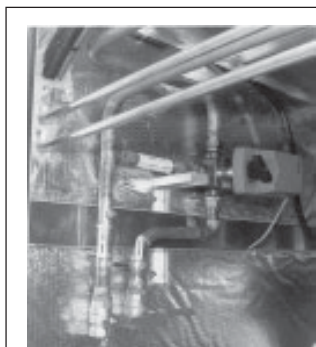

Figure 38

ELECTROLYTIC CORROSION

Attention is drawn to the corrosion problems resulting from electrolytic reaction created from unbalanced earth connections.

ANY COIL DAMAGED BY ELECTRONIC REACTION IS NOT COVERED BY THE WARRANTY.



1. PRELIMINARY CHECKS AND VERIFICATIONS BEFORE START-UP

NOTE :
ANY WORK ON THE GAS SYSTEM MUST BE CARRIED OUT BY QUALIFIED PERSONNEL. THIS UNIT MUST BE INSTALLED IN ACCORDANCE WITH LOCAL SAFETY CODES AND REGULATIONS AND CAN ONLY BE USED IN WELL VENTILLATED AREA. PLEASE READ CAREFULLY THE MANUFACTURER'S INSTRUCTIONS BEFORE STARTING A UNIT. BEFORE COMMISSIONING A UNIT WITH GAZ BURNER, IT IS MANDATORY TO ENSURE THAT THE GAZ DISTRIBUTION SYSTEM (type of gas, available pressure...) IS COMPATIBLE WITH THE ADJUSTMENT AND SETTINGS OF THE UNIT.

1.1 Check access and clearances around the unit :

- Make sure one can move freely around the unit
- A one-meter clearance must be left in front of the burnt gas exhaust chimney(s)
- Combustion air inlet and burnt gas exhaust(s) must not be obstructed in any way.

1.2 Supply network pipe sizing

- The gas supply to a rooftop gas unit must be according to Sound Engineering Practice.
- The pipe-work connected to each rooftop must not be smaller than the diameter of the connection on the rooftop unit.

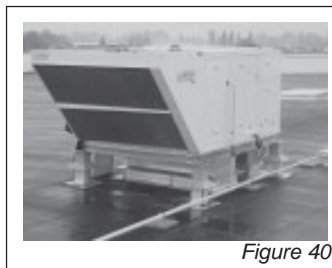

Figure 40

1.3 Shut-off valve in front of each rooftop

- Make sure that a shut off isolation valve has been installed before EACH rooftop.
- Check that the internal shut off valves in the rooftop unit is open.

1.4 Pipe-work purging and gas static pressure checks

- Purge the pipe-work near the connection on the HONEYWELL valve for a few seconds

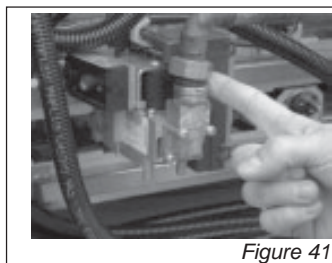

Figure 41

GN 300 mbar option with pressure regulator :

Check the pressure at the regulator inlet.

Propane 37 mbar option :

Check the pressure at the inlet of the HONEYWELL valve.

Propane 148 mbar option with pressure regulation (yellow spring) :

Check the pressure at the regulator inlet. A 10% tolerance around the nominal pressure is acceptable.

1.5 Probes and electrodes position check

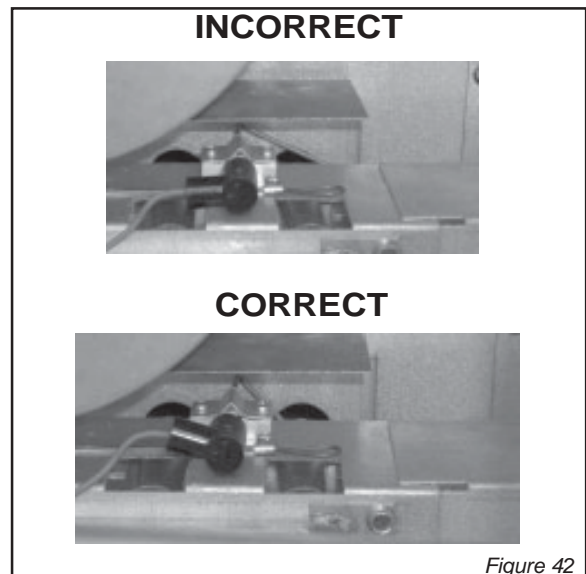

Figure 42

Visually check that the ionisation probe is centred in the middle of the flame.

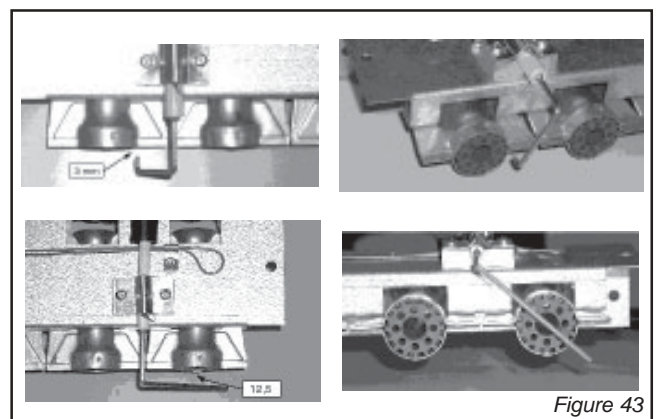

Figure 43

Check that the end of the ignition electrode is aligned with the side of the inshot burner.

Standard GN 20 mbar :
 Check the pressure at the inlet of the HONEYWELL valve.



- Standard start-up chronology
- If incorrect sequence, refer to the fault table to identify the problem.

3.4 Pressure regulator adjustment (in case of 300 mbar)

- The burner must be run in high heat mode for this check.
- Fit the tube of the "accurate" manometer on the **IN** pressure port of the HONEYWELL Block after having loosened the screw by two turns
- Check and adjust if necessary the IN pressure to 20,0 mbar (G20) or 37,0 mbar for propane (G31).

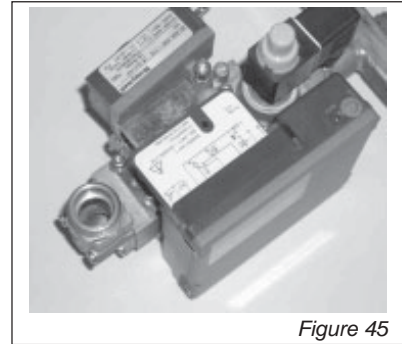

Figure 45

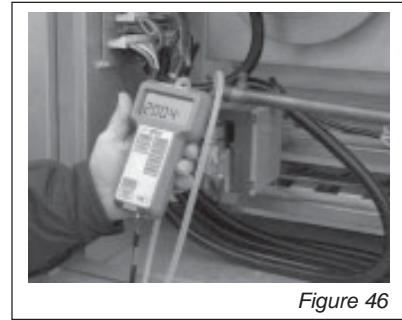

Figure 46

3.5 High heat injection pressure checks

- Fit the tube of the "accurate" Manometer to the **OUT** port on the HONEYWELL valve after having loosened the screw.
- Check and adjust if necessary the OUT pressure to 8,4 mbar (G20) or 31,4 mbar for propane (G31).

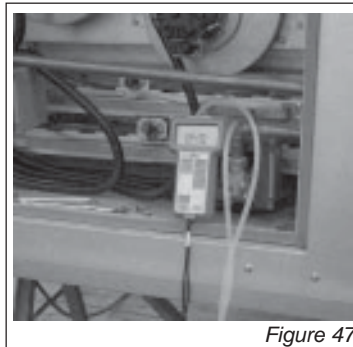

Figure 47

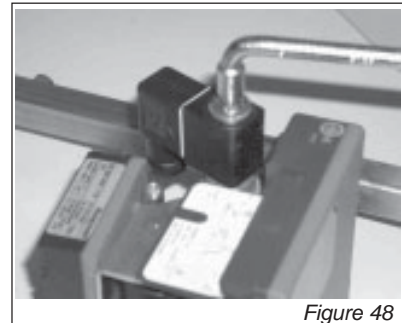

Figure 48

3.6 Low heat injection pressure checks

- Carefully disconnect the wire numbered 116 for the bottom gas burner and the wire numbered 126 for the tops gas burner.
- Check and adjust if necessary the **OUT** pressure to 3,5 mbar (G20) or 14 mbar for propane (G31).

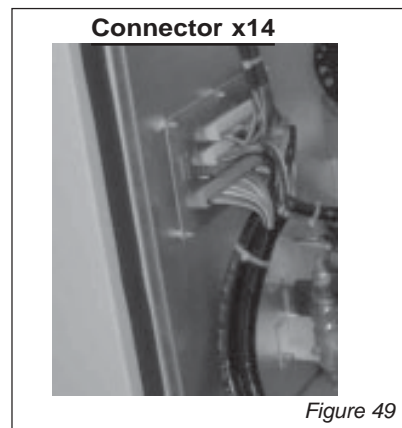

Figure 49

3.7 Reconnect the wires 116-126



Figure 50

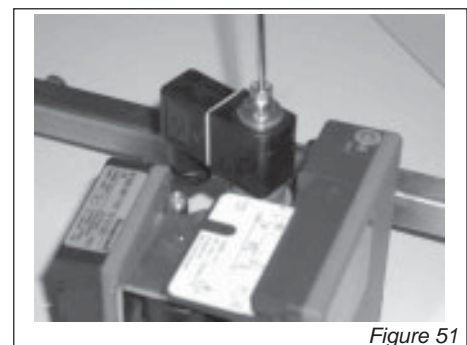

Figure 51



Then re-tighten all pressure adjustment screws.

3.8 Rating table for type of gas and corresponding adjustment pressure

Type of Gas	Category	Supply pressure adjustment Honeywell Valve	Low heat injection pressure adjustment	High heat injection pressure adjustment
Natural GAZ	G20	20.0 mbar	3.5 mbar	8.4 mbar
Natural GAZ	G25 (Groningue)	25.0 mbar	5.0 mbar	12.3 mbar
Propane	G31 (GPL)	37.0 mbar	14.0 mbar	31.4 mbar

4. Burner safety checks

4.1 Smoke extractor pressure switch test

- With the gas burner running, disconnect the flexible tube fitted to the pressure tapping on the smoke box (figure 53).
- The Flame must disappear and the fan must carry on running.
- However, NO fault will be displayed (HONEYWELL control block or CLIMATIC™).
- After reconnecting of the tube, the burner will restart after 30 seconds of pre-ventilation.

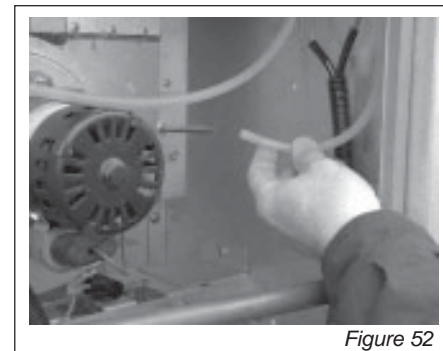

Figure 52

4.2 Gas pressure switch test

- With the gas burner running, close the internal shut off valve in the rooftop.
- The burner stops completely.
- However, No fault light will be displayed on the Honeywell Control box.
- After 6 Minutes, the CLIMATIC 2 will display fault 14 or 15.
- Reset the CLIMATIC™ 2.

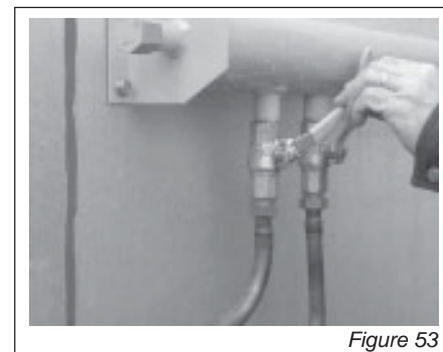

Figure 53

4.3 Ionisation probe test

- With the gas burner running, disconnect the RAJAH terminal plug.
- The flame disappears
- The fan is still running and attempting to restart the burner (restart cycle 45 seconds).
- At the end of the restart cycle the burner stops completely.
- The fault light on the HONEYWELL Block is ON.
- Manually reset the HONEYWELL controller to eliminate the fault. (Refer to §2).

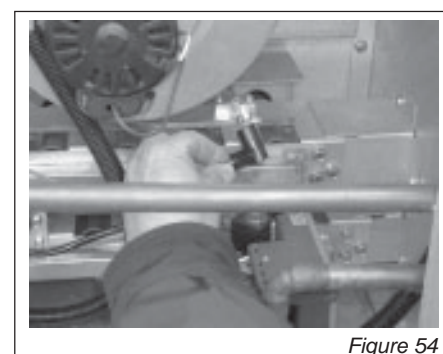

Figure 54



5. DISASSEMBLING THE GAS BURNER FOR MAINTENANCE PURPOSE

5.1 Preliminary safety recommendations

- Isolate the unit using the main isolator
- Close off the isolating gas valve located before the unit

5.2 Disconnect the pipework. Do not discard the seals

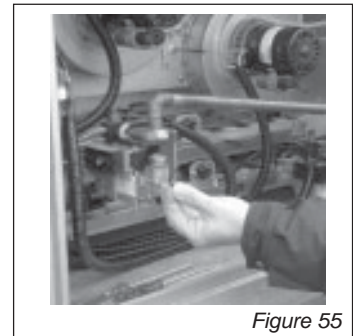

Figure 55

5.3 Disassembling the gas "rail"

- Disconnect the electrical connector on the electric board EF45 or 46.
- Remove the two screws which hold the gas bar in place
- Carefully remove the gas "rail" avoiding any damaged to the electrodes.

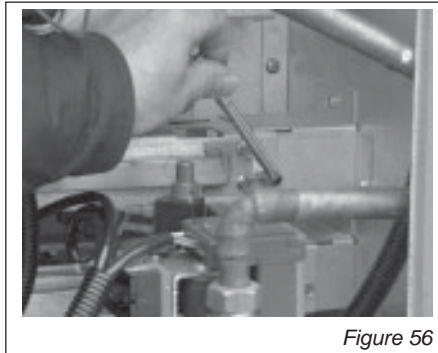

Figure 56

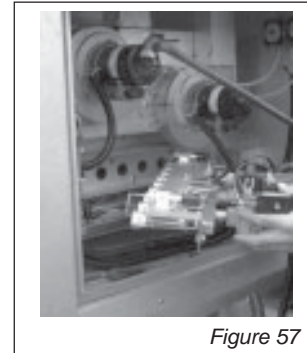

Figure 57

5.4 Disassembling the chimneys

- Electrically disconnect the fan and remove the screws holding it in place.
- Take care not to loose any cage nuts in the smoke bos.
- **Attention** : check the correct position of the pressure tube used by the extraction pressure switch.

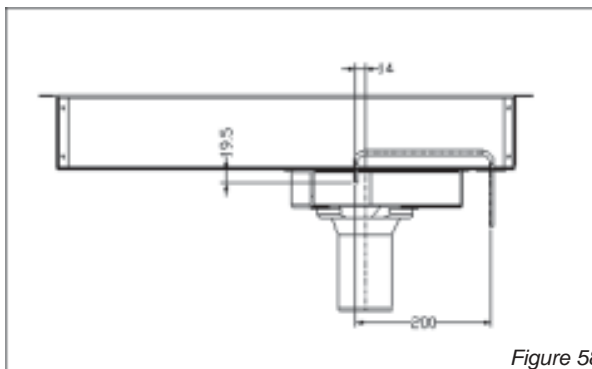

Figure 58



Figure 59



GAS BURNER FIRE-UP SEQUENCE

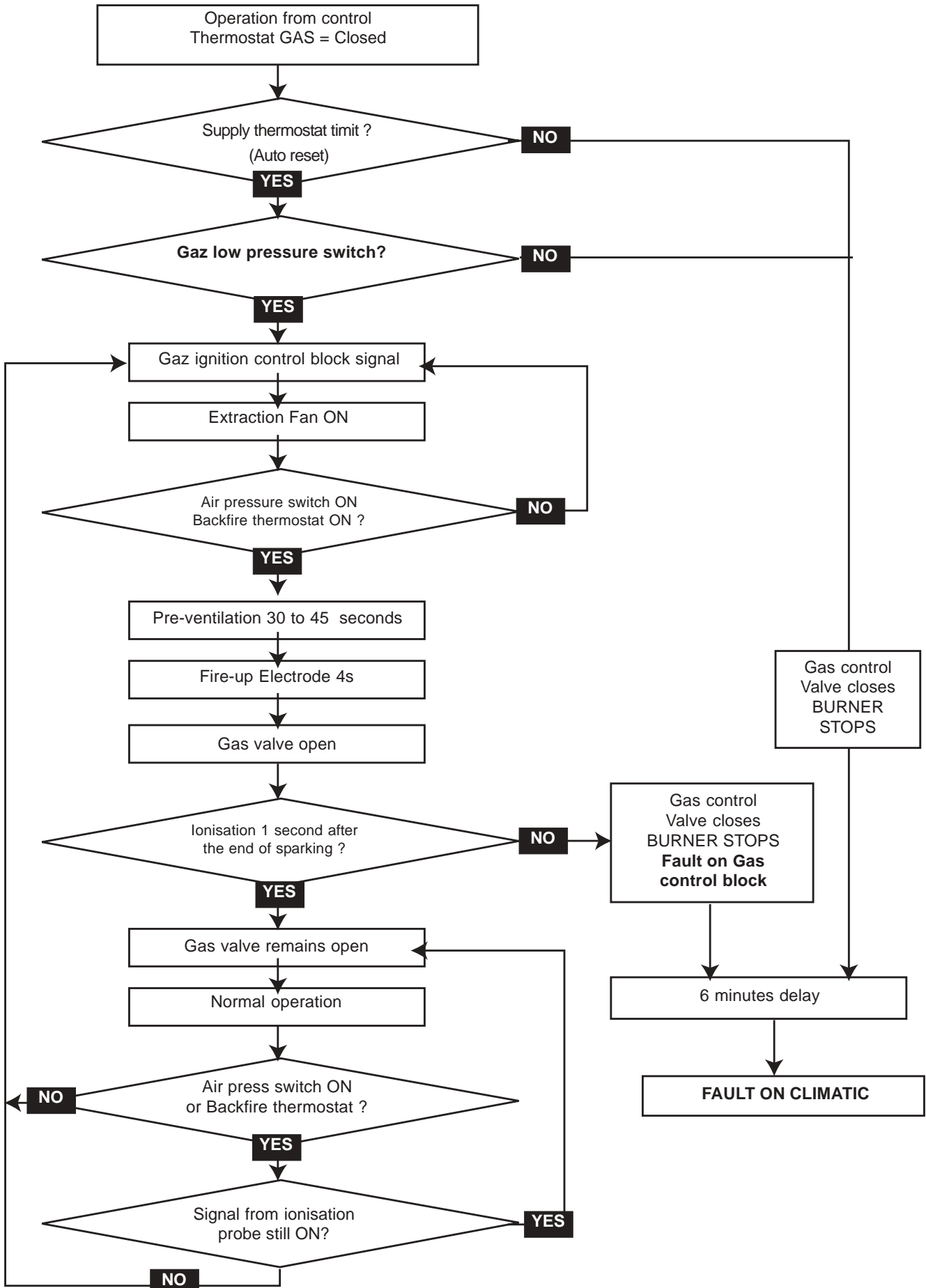



6.1 Fault codes 14 and 15

- Reset the CLIMATIC™ 2
- Check voltage 230V after circuit breaker QF3
- Check gas isolation shut-off valves are open
- Check gas pressure at the inlet of the gas valve. It must be > 20 mbar when the burners shut down
- Adjust the setpoints 59 and 60 to ON to priorities the burner. Increase the value of th setpoint "1" (room setpoint temperature) to a temperature higher than room (variable 1).
- Follow the diagnostic table (see following pages).

Check output voltage
after the control box



Figure 60

Check solenoid coils
on the Honeywell valve

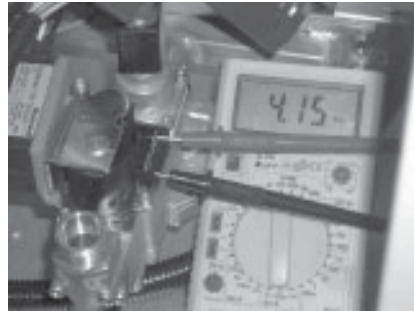

Figure 61



DIAGNOSTIC TABLE GAS BURNER

STAGES	NORMAL OPERATION	FAULT	ACTIONS	SOLUTIONS
Heating requested	Contactors KM21-22 engaged	Contactors do not engage	<ul style="list-style-type: none"> • Check safety thermostats B29-30 in the air duct before the gas heat exchanger 	<ul style="list-style-type: none"> • Replace component
Contactors KM21-22 are engaged	Extraction fans are running	Nothing happens	<ul style="list-style-type: none"> • Check the free movement of the fan wheel • Check the supply temperature limitation thermostats B45-46 • Check GAS low pressure switches B17-18 • Check electrical connection on the Honeywell control block and on EF45-46 connection boards • Check the fan supply voltage 	<ul style="list-style-type: none"> • Replace thermostat • Open GAS Supply • Replace EF 45-46 if necessary
Extraction fan ON	After 30 seconds: the fire-up electrode must create sparks	Continuous ventilation without sparks by electrode	<ul style="list-style-type: none"> • Check position of the fire-up electrode (refer to preliminary checks and verifications §1) • Check the pressure drop at the pressure switch : It must be higher than 200 Pa • Check the good operation of the pressure switch using an Ohmmeter and by sucking through the tube to create a depression. • Check the operation the Backfire thermostat B32-B33 	<ul style="list-style-type: none"> • Re-position the pressure taping tube.(§5.d) • Change the pressure switch • Reset or replace the Thermostat
Continuous ventilation with sparks created by electrode	After 2 seconds the gas burner fires-up	After 4 second the GAS Burner still not running and Safety shutdown by the Honeywell Block.	<ul style="list-style-type: none"> • Check injection pressure during start-up (value for high heat) • Check the supply voltage to the control box (continuous voltage). Refer to figure 61. • Remove the control box from the gas block. Check using an ohmmeter the solenoid coil of the GAS block (4 kOhm). Refer to figure 62 	<ul style="list-style-type: none"> • Remove the air from the pipe-work • Adjust the injection pressure to high heat value • Change the control box if the GAS valve is OK. • Change the gas valve control



7. REQUIRE EQUIPMENT LIST

6.1 Adjustment and start-up

- An accurate manometer from 0 to 3500 Pa (0 to 350 mbar) : 0.1% full scale.

Example Ref :
 DRUCK DPI 705
 19, rue Maurice Pellerin
 92600 Asnières.
 Tel +33 1 41 32 34 64.
 Fax: +33 1 47 93 00 48

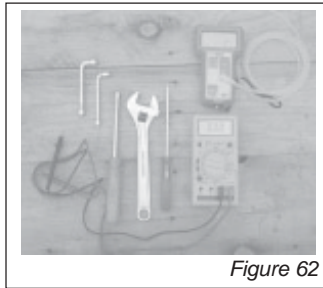

Figure 62

- A multimeter with ohmmeter and micro-amps scale (ionisation)
- Adjustable spanner
- Tube spanner Set : 8, 9, 10, and 13.
- 1 Flat screwdriver diameter 3,4, Phillips n°1

6.2 Maintenance

- Vacuum cleaner
- Paint brush / nylon brush diameter 50

8. CHANGING GAS TYPE

8.1 Modification of the gas burner to run propane instead of natural gas

- Disconnect electrically the GAS burner
- Disconnect GAS supply
- Remove the gas rail with the injectors
- Replace GAS Injectors (natural GAS = 2,3 mm by Propane = 1,37 mm)
- Replace the pilot high/low (natural GAS reference V4336A 2204 1) by the propane version (yellow reference V4336A 2212 1).
- **BE CAREFULL** : DO NOT REPLACE THE PILOT SEAL, keep the seal from the natural gas installation.

8.2 Modification of the pressure regulator (if option 148 mbar)

- Replace the pressure regulator of neutral colour with a YELLOW spring
- Start again all pressure adjustments (§4)

9. REGULAR MAINTENANCE

9.1 Preliminary safety recommendations

- Isolate the unit electrically
- Isolate the gas burner using the appropriate shut-off valves

9.2 Cleaning the components

- Disconnect the gas burner electrically
- Disassemble the gas pipe-work.
- Disassemble the gas burner and remove dust using a paintbrush and a vacuum cleaner.

9.3 Sweeping

- Disassemble the gas burner (refer to previous paragraph)
- Disassemble the exhaust extraction fan.
- Disassemble the exhaust box
- Sweep the inside of the box using a paintbrush and a vacuum cleaner.
- Remove the dust inside the heat exchanger tube using a nylon brush diameter 50 and vacuum the dust away.



60 KW BURNER FOR FGX 60 AND 70 MODELS

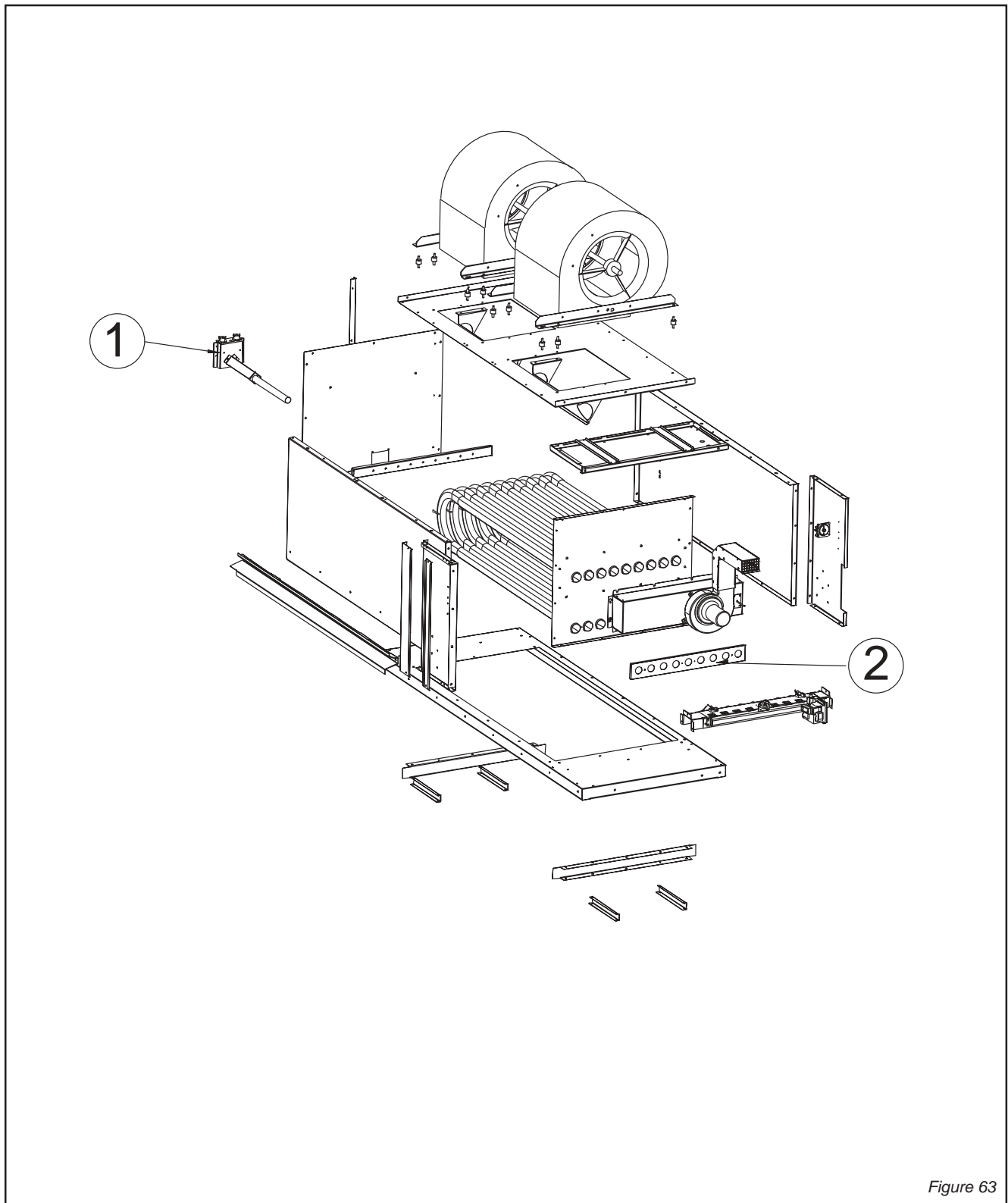

Figure 63



120 KW BURNER FOR FGX 60, 70 AND 100 MODELS

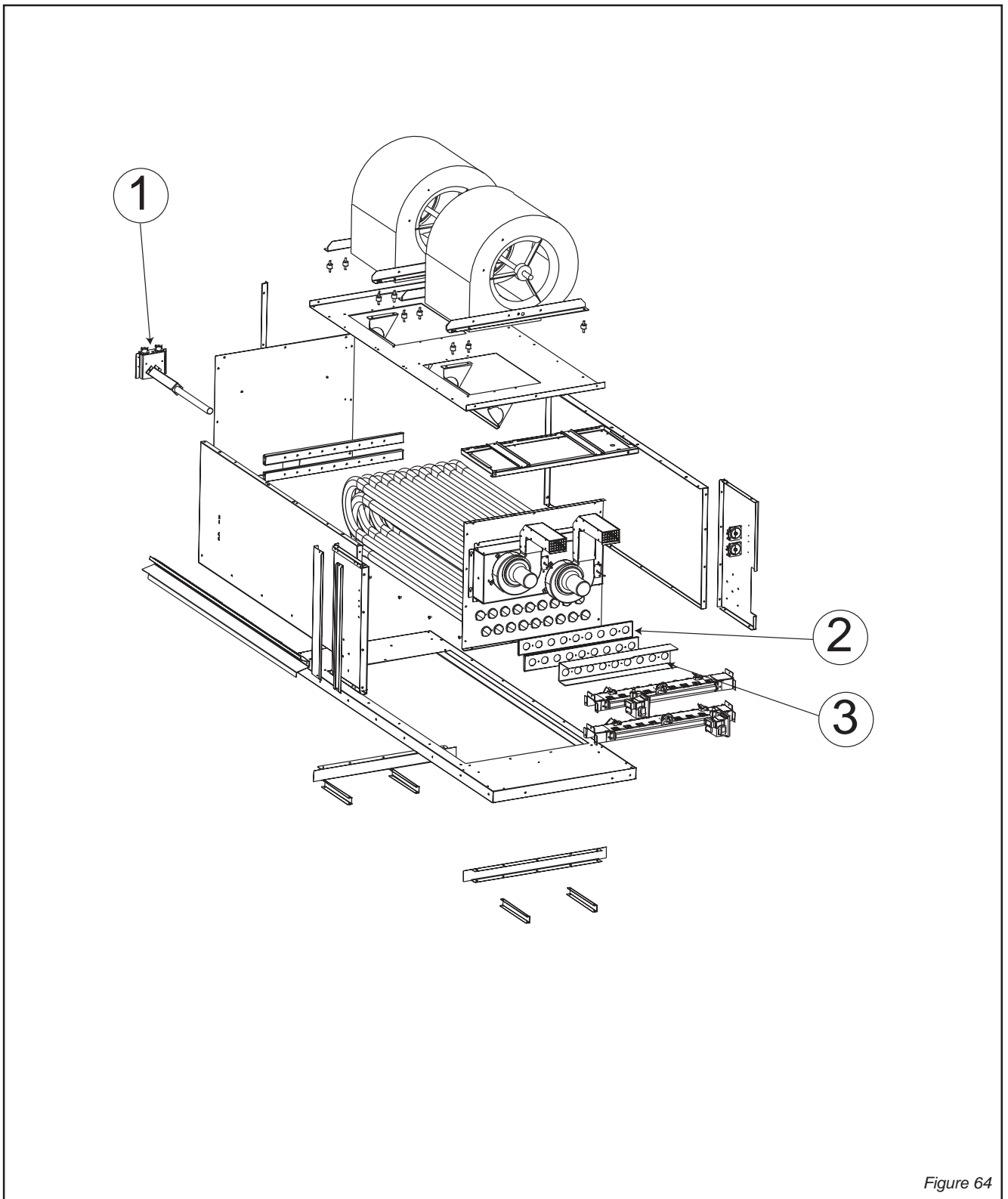

Figure 64



180 KW BURNER FOR FGX 120 AND 140 MODELS

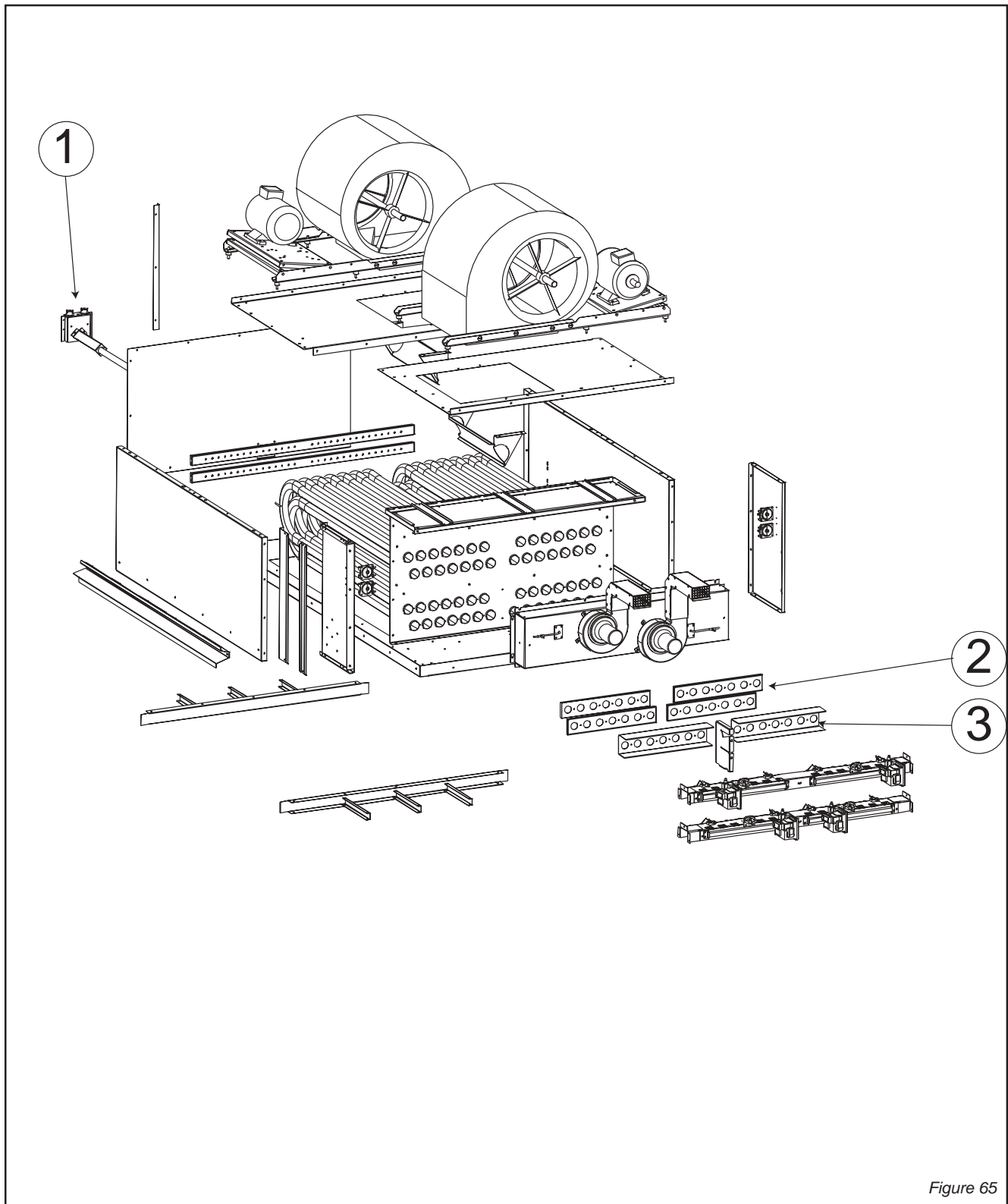

Figure 65



The CLIMATIC™ 'Comfort' control Display allows an untrained person to easily operate a Lennox Roof-Top.

This display connects to a single Rooftop and, through the use of the control keys, LED's and display the user can see how the connected Rooftop is operating, whether there are any faults, modify the comfort setpoint and override the Rooftop operation.

If installed correctly the CLIMATIC™ "Comfort" control display can be installed up to 1000 m away from the Rooftop unit.

DISPLAY (1 - figure 66)

In 'Automatic' operation the comfort setpoint is displayed in the event of a fault detected on the unit an error code is automatically displayed.

The + / - keys (2) are used to change the heating/cooling/operating setpoints.

The LED (3) indicates the current operating mode :

- In 'Automatic' mode, i.e. in the programmed time schedules, the LED flashes,
- In forced occupied mode, the LED is permanently on
- In forced unoccupied mode, the LED is off.

Forced Occupied Key (4)

Pressing this key will override the Automatic control and force the unit to run in its "Occupied" mode.

Whilst in this mode the LED (3) will remain permanently on. To return to "Automatic" mode press button (6) when the LED (3) will flash again.

Forced Unoccupied Key (5)

If, to save energy, the installations are not used within a period programmed for automatic use, it is possible, by pressing this key, to force the unit into its "unoccupied" mode. The LED (3), which was previously flashing or lit, will now go out.

Automatic Operation Key (6)

If the system was previously set to forced occupied mode (LED (3) lit) or forced unoccupied mode (LED (3) off), this key allows you to return to the automatic programmed mode. The LED will flash.

NOTE : 'Forced' modes will automatically be re-set at 00:00h

LED (7) Indicates whether the unit is operating or not.

LED (8) Indicates that the filters are dirty.

LED (9) Indicates a general fault has been detected by the CLIMATIC™. Refer to the "Fault codes" section of this manual.

KP17 COMFORT CONTROL DISPLAY WIRING

Failure to install the Comfort control display with the recommended cable may cause the display to malfunction. The KP17 remote must be connected to the CLIMATIC™ using a 4 x 0.5 mm² braid-screened cable.

This connection is provided through a remote interface card which is located within the Control panel section.

Refer to the wiring section of this manual.

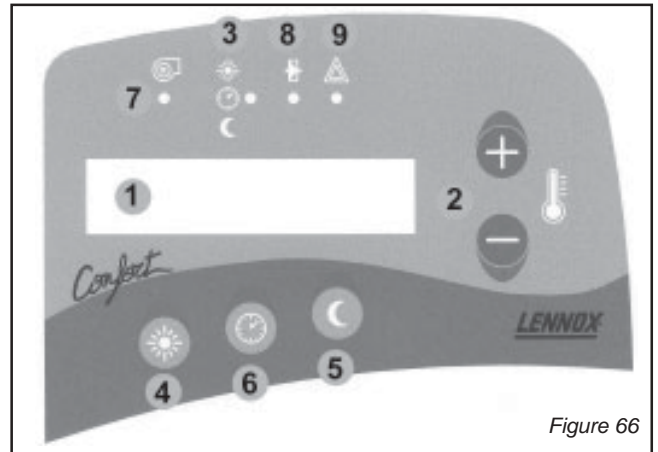
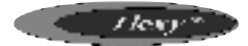

Figure 66



This display unit allows you to read and modify all the values of the variables or setpoints of the rooftop to which it is connected.

The dialogue with the controller is initiated by the CLIMATIC™. If, after 3 attempts, no communication is established, a message will be displayed signalling the problem. The unit will then try to re-connect at regular intervals.

NOTE : If your ROOFTOP already has a KP17 Comfort display connected (see previous section) simply disconnect it and connect this panel to the same location, once completed re-connect the KP17. It is not necessary to switch off the power to the CLIMATIC™ whilst the KP02/KP17 is being changed.

CALLOUT :

- 1 LIQUID CRYSTAL DISPLAY
- 2 RAISE/LOWER KEYS
- 3 "FILTER" LED (flashing red)
- 4 "ADDRESS" KEY
- 5 "MODE" KEY
- 6 "VALUE" KEY
- 7 "UNIT RUNNING" LED
- 8 "MODE" LED
- 9 "GENERAL ALARM" LED.

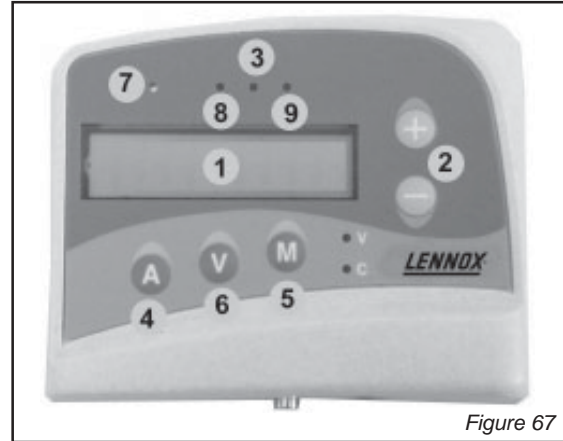
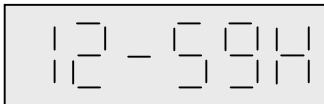

Figure 67

1 - DISPLAY FORMATS

Hour

Default display. If the display unit has been inactive for 5 minutes, this screen will automatically be displayed.



<--> 12 hours and 59 minutes

Date

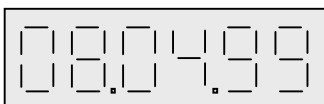

<--> 8 April 1999

Variable or setpoint address

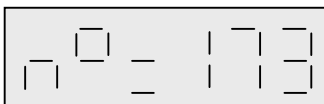



Variable or setpoint value

Digital Values



1 <--> ON

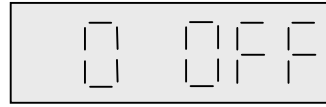

0 <--> OFF

Temperatures

Temperatures are displayed in °C, to an accuracy of 0.1 °C

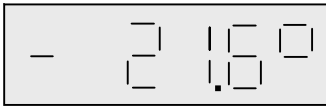

<--> -21.6 °C



<--> + 105.8 °C

Pressures

Pressure is given in bars, to an accuracy of 0.1 bar.

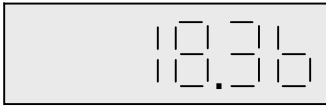

<--> 18.3 bars

Other analog values

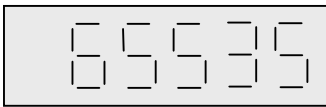

Valeurs displayed

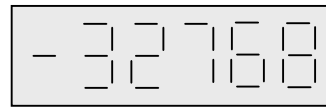

Values non displayed

Specific Displays

Software Version

When the unit is powered up, the KP02 software version number is displayed.

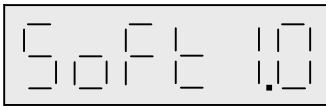

<--> version 1.0 (for example)

Display Test

The display can only be tested for correct operation when the unit is powered up and by pressing on the 3 keys "A", "M" and "-" simultaneously. If the display is working correctly, the following will be displayed :

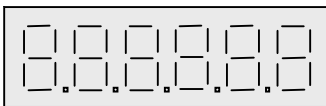

All digits are properly displayed.

Communication Error

If there is no communication between the KP02 display unit and the CPU card, the following message is displayed :

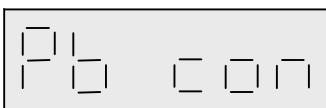

<--> "Communication problem"



2 - OPERATING MODES

The maintenance display allows for 4 modes of operation. Key [M] allows you to move successively and in a loop from one mode to the next.

The current mode is indicated by the status of LEDs [V] and [C] :

Status of LEDs associated with current mode :	[V]	[C]
A. The variable mode allows you to read the values of variables	lit	not lit
B. The setpoint mode allows you to change the settings	not lit	lit
C. The read date mode allows you to view the time and the date	not lit	not lit
D. The date setting mode allows you to change the time and the date	lit	lit

A : VARIABLES MODE

Pressing key [A] displays the address of the variable being read.

To go to a higher address, press [A] while simultaneously pressing on [+].

The address will increase slowly by pressing [+] intermittently or more quickly by keeping your finger on the key.

To go to a lower address, proceed as above but with the [-] key.

When the required address appears, press [V] to display the variable value. If you do not press any key, the display will automatically return after a minute. The variables are updated every second.

B : SETPOINTS MODE

The setpoint address can be chosen in the same way as for the variable address (see above).

When the address of the required setpoint appears, pressing [V] will likewise display the current value.

To increase the setpoint press [V] while holding down the [+] key at the same time.

The address will increase slowly by pressing [+] intermittently or more quickly by keeping your finger on the key.

To go to a lower setpoint, proceed as above but with the [-] key as well as the [V] key.

The new value is applied when [V] is released.

PASSWORD

Access to all the setpoints is password-protected. Enter the password before making changes.

To do so, following the above procedure : go to address setting n° 0 and enter the number corresponding to your password.

If the password code is correct, the following message will appear when key [V] is released :

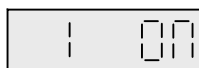

If the keypad has been inactive for 5 minutes, the password is reactivated. You must therefore enter it again to continue making changes to the setpoint values.

C : DATE READING MODE

One of the following modes

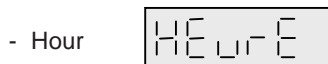

can be chosen by pressing [A] and briefly pressing on [+] or [-].

Pressing [V] will display the value of the data selected, otherwise it will automatically be displayed after a minute.

D : DATE SETTING MODE

This mode allows the 6 date modes to be set :

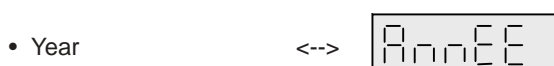
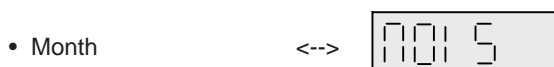
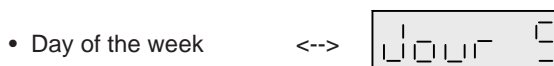
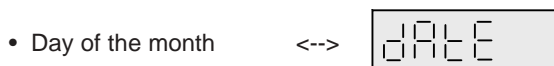
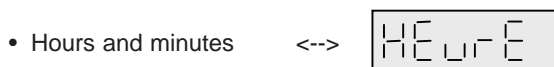

In the same way as for the setpoints, the value can be increased by simultaneously pressing on keys [V] and [+] and they can be decreased by simultaneously pressing on [V] and [-].



For different types of data, the setting ranges are as follows :

Item	Minimum value	Maximum value
Hours and minutes	00-00H	23-59 H
Day of the month	1	31
Day of the week	1	7
Month	1	12
Year	0	99

Changes are only incorporated when key **[A]** is pressed.

NOTE : The compatibility of the value for the day of the month is not checked when it is entered. You might therefore enter February 31st but when you try to validate, it will be ignored and the preceding value stored.

3 - POWER SUPPLY (LED 7 - figure 40)

When lit, the LED indicates that the machine is powered up.

4 - MODE (LED 8 - figure 40)

This LED indicates the current operating mode.
 In normal mode, i.e. within the programmed schedules, the LED flashes.
 In forced day mode, the LED is permanently on and in forced night mode, the LED is off.

5 - FILTER DIRTY (LED 3 - figure 40)

This LED indicates that the CLIMATIC™ has detected that the filter is blocked.

6 - GENERAL FAULT (LED 9 - figure 40)

This LED indicates a general fault has been detected.
 Refer to the "Fault codes" section of this manual.



LIST OF SETPOINTS (LF 20 - APRIL 2002)

1st Level

		Mini.	Factory	Maxi.
C 000	[Kp02] Password, technician level	0	#	255
C 001	[Kp17] [Mode] Required room temperature (in °c). This value corresponds to the middle of the dead zone - (active for Day mode only)	C 051	21.0°C	C 050
C 002	[Kp17] Forced occupied mode (Day) – This action deactivates automatically when the clock first pass midnight - Yellow led lit	Off	Off	On
C 003	[Kp17] Cancels the override of day or night modes- Yellow led flashing	Off	Off	On
C 004	[Kp17] Forced unoccupied mode (Night) – This action automatically deactivates when the clock pass midnight for the second time – Yellow led off	Off	Off	On
C 005	[Reset] Fault reset	Off	Off	On
C 006	[On / Off] Remote control, On / Off unit	Off	Off	On
C 007	[Kp02] Selection of the memory number for the defaults to be visualized	1	#	5
C 008	[Kp02] [Mode] Mode selection for the visualization and the adjustment of the settings 0 = Day, 1 = Week-End, 2 = Night, 3 = not used, 4 = Morning, 5 = Midday, 6 = Evening 7 = BMS	0	#	7
C 009	[Mode] Day of the week, Start of mode - (active for the Week-End mode)	1	#	7
C 010	[Mode] Hour, Start of mode - (active for the modes Week-End, Night, Morning, Midday, Evening)	0 h	# h	22 h
C 011	[Mode] Minute, Start of mode - (active for the modes Week-end, Night, Morning, Midday, Evening)	0 m	# m	59 m
C 012	[Mode] Day of the week, End of mode - (active for the Week-End mode)	1	#	7
C 013	[Mode] Hour, End of mode - (active for the modes Week-End, Morning, Midday, Evening)	0 h	# h	23 h
C 014	[Mode] Minute, End of mode - (active for the modes Week-End, Morning, Midday, Evening)	0 m	# m	59 m
C 015	[Mode] Required maximum room temperature (in °c) - Cooling set point	8.0 c	# c	35.0 c
C 016	[Mode] Required minimum room temperature (in °c) - Heating set point	8.0 c	# c	35.0 c
C 017	[Mode] Selection of humidity control mode [Off] The relative humidity set points are taken into account (in %) [On] The absolute humidity set points are taken into account - (in g/kg)	Off	Off	On
C 018	[Mode] Required maximum room relative humidity (in %) – Dehumidification set point	0 %	# %	100 %
C 019	[Mode] Required maximum room absolute humidity (in g/kg) – Dehumidification set point	0.0 g/kg	# g/kg	30.0 g/kg
C 020	[Mode] Required minimum room relative humidity (in %) – Humidification set point	0 %	# %	100 %



LIST OF SETPOINTS (LF 20 - APRIL 2002) - cont'd

1st Level

		Mini.	Factory	Maxi.
C 021	[Mode] Required minimum room absolute humidity (in g/kg) – Humidification set point	0.0 g/kg	# g/kg	30.0 g/kg
C 022	[Mode] Required minimum percentage for fresh air	0 %	# %	100 %
C 023	[Mode] Stopping and running of the fan blower supply [Off] The blower is stopped [On] The blower is running.	Off	#	On
C 024	[Mode] Stopping and running of the fan blower supply in the regulation dead zone [Off] The blower is stopped [On] The blower is running	Off	#	On
C 025	[Mode] Management of the low speed on the fan supply in the cooling regulation zone [Off] The fan is on high speed [On] The fan is on low speed	Off	#	On
C 026	[Mode] Management of the low speed on the fan supply in the regulation dead zone [Off] The fan is on high speed [On] The fan is on low speed	Off	#	On
C 027	[Mode] Management of the low speed on the fan supply in the heating regulation zone [Off] The fan is on high speed [On] The fan is on low speed	Off	#	On
C 028	[Mode] Force the noise reduction mode [On] 50% of the compressors are unloaded	Off	#	On
C 029	[Mode] Force the operation mode	Off	#	On
C 030	[Command] Force the low speed on fan blower supply	Off	Off	On
C 031	[Command] Force the fresh air damper in the closed position - (0% fresh air)	Off	Off	On
C 032	[Command] Force the fresh air damper to its defined minimum set point position.	Off	Off	On
C 033	[Command] Force fresh air damper in the fully open position - (100% fresh air)	Off	Off	On
C 034	[Command] Force an unloading of the compressors	Off	Off	On
C 035	[Command] Force an unloading of the electric heat	Off	Off	On
C 036	[Command] Forced unloading of : (FLEXY™) - 50% of the compressors - 100% of electrical heat	Off	Off	On
C 037	[Command] Force an unloading of all refrigeration parts	Off	Off	On
C 038	[Command] Force an unloading of all heating parts	Off	Off	On
C 039	[Safety limits] Room temperature low limit (in °c) - Threshold of activation of the safety cut-out	5.0 c	10.0 c	20.0 c
C 040	[Safety limits] Room temperature high limit (in °c) - Threshold of activation of the safety cut-out	20.0 c	40.0 c	40.0 c



LIST OF SETPOINTS (LF 20 - APRIL 2002) - cont'd

1st Level

		Mini.	Factory	Maxi.
C 041	[Safety limits] Room relative humidity low limit (in %) - Threshold of activation of the safety cut-out	0 %	0 %	50 %
C 042	[Limit safety] Room absolute humidity low limit (in g/kg) - Threshold of activation of the safety cut-out	0.0 g/kg	0.0 g/kg	30.0 g/kg
C 043	[Safety limits] Room relative humidity high limit (in %) - Threshold of activation of the safety cut-out	50 %	100 %	100 %
C 044	[Limit safety] Room absolute humidity high limit (in g/kg) - Threshold of activation of the safety cut-out	0.0 g/kg	30.0 g/kg	30.0 g/kg
C 045	[Anticipation function] Bottom of slope (in °c) - Limit of activation of the function - This allows an anticipated start-up in the morning mode depending on the outside temperature.	0.0 c	10.0 c	20.0 c
C 046	[Anticipation function] Slope - Number of minutes of anticipation per degrees. This allows an anticipated start-up in the morning mode depending on the outside temperature.	0	0	100
C 047	[Co2] Fresh air dampers opening threshold (in ppm)	0 ppm	1000 ppm	2000 ppm
C 048	[Co2] Fresh air dampers maximum opening limit (in ppm)	0 ppm	1500 ppm	2000 ppm
C 049	[Extraction] Threshold of activation of the power exhaust fan according to the position of the economiser damper (in %)	0 %	10%	100 %

2nd Level

		Mini.	Factory	Maxi.
C 050	[kp17] [Mode] Maximum limit for room temperature, Day mode (in °c) - (active for the mode Day)	21.0 c	27.0 c	35.0 c
C 051	[kp17] [Mode] Minimum limit for room temperature, Day mode (in °c) - (active for the mode Day)	8.0 c	17.0 c	21.0 c
C 052	[Room control] Minimum operation time for a stage (in seconds)	25 s	180 s	1800 s
C 053	[Room control] Temperature difference between the beginning and the end of a stage of control in cooling. (in °c)	0.0 c	1.0 c	10.0 c
C 054	[Room regulation] Temperature difference between two stages of control in cooling. (in °c)	0.1 c	1.0 c	10.0 c
C 055	[Room control] Temperature difference between the beginning and the end of a stage of control in heating. (in °c)	0.0 c	0.5 c	10.0 c
C 056	[Room control] Temperature difference between two stages of control in heating. (in °c)	0.1 c	0.5 c	10.0 c
C 057	[Room control] Choice of the priority for the control in heating. [On] Hot water coil or electrical heater or gas then compressors [Off]. Compressors then hot water coil or electrical heater or gas	Off	Off	On
C 058	[Supply control] Activation of the control. – The control of the supply applies when the room temperature is in the dead zone. - This function allows to maintain comfort with the supply air	Off	Off	On
C 059	[Supply control] Sampling time (in seconds)	1 s	10 s	120 s
C 060	[Supply control] Choice of the priority for the control in heating [On] Hot water coil or electrical heater or gas then compressors [Off] Compressors then hot water coil or electrical heater or gas	Off	Off	On



LIST OF SETPOINTS (LF 20 - APRIL 2002) - cont'd

2nd Level

		Mini.	Factory	Maxi.
C 061	[Humidity control] Relative humidity difference between the beginning and the end of a stage of control in dehumidification (in %)	1 %	3 %	50 %
C 062	[Humidity control] Relative humidity difference between two stages of control in dehumidification (in %)	1 %	3 %	50 %
C 063	[Humidity control] Sampling time of the control in humidification (in seconds)	1 s	10 s	120 s
C 064	[Humidity control] Proportional band for the control in humidification (in %)	1 %	5 %	50 %
C 065	[Safety limit] Supply temperature low limit (in °c) - Threshold of activation of the 1 st level of safety.	C 066 + 2.0 c	8.0c / 10.0 c	19.0 c
C 066	[Safety limit] Supply temperature low limit (in °c) - Threshold of activation of the 2 nd level of safety.	C 067 + 2.0 c	6.0c / 8.0 c	17.0 c
C 067	[Safety limit] Supply temperature low limit (in °c) - Threshold of activation of the 3 rd level of safety. - Alarm threshold	5.0 c / 1.0 c	2.0c / 6.0 c	15.0 c
C 068	[Safety limit] Supply temperature high limit (in °c) - Threshold of activation of the 1 st level of safety	20.0 c	40.0 c	70.0 c
C 069	[Safety limit] Supply temperature high limit (in °c) - Threshold of activation of the 2 nd level of safety. - Alarm threshold	C 068	60.0 c	70.0 c
C 070	[Control limit] Fresh air damper - Maximum outdoor temperature limit (in °c). - If the outdoor temperature is higher than this limit the control in free-cooling is not authorized. - The fresh air damper is then positioned on the minimum setting.	0.0 c	26.0 c	60.0 c
C 071	[Control limit] Fresh air damper – Minimum outdoor temperature limit (in °c). - If the outdoor temperature is lower than this limit the control in free-cooling is not authorized. - The fresh air damper is then positioned on the minimum setting.	0.0 c	5.0 c	30.0 c
C 072	[Fresh air damper] Maximum allowable opening for the fresh air damper (in %)	0 %	100 %	100 %
C 073	[Control limit] * 1° (FLEXY) If option all seasons control - Reduction of speed of the condenser fans - Threshold of outdoor temperature (in °c). - If the outside temperature is lower than this threshold the condenser fans run low speed * 2° Otherwise – Unloading 50% of the compressors in cooling mode - Threshold of outdoor temperature (in °c). - If the outdoor temperature is lower than this threshold 50% of the compressors are unloaded by the control.	-10.0 c / 10.0 c	12.0 c / 20.0 c	30.0 c
C 074	[Control limit] * 1° If option all seasons control – Shut down condenser fans - Threshold of outdoor temperature (in °c). - If the outdoor temperature is lower than this threshold the condenser fans are stopped * 2° Otherwise - Unloading 100% of compressors in cooling mode - Threshold of outdoor temperature (in °c). - If the outdoor temperature is lower than this threshold the compressors are stopped by the control	-10.0 c / 10.0 c	5.0 c / 12.0 c	30.0 c
C 075	[Control limit] Unloading 100% of compressors in heating mode - Threshold of outdoor temperature (in °c). - If the outdoor temperature is lower than this threshold the compressors are not used by the regulation	-50.0 c	-20.0 c	20.0 c



LIST OF SETPOINTS (LF 20 - APRIL 2002) - cont'd

2nd Level

		Mini.	Factory	Maxi.
C 076	[Defrost function] Authorization of defrost - Threshold of outdoor temperature (in °c)	8.0 c	10.0 c / 20.0 c	20.0 c
C 077	[Defrost function] Authorization of defrost - Threshold of temperature of refrigerant fluid (in °c)	-10.0 c	2.0 c / -2.0 c	6.0 c
C 078	[Defrost function] Coil icing time (in minute) - The defrost cycle starts if the operating time of a compressor in heat pump mode reached this value	30 m	30 m / 45 m	90 m
C 079	[Defrost function] Defrost cycle end - Value indicating the number of start-up of the condenser fan by the pressure switch to signify the end of the defrost cycle	1	1 / 3	5
C 080	[Safety limit] Water heat exchanger output temperature low limit (in °c) - Threshold of activation of the safety	4.0 c	5.0 c	20.0 c
C 081	[Safety limit] Water heat exchanger output temperature high limit (in °c) - Threshold of activation of the safety	20.0 c	45.0 c	46.0 c
C 082	[Control limit] Unloading 100% of electrical heat - Threshold of outdoor temperature (in °c). If the outdoor temperature is higher than this threshold electrical heat are switched off by the control	-20.0 c	10.0 c	30.0 c
C 083	[Electric heat] Maximum usable power for electric heat (in %)	0 %	100 %	100 %
C 084	[Electric heat] (FLEXY FX) All season control - Threshold of mixed air temperature (in °c) - If the mixed air temperature is lower than this threshold electric heat is activated	0.0 c	5.0 c	10.0 c
C 085	[Safety limit] Air flow detection - Threshold of pressure difference for the loss of pressure detection (in pa) - If the pressure difference across the filters is lower than this threshold the safety is activated.	0 pa	20 pa	1000 pa
C 086	[Safety limit] Clogged filter detection - Threshold of pressure difference for the detection of clogging (in pa) - If the pressure difference across the filters is higher than this threshold the safety is activated	0 pa	250 pa	1000 pa
C 087	[Safety limit] Missing filter detection - Threshold of pressure difference for the detection of missing filters (in pa) - If the pressure difference across the filter is lower than this threshold the safety is activated	0 pa	50 pa	1000 pa
C 088	[kp12-2] Time delay for the closing of contact n°3 (in seconds)	4 s	60 s	65535 s
C 089	[kp12-2] Time delay for the opening of the contact n°2 (in seconds)	2 s	300 s	65535 s
C 090	[kp17] Choice of operating mode – [Off] Left button = Forcing day mode / Medium button = Cancel forcing / Right button = Forcing night mode – [On] Left button = Start the unit / Right button = Stop the unit	Off	#	On
C 091	[Configuration] Identification number for the j-bus connections	1	#	255
C 092	[BMS] Activation of the control by a computer or an automat - Mode BMS is activated if this value is different from zero, this value is decreased every second	0	0	65535
C 093	[Configuration] [Link] Identification number for the connections link between boards	0	#	7
C 094	[Configuration] [Link] Number of boards linked on the bus	0	#	8



LIST OF SETPOINTS (LF 20 - APRIL 2002) - cont'd

2nd Level

		Mini.	Factory	Maxi.
C 095	[Configuration] [Link] Selection of the operating mode – [0] Inactive [1] One kp17 for several units - All information on the kp17 connected to the master unit is communicated to the slave units [2] One unit in standby mode - The unit with the highest address connected to the bus is stopped. If a fault is detected on another unit, the faulty unit is stopped and the standby unit is started automatically [3] Same as choice 2 but the standby unit is changed every Tuesday at 8 o'clock	0	#	3
C 096	[Configuration] [Link] Selection of exchange mode for room temperature and humidity [0] Inactive [1] The room temperature and humidity of the master unit are communicated to the slave units [2] The room temperature and humidity are taken as the average of the active probes.	0	#	2
C 097	[Configuration] [Link] Selection of exchange mode for outdoor temperature and humidity [0] Inactive [1] The outdoor temperature and humidity of the master unit are communicated to the slave units [2] The outdoor temperature and humidity are taken as the average of the active probes.	0	#	2
C 098	[Configuration] Type of unit	0	#	65535
C 099	[Configuration] Type of unit [Off] FLEXY	Off	#	On
C 100	[Configuration] Activation of the dual-speed option for fan supply	Off	#	On
C 101	[Configuration] Activation of the all seasons control option	Off	#	On
C 102	[Configuration] Activation of the optimised defrost option	Off	#	On
C 103	[Configuration] Activation of the humidity and the enthalpy management option	Off	#	On
C 104	[Various] Override all set points to factory settings	Off	Off	On
C 105	[Various] reserved Lennox	0	0	65535

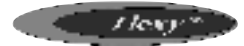

VARIABLE LIST (LF 20 - April 2002)

1st Level

V 000	[Defects] error codes
V 001	[Value] Temperature (in °c), Room, Reference value
V 002	[Value] Relative humidity (in %), Room, Reference value
V 003	[Value] Absolute humidity (in g/kg), Room, Reference value
V 004	[Value] Temperature (in °c), Outdoor, Reference value
V 005	[Value] Relative humidity (in %), Outdoor, Reference value
V 006	[Value] Absolute humidity (in g/kg), Outdoor, Reference value
V 007	[Input] Temperature (in °c), Supply
V 008	[Input] Temperature (in °c), Mixing
V 009	[Input] Temperature (in °c), Free
V 010	[Input] Temperature (in °c), Chilled water
V 011	[Input] Temperature (in °c), Compressor, n°1
V 012	[Input] Temperature (in °c), Compressor, n°2
V 013	[Input] Temperature (in °c), Compressor, n°3
V 014	[Input] Temperature (in °c), Compressor, n°4
V 015	[Input] Temperature (in °c), Condenser, n°1
V 016	[Input] Temperature (in °c), Condenser, n°2
V 017	[Input] Temperature (in °c), Condenser, n°3
V 018	[Input] Temperature (in °c), Condenser, n°4
V 019	[Input] Temperature (in °c), Water condenser, Output exchanger
V 020	[Input] Signal, Shift of the set point
V 021	[Input] Pressure (in pa), Air flow, Supply fan
V 022	[Input] Signal (in ppm), Air quality sensor, Co ²
V 023	[Input] Pressure (in b), Compressor, n°1
V 024	[Input] Pressure (in b), Compressor, n°2
V 025	[Input] Pressure (in b), Compressor, n°3
V 026	[Input] Pressure (in b), Compressor, n°4
V 027	[Output] Supply fan
V 028	[Output] Supply fan, Command low speed
V 029	[Output] Extraction fan
V 030	[Output] Compressor, n°1
V 031	[Output] Compressor, n°2
V 032	[Output] Compressor, n°3
V 033	[Output] Compressor, n°4
V 034	[Output] Compressor, Cycle reversing valve, Heat pump, n°1
V 035	[Output] Compressor, Cycle reversing valve, Heat pump, n°2
V 036	[Output] Compressor, Cycle reversing valve, Heat pump, n°3
V 037	[Output] Compressor, Cycle reversing valve, Heat pump, n°4
V 038	[Output] Compressor, Hot gas injection valve
V 039	[Output] Condenser fan, Command low speed
V 040	[Output] Condenser fan, n°1
V 041	[Output] Condenser fan, n°2
V 042	[Output] Condenser fan, n°3
V 043	[Output] Condenser fan, n°4
V 044	[Output] Pump
V 045	[Output] Electrical heater, n°1, 1st level
V 046	[Output] Electrical heater, n°1, 2nd level
V 047	[Output] Electrical heater, n°2
V 048	[Output] Gas grade, n°1, 1st level
V 049	[Output] Gas grade, n°1, 2nd level
V 050	[Output] Gas grade, n°2



V 051	[Output] Gas grade, Reset	
V 052	[Output] Economiser, Proportional action (0-255)	
V 053	[Output] Chilled water coil, Proportional action (0-255)	
V 054	[Output] Hot water coil, Proportional action (0-255)	
V 055	[Output] Electrical heater, Static relays, Proportional action (0-255)	
V 056	[Output] Humidifier, Proportionnel action (0-255)	
V 057	[Statute] supply fan 1 = ok 3 = option low speed 6 = activation of a defect 8 = ventilation nonready	2 = option air flow 4 = option air flow + low speed 7 = activation of a defect filters
V 058	[Statute] Economiser 0 = option any air recycled 2 = option economiser 4 = option co ² 6 = function enthalpy activates 8 = ventilation no ready	1 = all fresh air 3 = option enthalpy 5 = option enthalpy + co ² 7 = remote command active
V 059	[Statute] Chilled water coil 0 = not configured 8 = ventilation no ready	1 = ok
V 060	[Statute] Hot water coil 0 = not configured 8 = ventilation no ready	1 = ok
V 061	[Statute] Compressor, n°1 0 = not configured 2 = option heat pump 5 = limit outside temperature or remote command active 6 = activation of a defect 8 = ventilation no ready	1 = option cooling only 3 = defrost in progress 7 = activation of a defect condenser
V 062	[Statute] Compressor, n°2 0 = not configured 2 = option heat pump 5 = limit outside temperature or remote command active 6 = activation of a defect 8 = ventilation no ready	1 = option cooling only 3 = defrost in progress 7 = activation of a defect condenser
V 063	[Statute] Compressor, n°3 0 = not configured 2 = option heat pump 5 = limit outside temperature or remote command active 6 = activation of a defect 8 = ventilation no ready	1 = option cooling only 3 = defrost in progress 7 = activation of a defect condenser
V 064	[Statute] Compressor, n°4 0 = not configured 2 = option heat pump 5 = limit outside temperature or remote command active 6 = activation of a defect 8 = ventilation no ready	1 = option cooling only 3 = defrost in progress 7 = activation of a defect condenser
V 065	[Statute] Condenser 0 = not configured 2 = option water condenser 8 = ventilation no ready	1 = option air condenser 6 = activation of a defect
V 066	[Statute] Pump 0 = not configured 6 = activation of a defect	1 = ok 8 = ventilation no ready
V 067	[Statute] Electrical heater 0 = not configured 4 = static relays 5 = limit outside temperature or remote command active 6 = activation of a defect	1, 2 or 3 = number of stages 8 = ventilation no ready



V 068	[Statute] Gas grade 0 = not configured 6 = activation of a defect	1, 2 or 3 = number of stages 8 = ventilation no ready
V 069	[Statute] Humidifier 0 = not configured 6 = activation of a defect	1 = ok 8 = ventilation no ready
V 070	[Regulation] Real set point, Cooling, Room	
V 071	[Regulation] Real set point, Heating, Room	
V 072	[Regulation] Power-factor, Cooling, Room	
V 073	[Regulation] Power-factor, Heating, Room	
V 074	[Regulation] Real set point, Supply	
V 075	[Regulation] Power-factor, Cooling, Supply	
V 076	[Regulation] Power-factor, Heating, Supply	
V 077	[Regulation] Real set point, Dehumidification, Room	
V 078	[Regulation] Real set point, Humidification, Room	
V 079	[Regulation] Power-factor, Dehumidification, Room	
V 080	[Regulation] Power-factor, Humidification, Room	
V 081	[Mode] Number of the active mode	
V 082	[Function] Number of the unit in standby	
V 083	[Defects] Memory, Code	
V 084	[Defects] Memory, Hour	
V 085	[Defects] Memory, Minute	
V 086	[Defects] Memory, Day	
V 087	[Defects] Memory, Month	
V 088	[Information] Non-standard program	
V 089	[Information] Number of version of the program	

CONFIGURATION

This information is taken into account by the program after having switched off/on the CLIMATIC, and a second time for C091 and C093 setpoints.

Set point 'Eeprom'

(KP02 C.083)	Maximum percentage of power of electrical heater	1
(KP02 C.090)	On = KP17 in ON/OFF mode	1
(KP02 C.091)	J.Bus - Number of slave (KP06, KP07, CLIMALINK, CLIMALOOK)	2
(KP02 C.093)	Link - Identification number	2
(KP02 C.094)	Link - Number of connected cards	1
(KP02 C.095)	Link - Functions	1
(KP02 C.096)	Link - Room Temperature and Humidity	1
(KP02 C.097)	Link - Outside Temperature and Humidity	1
(KP02 C.098)	See tables below	1
(KP02 C.100)	On = Option Bi-Speed of the blower	1
(KP02 C.101)	On = Option Regulation all seasons	1
(KP02 C.102)	On = Option optimised defrost	1
(KP02 C.103)	On = Option Enthalpy and management of the humidity	1



Configuration table LF20

F.A050	11	FXA025	20	F.K050	111	FXK025	120
F.A060	12	FXA030	21	F.K060	112	FXK030	121
F.A070	13	FXA035	22	F.K070	113	FXK035	122
F.A085	14	FXA040	23	F.K085	114	FXK040	123
F.A100	15	FXA055	24	F.K100	115	FXK055	124
F.A120	16	FXA070	25	F.K120	116	FXK070	125
F.A140	17	FXA085	26	F.K140	117	FXK085	126
F.A160	18	FXA100	27	F.K160	118	FXK100	127
F.A190	19	FXA110	28	F.K190	119	FXK110	128
		FXA140	29			FXK140	129
		FXA170	30			FXK170	130

Switches on KP01

- 1 = on Option : pressure pick-up on air 500 pa (on FLEXY™ off = sensor 1000 pa)
- 2 = on | 3 = off Option : hot water coil
- 2 = off | 3 = on Option : electrical heater
- 2 = on | 3 = on Option : gas burner
- 4 = on Option : cycle reversing valve, compressors (heat pump)
- 5 = on Option : heating of great power / or / pump (except freezing of the hot water coil)
- 6 = on Option : fresh air, economiser
- 7 = on Option : fresh air, all fresh air
- 8 = on Option : KP02 / KP17



This display unit allows you to operate 1 to 8 machines. The icon and schematic display provides a vivid and user-friendly interface. It uses a liquid crystal monochrome display, with background lighting, consisting of 240 x 128 pixels. It has 2 LEDs and 12 keys.

The remote console must be connected to the unit using a 4 x 0.5 mm² braid-screened cable (maxi length is 1000 m).

Plan the console electric supply in 230V/50Hz (500 mA)

On the unit, connection to the KP01 card J18 input will be done with connection items (screws...) delivered with the console.

ITEMS :

- 1 LCD SCREEN, 240x128 PIXELS, MONOCHROME, BACKGROUND LIGHTING
- 2 5 KEYS FOR FIXED FUNCTIONS
- 3 7 "SCREEN" KEYS FOR VARIOUS FUNCTIONS
- 4 "ON" LED
- 5 "GENERAL ALARM" LED.

The main display unit functions are as follows :

- Control of a range of interactive screens allowing access to all information and control data.
- Continual resetting of all dynamic parameters displayed in the various screens.
- Recording of successive status of pre-defined variables to create analog and event histories.

A KP07 unit can be attached to more than 8 LENNOX Rooftops, providing they have the same software.

The link between the controllers and the display is serial and uses the JBUS protocol. After being connected, the unit tries to establish communication with the specified machines. If, after 3 attempts, the unit cannot communicate with the Rooftop(s), the latter will be "disconnected". The connection failure is displayed on the screen and recorded in the event history. The display unit will then try to re-connect at regular intervals.

NOTE : To adjust the screen contrast, please consult the end of this part.

1 - SCREEN KEYS WITH VARIABLE FUNCTIONS (figure 68)



Figure 68

There are 7 keys located around the LCD screen :



The function of these keys may vary from one screen to another and is defined on the active screen by an icon. In the case of keys [1], [2], [3] and [4], the icon is displayed above the key. For the 3 other keys [A], [B] and [C], the icon appears to their left.

Each key allows you to :

- Proceed to another screen, or
- Write a value in a given variable.



2 - FIXED KEYS (FIGURE 69)

The functions of these 5 keys are fixed :



PAGE DOWN :

Moves to the next page of the same screen type.



PAGE UP :

Returns to the previous page of the same screen type.



STRUCTURE :

Returns to the first screen (showing the structure).



PREVIOUS SCREEN :

Returns to the screen previously displayed



MODIFICATION :

Pressing on this key activates the "modification" mode (see below).

3 - ON (LED 4 - figure 69)

When lit, it indicates that the machine is powered up.

4 - GENERAL FAULT (voyant 5 - figure 69)

This LED indicates a general fault has been detected.

5 - "MODIFICATION" MODE

This mode allows you to change the values of all the variables displayed on the active screen. It uses the 4 keys "1", "2", "3" and "4" by attributing preset functions to them :

KEY / ASSOCIATED ICON



Selects the variable to be changed



Selects the number to be changed

(By pressing successively on the key the cursor will move from digit to digit, from right to left, then the cursor remains on the last digit of the value to be changed.)



Increases the number from 0 to 9



Confirms the current change.

Through "MODIFICATION" mode, the user is able to :

- choose the number of the controller he wishes to see the variables of (if several LENNOX Rooftops are attached to the same KP07 display unit),
- control the setpoints.

To exit "MODIFICATION" mode and return to the active screen, press the "MODIFICATION" key.

Note :

- During modification, the screen is no longer updated.
- If a change is not confirmed, the variable will retain its previous value.

CONTRAST SETTING

The display contrast can be set in "MODIFICATION" mode :

- Pressing successively on key **[A]** increases the contrast.
- Pressing successively on key **[B]** decreases the contrast.
- Key **[C]** allows you to find the default contrast.



GENERAL SCREEN LAYOUT

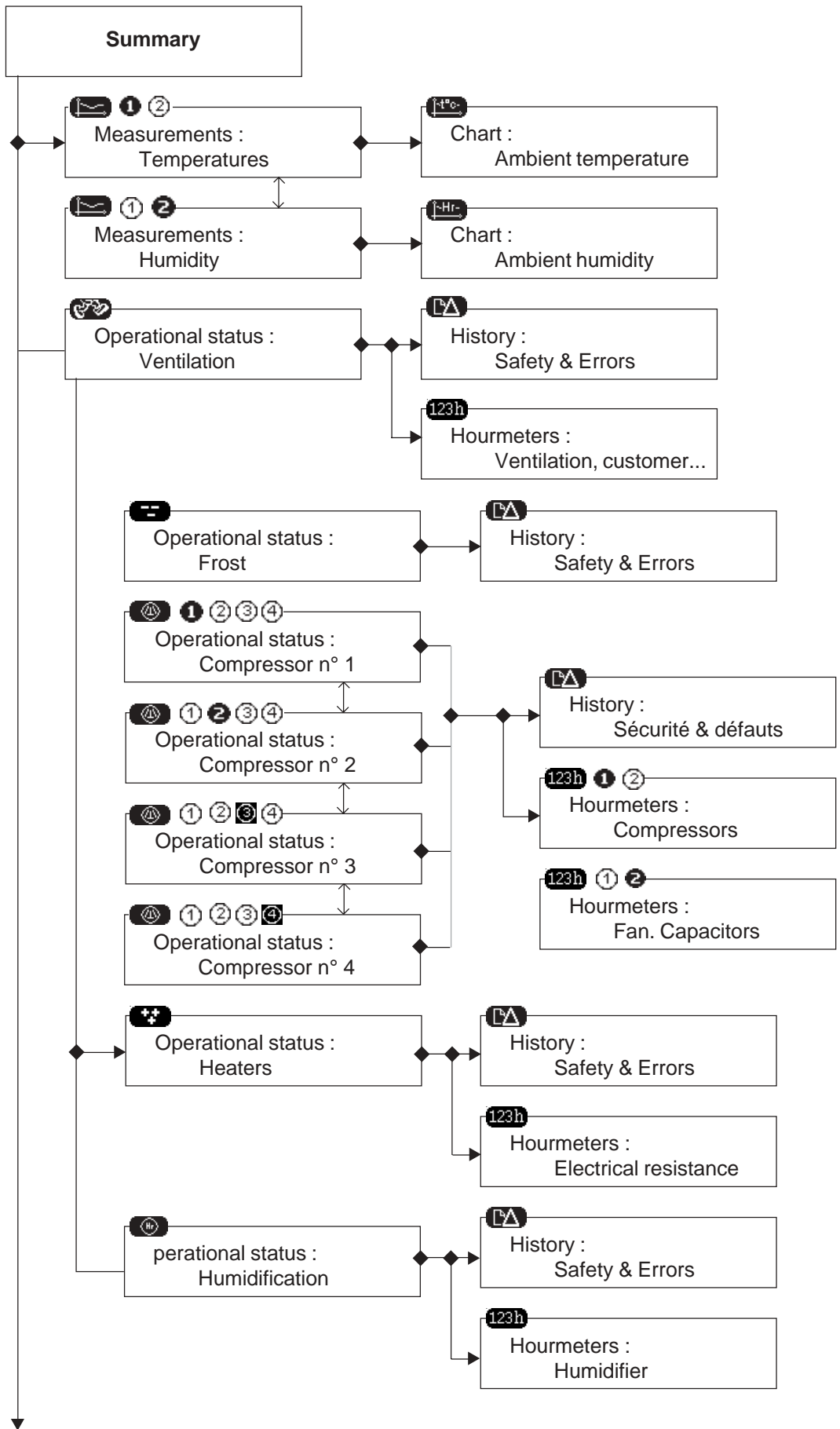

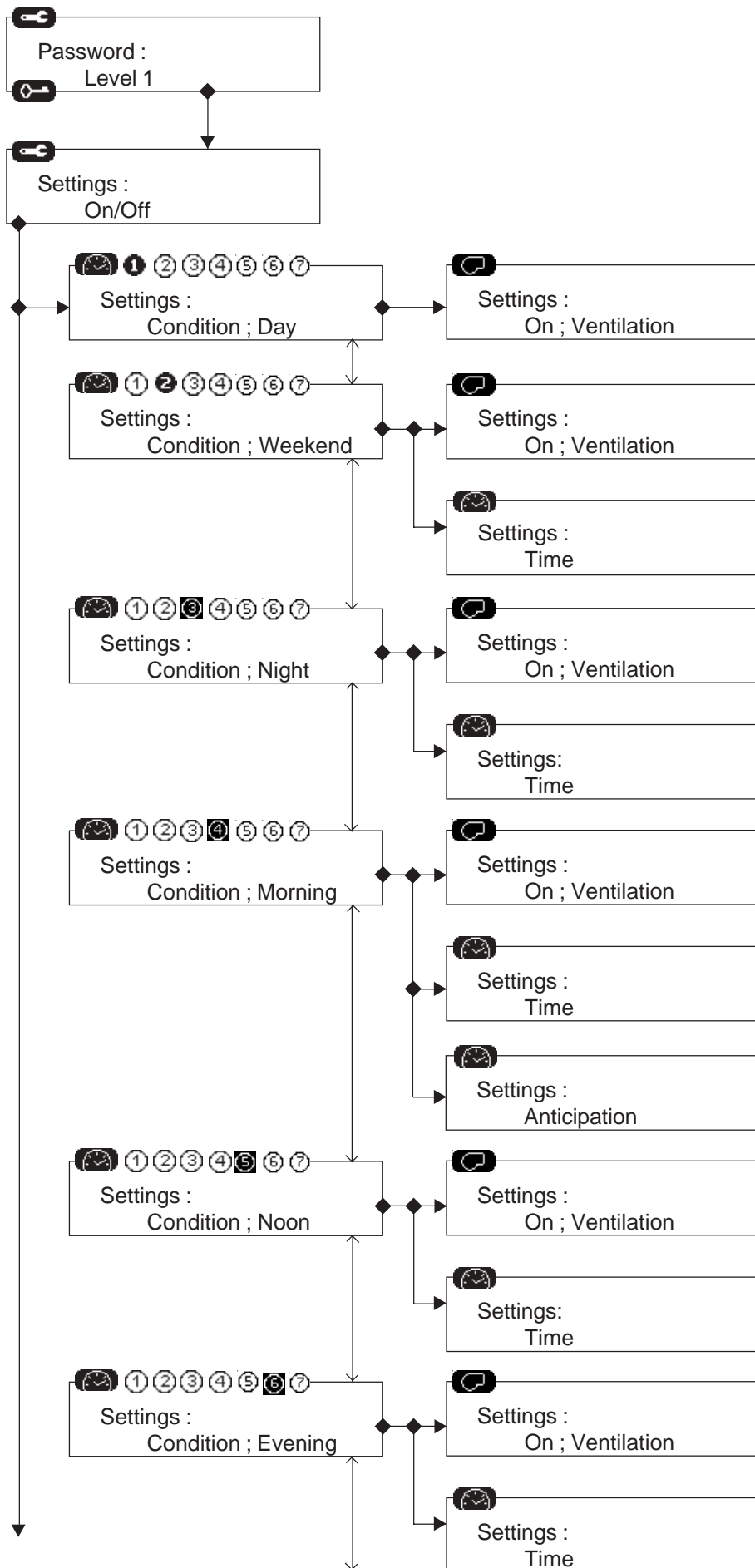

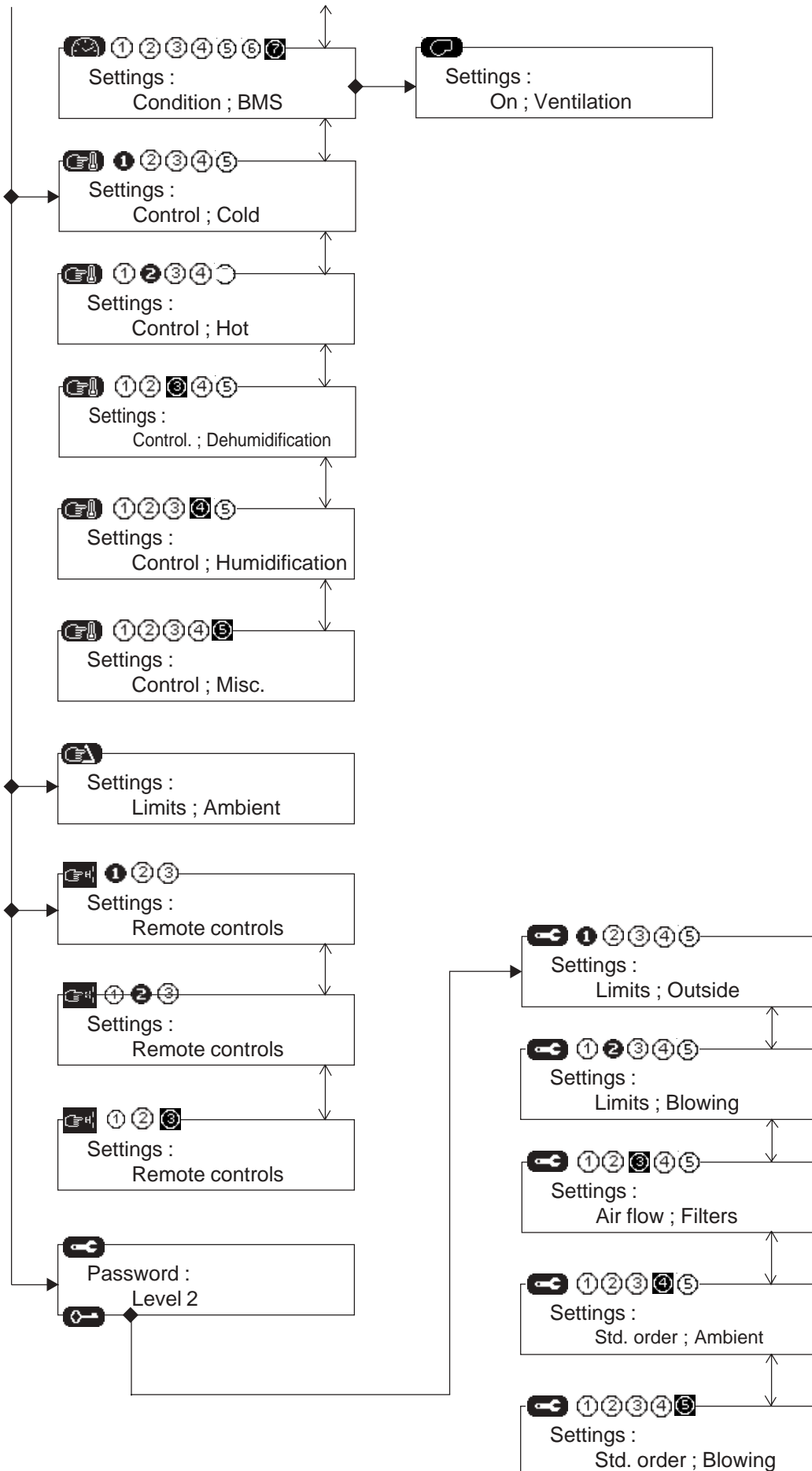



INDEX OF ICONS

Keys







	Select variable to change
	Select digit to change.
	Increase value
	Enter current change.
	Go to temperature and humidity values and charts.
	Go to the machine component status.
	Go to various notices.
	Go to room temperature chart.
	Go to room humidity chart (Flexy only)
	Reset errors and error meters.
	Go to error history.
	Go to operation hourmeters.
	Go to frosting component status.
	Go to compressor and condenser operational status.
	Go to heating devices operational status.
	Go to humidifier operational status (Flexy only)
	Enter password.
	Go to operational condition settings.
	Go to control settings.
	Go to safety settings.
	Go to On/Off and Discharge settings.
	Go to fan On/Off settings.
	Go to anticipation settings.

Logging on







	Log on password to go to settings.
	Log on date and time.













Sensors

	Temperature sensor
	Humidity sensor
	Pressure sensor
	Return or room data
	Supply data
	Outside data

Operating conditions

	Operating condition: Day
	Operating condition: Weekend
	Operating condition: Night
	Operating condition: Morning
	Operating condition: Noon
	Operating condition: Evening
	Operating condition: BMS

Operating status

	Cooling mode setting operation.
	Heating mode setting operation.
	Device in manual mode (prohibited under control)
	(On / Off) Customer option
	(On / Off) blower fan
	(High / Low) Ventilation speed (Flexy only)
	Filters
	(On / Off) Fresh air damper.
	(On / Off) Cold proportional valve, cold water battery
	(On / Off) Compressor



	Compressor defrosting.
	Compressor stopped in anti-short cycle.
	(On / Off) Condenser
	(On / Off) Gas grade.
	Half flow gas.
	(On / Off) Hot proportional valve, hot water valve.
	(On / Off) Electrical heaters.
	(On / Off) Humidifier
	(On / Off) Dehumidification
	(On / Off) Pump

Errors

	General alarm
	(Start / End) Communication interrupted between unit KP07 and a CPU board.
	(Start / End) [081][083][085][086][087][113] [123] [133] [143] Faulty temperature sensors.
	(Start / End) [082][084] Faulty humidity sensors (Flexy only)
	(Start / End) [112] [122] [132] [142] Faulty pressure transmitters (Flexy only)
	(Start / End) [013][022][096] Low temperature limit.
	(Start / End) [012][023][097] High temperature limit.
	(Start / End) [032] Low humidity limit (Flexy only)
	(Start / End) [033] High humidity limit. (Flexy only)
	(Start / End) [094] Error : only applicable to customer.



(Start / End) [091]
Faulty processing fan.



(Start / End) [001]
Wrong air flow.



(Start / End) [099]
Error smoke.



(Start / End) [004]
Dirty filters.



(Start / End) [005]
Missing filters.



(Start / End) [115][125][135][145]
Faulty high pressure or faulty electrical compressor.



(Start / End) [117][127][137][147]
Faulty low pressure compressor.



(Start / End) [092][093]
Faulty condensers.



(Start / End) [098]
Faulty water flow. (Flexy only)



(Start / End) [041]
Faulty pump. (Flexy only)



(Start / End) [011]
Faulty electrical batteries.



(Start / End) [014][015]
Faulty gas burner.

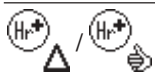

(Start / End) [031]
Faulty humidifier. (Flexy only)



This option is used for making a connection to the BMS only, by a set of hard contacts. It requires the addition of a KP05 card, if this is not already in place, and a KP12 card. Input connection must be by screened cable only.

Limits of relays :

- 10A – 250V with resistive load
- 4A – 250V with inductive load.

DRY CONTACT KIT FOR BMS / REMOTE SET POINT

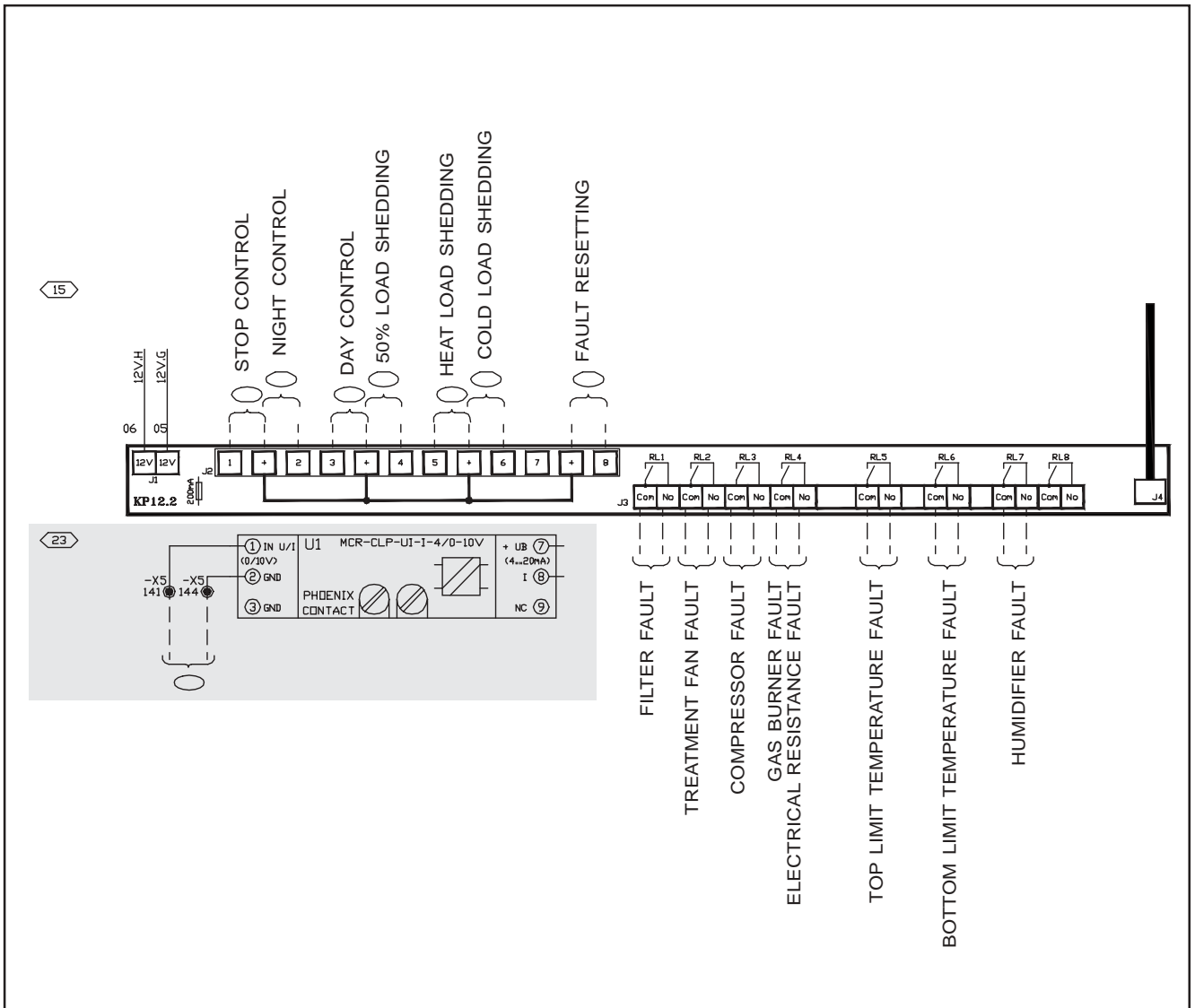



ON - OFF

The unit is declared On if setpoint 6 (C06) is ON.
 The unit can be stopped by a remote control command by hard contact.
 On KP12 extension card - see chapter on BMS contact kit.





DEFINITION OF TIME SLOT PARAMETERS

The CLIMATIC™ allows you to programme 5 operating zones per day, in addition to an idle zone for the weekend.

Slot activation is :

- automatically controlled by the CLIMATIC™, if you have defined these time parameters for each slot
- forced manually by action on the controller (instructions 02/03 and 04 for KP02).
- forced by the BMS contacts kit (see this chapter).
- forced by the computer connection.

The five available time slots are :

-  **WEEK-END**
-  **NIGHT**
-  **MORNING**
-  **NOON**
-  **EVENING**

If none of the time slots listed above is active, the active slot is :

-  **DAY**

A particular time slot :

-  **BMS** is activated if the unit is connected to a computer network.

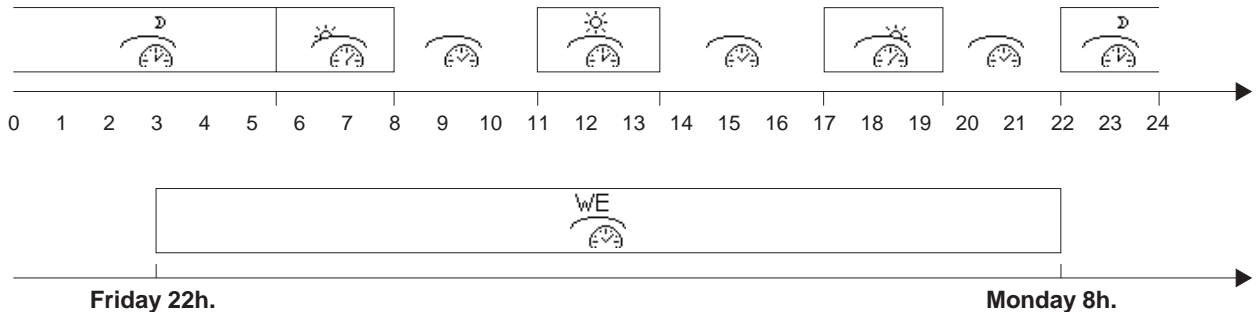

With the KP07 :

- Go directly to the screen concerning the time slot to be modified, enter the parameters described below on the screen (see organisation of screens in KP07chapter).

With the KP02 :

- The slot to be set up must first be defined by the 08 instruction. Enter the information below then return to the 08 instruction to go to the next slot.



DESCRIPTION OF PARAMETERS

Parameters are defined for the time slot. Select by instruction 08 setting.

0 = DAY / 1 = WEEKEND / 2 = NIGHT / 3 = unused / 4 = MORNING / 5 = MIDDAY / 6 = EVENING / 7 = BMS.

Instruction	Description
09	Day of the week of start of setting . From 1 to 7, 1 = Sunday.
10	Hour of start of setting
11	Minutes for start of setting
12	Day of the end of setting
13	Hour of end of setting
14	Minutes of end of setting
15	Setpoint in heating
16	Setpoint in air conditioning
17	Defined if the hygrometry values below are taken as absolute (ON) or relative (OFF).
18	Minimum relative humidity of ambient air (%)
19	Maximum relative humidity of ambient air (%)
20	Minimum absolute humidity of ambient air (g/kg of dry air)
21	Maximum absolute humidity of ambient air (g/kg of dry air)
22	Relative value of minimum flow of new air (%)
23	Fan operation in regulation zone *. ON OFF
24	Fan operation in neutral zone*. ON OFF
25	ON, forces low speed fan operation in the cooling zone
26	ON, forces low speed fan operation in the neutral zone*.
27	ON, forces automatic low speed operation in heating zone
28	Low noise
29	Instruction used to force operation in the current setting

* The regulation zone is defined for a temperature less than the heating instruction or greater than the air-conditioning instruction. The neutral zone is between these 2 values.

NOTE : The end of the night slot night is defined by the start of the morning slot : this is why there is no need to define the end of the night slot in the table below

Setpoint value for KP02	DAY = 0	WEEK-END = 1	NIGHT = 2	MORNING = 4	MIDDAY = 5	EVENING = 6	BMS = 7
9	-	7	-	-	-	-	-
10	-	22	22	6	12	19	-
11	-	0	0	0	0	0	-
12	-	2	-	-	-	-	-
13	-	6	-	6	12	19	-
14	-	0	-	0	0	0	-
15	23.0	30.0	30.0	23.0	23.0	23.0	23.0
16	19.0	10.0	10.0	19.0	19.0	19.0	19.0
17	Off	Off	Off	Off	Off	Off	Off
18	0	0	0	0	0	0	0
19	100	100	100	100	100	100	100
20	0.0	0.0	0.0	0.0	0.0	0.0	0.0
21	30.0	30.0	30.0	30.0	30.0	30.0	30.0
22	20	0	0	0	20	20	20
23	On	On	On	On	On	On	On
24	Off	Off	Off	Off	Off	Off	Off
25	Off	Off	Off	Off	Off	Off	Off
26	Off	Off	Off	Off	Off	Off	Off
27	Off	Off	Off	Off	Off	Off	Off
28	Off	Off	Off	Off	Off	Off	Off
29	Off	Off	Off	Off	Off	Off	Off



ADVANCE ACTIVATION OF THE MORNING SLOT

Depending on the thermal inertia of the building or the installation and external climatic conditions, it is possible to advance the switch from the NIGHT slot to the MORNING slot.

The time advanced, in minutes, is calculated using the following formula :

Time advanced = (gradient start temperature) x inertia coefficient

For example :

- Outside temperature 0 °C
- Gradient start temperature set to + 10 °C (i.e. below 10°C outside, you want to advance start-up)
- Inertia coefficient set to 12
- Start of Morning slot set to 8h30

In these conditions the switch to the morning slot will be advanced by: $(10 - 0) \times 12$ i.e. 120 min.

The installation will therefore start up at 6h30 instead of 8h30.

REGULATION OF AMBIENT AIR

Two power factors, one for cooling (variable 72), the other for heating (variable 73), are calculated according to the difference in temperature between the Setpoint and the reference temperature.

The progression of these cooling or heating power factors is limited by the temperature hysteresis and the activation differentials between 2 stages.

If the hysteresis value is 0, the power factor concerned is no longer limited.

See below for setting hysteresis and activation differentials.

The power factors are periodically recalculated by the CLIMATIC™. The integration time (setpoint 52) is adjustable. This parameter should depend on the air agitation ratio of the unit and temperature variations in the sector to be air conditioned.

ORDER OF COMPONENTS IN REGULATION

Heating operation

Setpoint 57 = ON

Water coil or electric coil or gas → Compressors

Setpoint 57 = OFF

Compressors → Water coil or electric coil or gas

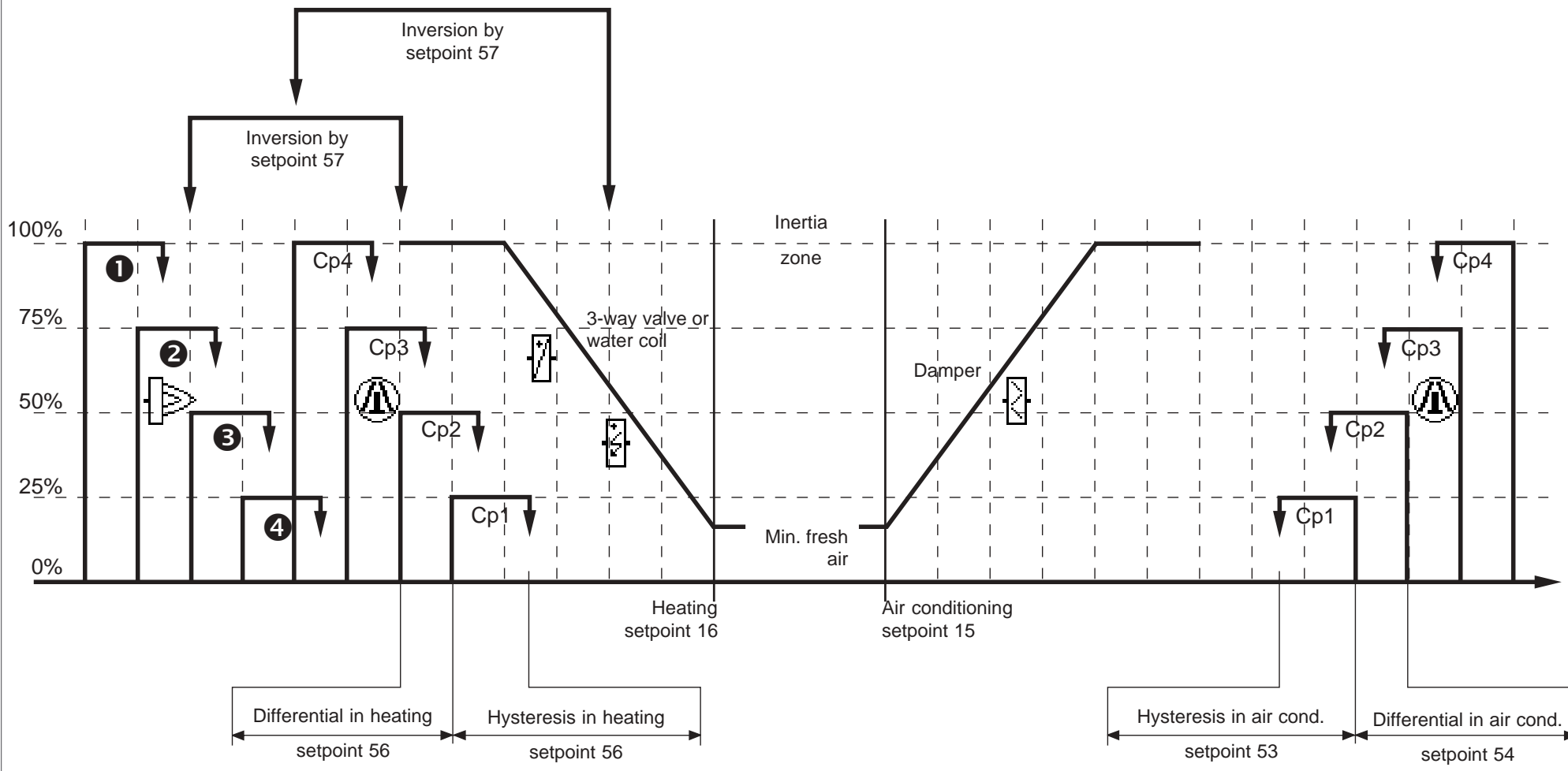

- ❶ : Gas 2 + Gas 1
- ❷ : Gas 2 + 1/2 Gas 1
- ❸ : Gas 1
- ❹ : 1/2 Gas 1

Cp1...Cp4 : Compressor no. 1...4

Figure 79





REGULATION OF SUPPLY AIR

Supplying air regulation should be activated by setting setpoint 58 to ON.

The main aim of supplying air regulation is to maintain the temperature of supplied air at a value close to the average of the neutral zone, if ambient air regulation is not active.

Two power factors, one for cooling (variable 75), and the other for heating (variable 76), are calculated according to the difference in temperature between the setpoint and the reference temperature.

The power factors are periodically recalculated by the CLIMATIC™. The integration time (setpoint 59) is adjustable

BLOWING REGULATION BY AIR DAMPER

The aim of air supplying regulation by the air damper is to even out the temperature of supplied air to a value close to the average of the neutral zone.

This function is not taken into account if blowing regulation is active.

A power factor is calculated according to difference in temperature between the setpoint and the ambient and outside temperatures.

The progression of the power factor is limited by the maximum percentage of fresh air (setpoint 72) if the outside temperature is less than the minimum outside air temperature (setpoint 71).

ORDER OF COMPONENTS IN REGULATION

Heating operation

Setpoint 60 = ON
Water coil or electric coil or gas → Compressors

Setpoint 60 = OFF
Compressors → Water coil or electric coil or gas

REGULATION IN HUMIDITY

Two power factors, one for dehumidifying (variable 79), the other for humidifying (variable 80), are calculated according to the difference in relative hygrometry between the setpoint and the reference relative hygrometry.

The power factors are recalculated periodically by the CLIMATIC™. The integration time is adjustable (setpoint 63).

REGULATION IN DEHUMIDIFYING

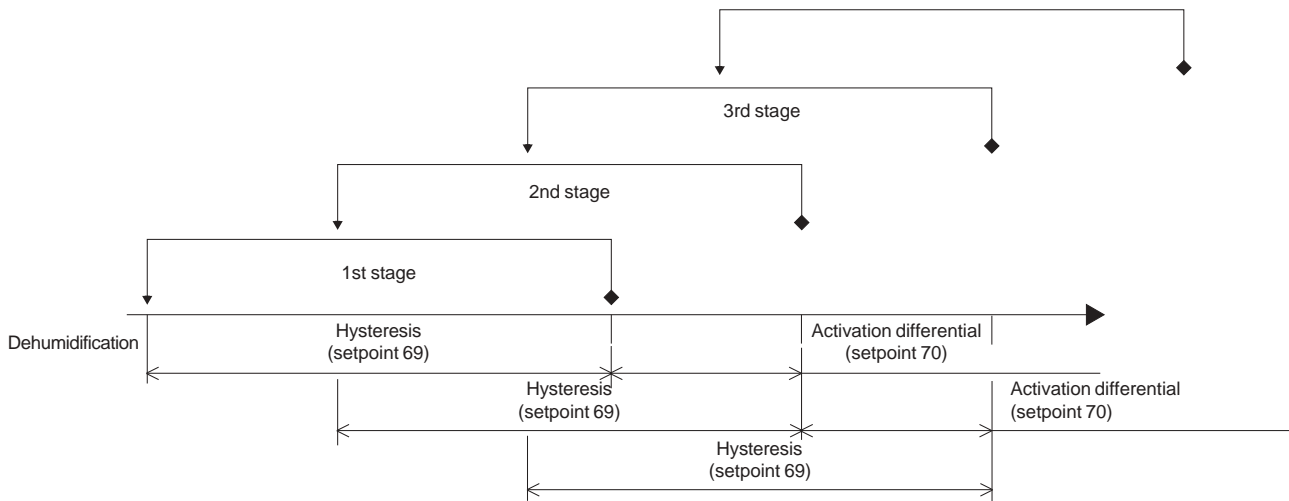



REGULATION IN HUMIDIFYING

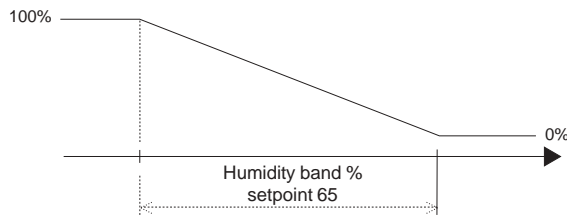

SETTING THE FRESH AIR MINIMUM

The minimum value for opening the damper to outside air can be set by instruction (see configuration of operating zones). This value is expressed directly as a percentage.

CO² SENSOR

Where a CO² sensor is connected to the unit, the value of the fresh air minimum is calculated according to the CO² ratio. The value measured by the sensor can be read in variable 17.

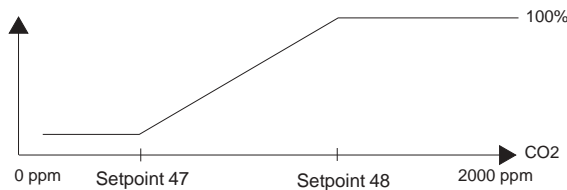

Setpoint 47 defines the number of ppm up to which the fresh air minimum is still achieved.

Setpoint 48 defines the number of ppm from which 100% fresh air is used.

ENTHALPY FUNCTION

This function is used to control the use of the economiser register according to air enthalpy. If the outside hygrometry is greater than the inside hygrometry, the respective enthalpy values are then calculated. According to the result obtained, input of new air is optimised.

COMPRESSOR-RELATED FUNCTIONS

Anti-short cycle

The CLIMATIC™ provides protection of the compressors against frequent restarts. This is why the compressors cannot be started, even if requested to do so by regulation, unless the time since they were last put into operation is greater than six minutes.

Equalisation of compressor operating times (F series)

The CLIMATIC™ program is organised to equalise compressor operating times

Defrost function

For heat pump units and air condensation units, cycle inversion phases are programmed for defrosting the outside coil.

Defrosting is activated depending on :

- outside temperature (limit set by setpoint 76),
- coil temperature (limit set by setpoint 77),
- with overall weighting by an icing constant (setpoint 78).



It is possible to connect up to 12 CLIMATIC50 with Climalook2 or 8 rooftops equipped with CLIMATIC2 and 12 with CLIMATIC 50 when Climalook 3 or Climalink is installed.

to have a local display of the installation. It can be connected to up to 12 CL50 controller via a RS485 interface.

CLIMALINK 2

This product consist in a central unit and a communication interface.
 This unit is designed to be connected to a maximum of 12 rooftops fitted with CLIMATIC 50 controllers via a RS485 interface. A connection diagram is provided in the box.
 The central unit must be installed in a dry, secured location.
 Once the unit is connected and powered up, it is entirely automatic and does not require a screen a keyboard or a mouse. After a power failure, the central unit must be restarted using the ON/OFF button.
 To avoid this Lennox recommend to connect the central unit to a pulsating current power outlet or "UPS". Lennox cannot be held responsible in the event this recommendation is not acted upon.

CLIMALOOK 3

Climalook 3 provides the same features as Climalook 2 as it can be connected to 12 rooftops equipped with CLIMATIC 50 controller but it can also be connected to 8 rooftops fitted with CLIMATIC2 controller and KP01 board (Flexy and Linea already on site).

NOTE: In order to connect a unit fitted with CLIMATIC2 you must ensure that the program version is at least LF20. Otherwise it must be upgraded to LF20 before connection to Climalook 3

Climalook uses the internet explorer interface for local operation. The local operating mode is completely automatic and does not require any configuration. Like Climalink, Climalook can receive remote queries thanks to its internal modem and an analogue telephone line.
 Climalook and Climalink do not work with ISDN telephone lines.

CLIMALOOK 2

This product is identical to the CLIMALINK 2 but it is equipped with a 15inch TFT flat screen, a mouse and a numeric keypad

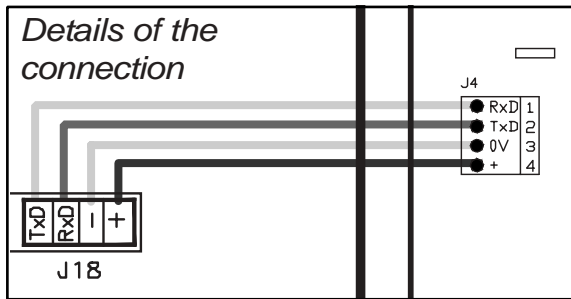
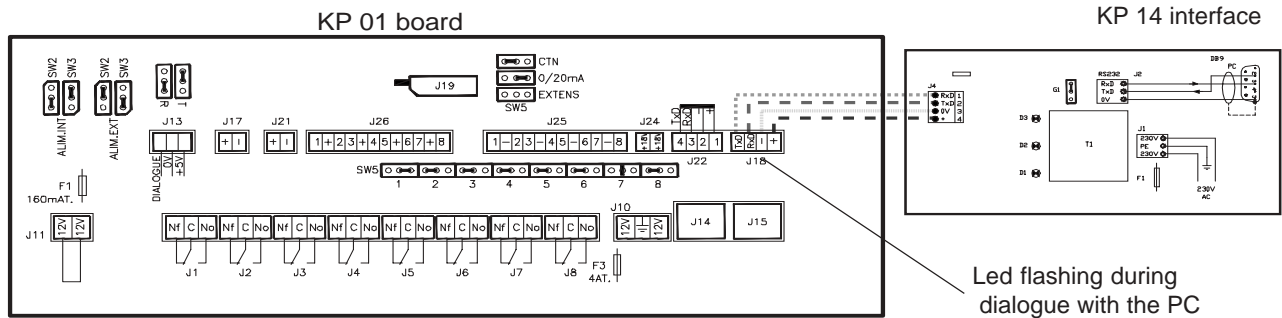

NOTE : To function correctly each RTU requires an address to be set using a KP02 (setpoint 91).
 To register in the climatic the power to the climatic must be switched off twice after entering the value.

Whenever the power is switched on it is necessary to wait 5 minutes after the welcome page is displayed to allow the software to fully update.

CONNECTION TO CLIMATIC2 AND KP01 BOARD

The connections between the units and the Climalink/ Climalook must be done using a double shielded pair of wire (not supplied by Lennox) This cable must have external metal braiding, and its cross-section must be at least 0.5mm² with a maximum of 1mm²

Each cable will be connected to the COM B port on the KP01 Board, and particular attention must be taken to the order of connections. The cable coming out of the KP14 with a BD9 plug at the end will be connected to the SERIAL Port at the back of the central unit.

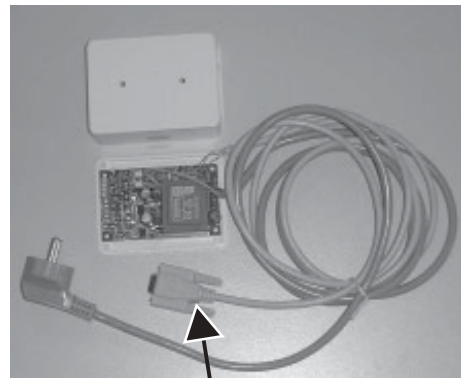

The cable coming out of the KP14 with a BD9 plug at the end will be connected to the SERIAL Port at the back of the central unit.



CONNECTION TO CLIMATIC™ 50 USING INTERFACE 435/232

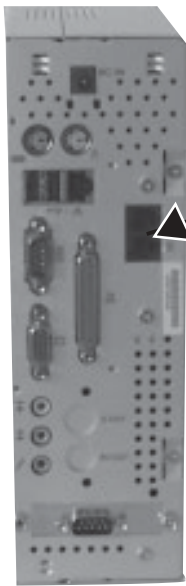

Plug for telephone link RJ11. Cable supplied with the unit.

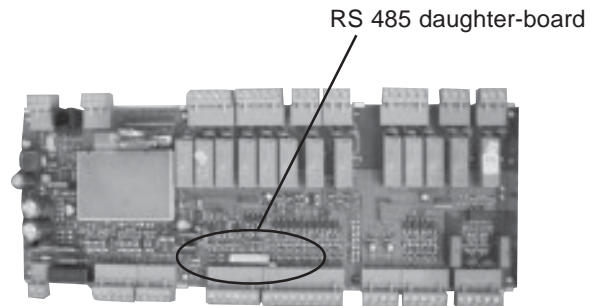

It is possible to connect up to 12 rooftops fitted with CLIMATIC 50 when using a Climalook 3. The connections between the units and the Climalink/Climalook must be done using a double shielded pair of wire (not supplied by Lennox) This cable must have external metal braiding, and its cross-section must be at least 0.5mm² with a maximum of 1mm²

After the starting procedure of the Climalook 3 central unit, the LED next to the B PORT on the CLIMATIC KP01 board will start to flash. The CPU connects to the boards one after the other, and so it is normal for the LED to stop flashing occasionally.

When all the connections are established, press the on/off button. The programs are launched automatically, and the LED located to the right of the Com B on the CLIMATIC KP01 board should flash.

Note the site telephone number in order to make the remote query.

The wires will be connected to each CLIMATIC50 485 ports You must ensure the connection order is correct :

- + on +,
- on -
- and gnd on gnd.

Note the site telephone number in order to make the remote query

The cable terminated by a DB9 plug, coming out of the 485/232 interface will be connected to the SERIAL port on the Climalook central unit

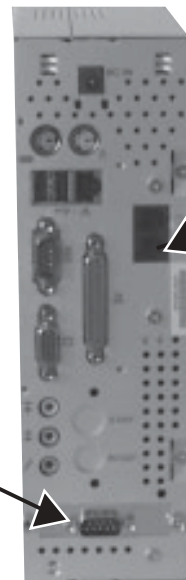

Plug for telephone link RJ11. Cable supplied with the unit.

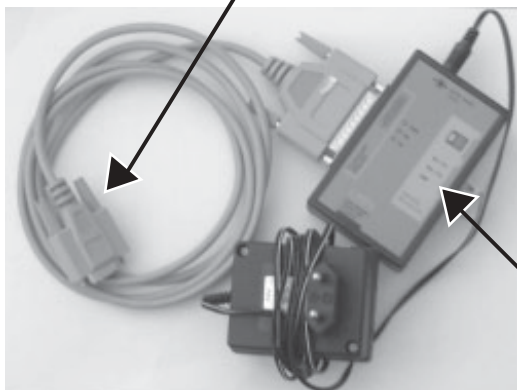

After the starting up procedure is completed the LED on the INTERFACE will start flashing.



SETTINGS FOR THE CONNECTIONS

Depending on the version of Windows you are running, access the « Make new connection » function.

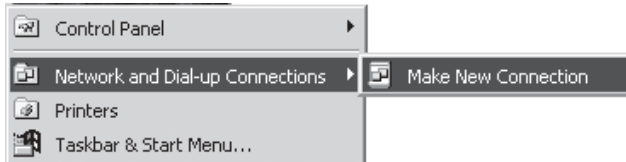

Click on next

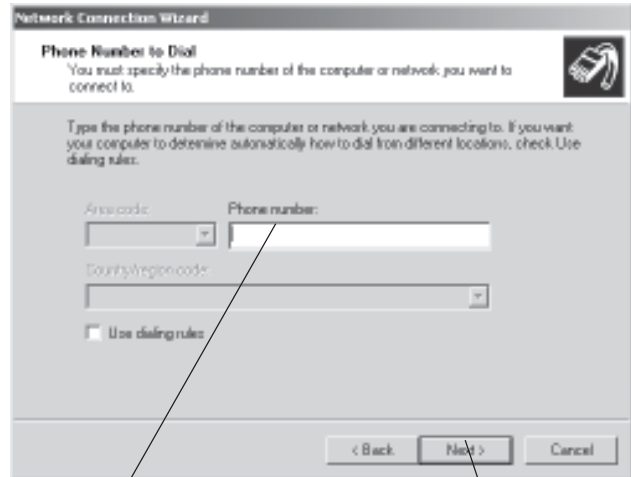

Enter the telephone number to which your ClimaLook's modem is connected.

Click

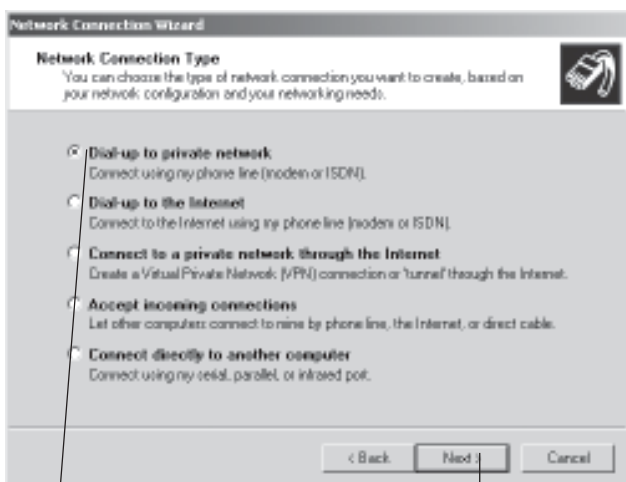

Click

Click on next

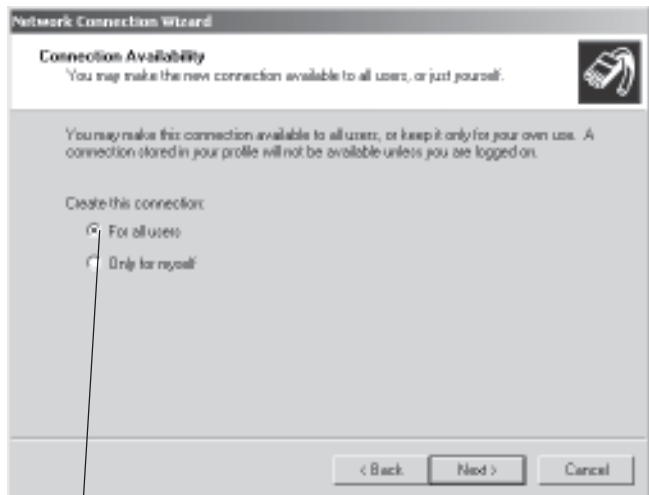

Click



Enter the site name

Click on Finish



Type "http:// Lennox" in the Address field

The first time you log in, Windows asks you to confirm your login identifiers:

- for User enter **Administrateur**
- for password enter **VISION**
- leave the workgroup field empty.

After this formality, you gain access to:

THE WELCOME PAGE

First of all you must lower the virtual keyboard window, before choosing the language.

NOTE : To operate the program it is necessary to minimise the virtual keyboard.

Then click on the flag corresponding to the language you want to use.

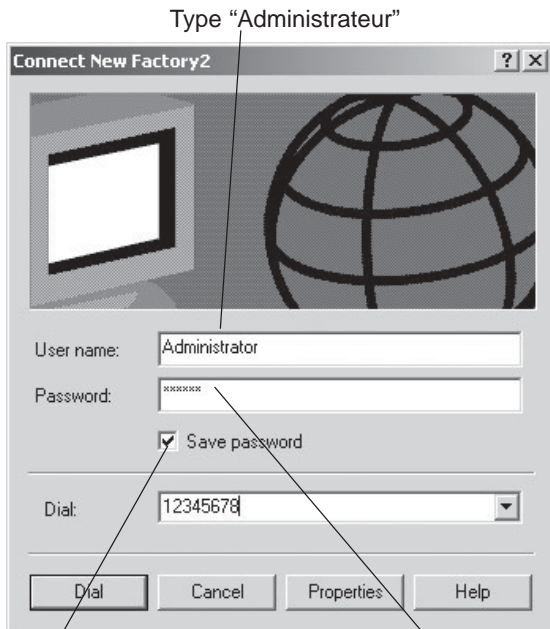

Type "Administrateur"

Click

Type "VISION"

The modem dials the number, and then the two modems hook up.

In the task bar next to the time display you should see the symbol indicating connection with the remote computer.



On some versions of Windows, a dialogue box may ask you to enter the password again. In this case :

- for User enter Administrateur
- for password enter VISION
- leave the workgroup field empty.

You can now start Internet Explorer.



Enter your access code and confirm. The access code **999** serves as a temporary code until you have configured your own security code.

If your code is valid you will access the next menu. Otherwise you remain on the same page.

There are three access levels :

- 1st level : use of the User, Schedule, Macro and History pages.
- 2nd level : ditto, plus the Service page.
- 3rd level : ditto, plus the Access page.

If the local application is not functioning, it is possible you may remain on the same page, even if your access code is valid. In this case, it is necessary to first restart the local central unit before continuing.



THE MAIN PAGE

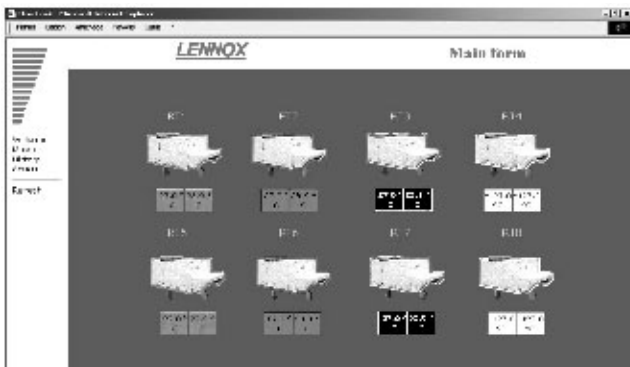

The colour outline around the roof-top unit and the operating temperatures indicate the unit's status:

- Green : Operating mode,
- White : Stop mode,
- Orange : Night mode,
- Red: Fault mode,

This page gives you the basic information about how your installation functions. The roof-top unit's number corresponds to its EPROM number.

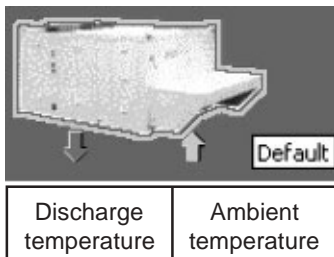

Position the mouse on one of the units to obtain information indicating this unit's status.

If the unit does not exist, is not powered up, or if communication with it is impossible, its icon disappears from the screen. The program attempts to communicate with absent units every ten minutes.

To access a unit's operating details, just click on it once. 20 seconds automatic refresh on this screen.

THE USER PAGE

This is the page used most frequently. It enables you to display and modify a number of settings on your unit.

Use the refresh function to update the values read.

Some settings are read-only, others can be modified.

Read-only setting :



Modifiable setting :



Unit's day and time

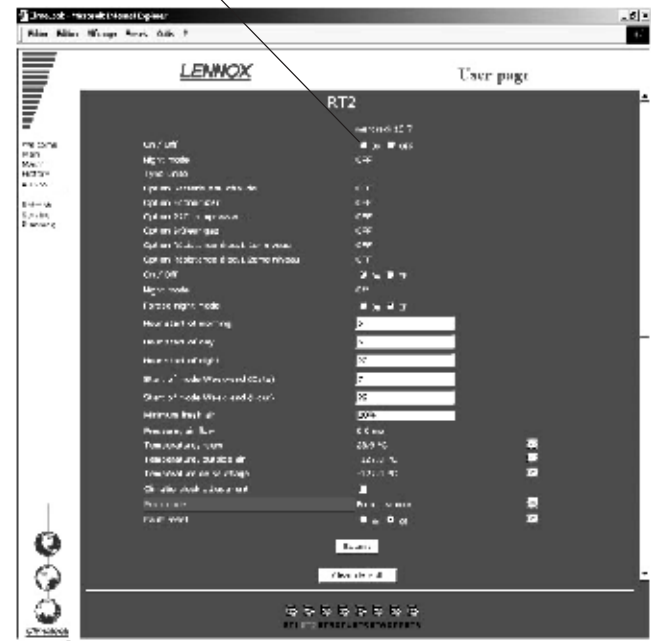

The bottom of the page displays the unit currently being queried, and can also be used to change the unit by clicking. This takes you to the user page for the new machine. If the unit does not exist, is not powered up, or if communication with it is impossible, its icon disappears from the screen. The program attempts to communicate with absent units every ten minutes.

It is possible modify several settings at the same time.

The settings will only be modified if the «submit» function is confirmed.



If your unit has - or had - a fault, it is outlined in red on the main page. You can use the fault module to trouble-shoot:

If the fault is still present, it is displayed here :

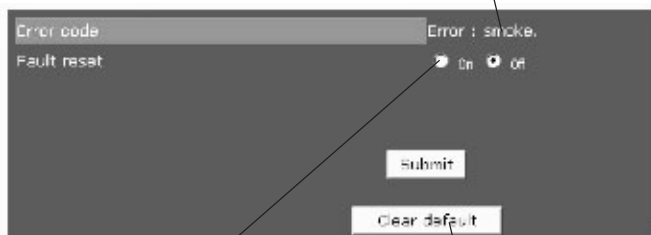

The fault reset function is used to clear the unit's errors if this is possible. If the error persists, the fault returns.

The clear default function is used to reset the software memory of defaults. It does not erase the unit's faults.



For some settings, a small icon is displayed at the end of the line
Click on it to get a history of this setting.



The empty fields correspond to occasions when the CLIMALOOK / CLIMALINK unit has stopped

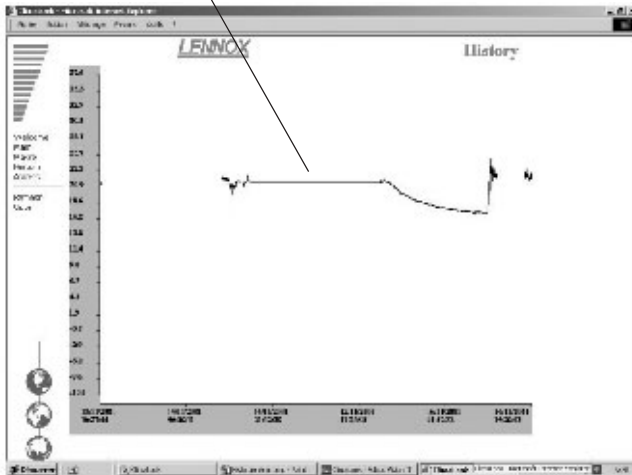

Use the refresh function to update the values read



- To access the Service page for another unit, simply click on this unit.
- To return to the User page, click on the User menu.
- To access the Schedule page, click on the Schedule menu.

+ Supply temperature / Room temperature / Outdoor air temperature + Faults (last 10 days)

The menus :

Welcome	Welcome page
Main	Main page
Macro	Macro page
History	General History page
Access	Access codes page

Refresh	To refresh the values
Service	Service page or experienced user
Planning	Schedule page which shows all the set points for the different modes.

THE SERVICE PAGE

The Service page is for technical users who know exactly how to adjust air-conditioning units. It is protected by a second level password.

The units are presented in groups, and it is possible to display and modify several settings, as in the User page. The settings will only be modified if the «submit» function is confirmed.

THE SCHEDULE PAGE

This page is used to display and modify all the configuration settings for each zone of a unit's operating schedule. Use the refresh function to update the values read.

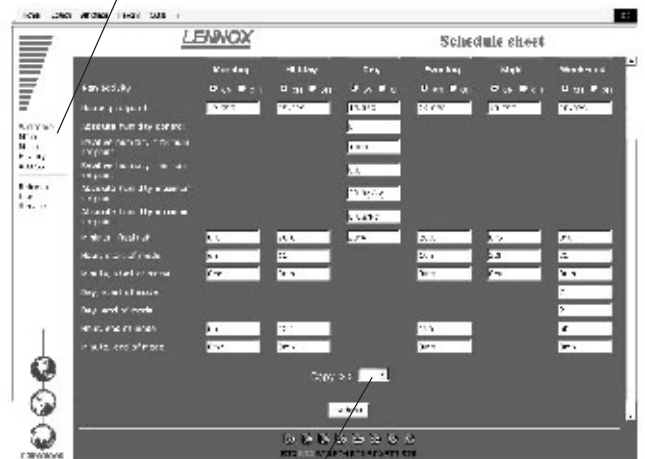

In addition it is possible to copy all the displayed settings and then paste them in another unit you have chosen.

The settings will only be modified if the «submit» function is confirmed.



THE MACRO PAGE

This page enables you to modify all the units on your site in one action.

You can choose to perform one or more actions. Modify the value or values you want to submit.

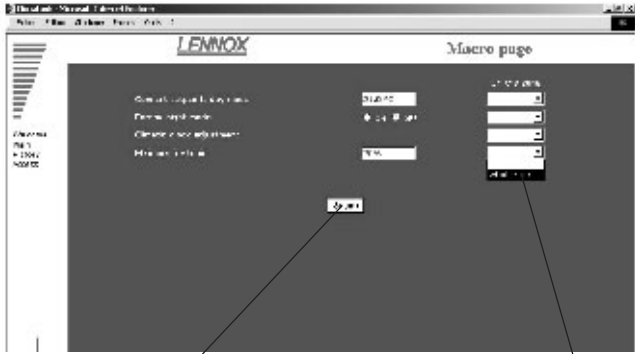

Click on "Submit"

Select "Entire site"

The standard Macros are :

- Adjust the Comfort thermostat
- Set to Night mode
- Set fresh air to the minimum
- Set the time on the Climatic boards.

THE HISTORY PAGE

This page is provided in addition to the individual history you've already seen in the User page. It tells you when local communication starts and stops, and gives you the users' access codes.

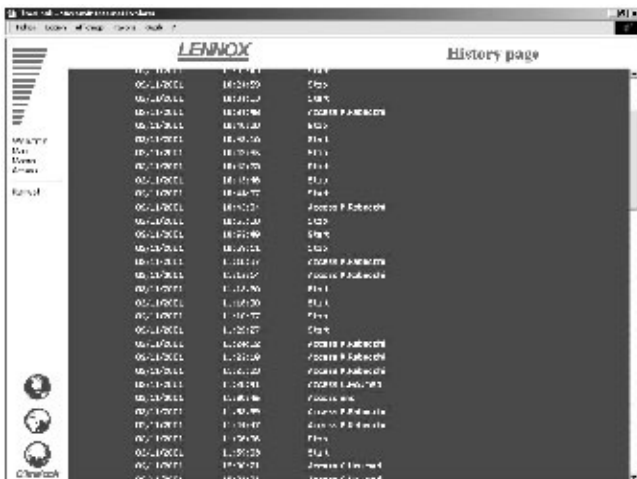

This is a read-only page. The history is automatically cleared to ensure refreshment doesn't take too long. This page will also show units faults.

THE ACCESS PAGE

This page enables users who have a third level access code to attribute access codes to other users.

The access code 999 is your first access code. Remember to delete it once you have created your own access codes.



To create a new user : Click on name



Use the virtual keyboard on the task bar

Use the keyboard to enter the name, password (maximum of 4 digits) and the access level.

- 1 = use of the User, Schedule, Macro and History pages.
- 2 = same level, plus the Service page.
- 3 = same level, plus the Access page.



Reposition the keyboard in the task bar by clicking on the minus sign in the top right-hand part of the keyboard.



Confirm by clicking on «Submit»

PROBLEM SOLVING

Impossible to enter your access code, you remain on the welcome page.

Local communication has been interrupted. You must restart the local unit.

After restarting, you must wait for 5 to 10 minutes until the unit is ready to be queried once more.

The values read do not seem to move.

The values are not in fact refreshed automatically, and for all the pages you must use the Refresh function to be sure you are reading the latest values.

The keyboard has disappeared from the task bar. Click on Start / Programs / StartUp



The local unit is not answering the phone.
 The local unit is - or was - powered down, and you must press the On/off button.
 See recommendations at the beginning of the document.
 The unit is not connected to a direct analogue phone line.

How to check the ClimaLink is functioning correctly after installation :

Connect up the unit and the KP14

Connect the cables to the J18 inputs on the Climatic boards. After a few minutes, the central unit should start its dialogue. The LED on the Climatic board to the right of the J18 input should flash.

If this does not happen, check the wiring.

The only way to examine the problem in more detail is to obtain a monitor and a mouse and contact the Lennox services.

After installing a ClimaLook or ClimaLink central unit, it is vital to perform the telephone communication tests.

Take a test telephone set and make sure you have a connection.

Note the telephone number to which the central unit is connected.

Connect the central unit and ask a person on the remote site to test communication.

Obviously the central unit must be the only device installed on the phone line. It cannot share the line with a fax or another modem.



The power cable should be connected to the main isolating switch and is fed from the underside of the unit into the electrical panel.

Refer to the general arrangement drawings in the documentation to locate the exact entry position.

The power cable sizes must be calculated with reference to the electrical characteristics of your machine.

We are unable to state the cross sectional area of the cable

as it is directly related to the type of cable you are using, the distance separating the equipment from the source but also various factors relating to the cable fitting.

In the following pages you will find references to electrical diagrams which will allow you to select the wiring for your equipment.

As the diagrams are valid for the entire range, they will refer to items not included in your scope of supply.

FUNCTIONS

FCA / FCK = Cooling only unit

01	-
02	Electric heater TRIAC
03	Hot water coil
04.1	-
05	Economiser
06	Extraction fan
07	All fresh air
08	Firestat
09	Smoke detector
0FC	Advanced control pack (FC : cooling - FH : heat pump)
11	Digital console KP02
12	Consoles KP07 or KP17
13	Hygiene probe
14	Air sock control
15	Dry contact kit (KP12.2)
16	RS232 KP14
17	CL06
18	KP07
19	Pump
20	Low ambient kit
21	-
22	-
23	Remote set point (KP05)
24	KP12.3 (TCB)
25	KP12.4 (Adaptvision)
26	Climalink/Climalook

FDA / FDK = Cooling only unit

01	-
02	-
03	-
04.2	Gas burner 33/60 kW
04.3	Gas burner 120 kW
04.4	Gas burner 180 kW
05	Economiser
06	Extraction fan
07	All fresh air
08	Firestat
09	Smoke detector
0FC	Advanced control pack (FC : cooling- FH : heat pump)
11	Digital console KP02
12	Consoles KP07 or KP17
13	Hygiene probe
14	Air sock control
15	Dry contact kit (KP12.2)
16	RS232 KP14
17	CL06
18	KP07
20	Low ambient kit
23	Remote set point (KP05)
24	KP12.3 (TCB)
25	KP12.4 (Adaptvision)
26	Climalink/Climalook



FHA / FHK = Heat pump rooftop

01	Heat pump
02	Electric heater TRIAC
03	Hot water coil
04.1	-
05	Economiser
06	Extraction fan
07	All fresh air
08	Firestat
09	Smoke detector
10FH	Advanced control pack (FC : cooling- FH : heat pump)
11	Digital console KP02
12	Consoles KP07 or KP17
13	Hygiene probe
14	Air sock control
15	Dry contact kit (KP12.2)
16	RS232 KP14
17	CL06
18	KP07
19	Pump
20	Low ambient kit
21	Intelligent defrost
22	-
23	Remote set point (KP05)
24	KP12.3 (TCB)
25	KP12.4 (Adaptvision)
26	Climalink/Climalook

FDA / FDK = Cooling only unit

01	Heat pump
02	-
03	-
04.2	Gas burner 33/60 kW
04.3	Gas burner 120 kW
04.4	Gas burner 180 kW
05	Economiser
06	Extraction fan
07	All fresh air
08	Firestat
09	Smoke detector
10FH	Advanced control pack (FC : cooling- FH : heat pump)
11	Digital console KP02
12	Consoles KP07 or KP17
13	Hygiene probe
14	Air sock control
15	Dry contact kit (KP12.2)
16	RS232 KP14
17	CL06
18	KP07
19	-
20	Low ambient kit
21	Intelligent defrost
22	-
23	Remote set point (KP05)
24	KP12.3 (TCB)
25	KP12.4 (Adaptvision)
26	Climalink/Climalook



FXA / FXK = Heat pump rooftop

01	Heat pump
02	Electric heater TRIAC
03	Hot water coil
04-1	-
05	Economiser
06	-
07	-
08	Firestat
09	Smoke detector
0FH	Advanced control pack (FC : cooling- FH : heat pump)
11	Digital console KP02
12	Consoles KP17
13	Hygiene probe
14	Air sock control
15	Dry contact kit (KP12.2)
16	RS232 KP14
17	CL06
18	KP07
19	-
20	-
21	-
22	All fresh air
23	Remote set point (KP05)
24	KP12.3 (TCB)
25	KP12.4 (Adaptvision)
26	Climalink/Climalook

DIAGRAM REFERENCE LEGEND

+A0	Climatic controller
+A1+A2	Condensation group 1 / Condensation group 2
+A3+A4	Condenser 1 / Condenser 2
-A1	
-B1	External air thermostat
-B2	Smoke detection head
-B3	RC circuit
-B4-B5	Gas manifold ionisation probe
-B6-B7	Gas manifold ignition electrode
-B11	Water flow rate controller

-B13	Clogged air filter pressure switch / air flow rate
-B14	Hot water battery antifreeze thermostat
-B15	Hot water battery antifreeze thermostat
-B16	Fire thermostat
-B17-B18	Gas manifold smoke minimum gas pressure switch
-B19-B20	Blower fan motor -MS1-MS2 stoptherme
-B21-B22	Gas manifold extraction air pressure switch
-B23-B24	Extraction fan motor -ME1-ME2 stoptherme
-B25-B26	Electric battery -E1-E2 safety klixon
-B27	Electric battery -E3 safety klixon
-B29-B30	Gas manifold air flow rate safety klixon
-B32-B33	Gas manifold flashback safety klixon
-B41-B42	Compressor -MG1-MG2 high pressure safety switch
-B43-B44	Compressor -MG3-MG4 high pressure safety switch
-B45-B46	Gas manifold 1 / gas manifold 2 regulation klixon
-B51-B52	Compressor -MG1-MG2 low pressure safety switch
-B53-B54	Compressor-MG3-MG4 low pressure safety switch
-B61-B62	Compressor -MG1-MG2 high pressure control switch
-B63-B64	Compressor -MG3-MG4 high pressure control switch
-B71-B72	Condenser -MC1-MC2 fan motor stoptherme
-B73-B74	Condenser -MC3-MC4 fan motor stoptherme
-B81-B82	Scroll compressor -MG1-MG2 protection module
-B83-B84	Scroll compressor -MG3-MG4 protection module
-B91-B92	Pressure switch 4 / 20ma compressor -MG1-MG2
-B93-B94	Pressure switch 4 / 20ma compressor -MG3-MG4

BCD	Condense battery
BEC	Hot water battery
BEG	Chilled water battery
BEV	Evaporator battery

-BG10	Hygiene probe
-BH10	Regulation hygrometry probe
-BH11	External hygrometry probe

-BT10	Regulation temperature probe
-BT11	External temperature probe
-BT12	Blower temperature probe
-BT13	Cold water temperature probe
-BT14	Condenser 1 speed regulation temperature probe
-BT15	Condenser 2 speed regulation temperature probe
-BT16	Heat exchanger water outlet antifreeze probe
-BT17	Mixture probe
-BT21-BT22	Compressor 1-2 antifrost temperature probe
-BT23-BT24	Compressor 3-4 antifrost temperature probe
-BT25	Free temperature
-BT91-BT92	Defrost temperature sensor compressor 1-2
-BT93-BT94	Defrost temperature sensor compressor 3-4
-BTP1-2	Compressor -MG1-MG2 accumulator
-BTP3-4	Compressor -MG3-MG4 accumulator

CL06.2	JBUS
DT	Thermostatic holder
-EEH	Horizontal water heat exchanger
EEV	Vertical water heat exchanger

-E1-E2	Heater -E1-E2
-E3	Heater -E3
-E4	Vapour humidifier -E4
-E7-E8	Antifreeze heater cords hot water battery
-E9-E10	Antifreeze heater cords
-E11	Smoke detector printed circuit
-E12	Humidifier -E4 level solenoid valve
-E13	Water leak electrode
-E14	Burner control box
-E15	Vapour humidifier -E4 printed circuit



-E16	Printed circuit 0/10V vapour humidifier -E4	-Q1-Q2	Blower fan motor -MS1-MS2 protection
-E20	CPU card KP01	-Q5-Q6	Extraction fan motor -ME1-ME2 protection
-E21	ON-OFF input card KP03	-Q9	Condenser -MC1-MC2 fan motor protection
-E22	ON-OFF input card KP08,1	-Q10	Condenser -MC3-MC4 fan motor protection
-E23	Analog output card KP04,1	-Q11-Q12	Compressor -MG1-MG2 protection
-E24	Analog output card KP04,2	-Q13-Q14	Compressor -MG3-MG4 protection
-E25	Analog output card KP04,3	-Q15	Condenser -MC2 fan motor protection
-E26	Analog output card KP04,4	-Q20	Circulation pump -MP1 protection
-E27	ON-OFF input card KP08,2	-Q25	Housing resistance protection
-E28	Input card 4 /20 mA KP05,1	-QF1	Primary circuit protection -T1
-E29.1.2	Input output card KP12	-QF2	Primary circuit protection -T3
-E30	Digital console KP02 ou KP17	-QF3	Secondary circuit protection -T3
-E31	Graphic console KP07	-QF4	Primary circuit protection -T4
-E32	Interface		
-E51-E52	Compressor -MG1-MG2 housing resistance	-QG	Main switch
-E53-E54	Compressor -MG3-MG4 housing resistance	-QG1-QG2	Condenser 1 / condenser 2 main switch
FCO	Water circuit humidifier	-QE1-QE2	Heater -E1-E2 protection
FD	Dehumidifier filter	-QE3	Heater -E3 protection
FDB	Bottle dehumidifier filter	-RL	Liquid reservoir
FDW	Double flow dehumidifier filter	-SAT	Check valve
		-SA1	Humidifier -E4 on/off switch
-F1	Secondary circuit -T1 128VA / 24V protection fuse	-SA2	Humidifier -E4 drain switch
-F2	Secondary circuit -T1 30VA / 12V protection fuse	-SB1	Emergency stop
-F3	Secondary circuit -T1 6VA / 12V protection fuse		
-F4	Secondary circuit -T1 36VA / 24V protection fuse	-T1	Control circuit transformer 400v / 24v
		-T2	Power supply transformer 400v / 12v / 12v / 24v
-KA31-KA32	Gas burner fault relay	-T3	Burner power supply transformer 400 / 230v
-KA41-KA42	Gas burner fault relay	-T4	Power supply transformer -dad4485 400 / 230v
-KA1-KA2	Relay		
-KA3	Smoke fault relay	-TCB	control thermostat
-KA4	PV/GV relay		
-KA9	External temperature relay +5°	-TI4	Humidifier -E4 current transformer
-KE1-KE2	Heater -E1-E2 contactor	UF	Cooling unit
-KE3	Heater -E3 contactor	UT	Air treatment unit
-KE4	Vapour humidifier -E4 contactor	U1	Interface
-KM1-KM2	Blower fan motor -MS1-MS2 contactor	VAM	Manual check valve
-KM3	Blower fan motor low speed contactor	VL	Liquid indicator
-KM4	Star coupling contactor	VRM	Manual control valve
-KM5-KM6	Extraction fan motor -ME1-ME2 contactor		
-KM7	Extraction fan motor low speed contactor	-V1	Electric battery static contactor
-KM8	Star coupling contactor+E40	-V2	Electric battery static contactor
-KM9-KM10	Condenser 1 / condenser 2 fan motor contactor		
-KM11-KM12	Compressor -MG1-MG2 contactor	V2VP	Pressure switched 2-way valve
-KM13-KM14	Compressor -MG3-MG4 contactor	V3VP	Pressure switched 3-way valve
-KM15	Condenser 2 fan motor contactor		
-KM20	Circulation pump -MP1 contactor	-Y1	Gas manifold N1 reset electromagnet
-KM21-KM22	Gas manifold 1 - gas manifold 2 contactor	-Y2	Gas manifold N2 reset electromagnet
		-YR	Humidifier -E4 filling solenoid valve
-KM91-KM101	Low ambient contactor	-YV	Humidifier -E4 drain solenoid valve
-KT1.2	Timing relay	-YV1	Chilled water 3-way valve
-MC1,2	Condenser -MC1-MC2 fan motor	-YV2	Hot water 3-way valve
-MC3,4	Condenser -MC3-MC4 fan motor	-YV11-YV12	Compressor -MG1-MG2 cycle reversal valve
-ME1-ME2	Extraction fan motor -ME1-ME2 contactor	-YV13-YV14	Compressor -MG3-MG4 cycle reversal valve
-ME3-ME4	Extraction fan motor -ME3-ME4	-YV31-YV32	Burner gas solenoid valve
-MG1-MG2	Compressor -MG1-MG2 contactor	-YV41-YV42	Gas manifold safety solenoid valve
-MG3-MG4	Compressor -MG3-MG4 contactor	-YV51-YV52	Gas manifold main solenoid valve
-MP1	Circulation pump motor	-YV61	Compressor -MG1 hot gas injection solenoid valve
-MR1	Economiser damper motor	-YV71-YV72	Compressor -MG1-MG2 liquid solenoid valve
-MR2	Blower damper motor		
-MR3	Fresh air damper motor		
-MR4	Extraction damper motor		
-MR5	Recycler air damper motor		
-MS1-MS2	Blower fan motor -MS1-MS2	-Z*	Capacity resistance circuit

FCA / FCK = Cooling only unit
 FXA/FXK = Heat recovery unit

FHA / FHK = Heat pump rooftop



MAIN CURRENT DIAGRAM

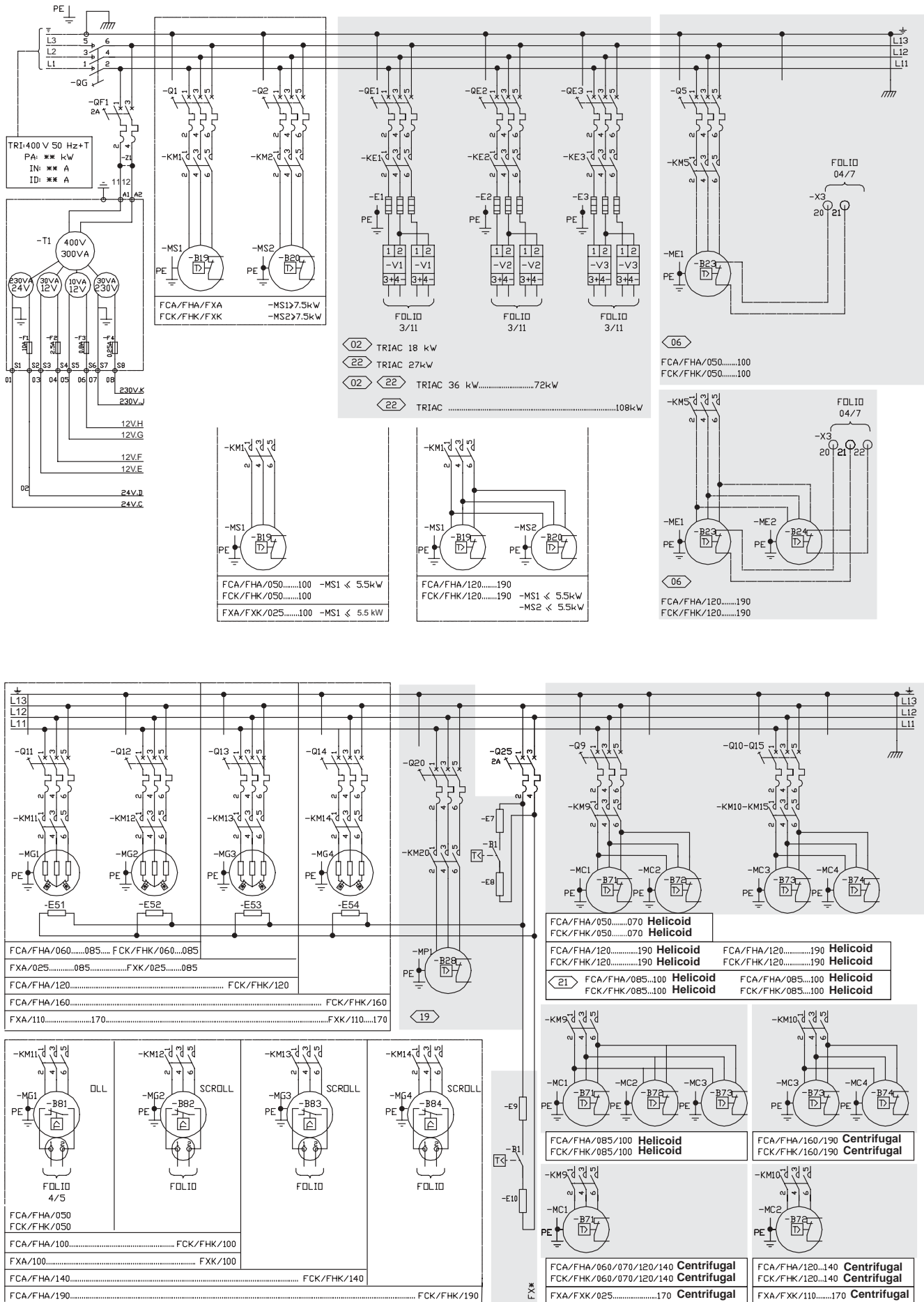



FGA / FGK = Cooling only unit with gas fired heating
 FDA / FDK = Heat pump rooftop with gas fired heating

MAIN CURRENT DIAGRAM

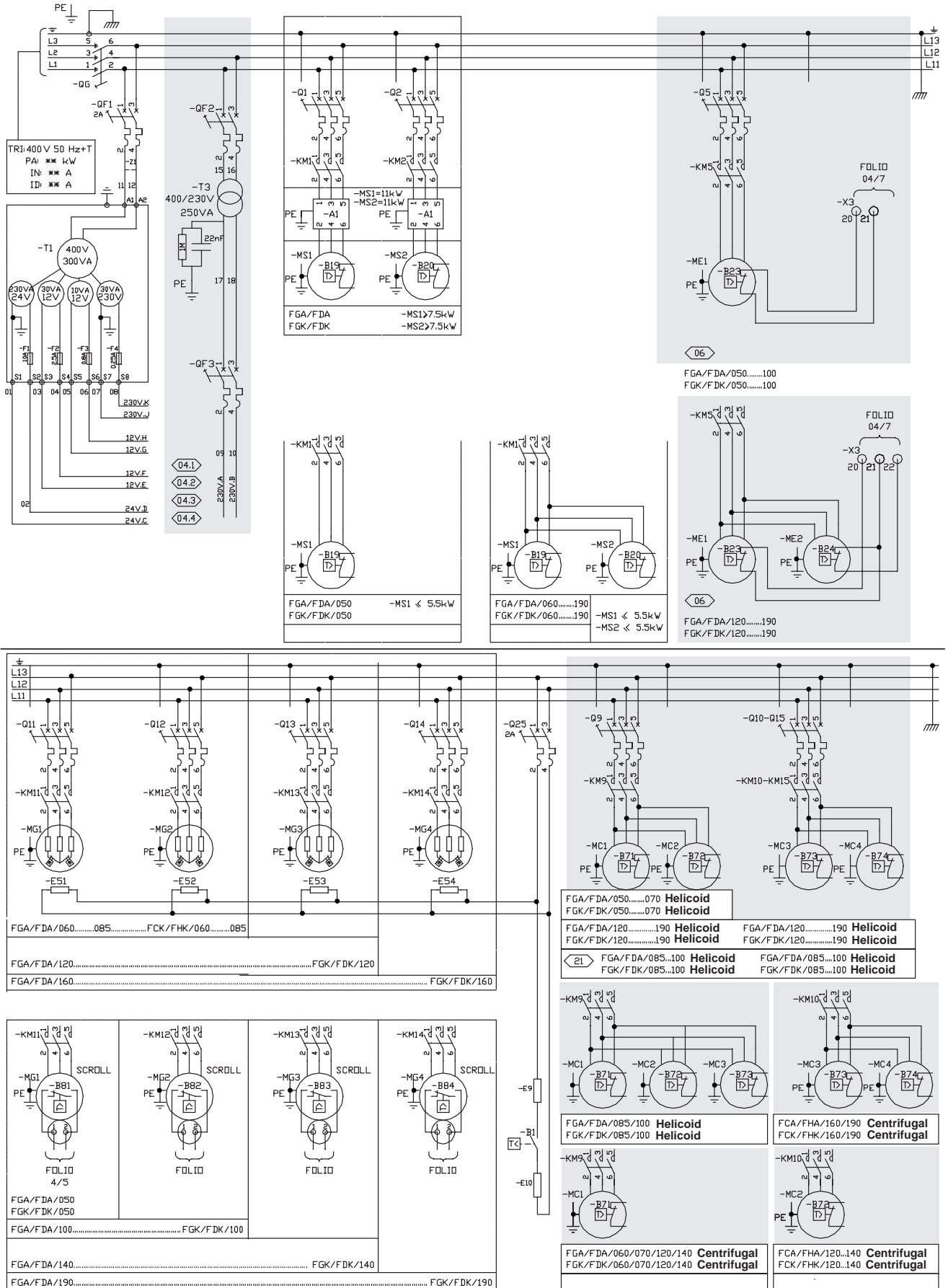



MAIN CURRENT DIAGRAM

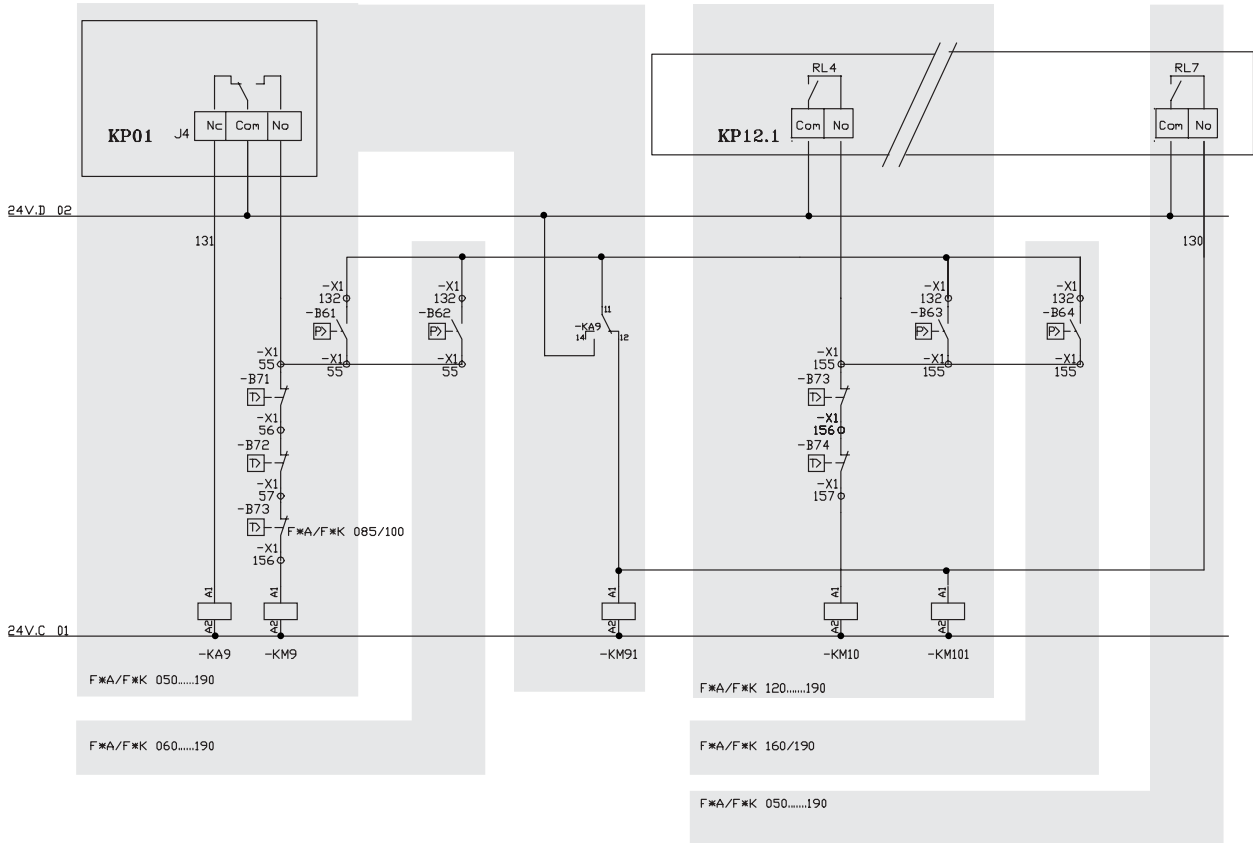

20

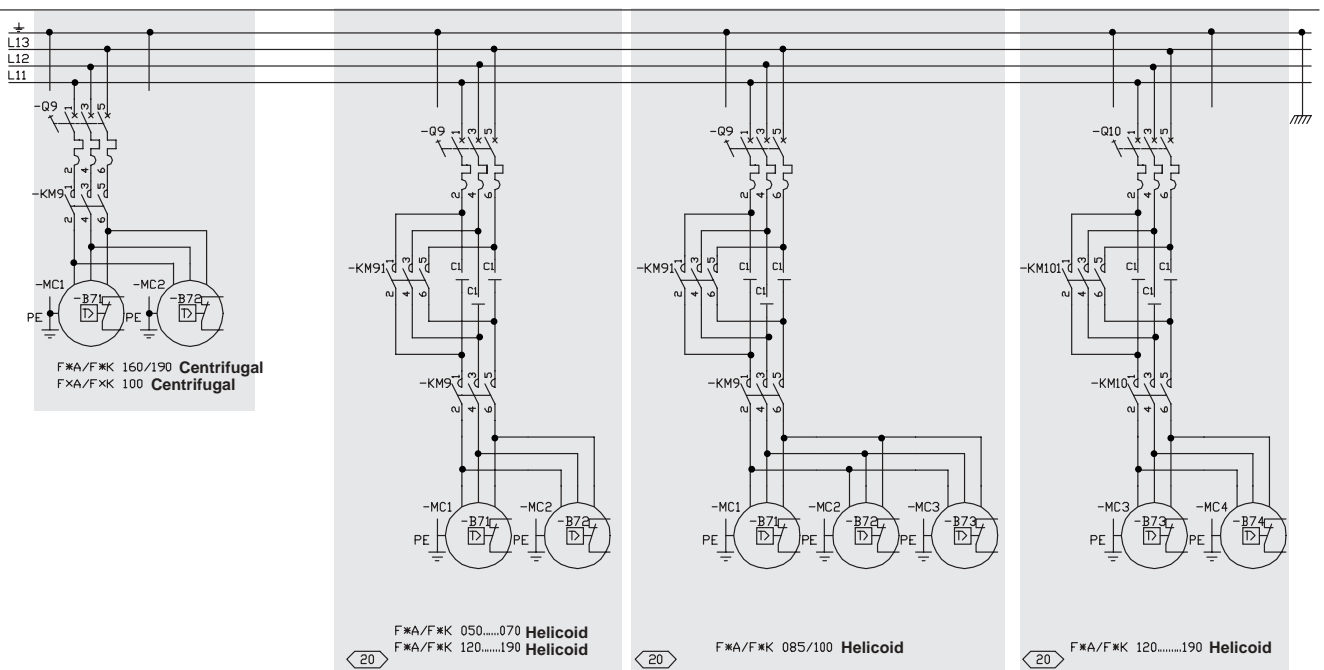

20

20

20

20



CLIMATIC CONTROLLER

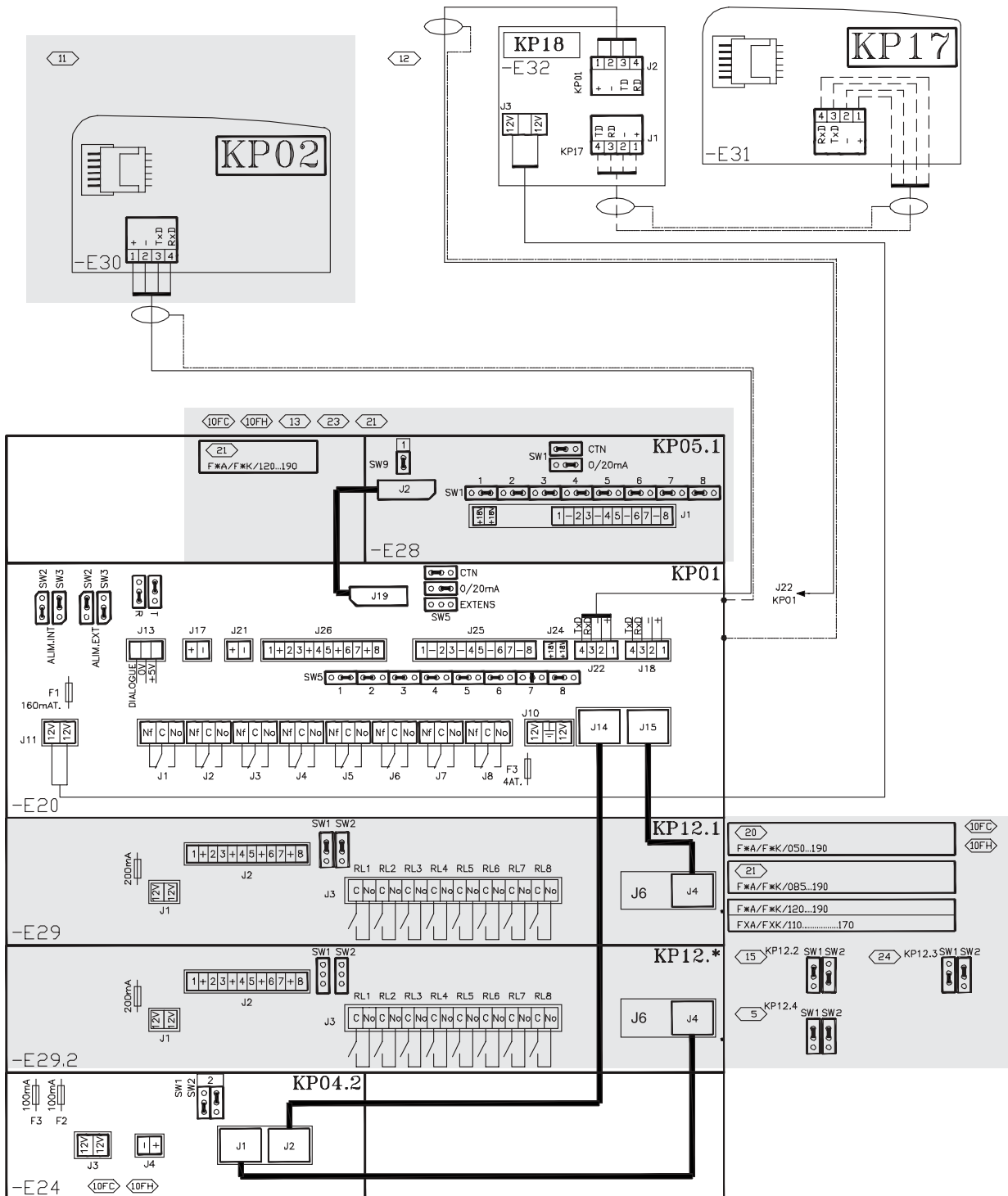



CLIMATIC INPUT FG / FD

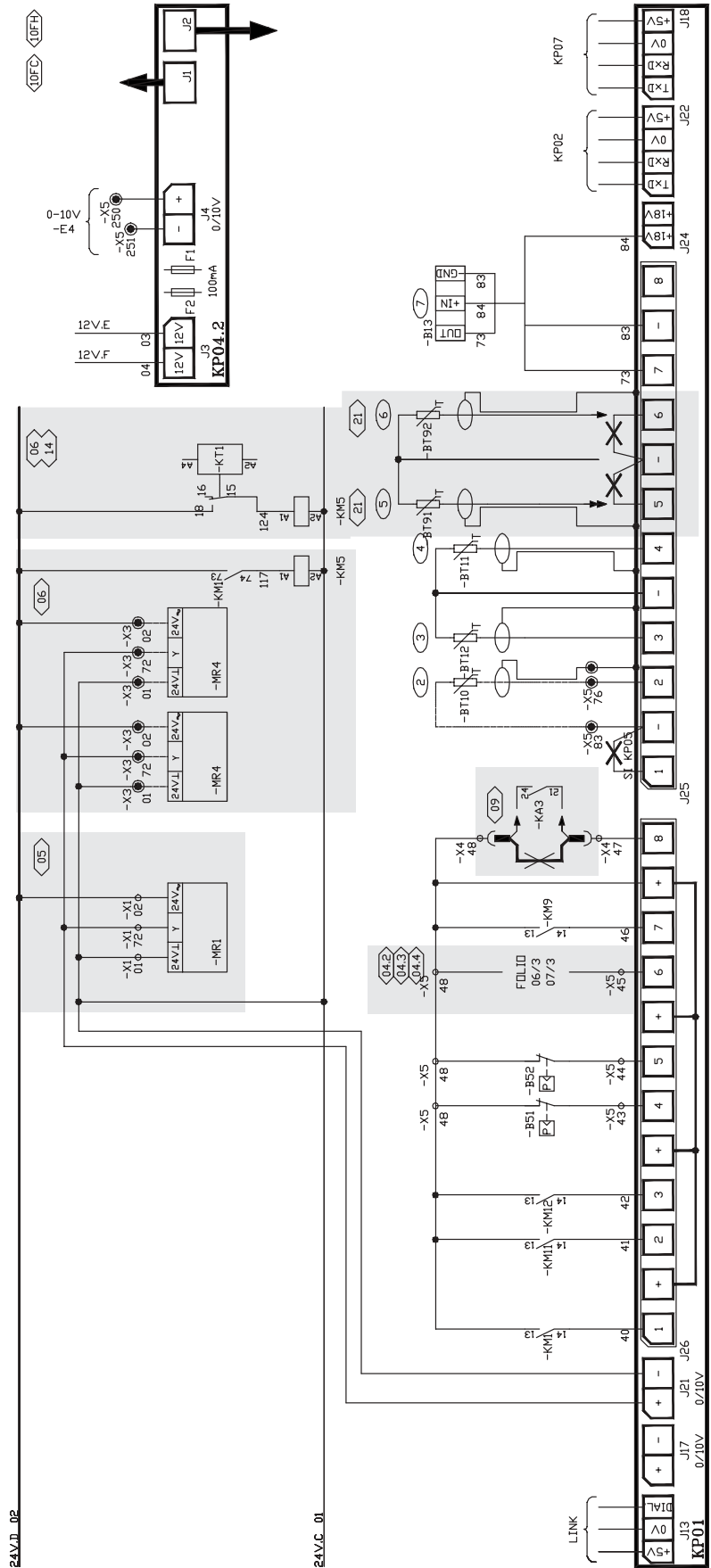
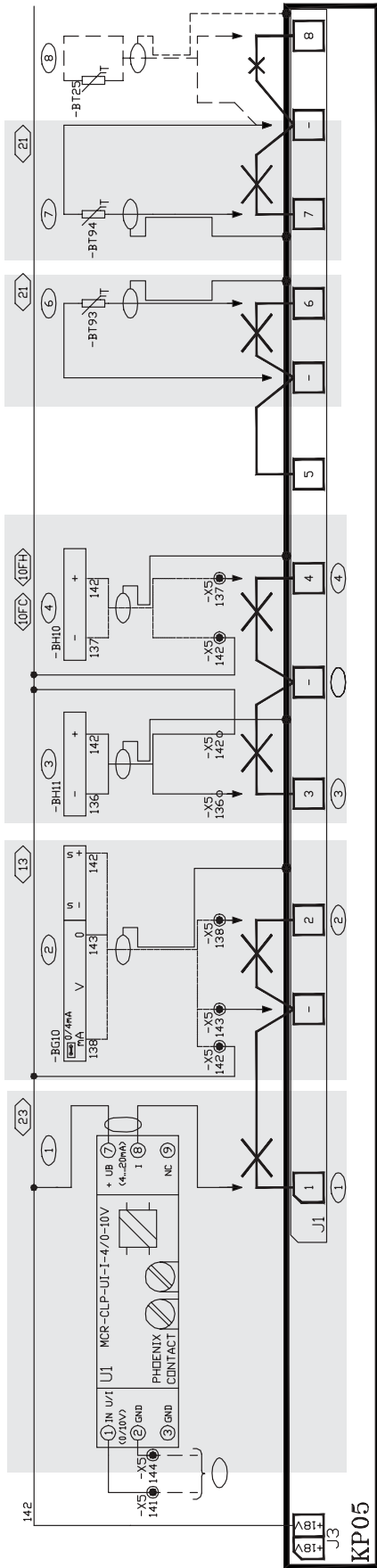



CLIMATIC OUTPUT FG / FD

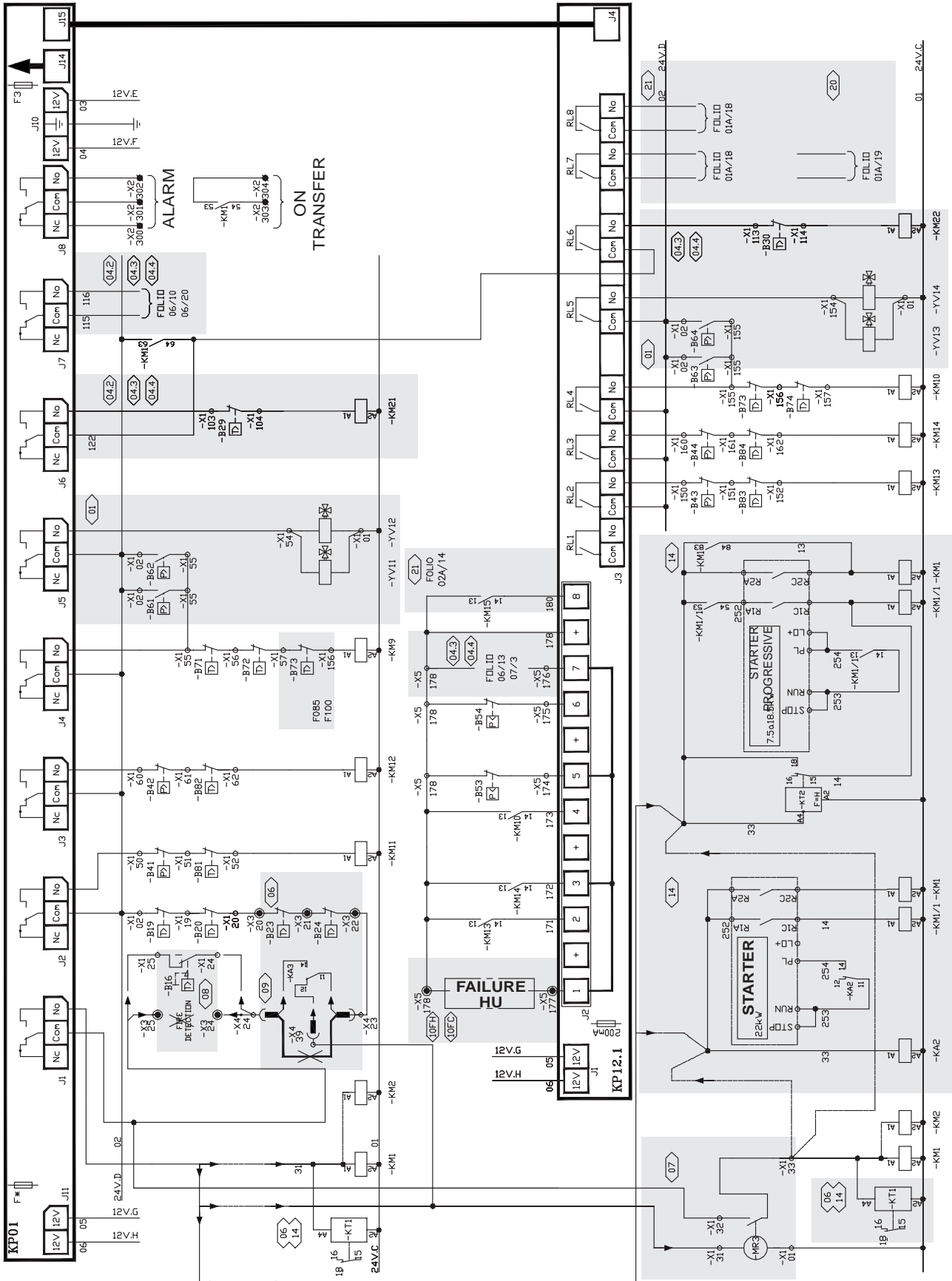



WIRING DIAGRAM GAS BURNER 33 / 60 / 120 Kw

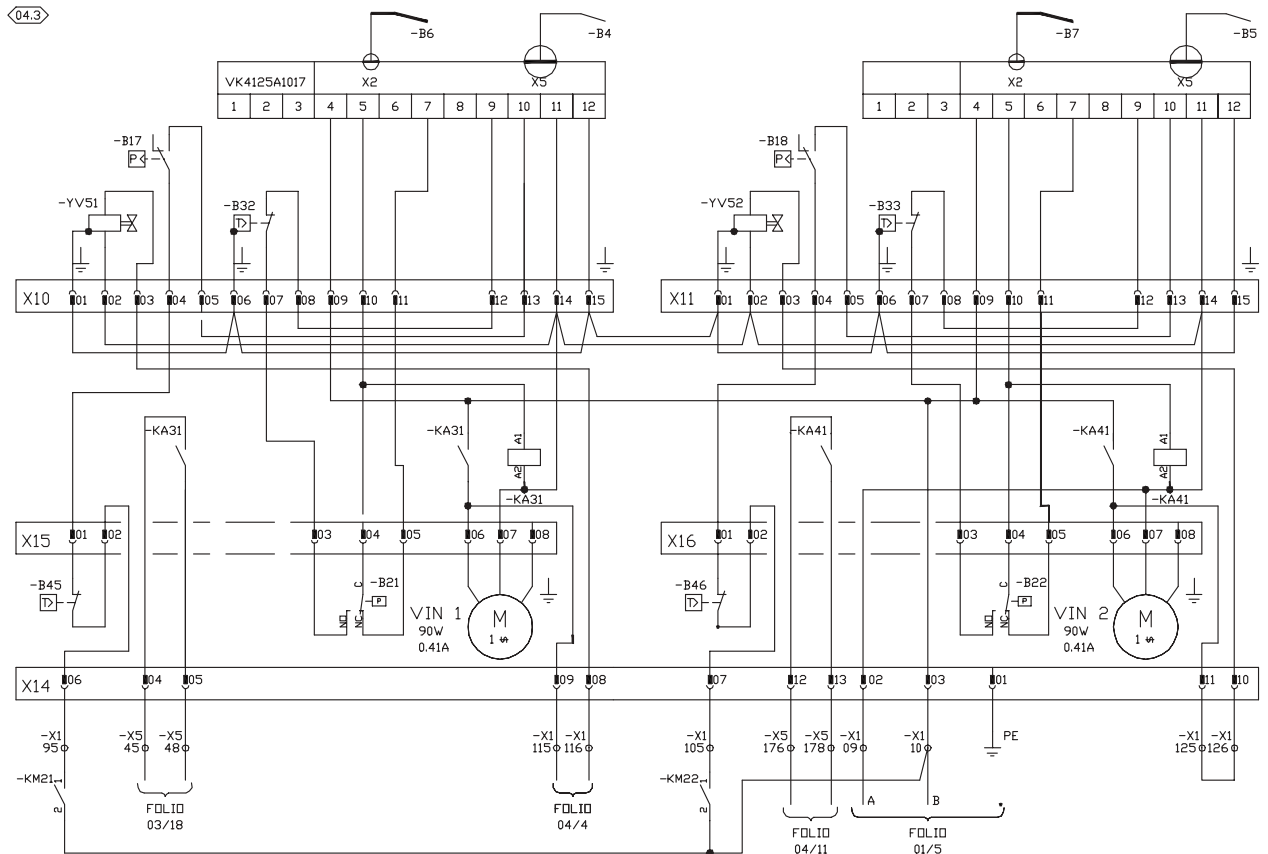
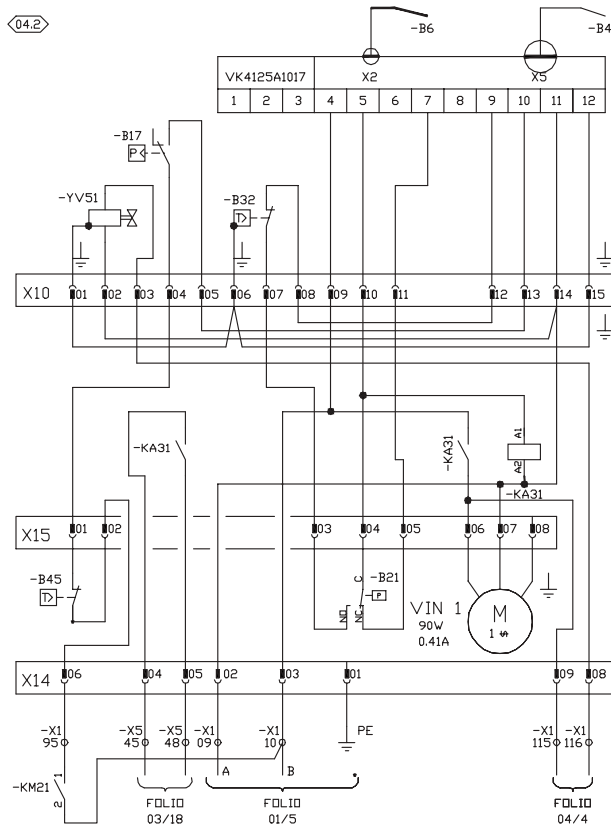



DAD SMOKE DETECTOR / KP7 GRAPHIC DISPLAY

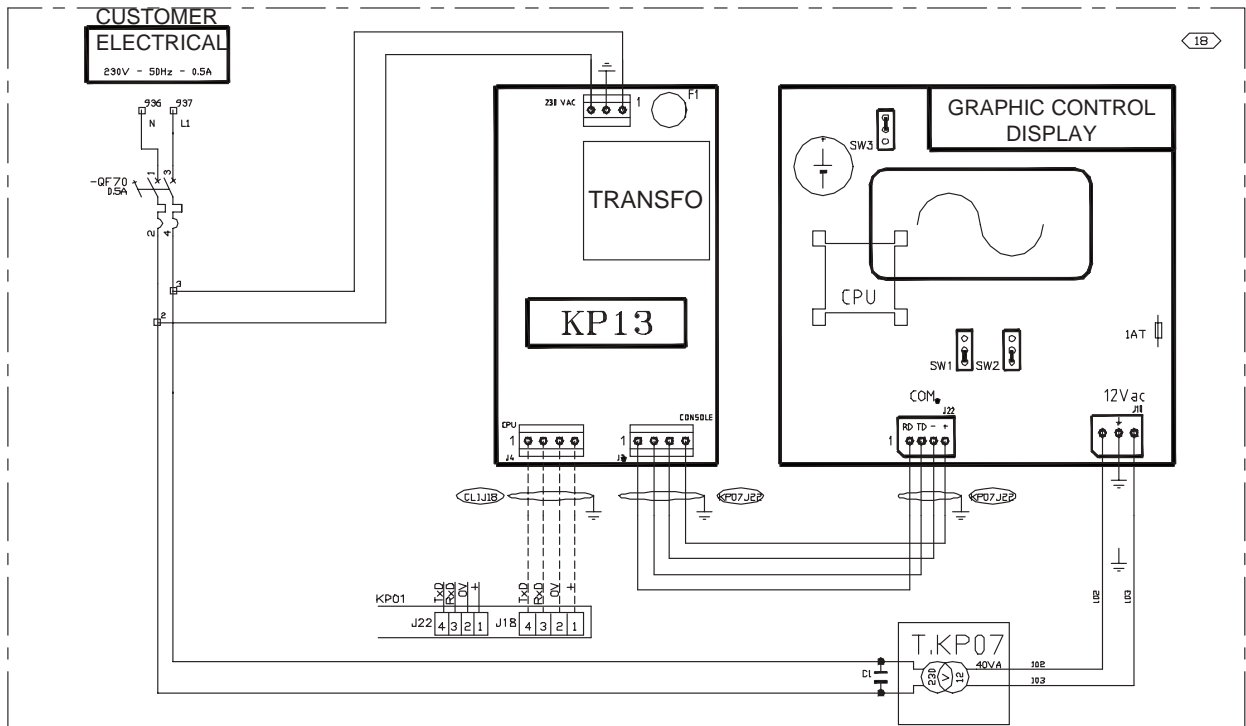
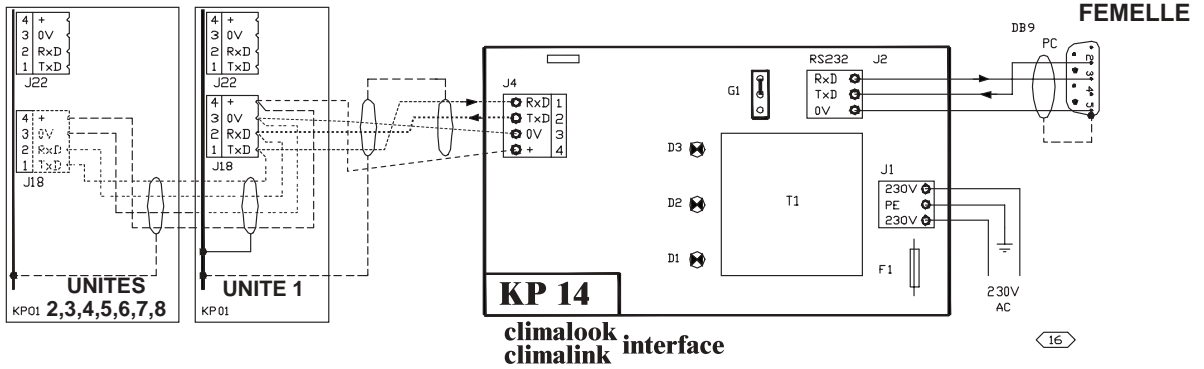
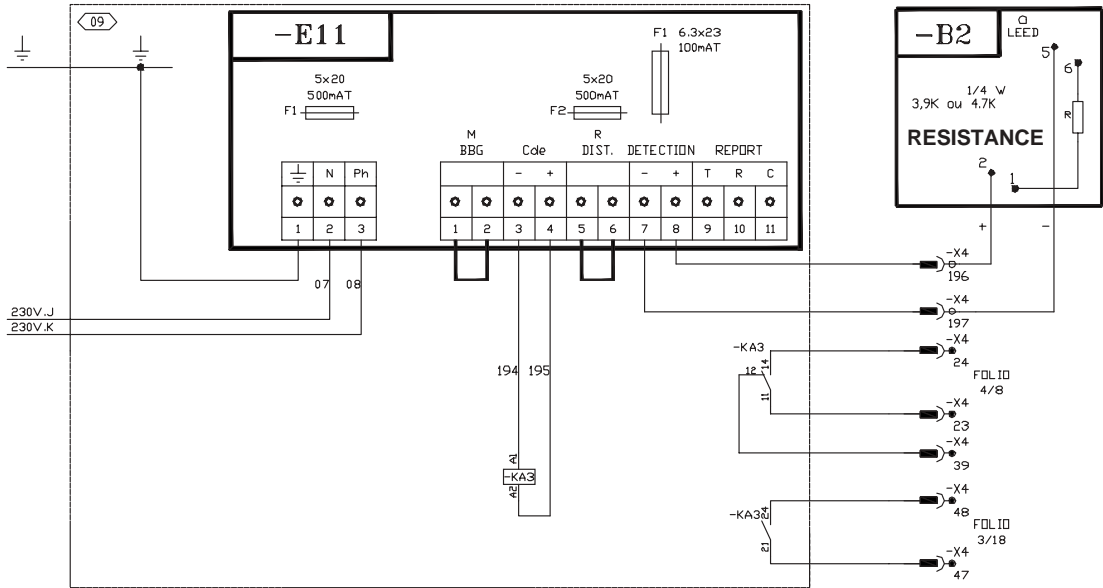



KP 06 (J-BUS INTERFACE)

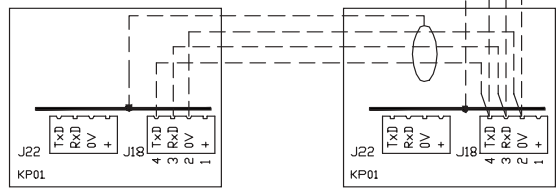
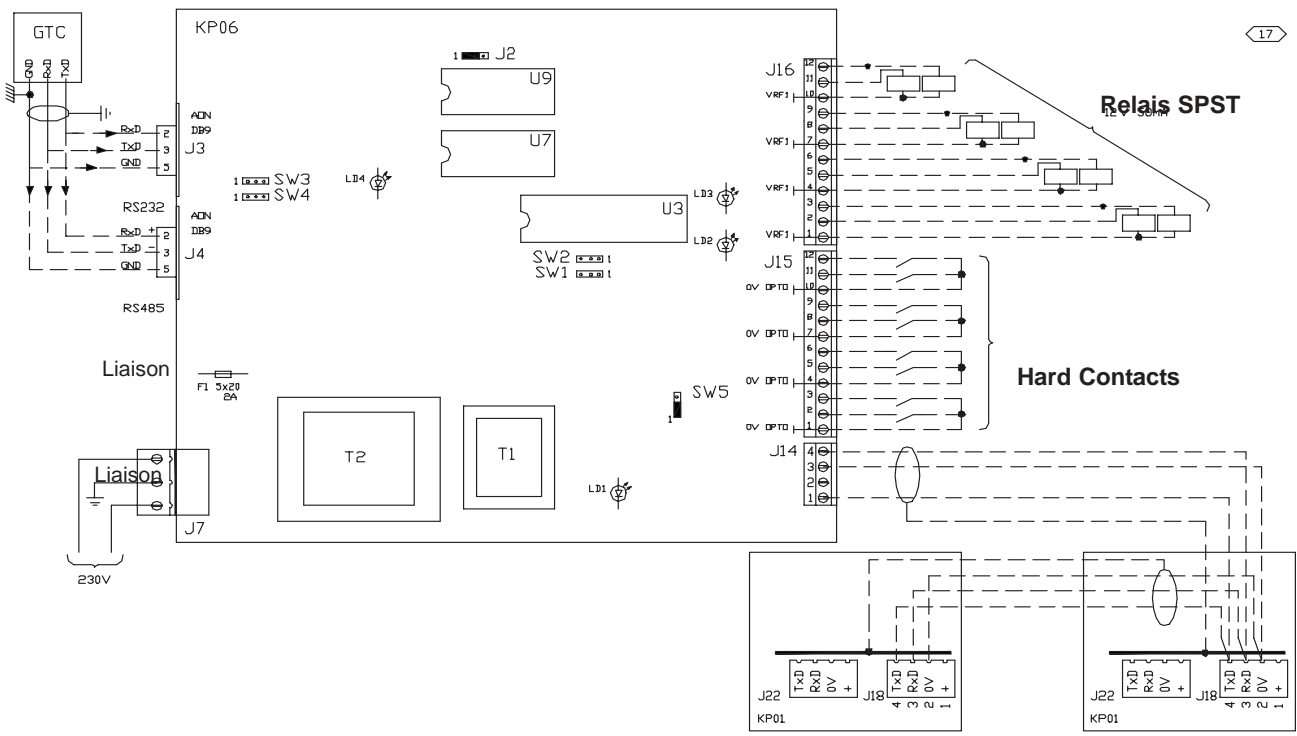

SW3	1,2	2,3	
SW4	1,2	2,3	
SERIE	RS485	RS232	

F1	Fuse 1A
J2	Unit size 8k (position 1-2) 32k (position 2-3)
J3	SUBD 9-point connector RS232 link
J4	15. SUBD 9-point connector RS485 link
J7	PHENIX 3-point connector supply 230 V
J14	CLIMATIC link 4-point connector
J15	ADN Inputs 12-point connector
J16	ADN Outputs 12-point connector
LD1	Monitoring LED power 6V link
LD2	Dialogue monitoring LED
LD3	Power Fell monitoring LED
LD4	Monitoring LED power 5V link
SW1	Speed configuration (9600, 4800 ,2400 or 1200 baud)
SW2	Speed configuration (9600, 4800 ,2400 or 1200 baud)
SW3	TXD signal configuration RS232 (position 2-3) / RS485 (position 1-2)
SW4	RXD signal configuration RS232 (position 2-3) / RS485 (position 1-2)
SW5	+10V Converter (Position 1-2)
U7	Programmable EPROM CL06
U9	Configurable EPROM

Serial link RS232
 The link is used for short distances
 Only a master control can be connected to this link

Serial link RS485
 This link is used for long distances (maximum 100 metres)
 Up to 31 controls can be connected (including 1 master)



LAYOUT ELECTRICAL PANEL

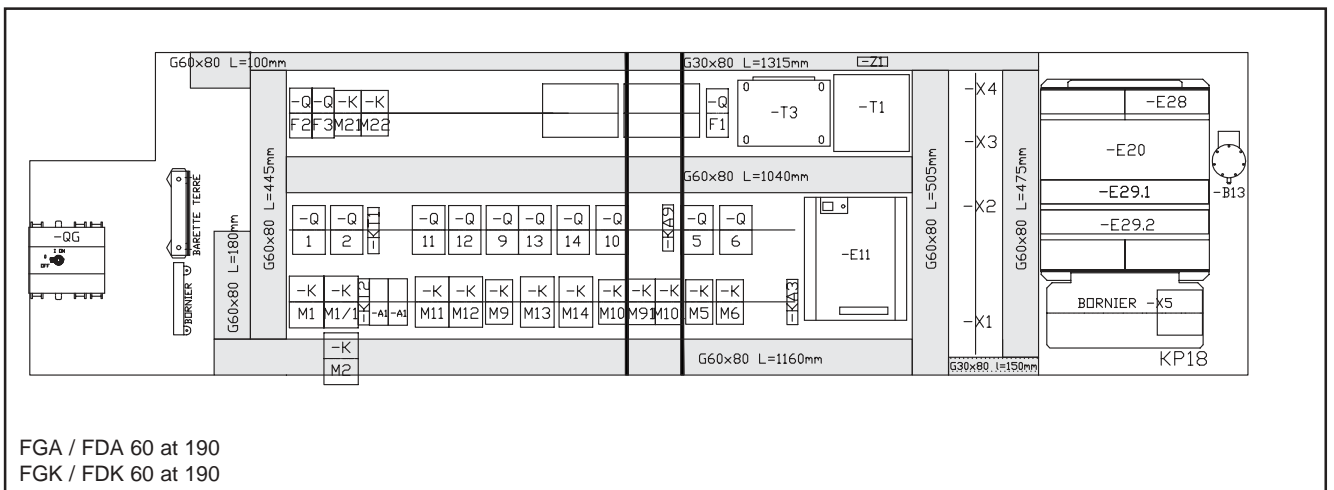
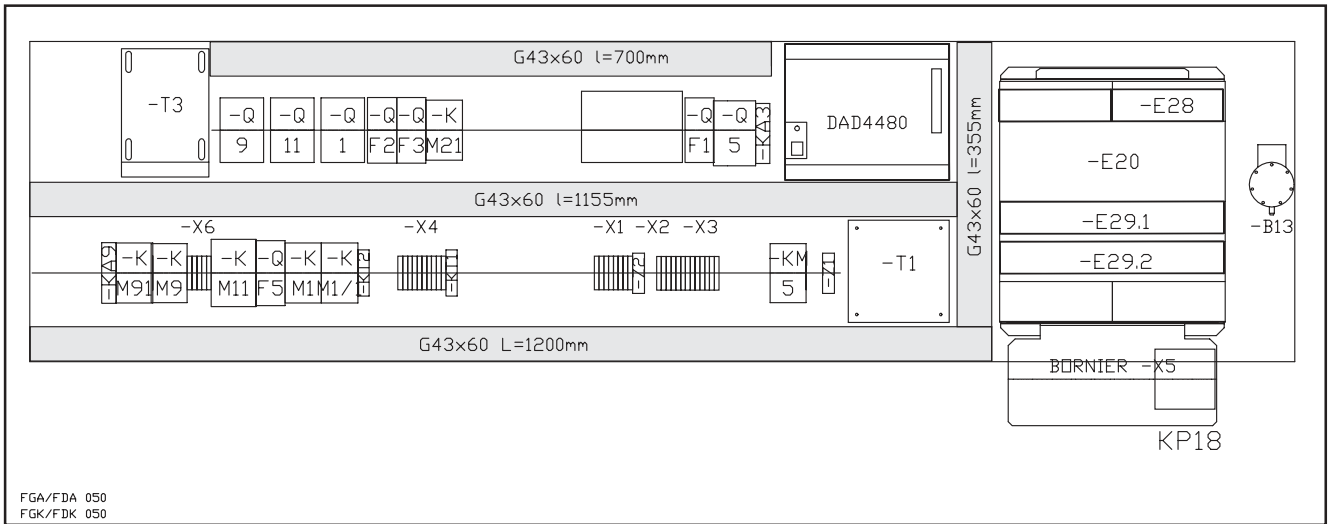

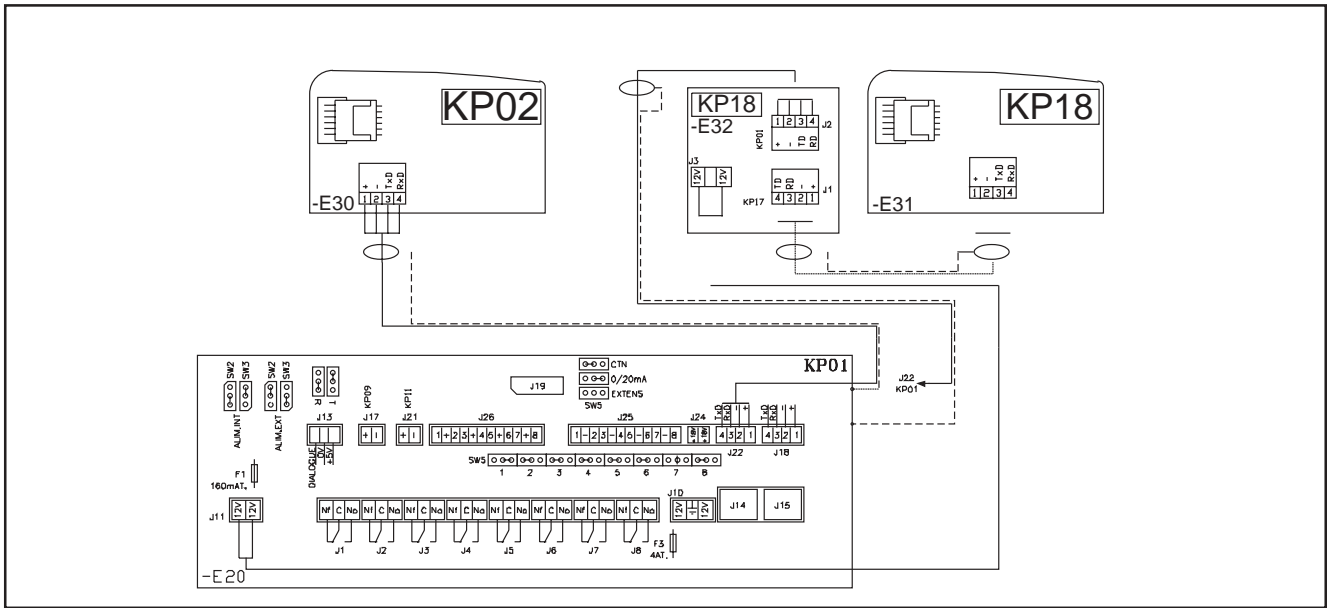

REGULATION TEMPERATURE PROBE

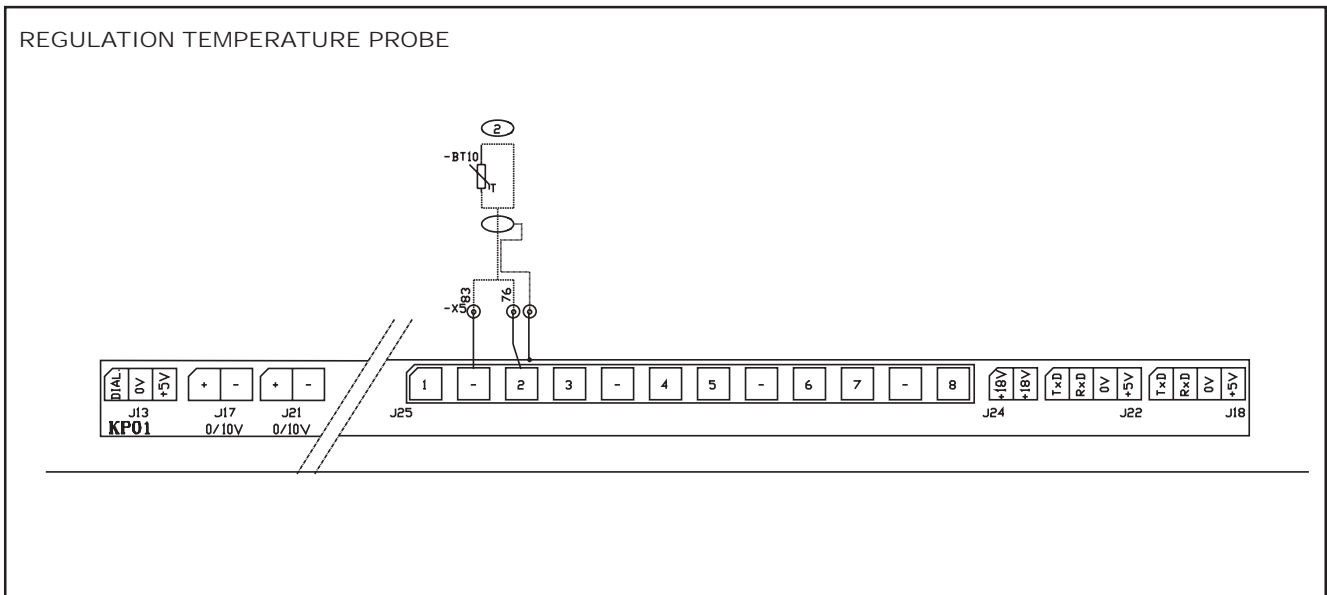

HYGIENE PROBE

REGULATION HYGROMETRY PROBE

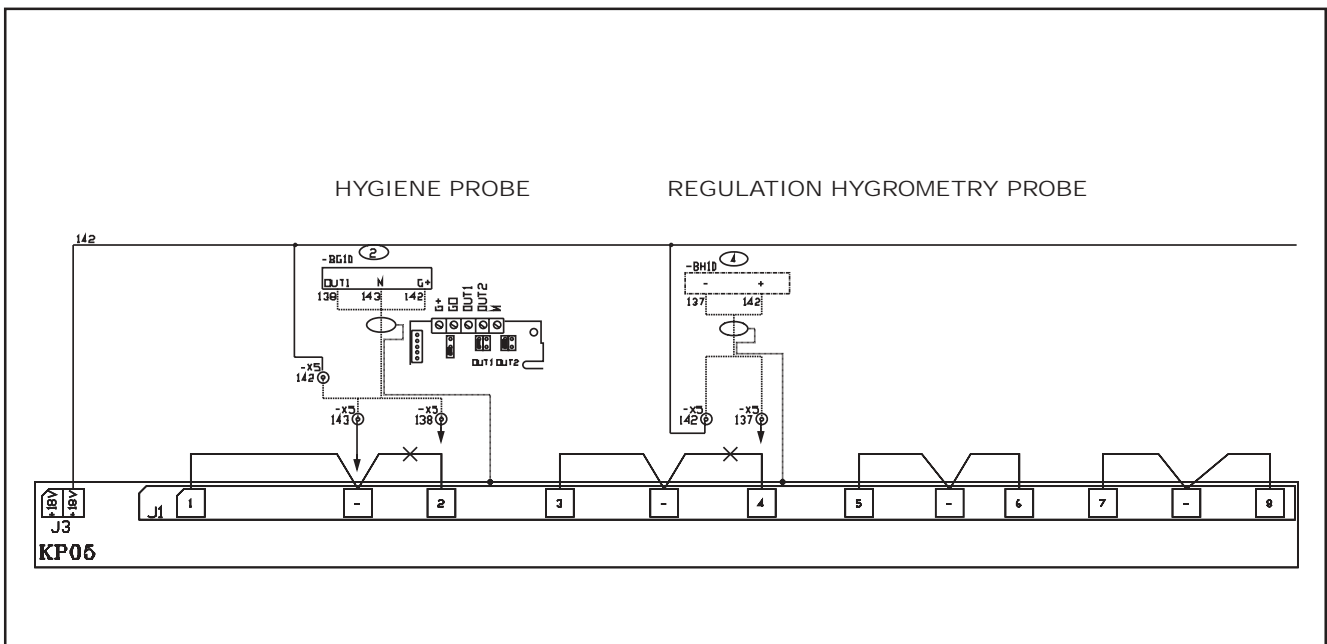

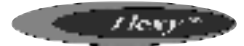

000	No fault
001	Failure air flow
004	Dirty filters
005	Missing filters
011	Faulty electrical heater
012	Supply air overtemperature
013	Temperature room too low
014	Faulty gas burner no. 1
015	Faulty gas burner no. 2
022	Supply temperature too low
023	Room overtemperature
031	Faulty humidifier
032	Room humidity too low
033	Room over humidity
041	Faulty pump
081	Faulty return air or room temperature sensor
082	Faulty return air or room relative humidity sensor
083	Faulty outside temperature sensor
084	Faulty outside relative humidity sensor
085	Faulty supply air temperature sensor
086	Faulty cold water loop temperature sensor
087	Faulty water condenser outlet temperature sensor
088	Faulty mixing air temperature sensor
091	Faulty blower fan
092	Faulty condenser : system 1
093	Faulty condenser : system 2
094	Faulty condenser : system 3
095	Faulty condenser : system 4
096	Condenser water temperature too low
097	Condenser water overtemperature
098	Faulty condenser water flow
099	Error : smoke
111	Faulty condenser temperature sensor, compressor no. 1
112	Faulty pressure transmitter, compressor no. 1
115	Faulty high pressure or faulty electrical power, compressor no. 1
117	Faulty low pressure compressor no. 1
121	Faulty condenser temperature sensor, compressor no. 2
122	Faulty pressure transmitter, compressor no. 2
125	Faulty high pressure or faulty electrical power compressor no. 2
127	Faulty low pressure compressor no. 2
131	Faulty condenser temperature sensor, compressor no. 3
132	Faulty pressure transmitter, compressor no. 3
135	Faulty high pressure or faulty electrical power compressor no. 3
137	Faulty low pressure compressor no. 3
141	Faulty condenser temperature sensor, compressor no. 4
142	Faulty pressure transmitter, compressor no. 4
145	Faulty high pressure or faulty electrical power compressor no. 4
147	Faulty low pressure compressor no. 4



The following text includes references such as [C11] and [V25]. They relate to the setpoint or variable numbers used with the KP02 unit.

001



Wrong Air Flow

If the pressure differential obtained by the analog sensor [V21] is less than the setpoint value [C88] for more than 20 seconds, and if the blower fan has operated for more than 1 minute 30 seconds, the air flow safety system is activated and stops the ventilation.

The air flow safety system automatically stops after 1 minute 30 seconds and is automatically locked out after 3 cut-outs in the same day. In this case a manual reset is obligatory. The cut-out counter is reset to zero every evening at 20:00 if the value does not exceed 3 failures.

004



Dirty Filters

If the pressure differential obtained by the analog sensor [V21] is greater than the setpoint value [C86] for more than one minute, the CLIMATIC™ indicates that the filters are dirty. The unit is not stopped.

005



Missing Filters

If the pressure differential obtained by the analog sensor [V21] is less than the setpoint value [C87] for more than one minute, the CLIMATIC™ indicates that the filters are missing. The unit is not stopped.

SUPPLY AIR TEMPERATURE SAFETY SYSTEM

Supply Air Overtemperature Limit

1st Safety Level

If the supply air temperature is greater than or equal to the setpoint [C68], the heat control system starts to reduce progressively. The control cycle will recommence normal operation for a temperature lower than 3°C below this setpoint.

2nd Safety Level

If the supply air temperature is greater than or equal to the setpoint [C69], the safety system is activated. The safety system automatically stops at a temperature lower than 3°C below this setpoint.

012



Supply Air Temperature Too Low

1st Safety Level

If the supply air temperature is greater than or equal to the setpoint [C65], the cold control system starts to reduce progressively. The control cycle will recommence normal operation for a temperature in excess of 3°C above this setpoint.

2nd Safety Level

If the supply air temperature is less than or equal to the setpoint [C66], the unit automatically positions its fresh air damper to the all air recycled position and cuts out cold production. This safety level automatically stops at a temperature in excess of 3°C above this setpoint.

3rd Safety Level

If the supply air temperature is less than or equal to the setpoint [C67] for more than 15 minutes and for 15 minutes after the fan has started, the "supply air temperature too low" safety system is activated. The unit shuts down completely.

022



This safety system cuts out if the supply air temperature is greater than 3°C above this setpoint. It is automatically maintained after 3 cut-outs in the same day, and in this case a manual reset is obligatory. The cut-out counter is reset to zero every evening at 20:00 if the value does not exceed 3 failures.

NOTE : If a unit has a hot water battery, the temperature setpoint value is fixed at +6°C and the



register time set to 5 seconds. In addition, if the antifreeze thermostat is opened, the 3rd safety level is immediately automatically maintained. In this case, manual resetting of the thermostat followed by the CLIMATIC™ is obligatory

Room Overtemperature Safety System



023

Upper Room Air Limit

If the room temperature is greater than or equal to the setpoint [C40], the safety system is activated. It automatically cuts out at a temperature lower than 3°C below this setpoint.



013

Lower Room Air Limit

If the room temperature is less than or equal to the setpoint [C39], the safety system is activate

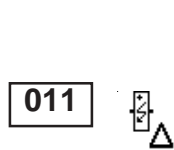

011

Faulty Electrical Heater Batteries

The electrical heater battery safety thermostats act directly on the heater stage contactors. This information is fed to the CLIMATIC™ via auxiliary contacts.

If the CLIMATIC™ gives the order to the heater to operate and if 5 seconds later the auxiliary contact is still open, the heat safety system is activated and stops the electrical heater assembly. This safety system is automatically locked-out. In this case a manual reset is obligatory.

Note: This fault is also displayed in the event of a contact "shunt".



014

Faulty Gas Burners

If there is a fault with the gas control boxes the heat safety system is activated and stops the respective burner.



015

This safety system automatically cuts out on the CLIMATIC™ and the control unit must be manually reset.



031

Faulty Humidifier (Flexy Only)

If there is a fault with the gas control unit for more than a minute, the safety system is activated and stops the humidifier.

This safety system is automatically locked-out. In this case a manual reset is obligatory.

Room Humidity Safety System



032

Lower Room Limit

If the room humidity is less than or equal to the setpoint [C41] or [C42], the safety system is activated. It automatically cuts out at a humidity of 3% above this setpoint.



033

Upper Room Limit

If the room humidity is greater than or equal to the setpoint [C43] or [C44], the safety system is activated. It automatically cuts out at a humidity of 3% below this setpoint.

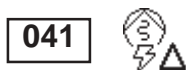

041

Faulty Pump















The internal protection of the water pump motor acts directly on the pump contactor. This information is transmitted to the CLIMATIC™ via an auxiliary contact of the contactor.

If the CLIMATIC™ gives the pump the order to operate and if 5 seconds later the auxiliary contact remains open, the safety system is activated and stops the pump.

The safety system is immediately automatically locked out. In this case, manual resetting is obligatory. Note: This error is also displayed in the event of a "shunt" of the auxiliary contact of the contactor.



Sensor Status

081	 	Room temperature sensor missing or faulty.
082	 	Room relative humidity sensor missing or faulty
083	 	Outside air temperature sensor faulty
084	 	Outside relative humidity sensor faulty
085	 	Supply Air temperature sensor faulty
086	 	Temperature sensor on cold water loop faulty
087	 	Temperature sensor on condenser water outlet faulty.

NOTE :

Missing or faulty room, supply air or outside air temperature sensors can affect the overall control system. A safety device will be activated and all equipment except for the ventilation will cut out. Failure of the other sensors will only stop the equipment involved.

089

Faulty inter card link

The inter card link is faulty or missing.

Faulty blower fan

The fan contactor is not connected although the CLIMATIC™ requests it.

- The thermostat fire safety mechanism, or the fire insertion, is open.
- The internal protection of the blower fan motor is open.

The fire detector and the fan motor internal protection act directly on the fan motor contactor. This information is transmitted to the CLIMATIC™ via an auxiliary contact of the contactor. If the CLIMATIC™ gives the order to operate to the fan and if the auxiliary contact is still open 5 seconds later, the fan safety system is activated and stops the unit.

The safety system is immediately automatically locked out. In this case, manual resetting is obligatory.

If a unit is fitted with an all-or-nothing servomotor-powered damper, the detection time extends to 2 minutes (Flexy™ only).

Note : This error is also displayed in the event of a "shunt" of the auxiliary contact of the contactor.

091



Faulty ventilation, condenser circuit 1 or 2

The fan contactor is not connected although the CLIMATIC™ requests it.

The fan motor internal protection acts directly on the fan motor contactor. This information is transmitted to the CLIMATIC™ via an auxiliary contact of the contactor.

If the CLIMATIC™ gives the order to operate to the fan and if the auxiliary contact is still open 5 seconds later, the fan safety system is activated and stops the condenser fan and the compressors concerned.

The safety system is immediately automatically locked out. In this case, manual resetting is obligatory.

092



Faulty ventilation, condenser circuit 3 or 4

The fan contactor is not connected although the CLIMATIC™ requests it.

The fan motor internal protection acts directly on the fan motor contactor. This information is transmitted to the CLIMATIC™ via an auxiliary contact of the contactor.

If the CLIMATIC™ gives the order to operate to the fan and if the auxiliary contact is still open 5 seconds later, the fan safety system is activated and stops the condenser fan and the compressors concerned.

The safety system is immediately automatically setpoint. In this case, manual resetting is obligatory.

093



**094****Customer error**

A fault has been detected, external to the unit.

095**Water leak**

If the contact of the water leak detection card is closed for more than 30 seconds, the safety system is activated.

WATER HEAT EXCHANGER OUTLET TEMPERATURE SAFETY SYSTEM.**Condenser Water Temperature Too Low****096**

If the temperature of the water loop is less than or equal to the preset setpoint **[C80]** during the operation of one of the compressors, the condenser safety mechanism is applied. The compressors are stopped.

This safety mechanism automatically cuts out if the loop temperature exceeds 4°C from this setpoint.

It is also automatically locked out after 3 failures within a day. In this case, manual resetting is obligatory. The counter is reset to zero every evening at 20:00 if its value does not exceed 3 failures.

096**Condenser Water Temperature Too High**

The temperature of the water loop is greater than or equal to the preset setpoint **[C81]** during the operation of one of the compressors, the condenser safety mechanism is applied. The compressors are stopped.

This safety mechanism automatically cuts out if the loop temperature is less than 4°C from this setpoint.

It is also automatically locked out after 3 failures within a day. In this case, manual resetting is obligatory. The counter is reset to zero every evening at 20:00 if its value does not exceed 3 failures.

Faulty Water Flow**098**

If the contact of the water flow controller is open for more than 20 seconds, the condenser safety mechanism is applied. The compressors are stopped.

This safety mechanism automatically cuts out if the loop temperature is less than 4°C from this setpoint.

It is also automatically locked out after 3 failures within a day. In this case, manual resetting is obligatory. The meter is reset to zero every evening at 20:00 if its value does not exceed 3 failures.

Error : Smoke**099**

If the contact closes due to the smoke detector card, the smoke safety mechanism is activated. The unit is completely shut down and the fresh air louver is set to the fresh air position.

This safety mechanism is automatically locked out. In this case, manual resetting is obligatory.



Refrigeration system faults

111			①	
121			②	Faulty condenser temperature sensor
131			➔	
141			④	
112			①	
122			②	
132			➔	Faulty pressure transmitter sensor, refrigeration system
142			④	
113			①	
123			②	Faulty refrigeration system, frost temperature sensor
133			➔	
143			④	

High pressure switch safety or compressor electrical safety

115		①	The compressor contactor is not connected although the CLIMATIC™ requests it. - The high pressure pressostat is open. - The internal protection of the compressor motor is open.
125		②	The high pressure pressostat and the compressor motor thermal protection act directly on the compressor contactor. This information is transmitted to the CLIMATIC™ via an auxiliary contact of the contactor.
135		③	If the CLIMATIC™ gives the order to operate to the compressor and if the auxiliary contact is still open 5 seconds later, the fan safety system is activated and stops the compressor. The safety system automatically cuts out after 4 minutes.
145		④	It is also automatically locked out after 3 failures within a day. In this case, manual resetting is obligatory. The counter is reset to zero every evening at 20:00 if its value does not exceed 3 failures.

Faulty low pressure compressor

117		①	If the low pressure pressostat is open and the compressor has been operating for more than 2 minutes, the low pressure safety system is activated and stops the compressor. This safety system is not taken into account during the defrost cycle for the heat pump units.
127		②	The compressor is engaged when the pressostat contact closes.
137		③	It is also automatically locked out after 3 failures within a day. In this case, manual resetting is obligatory. The counter is reset to zero every evening at 20:00 if its value does not exceed 3 failures.
147		④	

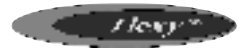

REFRIGERATION

Table 15

FAULT	POSSIBLE CAUSE AND SYMPTOMS	SOLUTION
LP PROBLEMS and LP CUT OUTS	Refrigerant charge too low	Measure the superheat and sub-cooling: Good if 5°C<SC<10°C and 5°C<SH<10°C Bad if SC>10°C and SH too Low Check superheat adjustment and charge unit (a leak check must be carried out)
	In Heat Pump Mode the temperature difference between T outdoor and T _{evap.} (Dew) is too high 5°C < Delta T < 10°C excellent 10°C < Delta T < 15°C acceptable 15°C < Delta T < 25°C too high	If too high check the coils are clean or check coil internal pressure drop between the liquid line and the suction line Good if < 3bar Too high if > 3bar (coil blocked)
	Refrigeration circuit blocked in distribution	Stop the fan and create icing of the coil. Check all circuits freeze evenly across the whole surface of the coil If some parts of the coil do not freeze this could indicate a problem with the distribution
	Liquid line drier blocked. High temperature difference between inlet and outlet of the drier	Change filter drier
	Contaminant in the expansion valve	Attempt to free the valve adjusting element by freezing the valve and then heating the thermostatic element. Replace the valve if necessary
	Expansion valve not adjusted properly	Adjust the expansion valve
	Ice plug in the expansion valve.	Heat the main body of the valve. If the LP increases and then decreases gradually, empty the circuit and replace the drier.
	Incorrect insulation of the thermostatic bulb of the expansion valve	Superheat too low: adjust superheat Move the thermostatic element along the pipe Insulate the Thermostatic element of the valve
	Low Pressure Switch cut out point too high	Check the cut out pressure of the Low Pressure switch: It must be 0.7+/- 0.2bar and must closes at 2.24 +/- 0.2 bar
	LP cut out due to not enough defrost on heat pumps	Adjust the CLIMATIC settings to extend the defrost cycles or shorten the time between defrosts
HP PROBLEMS AND HP CUT OUTS	Incorrect Airflow rates	<i>Heat pump mode :</i> Check the filter before the indoor coil measure and estimate the airflow rate increase the speed of the fan <i>Cooling mode :</i> Check the condenser fan (Amps)
	Moisture or contaminants in the system	Summer operation Several hours after the unit has stopped, check the correspondance between the measured pressure and the outdoor temperature



REFRIGERATION

FAULT	POSSIBLE CAUSE AND SYMPTOMS	SOLUTION
HP PROBLEMS AND HP CUT OUTS	Moisture or contaminants in the system	If the circuit pressure is higher (<1bar) than the saturated pressure corresponding to the measured outdoor temperature, there is possibility that some contaminants are present in the system. Reclaim the refrigerant, and vacuum the circuit (Ensure very low and slow vacuum for R407c) Recharge the unit
	Condenser coil is obstructed	Check the condenser coil and clean is necessary
	Recycled Hot Air	Check clearance around the condenser
Strong variations of pressure (2 to 3 bar) Thermostatic Expansion Valve "hunting"	Incorrect adjustment of the expansion valve Low refrigerant charge Filter drier obstructed with gas bubbles at the expansion valve inlet Moisture in the system	Refer to LP problems and LP cut out section
Very high discharge temperature, High amps measured at compressor	Very high superheat, very hot compressor	Open the superheat adjustment on the expansion valve. Check the pressure drop on the filter drier in the suction line
	Four Way reversing valve possibly blocked, abnormal noise from the valve, low LP and increasing HP	Check operation of the valve by going through cycle inversions. Change if necessary. Refer to LP problems

INDOOR FAN BLOWER

FAULT	POSSIBLE CAUSE AND SYMPTOMS	SOLUTION
High amps on action Fan motor	Pressure drop in the ducting installation too low.	Reduce the rotation speed of the fan Measure and estimate the airflow and pressure and compare with the specification from customer.
High amps on reaction Fan motor	Pressure drop in the ducting installation too high.	Reduce the rotation speed of the fan Measure and estimate the airflow and pressure and compare with the specification from customer.
Unstable running and high vibration	Fan jumping from one operating point to the other.	Change rotation speed of the fan.

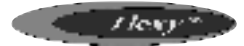

OUTDOOR AXIAL FAN

FAULT	POSSIBLE CAUSE AND SYMPTOMS	SOLUTION
Heat Pump mode : Circuit breaker open	High Amps due to a low voltage from the main supply	Check the voltage drop when all components are running. Change the circuit breaker for one with a higher rating.
	High amps due to freezing of the coil	Check the adjustable amps on the motor starter. Adjust the defrost cycle set points.
	Flexy : Water ingress in the motor connection box.	Change the component

ELECTRIC HEATER

FAULT	POSSIBLE CAUSE AND SYMPTOMS	SOLUTION
High Temperature trip out on electric heater	Low airflow rate	Measure and estimate the airflow and pressure and compare with the specification from customer.
	Incorrect position of the Klixon	Check that the Klixon, is positioned in the airflow, relocate Klixon if necessary Check that there is no heat transfer from the Klixon support.

ELECTRIC HEATER

FAULT	POSSIBLE CAUSE AND SYMPTOMS	SOLUTION
Water found in the ventilation section	Cooling mode: Water carried away from the coil because of excessive airflow and speed on the coil.	Estimate the airflow rate and check the speed is lower than 2.8 m/s
	Low air pressure in the compartment due to a high airflow rate or a high pressure drop before the fan	Check filter Reduce airflow rate
Water ingress in the filter compartment	Check seals around the ventilation section.	Check the door seal Check for the presence of silicone seals in the corners of the door and at the bottom of the refrigeration section bulkhead.
	Water ingress through a leaking fresh air hood or when running 100% fresh air	Check the seals and flanges in the fresh air hood Reduce the airflow rate if necessary



Rooftops are generally placed on the roof but can also be installed in technical rooms. These units are very robust but a minimum regular maintenance is required. Some moving parts in the units can suffer from wear and tear and must be checked regularly (belts). Other parts can get clogged by dirt carried in the air (filters) and must be cleaned or replaced.

These units are designed to produce cooled or heated air through the use of a refrigeration vapour compression system, it is therefore imperative to monitor the refrigeration circuit operating pressures and check the pipe-work for leaks.

The table below, details a possible maintenance plan, including the operations to be carried out and the periodicity at which they must be accomplished. It is recommended to follow such a plan to keep a rooftop unit in good working order. Regular maintenance of your rooftop will extend its operating life and reduce operating faults

Symbols and Legend :

O	Operation which can be carried out by on-site maintenance technicians.
Δ	Operation which must be carried out by qualified personnel, trained to operate on this type of equipment.

NOTE :

- Times are given for information purpose only and may vary depending on the unit size and type of installation.
- Coil cleaning must be carried out by qualified personnel using appropriate methods that won't damage the fins or the tubes.
- It is recommended to keep a minimum stock of common replacement parts in order to be able to carry out regular maintenance operations (i.e. filters). You can contact your local Lennox representative which can assist you in establishing a parts list for each type of equipment.
- The access ports to the refrigeration circuits **MUST** be leak checked every time gauges are connected to the service ports.

Table 16

TASK	OPERATING MODE						ESTIMATED TIME (mn)
		MONTHLY	QUARTERLY	6 MONTHLY	YEARLY B4 WINTER		
Clean or replace filters: Disposable, or metal frame.	Replace filters with new ones if disposable. Vacuum clean or blow the dirt. Wash and dry carefully. +Replace media if necessary Blocked filter will reduced the performance of the unit. THE UNIT MUST NOT OPERATE WITHOUT FILTERS	0					20
Visual check of the oil level	Visually check the oil level through the sight glass on the side of the compressor casing	0					2
Position check of the compressor crankcase heater.	Check the heating resistance is fitted properly and tight around the compressor body.	0					2
Belt tension check.	Check belt tension (Info in IOM) Replace belt if necessary.	0					10
Centrifugal fan bearings check	Isolate unit from the main power supply; Push the fan wheel manually and check for abnormal noises. Bearings are lubricated for life but may need replacement after 10000 hours	0					10
Check absorbed Amps	Check absorbed Amps on all three phases; compare with the nominal value given in the electrical wiring diagram.		Δ				15
Check Smoke detector	Start the unit. Trigger the smoke detector by moving a magnet around the detector head. Reset unit and control.		Δ				5
Check Climatic control, set-points and variables	Refer to the commissioning sheet; Check all set points are set according to this document.		Δ				15
Check clock settings	Check the time and date of the control		0				5
Check the position and tightness of refrigeration components	Check systematically all connections and fixings on the refrigeration circuit. Check for oil traces, eventually a leak test should be conducted. Check operating pressures correspond to the ones indicated on the commissioning sheet		Δ				30
Check Airflow rate safety switch (if fitted).	Shut down supply fan. The fault must be detected within 5 seconds.			0			
Check freeze protection on HWC				Δ			5
Check three way valve on HWC	Increase room set-point 10°C above the actual room temperature. Check operation of the piston. It must move away from the valve head. Reset the control.			Δ			5
Check economiser actuator operation	Check all fixings and transmission. Stop the unit using the control. The fresh air damper must closes. Start the unit the fresh air damper should open			Δ			5
Check refrigeration 4way valve	With the unit running in cooling mode increase the room set-point temperature by 10°C. The unit should switch to heat pump mode. Reset the control.			Δ			5
Check tightness of all electrical connections	Power down the unit and check and tighten all screws, terminal and electric connections, taking a particular attention to the power lines and low voltage control wires			Δ			30

TASK	OPERATING MODE					
		MONTHLY	QUARTERLY	6 MONTHLY	YEARLY B4 WINTER	ESTIMATED TIME (mn)
Check HP / LP safety switches	Install manifold gauges on the circuit to be checked. Shut down the axial fans and wait for the HP switch to shut down the compressor: 29bar (+1 / -0) auto-reset 22bar (+ - 0.7) Reconnect fans. Switch off the centrifugal supply fan and wait for the LP switch to cut out: 0.5bar (+ - 0.5) reset 1.5bar (+-0.5).			Δ		15
Check outdoor fans and fan guards	Check the fan blades conditions and all fan guards and protections				0	5
Check position of all sensors	Check the good positioning and operation of all sensors of all sensors. Check the values given in the control system. Replace sensor if necessary				0	5
Check and clean if necessary all fresh air grilles	Check the fresh air grilles (if fitted). If dirty or damaged, remove them from unit and clean with high pressure water cleaner. Refit on unit once clean and dry.				0	5
Check indoor and outdoor coils, clean if necessary	Visually check the coils for dirt. If not too dirty, cleaning with a light brush may be enough (WARNING: Fins and copper tubes are very fragile! Any damage WILL reduce the performances of the unit). If very dirty, deep industrial cleaning is required using de-greasing agents.(External contractors must be called).				0 / Δ	1h if cleaning
Check electric heater element for excessive corrosion	Isolate the unit; Pull the electric heater out of the heater module box and check the resistances fo traces of corrosion; Replace resistance as required;				0	1h if replacement
Check anti-vibration mountings, for wear and tear.	Visually check anti-vibration mountings on compressors and centrifugal fan. Replace if damaged.				0	1h if replacement
Check refrigeration circuit for traces of acid in the oil	Take a sample of oil from the refrigeration circuit.				Δ	
Check Glycol concentration in the HWC circuit	Check the glycol concentration in the pressurised water circuit. (a concentration of 30% gives a protection down to aprox. - 15°C) check the circuit pressure				Δ	30
Check defrost cycle with 4-way valve inversion.	Switch the unit to heat pump mode. Change the set point to obtain the standard defrost mode and reduce the cycle time to the min value. Check the operation of the defrost cycle.				Δ	30
Gas burner module check for corrosion	Pull out the burner to access the tubes (refer to Gas burner section in the IOM)				Δ	30
Sweeping and cleaning the gas burner	Clean the in-shot burners and the blower wheel lightly with a brush. Sweep the flue and flue box. Wipe-off the dust from the housing of the motor. Clean combustion air inlet louvers Pull-out baffles from the tubes, sweep the tubes CHECK FLUE BOX GASKET				Δ	30
Gas supply pressures / connections checks	refer to Gas burner section in the IOM for details				Δ	15
Gas regulation valve settings	refer to Gas burner section in the IOM for details				Δ	30
Check gas burner safety switches	refer to Gas burner section in the IOM for details				Δ	30





TERMS AND CONDITIONS

In the absence of any other written agreement, the guarantee shall only apply to design faults which occur within a 12 month period (warranty period).

The warranty period starts on the date of commissioning and at the latest six months after the delivery of the Rooftop.

ANTI-CORROSION WARRANTY

10 year warranty terms and conditions for corrosion to the Rooftop casing :

Lennox shall guarantee the casing of its Rooftop units manufactured since May 1991 against corrosion for 10 years commencing from the date of delivery of the material.

The warranty shall not apply in the following cases :

1. If the corrosion of the casing is caused by external damage to the protective layer such as scratches, projections, abrasion, impacts etc...
2. If the casing is not kept continually clean in the course of maintenance work or by a specialist company,
3. If the casing is not cleaned and maintained in accordance with regulations,
4. If the Rooftop units are installed on a site or in an environment which is known to be corrosive, unless a special protective coating has been applied by the owner for these applications, which has been recommended by a competent body not linked to the owner and after carrying out a study of the site.

Note : With the exception of the casing, the rest of the machine is covered by the warranty of our general terms of sale.

DO NOT CONFUSE THE WARRANTY WITH MAINTENANCE

The warranty will only apply if a maintenance contract has been signed, starting from the date of commissioning, and if the maintenance contract has actually been performed.

The maintenance contract must be made with a specialist,

competent company.

The sole effect of any repair, modification or replacement of an item during the warranty period must be to extend the material's warranty period.

Maintenance must be carried out in accordance with regulations.

If a spare part is supplied after the expiry of the warranty period, it shall be guaranteed for a period equal to the initial warranty period and will be subject to the same conditions.

We recommend for a contract four inspections per year (every three months), before the start of each season, in order to check the operation of the equipment in the various operating modes.



CERTIFICATION



N° QUAL/2001/15834b

**LENNOX FRANCE
DIVISION DE LGL FRANCE**

**CONCEPTION, FABRICATION ET CESSION INTERNE DE ROOF TOP
ET CENTRALES DE TRAITEMENT D'AIR.**

**DESIGN, MANUFACTURING AND INTERNAL TRANSFER OF ROOF TOP
AND AIR HANDLING UNITS.**

2, rue Lavoisier ZI de Longvic BP 60 F-21602 LONGVIC CEDEX

AFAQ certifie que pour les activités et les sites référencés ci-dessus toutes les dispositions mises en œuvre pour répondre aux exigences requises par la norme internationale :
AFAQ certifies that all the arrangements covering the above mentioned activities and locations are established to meet the requirements of the international standard :

ISO 9001 : 2000

ont été examinées et jugées conformes.
have been examined and found conform.

2003-01-24

2006-01-23

(année/mois/jour) Il est valable jusqu'au*
*It is valid until**

(year/month/day)

Le Président du Comité de certification
The President of the Certification Committee

C. GUERIN

Le Directeur Général d'AFAQ
The Managing Director of AFAQ

O. PEYRAT

Le Représentant de l'Entreprise
On Behalf of the Firm

E. MOUTON

*Sauf suspension notifiée entre temps par AFAQ à l'entreprise désignée ci-dessus, le présent document n'a donc qu'une valeur indicative. Seule fait, sur la base de données des certificats AFAQ accessible à l'adresse Internet : <http://www.afaq.org>
 *Ecosignation AFAQ est conforme aux normes internationales en vigueur (guide ISO/IEC 92 - norme EN 45012). Les accréditations détenues par AFAQ et ses filiales sont disponibles à l'adresse Internet : <http://www.afaq.org/accréditation>
 AFAQ se réserve le droit de modifier, à tout moment et sans préavis la forme de ce document de certification. Ce document, et notamment le logo y figurant, ne peut être utilisé par son titulaire que dans le respect des obligations légales et d'une communication claire et précise.
 *Excepting suspension by AFAQ to the above-mentioned company of its accreditations. This document is for information purposes only. For up-to-date information, the only official source is the AFAQ certification database at <http://www.afaq.org>
 The AFAQ organization complies with the international standards in force (ISO/IEC Guide 62 - EN 45012 standard). Information on the accreditations held by AFAQ and its subsidiaries is available at: <http://www.afaq.org/accréditation>
 AFAQ reserves the right to modify, at anytime and without any notice, the shape of this certification document. This document and most specially the logo featuring on this document can only be used by its holder in the frame respecting the legal requirements and a clear and precise communication.



LENNOX®

Site Industriel de LONGVIC
ZI de LONGVIC - BP 80
21802 LONGVIC - France

Téléphone : +33 (0)3 80 77 41 41
Fax : +33 (0)3 80 66 66 35

DECLARATION DE CONFORMITE DU CONSTRUCTEUR
Conformément
à la Directive européenne « Equipement sous pression » 97/23/CE,

CE CONFORMITY DECLARATION
As defined by
« Pressure equipment » Directive 97/23/EC,

LGL France SA, ZI Les Meurières - 69780 Mions - France

La société soussignée certifie sous sa seule responsabilité que l'ensemble de nos fabrications de roof top désignés par les types suivants :
The company hereby declare, under its own responsibility, that the entire roof top range which designations are :

FCA FHA FGA FDA FCK FHK FGK FDK
FXA FXK
BCK BHK BGK BDK

Qui contiennent des fluides frigorigènes classés en groupe 2 (R22 et R407C),
Which are containing refrigerating fluids classified in group 2 (R22 et R407C),

Sont conformes aux dispositions de la Directive « Equipements sous pression », 97/23/CE
Is in compliance with the requirements of « Under pressure equipments » directive, 97/23/EC :

Catégorie *Category* : II

Module d'évaluation *Evaluation Module* : D1

Organisme notifié *Notified body* : Bureau VERITAS

17 bis, place des reflets - La DEFENSE 2 - 92400 Courbevoie.

Sont conformes aux dispositions de la Directive - *Are in compliance with the requirements of*
« Machines », 98/37/CE - « Machinery », 98/37/EC

« Basse Tension », 73/23/CEE modifiée - « Low voltage », 73/23/EEC amended

« CEM », 89/336/CEE - « EMC », 89/336/EEC

« Appareils à gaz », 90/396/CEE modifiée - « Gas machines », 90/396/EEC amended

Ces produits sont fournis avec un marquage de conformité .

The products are provided with a marking of conformity.

Date : 22 Mai 2003 / May 22th 2003

E. MOUTON
Directeur du site de Longvic

LENNOX France, Division climatisation de LGL France

Siège social : LGL France - ZI « Les Meurières » - BP71 - 69780 MIONS - France

Société anonyme au capital de 309.615.120F - RCS LYON B 309 528 115 - N° IDENTIFICATION TVA FR 69 300 528 115 - APE 292F



le futur en construction

SÉCURITÉ FEU
Réaction au feu

cofrac

Accréditation
n° 1-0300



PROCÈS-VERBAL DE CLASSEMENT DE RÉACTION AU FEU D'UN MATÉRIAU

Prévu à l'article 88 de l'Arrêté du Ministère de l'Intérieur du 30 juin 1983,
modifié par l'arrêté du 28 août 1991
Laboratoire pilote agréé du Ministère de l'Intérieur (arrêté du 05/02/99, modifié)

N° RA00-461

Valable 5 ans à compter du 17 octobre 2000

Matériau présenté par : La Société SAINT GOBAIN ISOVER FRANCE
Les Miroirs
18 avenue d'Alsace
92400 COURBEVOIE

Marque commerciale : CLIMAVER 202 - FIB-AIR ISOL

Description sommaire :
Feutre en laine de verre (fibres de verre liées par une résine thermodurcissable) revêtu
sur une face d'une feuille d'aluminium renforcée d'une grille de verre. Le complexe
aluminium est contrecollé à l'aide d'une colle polyéthylène.
Épaisseurs : 25 à 50 mm. Masse volumique nominale de la laine de verre : 30 kg/m³

Nature de l'essai : Essai par rayonnement avec joint simulé suivant
avis CECMI en date du 08 avril 1993.
Mesure du Pouvoir Calorifique Supérieur

Classement :

MO

Durabilité du classement (Annexe 22) : Non limitée
compte tenu des critères résultant des essais décrits dans le rapport d'essais N° RA00-461 annexé.

Le classement indiqué ne préjuge pas de la conformité des matériaux commercialisés aux échantillons soumis aux
essais et ne saurait en aucun cas être considéré comme un certificat de qualification tel que défini par la loi. Cette
conformité peut être attestée par les certificats de qualification reconnus par le ministère chargé de l'industrie, et
notamment par la marque NF - Réaction au Feu.

Champs/Marne le : 17 octobre 2000

Le technicien vérificateur

Bruce LE MADEC

Le Chef du laboratoire Réaction feu
responsable de l'essai

Martial BONHOMME

Sont seules autorisées les reproductions intégrales du présent procès-verbal de classement ou de l'ensemble procès-verbal de
classement et rapport d'essais annexé.

PARIS - MARNE-LA-VALLÉE - GRENOBLE - NANTES - SOPHIA ANTIPOLIS
CENTRE SCIENTIFIQUE ET TECHNIQUE DU BÂTIMENT

84, avenue Jean-Jaurès - Champs-sur-Marne - BP 2 - F-77421 Marne-la-Vallée Cedex 2
Tél. : 01 64 68 84 12 - Fax : 01 64 68 84 79 - E-mail : reaction@castb.fr - http://www.castb.fr/feu



Certificat Certificate

CE 0049

(Directive 90/396/CEE « Appareils à gaz »)
(« Gas appliances » 90/396 EEC Directive)

Numéro : **49AR1674** (rév. 6)

AFNOR CERTIFICATION, après examen et vérifications, certifie que l'appareil :
AFNOR CERTIFICATION, after examination and verifications, certifies that the appliance:

- **Fabriqué par :** **LENNOX FRANCE**
Manufactured by **Z.I. LONGVIC**
BP 60
F-21602 LONGVIC CEDEX
- **Marque commerciale et modèle(s) :** **LENNOX**
Trade mark and model(s) : **> GM 033/2**
- **Genre de l'appareil :** **MODULE DE CHAUFFAGE POUR**
Kind of the appliance : **CLIMATISEURS DE TOITURE**
GAS AIR HEATER UNIT FOR ROOF TOP
- **Désignation du type :** **GM 033/2**
Type designation:

Pays de destination <i>Destination countries</i>	Pressions (mbar) <i>Pressures (mbar)</i>	Catégories <i>Categories</i>
FR	20/25 ; 37	I12Er3P
BE	20/25 ; 37	I2EB ; I3P
PT-CH-ES-GB	20 ; 37	I12H3P
DE	20 ; 50	I2E ; I3P
IT	20	I2H
NL	25 ; 37-50	I12L3P

est conforme aux exigences essentielles de la directive "Appareils à gaz" 90/396/CEE (29/06/1990).
is in conformity with the essential requirements of the "Gas appliances" directive 90/396/EEC (29/06/1990).

AFNOR CERTIFICATION
Le Directeur Exécutif

Jacques BESLIN



Paris le : 27 mars 2002

Rév. 6 : 49AR1674 du 96/09/02

11 avenue Francis de Pressensé - 93571 Saint-Denis La Plaine Cedex - France

Tél. : +33 (0)1 41 62 76 60 - Fax : +33 (0)1 48 17 91 91

certification@afnor.fr

www.afnor.fr - www.marque-af.com



AFNOR CERTIFICATION

Certificat Certificate

CE 0049

(Directive 90/396/CEE « Appareils à gaz »)
(« Gas appliances » 90/396 EEC Directive)

Numéro : **49AR1675** (rév. 6)

AFNOR CERTIFICATION, après examen et vérifications, certifie que l'appareil :
AFNOR CERTIFICATION, after examination and verifications, certifies that the appliance:

- **Fabriqué par :**
Manufactured by **LENNOX FRANCE**
Z.I. LONGVIC
BP 60
F-21602 LONGVIC CEDEX
- **Marque commerciale et modèle(s) :**
Trade mark and model(s) : **LENNOX**
➤ **GM 060/2**
- **Genre de l'appareil :**
Kind of the appliance : **MODULE DE CHAUFFAGE POUR**
CLIMATISEURS DE TOITURE
GAS AIR HEATER UNIT FOR ROOF TOP
- **Désignation du type :**
Type designation: **GM 060/2**

Pays de destination <i>Destination countries</i>	Pressions (mbar) <i>Pressures (mbar)</i>	Catégories <i>Categories</i>
FR	20/25 ; 37	I12Er3P
BE	20/25 ; 37	I2EB ; I3P
PT-CH-ES-GB	20 ; 37	I12H3P
DE	20 ; 50	I2E ; I3P
IT	20	I2H
NL	25 ; 37-50	I12L3P

est conforme aux exigences essentielles de la directive "Appareils à gaz" 90/396/CEE (29/06/1990).
is in conformity with the essential requirements of the "Gas appliances" directive 90/396/EEC (29/06/1990).

AFNOR CERTIFICATION
Le Directeur Exécutif

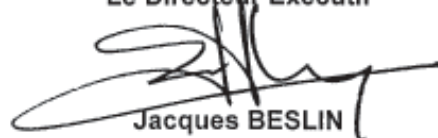
Jacques BESLIN



Paris le : 27 mars 2002

Rév. 6 : 49AR1675 du 96/09/02

11 avenue Francis de Pressensé - 93571 Saint-Denis La Plaine Cedex - France

Tel. : +33 (0)1 41 82 76 60 - Fax : +33 (0)1 49 17 91 91

certification@afnor.fr

www.afnor.fr - www.marque-afnor.com



AFNOR CERTIFICATION

Groupe AFNOR

Certificat Certificate

CE 0049

(Directive 90/396/CEE « Appareils à gaz »)
(« Gas appliances » 90/396 EEC Directive)

Numéro : **49AR1860** (rév. 6)

AFNOR CERTIFICATION, après examen et vérifications, certifie que l'appareil :
AFNOR CERTIFICATION, after examination and verifications, certifies that the appliance:

- **Fabriqué par :** **LENNOX FRANCE**
Manufactured by **Z.I. LONGVIC**
BP 60
F-21602 LONGVIC CEDEX
- **Marque commerciale et modèle(s) :** **LENNOX**
Trade mark and model(s) : **> GM 120/2**
- **Genre de l'appareil :** **MODULE DE CHAUFFAGE POUR**
Kind of the appliance : **CLIMATISEURS DE TOITURE**
GAS AIR HEATER UNIT FOR ROOF TOP
- **Désignation du type :** **GM 120/2**
Type designation:

Pays de destination <i>Destination countries</i>	Pressions (mbar) <i>Pressures (mbar)</i>	Catégories <i>Categories</i>
FR	20/25 ; 37	I12Er3P
BE	20/25 ; 37	I2EB ; I3P
PT-CH-ES-GB	20 ; 37	I12H3P
DE	20 ; 50	I2E ; I3P
IT	20	I2H
NL	25 ; 37-50	I12L3P

est conforme aux exigences essentielles de la directive "Appareils à gaz" 90/396/CEE (29/06/1990).
is in conformity with the essential requirements of the "Gas appliances" directive 90/396/EEC (29/06/1990).

AFNOR CERTIFICATION
Le Directeur Exécutif

Jacques BESLIN



Paris le : 27 mars 2002

Rév. 6 : 49AR1860 du 96/09/02

11 avenue Francis de Pressensé - 93571 Saint-Denis La Plaine Cedex - France

Tél : +33 (0)1 41 62 76 60 - Fax : +33 (0)1 49 17 91 91

certification@afnor.fr

www.afnor.fr - www.marque-nf.com



AFNOR CERTIFICATION

Certificat Certificate

CE 0049

(Directive 90/396/CEE « Appareils à gaz »)
(« Gas appliances » 90/396 EEC Directive)

Numéro : **49BL3276** (rév. 1)

AFNOR CERTIFICATION, après examen et vérifications, certifie que l'appareil :
AFNOR CERTIFICATION, after examination and verifications, certifies that the appliance:

- **Fabriqué par :**
Manufactured by **LENNOX FRANCE**
Z.I. LONGVIC
BP 60
F-21602 LONGVIC CEDEX
- **Marque commerciale et modèle(s) :**
Trade mark and model(s) : **LENNOX**
➤ **GM 180/4**
- **Genre de l'appareil :**
Kind of the appliance : **MODULE DE CHAUFFAGE POUR**
CLIMATISEURS DE TOITURE
GAS AIR HEATER UNIT FOR ROOF TOP
- **Désignation du type :**
Type designation: **GM 180/4**

Pays de destination <i>Destination countries</i>	Pressions (mbar) <i>Pressures (mbar)</i>	Catégories <i>Categories</i>
FR	20/25 ; 37	I12Er3P
BE	20/25 ; 37	I2EB ; I3P
PT-CH-ES-GB	20 ; 37	I12H3P
DE	20 ; 50	I2E ; I3P
IT	20	I2H
NL	25 ; 37-50	I12L3P

est conforme aux exigences essentielles de la directive "Appareils à gaz" 90/396/CEE (29/06/1990).
is in conformity with the essential requirements of the "Gas appliances" directive 90/396/EEC (29/06/1990).

AFNOR CERTIFICATION
Le Directeur Exécutif

Jacques BESLIN



Paris le : 27 mars 2002



Rév. 1 : 49BL3276 du 2000/06/30

11 avenue Francia de Pressensé - 93571 Saint-Denis La Plaine Cedex - France
Tél. : +33 (0)1 41 62 76 60 - Fax : +33 (0)1 49 17 81 81

certification@afnor.fr
www.afnor.fr - www.marque-nf.com



Organisme certificateur
AFNOR CERTIFICATION
11, avenue Francis de Pressensé
93571 SAINT-DENIS LA PLAINE Cedex
☎ : (33) 1.47.62.76.60 - Fax : (33) 1.49.17.91.91
Site Internet : <http://www.marque-nf.com>

Marque NF – Matériels de Détection Incendie



LA SECURITE CERTIFIEE

Organisme mandaté
Comité National Méhobélance Incendie Sécurité sas
C.N.M.I.S. sas - 14, avenue Hoche - 75008 PARIS
☎ : (33) 1.53.89.00.40 - Fax : (33) 1.45.63.40.63
Site Internet : <http://www.cnmis.org>

CERTIFICAT DE DROIT D'USAGE DE LA MARQUE NF (LICENCE)

N° DROIT D'USAGE
DAD 020 B0

La Société :
Pour son usine de

ANELEC
37, place de Loire SILIC 139
94523 RUNGIS Cedex

Correspondant C.N.M.I.S SAS
José CAMPO Tél : 01 53 89 00 48
Fax : 01 45 63 40 63

Date de fin de validité :
31/03/2004

N° Dossier C.N.M.I.S SAS
99 06 55
Conformité aux normes :
NF S 61-950 de Novembre 1985
NF S 61-961 de Septembre 1989

MODIFICATIONS

Est autorisée à apposer la marque NF sur le matériel désigné ci-après :

Désignation technique du matériel	: Détecteur Autonome Déclencheur
Désignation commerciale	: DAD 4480 CGDI
Caractéristiques certifiées	: Type 2
Nombre de détecteurs	: 2 <i>(Les autres caractéristiques sont reprises dans les rapports d'essai)</i>
Ce matériel fonctionne avec	: Le détecteur SIJ-EF (E4 064 B0) <i>(Les autres produits associés sont repris dans les certificats d'association)</i>
Références et date des rapports d'essais	: DH 95 01 11 du 14 Mars 1996
Fonctions supplémentaires	: Voir rapports référencés ci-dessus

N.B : Cette décision dispense le titulaire de la présentation des Procès Verbaux d'essai (incluant les rapports d'essais) de conformité aux normes du matériel ci-dessus.

PARIS, le 14 février 2003
Par mandat d'AFNOR CERTIFICATION
Le C.N.M.I.S. S.A.S

Le Directeur Général
Denis CLUZEL



ACCREDITATION N° 5-0015

Ce certificat annule et remplace tout certificat antérieur, sa date de validité est confirmée sous réserve des contrôles effectués par AFNOR CERTIFICATION et/ou le C.N.M.I.S. sas qui peuvent prendre toute sanction conformément aux Règles Générales de la marque NF et au Règlement R075. Ce certificat atteste que les produits désignés sont certifiés conformes au référentiel technique du Règlement R075 et que le système qualité de la société a été évalué selon ce même Règlement. Il n'engage en aucun cas AFNOR CERTIFICATION et le C.N.M.I.S. sas quant à la conformité réglementaire de l'installation dans laquelle les produits objets de ce certificat seront utilisés.

13/06 2003 VEN 14:51 FAX

002/002



Organisme certificateur
AFNOR CERTIFICATION
11, avenue François de Mitterrand
93571 SAINT-DENIS LA PLAINE Cedex
☎ : (33) 1.47.62.76.60 • Fax : (33) 1.49.17.31.51
Site Internet : <http://www.marque-nf.com>

Marque NF – Matériels de Détection Incendie



LA SECURITE CERTIFIEE
Organisme mandaté
Comité National Métréologie Incendie Sécurité S&D
C.N.M.I.S. SAS - 16, avenue Hoche - 75008 PARIS
☎ : (33) 1.53.89.00.40 • Fax : (33) 1.45.63.40.63
Site Internet : <http://www.cnmis.org>

CERTIFICAT DE DROIT D'USAGE DE LA MARQUE NF (LICENCE)

N° DROIT D'USAGE
DAD 013 J0 Le 27/05/2003

La Société : **FINSECUR**
Pour son usine de 15, rue du Général Négrier
78800 HOUILLES

Correspondant C.N.M.I.S. SAS
José CAMPO Tél : 01 53 89 00 48
Fax : 01 45 63 40 63

Date de fin de validité :
31/03/2004

N° Dossier C.N.M.I.S. SAS
03 03 18
Conformité aux normes :
NF S 61-961 de Septembre 2000

MODIFICATIONS

Est autorisée à apposer la marque NF sur le matériel désigné ci-après :

Désignation technique du matériel : **Détecteur Autonome Déclencheur**
Désignation commerciale : **LOTUS 1 W2C**
Caractéristiques certifiées : **Type II**
Elément sensible : **2 TYPE E4**
(Les autres caractéristiques sont reprises dans les rapports d'essai)
Ce matériel fonctionne avec : **Voir liste des matériels associés**
Références et date des rapports d'essais : **DH 03 01 76 du 14 Mai 2003 (Fiche Technique N° 1441)**
Fonctions supplémentaires : **Voir rapports référencés ci-dessus**

N.B : Cette décision dispense le titulaire de la présentation des Procès Verbaux d'essai (incluant les rapports d'essais) de conformité aux normes du matériel ci-dessus.

PARIS, le 11 juin 2003
Par mandat d'AFNOR CERTIFICATION
Le C.N.M.I.S. S.A.S

Le Directeur Général
Denis CLUZEL



LA SECURITE CERTIFIEE

Ce certificat annule et remplace tout certificat antérieur, sa date de validité est confirmée sous réserve des contrôles effectués par AFNOR CERTIFICATION et/ou le C.N.M.I.S. SAS qui peuvent prendre toute sanction conformément aux Règles Générales de la marque NF et au Règlement R075. Ce certificat atteste que les produits désignés sont certifiés conformes au référentiel technique du Règlement R075 et que le système qualité de la société a été évalué selon ce même Règlement. Il n'engage en aucun cas AFNOR CERTIFICATION et le C.N.M.I.S. SAS quant à la conformité réglementaire de l'installation dans laquelle les produits objets de ce certificat seront utilisés.



ACCREDITATION N° 5-0115



SÉCURITÉ FEU
Réaction au feu

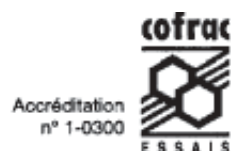

PROCÈS-VERBAL DE CLASSEMENT DE RÉACTION AU FEU D'UN MATÉRIAU

Prévu à l'article 88 de l'Arrêté du Ministère de l'Intérieur du 30 juin 1983,
modifié par l'arrêté du 28 août 1991
Laboratoire pilote agréé du Ministère de l'Intérieur (arrêté du 05/02/59, modifié)

N° RA01-279

Valable 5 ans à compter du 26 juin 2001

Matériau présenté par : La Société CAMFIL FARR
Route d'Avrigny
ZI Saint Martin Longueau
60722 PONT SAINTE MAXENCE

Marque commerciale : A300F1

Description sommaire :
Média filtrant 100% fibres polyester non ignifugé.
Masse surfacique nominale : 198 g/m². Épaisseur nominale : 20 mm. Coloris : Blanc

Nature de l'essai : Essai au Brûleur Électrique
Essais Complémentaires

Classement :

M1

Durabilité du classement (Annexe 22) : Non limitée a priori (Filtre non régénérable)
compte tenu des critères résultant des essais décrits dans le rapport d'essais N° RA01-279 annexé.

Le classement indiqué ne préjuge pas de la conformité des matériaux commercialisés aux échantillons soumis aux essais et ne saurait en aucun cas être considéré comme un certificat de qualification tel que défini par la loi. Cette conformité peut être attestée par les certificats de qualification reconnus par le ministère chargé de l'Industrie, et notamment par la marque NF - Réaction au Feu.

Champs/Marne le : 26 juin 2001

Le technicien responsable de l'essai

Nicolas ROURE

Le chef du laboratoire Réaction au Feu

Martial BONHOMME

Sont seules autorisées les reproductions intégrales du présent procès-verbal de classement ou de l'ensemble procès-verbal de classement et rapport d'essais annexé.

PARIS - MARNE-LA-VALLÉE - GRENOBLE - NANTES - SOPHIA ANTIPOLIS
CENTRE SCIENTIFIQUE ET TECHNIQUE DU BÂTIMENT

84, avenue Jean-Jaurès - Champs-sur-Marne - BP 2 - F-77421 Marne-la-Vallée Cedex 2
Tél. : 01 64 66 64 12 - Fax : 01 64 68 64 79 - E-mail : reaction@csfb.fr - <http://www.csfb.fr/feu>



SÉCURITÉ FEU
Réaction au feu

Accréditation
n° 1-0300



PROCÈS-VERBAL DE CLASSEMENT DE RÉACTION AU FEU D'UN MATÉRIAU

Prévu à l'article 88 de l'Arrêté du Ministère de l'Intérieur du 30 juin 1983,
modifié par l'arrêté du 28 août 1991
Laboratoire pilote agréé du Ministère de l'Intérieur (arrêté du 05/02/59, modifié)

N° RA01-065

Valable 5 ans à compter du 25 janvier 2001

Matériau présenté par : La Société HOLLINGSWORTH and VOSE Compagny LTD
Postlip mills - Winchcombe
GLOS GL54 5BB
ROYAUME UNI

Marque commerciale : MEDIA A100G

Description sommaire :
Média filtrant en fibres de verre non tissées liées par une résine acrylique.
Masse surfacique nominale : 63 g/m². Épaisseur nominale : 0,47 mm. Coloris présenté :
blanc.

Nature de l'essai : Essai au Brûleur Électrique

Classement :

M3

Durabilité du classement (Annexe 22) : Non limitée a priori Article non régénérable
compte tenu des critères résultant des essais décrits dans le rapport d'essais N° RA01-065 annexé.

Le classement indiqué ne préjuge pas de la conformité des matériaux commercialisés aux échantillons soumis aux essais et ne saurait en aucun cas être considéré comme un certificat de qualification tel que défini par la loi. Cette conformité peut être attestée par les certificats de qualification reconnus par le ministère chargé de l'Industrie, et notamment par la marque NF - Réaction au Feu.

Champs/Marne le : 25 janvier 2001

Le technicien responsable de l'essai

Le chef du laboratoire Réaction au Feu

David BETTOIA

Martial BONHOMME

Sont seules autorisées les reproductions intégrales du présent procès-verbal de classement ou de l'ensemble procès-verbal de classement et rapport d'essais annexé.

PARIS - MARNE-LA-VALLÉE - GRENOBLE - NANTES - SOPHIA ANTIPOLIS
CENTRE SCIENTIFIQUE ET TECHNIQUE DU BÂTIMENT

84, avenue Jean-Jaurès - Champs-sur-Marne - BP 2 - F-77421 Marne-la-Vallée Cedex 2
Tél. : 01 64 88 84 12 - Fax : 01 64 88 84 79 - E-mail : reaction@csfb.fr - http://www.csfb.fr/feu

BELGIUM,
LUXEMBOURG : LENNOX BENELUX N.V./S.A.
tel. : + 32 3 633 30 45
fax : + 32 3 633 00 89
e-mail : info.be@lennoxbenelux.com

CZECH REPUBLIC : JANKA LENNOX a.s.
tel. : + 420 2 510 88 111
fax : + 420 2 579 10 393
e-mail : janka@janka.cz

FRANCE : LENNOX FRANCE
tel. : + 33 1 64 76 23 23
fax : + 33 1 64 76 35 75
e-mail : marketing.france@lennoxfrance.com

GERMANY : LENNOX DEUTSCHLAND GmbH
tel. : + 49 69 42 09790
fax : + 49 69 42 09 79 40
e-mail : info.de@lennoxdeutschland.com

NETHERLANDS : LENNOX BENELUX B.V.
tel. : + 31 33 2471 800
fax : + 31 33 2459 220
e-mail : info@lennoxbenelux.com

POLAND : LENNOX POLSKA Sp. z o.o.
tel. : + 48 22 832 26 61
fax : + 48 22 832 26 62
e-mail : info@lennoxpolska.pl

PORTUGAL : LENNOX PORTUGAL LDA.
tel. : +351 22 998 33 70
fax : +351 22 998 33 79
e-mail : info@lennoxportugal.com

RUSSIA : LENNOX DISTRIBUTION MOSCOW
tel. : + 7 095 246 07 46
fax : + 7 502 933 29 55
e-mail : lennox.dist.moscow@netmaster.ru

SLOVAKIA : LENNOX SLOVENSKO s.r.o.
tel. : + 421 2 44 87 19 27
fax : + 421 2 44 88 64 72
e-mail : lennox.slovensko@lennox.sk

SPAIN : LENNOX REFAC S.A.
tel. : + 34 915 40 18 10
fax : + 34 915 42 84 04
e-mail : marketing@lennox-refac.com

UKRAINE : LENNOX DISTRIBUTION KIEV
tel. : + 380 44 213 14 21
fax : + 380 44 213 14 21
e-mail : jankauk@uct.kiev.ua

UNITED KINGDOM,
IRELAND : LENNOX INDUSTRIES LTD
tél. : + 44 1604 599400
fax : + 44 1604 594200
e-mail : ukmarketing@lennoxind.com

OTHER EUROPEAN COUNTRIES,
AFRICA,
MIDDLE-EAST : LENNOX DISTRIBUTION
tel. : + 33 4 72 23 20 14
fax : + 33 4 72 23 20 28
e-mail : marketing@lennoxdist.com



LENNOX®

www.lennox europe.com

FLEXY_IOM/0903-E

Due to Lennox's ongoing commitment to quality, Specifications, Ratings and Dimensions subject to change without notice and without incurring liability. Improper installation, adjustment, alteration, service or maintenance can cause property damage or personal injury. Installation and service must be performed by a qualified installer and servicing agency.