

User manual **ADALINK**



- Providing indoor climate comfort

ADALINK

INSTALLATION OPERATING & MAINTENANCE MANUAL

Ref : ADALINK_IOM-0907-E

LENNOX have been providing environmental solutions since 1895, our range of Baltic™ rooftop continues to meet the standards that have made LENNOX a household name. Flexible design solutions to meet YOUR needs and uncompromising attention to detail. Engineered to last, simple to maintain and Quality that comes as standard. Information on local contacts at www.lennox europe.com.

All the technical and technological information contained in this manual, including any drawing and technical descriptions provided by us, remain the property of Lennox and must not be utilised (except in operation of this product), reproduced, issued to or made available to third parties without the prior written agreement of Lennox.

CONTENTS

1 - INTRODUCTION.....	3
1.1 – Contents - Reception - Control.....	3
1.2 – Housing.....	4
1.3 – Front panel control LED.....	4
1.4 – Connections.....	5
2 - INSTALLATION	9
2.1 – Connections to the units.....	9
2.2 – Internet explorer / Flash player / Java set up	10
2.3 – Start up.....	10
2.4 – Customer network connection	11
2.5 – Connection to the phone line or GSM	14
2.6 – FTP connection.....	15
3 - SET UP OF THE ADALINK.....	17
3.1 – Languages.....	17
3.2 – Access management	17
3.3 – Note book	18
3.4 – Configuration	19
3.5 – Calendar.....	24
3.6 – Macro-command	18
4 - FUNCTIONING.....	26
4.1 – Remote control of the unit.....	26
6.2 – Supervision of the unit.....	26

1. INTRODUCTION

You must read and be familiarized with this instruction manual before the start-up of the ADALINK. You must apply the following instructions.

We lay stress on the importance of training for a proper use of the Adalink. This Instruction manual must stay close to the Adalink Box.

The Adalink is a terminal that enables access to technical data, whatever their format is. It is configurable by web pages. It is secure because it meets the toughest industrial standards and has restricted access features (required in open networks). The hardware platform of the Adalink embeds a modem (PSTN or GSM/GPRS). The Adalink supports the TCP/IP and PPP protocols. This brings you all the benefits of an universally recognized standard network. It also allows you to use popular software tools like Internet Explorer, FTP client, SNMP Manager, Mail Recipient ... and so to reduce significantly your costs (implementation and ownership).

General specification of the hardware platform

- Processor ARM clocked @ 75Mhz, 8Mb SDRAM, 8 Mb Flash
- Backed up real time clock (RTC) with 24 Hours autonomy
- Battery with 10 years autonomy
- External power supply 12-24 VDC +/- 20%
- 1 Ethernet port 10/100Mb BaseTx
- 1 Serial port configurable in RS232/RS422/RS485
- 1 digital input (DI)
- 1 digital output (DO)
- DIN rail mounting compliant with EN50022 (latch)
- Environmental conditions (operating):
Ambient T°: from 0°C to +50°C
Humidity: from 0 to 80% non condensing

Lennox recommend to install the Adalink Box in a clean area, not in the units and not in a electrical box.

1.1. Contents – Reception – Control

- The Adalink set is made up of:
- Adalink case – distant access loaded and set
- Power supply 220VAC/3-12VDC controlled, protected and 12 VDC preset
- Ethernet connection : RJ45/RJ45, Cat 5E, FTP cable
- Phone connection : RJ12 cable + connection
- Modbus connection : subD9 cable connected to a wire box

Take care when you receive the material, that all these components are present in the box.



Adalink package



Adalink



RS485 cable



Ethernet cable



Power supply



Phone cable

1.2. Housing

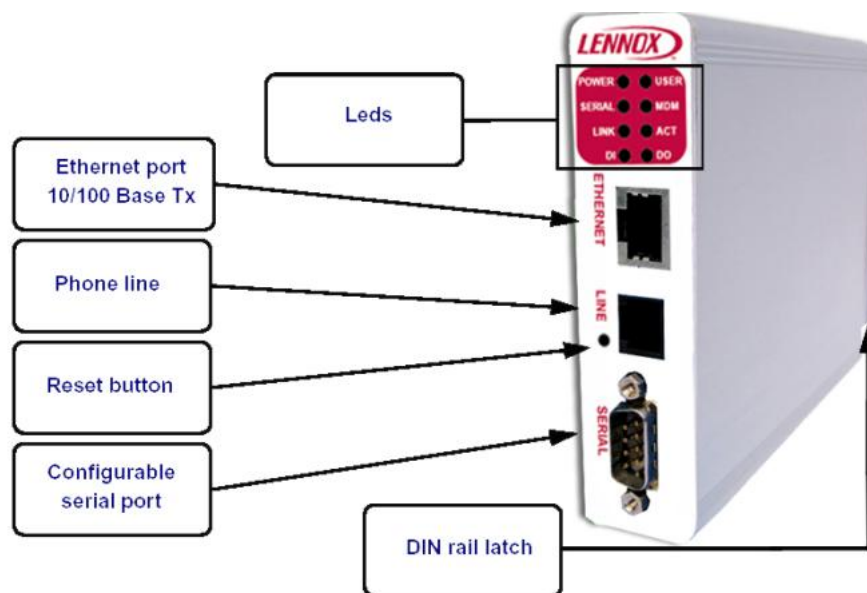

Figure 1: Housing, front view

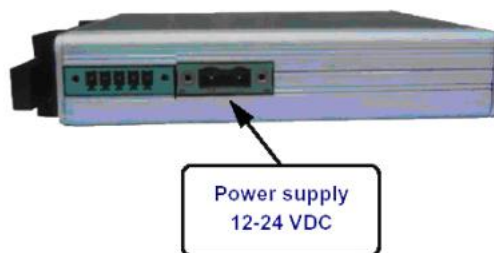

Figure 2: Housing, bottom view

1.3. Front panel control LED

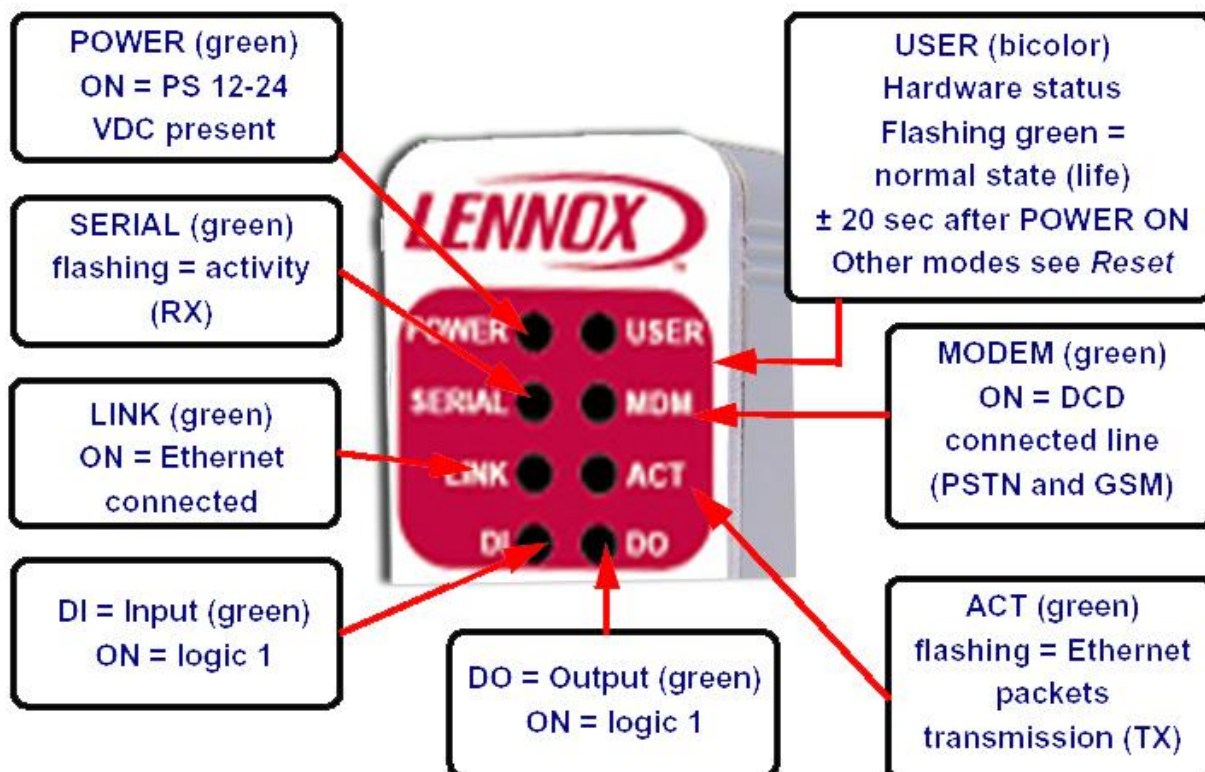

Figure 6: Front Panel leds description

1.4. Connections

1.4.1. Power supply



Figure 10: Adalink Mating female connector (included)

Pinout:

1.4.2. Ethernet

The Adalink can be accessed by a 10/100BaseTX Ethernet connection. This connection can be made with two different cables (straight or crossed). These cables have 8 copper conductors and are known as UTP Class 5 with RJ45 terminations at both ends.

The type of cable (straight or crossed) depends on the equipment the Adalink will be connected to. The most current cases are the direct connection with a PC (crossed) and the connection through a hub/router (straight).



1.4.3. Direct connection

If the Adalink is connected directly to a PC, then use the crossed cable:



When cabling over long distance, you have to take care of the twisted pairs. This means that along with the above cabling conventions, the emission (TX+/TX-) and reception (RX+/RX-) signals have to be connected on the same twisted pair:

TX+: pin3, TX-: pin6	Twisted pair 1
RX+: pin1, RX-: pin2	Twisted pair 2

Pins 4, 5, 7 and 8 do not have to be connected. The following picture shows the twisted pair connections:

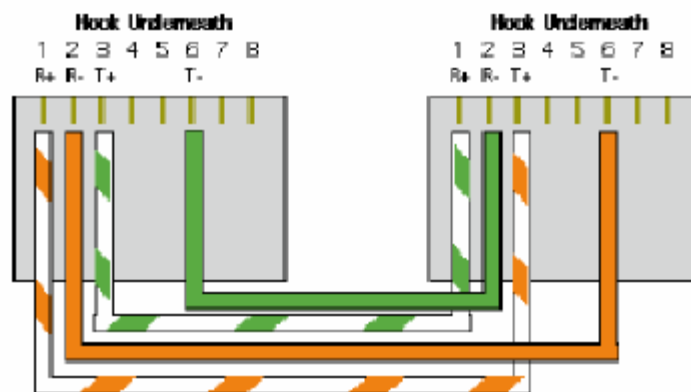

1.4.4.Connection over Hub/Router

If the Adalink is connected to a hub, it has to be connected like any other device, with a straight cable. Again, the wiring is as shown on the following picture, and care should be taken to keep the RX and TX signals on twisted pairs:

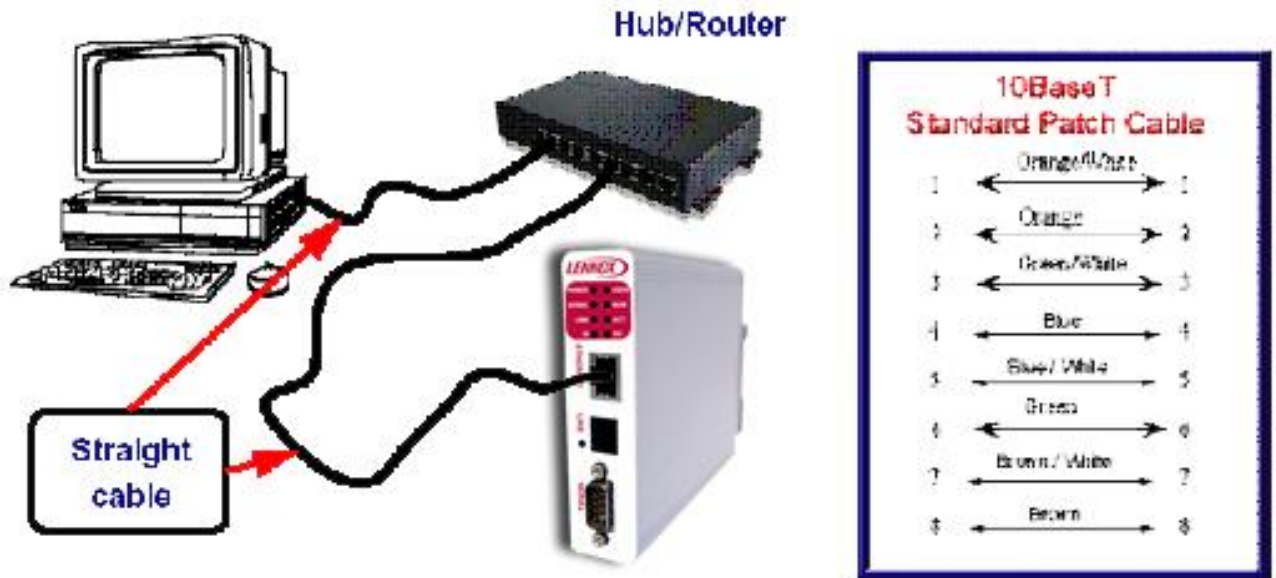

1.4.5. PTSN Phone line connector



Type:	RJ11 type "6P2C" without shield
--------------	---------------------------------

Pinout PST line

Pin N°	Description
1	-
2	-
3	TIP
4	RING
5	-
6	-

Table 16: Pinout PST Line

1.4.6.Serial Port

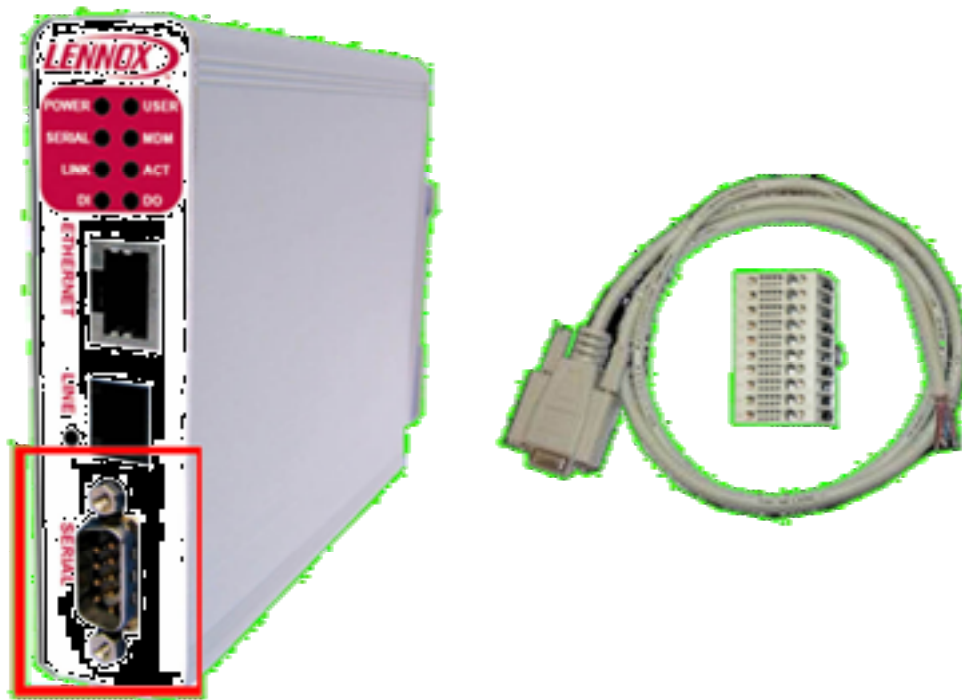

Type	Female DB9 with 4/40 blocking screws
------	--------------------------------------

Pinout serial port (according to mode):

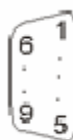

Pin N°	RS485
1	-
2	-
3	A+
4	-
5	GND
6	-
7	-
8	B-
9	-

Table 15: Pinout serial port

1.4.7. Configurable serial port

The configuration of the physical serial mode is done by a set of 4 dip switches located on left side from the unit. The settings of the switches are shown in the table below (note: switch 1 is the most right one).

Positions	Mode
	RS422, RS485 WITHOUT polarisation and termination resistors
	RS422, RS485 WITH polarisation and termination resistors

Note: the 3 switch configurations shown here above are the sole configurations giving satisfactory results. See important remarks about this configuration on the next page.

Warning: Contrary to indications on the label, the switch 2 is reserved and must stay OFF. Note that switch 3 & 4 need to have the same position (both ON or both OFF). When they are ON, it connects the internal polarisation (typ 680 Ohms) and termination (typ 120 Ohms) resistors. This configuration applies only to RS4xx lines conforming to good practices.

2. INSTALLATION

2.1. Connections to the units

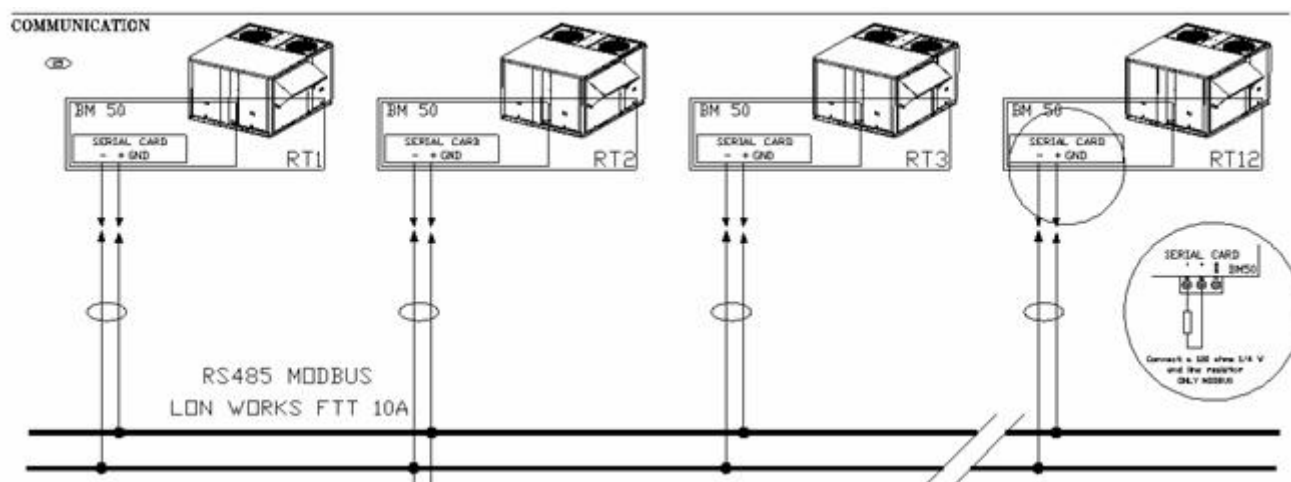

The communication bus is connected to the Climatic™ on the 'Serial Card' connection on the daughter card of the BM50.

A star connection is not recommended, in order to have a perfect function it is advisable to connect max 2 cables per units.

A 120Ω 1/4W resistance must be connected on the last unit between -&- connections.

For the connection, you must use :

Cable length 0 to 300m : AWG22 (0.34 mm²), 1 cross pair + screen.

Cable length 0 à 1000m : LiYCY-P (0.34 mm²), 1 pair fully armoured

The length of the cable does not exceed 1000m.

For better protection against electromagnetic disruptions, Lennox recommends the use of LiYCY-P cable.

A software version 50.20 minimum is mandatory and on you to set the following CL50 variables:

- 3931 ID address different for each unit ,
- 3932 Protocol set on Adalink
- 3933 Baud Speed set 9600

2.2. Internet Explorer / Flash player / Java set up

To be sure to be able to run Adalink from your Internet Explorer you need a Java and Flash Player add-on. You need to download this add-on from the CD. And of course to install the software.

2.3. Start up

To do the start up of the Adalink, you need to connect the Adalink to your PC via a cross cable:

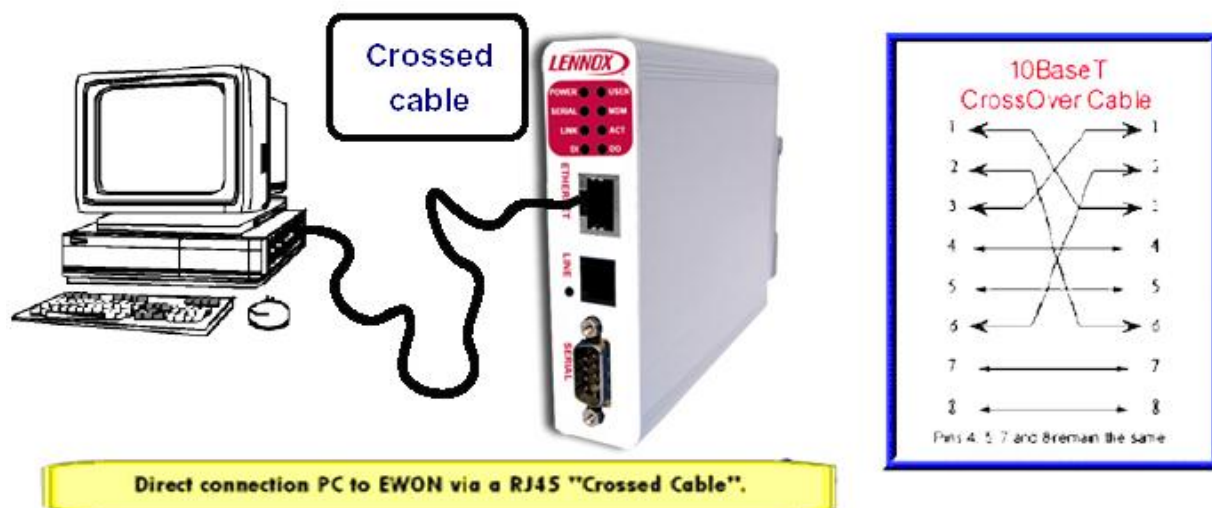

To connect your PC to the Adalink, you need to go on your computer on the control panel and the network configuration:

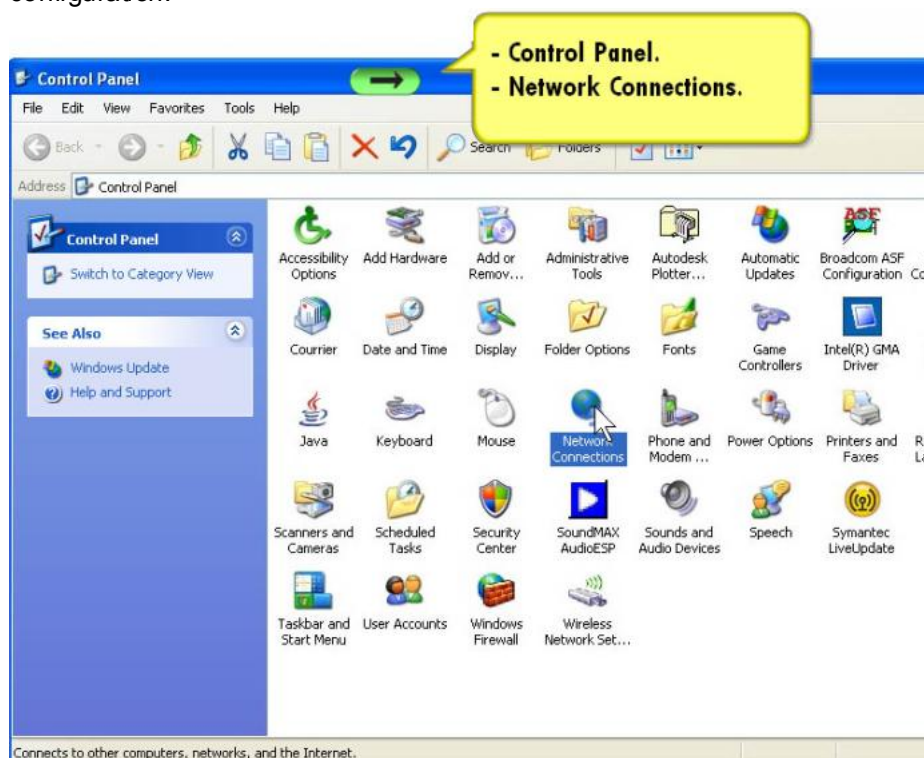

and open the local area connections and configure it:

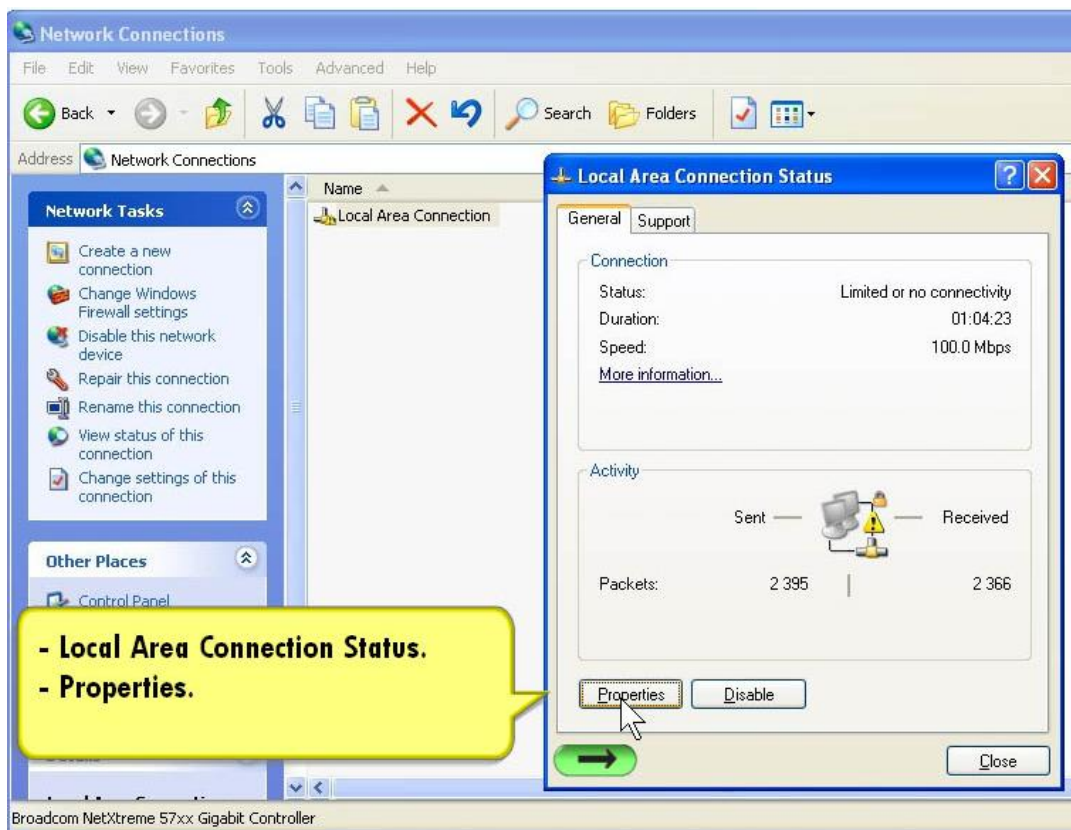
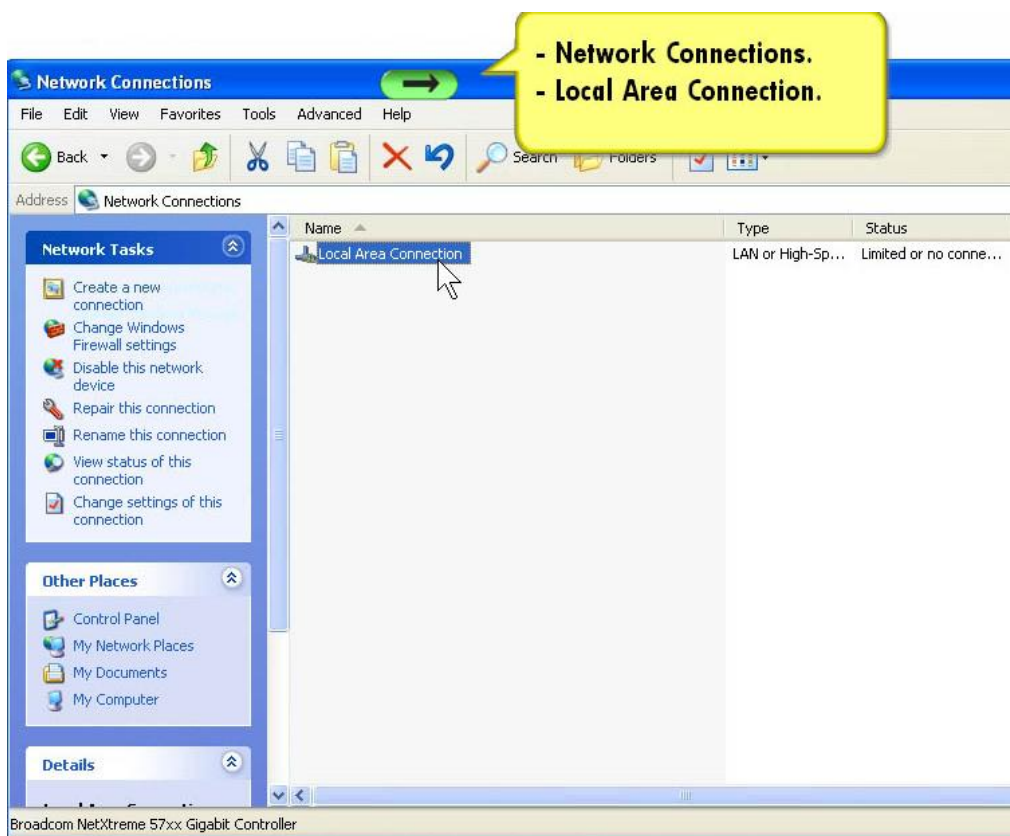

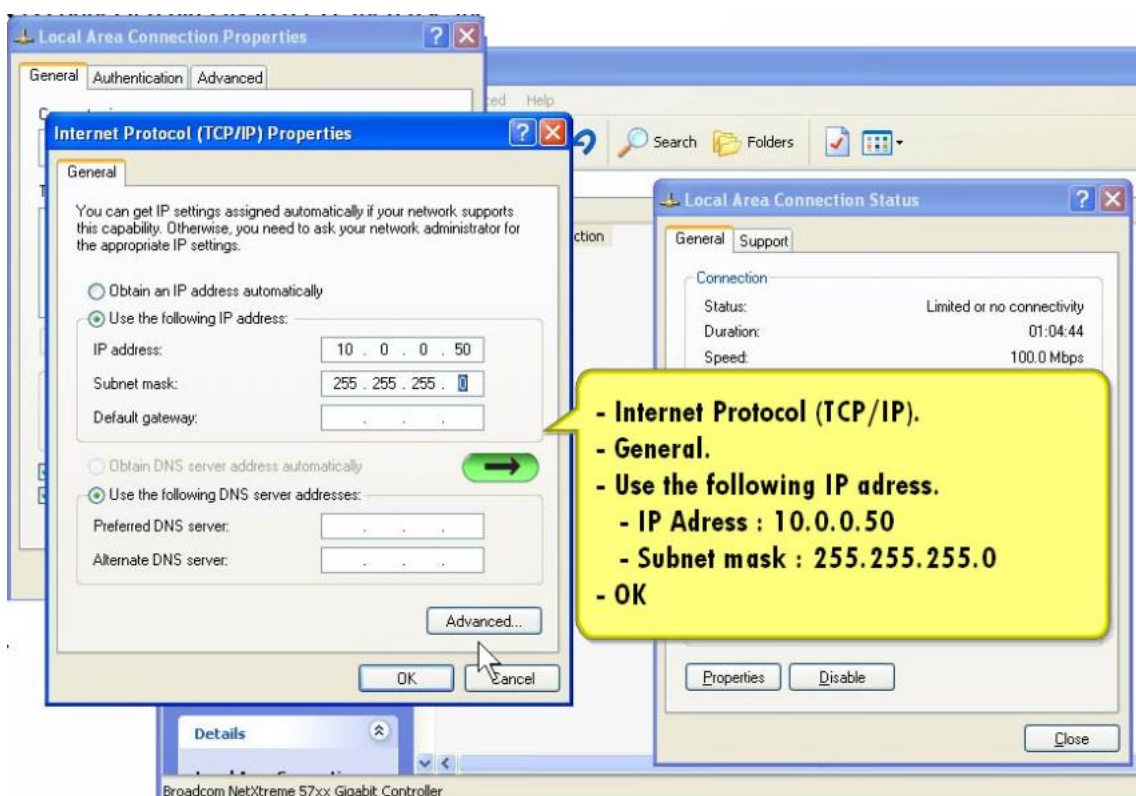
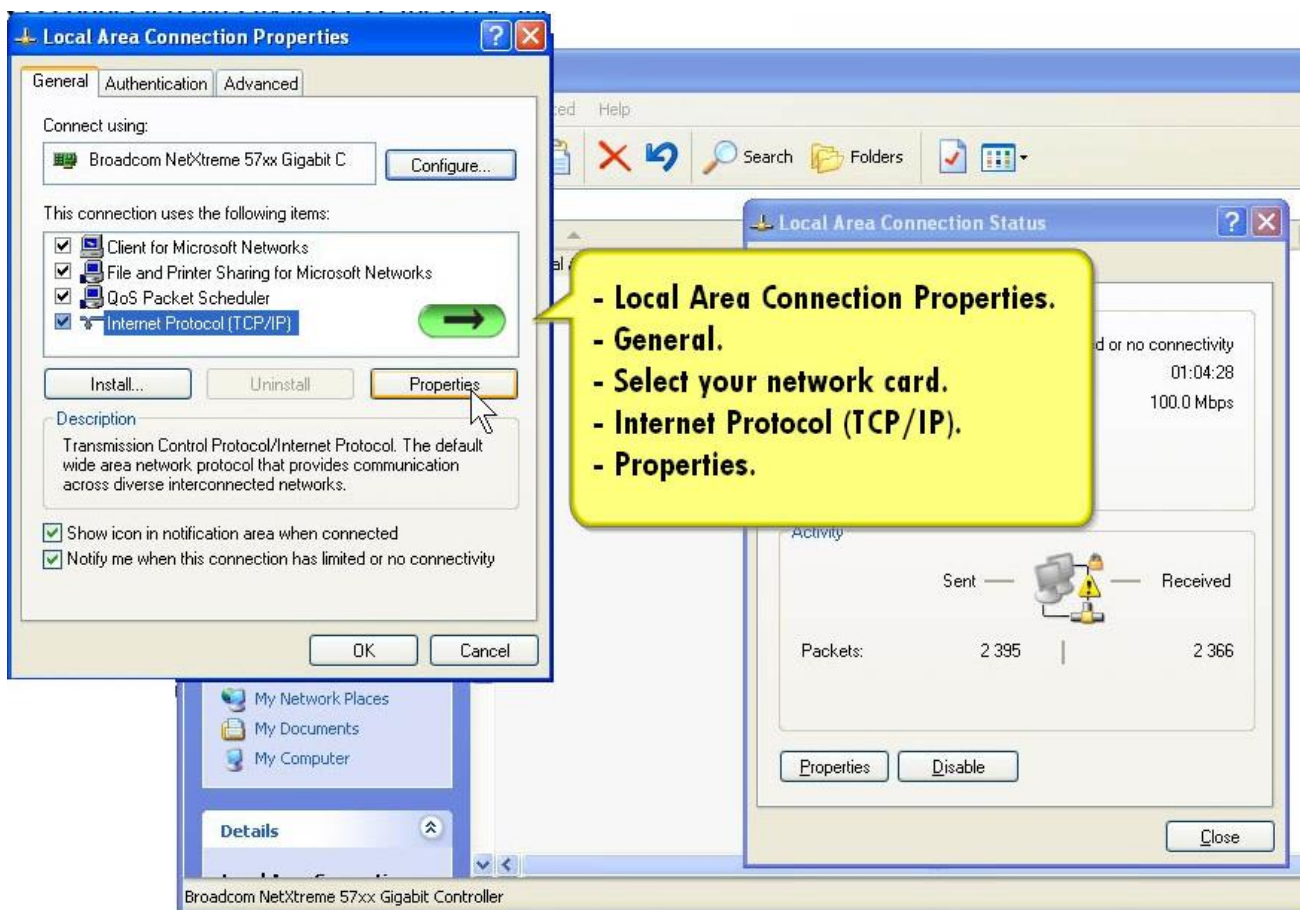

You close all the windows by ok and open internet explorer:

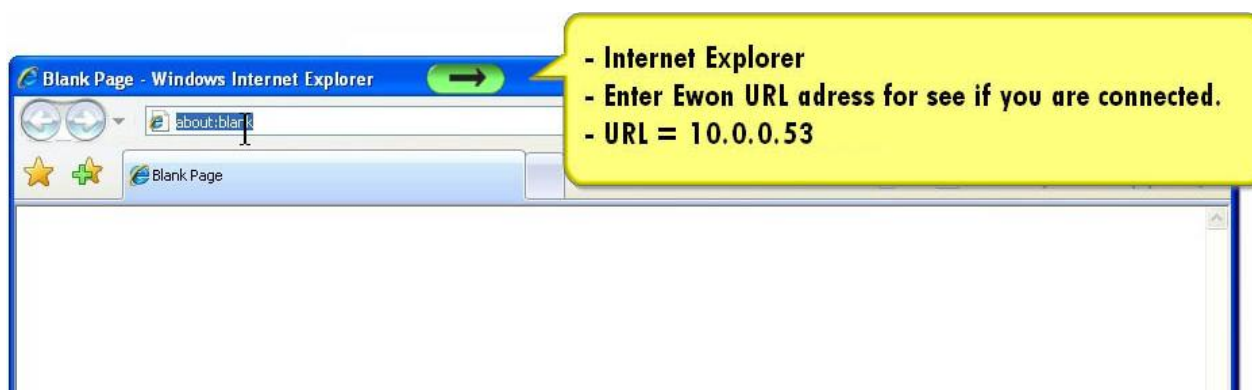

insert the Adalink address and enter to connect

You open the Adalink page

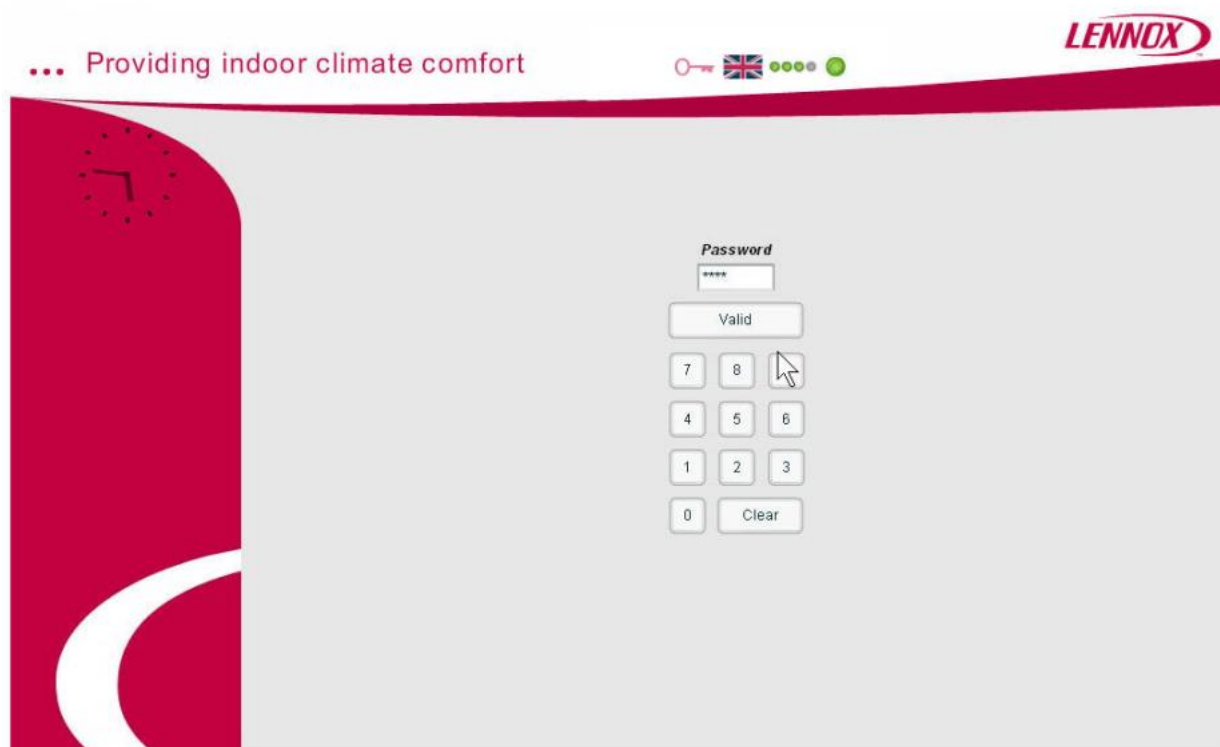

2.4. Customer network connection

If the Adalink is not directly connected to a PC but connected on the customer network, you need to change the IP address, you need also to scan the IP address, the software EwonCfg.exe, available to download on Lennoxtools.

For this connection, the IP parameters of the Adalink must be given by the Network IT manager of the customer.



When you launch the software you go to the following screen:



when you scan the network, the software will automatically, recognize the ewon:

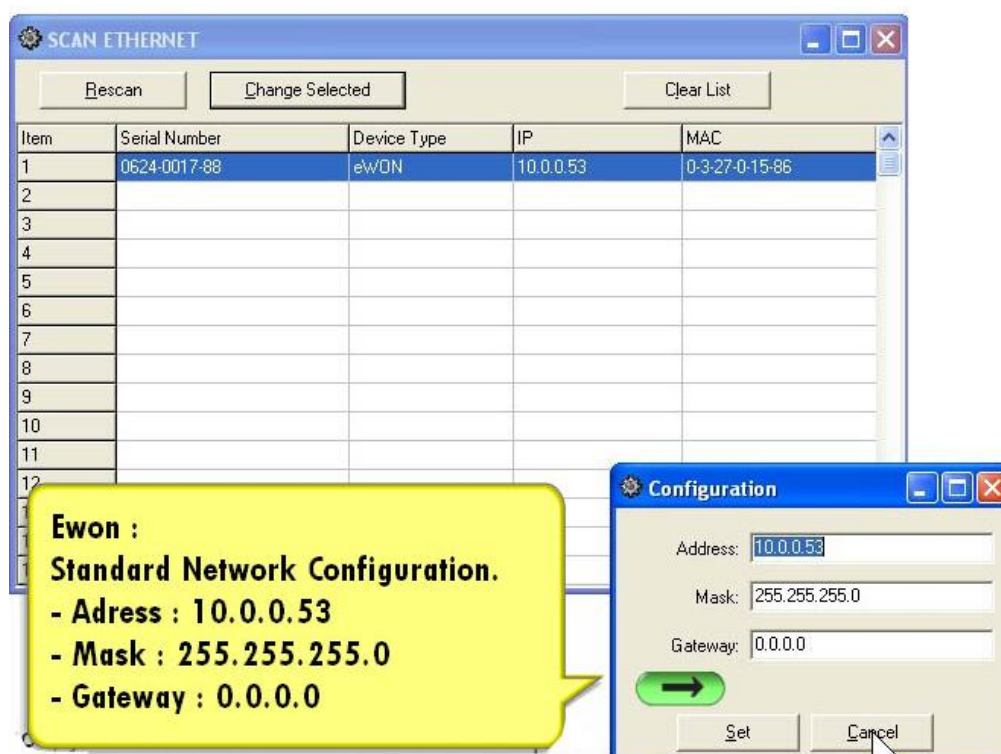

You close all the windows by ok and open internet explorer:

2.5. Connection to the phone line or GSM

2.5.1. Under Windows 98, NT and 2000

- 1) Open the root folder **Dial-up Networking**.
- 2) Click on the icon **Make new connection**.
- 3) Give a name to this connection.
- 4) Select a local modem from the list and click **Next**.
- 5) Introduce the **phone number** and the login **<adm>** and password **<ada01LNX>** of your Adalink (or the login/ password you have created) and click **Next**.
- 7) A new icon has been created in the **Dialup Networking** folder.
- 8) Open the connection wizard by double clicking on this icon and introduce the **login/password** for PPP authentication which are the same than those for the Adalink Web site access (**<adm>** / **<ada01LNX>** by default). Make the connection and wait until the modems are synchronized (MDM led on the front panel is active) and that your authentication login has been accepted.
- 9) Launch your Internet Browser on your PC.
- 10) Types the Adalink TCP/IP address on the address edit control of your Internet Browser (202.0.0.240 is the Adalink but you could have modified, in this case use the new address).
- 11) The Adalink should display its login web page. If not **-404 Error, server not found-**, redo the procedure from the beginning and check whether you did not forget anything.

2.5.2. Under Windows XP

- 1) With Windows XP, you first have to go to Start and select Connect to and then **Show all connections**. **Create a new connection** appears in the network tasks box (top left corner).
- 2) Selecting **Create a new connection** menu opens the new connection creation wizard. Click **Next**.
- 3) Select the 2nd option (out of 4) – **Connect to the network at my workplace** and then click **Next**.
- 4) Select the 1st option (out of 2) – **Dial-up connection** and click **Next**.
- 5) Give a **name** to this connection and click **Next**.

- 6) Introduce the **phone number** of the Adalink and click Next.
- 7) Click **Finish**.
- 8) The connection window opens and introduce the PPP authentication parameters that are the same than those used to access to the Adalink embedded Web site (<**adm**> / <**ada01LNx**> by default).
- 9) The new connection has now been added in the "Connections" directory and also under **Start** and Connect to as well as on your desktop if you selected the relevant option (**Create icon on desktop**).
- 10) You can now make a connection either by using the currently open window, or later on by using one of the available paths (**Start** menu or desktop icon).
- 11) Wait until the modems are synchronized and that your PPP authentication has been accepted.
- 12) Launch your Internet navigator.
- 13) Introduce the IP address of the Adalink in the address field of the navigator (the default address is 202.0.0.240 in dial-up mode (see chapter IP parameters configuration on page 20).
- 14) The Adalink should then display its login Web page. If not (-404 Error, server not found-), redo the procedure from the beginning and check whether you did not forget anything.

2.6. FTP connection

For the language files and the background image and customer logo, you need to download files through FTP connection.

Opening Internet Explorer, type TCP/IP address, with FTP:// above:

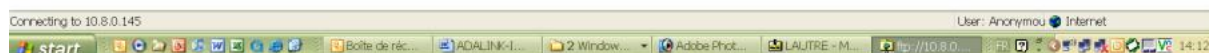
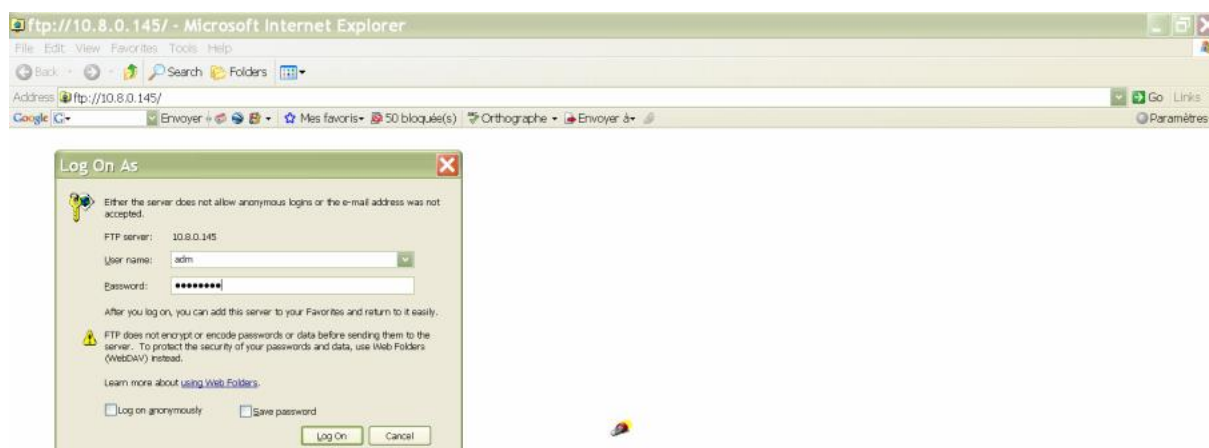

In the Log On window type the following:

User Name = **adm**

Password = **ada01LNx**

You have now access to the flash memory of the Adalink.

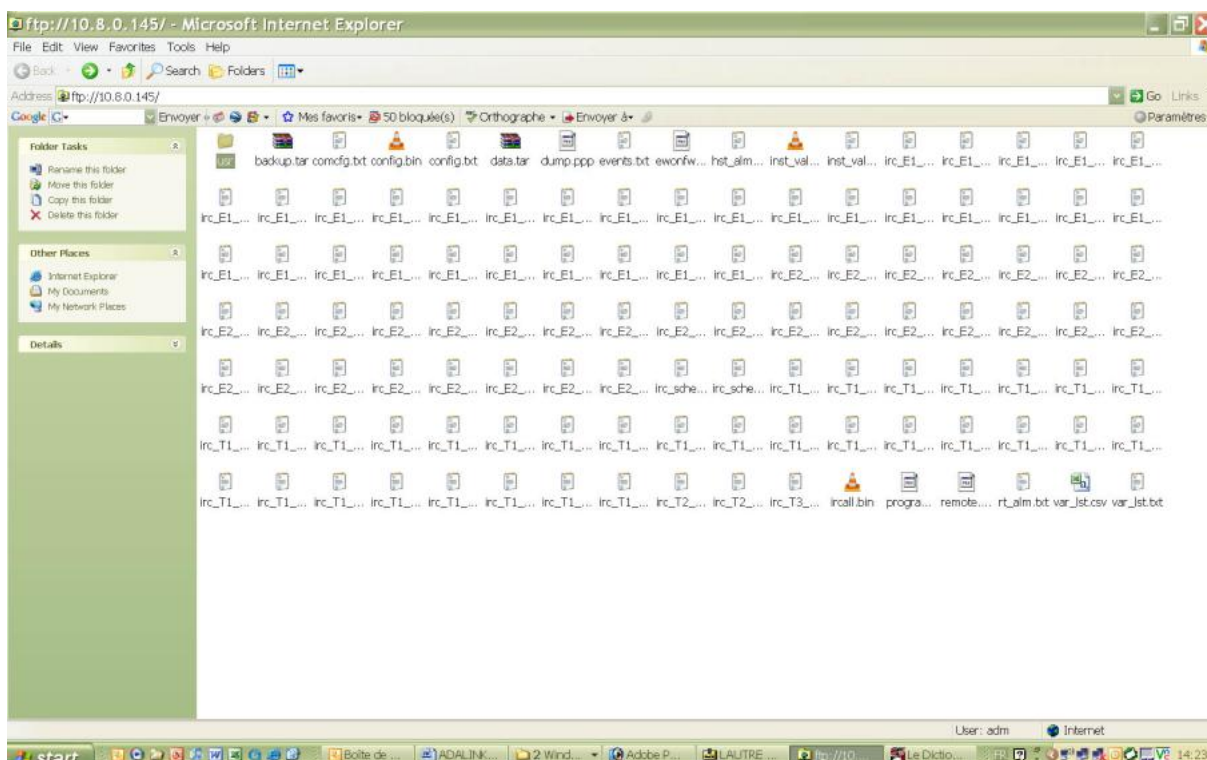

Open the USR folder

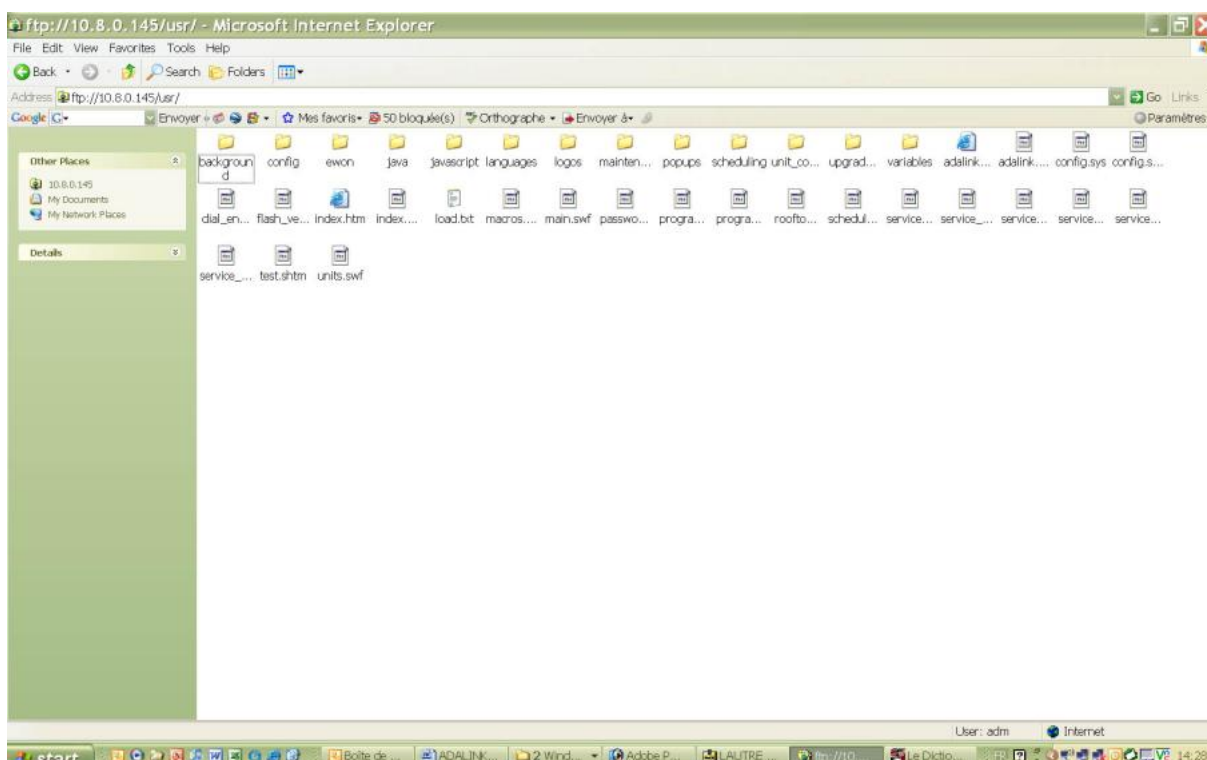

2.6.1.Languages Files

In standard Adalink is delivered with English an French language, if you want a different one, please ask the Lennox Technical Support for a xml translation file. When you have this file copy it in the language directory and delete the French one; List_fr.xml (Adalink can support only 2 languages in the same time).
 FTP://10.0.0.53/Usr/Languages/List_fr.xml

It's always possible to switch to the English language by a dick on the English Flag.

2.6.2. Background image and customer Logo

Adalink give you the possibility to have on the Adalink background the logo of the customer and a picture of the site of the customer.

First you have to download the logo and the background of the customer according the following rules :

- Logo : The size of the picture must be max h x l = 72 x 250 pixels. And you need to save it as FTP://10.0.0.53/Usr/logos/logo_customer.jpg
- Background : The size of the picture must be h x l = 529 x 824 pixels. And you need to save it as FTP://10.0.0.53/Usr/background/pkg_customer.jpg

3. SET UP OF THE ADALINK

3.1. Languages

Automatically, Adalink will recognize the Window language of your computer and set this language by default.

3.2. Access management

There is 3 levels of access in Adalink;

Levels :

- 1 light Customer
- 2 lights Technician of the customer
- 3 lights Lennox service engineers

You can change the password access if it's needed.

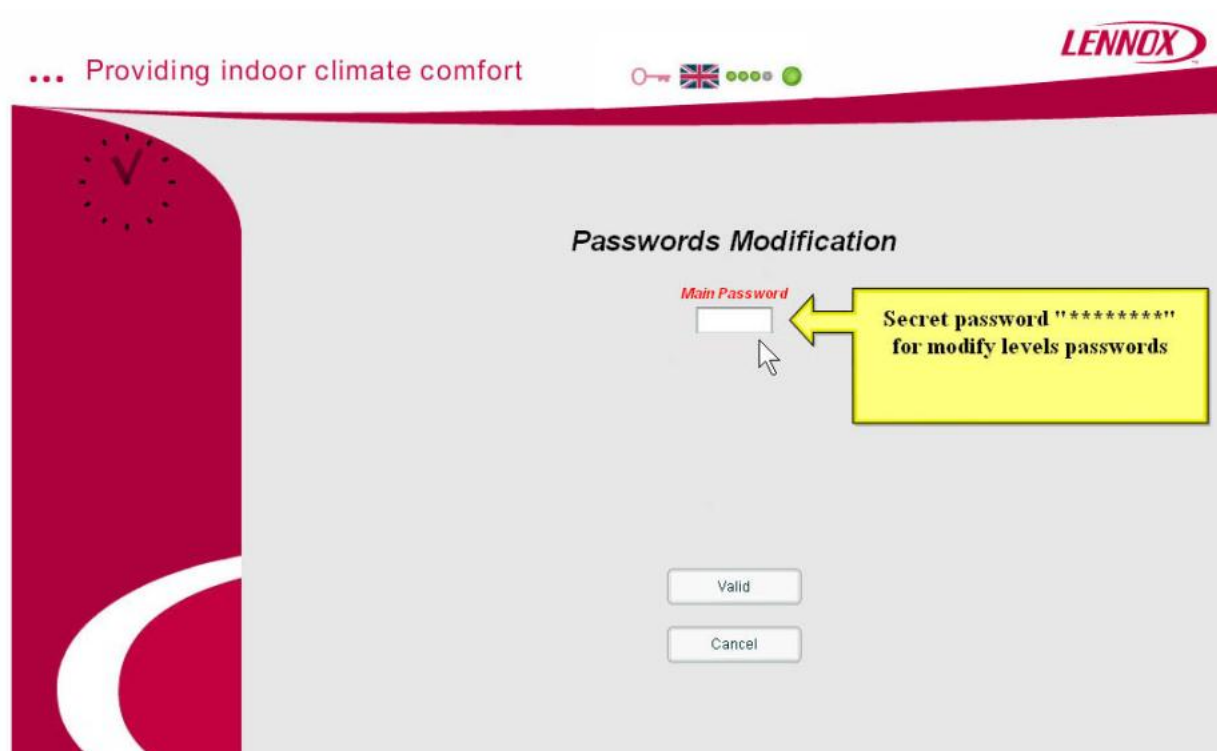

With the Password access code xxxxxxxx (ask the LENNOX Team), you can open the password window.

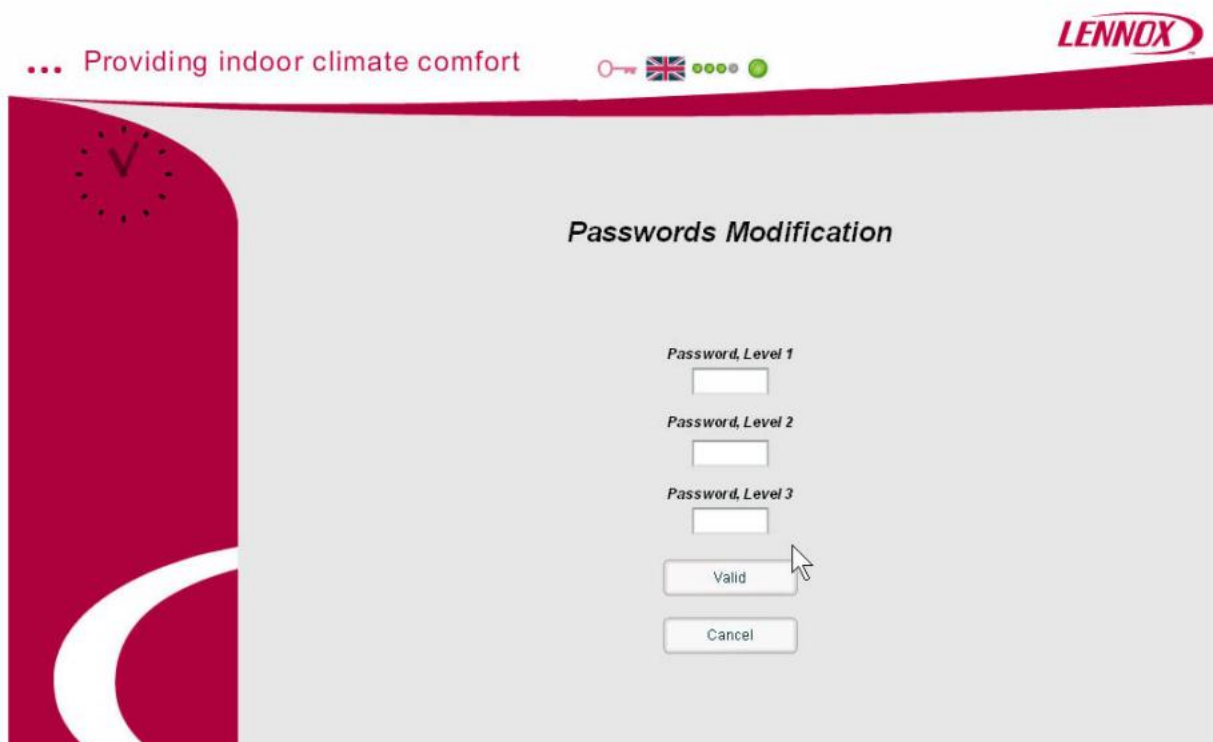

On this page you can enter new 4 digits password. And don't forget to valid to save your new password in the Adalink memory.

If your password is valid you open the main page of the Adalink.

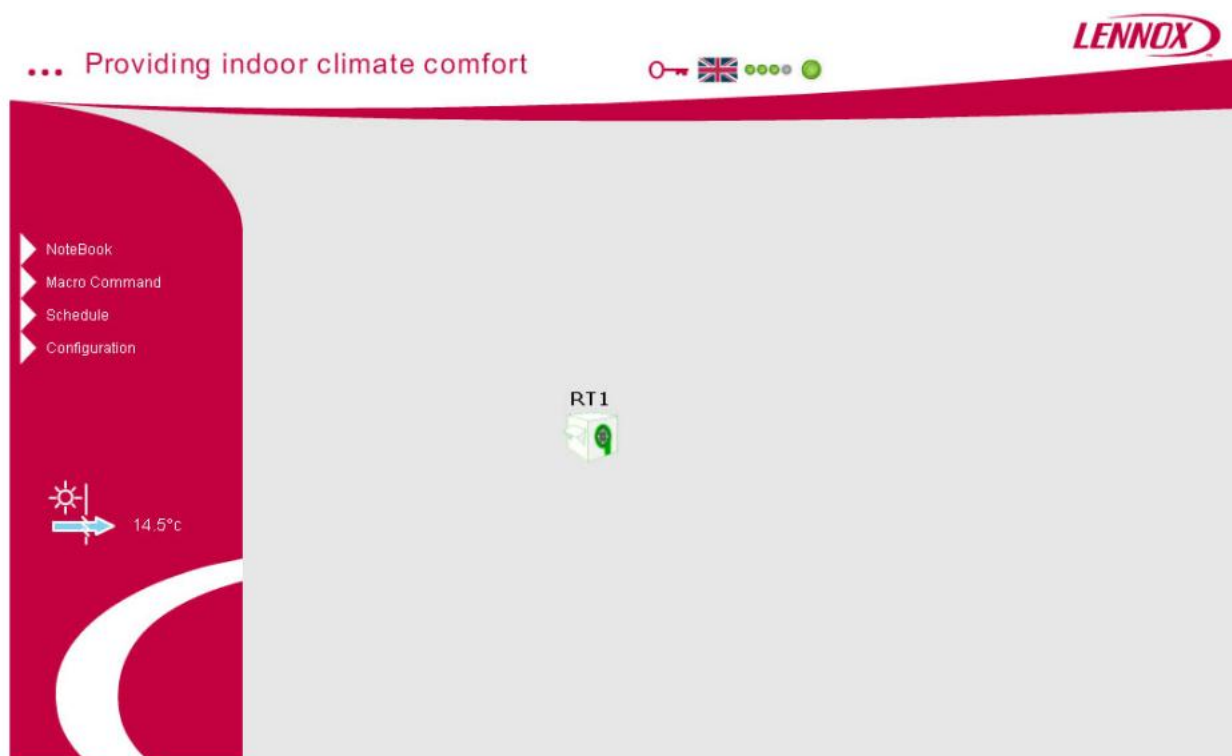

3.3. Note book

On the main page, you have access to the note book page, it's a page dedicated to the site. This page is available for all the user of the Adalink site to write different action or remarks.



3.4. Configuration



3.4.1.Desktop Configuration

If during the start up of the Adalink you have download a site picture, you can modify the background configuration in the Adalink main page.

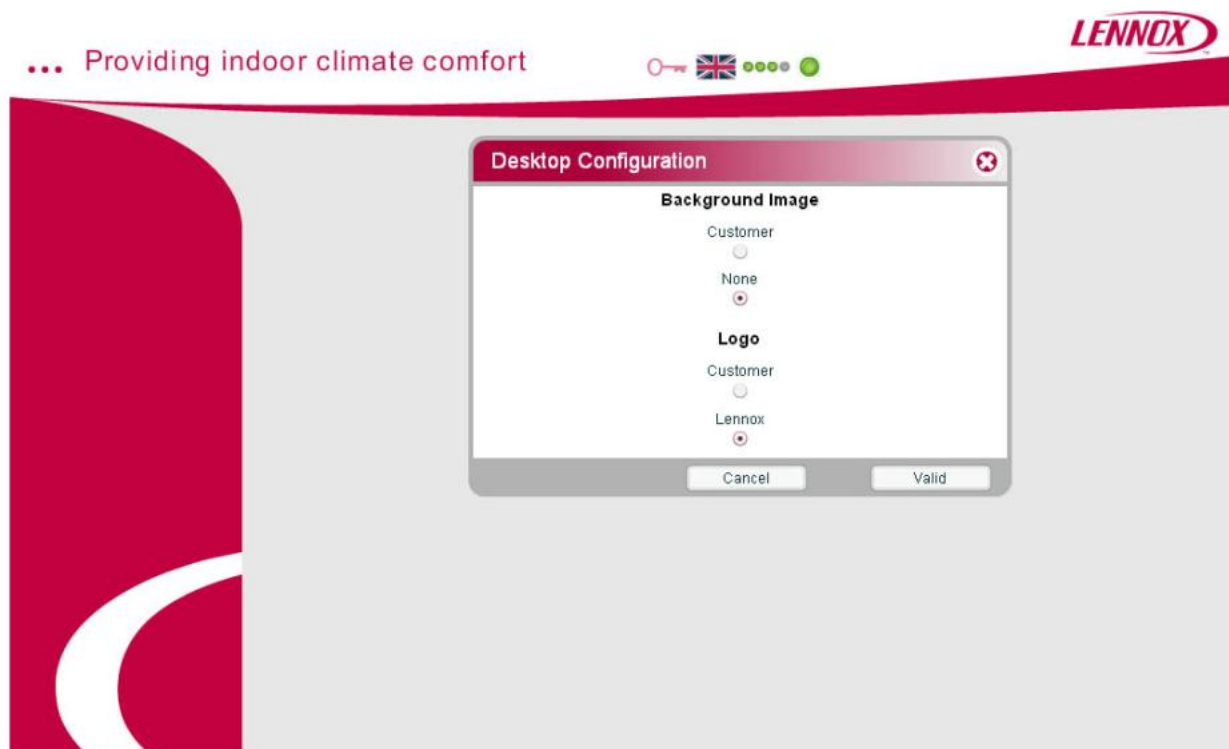

And from this page you choose what type of background you need:

- Customer background or no background
- Customer logo or LENNOX logo

3.4.2. Unit configuration

All the units must be connected on a Modbus network, the BM 50 of each unit must be configured to “Adalink mode – 3932 menu” and must have a BM 50 card number.

At the first connection, you need to configure the units connected to the Adalink.

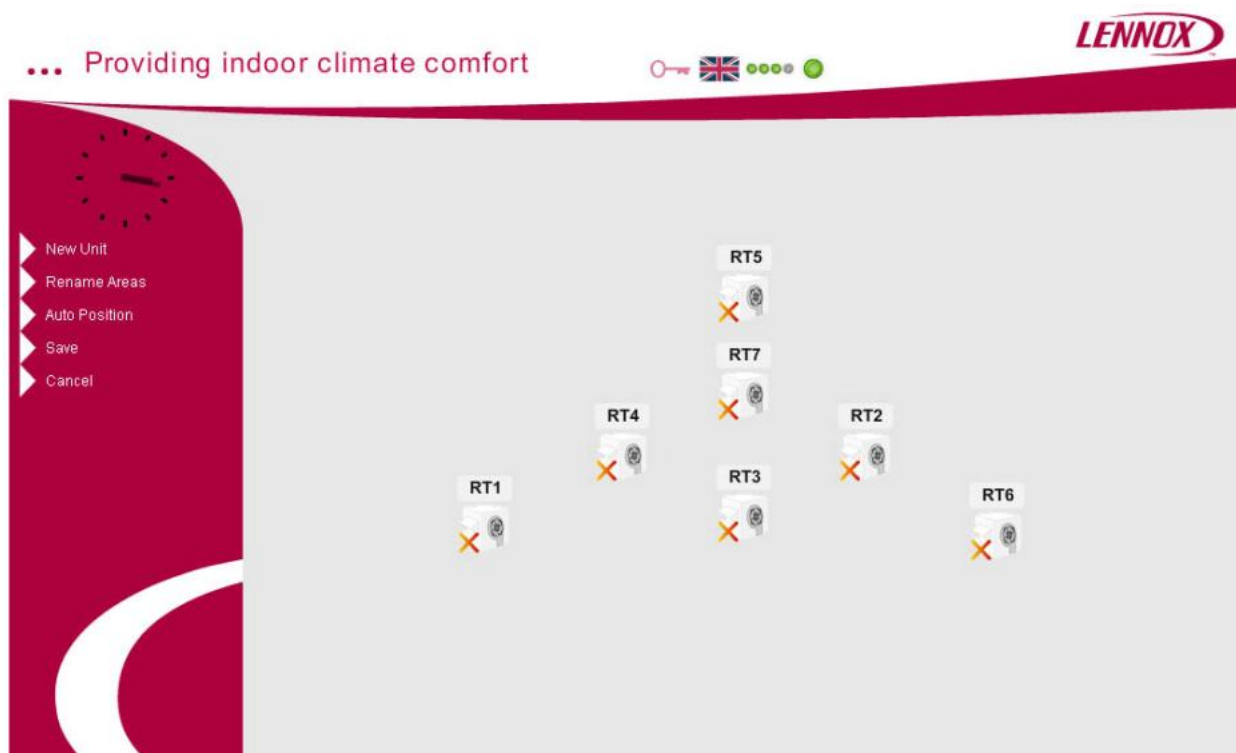

First you need to declare the Area or group you want to create on your site

3.4.2.1. Rename Area



These is 32 area preset , and you can change the name of the area using the modify window. After you need to create a new unit, give a name, affect the BM50 card number and a area.

3.4.2.2.New unit

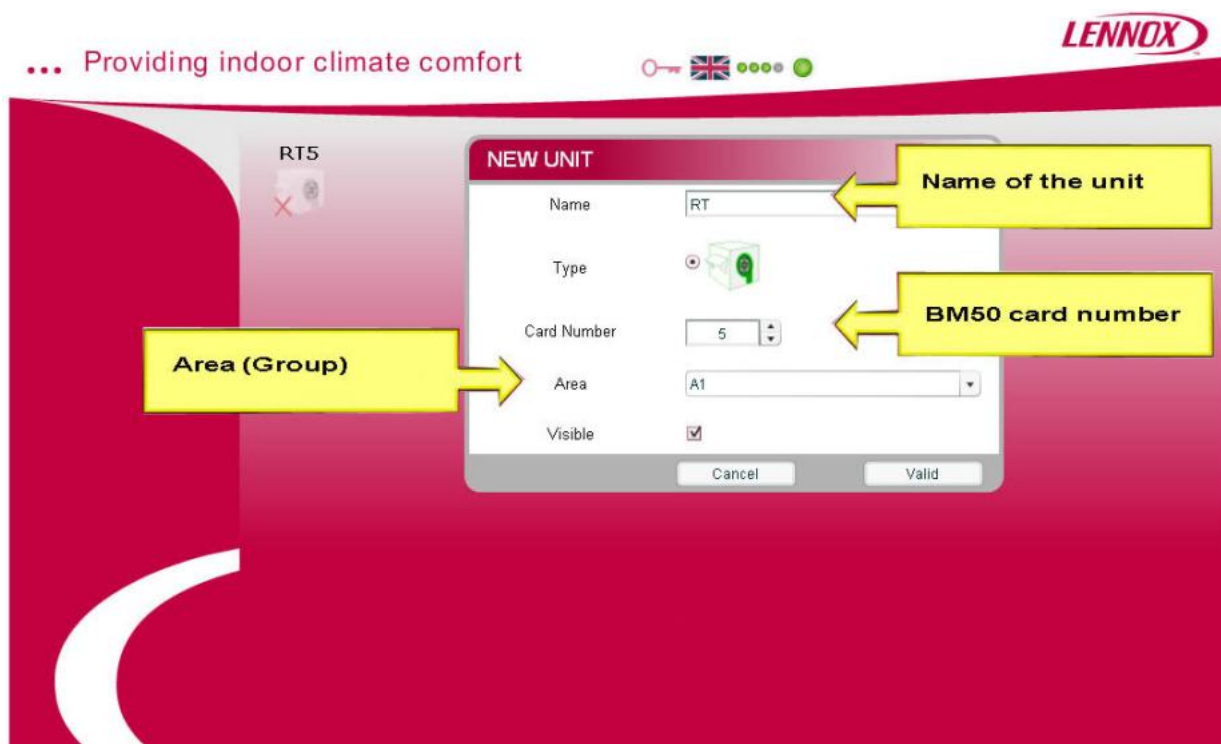

You need to exit the window by "valid" to save the data.

3.4.2.3. Modify the units

To modify an existing unit, put the mouse on the units and double click right, you open the modification screen, with the same parameters as the new unit screen + a delete button.

3.4.2.4. Auto Position

You automatically position the units on a concentric network.

3.4.2.5. Manual position of the unit

To move manually the units you can capture the units with the mouse (left click) and set your position.

3.4.2.6. Save

You save the position and all the modifications of the units

3.4.2.7. Cancel

To return to the previous menu without modification saving.

3.4.3. Schedule activation

You can activate the scheduling functionality with this menu. If you choose this solution, the BM 50 work in BMS mode, if not they work on their own BM50 zone.

3.4.4. Create days types

Adalink give you the possibility to create 6 types of days according your typical demand. You can rename the day type and set different macro command hourly in the day and affected to different areas.



To modify the name, you select a day, write the new name in the right input and confirm by modify

To set a macro command list in a day, you need to click on the “new “ button, and program the hour, the area, the macro command and the set point.

If you need to modify an existing macro command, first you need to choose the line to modify and click on it. After, use the “edit” button, and modify according your new set up.

... Providing indoor climate comfort



Create Days Types

Days types: Open 12 Hours Open 12 Hours Modify

Hours	Areas	Macros Commands	Value n°1	Value n°2
00:00	Charcuterie	RT Enable, Free-Cooling, Day	No	
02:00	Charcuterie	General On/Off	On	
08:00	Charcuterie	RT Set, Room Temp., Day	19°C	24°C

Hour: 08:00 Area: Charcuterie Macro Command: RT Set, Room Temp., Day Modify

Value n°1: Heating, Schedule 19 °C

Value n°2: Cooling, Schedule 24 °C

Edit New Delete Save

3.4.5. Date & Hour Modification

On your bus loop, you need to synchronize the docks of the BM50 cards and the inner dock of the Adalink.

... Providing indoor climate comfort



Date & Hour Modification : Adalink & units

Modify Date

28 08 2007 16:23 Save

Adalink : Actual Date & Hour - 28/08/2007 - 16:22

To modify the date and hour you need to choose the number and modify with the up and down arrows; when everything is properly set, save you values.

If you want your loop dock synchronized also with the left screen virtual dock, set you computer value.

3.5. Calendar

A yearly calendar is included and reachable from the main page with the Calendar icon.

On the calendar page, you have a full year and you can apply clicking on the day, one the 6 days you have set up on the days types page.



For easy use you can, when you have completed a week, copy it several time. For this select a week number

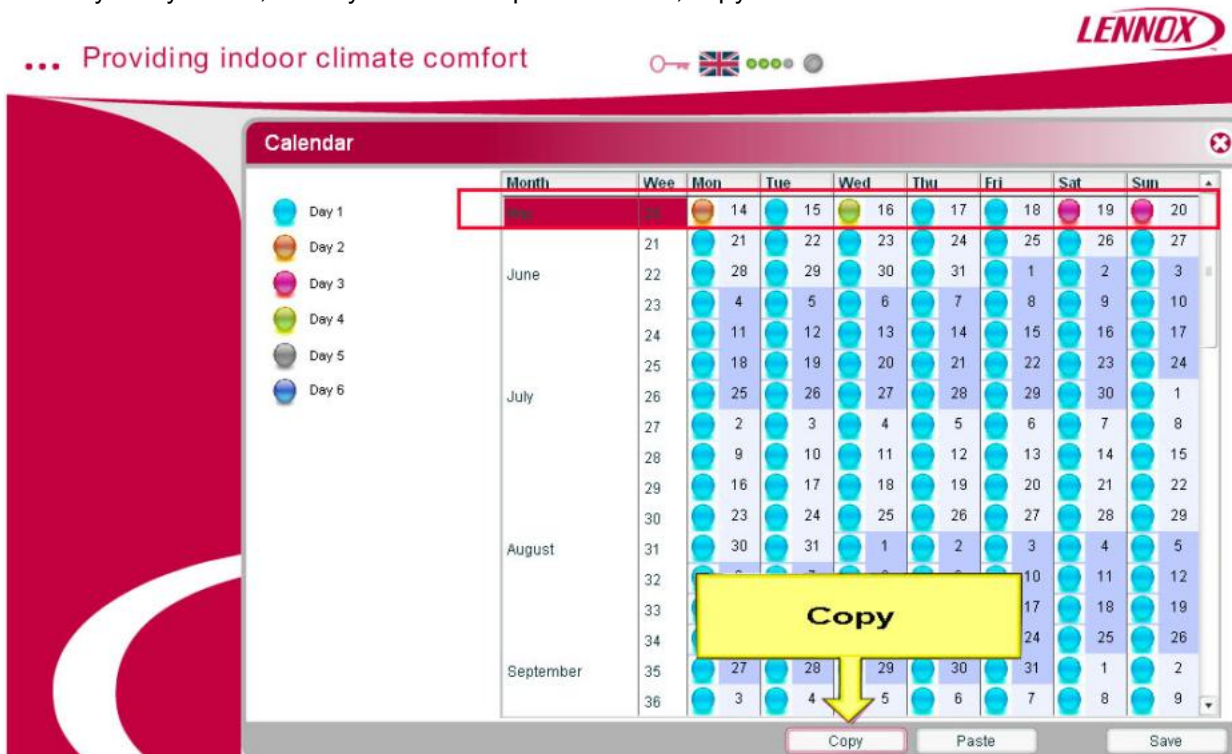

And use the Copy/Paste buttons at the bottom of the page.

... Providing indoor climate comfort



Calendar

- Day 1
- Day 2
- Day 3
- Day 4
- Day 5
- Day 6

Month	Wee	Mon	Tue	Wed	Thu	Fri	Sat	Sun
May	20	14	15	16	17	18	19	20
	21	21	22	23	24	25	26	27
June	22	28	29	30	31	1	2	3
	23	4	5	6	7	8	9	10
	24	11	12	13	14	15	16	17
July	25	18	19	20	21	22	23	24
	26	25	26	27	28	29	30	1
August	27	2	3	4	5	6	7	8
	28	9	10	11	12	13	14	15
	29	16	17	18	19	20	21	22
	30	23	24	25	26	27	28	29
	31	30	31	1	2	3	4	5
	32	6	7	8	9	10	11	12
September	33	13	14	15	16	17	18	19
	34	20	21	22	23	24	25	26
	35	27	28	29	30	31	1	2
	36	3	4	5	6	7	8	9

Copy Paste Save

Do not forget to save your schedule before exit this page.

3.6. Macro command

You can force at each moment a macro command to an area, you chose your area, the macro command you want to affect, the value and push the button "Send"

... Providing indoor climate comfort

Macros Commands

Area

Macro Command

Value n*1

Set point, On Unit

4. Functioning

4.1. Remote control of the unit

4.1.1. Unit Page

On the front page, if the mouse stay on the roof top icon, a pop up appear with summary information's.

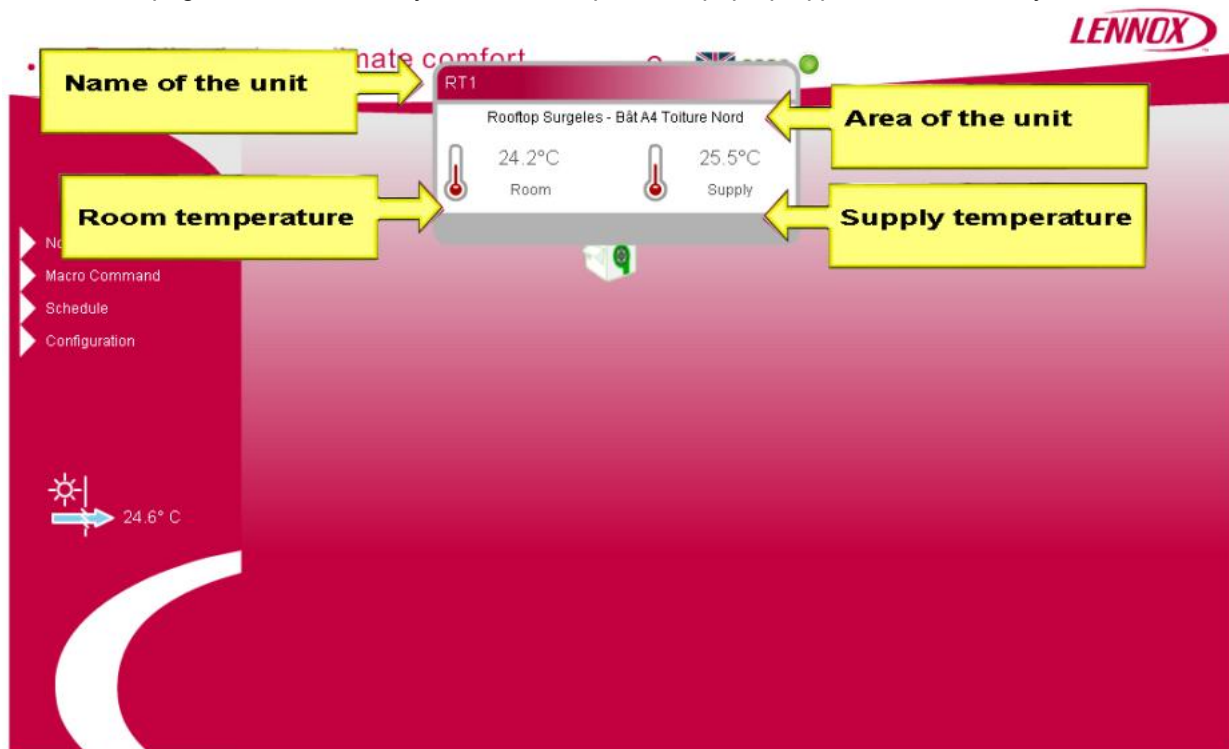

When you click on the unit, you enter in the "unit " page

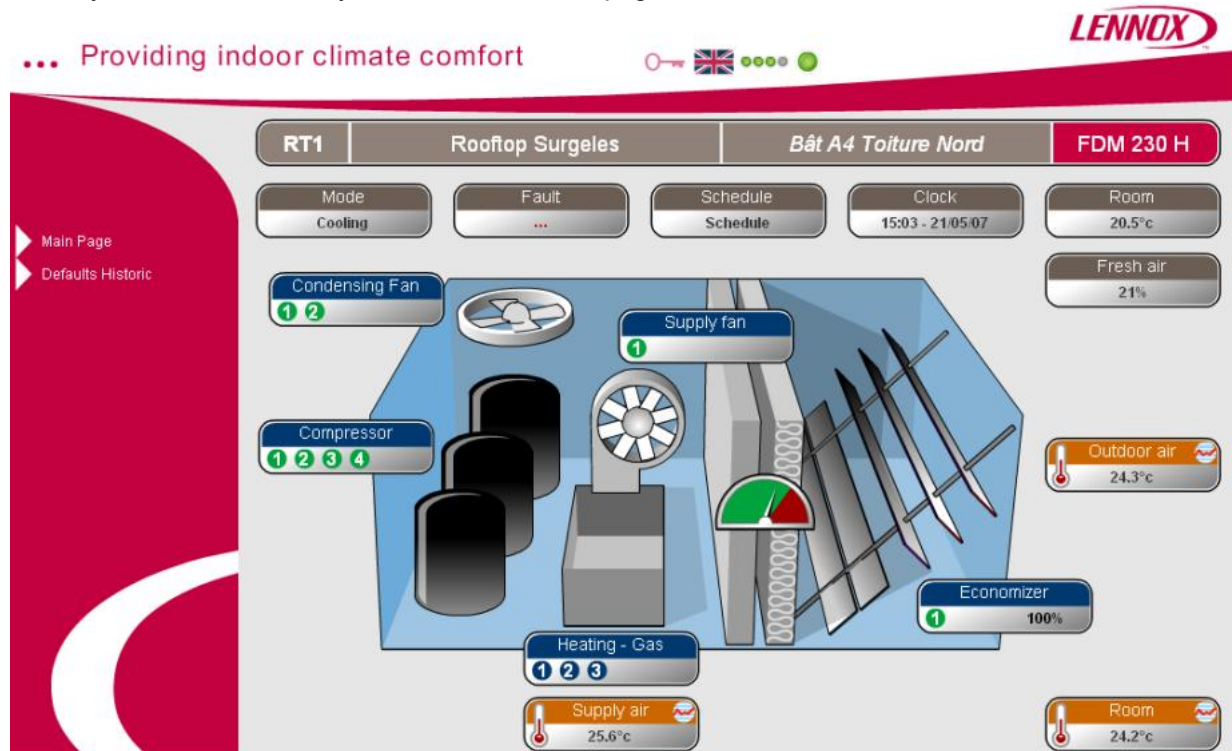

On the top of the page the top line shows, the name of the card, the name of the unit, the area, and the type of unit (auto detected from the BM50)

On this page you have 3 type of icons :

- ❖ Grey : unit parameter
- ❖ Blue : unit components
- ❖ Orange : temperatures

The first grey icon is the mode information, it display the status of the unit:

- ❖ Cooling
- ❖ Heating
- ❖ Dead zone

From this screen you have access to the list of the connected units by a right click on the Unit Name :

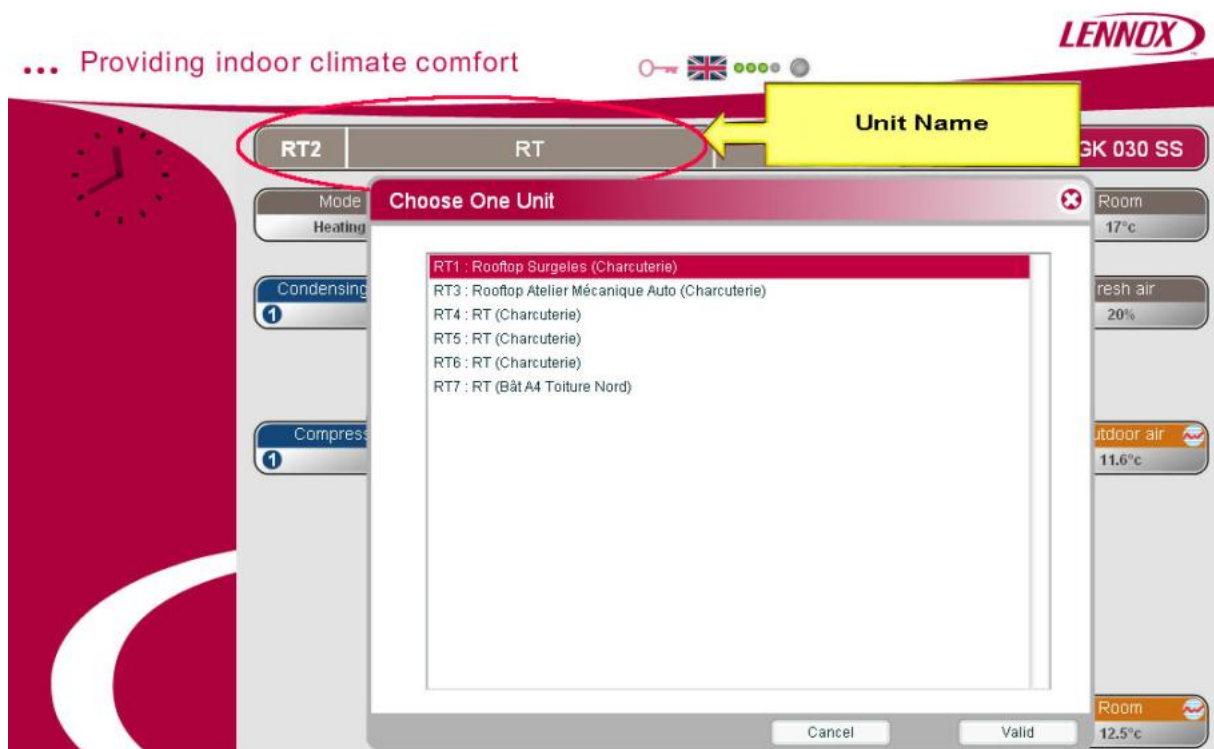

And you can go directly to an over unit, by choosing the line and valid.

You have also access to the complete parameter list by a right click on the type of unit:



4.1.2. Fault Icon

The icon “fault” display the fault if there is one and if you open you have all the details of the fault in clear.



On all the Setting line with a pencil at the end, you can enter by clicking on the pencil and change a parameter

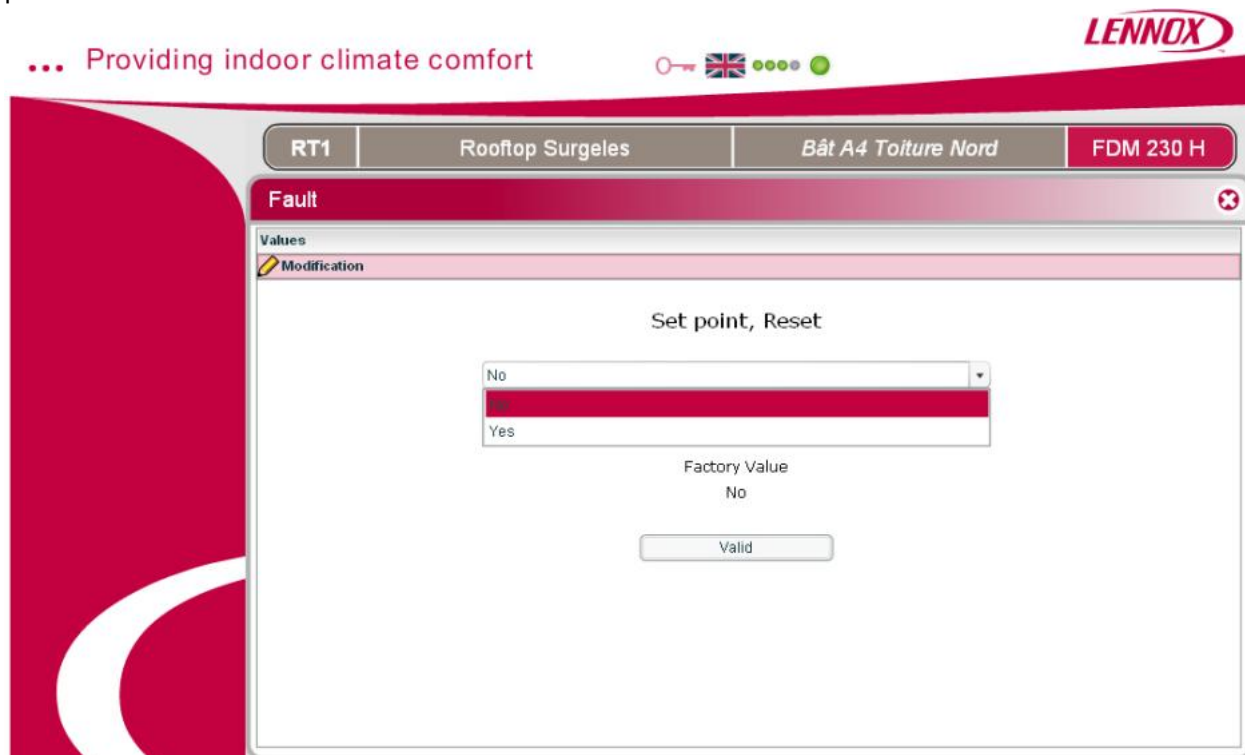



4.1.3. Schedule Icon

On the schedule icon, you have access to the week schedule of the CL50. And you can modify by a click on the pencil all the parameter.

... Providing indoor climate comfort    





RT1 | Rooftop Surgeles | Bât A4 Toiture Nord | FDM 230 H

Internal Unit, Time zone 

Values		Data
Actual, Zone		Schedule
Setting		
Monday		
Monday, Beginning of Day A		6h 
Monday, Beginning of Day B		22h 
Monday, Beginning of Day C		22h 
Monday, Beginning of Night		22h 
Tuesday		
Tuesday, Beginning of Day A		6h 
Tuesday, Beginning of Day B		22h 
Tuesday, Beginning of Day C		22h 
Tuesday, Beginning of Night		22h 
Wednesday		
Wednesday, Beginning of Day A		6h 
Wednesday, Beginning of Day B		22h 

4.1.4. Clock Icon

The dock icon is to check the hour and date and to activate the automatic summer/winter hour change.

... Providing indoor climate comfort    

RT1 | Rooftop Surgeles | Bât A4 Toiture Nord | FDM 230 H

Clock 

Values		Data
Hour		17h
Minute		37min
Day		21
Month		5
Year		7
Setting		
Automatic, Hour Winter/Summer		Yes 

To set up the dock of the Adalink, you need to go to the first page, configuration, dock



To change the date and the hour, you select the number and you adjust with the arrows on the side. Do not forget to valid before exit to save the modification.

4.1.5. Room Icon

To have access to the room temperature settings you need to click on the “Room” icon.

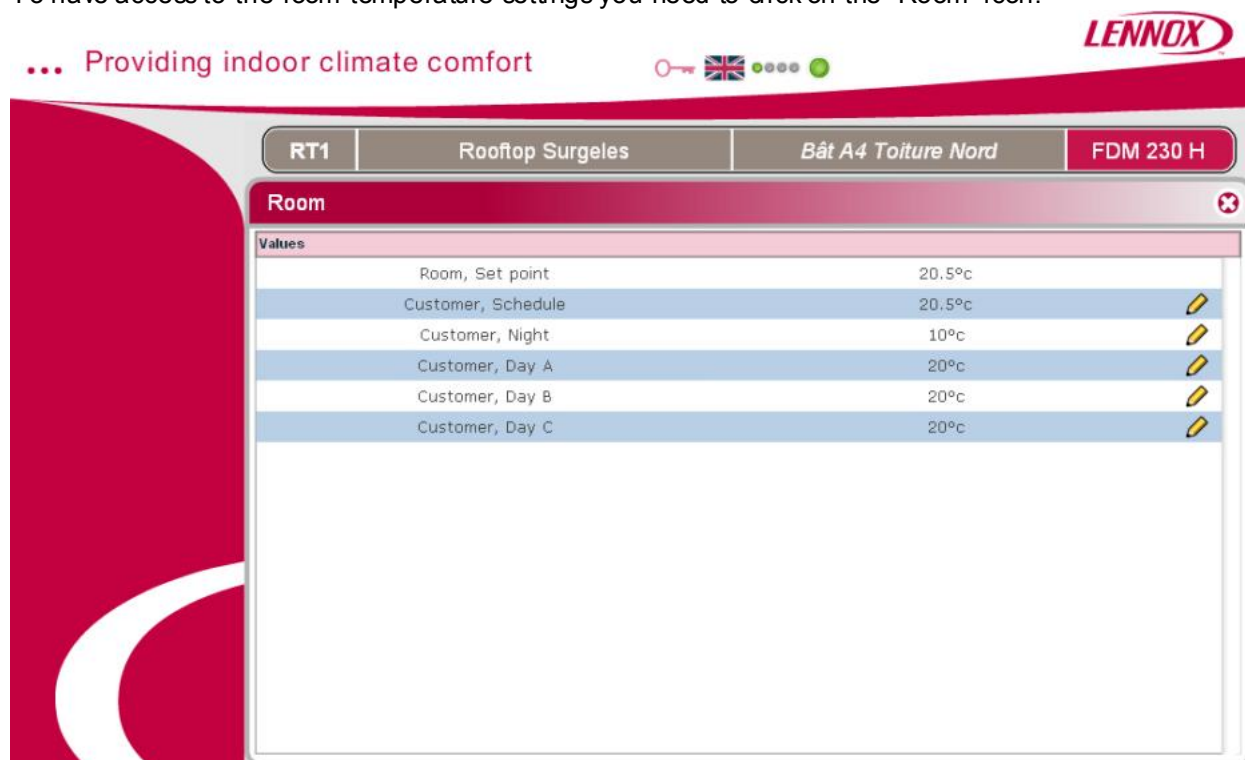

In this window, by clicking on the pen on each setting, you can adjust you temperature set point for all the time schedule.

4.1.6. Fresh Air Icon

To set your fresh air you need to enter in the “fresh air” window and by a click on the pencil you can setup all your parameters.

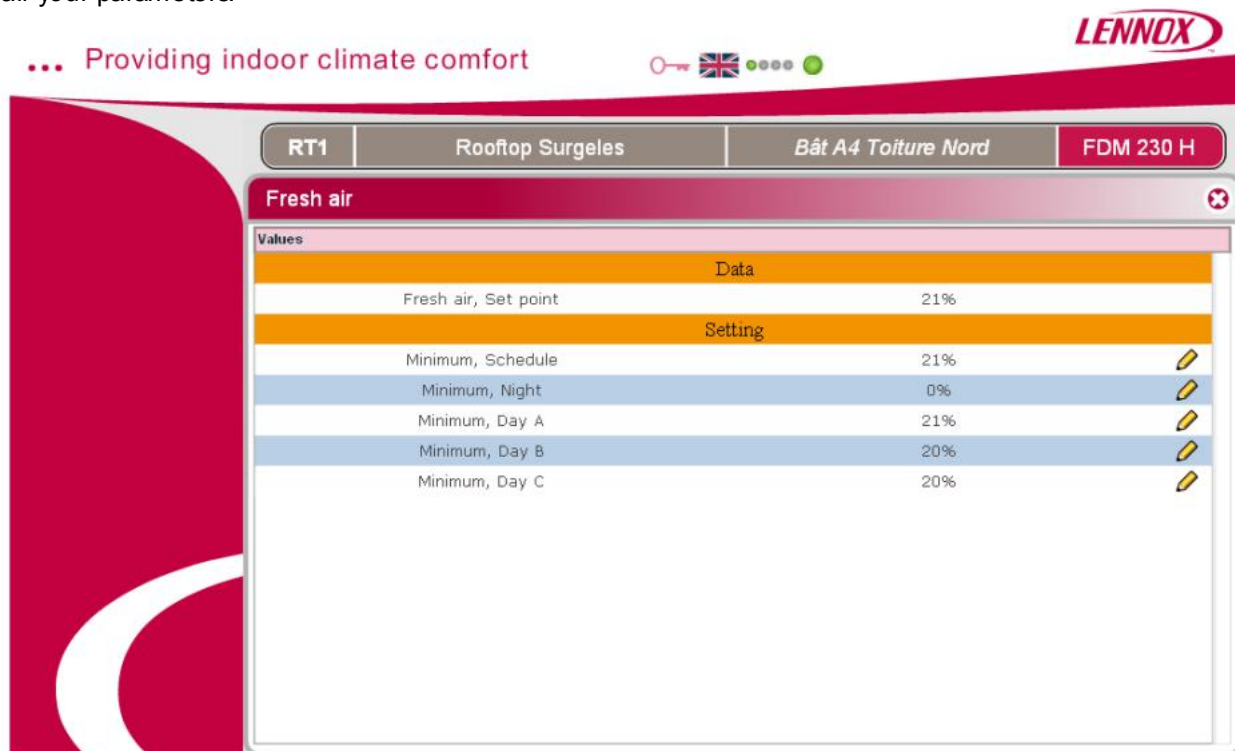

4.2. Supervision of the unit

4.2.1. Filter control

You can control the status of the filters with the filter pressostat icon:

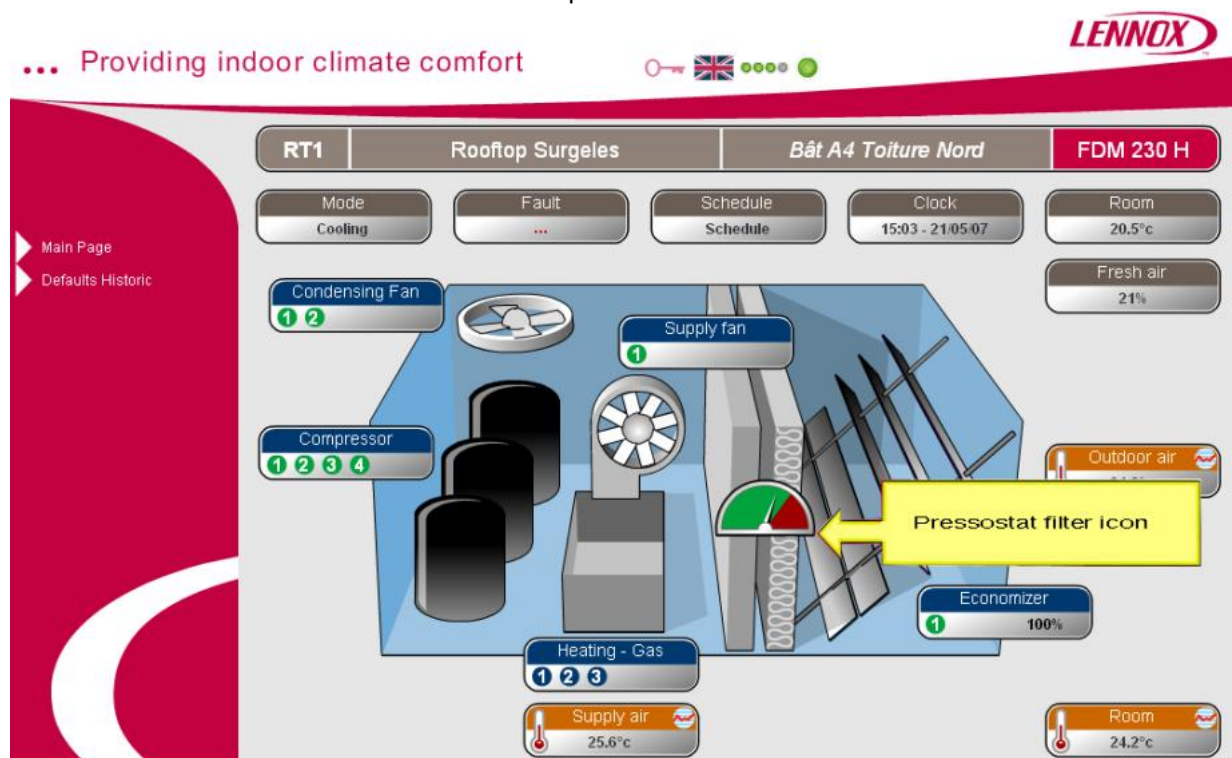

... Providing indoor climate comfort



Values	
Value	Data
	77pa
Setting	
Safety, Air flow	25pa
Safety, no filters	60pa
Safety, Dirty filters	420pa

On this screen you can see:

- The current pressure drop of the filter
- The minimum value for airflow alarm
- The minimum value for no filters alarm
- The maximum value for dirty filter alarm

... Providing indoor climate comfort



Safety, Air flow

Minimum Value 0pa

Maximum Value 500pa

Factory Value 25pa

Valid

And you can change the Factory settings with the pencil icon; you obtain a new screen with minimum, factory setting and maximum value. You can adjust your setting by moving the cursor and save your modification.

4.2.2. Temperature curves

For the 3 temperature icons (Orange):

- Outdoor Air
- Room
- Supply Air

If you click you open a screen with the temperature graph, by hour, day or month

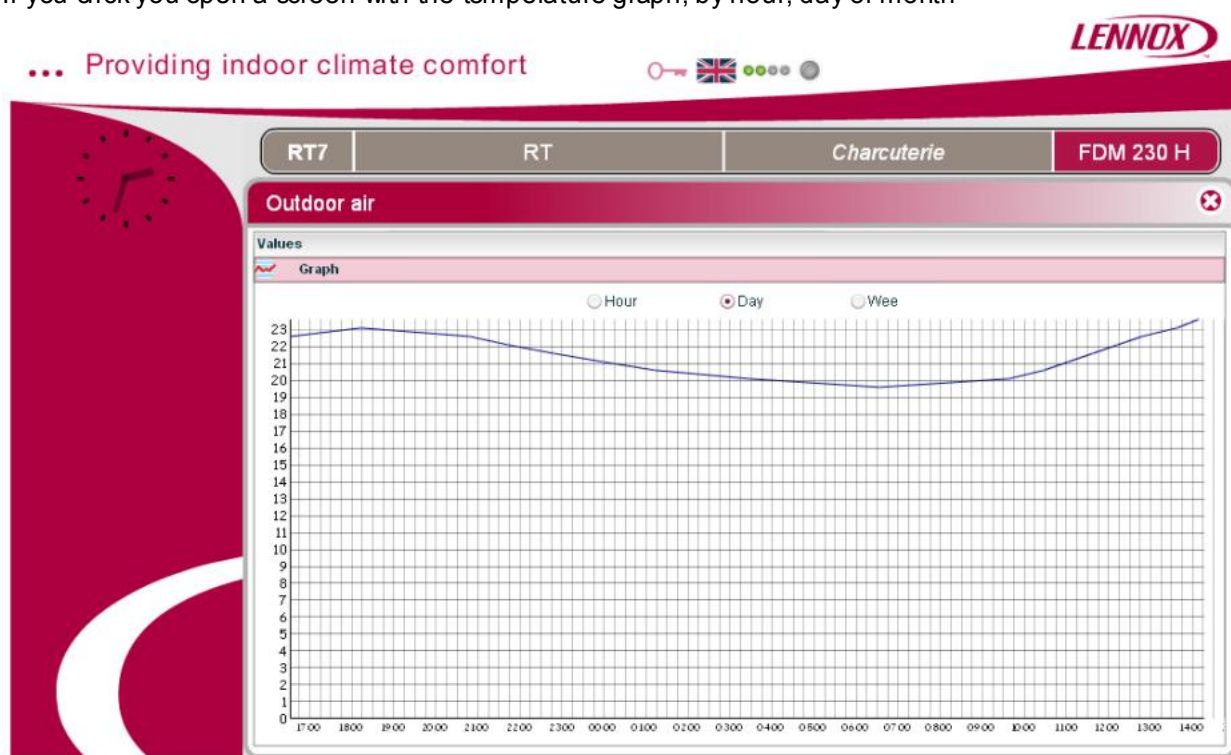

Or if you choose on the top of this screen “Values”, you open a screen with the detailed instantaneous temperature and setting.

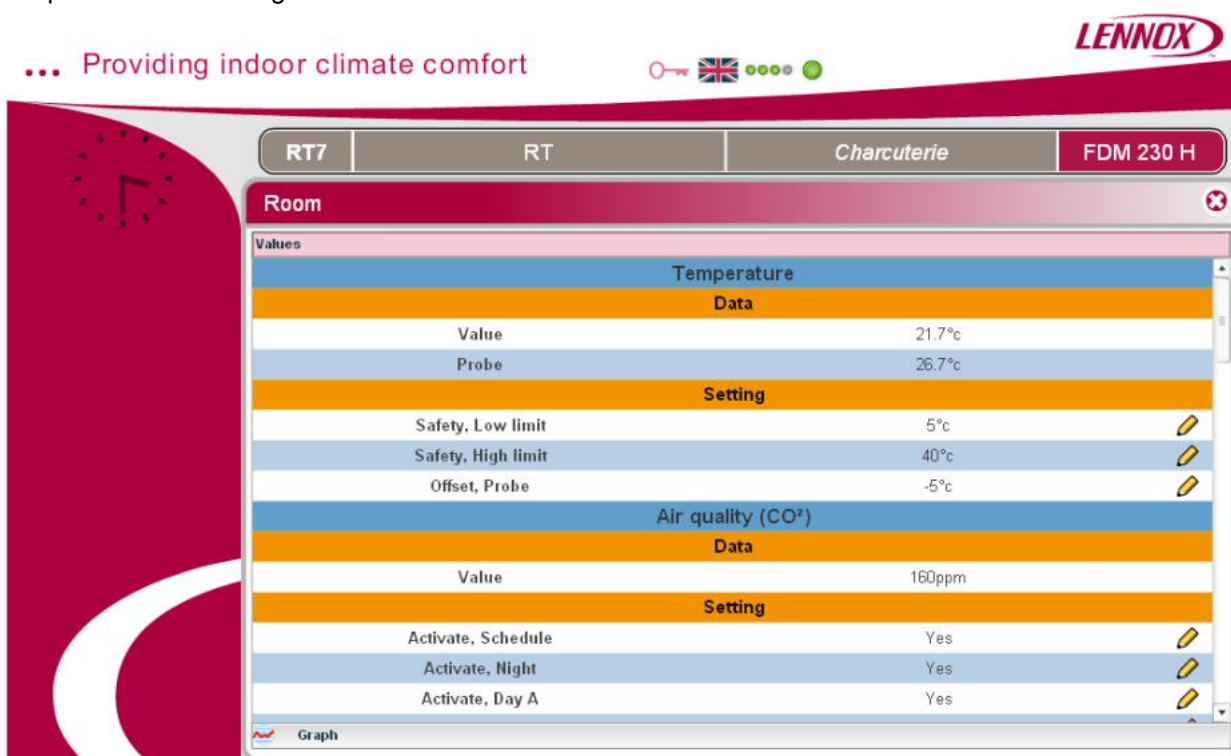

You can come back to the graph by choosing in the bottom of the screen “Graph”

4.2.3. Supply fan icon

When you open the Supply fan screen, you have access to the On / Off of the unit, the supply fan status and setting, and the exhaust fan status and settings.

RT7	RT	Charcuterie	FDM 230 H
Supply fan			
Values			
On/Off			
Data			
Switch, On Unit		On	
Setting			
Set point, On Unit		On	
Disable override, DC50		No	
Test		No	
Supply fan			
Data			
State		Started	
Relay		On	
Run time		1023h	
Setting			
Activate, Schedule		Yes	
Activate, Night		Yes	
Activate, Day A		Yes	
Activate, Day B		Yes	
Activate, Day C		Yes	
Activate, Control dead zone., Schedule		Yes	
Activate, Control dead zone., Night		No	
Activate, Control dead zone., Day A		Yes	
Activate, Control dead zone., Day B		Yes	
Activate, Control dead zone., Day C		Yes	
Exhaust fan			
Data			
State		Stopped	
Relay		Off	
Setting			
Fresh air, Threshold		50%	

4.2.4. Condensing fan icon

Opening, the condensing fan screen, you have access to all the status of the condensing fans and the parameters of the Defrost.

... Providing indoor climate comfort

RT7 RT Charcuterie FDM 230 H

Condensing Fan

Values

Data.1	
State	Started
Relay	On

Values

Data.2	
State	Started
Relay	On

Setting

Defrost, Type	Dynamic	
Defrost, Activate, Outside air	16°C	
Defrost, Activate, Coil	1.7°C	
Defrost, Time limit for icing	45min	
Defrost, Condenser fan, Start-ups	3	

4.2.5. Compressor icon

In the compressor screen, you see the data of all the compressors according to the number in the units and you can modify parameters like rotation, unloading, percentage outside air activation, room control priority, cooling and heating activation and low noise activation.

... Providing indoor climate comfort

RT7 RT Charcuterie FDM 230 H

Compressor

Values

Data.4	
State	Stopped
Relay	Off
Mode	Cooling
Coil, Temperature	-99.9°C
Run time	0h

Setting

Rotation	COP	
Unloaded, Compressor	C.1.2.3.4	
Activate, 50%, Outside air, Cooling	20°C	
Activate, 100%, Outside air, Cooling	12°C	
Activate, 100%, Outside air, Heating	-20°C	
Room Control, Priority, Schedule	Heat Pump	
Room Control, Priority, Night	Heat Pump	
Room Control, Priority, Day A	Heat Pump	
Room Control, Priority, Day B	Heat Pump	

4.2.6. Economiser icon

When you open the Economiser screen, you have access to the status of the economizer and the settings for Minimum Fresh air, CO2 control, air flow calibration.



4.2.7. Heating Icon

In the heating screen, you see the type of heating, the status of the different stages and the setting of the activation.

4.2.7.1. Gas Heating Unit screen:

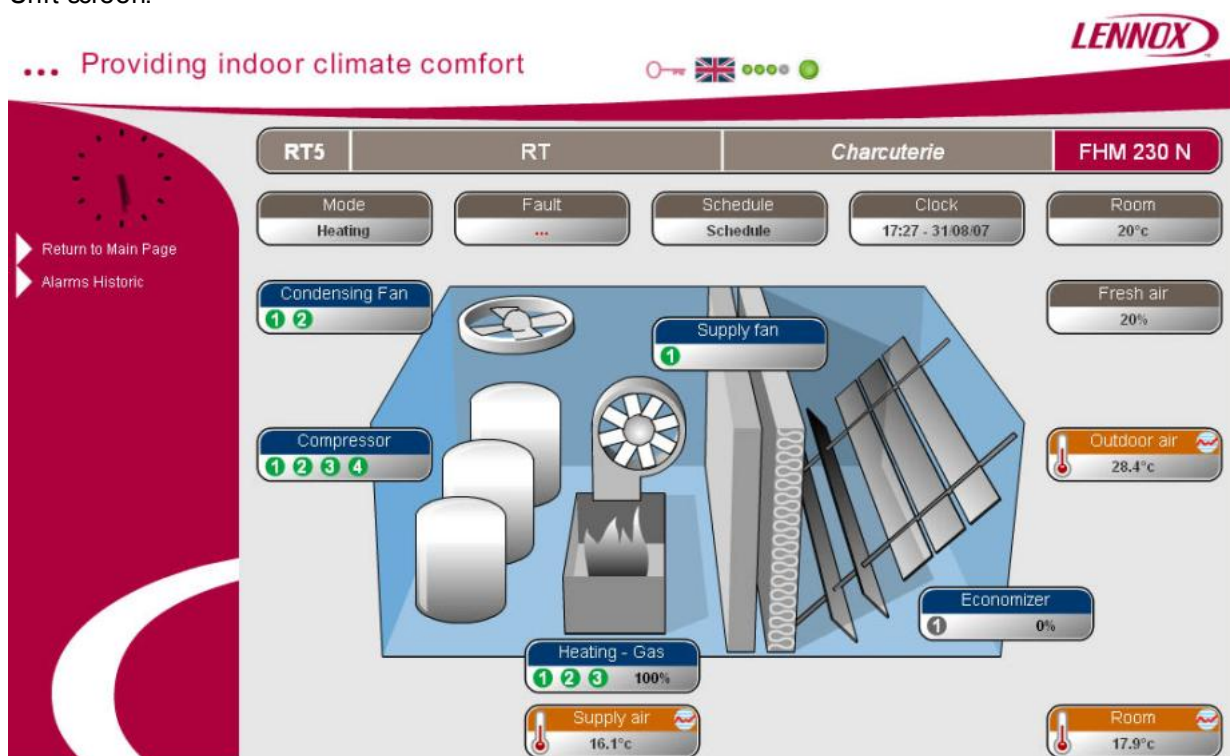

Parameters screen:

... Providing indoor climate comfort

RT7 RT Charcuterie BGK 045 HS

Heating - Gas

Values	
Data.1	
State	Disable in this zone
Relay	On
Power	High
Data.2	
State	Disable in this zone
Relay	On
Setting	
Activate, Schedule	Yes
Activate, Night	Yes
Activate, Day A	Yes
Activate, Day B	Yes
Activate, Day C	Yes

4.2.7.2. Electrical heating
Unit screen:

... Providing indoor climate comfort

RT6 RT Charcuterie FHK 085 N

Mode Heating Fault ... Schedule Schedule Clock 17:24 - 05:09:07 Room 27°C

Condensing Fan 1 2

Supply fan 1

Compressor 1 2 3 4

Heating - Electric 1 100%

Supply air 16.1°C

Economizer 1 0%

Outdoor air 0.1°C

Fresh air 40%

Room 14.8°C/0%HR

Return to Main Page

Alarms Historic

Parameters screen:

... Providing indoor climate comfort

RT6 RT Charcuterie FHK 085 N

Heating - Electric

Values	
Data.1	
State	Started, 1
Relay	On
Modulation	100%
Setting	
Set point, Mixing	5°C
Limitation, power	100%
Activate, Outside air	10°C
Activate, Schedule	Yes
Activate, Night	Yes
Activate, Day A	Yes
Activate, Day B	Yes
Activate, Day C	Yes

4.2.7.3. Hot water heating
Unit screen:

... Providing indoor climate comfort

RT2 RT Charcuterie BGK 030 SS

Mode Heating Fault ... Schedule Schedule Clock 17:25 - 31/08/07 Room 20.1°C

Condensing Fan 1 Supply fan 1

Compressor 1

Economizer 1 20%

Heating - Water 1 100%

Supply air 18.7°C

Fresh air 20%

Outdoor air 11.6°C

Room 12.6°C

Return to Main Page
Alarms Historic

Parameters screen:

... Providing indoor climate comfort

RT2 RT Charcuterie FCK 085 N

Heating - Water

Values

Data	
State	Waiting of ventilation
Modulation	0%
Switch, Safety Freeze	On
Setting	
Activate, Outside air	10°C
Leak-flow, Opening	0%
Safety, Freeze	Open
Activate, Schedule	Yes
Activate, Night	Yes
Activate, Day A	Yes
Activate, Day B	Yes
Activate, Day C	Yes



www.lennox europe.com

Due to Lennox's ongoing commitment to quality, the Specifications, Ratings and Dimensions are subject to change without notice and without incurring liability.

Improper installation, adjustment, alteration, service or maintenance can cause property damage or personal injury.

Installation and service must be performed by a qualified installer and servicing agency.