

# USER MANUAL SCROLL CHILLER

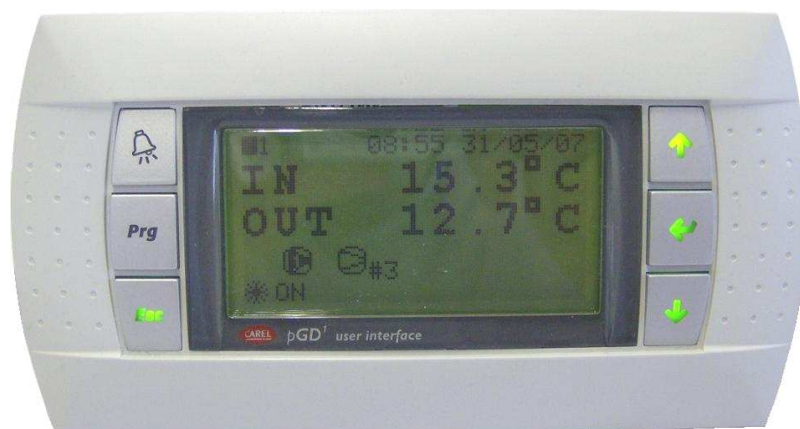



## TABLE OF CONTENTS

<b>1</b>	<b>GENERAL DESCRIPTION OF THE APPLICATION</b> .....	<b>7</b>
<b>2</b>	<b>CONTROL LOGIC</b> .....	<b>7</b>
2.1	CONTROL OF INLET TEMPERATURE.....	7
2.1.1	Hysteresis .....	8
2.1.2	PROPORTIONAL control.....	9
2.1.3	PROPORTIONAL + INTEGRAL Control.....	9
2.2	SETPOINT.....	9
2.3	ON/OFF ENABLING .....	11
2.3.1	On-Off by Time Zones .....	12
2.3.2	Inhibition of compressor operation based on outdoor temperature.....	13
2.4	OPERATING MODE.....	13
2.5	COMPRESSORS .....	14
2.5.1	Compressor rotation .....	14
2.5.2	Minimum ON time of a compressor .....	14
2.5.3	Minimum OFF time of a compressor .....	14
2.5.4	Delay time between two start-ups of different compressors.....	15
2.5.5	Delay time between two consecutive start-ups of the same compressor.....	15
2.5.6	Circuit Rotation .....	15
2.6	FANS .....	16
2.6.1	Condensation control .....	16
2.6.2	Evaporation Control .....	18
2.7	WATER RE-CIRCULATION PUMPS .....	19
2.7.1	Rotation logic .....	19
2.8	ELECTRICAL HEATING ELEMENTS.....	20
2.9	DEFROST FUNCTION.....	21
2.9.1	Start Defrost Logic .....	21
2.9.2	Main Phase .....	22
2.9.3	Override phases.....	22
2.9.4	Defrost Management .....	24
2.9.5	Manual Defrost Override.....	24
2.10	FREECOOLING .....	24
2.10.1	Activation of Freecooling.....	25
2.10.2	Fan speed in Freecooling mode .....	25
2.10.3	Combined operation: mechanical cooling + freecooling .....	26
2.10.4	Condensation coil capacity control .....	26
2.10.5	Capacity reducing override function .....	26
2.10.6	Freecooling warning.....	27
2.10.7	3-way valve maintenance function.....	27
<b>3</b>	<b>ALARMS</b> .....	<b>28</b>
3.1	ALARM MANAGEMENT .....	28
3.1.1	Phase Direction Alarm .....	28
3.1.2	Sensor Alarms .....	28
3.1.3	High Pressure Alarm from Digital Input .....	28
3.1.4	Low Pressure Alarm from Digital Input .....	29
3.1.5	High Pressure Alarm triggered by Sensor .....	29
3.1.6	Compressor Thermal Alarm.....	29
3.1.7	Fan Thermal Alarm .....	30
3.1.8	Antifreeze Alarm .....	30
3.1.9	Pump Thermal Alarm.....	31
3.1.10	Water Flow Alarm .....	31
3.1.11	Alarm from Digital Input .....	31
3.1.12	Maintenance Alarms .....	31
3.1.13	Clock Card Alarm.....	32
3.1.14	Digital Alarm Output.....	32
3.2	ALARM HISTORY .....	32
<b>4</b>	<b>USER INTERFACE</b> .....	<b>34</b>
4.1	DESCRIPTION OF KEYBOARD .....	34
4.2	SWITCHING ON THE UNIT AND SELECTING THE OPERATING MODE .....	34
4.3	SWITCHING OFF OF THE UNIT .....	35
4.4	GENERAL DESCRIPTION OF MENUS.....	35
4.5	USER INTERFACE CONNECTION.....	36
4.5.1	Physical connection .....	36
4.5.2	Software configuration .....	37

<b>5</b>	<b>ADDRESS SETTINGS</b> .....	<b>37</b>
5.1	SETTING THE DISPLAY ADDRESS .....	37
5.2	SETTING THE PCO ADDRESS (PCOXS OR PCO1) .....	38
5.3	MICROPROCESSOR/DISPLAY CONFIGURATION .....	38
<b>6</b>	<b>SCREENS</b> .....	<b>39</b>
6.1	MAIN .....	39
6.2	CHILLER STATUS .....	39
6.2.1	Chiller Status – Devices .....	39
6.2.2	Chiller Status - Valve .....	41
6.2.3	Chiller Status – LAN.....	41
6.3	INPUTS/OUTPUTS MENU.....	41
6.3.1	Inputs/Outputs Menu - I/O Status .....	41
6.3.2	Inputs/Outputs Menu - I/O Override.....	42
6.4	SETPOINT MENU .....	42
6.5	MAINTENANCE MENU .....	42
6.5.1	Running hours.....	42
6.5.2	History.....	42
6.6	MANUFACTURER'S MENU.....	43
6.6.1	Initialisation and password.....	43
6.7	INFO MENU.....	43
<b>7</b>	<b>APPLICATION SETTING PARAMETERS</b> .....	<b>44</b>
7.1	SETPOINT MENU .....	44
7.2	USER MENU .....	44
7.2.1	User - Setpoints and Parameters .....	44
7.2.2	User - LAN and Supervision .....	45
7.2.3	User - Alarms .....	45
7.2.4	User - Clock .....	45
7.3	MAINTENANCE MENU .....	45
7.3.1	Maintenance – Manual Control.....	45
7.3.2	Maintenance – Running hours.....	45
7.3.3	Maintenance – Parameters.....	46
7.4	MANUFACTURER'S MENU.....	46
7.4.1	Manufacturer - Unit Config.....	46
7.4.2	Manufacturer – Parameters .....	47
7.4.3	Manufacturer – Alarms.....	48
7.4.4	Manufacturer – Carel EVD.....	49
<b>8</b>	<b>CONTROL SYSTEM ARCHITECTURE</b> .....	<b>51</b>
8.1	MICROPROCESSOR LAYOUT .....	51
8.1.1	pCO1.....	51
8.1.2	pCOXS.....	52
8.1.3	Analog Input Configuration .....	52
8.2	DESCRIPTION OF INPUTS/OUTPUTS.....	53
8.2.1	pCO1.....	53
8.2.2	pCOXS.....	58
8.3	INPUT/OUTPUT OVERRIDE .....	60
<b>9</b>	<b>SUPERVISION</b> .....	<b>61</b>
9.1	MAIN PARAMETERS.....	61
9.2	CONNECTION WITH CAREL / MODBUS PROTOCOL.....	61
9.3	CONNECTION WITH LONWORKS PROTOCOL.....	62
9.4	GSM PROTOCOL .....	62
9.4.1	Alarm Message .....	62
9.4.2	Unit Status Message .....	63
9.4.3	Main Parameters Message .....	63
9.4.4	Parameter Configuration Message .....	63
9.4.5	Software configuration .....	65
9.4.6	Modem Configuration.....	66
9.4.7	Modem status.....	66
9.5	OTHER SUPERVISION PROTOCOLS.....	66
9.6	LIST OF VARIABLES UNDER SUPERVISION .....	67
<b>10</b>	<b>LAN</b> .....	<b>70</b>
10.1	LAN LOGIC(USER MENU -> LAN AND SUPERVISION ) .....	70
10.1.1	Control Logic .....	70
	Example 70	
10.1.2	Rotation Logic .....	71
10.1.3	LAN dynamics.....	72

10.2	SYSTEM CONFIGURATION .....	72
10.2.1	Address Settings .....	73
10.2.2	Electrical Connection .....	73
10.2.3	Configuration of LAN Application .....	74
10.2.4	LAN Status .....	75
10.2.5	Switching on Units .....	75
10.2.6	Shared Display Terminal.....	76
<b>11</b>	<b>ADVANCED OPTIONS .....</b>	<b>76</b>
11.1	LOW LOAD LOGIC .....	76
11.2	HIGH PRESSURE PREVENTION FUNCTION .....	77
11.3	ELECTRONIC VALVE.....	77
11.3.1	EVD 400 – tLAN.....	78
11.3.2	EVD 400 – pLAN.....	79
11.3.3	Software Management.....	79



# 1 GENERAL DESCRIPTION OF THE APPLICATION

The software application to which this manual relates has been designed to manage all Cooling Only, Heat Pump and Freecooling Chillers equipped with scroll compressors. For this purpose we have implemented the option of using either a pCOXS or pCO1 electronic controller, based on the type of chiller. Given the differences in the inputs/outputs, some logics refer only to the more complete control system.

## 2 CONTROL LOGIC

### 2.1 CONTROL OF INLET TEMPERATURE

**Inputs used:**

- Evaporator inlet water temperature

**Parameters used:**

- Control setpoint (*Setpoint menu*)
- Proportional band for inlet temperature control (*User menu → Setpoints and parameters → H9*).
- Type of control (*User menu → Setpoints and parameters → H3*)
- Integration time (if Proportional + Integral control is enabled) (*User menu → Setpoints and parameters → H3*)
- Hysteresis percentage for single compressor (*User menu → Setpoints and parameters → H3*)

**Outputs used:**

- Compressors On/Off

**EX:** Diagram showing control logic with 4 compressors and 100% hysteresis:

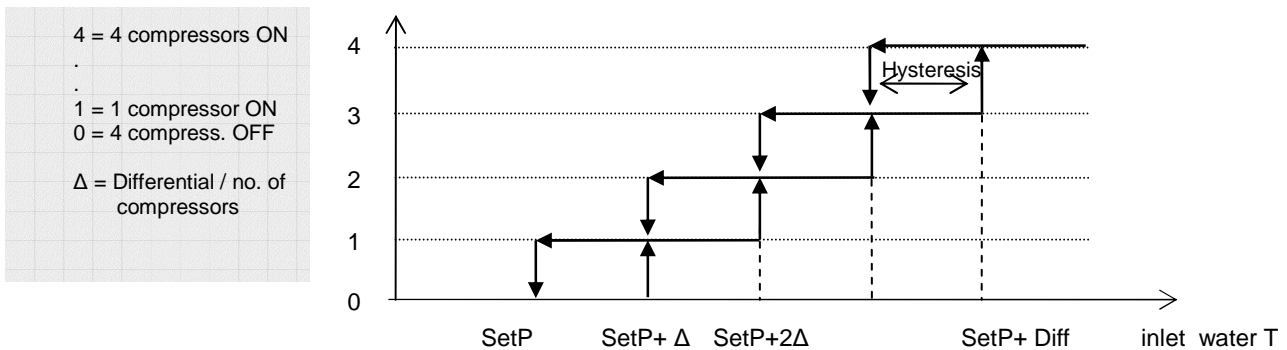

**Figure 1: Control with 4 compressors – 100% hysteresis**

**EX:** Diagram showing control logic with 4 compressors and 70% hysteresis:

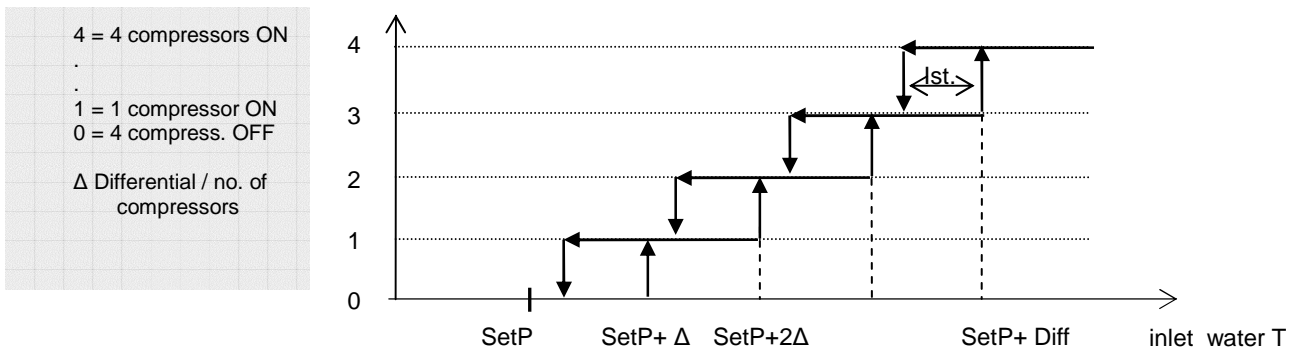

**Figure 2: Control with 4 compressors – 70% hysteresis**

## 2.1.1 Hysteresis

(User menu → Setpoints and parameters → H3)

The typical system with hysteresis of the capacity control steps provokes an often undesired undercooling effect during the thermal load reduction phase and at the points of variation in the capacity control steps.

Let us consider the following example:

- Unit with 2 compressors ( let us assume the cooling capacity of a single compressor to be equal to 2.5°C)
- Setpoint: 12°C
- Differential: 2°C
- Hysteresis 100%

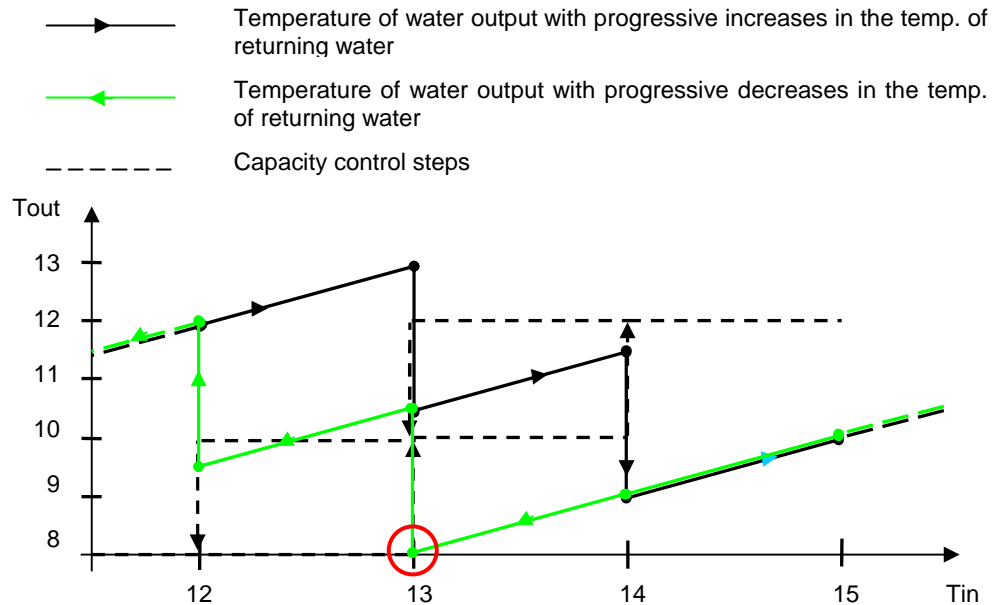

As may be seen from the above diagram, in the phase characterised by increases in the thermal load (and hence increases in the inlet water temperature), the unit's entire capacity will be utilised at 14° with an output of water at 9°C. In the opposite situation, i.e. a reduction in the thermal load, at a temperature barely above 13°C the hysteresis will cause the chiller to keep working with both compressors on. This causes the outlet water temperature to cool by a further 5°C, thus bringing it to 8°C. The effect of this hysteresis step is to produce colder water in a less critical phase, one in which theoretically speaking such a large thermal differential would not be necessary.

Where we have the option of modifying the dimension of the hysteresis window, we can thus reduce this undercooling effect.

Below we give two examples with reduced hysteresis.

### 1. Hysteresis 50%

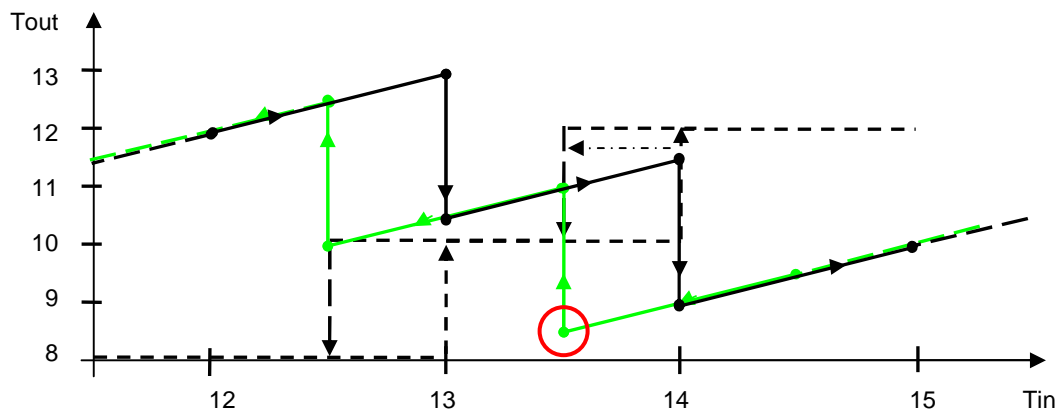



## 2. Hysteresis 30%

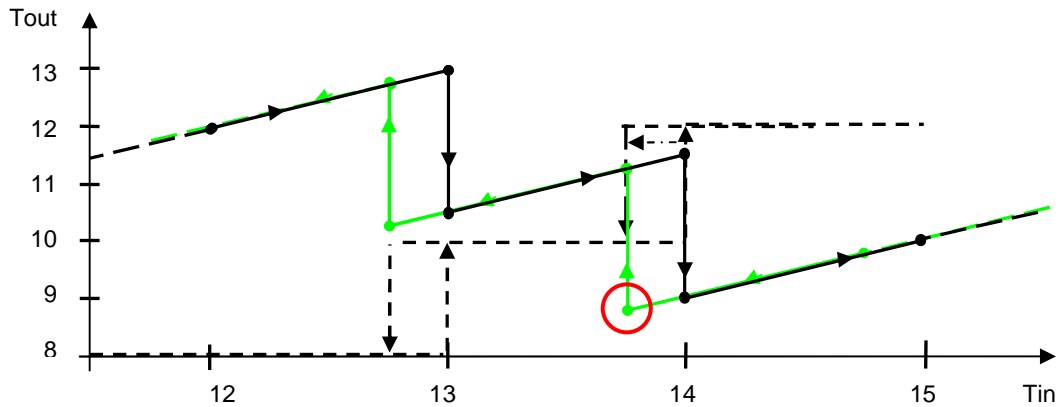

We may note that narrowing the hysteresis window has the effect of shifting the reference temperatures at which the number of active capacity control steps will be reduced; consequently, the compressors will switch off earlier. The output water will thus be less cold on average. Referring to the critical point highlighted in the example with 100% hysteresis, we can see that we will go from a temperature of 8°C (with 100% hysteresis) to a value just below 9°C (with 30% hysteresis).

It is important to bear in mind that an excessive reduction in this parameter may lead to a condition of instability and a larger number of compressor ON/OFF switching operations.

### 2.1.2 PROPORTIONAL control

When selected from the *User menu* → *Setpoints and parameters* → *H3*, the proportional control function based on the currently active setpoint (*Setpoint menu*) and differential (*User menu* → *Setpoints and parameters* → *H9*) will define a proportional band. Within this band the positions of the device control steps will be computed based on the number of compressors.

### 2.1.3 PROPORTIONAL + INTEGRAL Control

The proportional + integral control system uses the same parameters as the simple proportional control, computing the device switch-on steps based on the setpoint, differential and set integration time (*User menu* → *Setpoints and parameters* → *H3*)

## 2.2 SETPOINT

### Active Setpoint

( *Setpoint menu* → *F1* )

The first screen displayed in the SETPOINT menu indicates the setpoint value used in the chiller control logic. This is the overall value resulting from automatic adjustments, corrections and limitations.

### Main setpoint

( *Setpoint menu* → *F2* )

From the SETPOINT menu you can establish the main setpoint for the summertime and wintertime operating modes.

```

t_setpoint_2
+-----+
| SETPOINT                F2 |
| SETTING                 |
|                            |
| Cool. : 00.0°C          |
| Heat.  : 00.0°C          |
|                            |
+-----+

```

### Secondary setpoint

( *Setpoint menu* → *F3* )

From the SETPOINT menu you can establish the secondary summertime and wintertime setpoints controlled by the digital input ID14 (or ID6 with pCOXS). When the digital input is open, the main setpoint will be used under the control logic; when the digital input is closed the secondary setpoint will be used.

```

t_setpoint_3
+-----+
| SECONDARY SETPOINT F3 |
| SETTING                |
|                        |
| Cool.: 00.0°C         |
| Heat.: 00.0°C         |
|                        |
+-----+

```

Condition:

- configuration of digital input ID14 (or ID6 with pCOXS) as “->secondary setpoint” (*User menu → Setpoints and parameters → H1 or H2*)
- selection of automatic setpoint adjustment “by digital input” (*User menu → Setpoints and parameters → H4*)

### Setpoints for programmed time zones

From the SETPOINT menu you can set time zones for every day of the week ( *Setpoint menu → F7*).

```

t_setpoint_7
+-----+
| SETPOINT TIME Z.      F7 |
| Mon: 00:00 - 00:00    |
| Tue: 00:00 - 00:00    |
| Wed: 00:00 - 00:00    |
| Thu: 00:00 - 00:00    |
| Fri: 00:00 - 00:00    |
| Sat: 00:00 - 00:00    |
| Sun: 00:00 - 00:00    |
+-----+

```

At the same time you must set the summer and winter setpoints to be used during or outside the time zones (*Setpoint menu → F4-F6*).

```

t_setpoint_4
+-----+
| TIME ZONES SETPOINT F4 |
| SETTING                |
|                        |
| IN time zone: 00.0°C  |
| OUT time zone: 00.0°C |
|                        |
+-----+

```

Conditions:

- clock card present
- selection of automatic setpoint adjustment by “time zones” (*User menu → Setpoints and parameters → H4*)

### Remote setpoint (adjustment)

(*Setpoint menu → F9*)

From the SETPOINT menu you can enable the function for remotely correcting the setpoint via an analog input. The signal will be converted between the minimum and maximum values set from the menu. The value thus obtained (in degrees) will then be added to the value derived from the main, secondary or time zone setpoint.

```

t_setpoint_9
+-----+
| SETPOINT REMOTE      F9 |
| ADJUST               |
|                        |
| Enable: no           |
| Min.  00.0°C         |
| Max.  00.0°C         |
|                        |
+-----+

```

Condition:

- pCO1 (use of analog input B3)
- pCOXS with analog input B2 configured for remote setpoint adjustment (*Manufacturer's menu → Unit Config. → S7*)

### Setpoint Compensation

(*Setpoint menu → Fa-Fb*).

The compensation function corrects the control setpoint based on the outdoor temperature. For both the heating and cooling modes it is possible to select a compensation setpoint, differential and max. adjustment.

The logic works as follows:

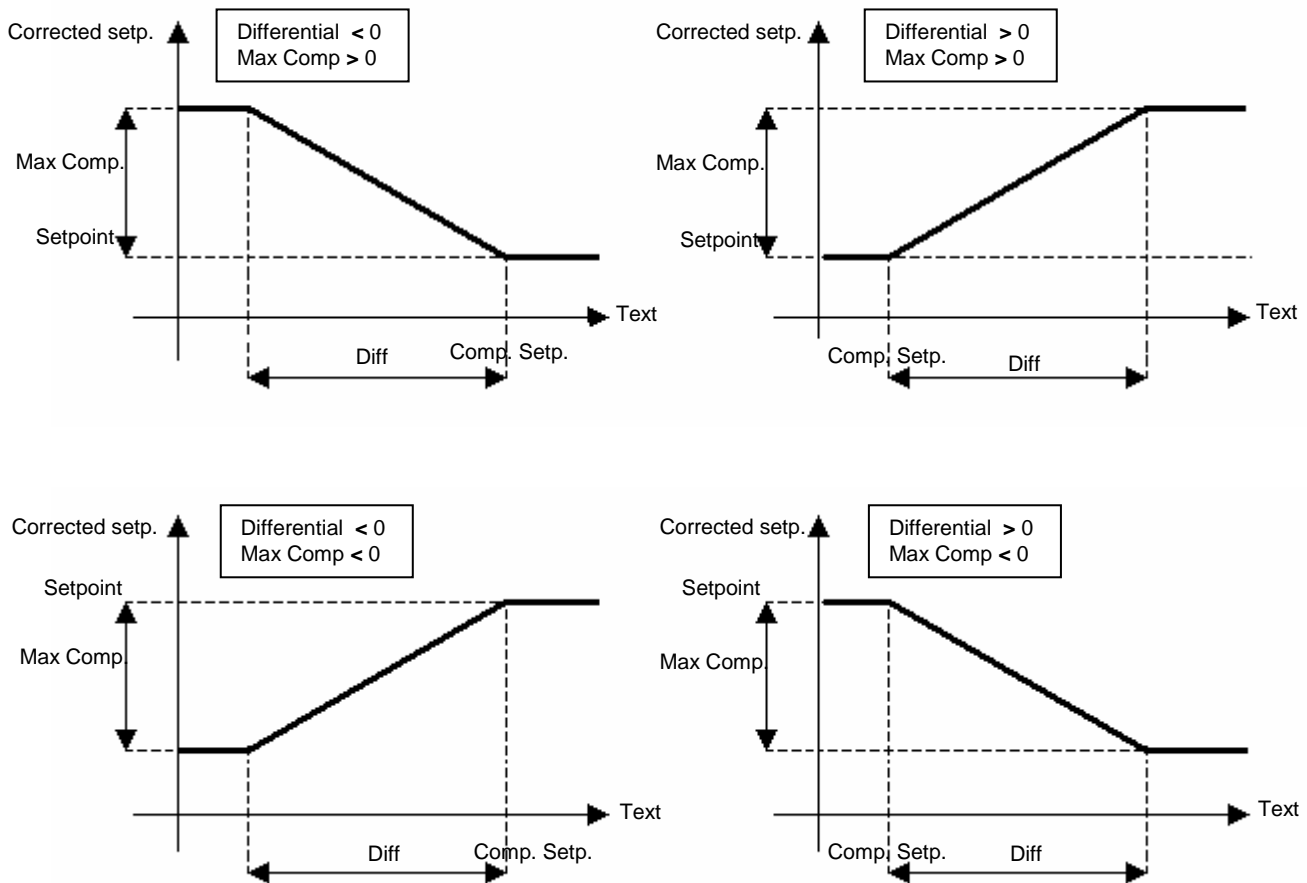

**EX:**

Let us assume we have set the following parameters for the cooling mode:

- Cooling setpoint: 12°C
- Compensation setpoint: 30°C
- Differential: 10°C
- Max compensation: 4°C

When the outdoor temperature is less than 30°C the control setpoint (assuming that no other setpoint adjustment logics are active) will be 12°C

When the outdoor temperature is between 30°C and 40 °C, the control setpoint is adjusted by an amount of compensation calculated on the basis of the adjustment ramp defined by the parameters themselves. (e.g.: Text = 32°C → compens. = 0.8°C → active setpoint = 12 + 0.8 = 12.8°C)

With temperatures above 40°C the amount of compensation will be 4°, resulting in a setpoint of (12 + 4) 16°C.

Conditions:

- pCO1: outdoor temperature sensor enabled (*Manufacturer's menu* → *Unit Config.* → S9);
- pCOXS: analog input B2 configured as "outdoor temp. sensor" (*Manufacturer's menu* → *Unit Config.* → S7)
- summer and/or winter compensation enabled (*User menu* → *Setpoints and parameters* → H5)

**NB:** the setpoint obtained based on the various logics enabled will be limited according to criteria set by the user (*User menu* → *Setpoints and parameters* → H7-H8). If this is necessary, the item "**Bounded**" will be checked on the screen of the active setpoint.

### 2.3 ON/OFF ENABLING

From the *User menu* → *LAN and Supervision* → J1 it is possible to define how the on/off switching of the chiller will be controlled. The options are:

- by means of the keyboard (local or remote independently)
- by time zones
- by remote contact
- by supervisor

Since these are means for enabling operation, if more than one of the options is selected all will need to be in the ON status in order for the chiller to work. The main screen shows the unit's status specifying, in the event that the chiller is OFF, the condition that imposes this status.

```

main
+-----+
|U1      08:00 01/01/00|
| IN    12.0°C |
| OUT   12.5°C |
| OFF by keyboard |
+-----+

```

The indication shown may be:

- ON: chiller on (all On/Off logics of the unit enable operation).
- OFF Alarm : chiller off because an alarm has occurred. Irrespective of the status of the enabled On/Off logics, some alarms will cause the unit to shut down.
- OFF Superv. : chiller switched off by Supervisor.
- OFF Time Z. : chiller off according to scheduled time zones.
- OFF Remote : chiller switched off by remote digital contact.
- OFF Keyboard : chiller switched off from the keyboard. If this option is disabled, it will no longer be possible to change the unit's status from the keyboard. NB: If the chiller has been switched off from the keyboard and then this control mode is disabled, it will no longer be possible to switch on the unit.
- Standby : chiller switched off by the Master unit. This status of the unit depends on the use of LAN logic and the setting of a specific type of rotation mode on the Master unit.

### 2.3.1 On-Off by Time Zones

If the optional clock card is installed it will be possible to schedule the unit On/Off times according to time zones.

#### Enabling requirements

- Clock card installed
- The On-Off by time zones option must be enabled (*User menu* → *LAN and Supervision* → *J1*)

```

t_user_lan_1
+-----+
|UNIT ON/OFF          J1|
|Enable On/Off by:   |
|                    |
| - time zones      : yes|
+-----+

```

#### Setting On-Off Time Zones

Four different time zones are present (*User menu* → *Clock* → *L2*); two are configurable and can be used to define the logic of the different days of the week.

- Time zone 1 (F1) : it defines 2 unit on/off intervals over a 24 hour period

```

m_clock_2
+-----+
|ON/OFF TIME ZONES   L2|
|Time Zone 1:        |
|ON 00:00 - OFF 00:00|
|ON 00:00 - OFF 00:00|
+-----+

```

- Time zone 2 (F2) : it defines one unit on/off interval over a 24 hour period

```

m_clock_2
+-----+
| ON/OFF TIME ZONES L2 |
+-----+
|
| Time Zone 2:
| ON 00:00 - OFF 00:00
|
+-----+

```

- Time zone 3 (F3) : unit always on
- Time zone 4 (F4) : unit always off

### Weekly programming

Once the On/Off time zones have been defined, they must be used to define the logic to be adopted on different days of the week (*User menu* → *Clock* → *L3*)

```

m_clock_3
+-----+
| Time Zones          L3 |
| Selection           |
+-----+
| Mon: F1  Tue: F1   |
| Wed: F1  Thu: F1   |
| Fri: F1  Sat: F1   |
| Sun: F1              |
+-----+

```

**NB:** The On/Off by time zones option is only a means of enabling or disabling operation; this means that the unit will switch on only if all the active On/Off options (*User menu* → *LAN and Supervision*) similarly enable operation.

### 2.3.2 Inhibition of compressor operation based on outdoor temperature

(*Manufacturer's menu* → *Parameters* → *Tz*)

When a temperature sensor is installed, it is possible to enable a function for monitoring outdoor temperature so as to prevent compressor start-up during operation in the heat pump mode. In particular low-temperature conditions the chiller could end up outside its operating range, being forced to evaporate at too low a temperature.

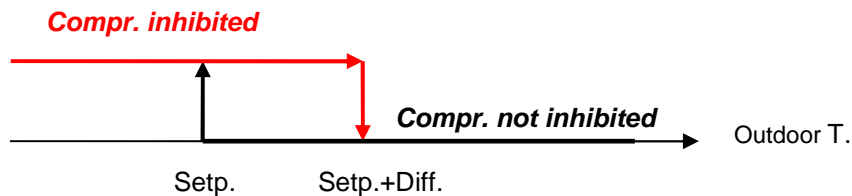

## 2.4 OPERATING MODE

For heat pump models, the operating mode can be selected using different solutions (some of which can be enabled from *User menu* → *LAN and Supervision* → *J2*). Unlike in the case of On/Off logics, here the logic will be determined according to priority.

The possible methods for selecting the unit's operating mode (cooling/heating) are shown below, in order of priority:

1. via Digital input
2. from the Keyboard or via the Supervisor

When the chiller is switched on the control logic will check the operating mode and show this information on the main screen (the correspondence between the symbol used on the display and the mode can be configured from the *User menu* → *Setpoints and parameters* → *Hh*)

```

main
+-----+
| U1      08:00 01/01/00 |
| IN      12.0°C |
| OUT     12.5°C |
| [Icon] #1 [Icon] |
| [Icon] ON |
+-----+

```

**NB:** If the units are controlled via a LAN-based system, the operating mode can be selected only on the Master unit. This will activate the same mode for the Slave units as well, overriding the other methods of mode selection.

## 2.5 COMPRESSORS

The controller permits the management of hermetic scroll compressors. The number of compressors and circuits is set from the screens of the *Manufacturer's menu* → *Unit Config.* → *S2*.

The majority of the interventions effected by the pCO controller are subject to delay times programmable from the manufacturer's menu. These delays are designed to assure correct operation of the compressors and increase the stability and lifespan of the system.

### 2.5.1 Compressor rotation

(User menu → Setpoints and Parameters)

Compressors are switched on in turns so that the number of running hours and starts/stops of different compressors are equally divided. The method of rotation can follow two different logics:

- FIFO: the first compressor to start will be the first one to stop.
- LIFO: the last compressor to start will be the first to stop.

The unit's operation may initially result in large differences in the running times of the various compressors, but under normal working conditions they will eventually become very similar.

**EX: FIFO rotation (with four compressors):**

- ON sequence: C1,C2,C3,C4.
- OFF sequence: C1,C2,C3,C4.

**EX: LIFO rotation (with four compressors):**

- ON sequence: C1,C2,C3,C4.
- OFF sequence: C4,C3,C2,C1.

### 2.5.2 Minimum ON time of a compressor

(Manufacturer's menu → Parameters → T1)

It establishes the minimum time (in seconds) for which the compressors must remain on; therefore, once they start up they must keep running for a period at least equal to the set time.

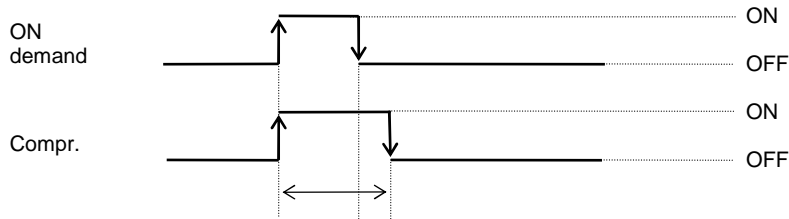

Figure 3: Minimum compressor ON time

### 2.5.3 Minimum OFF time of a compressor

(Manufacturer's menu → Parameters → T1)

It establishes the minimum time (in seconds) for which the compressors must remain off. The compressors will not be started up again until the set minimum time has elapsed since they were last switched off.

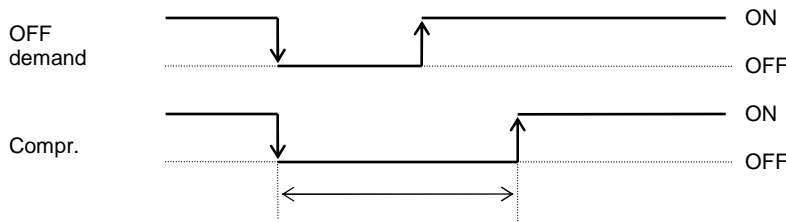

Figure 4: Minimum compressor OFF time

## 2.5.4 Delay time between two start-ups of different compressors

(Manufacturer's menu → Parameters → T2)

It establishes the minimum time that must elapse between two compressor start-ups, irrespective of the water temperature read and the setpoint.

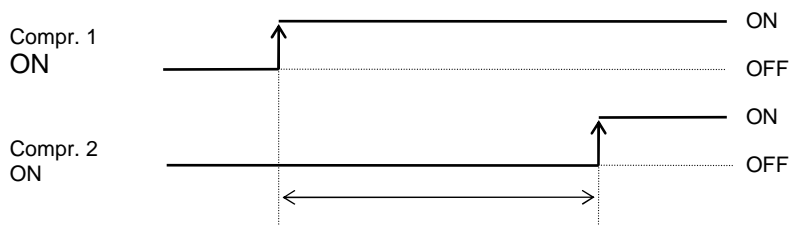

Figure 5: Delay time between two start-ups

## 2.5.5 Delay time between two consecutive start-ups of the same compressor

(Manufacturer's menu → Parameters → T2)

It establishes the minimum time that must elapse between two start-ups of the same compressor, irrespective of the water temperature read and the setpoint. This parameter makes it possible to limit the number of switching operations per hour. If, for example, the maximum allowed number of compressor starts per hour is equal to 10, it will suffice to set a value of 360 seconds to assure compliance with this limit.

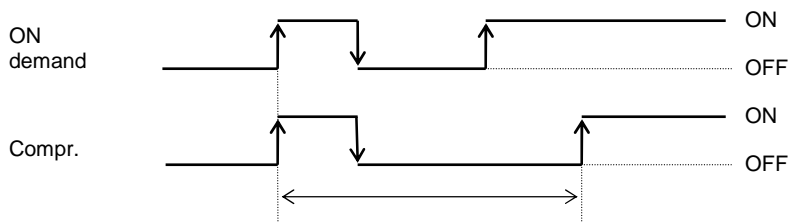

Figure 6: Delay time between two consecutive start-ups

## 2.5.6 Circuit Rotation

(User menu → Setpoints and Parameters)

In addition to the logic whereby compressors are operated in turn, it is also possible, in the case of two circuits, to select how start-up demands will be distributed. The possible logics are:

- **Balanced Rotation:** compressor "ON" commands will be transmitted in turn to one circuit and then the other.
- **Unbalanced Rotation:** the required compressor capacity will be drawn first using all the resources of one circuit before switching over to the other.

### EX: Balanced rotation (with 2 circuits comprising 2 compressors each)

The ON sequence of the 4 compressors will be:

1. Compr.1 – circuit 1
2. Compr.1 – circuit 2
3. Compr.2 – circuit 1
4. Compr.2 – circuit 2

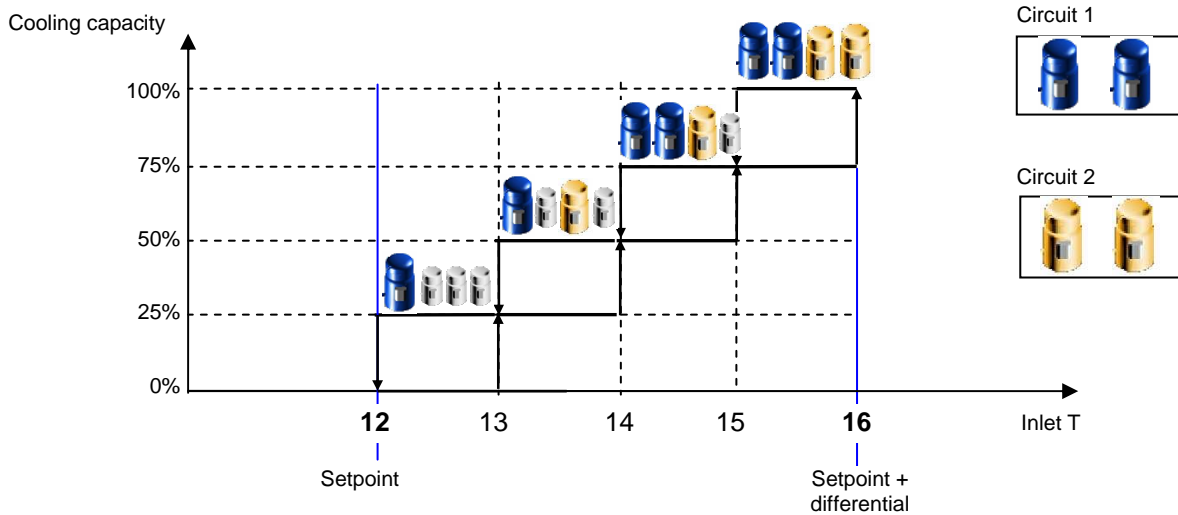
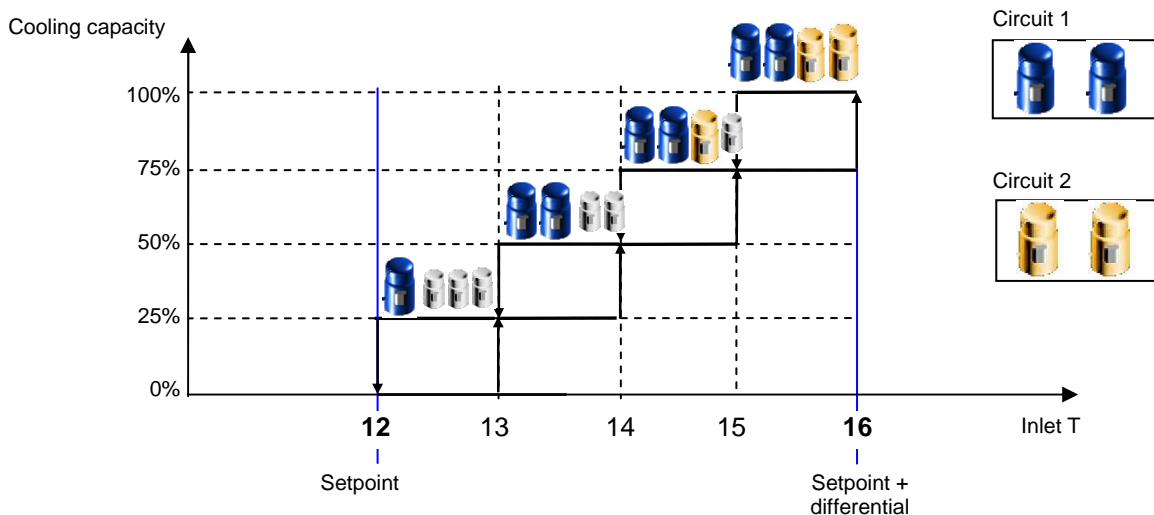

**Figure 7: Balanced Rotation**

**EX: Unbalanced Rotation (with 2 circuits comprising 2 compressors each)**

The ON sequence of the 4 compressors will be:

1. Compr.1 – circuit 1
2. Compr.2 – circuit 1
3. Compr.1 – circuit 2
4. Compr.2 – circuit 2



**Figure 8: Unbalanced Rotation**

## 2.6 FANS

### 2.6.1 Condensation control

*(Manufacturer's menu → Unit Config.)*

Condensation control entails first of all configuring the number of series of fans (0-2) and the type of control output:

- PWM output
- 0-10V output

The output used must be configured according to the type of speed regulator and fan used in order to define the operating range.

#### 0-10V output

- Min V: minimum fan operating voltage.
- Max V 1: maximum voltage for the fan pulse-width modulation ramp, where present.
- Max V 2: maximum fan operating voltage.



## PWM output

- Min.Triac : minimum phase difference.
- Max.Triac: maximum phase difference.
- Wd Triac: duration of triac pulse.

As regards the condensation control logic, besides the option of disabling it ( in which case there will not be any enabling of the fans), there are two control modes to select from (*Manufacturer's menu* → *Unit Config.* → *S5*):

- On/Off Control
- Modulating Control

Both logics work on the basis of the condensation pressure; the respective parameters and functions are illustrated below.

### 2.6.1.1 On/Off Control (*Manufacturer's menu* → *Parameters* → *T5*)

#### Configuration Parameters

- set point
- differential

Based on the condensation pressure within the circuit, the fans will be made to operate at 0% or 100% of their capacity. If the fans are controlled by means of a 0-10V signal, their activation at 100% capacity will bring the respective output to the maximum operating voltage.

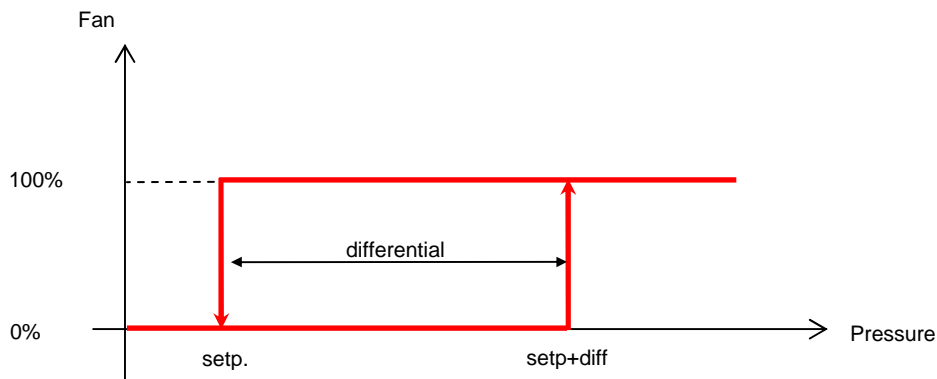

Figure 9: Condensation Ctrl On/Off

In the case of the pCO1 microprocessor, the logic also manages a digital signal for enabling each series of fans (NO9-NO12); this output will be active every time the fan is switched to 100%.

### 2.6.1.2 Modulating Control (*Manufacturer's menu* → *Parameters* → *T5*)

#### Configuration Parameters

- setpoint
- differential

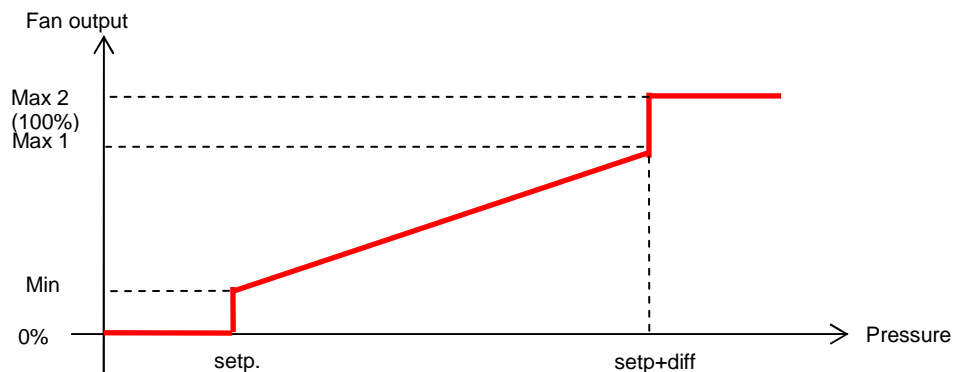

Figure 10: Modulation with 0-10V output

Based on the condensation pressure, the fan will be controlled via a modulating signal as soon as an operating capacity above 0% is demanded (in this case it will be made to operate at the minimum of its operating range). In cases where the fans are controlled via a 0-10V output, if Max1 and Max2 take on a different value, when the “setpoint+differential” values are reached, there will be a step in the control value equal to the difference between the two parameters (see ex. Figure 10).

With the pCO1 microprocessor, the logic that manages the additional digital enabling signal (NO9-NO12) will activate this output in the following cases:

- modulating control active (with compressors running)
- fans switched on via override

### 2.6.1.3 Condensation Options

In addition to the condensation logics described above, it is possible to switch on the fans via an override function.

### 2.6.1.4 Override function for activating Fans when Compressors are switched On

(Manufacturer's menu → Parameters → T6)

At compressor start-up, it is possible to choose between:

- **No override:** the fans will be controlled by the selected condensation logic
- **Speed UP:** irrespective of the pressure the fans will be switched on at compressor start-up. The parameters that may be set under this logic are:
  - Duration: time of fan operation
  - Fan speed: level of fan operation (with On/Off control, this value will be equal to 100%)
- **In advance :** irrespective of the pressure, the fans will be switched on, preceding and momentarily inhibiting the start-up of the compressors. The parameters that may be set under this logic are:
  - Duration: time of fan operation
  - Fan speed: level of fan operation (with On/Off control, this value will be equal to 100%)

### 2.6.1.5 Override function for activating Fans when an Alarm occurs

(Manufacturer's menu → Parameters → T7)

Only in the case of modulating condensation control will it be possible to choose the level of operation of the fans in the event of alarms generated by failure of the pressure sensor

```

t_costr_par_7
+-----+
| CONDENSATION          T7 |
| CONTROL               |
|                         |
| Condensation fans     |
| override level        |
| on alarm: 000.0%     |
+-----+
    
```

## 2.6.2 Evaporation Control

In the case of Heat Pumps it is also possible to customise the evaporation control function by configuring a setpoint and differential (Manufacturer's menu → Parameters → T8) and overrides (Manufacturer's menu → Parameters → T9-Ta).

Below we illustrate how the above-described logics work in controlling condensation.

- **On-Off Control**

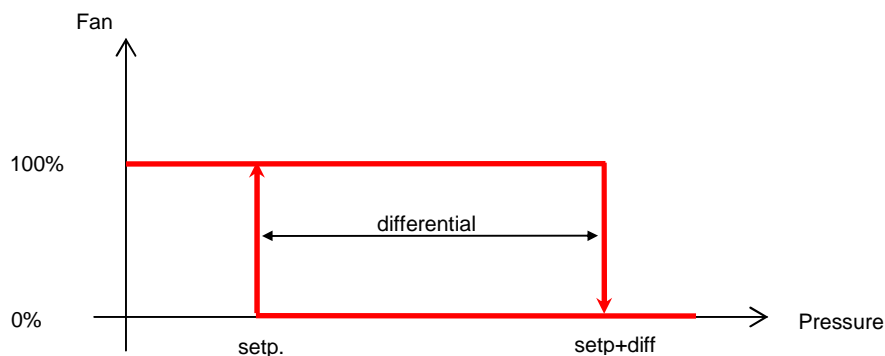
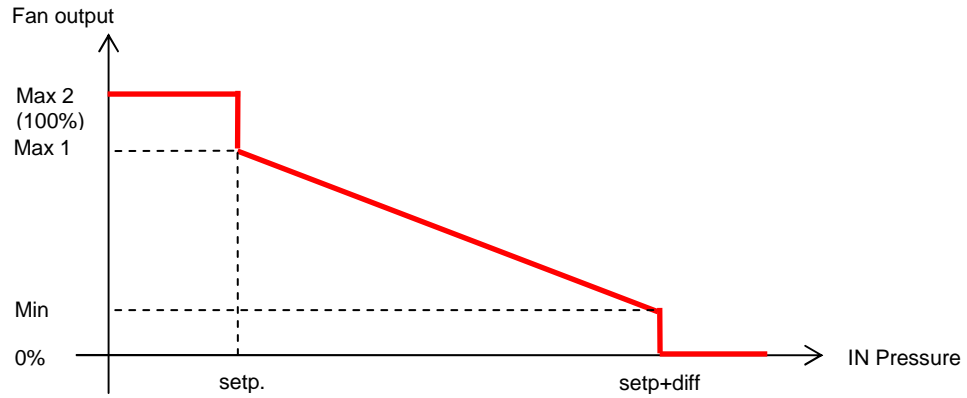

Figure 11: Evaporation On/Off Ctrl

- **Modulating Control**



**Figure 12: Modulating Ctrl with 0-10V output**

## 2.7 WATER RE-CIRCULATION PUMPS

The number of pumps that can be managed by the control software depends on the type of microcontroller used. 2 pumps can be used only with a pCO1 controller.

### 2.7.1 Rotation logic

(User menu → Setpoints and Parameters)

If 2 pumps are installed, it will be possible to choose between:

- Manual Rotation
- Automatic Rotation

#### 2.7.1.1 Manual Rotation

This type of logic entails choosing which pump will be used during normal chiller operation. The second pump will be switched on only if the first pump goes into an alarm status. If an alarm occurs in the second pump as well, the unit will be stopped.

#### 2.7.1.2 Automatic Rotation

If the automatic rotation option is selected it will also be necessary to set the pump changeover or “rotation” time. The events that can interact with normal pump rotation are:

- switching off of the unit
- pump in alarm status

#### Unit switched off

If the unit is switched off, the time count will also be interrupted.

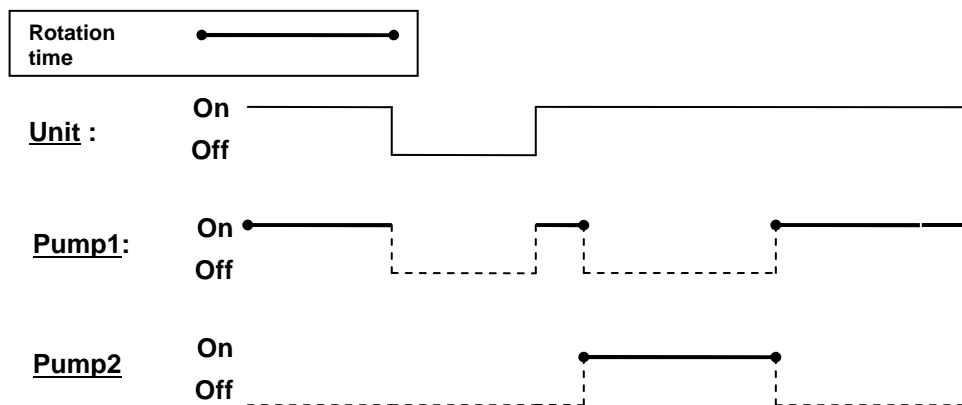

**Figure 13: Pump Rotation with Unit Off**

### Pump alarm

In the event that the currently active pump goes into an alarm status, the second pump will be automatically switched on until the first one is fixed. Once the alarm has been cleared, the pump that had not completed its turn will start up again and repeat the entire cycle.

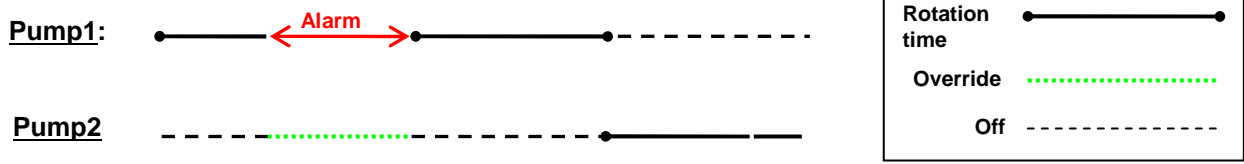

Figure 14: Pump Rotation with Alarm - 1

In cases where it is instead the non-active pump that gives an alarm signal, the first pump will keep running until the alarm is cleared. Once normal operating conditions have been restored, rotation will proceed normally.

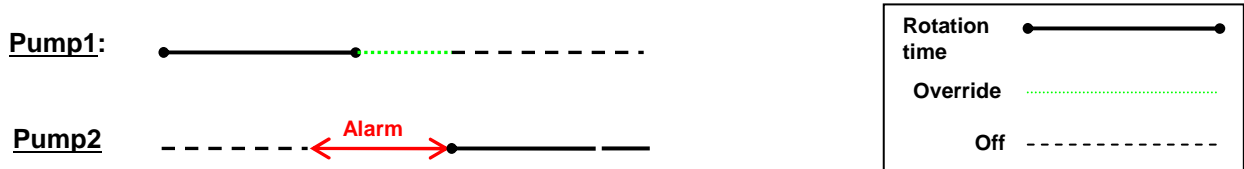

Figure 15: Pump Rotation with Alarm - 2

If the chiller switches off due to both pumps being in an alarm status, once normal operating conditions are restored the pump that will start up first will be the one determined by the Sequence parameter (*User menu → Setpoints and Parameters → Ha*) (which in the case of manual rotation defines the pump to be used)

```

t_user_set_10
-----
PUMPS                Ha
Rotation: man
Period : 000 hours
Sequence : pump 1
    
```

### OFF delay time

Another pump configuration parameter is the delay with which it will switch off after the compressors have stopped. This time, which can be set from the *Manufacturer's menu → Parameters → Tb* is also used to set the time by which the pump will start up in advance when the unit is switched on.

## 2.8 ELECTRICAL HEATING ELEMENTS

#### Inputs used:

- Evaporator 1 outlet water temperature sensor (B4: pCO XS, B5: pCO1)
- Evaporator 2 outlet water temperature sensor (B6: pCO 1)

#### Outputs used:

- NO7 (pCO1 controller)
- NO2 (pCO XS controller)

**NB:** in the case of a pCOXS controller the heating element must be enabled from the manufacturer's menu (*Manufacturer's menu → Unit Config. → Sa*)

#### Control parameters

(*Manufacturer's menu → Parameters → T3*)

- Enabling
- Setpoint
- Differential

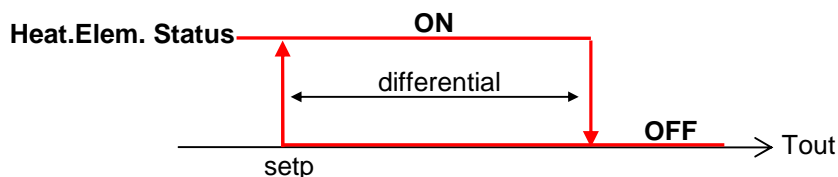

Figure 16. Heating Element Logic

## Operating logic

The temperature used in the heating element control logic, in the case of a unit with a single evaporator, is the one read by the sensor on the outlet side; in the case of two evaporators, the lower of the two outlet water temperatures will be taken.

If an error occurs in one of the two sensors, the incorrect reading will be ignored; if no reliable reading is available, the heating element will be disabled.

## 2.9 DEFROST FUNCTION

(Manufacturer's menu → Parameters )

The defrost logic defines the chiller's operation when the device statuses are as follows:

- compressors ON
- fans OFF
- 4-way valve reversed from the heat pump position

This logic can be broken down into 3 phases:

- Initial Override
- Main Phase
- Final Override

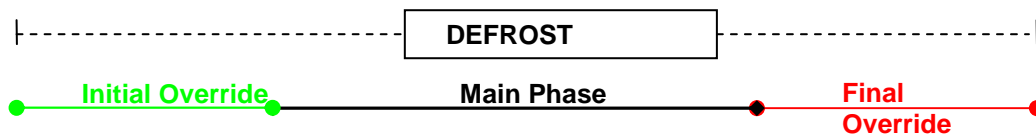

Figure 17: Defrost - Phases

Though not in the main phase, where the chiller operates with the above-described defrost logic, in the other two phases it is possible to enable the override logics which alter the defined configuration.

### 2.9.1 Start Defrost Logic

(Manufacturer's menu → Parameters → Td...)

There exist two different logics for activating a defrost cycle; namely:

#### 2.9.1.1 Pressure Threshold Logic

(Manufacturer's menu → Parameters → Te)

Defrosting will begin if the evaporation pressure remains beneath the start defrost threshold for a cumulative amount of time ( $t_1+t_2+t_3$ ) equal to the defrost delay time and if at least one of the compressors of the circuit concerned is running.

The relevant parameters are:

- Defrost start setpoint
- Time pressure remains below threshold

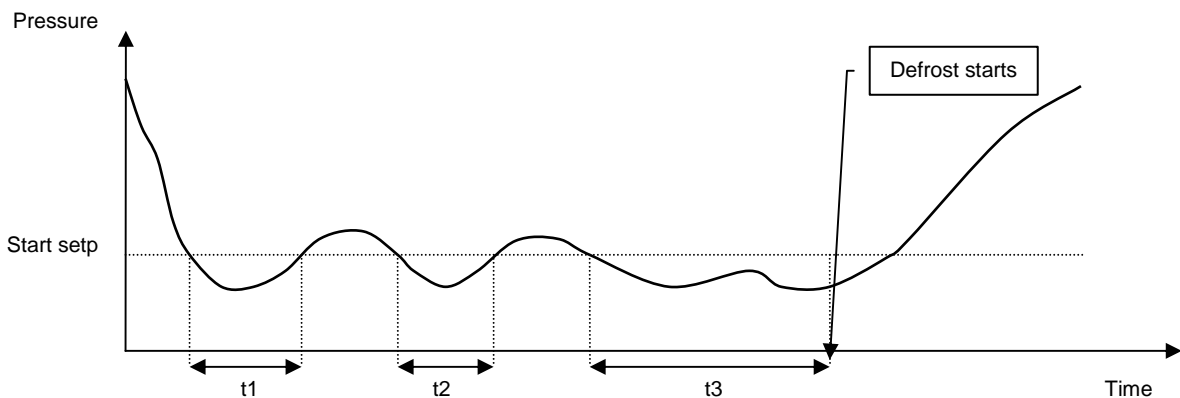

Figure 18: Threshold Logic

#### 2.9.1.2 Temperature Change-Based Logic

(Manufacturer's menu → Parameters → Tf..Tf2)

Defrosting will begin if the saturated evaporation temperature falls beyond a certain set limit below the maximum detected during normal operation.

The relevant parameters are:

- Change, in relation to the maximum saturation temperature detected, such as to trigger the beginning of a defrost cycle
- Delay time for memorisation of the maximum saturation temperature following compressor start-up

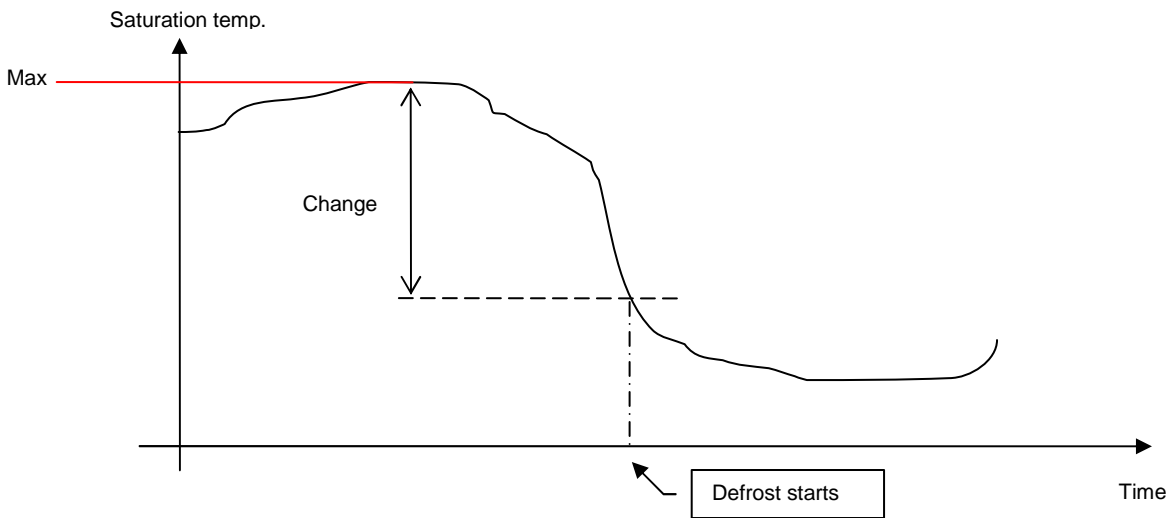

Figure 19: Change-Based Logic

## 2.9.2 Main Phase

During this phase the unit is controlled according to the normal defrost logic described above.

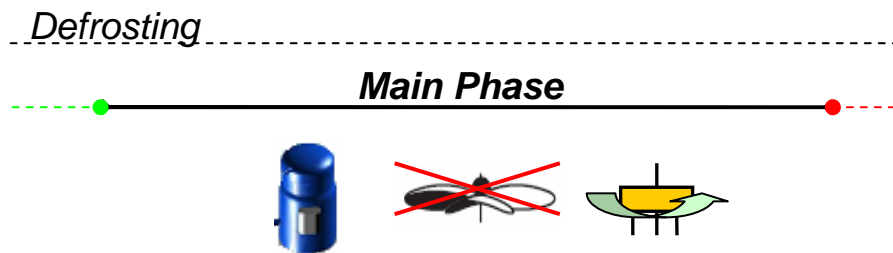

Figure 20: Defrosting - Main Phase

The causes that may bring this phase to an end are:

- **exceeding of the threshold:** the pressure rises above the stop defrost threshold, defined in the start defrost logic.
- **timeout:** the main phase has lasted beyond the maximum time set (*Manufacturer's menu* → *Parameters* → *Td*)

Whichever condition occurs first will cause the main defrosting phase to be terminated

## 2.9.3 Override phases

(*Manufacturer's menu* → *Parameters*)

The following override phases, which can be enabled separately, allow the user to configure custom settings for chiller operation at the beginning and end of the defrost logic.

### 2.9.3.1 Initial Override - Compressors OFF when defrosting begins

(*Manufacturer's menu* → *Parameters* → *Tg*)

This logic defines an interval of time that precedes the main phase and in which the compressors are shut down via the override function. The 4-way valve is switched into the same status as during normal heat pump operation until halfway through the interval.

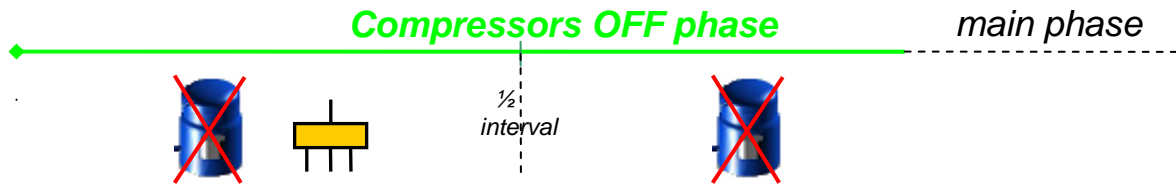

**Figure 21: Devices controlled by override in the case of “Compressors OFF when Defrosting Begins”**

**NB:** In the absence of an override the fans and valve maintain the status determined by the defrost logic

### 2.9.3.2 Final Override - Compressors OFF when defrosting ends

(Manufacturer's menu → Parameters → Th)

This logic defines an interval of time in which the compressors are shut down via the override function. The 4-way valve is switched into the same status as during heat pump operation in the second half of this interval.



**Figure 22: Devices controlled by override in the case of “Compressors OFF when Defrosting Ends”**

**NB:** In the absence of an override the fans and valve maintain the status determined by the defrost logic

### 2.9.3.3 Final Override - Post-Ventilation

(Manufacturer's menu → Parameters → Ti)

This logic defines an interval of time following the main phase in which fan operation and fan speed are controlled via the override function.



**Figure 23: Devices controlled by override in the case of “Post-Ventilation when Defrosting Ends”**

**NB:** In the absence of an override the compressors will remain on, maintaining the status determined by the defrost logic.

As noted previously, these logics can be activated independently of each other. In the event that both the “Post-Ventilation” and “Compressors OFF” options are selected for the Final Override phase, they will be activated simultaneously once the main phase has terminated. It is important not to set a longer Post-Ventilation than “Compressors OFF” time; otherwise, when the Compressors OFF time has elapsed, the reversing valve override will cease to have effect and the valve will go back into the standard defrost status during the remaining time while the fans are running.

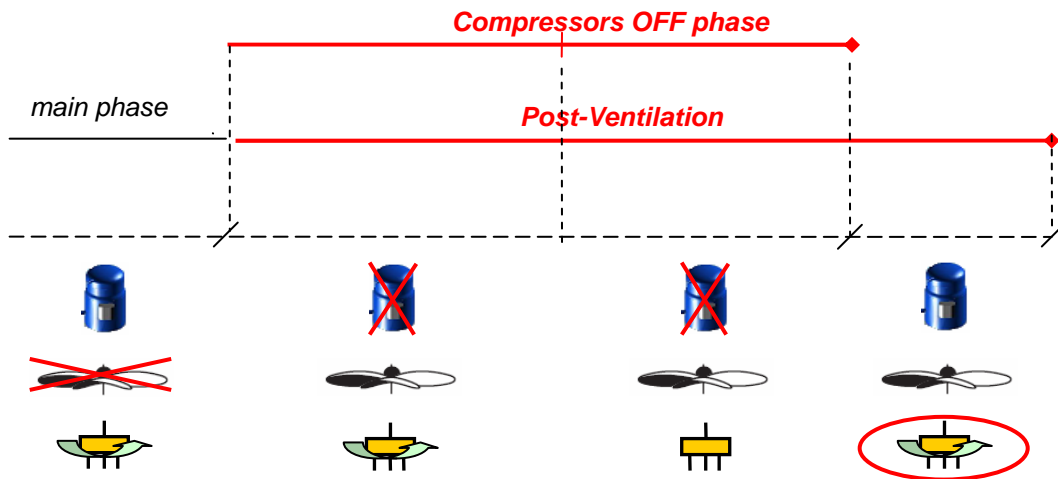

Figure 24: Logic resulting after overrides, WRONG config.

### Compressor restart times

A complete defrost cycle may entail several compressor restart phases (especially when the override controls are enabled) which cannot be managed according to normal compressor times. For this reason the possibility of defining a specific compressor start-up delay time has been introduced. (*Manufacturer's menu* → *Parameters* → *Tj*)

## 2.9.4 Defrost Management

(*Manufacturer's menu* → *Parameters* → *Td*)

In the case of a dual circuit unit, it is possible to use two different types of defrost cycles:

### 2.9.4.1 Simultaneous defrosting

It is sufficient for only one of the circuits to require defrosting: both will automatically start a defrost cycle; the first circuit to complete the main phase (either because the stop defrost threshold has been exceeded or due to a timeout) will stop and wait either to carry out any override phases together with the other circuit or resume heat pump operation.

### 2.9.4.2 Separate defrosting

With this logic each cooling circuit will go into a defrost cycle separately; the first circuit to carry out a defrost cycle will prevent the other circuit from doing so until it switches back into the heat pump mode; at this point the second circuit will be able to go into the defrost mode if the conditions thus require.

## 2.9.5 Manual Defrost Override

From the *Maintenance menu* → *Manual Control* → *M2* it is possible to start a defrost cycle via the override function; this override bypasses the minimum time set between two consecutive defrost cycles (set from *Manufacturer's menu* → *Parameters* → *Td*), and resets the time counter.

**NB:** the override will follow either the "Simultaneous" or "Separate" logic as configured for normal operation and will be utilisable only on the active circuit.

## 2.10 FREECOOLING

The freecooling function (a feature only of specific units) makes it possible to economise on the costs of cooling water supplied to users thanks to an outdoor air-cooled water heat exchanger; its advantages include:

- production of chilled water at no cost in wintertime;
- lower operating costs during in-between seasons;
- lower maintenance costs and less wear on the compressors.



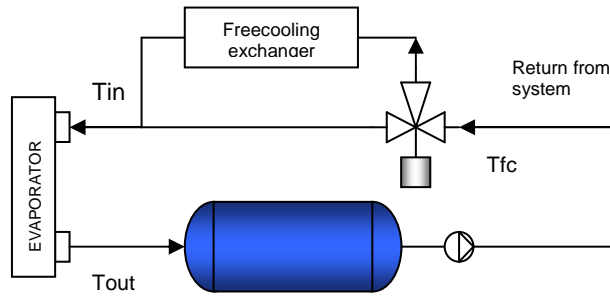

Figure 25: General Layout of a Freecooling Unit

### 2.10.1 Activation of Freecooling

Once the freecooling function has been enabled (*Manufacturer's menu* → *Parameters* → *Tk*), the logic will be activated, when the chiller is operating, if the following conditions hold true:

1) **Test on outdoor air** (*User menu* → *Setpoints and parameters* → *He*):

$$T_{fc} - T_{ext} > \Delta FC$$

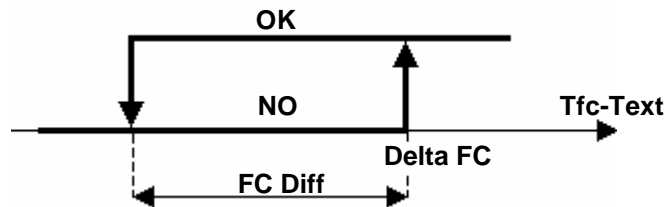

Figure 26

2) **Test on outlet water** (*Manufacturer's menu* → *Parameters* → *Tn*):

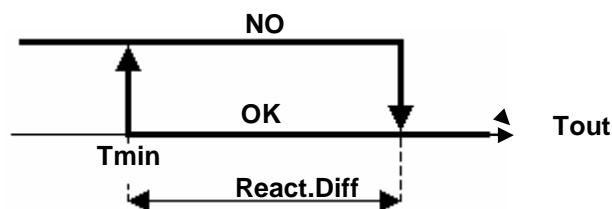

Figure 27

3) **None of the following alarms are active:**

- Thermal alarm condensation 1
- Thermal alarm condensation 2
- Flow alarm
- Antifreeze alarm evaporator 1
- Antifreeze alarm evaporator 2
- Pump thermal alarm
- Phase direction alarm

**NB:** Activating the Freecooling function will cause the compressors to shut down momentarily (for a period of time set from *Manufacturer's menu* → *Parameters* → *Tm*).

### 2.10.2 Fan speed in Freecooling mode

(*User menu* → *Setpoints and parameters* → *Hf-Hg*)

If the chiller is working exclusively in the freecooling mode, fan operation will be controlled according to the following logic:

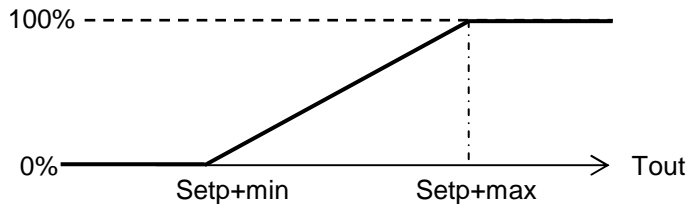

**Figure 28: Fan Ctrl - Freecooling**

where:

- "Setp" represents the active setpoint
- min: the sum of this parameter and the setpoint indicates determines the starting point of the fan modulation ramp
- max: the sum of this parameter and the setpoint indicates determines the end point of the fan modulation ramp

**NB:**

- min and max can be defined as negative values to control a modulation ramp that operates below the setpoint (the default values are in fact: min = -5°; max = -3°).
- fan control, expressed as a percentage, refers to the actual operating range, which will depend on the characteristics of the motor.

### 2.10.3 Combined operation: mechanical cooling + freecooling

If the freecooling function does not suffice on its own to achieve the desired water temperatures, the unit will go into a combined operating mode, where the mechanical cooling system will step in. Compressors will be switched on based on the inlet water temperature using proportional or proportional + integral control.

In units with two or more steps per circuit, during combined operation the steps will be disabled and the system will only operate at full capacity. In dual circuit units, the balanced start-up mode will also be disabled.

During combined operation the fan speed will again be controlled by the condensation logic.

### 2.10.4 Condensation coil capacity control

(*Manufacturer's menu* → *Parameters* → *Tq*)

In conditions of combined operation, in order to maintain the condensation temperature at a sufficient level ( $T_{cond} \geq 40\text{ °C}$ ), the heat exchange area is reduced by reducing the capacity of the condensation coils.

### 2.10.5 Capacity reducing override function

#### **Periodic Override**

Where enabled (*Manufacturer's menu* → *Parameters* → *Tt*), there are two override logics that periodically determine a reduction in coil capacity. The purpose of these logics is to restore the balance of oil within the cooling circuit.

- **Logic A** : (*Manufacturer's menu* → *Parameters* → *Tu*) if the compressors remain idle for a period longer than the set "Comp off T", when they start up again the solenoid valve will be kept open for a time equal to "Override T".
- **Logic B** : (*Manufacturer's menu* → *Parameters* → *Tv*) if the compressors continue to run while the freecooling logic is also enabled for a period longer than "Comp +FC on T", the solenoid valve will be kept open for a time equal to "Override T".

#### **High pressure prevention function**

(*Manufacturer's menu* → *Parameters* → *Tr*)

To prevent the triggering of a high pressure alarm, the capacity control function is deactivated when the condensation pressure reaches the setpoint value.

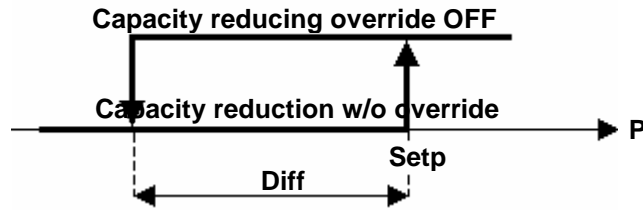
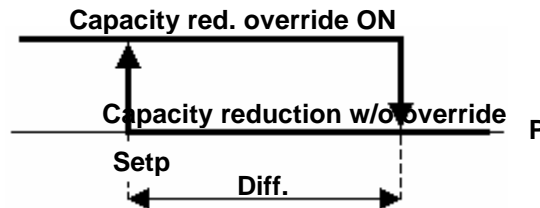

Figure 29

### Low pressure prevention function

((Manufacturer's menu → Parameters → Ts)

To prevent the triggering of a low pressure alarm, in the event that the freecooling mode is not active, the capacity control function is activated when the condensation pressure reaches the setpoint value.



In the case of a dual circuit, the higher of the pressures is considered

### 2.10.6 Freecooling warning

(Manufacturer's menu → Alarms → Um-Un)

The Freecooling warning function has been implemented to enable identification of a malfunctioning of the freecooling valve and is based on the reading of the temperature sensor and the freecooling logical status.

An alarm is signalled if any of the following conditions occur:

1. If FC = ON, a freecooling fault will be signalled if:

$$| T_{fc} - T_{in} | < \text{FaultDeltaON}$$

If the freecooling mode is enabled and the absolute value of the difference between  $T_{in}$  and  $T_{fc}$  is very small, the freecooling valve could be incorrectly blocked in the closed position and thus prevent the freecooling function from working.

2. If FC = OFF, a freecooling fault will be signalled if:

$$T_{in} - T_{fc} > \text{FaultDeltaOFF}$$

If the freecooling mode is disabled and the difference between  $T_{in}$  and  $T_{fc}$  is greater than  $\text{FaultDeltaOFF}$ , the freecooling valve could be incorrectly blocked in the open position and cause an increase in the temperature  $T_{in}$

**NB:** The freecooling warning will be disabled if the fan speed is lower than the minimum set for enabling the function itself (Manufacturer's menu → Alarms → Uo).

### 2.10.7 3-way valve maintenance function

The valve used to divert water into the freecooling coil is a sector-type valve and in order to ensure that it performs efficiently over time it must be put through an open-and-close cycle after a certain interval of time has elapsed without any switching operations. This time can be set from *Manufacturer's menu* → *Parameters* → *To-Tp*.

#### Note

During the override rotation phase, the freecooling fault alarm is inhibited.

## 3 ALARMS

### 3.1 ALARM MANAGEMENT

#### 3.1.1 Phase Direction Alarm

- Input: DIN 11
- Present: with pCO1 controller
- Active: always
- Effect: it stops the unit; the pump will shut down after a set delay time

##### Configuration

(*Manufacturer's menu* → *Alarms* → *Uk*)

- Enable: yes/no
- Delay time: *not provided*
- Reset: automatic/manual

#### 3.1.2 Sensor Alarms

Sensor alarms are triggered when the sensor reading is outside the range of values typical of normal operating conditions. The sensors, and the effects that will ensue in the event of an alarm, are:

- Inlet water temperature sensor: disables operation of all compressors
- Outlet water temperature sensor, evaporator 1 : disables the heating element as well as the compressors of circuit 1 and circuit 2 if a single evaporator is present.
- Outlet water temperature sensor, evaporator 2: disables the heating element and the compressors of circuit 2
- Pressure sensor, circuit 1 : causes the fans to switch on (it will not disable compressor operation but will terminate any defrost cycle underway)
- Pressure sensor, circuit 2 : causes the fans to switch on (it will not disable compressor operation but will terminate any defrost cycle underway)
- Outdoor Temperature Sensor: disables Freecooling, setpoint compensation and compressor inhibition based on outdoor temperature.
- Freecooling Temperature Sensor: disables the Freecooling mode
- Setpoint Adjustment Sensor: disables setpoint adjustment via analog input
- Water Temperature Sensor, Condenser 1 (W/W units): if there is only one condenser or if the other sensor has also signalled an alarm, it will inhibit operation of the heating element.
- Water Temperature Sensor, Condenser 2 (W/W units): if the sensor of the first condenser has likewise signalled an alarm, it will inhibit operation of the heating element.

From *Manufacturer's menu* → *Alarms* → *U1-U3* it is possible to enable the alarms of individual sensors and define a trip delay time.

#### 3.1.3 High Pressure Alarm from Digital Input

##### High Pressure Alarm circuit 1

- Input: DIN3 (pCO XS) / DIN1 (pCO1)
- Present: always
- Active: while unit is on
- Effect: stops the compressors of circuit 1

##### High Pressure Alarm circuit 2

- Input: DIN2 (pCO1)
- Present: with pCO1 controller
- Active: while unit is on
- Effect: stops the compressors of circuit 2

##### Configuration

(*Manufacturer's menu* → *Alarms* → *U9*)

- Enable: yes/no
- Reset: automatic/manual
- Delay: 0-999 s

### 3.1.4 Low Pressure Alarm from Digital Input

#### Low Pressure Alarm circuit 1

- Input: DIN4 (pCO XS) / DIN3 (pCO1)
- Present: always
- Active: while circuit 1 is operating
- Not Active: in heat pump mode (optional) and during a defrost cycle
- Effect: stops the compressors of circuit 1

#### Low Pressure Alarm circuit 2

- Input: DIN4 (pCO1)
- Present: with pCO1 controller
- Active: while circuit 2 is operating
- Not Active: in heat pump mode (optional) and during a defrost cycle
- Effect: stops the compressors of circuit 2

#### Configuration

(Manufacturer's menu → Alarms → Ua)

- Enable: yes/no
- Reset: automatic/manual
- Delay:
  - at compressor start-up
  - while compressors are running

As regards the low pressure alarm, if the automatic reset function is enabled you can select an option that switches the reset to manual if a second low pressure alarm occurs within a certain interval of time after the first one (Manufacturer's menu → Alarms → Uc).

### 3.1.5 High Pressure Alarm triggered by Sensor

#### High Pressure Alarm circuit 1

- Input: B1
- Present: always
- Active: while unit is on
- Effect: it stops the compressors of circuit 1

#### High Pressure Alarm circuit 2

- Input: B2 (pCO1)
- Present: with pCO1 controller
- Active: while unit is on
- Effect: it stops the compressors of circuit 2

#### Configuration

(Manufacturer's menu → Alarms → Ud)

- Enable: yes/no
- Reset: automatic/manual
- Delay: 1-999 s
- Setpoint [bars]
- Differential [bars]

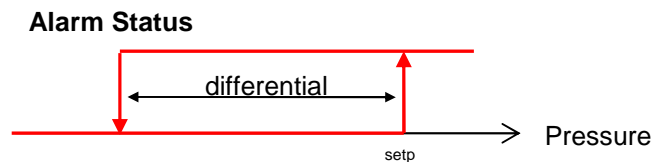

### 3.1.6 Compressor Thermal Alarm

#### Thermal Alarm Circuit 1

- Input: DIN5 (pCO1)
- Present: with pCO1 controller
- Active: while circuit 1 is operating
- Effect: stops the compressors of circuit 1

### Thermal Alarm Circuit 2

- Input: DIN6 (pCO1)
- Present: with pCO1 controller
- Active: while circuit 2 is operating
- Effect: stops the compressors of circuit 2

### Configuration

(Manufacturer's menu → Alarms → Uh)

- Enable: yes/no
- Reset: automatic/manual
- Delay:
  - at compressor start-up
  - while the compressors are running

## 3.1.7 Fan Thermal Alarm

### Fan Thermal Alarm 1

- Input: DIN10 (pCO1)
- Present: with pCO1 controller
- Active: when the fan digital output is active
- Effect: stops the compressors of circuit 1 and circuit 2 (if a single series of fans is present); stops the fans

### Fan Thermal Alarm 2

- Input: DIN14 (pCO1)
- Present: with pCO1 controller and configuration DIN14 for the alarm concerned  
(User menu → Setpoints and Parameters → H1)
- Active: when the fan digital output is active
- Effect: stops the compressors of circuit 2; stops the fans

### Configuration

(Manufacturer's menu → Alarms → Uj)

- Enable
- Reset: automatic/manual
- Delay: 0-999 s

## 3.1.8 Antifreeze Alarm

### Antifreeze Alarm, Evaporator 1

- Input: B4(pcoXS) / B5 (pco1)
- Present: always
- Active: while unit is on
- Effect: stops the compressors of circuit 1; stops the compressors of circuit 2 only if a single evaporator is present

### Antifreeze Alarm, Evaporator 2

- Input: B6 (pco1)
- Present: with pCO1 controller
- Active: while unit is on
- Effect: stops the compressors of circuit 2

### Configuration

(Manufacturer's menu → Alarms → Uj)

- Enable: yes/no
- Delay: 0-999s
- Reset: automatic/manual
- Setpoint [°C]
- Differential [°C]

### Alarm Status

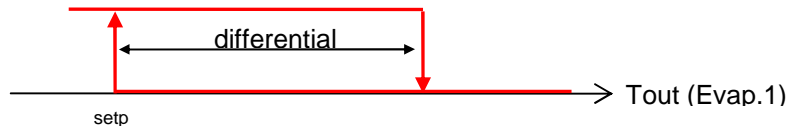

## 3.1.9 Pump Thermal Alarm

### Thermal Alarm, Pump 1

- Input: DIN7 (pCO1)
- Present: with pCO1 controller
- Active: while unit is on
- Effect: stops pump 1; if only one pump is installed or a second pump is in an alarm status, it stops the compressors

### Thermal Alarm, Pump 2

- Input: DIN8 (pCO1)
- Present: with pCO1 controller
- Active: while unit is on
- Effect: stops pump 2; if the first pump is also in an alarm status, it stops the compressors

### Configuration

*(Manufacturer's menu → Alarms → U6)*

- Enable: yes/no
- Delay: 0-999s
- Reset: automatic/manual

## 3.1.10 Water Flow Alarm

- Input: DIN2(pCOXS) / DIN9 (pCO 1)
- Present: always
- Active: while unit is on
- Effect: stops all the compressors; the pump will shut down after a set delay time

### Configuration

*(Manufacturer's menu → Alarms → U7)*

- Enable: yes/no
- Delay:
  - at compressor start-up
  - while compressors are running
- Reset: automatic/manual

## 3.1.11 Alarm from Digital Input

- Input: DIN6(pCOXS) / DIN14 (pCO 1)
- Present: configuration DIN6 or DIN14 (based on the controller installed) as alarm signalled via digital input  
*(User menu → Setpoint and Parameters → H1-H2)*
- Active: while unit is on
- Effect: stops the unit; the pump will shut down after a set delay time

### Configuration

*(User menu → Setpoints and parameters → U1-H2)*

- Enable: yes/no
- Delay: 0-999s
- Reset: automatic/manual

## 3.1.12 Maintenance Alarms

A time counter keeps track of the running hours of the devices installed in the chiller, namely:

- Pumps *(Maintenance menu → Running hours → Pd-Pe)*
- Compressors *(Maintenance menu → Running hours → P3-P10)*

If the maintenance alarms are enabled *(Maintenance menu → Running hours → P1,Pb)*, it will be necessary to configure operating thresholds above which the alarm concerned will be triggered.

This time counter can then be reset in order to deactivate the corresponding alarm *(Maintenance menu → Running hours → P3-P10,Pd-Pe)*.

### 3.1.13 Clock Card Alarm

(Manufacturer's menu → Alarms → U5)

The alarm generated by the clock card inhibits unit On/Off switching and setpoint adjustments based on time zones.

### 3.1.14 Digital Alarm Output

From the *User menu* → *Alarms* → *K1* it is possible to configure the digital output dedicated to the signalling of alarms (NO5: pCOXS; NO8: pCO1) based on the use logic

- N.O. : normally open
- N.C. : normally closed

and the type of alarms present. Specifically, it is possible to choose whether to be alerted of the occurrence of:

- SERIOUS Alarms
- NON-SERIOUS Alarms
- ALL Alarms

Whereas in the latter case the output will be activated upon the occurrence of any alarm whatsoever, including those serving solely as warnings, the other two options are configurable. Based on the level (Serious or Non-Serious) that the user assigns to individual alarms, the output will signal the occurrence of any of them.

Shown below is one of the configuration screens (*User* → *Alarms* → *K2-K3*) in which each alarm is represented by its corresponding code (see Table of Alarm Codes and Descriptions).

```

t_user_all_02
+-----+
| ALARMS                               K2 |
| CONFIGURATION                         |
| S=Serious N=Not serious              |
| A01-A10: NNNNN NNNNN                 |
| A11-A20: NNNNN NNNNN                 |
| A21-A30: NNNNN NNNNN                 |
| A31-A40: NNNNN NNNNN                 |
| A41-A50: NNNNN NNNNN                 |
+-----+

```

A14: Low Press. Alarm -  
Circuit 2

Based on this division it can also be decided which alarms (the ones defined as serious) will disengage the unit from any active LAN logic (see section on LAN) and bring it back into a stand-alone mode.

## 3.2 ALARM HISTORY

The system features a history function, accessible from *Maintenance menu* → *History* → *R1*, which keeps track of the alarms occurring in the chiller.

If a clock card has been installed, the time and date will be memorised along with the alarm code and position in the database.

```

history_alarms
+-----+
| Alarm History #030                    |
| AL: 015                               |
| High pres. circ. 1                    |
| 12:23 03/02/07                       |
+-----+

```

Time ←

Alarm index in list  
Alarm Code  
Alarm Description  
Date

A maximum of 100 alarms can be memorised; once this limit is reached, the alarms of oldest date will be progressively erased.

Erasure is always possible from *Maintenance menu* → *History* → *R2*.

**Table of Alarm Codes and Descriptions**

ALARM CODE	DESCRIPTION	DEFAULT
AL: 001	Alarm from Digital Input	G
AL: 002	Thermal Alarm Pump 1	G
AL: 003	Thermal Alarm Pump 2	G
AL: 004	Evaporator Water Flow Alarm	G
AL: 005	Inlet Temp. Sensor Alarm	G
AL: 006	Outlet Water Temp. Sensor Alarm - Evaporator 1	G
AL: 007	Outlet Water Temp. Sensor Alarm - Evaporator 2	G
AL: 008	Press. Sensor Alarm – Circuit 1	G



AL: 009	Press. Sensor Alarm – Circuit 2	G
AL: 010	Freecooling Temp. Sensor Alarm	G
AL: 011	Setpoint Adjustment Sensor Alarm	N
AL: 012	Outdoor Temp. Sensor Alarm	N1
AL: 013	Low Pressure Alarm - Circuit 1	G
AL: 014	Low Pressure Alarm - Circuit 2	G
AL: 015	High Pressure Alarm - Circuit 1	G
AL: 016	High Pressure Alarm - Circuit 2	G
AL: 017	Low Press. Alarm from Sensor – Circuit 1	G
AL: 018	Low Press. Alarm from Sensor – Circuit 2	G
AL: 019	High Press. Alarm from Sensor – Circuit 1	G
AL: 020	High Press. Alarm from Sensor – Circuit 2	G
AL: 021	Compressor Thermal Alarm - Circuit1	G
AL: 022	Compressor Thermal Alarm - Circuit2	G
AL: 023	Fan Thermal Alarm – Series 1	G
AL: 024	Fan Thermal Alarm – Series 2	G
AL: 025	Maintenance Threshold Exceeded - Pump 1	N1
AL: 026	Maintenance Threshold Exceeded - Pump 2	N1
AL: 027	Phase Direction Alarm	G
AL: 028	Antifreeze Alarm – Evaporator 1	G
AL: 029	Antifreeze Alarm – Evaporator 2	G
AL: 030	Maintenance Threshold Exceeded Compr.1	N1
AL: 031	Maintenance Threshold Exceeded Compr.2	N1
AL: 032	Maintenance Threshold Exceeded Compr.3	N1
AL: 033	Maintenance Threshold Exceeded Compr.4	N1
AL: 034	Maintenance Threshold Exceeded Compr.5	N1
AL: 035	Maintenance Threshold Exceeded Compr.6	N1
AL: 036	Maintenance Threshold Exceeded Compr.7	N1
AL: 037	Maintenance Threshold Exceeded Compr.8	N1
AL: 038	Clock Malfunction	N1
AL: 039	Freecooling Fault	N1
AL: 040	--	
AL: 041	EPROM Error Drv1	G
AL: 042	EPROM Error Drv2	G
AL: 043	Motor Error EEV1	G
AL: 044	Motor Error EEV2	G
AL: 045	Timeout MOP Drv1	N1
AL: 046	Timeout MOP Drv2	N1
AL: 047	Timeout LOP Drv1	N1
AL: 048	Timeout LOP Drv2	N1
AL: 049	Low SuperHeat Drv1	N1
AL: 050	Low SuperHeat Drv2	N1
AL: 051	Valve not closed during power OFF Drv1	N1
AL: 052	Valve not closed during power OFF Drv2	N1
AL: 053	High SuperHeat Drv1	N1
AL: 054	High SuperHeat Drv2	N1
AL: 055	Error sensor S1 – Drv1	G
AL: 056	Error sensor S1 – Drv2	G
AL: 057	Error sensor S2 – Drv1	G
AL: 058	Error sensor S2 – Drv2	G
AL: 059	Error sensor S3 – Drv1	G
AL: 060	Error sensor S3 – Drv2	G
AL: 061	GoAhead Required Drv1	N1
AL: 062	GoAhead Required Drv2	N1
AL: 063	LAN disconnected Drv1	N1
AL: 064	LAN disconnected Drv2	N1
AL: 065	Autosetup Procedure not completed Drv1	N1
AL: 066	Autosetup Procedure not completed Drv2	N1
AL: 067	Outlet Water Temp. Sensor Alarm - Condenser 1	G
AL: 068	Outlet Water Temp. Sensor Alarm - Condenser 2	G





## 4 USER INTERFACE

The user interface adopted, PGD1, comprises an LCD display (8 rows x 22 columns) and 6 keys. From here the user can carry out all program-related operations, view the status of the unit at all times and edit parameters.



### 4.1 DESCRIPTION OF KEYBOARD

The 6 keys and their respective functions are described in the table below.

	Key	Description
	ALARM	Press the ALARM key to reset alarms. When there is an alarm, it will light up.
<b>Prg</b>	PROGRAM	Press PRG to access the main menu.
<b>Esc</b>	ESC	Press ESC to move up to a higher level in the menu.
	UP	Press UP to go to the next screen or increase the value of a parameter..
	ENTER	Press ENTER to go into the fields of parameters to be edited and to confirm changes.
	DOWN	Press DOWN to go to the previous screen or decrease the value of a parameter.

### 4.2 SWITCHING ON THE UNIT AND SELECTING THE OPERATING MODE

The steps necessary for switching on the unit (and selecting the mode) are the following:

- press **Esc** to go to the main screen

```

main
+-----+
|U1      08:00 01/01/00|
| IN   12.0°C |
| OUT  12.5°C |
|                |
| OFF by keyboard |
+-----+
  
```

- keep the  key pressed down for at least 3 seconds. The following screen will appear:

```

on_unit
+-----+
|                |
| Switch On unit |
| ->cooling      |
| PRG : Confirm  |
| ESC : Cancel   |
|                |
+-----+
  
```

- if the chiller is a Heat Pump model you can move the cursor to the operating mode by pressing  and, using the arrows, select between “cooling” and “heating”.
- Press **Prg** to confirm unit ON in the selected mode or **Esc** to cancel the operation. Once you have made the selection, the display will return to the main screen.

### 4.3 SWITCHING OFF OF THE UNIT

The steps necessary for switching off the unit are the following:

- press **Esc** to go to the main screen

```
main
+-----+
|U1      08:00 01/01/00|
|IN      12.0°C|
|OUT     12.5°C|
|*ON|
+-----+
```

- keep the  key pressed down for at least 3 seconds. The following screen will appear:

```
off_unit
+-----+
|          Switch Off unit ?          |
|PRG : Confirm|
|ESC : Cancel |
+-----+
```

Press **Prg** to confirm unit OFF or **Esc** to cancel the operation. Once you have made the selection, the display will return to the main screen.

### 4.4 GENERAL DESCRIPTION OF MENUS

The **Esc** key can be used as needed to exit submenus and also permits the user to view the main information concerning chiller operation. From the main screen:

```
main
+-----+
|U1      08:00 01/01/00|
|IN      12.0°C|
|OUT     12.5°C|
|*ON|
+-----+
```

press **Prg** to view the menu; using the arrow keys select the submenu concerned and press  to enter it. Below is a list of the items included in the main menu and the type of parameters contained in each.

#### Chiller Status

This menu provides general information regarding the status of the unit and its main components. It is in turn divided into 3 submenu items:

- Devices: status of compressors, heating element, fans, pumps
- Electronic valve: status of the electronic valves and reading of sensors
- LAN: indication of any units connected to the LAN

#### Inputs/Outputs Menu

From this menu it is possible to view, and if necessary override, the status of all controller inputs and outputs. The submenu items are:

- I/O status: the statuses of the analog and digital inputs and analog and digital outputs are displayed in order.
- I/O override: if enabled from the maintenance menu, all inputs and outputs read and governed by the pCO can be manually controlled.

#### Setpoint Menu

Management of fixed setpoint and variable setpoint.

#### User Menu

From this menu, password protected (100), it is possible to configure the main chiller control logics. This menu is in turn divided into:

- Setpoints and Parameters: control logic, setpoint management, compressor rotation and any configurable digital inputs.

- LAN and Supervision : enabling of On/Off logics and summer/winter changeovers; LAN logic and selection of parameters for serial communication
- Alarms: configuration of the digital alarm output and definition of serious alarms
- Clock: clock setting and programming of unit ON/OFF time zones (only where a clock card is installed)

### Maintenance Menu

Password protected (*password not provided*), this menu is divided into:

- Manual Control: enabling of manual override of the microcontroller inputs and outputs (managed thereafter from the I/O menu)
- Parameters: sensor offset and password change
- Running hours: run time of the main chiller devices and management of the related alarms
- History: list of past alarms and erasure of history

### Manufacturer's Menu

Password protected (*password not provided*), this menu is divided into:

- Unit Configuration: parameters that define the type of unit and the devices making it up
- Parameters: setting of essential operating parameters (condensation control, defrost function...)
- Alarms: configuration of alarms
- Carel EXV Drivers: settings of drivers for the control of electronic valves
- Initialisation and password: restoring of default parameters and password definition

### Info Menu

It contains the version, code and date of the software used; from here you can also set the display language

### Password

As indicated above, the User, Maintenance and Manufacturer's menus require entry of a password in order to gain access; it was decided to give only the User password in this manual. Entry of the password enables access at the level concerned for a certain amount of time, so that it will not be necessary to re-enter the password until this time elapses; the password also provides access to lower level menus, according to priority as shown below:

1. Manufacturer's Menu
2. Maintenance Menu
3. User Menu

The passwords can subsequently be changed respectively from:

1. Manufacturer's menu → Initialisation and Password → W2
2. Maintenance menu → Parameters → N5
3. User menu → Setpoints and parameters → Hi

The duration of access is a single parameter which, for the sake of convenience, has been included in all three of the screens indicated above. If this value is changed from one screen, the change will automatically be shown in the others as well.

## 4.5 USER INTERFACE CONNECTION

### 4.5.1 Physical connection

#### Local display

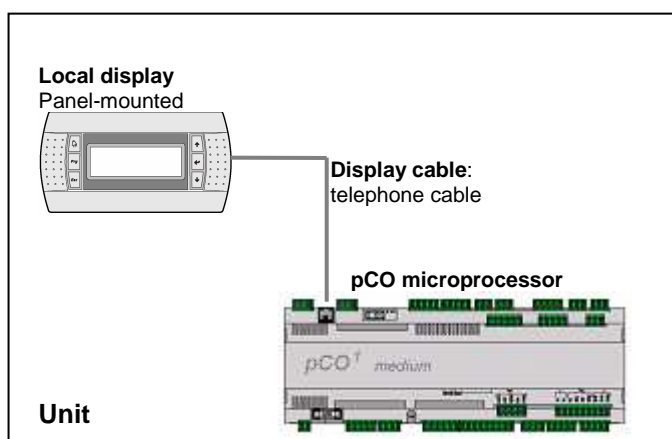

- a telephone cable (for the connection between pCO and Local Display)

### 4.5.1.1 Local and remote display (within 50m)

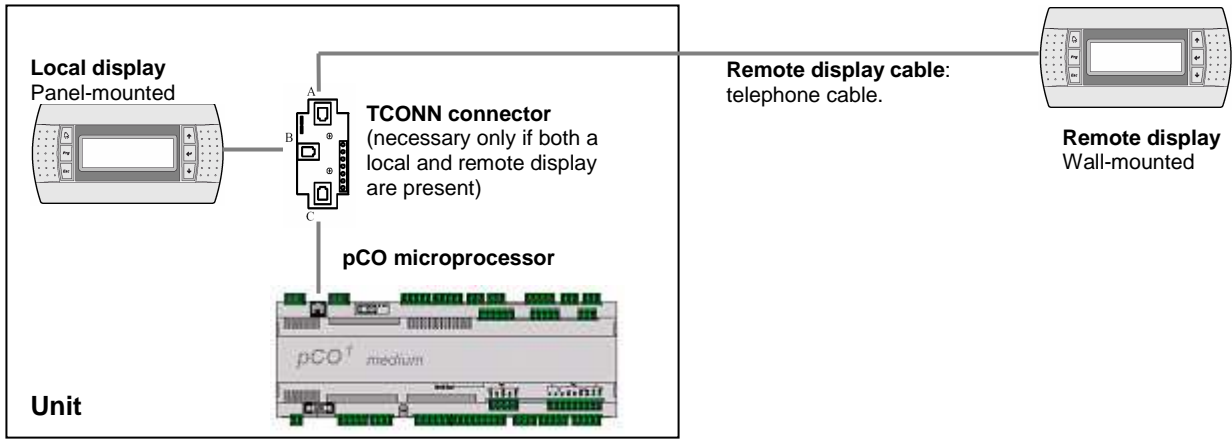

- 1 T-connector (TCOONN6 with jumpers J14 and J15 in position 1-2)
- 3 telephone cables (for the connections between pCO1-T-connector; T-connector-Local Display; T-connector-Remote Display)

### 4.5.1.2 Local and remote remote display (over 50m)

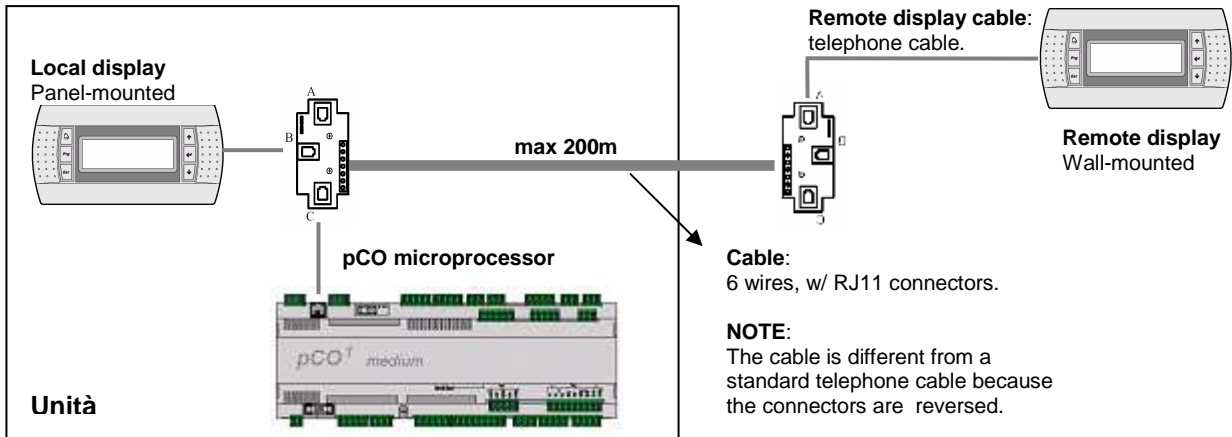

- 2 T-connectors (TCOONN6 with jumpers J14 and J15 in position 1-2)
- 3 telephone cables (for the connections between pCO1-T-connector; T-connector-Local Display; T-connector-Remote Display)
- Shielded 3 twisted pair cable ( to connect the two T-connectors)

## 4.5.2 Software configuration

In order for the local display terminal and, where present, the remote display terminal to work correctly, the addresses must be set as shown in the table:

	List of Addresses	
	pCO address	Display Address
Unit	1	25
Remote Display	-	32

For the configuration procedure, see section 10.2

## 5 ADDRESS SETTINGS

### 5.1 SETTING THE DISPLAY ADDRESS

To set the address of the display terminal, carry out the following steps:

- Press the Up, Enter and Down keys together until the following screen appears:

```

+-----+
| Display address |
| setting.....:00 |
+-----+

```

- Press UP or DOWN to set the address
- Press ENTER to save and exit the procedure

## 5.2 SETTING THE PCO ADDRESS (PCOXS OR PCO1)

To set the address of the pCO controller, carry out the following steps:

- To the pCO1 connect a display terminal with an address configured as 0
- Switch on the pCO1 controller, simultaneously pressing the ALARM and UP keys on the terminal until the following screen appears

```

+-----+
| pLan address:   0 |
| UP:   increase |
| DOWN: decrease  |
| ENTER: save & exit |
+-----+

```

- Press UP or DOWN to set the address according to the table above
- Press ENTER to save and exit the procedure

## 5.3 MICROPROCESSOR/DISPLAY CONFIGURATION

Once the display and pCO addresses have been set (values indicated in the tables provided), if the display does not show anything it means that the pCO controller needs to be set so that it can communicate with the display terminal. Follow the procedure indicated below.

- Press UP + ENTER + DOWN together for 5 seconds; the following screen will appear:

```

+-----+
| Display address |
| setting.....:25 |
| I/O Board address:-- |
+-----+

```

- Press ENTER to move to the field at the bottom and use the arrows to select the address of the pCO controller connected to the display
- Press ENTER to confirm; the following screen will appear:

```

+-----+
| Terminal config |
| Press ENTER    |
| to continue     |
+-----+

```

- Press ENTER; the following screen will appear:

Microprocessor address	Adr	Priv/Shared	Display mode:
P:01	25	Pr	Pr = Private, Sh = Shared
Trm1	32	Sh	
Trm2	None	--	
Trm3			

Change from "No" to "Yes" to confirm changes

From this screen you must set the address and operating mode of the display (terminal) connected to the microprocessor. Note that up to 3 displays (terminals Trm1-2-3) can be connected to a pCO. Press ENTER to move the cursor into the fields and UP and DOWN to change the value of the terminals concerned, so that they match those of the connected displays

The display mode can be:

- Private : if the display terminal is defined as private, it can communicate with only one microprocessor.
- Shared : if the display terminal is shared (in the case of units connected in a LAN), it can communicate with a number of microprocessors; in this case you can switch from one to another by keeping the ESC key pressed and repeatedly pressing the DOWN key.

- To confirm the changes, change the parameter near "Ok?" to YES.

## 6 SCREENS

The main information screens of the application, divided into the different menus, are shown below. Appearing in the top right-hand corner is a code identifying the individual screen (except the Main menu screens).





### 6.1 MAIN

main

```

+-----+
|U1      08:00 01/01/00|
|IN      12.0°C|
|OUT     12.5°C|
|
| OFF
+-----+
  
```

Main screen that shows the inlet water temperature, outlet water temperature (average in units with 2 evaporators), unit status and any active components (indicated by means of icons).

-  pump 1      -  pump 2
-  compressors (with an indication of how many are running)
-  fans
-  heating elements

main\_2

```

+-----+
|          CIRCUIT 1          |
|
| Water IN  : 00.0°C
| Water OUT : 00.0°C
| Cond.press: 00.0 bar
| Cond.temp : 00.0°C
+-----+
  
```

Main readings relative to circuit 1:

- Inlet water temperature
- Outlet water temperature
- Condensation Pressure (or Evaporation in heat pump models)
- Equivalent temperature (dewpoint)

main\_2b

```

+-----+
|          CIRCUIT 1          |
|
| Water IN  : 00.0°C
| Water OUT : 00.0°C
| Cond.temp : 00.0°C
+-----+
  
```

Main readings relative to circuit 1 (in the case of water/water units):

- Inlet water temperature
- Outlet water temperature
- Condenser Temperature

main\_3

```

+-----+
|          CIRCUIT 2          |
|
| Water IN  : 00.0°C
| Water OUT : 00.0°C
| Cond.press: 00.0 bar
| Cond.temp : 00.0°C
+-----+
  
```

Main readings relative to circuit 2

main\_4

```

+-----+
|          DEFROST           |
|
| Circuit 1: no
| Circuit 2: no
+-----+
  
```

( in the case of Heat Pump units)

Indication of whether the circuit is undergoing a defrost cycle

main\_5

```

+-----+
|          FREECOOLING       |
| Ext.Temp  : 00.0°C
| Status    : off
| Coil partial.: no
|
| 3 ways valve: closed
+-----+
  
```

(in the case of Freecooling units)

- Outdoor Temperature
- Freecooling Status
- Coil capacity control
- 3-way valve

### 6.2 CHILLER STATUS

#### 6.2.1 Chiller Status – Devices

```

t_sm_disp_01
+-----+
COMPRESSORS      A1
C1:off  C4:off  C8:--
C2:off  C5:--  C7:--
C3:off  C6:--

Prev.HP on circ1: -
Prev.HP on circ2: -
+-----+

```

#### Compressor status.

Indication of whether high pressure prevention function is active in the circuit

```

t_sm_disp_02
+-----+
PUMPS            A2

Pump 1: off
Pump 2: off
+-----+

```

#### Pump status

```

t_sm_disp_03
+-----+
HEATERS          A3

Heater : off
+-----+

```

#### Antifreeze heating element output status

```

t_sm_disp_04
+-----+
FANS              A4

Fans 1: off 000.0%
Fans 2: off 000.0%
+-----+

```

#### Fan status and percentage of operating capacity used, where applicable

```

t_sm_disp_05
+-----+
4 WAYS VALVE     A5

Valve C1->Not Excited
Valve C2->Not Excited
+-----+

```

( in the case of Heat Pump units)

#### 4-way valve status

**NB:** 4-way valve logic config. in *Manufacturer's menu* → *Parameters* → *Tc*

```

t_sm_disp_06
+-----+
3 WAYS VALVE     A6

->closed
+-----+

```

(in the case of Freecooling units)

#### 3-way valve status

```

t_sm_disp_07
+-----+
COIL PARTIAL.   A7
SOLENOID

->not active
+-----+

```

(in the case of Freecooling units)

#### Status of capacity control solenoid valve

```

t_sm_disp_08
+-----+
EXTERN MODEM     A8

Status:
Modem on stand-by.
Dialled Number:0
+-----+

```

(in the case of GSM supervision protocol)

#### Modem status



## 6.2.2 Chiller Status - Valve

d\_inout1\_d1

```
+-----+
| DRIVER 1          B1 |
| Gas               : --- |
| Mode              : Cool |
| EEV               : AUTO |
| Valve position:0000 |
| Power request: 000% |
+-----+
```

Electronic Valve Status

d\_inout2\_d1

```
+-----+
| DRIVER 1          B2 |
| SuperHeat       : 000.0°C |
| Suction T.     : 000.0°C |
| Evap.temp.     : 000.0°C |
| Evap.press.   : 00.0barg |
| Cond.temp.    : 000.0°C |
+-----+
```

d\_inout4\_d1

```
+-----+
| DRIVER 1          B3 |
| PROTECTION      |
| LowSH:No  HtCond:No |
| LOP: No  MOP: No |
+-----+
```

d\_io\_drv\_vers

```
+-----+
| DRIVERS          B7 |
| Drv1 Version 000 000 |
| Drv2 Version 000 000 |
+-----+
```

Electronic valve driver versions

## 6.2.3 Chiller Status – LAN

t\_sm\_lan\_01

```
+-----+
| pLAN             C1 |
| Unit 1:On Line Alone |
| Unit 2:Off Line |
| Unit 3:Off Line |
| Unit 4:Off Line |
+-----+
```

Indication of which units are physically connected to pLAN

- On Line : connected
  - Off Line : disconnected
- Indication of enabled LAN logic, where applicable
- (Stand) Alone: LAN logic not active
  - Master : LAN logic active in unit 1
  - Slave : LAN logic active in a unit other than number 1

t\_sm\_lan\_02

```
+-----+
| Reference T.IN   C2 |
| for control logic |
|                 00.0°C |
+-----+
```

Inlet water temperature used by the Master unit for the purpose of the control logic. If the Master unit pump is off, this value will be the average of the other units connected.

t\_sm\_lan\_03

```
+-----+
| Running mode    C3 |
| active for LAN |
| - Cooling |
+-----+
```

If the Master unit is off it indicates the active operating mode, in which the slave units will start up

## 6.3 INPUTS/OUTPUTS MENU

### 6.3.1 Inputs/Outputs Menu - I/O Status

```
t_io_stato_01
+-----+
ANALOG INPUTS      D1
B1: 00.0bar
B2: 00.0°C
B3: 00.0°C
B4: 00.0°C
+-----+
```

It displays the status of the analog inputs (value resulting from an override, where present)

### 6.3.2 Inputs/Outputs Menu - I/O Override

```
t_io_forz_01
+-----+
ANALOG INPUTS      E1
Override
B1: AUTO 00.0bar
B2: AUTO 00.0°C
B3: AUTO 00.0°C
B4: AUTO 00.0°C
+-----+
```

Indication of the value assigned to the analog input and the value applied in the case of an override

- AUTO : analog input not overridden
- MAN : analog input overridden with the value on the right

```
t_io_forz_99
+-----+
Override
Not Enabled
+-----+
```

If the override function has not been enabled from the *Maintenance menu* → *Manual Control*→*M1*, this screen will be displayed

## 6.4 SETPOINT MENU

```
t_setpoint_1
+-----+
Active              F1
Setpoint : 00.0°C
- secondary : -
- time zones : -
- remote adjust : -
- compensation : -
- bounded : -
+-----+
```

Active setpoint used by the control logic and any setpoint adjustment logics that may be active

## 6.5 MAINTENANCE MENU

### 6.5.1 Running hours

```
m_mant_oref_3
+-----+
Running hours      P3
Compressor 1

Hours: 000000
Reset: no
+-----+
```

Running hours of compressor 1, may be reset

```
m_mant_oref_13
+-----+
Running hours      Pd
Pump 1

Hours: 000000 h
Reset: no
+-----+
```

Running hours of pump 1, may be reset

### 6.5.2 History

```
m_mant_sto_01
+-----+
R1

Press ALARM
to view the
Alarm History
+-----+
```

From this screen, pressing the ALARM key will call up the alarm history; while pressing the arrow will take you to the next screen of this menu

m\_mant\_sto\_02

```
+-----+
|                                             |
|                                             |
| Erase history                               | R2 |
| database? no                               |
|                                             |
|                                             |
+-----+
```

## 6.6 MANUFACTURER'S MENU

### 6.6.1 Initialisation and password

m\_cost\_iniz\_01

```
+-----+
|                                             |
|                                             |
| Reset all the                               | W1 |
| parameters to the                           |
| default values? no                          |
|                                             |
|                                             |
+-----+
```

Screen for restoring the default parameters (indicated in this manual in section 7)

## 6.7 INFO MENU

t\_info\_1

```
+-----+
| - INFO -                                   | X1 |
| V: ChillerScroll 1.00                     |
| C: 000001                                 |
| D: 05/2007                                 |
|                                             |
| Language: German                           |
|                                             |
+-----+
```

- Software version installed
- Code of the installed software
- Date of the installed software
- Language selection

t\_info\_2

```
+-----+
| CONFIGURATION                               | X2 |
| WORD                                         |
|                                             |
| 00000-00000                                 |
|                                             |
+-----+
```

Parameter resulting from the combination of the main parameters set in the software application.

## 7 APPLICATION SETTING PARAMETERS

### 7.1 SETPOINT MENU

Screen	Par.	Description	Default	Range	UOM
		<b>Setpoint</b>			
F2	1	Cooling Setpoint	12.0	H7(1) / H7(2)	°C
	2	Heating Setpoint	40.0	H8(1) / H8(2)	°C
F3	1	Secondary Cooling Setpoint	12.0	H7(1) / H7(2)	°C
	2	Secondary Heating Setpoint	40.0	H8(1) / H8(2)	°C
F4	1	Setpoint Inside Time zone	12.0	H7(1) / H7(2)	°C
	2	Setpoint Outside Time zone	12.0	H7(1) / H7(2)	°C
F5	1	Setpoint Inside Time zone- Cooling	12.0	H7(1) / H7(2)	°C
	2	Setpoint Outside Time zone - Cooling	12.0	H7(1) / H7(2)	°C
F6	1	Setpoint Inside Time zone - Heating	40.0	H8(1) / H8(2)	°C
	2	Setpoint Outside Time zone - Heating	40.0	H8(1) / H8(2)	°C
F7	1	Start of time zone - hour (Monday)	7	0 / 23	h
	2	Start of time zone - minutes (Monday)	00	0 / 59	min.
	3	End of time zone - hour (Monday)	22	0 / 23	h
	4	End of time zone - minutes (Monday)	00	0 / 59	min.
	..	the same applies for the other days			
F9	1	Enabling of setpoint adjustment via analog input	0	0/1	
	2	Adjustment with min. value of analog input	-5.0	-99.9 / 99.9	°C
	3	Adjustment with max. value of analog input	5.0	-99.9 / 99.9	°C
Fa	1	Compensation Setpoint - Cooling	30.0	-99.9 / 99.9	°C
	2	Compensation Differential - Cooling	3.0	-10.0 / 10.0	°C
	3	Maximum Compensation - Cooling	2.0	-10.0 / 10.0	°C
Fb	1	Compensation Setpoint - Heating	0	-99.9 / 99.9	°C
	2	Compensation Differential - Heating	-3.0	-10.0 / 10.0	°C
	3	Maximum Compensation - Heating	0	-10.0 / 10.0	°C

### 7.2 USER MENU

#### 7.2.1 User - Setpoints and Parameters

Screen	Par.	Description	Default	Range	UOM
		<b>User</b>			
H1	1	DIN 14 Configuration	not present	not present/ serious alarm/ secondary setpoint/ fan 2nd series	
	2	Reset serious alarm from DIin	auto	auto / man	
H2	1	DIN 6 Configuration	not present	not present/ serious alarm/ secondary setpoint	
	2	Reset serious alarm from DIin	auto	auto / man	
H3	1	Type of control	proportional	proportional / prop.+int.	
	2	Integral Time	600	0 / 9999	s
	3	Percentage of Hysteresis	100	0 / 100	%
H4	1	Automatic Setpoint Adjustment	none	none / by time zones / via digital input	
H5	1	Setpoint compensation in cooling mode	no	no / yes	
	2	Setpoint compensation in heating mode	no	no / yes	
H6	1	Enable dehumidification setpoint	no	no / yes	
H7	1	Cooling setpoint lower limit	8	-99.9 / 99.9	°C
	2	Cooling setpoint upper limit	16	-99.9 / 99.9	°C
H8	1	Heating setpoint lower limit	30	-99.9 / 99.9	°C
	2	Heating setpoint upper limit	50	-99.9 / 99.9	°C
H9	1	Setpoint Differential in cooling mode	4	0.0 / 10.0	°C
	2	Setpoint Differential in heating mode	4	0.0 / 10.0	°C
Ha	1	Pump Rotation	auto	man / auto	
	2	Rotation Period	6	0 / 999	h9
	3	Pump Sequence	pump 1	pump 1/ pump 2	
Hb	1	Compressor Rotation	FIFO	LIFO / FIFO	
	2	Circuit Rotation	balanced	non-bal. / balanced	
He	1	Freecooling Enabling Delta	3	2.0 / 9.9	°C
	2	Freecooling Enabling Differential	2	1.0 / 3.0	°C
Hf	1	Type of fan control in FC	proportional	proportional / prop.+int.	
	2	Integral Time	600	0 / 9999	s
Hg	1	Deviation from setpoint for min. fan speed in FC	-5	-8.0 / Hg(2)	°C
	2	Deviation from setpoint for max. fan speed in FC	-3	Hg(1) / 2.0	°C

Hh	1	Cooling icon configuration	snowflake	snowflake / sun	
Hi	1	User Password	100	0 / 9999	
	2	Duration of Login w/ Password	5	0 / 480	

## 7.2.2 User - LAN and Supervision

Screen	Par.	Description	Default	Range	UOM
		<b>User</b>			
J1	1	Enable On/Off from keyboard	yes	no / yes	
	2	Enable On/Off by remote contact	yes	no / yes	
	3	Enable On/Off via supervisor	no	no / yes	
	4	Enable On/Off by time zones	no	no / yes	
J2	1	Enable summer/winter changeover via remote contact	yes	no / yes	
	2	Enable summer/winter changeover via supervisor	no	no / yes	
J3	1	Enable LAN logic	no	no / yes	
	2	Unit On/Off logic in LAN	Cascade	Cascade / Step Control	
J4	1	Unit Rotation Logic in LAN	standard	none / standard / with standby	
	2	Unit rotation time in LAN	24	0 / 9999	h
J5	1	Delay in next start-up of compressors	2	0 / 999	s
J6	1	Communication speed	19200	1200 / 2400 / 4800 / 9600 / 19200	bps
	2	Identification number	1	1/200	
	3	Communication protocol	Carel	Carel / Modbus/ Lon / Rs232 / GSM	

## 7.2.3 User - Alarms

Screen	Par.	Description	Default	Range	UOM
		<b>User</b>			
K1	1	Type of alarm digital output	all	all / serious / not serious	
	2	alarm digital output logic	n.o.	n.o. / n.c.	
K2	...	alarm configuration Serious/Not Serious	see alarms table	Serious/Not Serious	
K3	...	alarm configuration Serious/Not Serious	see alarms table	Serious/Not Serious	

## 7.2.4 User - Clock

Screen	Par.	Description	Default	Range	UOM
		<b>User</b>			
L2	1	Start of first interval of TIME ZONE 1 - hour	8	0 / 23	h
	2	Start of first interval of TIME ZONE 1 - minutes	0	0 / 59	min.
	3	End of first interval of TIME ZONE 1 - hour	12	0 / 23	h
	4	End of first interval of TIME ZONE 1 - minutes	0	0 / 59	min.
	5	Start of second interval of TIME ZONE 1 - hour	13	0 / 23	h
	6	Start of second interval of TIME ZONE 1 - minutes	0	0 / 59	min.
	7	End of second interval of TIME ZONE 1 - hour	20	0 / 23	h
	8	End of second interval of TIME ZONE 1 - minutes	0	0 / 59	min.
	9	Start of TIME ZONE 2 - hour	8	0 / 23	h
	10	Start of TIME ZONE 2 - minutes	0	0 / 59	min.
	11	End of TIME ZONE 2 - hour	18	0 / 23	h
	12	End of TIME ZONE 2 - minutes	0	0 / 59	min.

## 7.3 MAINTENANCE MENU

### 7.3.1 Maintenance – Manual Control

Screen	Par.	Description	Default	Range	UOM
		<b>Maintenance</b>			
M1	1	Enable D.IN from keyboard	no	no / yes	
	2	Enable A.IN from keyboard	no	no / yes	
	3	Enable D.OUT from keyboard	no	no / yes	
	4	Enable A.OUT from keyboard	no	no / yes	
M4	1	EEV mode circuit 1	auto	auto / man	
	2	Steps demanded of EEV circuit 1	250	0/..	
M6	1	EEV mode circuit 2	auto	auto / man	
	2	Steps demanded of EEV circuit 2	250	0/..	

### 7.3.2 Maintenance – Running hours

Screen	Par.	Description	Default	Range	UOM
		<b>Maintenance</b>			
P1	1	Enable alarm to signal when compressors exceed run time threshold	yes	no / yes	

	2	Compressor run time threshold	10'000	1'000 / 999'000	h
Pb	1	Enable alarm to signal when pumps exceed run time threshold	yes	no / yes	
	2	Pump run time threshold	10'000	1'000 / 999'000	h

### 7.3.3 Maintenance – Parameters

Screen	Par.	Description	Default	Range	UOM
		<b>Maintenance</b>			
N1	1	Offset sensor B1 – pCOXS	0.0	-9.9 / 9.9	
	2	Offset sensor B2 – pCOXS	0.0	-9.9 / 9.9	
	3	Offset sensor B3 – pCOXS	0.0	-9.9 / 9.9	
	4	Offset sensor B4 – pCOXS	0.0	-9.9 / 9.9	
N2	1	Offset sensor B1 – pCO1	0.0	-9.9 / 9.9	
	2	Offset sensor B2 – pCO1	0.0	-9.9 / 9.9	
	3	Offset sensor B3 – pCO1	0.0	-9.9 / 9.9	
	4	Offset sensor B4 – pCO1	0.0	-9.9 / 9.9	
	5	Offset sensor B5 – pCO1	0.0	-9.9 / 9.9	
	6	Offset sensor B6 – pCO1	0.0	-9.9 / 9.9	
	7	Offset sensor B7 – pCO1	0.0	-9.9 / 9.9	
	8	Offset sensor B8 – pCO1	0.0	-9.9 / 9.9	
N3	1	Offset sensor S1 – EVD Circuit 1	0.0	-9.9 / 9.9	
	2	Offset sensor S2 – EVD Circuit 1	0.0	-9.9 / 9.9	
	3	Offset sensor S3 – EVD Circuit 1	0.0	-9.9 / 9.9	
N4	1	Offset sensor S1 – EVD Circuit 2	0.0	-9.9 / 9.9	
	2	Offset sensor S2 – EVD Circuit 2	0.0	-9.9 / 9.9	
	3	Offset sensor S3 – EVD Circuit 2	0.0	-9.9 / 9.9	
N5	1	Maintenance Password	xxxx	0 / 9999	
	2	Duration of Login w/ Password	5	0 / 480	

## 7.4 MANUFACTURER'S MENU

### 7.4.1 Manufacturer - Unit Config.

Screen	Par.	Description	Default	Range	UOM
		<b>Manufacturer</b>			
S1	1	Unit Type	water/air	water/water ; water/air	
	2	Configuration	cooling only	cooling only / heat pump	
	3	Gas	R407C	R22 / R134a / R404A / R407C / R410A / R507 / R290 / R600 / R600a / R717 / R744	
S2	1	Number of circuits	1	1 / 2	
	2	Compressors Circuit 1	1	1 / 2 / 3 / 4	
	3	Compressors Circuit 2	1	1 / 2 / 3 / 4	
	4	Pumps	0	0 / 1 / 2	
S	1	Evaporator	single	single / separate	
S4	1	Condenser	single	single / separate	
S4a	1	Pressure sensor installed	yes	no / yes	
S5	1	Type of Condensation/Evaporation Control	modulating	no / on-off / modulating	
	2	Fan series	1	1 / 2	
	3	Fan series 1 control output	pwm	0-10V / pwm	
	4	Fan series 2 control output	pwm	0-10V / pwm	
S6	1	Pressure sensor configuration	transducer 4-20mA	transd 4-20mA / ratiometric	
	2	Lower value	0.0	-999.9 / 999.9	bars
	3	Upper value	30.0	-999.9 / 999.9	bars
S7	1	Configuration of sensor B2	not present	not present / rem.set.corr. / outdoor temp. sensor	
	2	B2 sensor type	NTC sensor	NTC sensor / 0/1V sensor / 0/5V sensor / 0-20mA sensor / 4-20mA sensor	
S8	1	Configuration of sensor B3	Remote Setpoint Adjustment	Remote Setp. Adjustment / Outdoor Temp.	
S9	1	Outdoor temperature sensor installed	no	no / yes	
Sa	1	Heating element installed	no	no / yes	
Sb	1	Configuration of analog outputs Y1-Y2	without Slew Rate	w/o Slew Rate / w/Slew Rate	

	2	Configuration of analog outputs Y3-Y4	MCHRTF	FCS or CONV0-10A0 / MCHRTF	
Sc	1	Config. of Y1-Y2 Duty Cycle	1.0	0.5 / 10.0	V/ s
	2	Config. of Y1-Y2 Period	1.0	0.5 / 10.0	V/ s
Sd	1	Config. of Y1-Y2 minimum voltage	0.0	0 / 9.9	V
	2	Config. of Y1-Y2 maximum voltage 1	10.0	Sd(1) / Sd(3)	V
	3	Config. of Y1-Y2 maximum voltage 2	10.0	Sd(2) / 10.0	V
Se	1	Minimum Config. Triac Y3-Y4	35.0	0.0 / 100.0	%
	2	Maximum Config. Triac Y3-Y4	93.0	0.0 / 100.0	%
	3	Config. WD Triac Y3-Y4	2.0	0.0 / 10.0	ms
Sf	1	pCOE expansion installed	no	no / yes	
Sg	1	Driver EVD400	0	0 / 2	
	2	EVD400 Driver Type	tLAN	pLAN / tLAN	
Sh	1	EVD400 Sensor Type	NTC-P(rat)	...	
	2	PID Control	direct	direct / reverse	
Yes	1	Valve Type	CAREL E2V	..	
	2	Coil Enabled	no	no / yes	

## 7.4.2 Manufacturer – Parameters

Screen	Par.	Description	Default	Range	UOM
		<b>Manufacturer</b>			
T1	1	Minimum compressor off time	360	0 / 9999	s
	2	Minimum compressor on time	60	0 / 9999	s
T2	1	Time lapse between start-up of different compressors	120	0 / 9999	s
	2	Time lapse between two start-ups of same compressor	450	0 / 9999	s
T3	1	Enable antifreeze heating element	no	no / yes	
	2	Antifreeze heating element control setpoint	6.0	-99.9 / 99.9	°C
	3	Antifreeze heating element control differential;	1.0	-99.9 / 99.9	°C
T4	1	Enable D.In filter	no	no / yes	
	2	Filter delay time	5	0 / 9	s
T5	1	Condensation Control - Setpoint	11.0	0.0 / 30.0	bars
	2	Condensation Control - Differential	10.0	0.0 / 20.0	bars
T6	1	Condensation - Fans On Override	none	none / in advance / speed-up	
	2	Condensation - Duration of Override	10	0 / 999	s
	3	Condensation - Override Speed	80.0	0.0 / 100.0	%
T7	1	Condensation - Speed Alarm	100.0	0.0 / 100.0	%
T8	1	Evaporation Control - Setpoint	9.0	0.0 / 45.0	bars
	2	Evaporation Control - Differential	4.0	0.0 / 45.0	bars
T9	1	Evaporation - Fans On Override	none	none / in advance / speed-up	
	2	Evaporation - Duration of Override	10	0 / 999	s
	3	Evaporation - Override Speed	80.0	0.0 / 100.0	%
Ta	1	Evaporation - Speed Alarm	100.0	0.0 / 100.0	%
Tb	1	Advance/delay in pump on/off switching	20	0 / 999	s
Tc	1	Cycle-reversing valve in heat pump	energised	energised / non-energised	
	2	ON delay in valve rotation	10	0 / 99	s
	3	Enable ON delay	no	no / yes	
Td	1	Defrost Logic	Press. threshold	Pressure threshold / Temp. change	
	2	Defrost Mode	simultaneous	simultaneous / separate	
	3	Max. duration of defrost cycle	300	0 / 9999	s
	4	Minimum time lapse between two defrost cycles	30	0 / 500	min.
Te	1	Pressure threshold for starting defrost cycle	2.5	-99.9 / 99.9	bars
	2	Pressure threshold for stopping defrost cycle	19.0	Te(1) / 99.9	bars
	3	Defrost start delay time	120	0 / 9999	s
Tf	1	Temperature change for starting defrost cycle	5.0	0 / 99.9	°C
	2	Pressure threshold for stopping defrost cycle	19.0	-99.9 / 99.9	bars
Tf	1	Max. evap. temp. for starting defrost cycle	0.0	-99.9 / 99.9	°C
Tf	1	Delay for memorisation of max. evaporation temp.	180	0 / 999	s
Tg	1	Enable compres. stop when defrosting begins	no	no / yes	
	2	Duration of compres. stop at beginning of defrost cycle	30	2 / 999	s
Th	1	Enable compres. stop when defrosting ends	no	no / yes	
	2	Duration of compres. stop at end of defrost cycle	30	2 / 999	s
Ti	1	Enable fans ON at end of defrost cycle	no	no / yes	
	2	Fan speed at end of defrost cycle	100.0	0.0 / 100.0	%
	3	Max. fan run time at end of defrost cycle	30	2 / 999	s
	4	Max. pressure while fans running at end of defrost cycle	21.5	Te(2) or Tf(2) / 99.9	bars
Tj	1	Delay compres. start-up during defrost cycle	5	1 / 999	s
Tk	1	Enable Freecooling	no	no / yes	
Tm	1	Compr. off time at start of Freecooling	120	30 / 999	s
Tn	1	Outlet water T limit in Freecooling mode	7.0	/ 99.9	°C
	2	Differential for reactivation of Freecooling	1.0	0.0 / 5.0	°C
To	1	Freecooling valve run time	180	0 / 500	s

	2	Enable Freecooling valve rotation	yes	no / yes	
	3	Freecooling valve rotation threshold	168	0 / 720	hours
<b>Tp</b>	1	Freecooling valve override time	50	0 / 180	s
	2	Adjust Freecooling valve counter	3600	0 / 4000	s
<b>Tq</b>	1	Enable coil capacity control solenoid valve	yes	no / yes	
	2	Capacity control solenoid valve logic	n.o.	n.o. / n.c.	
<b>Tr</b>	1	HP prevention – Capacity reduction inhibition setpoint	23.0	20.0 / 25.0	bars
	2	HP prevention – Capacity reduction inhibition differential	5.0	1.0 / 10.0	bars
<b>Ts</b>	1	LP prevention – Capacity reduction setpoint	11.0	5.0 / 20.0	bars
	2	LP prevention – Capacity reduction differential	5.0	1.0 / 10.0	bars
<b>Tt</b>	1	Enable capacity control solenoid valve override	yes	no / yes	
<b>Tu</b>	1	Compr. OFF time with valve open due to override	120	0 / 999	min.
	2	Duration of valve override for compr. OFF	10	0 / 999	min.
<b>Tv</b>	1	Compr. ON time in FC mode with valve open due to override	60	0 / 999	min.
	2	Duration of valve override for compr. ON in FC mode	5	0 / 999	min.
<b>Tw</b>	1	Enable low load logic	no	no / yes	
	2	Low load logic application mode	Chiller	Chiller / Heat Pump / Chiller + Heat Pump	
	3	Max compr. On for low load definition	120	T1(2) / 999	s
<b>Tx</b>	1	Differential in low load - Chiller	5.0	0.0 / 10.0	°C
	2	Differential in low load – Heat Pump	5.0	0.0 / 10.0	°C
<b>Ty</b>	1	Duration of ON enabling by Master unit	5	0 / 999	s
<b>Tz</b>	1	Enable compr. inhibition on Text – Heat Pump	no	no / yes	
	2	Set compr. inhibition on Text – Heat Pump	-10.0	-99.9 / 99.0	°C
	3	Compr. inhibition differential on Text – Heat Pump	1.0	0.0 / 9.9	°C

### 7.4.3 Manufacturer – Alarms

Screen	Par.	Description	Default	Range	UOM
		<b>Manufacturer</b>			
<b>U1</b>	1	Enable sensor fault alarm	yes	no / yes	
	2	Sensor fault alarm delay	10	0 / 9999	s
<b>U2</b>	1	Enable sensor B1 fault alarm – pCOXS	yes	no / yes	
	2	Enable sensor B2 fault alarm – pCOXS	yes	no / yes	
	3	Enable sensor B3 fault alarm – pCOXS	yes	no / yes	
	4	Enable sensor B4 fault alarm – pCOXS	yes	no / yes	
<b>U3</b>	1	Enable sensor B1 fault alarm – pCO1	yes	no / yes	
	2	Enable sensor B2 fault alarm – pCO1	yes	no / yes	
	3	Enable sensor B3 fault alarm – pCO1	no	no / yes	
	4	Enable sensor B4 fault alarm – pCO1	yes	no / yes	
	5	Enable sensor B5 fault alarm – pCO1	yes	no / yes	
	6	Enable sensor B6 fault alarm – pCO1	no	no / yes	
	7	Enable sensor B7 fault alarm – pCO1	no	no / yes	
	8	Enable sensor B8 fault alarm – pCO1	no	no / yes	
<b>U5</b>	1	Enable clock alarm	no	no / yes	
<b>U6</b>	1	Enable pump thermal alarm	yes	no / yes	
	2	Pump thermal alarm reset	man	auto / man	
	3	Pump thermal alarm delay	0	0 / 999	s
<b>U7</b>	1	Enable flow alarm	yes	no / yes	
	2	Flow alarm reset	man	auto / man	
	3	Flow alarm delay at start-up	20	0 / 999	s
	4	Flow alarm delay during operation	5	0 / 999	s
<b>U9</b>	1	Enable high pressure alarm by pressure switch	yes	no / yes	
	2	High pressure alarm reset	man	auto / man	
	3	High pressure alarm delay	0	0 / 999	s
<b>Ua</b>	1	Enable low pressure alarm by pressure switch	yes	no / yes	
	2	Low pressure alarm reset	man	auto / man	
	3	Low pressure alarm delay at start-up	120	0 / 999	s
	4	Low pressure alarm delay during operation	120	0 / 999	s
<b>Ub</b>	1	Disable low pressure alarm in heat pump mode	no	no / yes	
<b>Uc</b>	1	Delay time of a second manually reset low pressure alarm	60	0 / 540	min.
	2	Enable second manually reset low pressure alarm	no	no / yes	
<b>Ud</b>	1	Enable high pressure alarm triggered by sensor	yes	no / yes	
	2	Sensor-triggered high pressure alarm reset	man	auto / man	
	3	Sensor-triggered high pressure alarm setpoint	27.5	0.0 / 99.9	bars
	4	Sensor-triggered high pressure alarm differential	2.0	0.0 / 99.9	bars
	5	Sensor-triggered high pressure alarm delay	1	1 / 999	s
<b>Ue</b>	1	High pressure alarm prevention	yes	no / yes	
	2	High pressure alarm prevention setpoint	26.5	0.0 / 99.9	bars
	3	High pressure alarm prevention diff.	5.0	0.0 / 99.9	bars
	4	High pressure alarm prevention delay	0	0 / 999	s
<b>Uf</b>	1	Attempts to prevent high pressure alarm with single compressor circuit	3	1 / 99	
<b>Ug</b>	1	Enable low pressure alarm triggered by sensor	no	no / yes	
	2	Sensor-triggered low pressure alarm reset	man	auto / man	
	3	Sensor-triggered low pressure alarm setpoint	1.0	0.0 / 99.9	bars
	4	Sensor-triggered low pressure alarm differential	2.0	0.0 / 99.9	bars
	5	Low pressure alarm delay at start-up	60	0 / 999	s



	6	Low pressure alarm delay during operation	0	0 / 999	s
Uh	1	Enable compressor thermal alarm	yes	no / yes	
	2	Compressor thermal alarm reset	man	auto / man	
	3	Compressor thermal alarm delay at start-up	10	0 / 999	s
	4	Compressor thermal alarm delay during operation	10	0 / 999	s
Ui	1	Enable fan thermal alarm	yes	no / yes	
	2	Fan thermal alarm reset	man	auto / man	
	3	Fan thermal alarm delay	0	0 / 999	s
Uj	1	Enable antifreeze alarm	yes	no / yes	
	2	Antifreeze alarm reset	man	auto / man	
	3	Antifreeze alarm setpoint	4.0	-99.9 / 99.9	°C
	4	Antifreeze alarm differential	1.0	0.0 / 99.9	°C
	5	Antifreeze alarm delay	0	0 / 999	s
Uk	1	Enable phase direction alarm	yes	no / yes	
Um	1	Enable Freecooling fault alarm	no	no / yes	
	2	Freecooling fault alarm reset	auto	auto / man	
	3	Freecooling fault alarm delay	300	240 / 600	s
	4	Freecooling fault alarm differential	0.2	0.0 / 2.0	°C
Un	1	Threshold value of (Tin-Tfc) beyond which, in the absence of freecooling, a fault will be signalled	1.0	0.0 / 3.0	°C
	2	Threshold value of  Tfc-Tin  below which, if the freecooling function is on, a fault will be signalled	0.5	0.0 / 2.0	°C
Uo	1	Minimum fan operating capacity for enabling freecooling fault alarm	20.0	0.0 / 100.0	%

#### 7.4.4 Manufacturer – Carel EVD

Screen	Par.	Description	Default	Range	UOM
		<b>Manufacturer</b>			
V1	1	Minimum steps – Custom Valve	0	0 / 8100	
	2	Maximum steps – Custom Valve	0	0 / 8100	
	3	Closing steps – Custom Valve	0	0 / 8100	
V2	1	Extra Opening – Custom Valve	no	no / yes	
	2	Extra Closing – Custom Valve	no	no / yes	
V3	1	Mov. current	0	0 / 1000	mA
	2	Stat. current	0	0 / 1000	mA
	3	Frequency	32	32 / 501	Hz
	4	Duty cycle	0	0 / 100	%
V4	1	EEV position with 0% capacity demanded	30		
V5	1	Minimum value of EVD sensor S1	-1.0	-9.9 / 99.9	barg
	2	Maximum value of EVD sensor S1	9.3	0.0 / 99.9	barg
V6	1	Low superheat alarm delay	120	0 / 3600	s
	2	High superheat alarm delay	20	0 / 500	min.
	3	LOP alarm delay	120	0 / 3600	s
	4	MOP alarm delay	0	0 / 3600	s
	5	Sensor error alarm delay	10	0 / 999	s
V8	1	Percentage of EEV opening – Chiller Mode	0	0 / 100	%
	2	Proportional constant – Chiller Mode	0.0	0.0 / 99.9	
	3	Integration time – Chiller Mode	0	0 / 999	s
V9	1	Superheati setpoint – Chiller Mode – Driver 1	0.0	0.0 / 50.0	°C
	2	Low superheat – Chiller Mode – Driver 1	0.0	-4.0 / 21.0	°C
Va	1	Superheat setpoint – Chiller Mode – Driver 2	0.0	0.0 / 50.0	°C
	2	Low superheat – Chiller Mode – Driver 2	0.0	-4.0 / 21.0	°C
Vb	1	Percentage of EEV opening – Heat Pump Mode	0	0 / 100	%
	2	Proportional constant – Heat Pump Mode	0.0	0.0 / 99.9	
	3	Integration time – Heat Pump Mode	0	0 / 999	s
Vc	1	Superheat setpoint – Heat Pump Mode – Driver 1	0.0	0.0 / 50.0	°C
	2	Low superheat – Heat Pump Mode – Driver 1	0.0	-4.0 / 21.0	°C
Vd	1	Superheat setpoint – Heat Pump Mode – Driver 2	0.0	0.0 / 50.0	°C
	2	Low superheat – Heat Pump Mode – Driver 2	0.0	-4.0 / 21.0	°C
Ve	1	Percentage of EEV opening – Defrost Mode	0	0 / 100	%
	2	Proportional constant – Defrost mode	0.0	0.0 / 99.9	
	3	Integration time – Defrost mode	0	0 / 999	s
Vf	1	Superheat setpoint – Defrost Mode – Driver 1	0.0	0.0 / 50.0	°C
	2	Low superheat – Defrost Mode – Driver 1	0.0	-4.0 / 21.0	°C
Vg	1	Superheat setpoint – Defrost Mode – Driver 2	0.0	0.0 / 50.0	°C
	2	Low superheat – Defrost Mode – Driver 2	0.0	-4.0 / 21.0	°C
Vh	1	Dead band - Superheating	0.0	0.0 / 9.9	°C
	2	Derivative time - Superheating	0.0	0.0 / 99.9	s
	3	Integral time low superheat	0.0	0.0 / 30.0	s
	4	Integral time LOP	0.0	0.0 – 25.5	s
Vi	1	Integral time MOP	0.0	0.0 – 25.5	s
	2	MOP start-up delay	0	0 / 500	s
Vj	1	Dynamic proportional control	no	no / yes	
	2	EEV block control	0	0 / 999	s
Vk	1	High condensation temp. alarm	0	0.0 / 99.9	°C
	2	Integral time condensation temp.	0	0 / 25.5	s
Vn	1	Percentage of opening at start-up	60	0 / 100	%

<b>Vo</b>	1	Compressors	SCREW	Not Selected / RECIPROCATING / SCREW / SCROLL / CABINET FLOODED / CABINET	
	2	Capacity control	NO / STEPS	Not selected / NO- STEPS / SLOW CONTINUOUS / FAST CONTINUOUS	
<b>Vp</b>	1	Evaporator in cooling mode	PLATES	Not Selected / PLATES / TUBE BUNDLE / FINS FAST / FINS SLOW	
	2	Evaporator in heating mode	FINS FAST	Not Selected/ PLATES/ TUBE BUNDLE/ FINS FAST / FINS SLOW	
<b>Vq</b>	1	Min. saturation temp. in cooling mode	-2.0	-70.0 / 50.0	°C
	2	Min. saturation temp. in heating mode	-18.0	-70.0 / 50.0	°C
	3	Min. saturation temp. in defrost mode	-30.0	-70.0 / 50.0	°C
<b>Vr</b>	1	Max. saturation temp. in cooling mode	12.0	-50.0 / 90.0	°C
	2	Max. saturation temp. in heating mode	12.0	-50.0 / 90.0	°C
	3	Max. saturation temp. in defrost mode	15.0	-50.0 / 90.0	°C
<b>Vs</b>	1	High superheat alarm threshold	0	0 / 1000	°C

# 8 CONTROL SYSTEM ARCHITECTURE

## 8.1 MICROPROCESSOR LAYOUT

### 8.1.1 pCO1

#### Description of connectors

1. power supply connection [G(+), G0(-)];
2. 2A slow-blow fuse, 250 Vac (T2 A);
3. NTC universal analog inputs, 0/1 V, 0/5 V, 0/20 mA, 4/20 mA;
4. ON/OFF and NTC passive analog inputs;
5. NTC passive analog inputs;
6. Yellow power ON LED and 3 indicator LEDs;
7. analog outputs 0/10 V and PWM current outputs;
8. 24 Vac/Vdc digital inputs;
9. 230 Vac or 24 Vac/Vdc digital inputs;
10. connector with Vref for 5V power supply to sensors and V Term for power supply to display terminal;
11. connector for all standard display terminals in pCO controller series and for downloading application program;
12. pLAN local network connector;
13. connector for connection to the programming key;
14. digital outputs to relay;
15. flap for selecting the type of analog inputs;
16. flap for installing serial card (optional)
17. flap for installing clock card (optional).

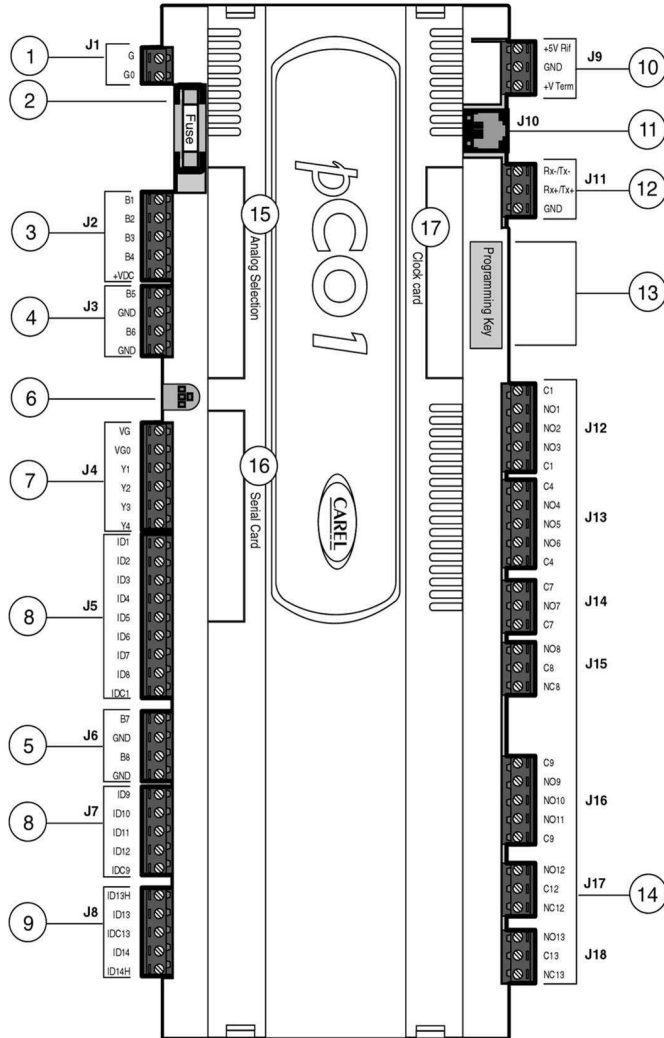
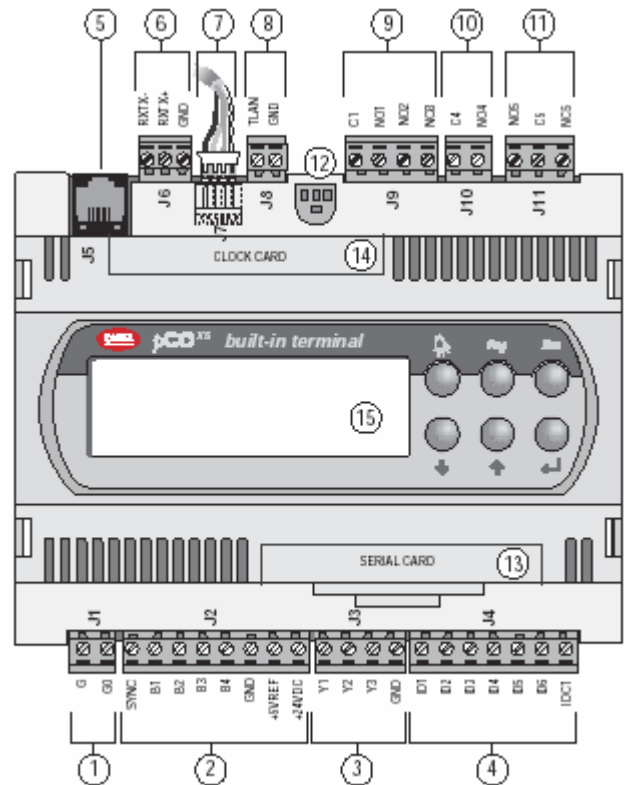

Figure 15: Layout

## 8.1.2 pCOXS

1. Connector for 24Vac or 20/60 Vdc power supply [G (+), G0 (-)].
2. Input (24 Vac) for phase controller and NTC analog inputs, 0/1 V, 0/5 V, 0/20 mA, 4/20 mA, +5Vref for power supply to 5V ratiometric sensors and +24VDC for power supply to active sensors.
3. Analog outputs 0/10 V and PWM phase control output
4. Voltage-free contact digital inputs.
5. Connector for all standard pCO\* series terminals and for downloading application program.
6. pLAN local network connector.
7. tLAN terminal connector.
8. tLAN or MP-Bus network connector.
9. Digital relay outputs with 1 common.
10. Digital relay output
11. Alarm digital relay output with changeover contact/SSR.
12. Yellow power ON LED and 3 LEDs for indicating the pCOXS status.
13. Flap for installing serial card (optional).
14. Flap for installing clock card (optional).
- 15 Built-In Terminal (non provided).



## 8.1.3 Analog Input Configuration

Given the presence of analog inputs designed to accept different sensors, the inputs themselves must be configured from the screens of the *Manufacturer's menu* → *Parameters* → *S6-S8*. In the case of the pCO1 controller, it is also necessary to configure the respective dipswitches as shown in the figure below

B1	B2	B3	B4	B5	B6	ON	OFF
1	2	3	4	5	6	1	2

0/1V	NTC	0/20mA	0/5V								
1	2	3	4	5	6	1	2	3	4	5	6

**Esempio/Example**

B1	B2	B3	B4	B5	B6	ON	OFF
0/1V	NTC	0/20mA	0/5V	NTC	digital input		

Input B1, B2, B3, B4			Input
OFF	OFF	OFF	0/1V
ON	OFF	OFF	NTC
OFF	ON	OFF	0/20mA
OFF	OFF	ON	0/5V

Input B5, B6		Input
ON		digital input
OFF		NTC

digital input	NTC	ON	OFF

## 8.2 DESCRIPTION OF INPUTS/OUTPUTS

### 8.2.1 pCO1

#### • Cooling Only – W/A

Cooling Only – W/A			Description			
Conn.	Name	Signal	1 Circuit 1 Compressor	1 Circuit 2 Compressors	2 Circuits 2 Compressors	2 Circuits 4 Compressors
<b>Analog input</b>						
J2-1	B1	4..20 mA / 0-5V	Condensation Pressure	Condensation Pressure	Condensation Pressure circ.1	Condensation Pressure circ.1
J2-2	B2	4..20 mA / 0-5V	--	--	Condensation Pressure circ.2	Condensation Pressure circ.2
J2-3	B3	4..20 mA	Remote Setpoint adjustment	Remote Setpoint adjustment	Remote Setpoint adjustment	Remote Setpoint adjustment
J3-3	B4	NTC	Evaporator inlet water temperature	Evaporator inlet water temperature	Evaporator inlet water temperature	Evaporator inlet water temperature
J3-1	B5	NTC	Evaporator outlet water temperature	Evaporator outlet water temperature	Evaporator 1 outlet water temperature	Evaporator 1 outlet water temperature
J3-3	B6	NTC	--	--	Evaporator 2 outlet water temperature	Evaporator 2 outlet water temperature
J6-1	B7	NTC	Outdoor air temperature	Outdoor air temperature	Outdoor air temperature	Outdoor air temperature
J6-3	B8	NTC	--	--	--	--
<b>Analog output</b>						
J4-3	Y1	0..10 V	Condensation fan control	Condensation fan control	Condensation fan control - 1	Condensation fan control - 1
J4-4	Y2	0..10 V	--	--	Condensation fan control - 2	Condensation fan control - 2
J4-5	Y3	PWM	Condensation fan control	Condensation fan control	Condensation fan control - 1	Condensation fan control - 1
J4-6	Y4	PWM	--	--	Condensation fan control - 2	Condensation fan control - 2
<b>Digital input</b>						
J5-1	ID1	24 Vac/Vdc	High-pressure alarm triggered by pressure switch	High-pressure alarm triggered by pressure switch	High-pressure alarm triggered by pressure switch- circ. 1	High-pressure alarm triggered by pressure switch- circ. 1
J5-2	ID2	24 Vac/Vdc	--	--	High-pressure alarm triggered by pressure switch - circ. 2	High-pressure alarm triggered by pressure switch - circ. 2
J5-3	ID3	24 Vac/Vdc	Low-pressure alarm triggered by pressure switch	Low-pressure alarm triggered by pressure switch	High-pressure alarm triggered by pressure switch - circ. 1	High-pressure alarm triggered by pressure switch - circ. 1
J5-4	ID4	24 Vac/Vdc	--	--	High-pressure alarm triggered by pressure switch - circ. 2	High-pressure alarm triggered by pressure switch - circ. 2
J5-5	ID5	24 Vac/Vdc	Compressor thermal alarm	Compressor thermal alarm	Compressor thermal alarm - circ 1	Compressor thermal alarm - circ 1
J5-6	ID6	24 Vac/Vdc	--	--	Compressor thermal alarm - circ 2	Compressor thermal alarm - circ 2
J5-7	ID7	24 Vac/Vdc	Thermal alarm pump 1	Thermal alarm pump 1	Thermal alarm pump 1	Thermal alarm pump 1
J5-8	ID8	24 Vac/Vdc	Thermal alarm pump 2	Thermal alarm pump 2	Thermal alarm pump 2	Thermal alarm pump 2
J7-1	ID9	24 Vac/Vdc	Water flow switch alarm	Water flow switch alarm	Water flow switch alarm	Water flow switch alarm
J7-2	ID10	24 Vac/Vdc	General fan alarm	General fan alarm	General fan alarm - 1	General fan alarm - 1
J7-3	ID11	24 Vac/Vdc	Phase direction alarm	Phase direction alarm	Phase direction alarm	Phase direction alarm
J7-4	ID12	24 Vac/Vdc	Remote On/Off	Remote On/Off	Remote On/Off	Remote On/Off
J8-2	ID13	24 Vac/Vdc	--	--	General fan alarm - 2	General fan alarm - 2
J8-4	ID14	24 Vac/Vdc	Serious alarm/secondary setpoint	Serious alarm/secondary setpoint	Serious alarm/secondary setpoint	Serious alarm/secondary setpoint
<b>Digital output</b>						
J12-2	NO1	NO relay	Compr. ON/OFF 1	Compr. ON/OFF 1	Compr.1 ON/OFF (Circ.1)	Compr.1 ON/OFF (Circ.1)
J12-3	NO2	NO relay	--	Compr. ON/OFF 2	Compr.2 ON/OFF (Circ.2)	Compr.2 ON/OFF (Circ.1)
J12-4	NO3	NO relay	--	--	--	Compr.3 ON/OFF (Circ.2)
J13-2	NO4	NO relay	--	--	--	Compr.4 ON/OFF (Circ.2)

J13-3	NO5	NO relay	Pump 1 ON/OFF	Pump 1 ON/OFF	Pump 1 ON/OFF	Pump 1 ON/OFF
J13-4	NO6	NO relay	Pump 2 ON/OFF	Pump 2 ON/OFF	Pump 2 ON/OFF	Pump 2 ON/OFF
J14-2	NO7	NO relay	Antifreeze heating element ON/OFF	Antifreeze heating element ON/OFF	Antifreeze heating element ON/OFF	Antifreeze heating element ON/OFF
J15-1	NO8	NO relay	General alarm	General alarm	General alarm	General alarm
J16-2	NO9	NO relay	Fans ON/OFF	Fans ON/OFF	Fans ON/OFF - 1	Fans ON/OFF - 1
J16-3	NO10	NO relay	--	--	--	--
J16-4	NO11	NO relay	--	--	--	--
J17-1	NO12	NO relay	--	--	Fans ON/OFF - 2	Fans ON/OFF - 2
J18-1	NO13	NO relay	Unit ON/OFF	Unit ON/OFF	Unit ON/OFF	Unit ON/OFF

• **Cooling Only – W/W**

Cooling Only – W/W			Description			
Conn.	Name	Signal	1 Circuit 1 Compressor	1 Circuit 2 Compressors	2 Circuits 2 Compressors	2 Circuits 4 Compressors
<b>Analog input</b>						
J2-1	B1	4..20 mA / 0-5V	Condensation Pressure	Condensation Pressure	Condensation Pressure circ.1	Condensation Pressure circ.1
J2-2	B2	4..20 mA / 0-5V	--	--	Condensation Pressure circ.2	Condensation Pressure circ.2
J2-3	B3	4..20 mA / NTC	Remote setpoint adjustment / Outdoor air temperature	Remote setpoint adjustment / Outdoor air temperature	Remote setpoint adjustment / Outdoor air temperature	Remote setpoint adjustment / Outdoor air temperature
J3-3	B4	NTC	Evaporator inlet water temperature	Evaporator inlet water temperature	Evaporator inlet water temperature	Evaporator inlet water temperature
J3-1	B5	NTC	Evaporator outlet water temperature	Evaporator outlet water temperature	Evaporator 1 outlet water temperature	Evaporator 1 outlet water temperature
J3-3	B6	NTC	--	--	Evaporator 2 outlet water temperature	Evaporator 2 outlet water temperature
J6-1	B7	NTC	Condenser water temperature	Condenser water temperature	Condenser water temperature	Condenser water temperature
J6-3	B8	NTC	--	--	Condenser water temperature	Condenser water temperature
<b>Analog output</b>						
J4-3	Y1	0..10 V	--	--	--	--
J4-4	Y2	0..10 V	--	--	--	--
J4-5	Y3	PWM	--	--	--	--
J4-6	Y4	PWM	--	--	--	--
<b>Digital input</b>						
J5-1	ID1	24 Vac/Vdc	High-pressure alarm triggered by pressure sensor	High-pressure alarm triggered by pressure sensor	High-pressure alarm triggered by pressure sensor - circ. 1	High-pressure alarm triggered by pressure sensor - circ. 1
J5-2	ID2	24 Vac/Vdc	--	--	High-pressure alarm triggered by pressure sensor - circ. 2	High-pressure alarm triggered by pressure sensor - circ. 2
J5-3	ID3	24 Vac/Vdc	Low-pressure alarm triggered by pressure sensor	Low-pressure alarm triggered by pressure sensor	High-pressure alarm triggered by pressure sensor - circ. 1	High-pressure alarm triggered by pressure sensor - circ. 1
J5-4	ID4	24 Vac/Vdc	--	--	High-pressure alarm triggered by pressure sensor - circ. 2	High-pressure alarm triggered by pressure sensor - circ. 2
J5-5	ID5	24 Vac/Vdc	Compressor thermal alarm	Compressor thermal alarm	Compressor thermal alarm - circ 1	Compressor thermal alarm - circ 1
J5-6	ID6	24 Vac/Vdc	--	--	Compressor thermal alarm - circ 2	Compressor thermal alarm - circ 2
J5-7	ID7	24 Vac/Vdc	Thermal alarm pump 1	Thermal alarm pump 1	Thermal alarm pump 1	Thermal alarm pump 1
J5-8	ID8	24 Vac/Vdc	Thermal alarm pump 2	Thermal alarm pump 2	Thermal alarm pump 2	Thermal alarm pump 2
J7-1	ID9	24 Vac/Vdc	Water flow switch alarm	Water flow switch alarm	Water flow switch alarm	Water flow switch alarm
J7-2	ID10	24 Vac/Vdc	--	--	--	--
J7-3	ID11	24 Vac/Vdc	Phase direction alarm	Phase direction alarm	Phase direction alarm	Phase direction alarm
J7-4	ID12	24 Vac/Vdc	Remote On/Off	Remote On/Off	Remote On/Off	Remote On/Off
J8-2	ID13	24 Vac/Vdc	--	--	--	--
J8-4	ID14	24 Vac/Vdc	Serious alarm/secondary setpoint	Serious alarm/secondary setpoint	Serious alarm/secondary setpoint	Serious alarm/secondary setpoint

Digital output						
J12-2	NO1	NO relay	Compr. ON/OFF 1	Compr. ON/OFF 1	Compr.1 ON/OFF (Circ.1)	Compr.1 ON/OFF (Circ.1)
J12-3	NO2	NO relay	--	Compr. ON/OFF 2	Compr.2 ON/OFF (Circ.2)	Compr.2 ON/OFF (Circ.1)
J12-4	NO3	NO relay	--	--	--	Compr.3 ON/OFF (Circ.2)
J13-2	NO4	NO relay	--	--	--	Compr.4 ON/OFF (Circ.2)
J13-3	NO5	NO relay	Pump 1 ON/OFF	Pump 1 ON/OFF	Pump 1 ON/OFF	Pump 1 ON/OFF
J13-4	NO6	NO relay	Pump 2 ON/OFF	Pump 2 ON/OFF	Pump 2 ON/OFF	Pump 2 ON/OFF
J14-2	NO7	NO relay	Antifreeze heating element ON/OFF	Antifreeze heating element ON/OFF	Antifreeze heating element ON/OFF	Antifreeze heating element ON/OFF
J15-1	NO8	NO relay	General alarm	General alarm	General alarm	General alarm
J16-2	NO9	NO relay	--	--	--	--
J16-3	NO10	NO relay	--	--	--	--
J16-4	NO11	NO relay	--	--	--	--
J17-1	NO12	NO relay	--	--	--	--
J18-1	NO13	NO relay	Unit ON/OFF	Unit ON/OFF	Unit ON/OFF	Unit ON/OFF

• Heat Pump – W/A

Heat Pump – W/A			Description			
Conn.	Name	Signal	1 Circuit 1 Compressor	1 Circuit 2 Compressors	2 Circuits 2 Compressors	2 Circuits 4 Compressors
<b>Analog input</b>						
J2-1	B1	4..20 mA / 0-5V	Condensation Pressure	Condensation Pressure	Condensation Pressure circ.1	Condensation Pressure circ.1
J2-2	B2	4..20 mA / 0-5V	--	--	Condensation Pressure circ.2	Condensation Pressure circ.2
J2-3	B3	4..20 mA	Remote Setpoint adjustment	Remote Setpoint adjustment	Remote Setpoint adjustment	Remote Setpoint adjustment
J3-3	B4	NTC	Evaporator inlet water temperature	Evaporator inlet water temperature	Evaporator inlet water temperature	Evaporator inlet water temperature
J3-1	B5	NTC	Evaporator outlet water temperature	Evaporator outlet water temperature	Evaporator 1 outlet water temperature	Evaporator 1 outlet water temperature
J3-3	B6	NTC / On-Off	--	--	Evap. 2 outlet water temp. / General fan alarm - 2	Evap. 2 outlet water temp. / General fan alarm - 2
J6-1	B7	NTC	Outdoor air temperature	Outdoor air temperature	Outdoor air temperature	Outdoor air temperature
J6-3	B8	NTC	--	--	--	--
<b>Analog output</b>						
J4-3	Y1	0..10 V	Condensation fan control	Condensation fan control	Condensation fan control - 1	Condensation fan control - 1
J4-4	Y2	0..10 V	--	--	Condensation fan control - 2	Condensation fan control - 2
J4-5	Y3	PWM	Condensation fan control	Condensation fan control	Condensation fan control - 1	Condensation fan control - 1
J4-6	Y4	PWM	--	--	Condensation fan control - 2	Condensation fan control - 2
<b>Digital input</b>						
J5-1	ID1	24 Vac/Vdc	High-pressure alarm triggered by pressure sensor	High-pressure alarm triggered by pressure sensor	High-pressure alarm triggered by pressure sensor - circ. 1	High-pressure alarm triggered by pressure sensor - circ. 1
J5-2	ID2	24 Vac/Vdc	--	--	High-pressure alarm triggered by pressure sensor - circ. 2	High-pressure alarm triggered by pressure sensor - circ. 2
J5-3	ID3	24 Vac/Vdc	Low-pressure alarm triggered by pressure sensor	Low-pressure alarm triggered by pressure sensor	High-pressure alarm triggered by pressure sensor - circ. 1	High-pressure alarm triggered by pressure sensor - circ. 1
J5-4	ID4	24 Vac/Vdc	--	--	High-pressure alarm triggered by pressure sensor - circ. 2	High-pressure alarm triggered by pressure sensor - circ. 2
J5-5	ID5	24 Vac/Vdc	Compressor thermal alarm	Compressor thermal alarm	Compressor thermal alarm - circ 1	Compressor thermal alarm - circ 1
J5-6	ID6	24 Vac/Vdc	--	--	Compressor thermal alarm - circ 2	Compressor thermal alarm - circ 2
J5-7	ID7	24 Vac/Vdc	Thermal alarm pump 1	Thermal alarm pump 1	Thermal alarm pump 1	Thermal alarm pump 1
J5-8	ID8	24 Vac/Vdc	Thermal alarm pump 2	Thermal alarm pump 2	Thermal alarm pump 2	Thermal alarm pump 2

J7-1	ID9	24 Vac/Vdc	Water flow switch alarm	Water flow switch alarm	Water flow switch alarm	Water flow switch alarm
J7-2	ID10	24 Vac/Vdc	General fan alarm	General fan alarm	General fan alarm - 1	General fan alarm - 1
J7-3	ID11	24 Vac/Vdc	Phase direction alarm	Phase direction alarm	Phase direction alarm	Phase direction alarm
J7-4	ID12	24 Vac/Vdc	Remote On/Off	Remote On/Off	Remote On/Off	Remote On/Off
J8-2	ID13	24 Vac/Vdc	Summer/Winter Changeover	Summer/Winter Changeover	Summer/Winter Changeover	Summer/Winter Changeover
J8-4	ID14	24 Vac/Vdc	Serious alarm/secondary setpoint	Serious alarm/secondary setpoint	Serious alarm / secondary setpoint	Serious alarm / secondary setpoint
<b>Digital output</b>						
J12-2	NO1	NO relay	Compr. ON/OFF 1	Compr. ON/OFF 1	Compr.1 ON/OFF (Circ.1)	Compr.1 ON/OFF (Circ.1)
J12-3	NO2	NO relay	--	Compr. ON/OFF 2	Compr.2 ON/OFF (Circ.2)	Compr.2 ON/OFF (Circ.1)
J12-4	NO3	NO relay	--	--	--	Compr.3 ON/OFF (Circ.2)
J13-2	NO4	NO relay	--	--	--	Compr.4 ON/OFF (Circ.2)
J13-3	NO5	NO relay	Pump 1 ON/OFF	Pump 1 ON/OFF	Pump 1 ON/OFF	Pump 1 ON/OFF
J13-4	NO6	NO relay	Pump 2 ON/OFF	Pump 2 ON/OFF	Pump 2 ON/OFF	Pump 2 ON/OFF
J14-2	NO7	NO relay	Antifreeze heating element ON/OFF	Antifreeze heating element ON/OFF	Antifreeze heating element ON/OFF	Antifreeze heating element ON/OFF
J15-1	NO8	NO relay	General alarm	General alarm	General alarm	General alarm
J16-2	NO9	NO relay	Fans ON/OFF	Fans ON/OFF	Fans ON/OFF - 1	Fans ON/OFF - 1
J16-3	NO10	NO relay	Cycle Reversing Valve	Cycle Reversing Valve	Cycle Reversing Valve - circ.1	Cycle Reversing Valve - circ.1
J16-4	NO11	NO relay	--	--	Cycle Reversing Valve - circ.2	Cycle Reversing Valve - circ.2
J17-1	NO12	NO relay	--	--	Fans ON/OFF - 2	Fans ON/OFF - 2
J18-1	NO13	NO relay	Unit ON/OFF	Unit ON/OFF	Unit ON/OFF	Unit ON/OFF

• Heat Pump – W/W

Heat Pump – W/W			Description			
Conn.	Name	Signal	1 Circuit 1 Compressor	1 Circuit 2 Compressors	2 Circuits 2 Compressors	2 Circuits 4 Compressors
<b>Analog input</b>						
J2-1	B1	4..20 mA / 0-5V	Condensation Pressure	Condensation Pressure	Condensation Pressure circ.1	Condensation Pressure circ.1
J2-2	B2	4..20 mA / 0-5V	--	--	Condensation Pressure circ.2	Condensation Pressure circ.2
J2-3	B3	4..20 mA / NTC	Remote setpoint adjustment / Outdoor air temperature	Remote setpoint adjustment / Outdoor air temperature	Remote setpoint adjustment / Outdoor air temperature	Remote setpoint adjustment / Outdoor air temperature
J3-3	B4	NTC	Evaporator inlet water temperature	Evaporator inlet water temperature	Evaporator inlet water temperature	Evaporator inlet water temperature
J3-1	B5	NTC	Evaporator outlet water temperature	Evaporator outlet water temperature	Evaporator 1 outlet water temperature	Evaporator 1 outlet water temperature
J3-3	B6	NTC	--	--	Evaporator 2 outlet water temperature	Evaporator 2 outlet water temperature
J6-1	B7	NTC	Condenser water temperature	Condenser water temperature	Condenser water temperature	Condenser water temperature
J6-3	B8	NTC	--	--	Condenser water temperature	Condenser water temperature
<b>Analog output</b>						
J4-3	Y1	0..10 V	--	--	--	--
J4-4	Y2	0..10 V	--	--	--	--
J4-5	Y3	PWM	--	--	--	--
J4-6	Y4	PWM	--	--	--	--
<b>Digital input</b>						
J5-1	ID1	24 Vac/Vdc	High-pressure alarm triggered by pressure sensor	High-pressure alarm triggered by pressure sensor	High-pressure alarm triggered by pressure sensor - circ. 1	High-pressure alarm triggered by pressure sensor - circ. 1
J5-2	ID2	24 Vac/Vdc	--	--	High-pressure alarm triggered by pressure sensor - circ. 2	High-pressure alarm triggered by pressure sensor - circ. 2
J5-3	ID3	24 Vac/Vdc	Low-pressure alarm triggered by pressure	Low-pressure alarm triggered by pressure	High-pressure alarm triggered by pressure	High-pressure alarm triggered by pressure



			sensor	sensor	sensor - circ. 1	sensor - circ. 1
J5-4	ID4	24 Vac/Vdc	--	--	High-pressure alarm triggered by pressure sensor - circ. 2	High-pressure alarm triggered by pressure sensor - circ. 2
J5-5	ID5	24 Vac/Vdc	Compressor thermal alarm	Compressor thermal alarm	Compressor thermal alarm - circ 1	Compressor thermal alarm - circ 1
J5-6	ID6	24 Vac/Vdc	--	--	Compressor thermal alarm - circ 2	Compressor thermal alarm - circ 2
J5-7	ID7	24 Vac/Vdc	Thermal alarm pump 1	Thermal alarm pump 1	Thermal alarm pump 1	Thermal alarm pump 1
J5-8	ID8	24 Vac/Vdc	Thermal alarm pump 2	Thermal alarm pump 2	Thermal alarm pump 2	Thermal alarm pump 2
J7-1	ID9	24 Vac/Vdc	Water flow switch alarm	Water flow switch alarm	Water flow switch alarm	Water flow switch alarm
J7-2	ID10	24 Vac/Vdc	--	--	--	--
J7-3	ID11	24 Vac/Vdc	Phase direction alarm	Phase direction alarm	Phase direction alarm	Phase direction alarm
J7-4	ID12	24 Vac/Vdc	Remote On/Off	Remote On/Off	Remote On/Off	Remote On/Off
J8-2	ID13	24 Vac/Vdc	Summer/Winter Changeover	Summer/Winter Changeover	Summer/Winter Changeover	Summer/Winter Changeover
J8-4	ID14	24 Vac/Vdc	Serious alarm/secondary setpoint	Serious alarm/secondary setpoint	Serious alarm/secondary setpoint	Serious alarm/secondary setpoint
<b>Digital output</b>						
J12-2	NO1	NO relay	Compr. ON/OFF 1	Compr. ON/OFF 1	Compr.1 ON/OFF (Circ.1)	Compr.1 ON/OFF (Circ.1)
J12-3	NO2	NO relay	--	Compr. ON/OFF 2	Compr.2 ON/OFF (Circ.2)	Compr.2 ON/OFF (Circ.1)
J12-4	NO3	NO relay	--	--	--	Compr.3 ON/OFF (Circ.2)
J13-2	NO4	NO relay	--	--	--	Compr.4 ON/OFF (Circ.2)
J13-3	NO5	NO relay	Pump 1 ON/OFF	Pump 1 ON/OFF	Pump 1 ON/OFF	Pump 1 ON/OFF
J13-4	NO6	NO relay	Pump 2 ON/OFF	Pump 2 ON/OFF	Pump 2 ON/OFF	Pump 2 ON/OFF
J14-2	NO7	NO relay	Antifreeze heating element ON/OFF	Antifreeze heating element ON/OFF	Antifreeze heating element ON/OFF	Antifreeze heating element ON/OFF
J15-1	NO8	NO relay	General alarm	General alarm	General alarm	General alarm
J16-2	NO9	NO relay	--	--	--	--
J16-3	NO10	NO relay	Cycle Reversing Valve	Cycle Reversing Valve	Cycle Reversing Valve - circ.1	Cycle Reversing Valve - circ. 1
J16-4	NO11	NO relay	--	--	Cycle Reversing Valve - circ.2	Cycle Reversing Valve - circ.2
J17-1	NO12	NO relay	--	--	--	--
J18-1	NO13	NO relay	Unit ON/OFF	Unit ON/OFF	Unit ON/OFF	Unit ON/OFF

• **Freecooling**

Freecooling – pCO1			Description			
Conn.	Name	Signal	1 Circuit 1 Compressor	1 Circuit 2 Compressors	2 Circuits 2 Compressors	2 Circuits 4 Compressors
<b>Analog input</b>						
J2-1	B1	4..20 mA / 0-5V	Condensation Pressure	Condensation Pressure	Condensation Pressure circ.1	Condensation Pressure circ.1
J2-2	B2	4..20 mA / 0-5V	--	--	Condensation Pressure circ.2	Condensation Pressure circ.2
J2-3	B3	4..20 mA	Remote Setpoint adjustment	Remote Setpoint adjustment	Remote Setpoint adjustment	Remote Setpoint adjustment
J3-3	B4	NTC	Evaporator inlet water temperature	Evaporator inlet water temperature	Evaporator inlet water temperature	Evaporator inlet water temperature
J3-1	B5	NTC	Evaporator outlet water temperature	Evaporator outlet water temperature	Evaporator 1 outlet water temperature	Evaporator 1 outlet water temperature
J3-3	B6	NTC	--	--	Evaporator 2 outlet water temperature	Evaporator 2 outlet water temperature
J6-1	B7	NTC	Outdoor air temperature	Outdoor air temperature	Outdoor air temperature	Outdoor air temperature
J6-3	B8	NTC	Freecooling Temperature	Freecooling Temperature	Freecooling Temperature	Freecooling Temperature
<b>Analog output</b>						
J4-3	Y1	0..10 V	Condensation fan control	Condensation fan control	Condensation fan control - 1	Condensation fan control - 1
J4-4	Y2	0..10 V	--	--	Condensation fan control - 2	Condensation fan control - 2

J4-5	Y3	PWM	Condensation fan control	Condensation fan control	Condensation fan control - 1	Condensation fan control - 1
J4-6	Y4	PWM	--	--	Condensation fan control - 2	Condensation fan control - 2
<b>Digital input</b>						
J5-1	ID1	24 Vac/Vdc	High-pressure alarm triggered by pressure sensor	High-pressure alarm triggered by pressure sensor	High-pressure alarm triggered by pressure sensor - circ. 1	High-pressure alarm triggered by pressure sensor - circ. 1
J5-2	ID2	24 Vac/Vdc	--	--	High-pressure alarm triggered by pressure sensor - circ. 2	High-pressure alarm triggered by pressure sensor - circ. 2
J5-3	ID3	24 Vac/Vdc	Low-pressure alarm triggered by pressure sensor	Low-pressure alarm triggered by pressure sensor	High-pressure alarm triggered by pressure sensor - circ. 1	High-pressure alarm triggered by pressure sensor - circ. 1
J5-4	ID4	24 Vac/Vdc	--	--	High-pressure alarm triggered by pressure sensor - circ. 2	High-pressure alarm triggered by pressure sensor - circ. 2
J5-5	ID5	24 Vac/Vdc	Compressor thermal alarm	Compressor thermal alarm	Compressor thermal alarm - circ 1	Compressor thermal alarm - circ 1
J5-6	ID6	24 Vac/Vdc	--	--	Compressor thermal alarm - circ 2	Compressor thermal alarm - circ 2
J5-7	ID7	24 Vac/Vdc	Thermal alarm pump 1	Thermal alarm pump 1	Thermal alarm pump 1	Thermal alarm pump 1
J5-8	ID8	24 Vac/Vdc	Thermal alarm pump 2	Thermal alarm pump 2	Thermal alarm pump 2	Thermal alarm pump 2
J7-1	ID9	24 Vac/Vdc	Water flow switch alarm	Water flow switch alarm	Water flow switch alarm	Water flow switch alarm
J7-2	ID10	24 Vac/Vdc	General fan alarm	General fan alarm	General fan alarm - 1	General fan alarm - 1
J7-3	ID11	24 Vac/Vdc	Phase direction alarm	Phase direction alarm	Phase direction alarm	Phase direction alarm
J7-4	ID12	24 Vac/Vdc	Remote On/Off	Remote On/Off	Remote On/Off	Remote On/Off
J8-2	ID13	24 Vac/Vdc	--	--	General fan alarm - 2	General fan alarm - 2
J8-4	ID14	24 Vac/Vdc	Serious alarm/secondary setpoint	Serious alarm/secondary setpoint	Serious alarm / secondary setpoint	Serious alarm / secondary setpoint
<b>Digital output</b>						
J12-2	NO1	NO relay	Compr. ON/OFF 1	Compr. ON/OFF 1	Compr.1 ON/OFF (Circ.1)	Compr.1 ON/OFF (Circ.1)
J12-3	NO2	NO relay	--	Compr. ON/OFF 2	Compr.2 ON/OFF (Circ.2)	Compr.2 ON/OFF (Circ.1)
J12-4	NO3	NO relay	--	--	--	Compr.3 ON/OFF (Circ.2)
J13-2	NO4	NO relay	--	--	--	Compr.4 ON/OFF (Circ.2)
J13-3	NO5	NO relay	Pump 1 ON/OFF	Pump 1 ON/OFF	Pump 1 ON/OFF	Pump 1 ON/OFF
J13-4	NO6	NO relay	Pump 2 ON/OFF	Pump 2 ON/OFF	Pump 2 ON/OFF	Pump 2 ON/OFF
J14-2	NO7	NO relay	Antifreeze heating element ON/OFF	Antifreeze heating element ON/OFF	Antifreeze heating element ON/OFF	Antifreeze heating element ON/OFF
J15-1	NO8	NO relay	General alarm	General alarm	General alarm	General alarm
J16-2	NO9	NO relay	Fans ON/OFF	Fans ON/OFF	Fans ON/OFF	Fans ON/OFF
J16-3	NO10	NO relay	Opening of 3-way valve (FC)	Opening of 3-way valve (FC)	Opening of 3-way valve (FC)	Opening of 3-way valve (FC)
J16-4	NO11	NO relay	Closing of 3-way valve (FC)	Closing of 3-way valve (FC)	Closing of 3-way valve (FC)	Closing of 3-way valve (FC)
J17-1	NO12	NO relay	Coil capacity control solenoid valve On/Off	Coil capacity control solenoid valve On/Off	Coil capacity control solenoid valve circ. 1 and 2 On/Off	Coil capacity control solenoid valve circ. 1 and 2 On/Off
J18-1	NO13	NO relay	Unit ON/OFF	Unit ON/OFF	Unit ON/OFF	Unit ON/OFF

## 8.2.2 pCOXS

### • Cooling Only

Cooling Only– pcoXS			Water / Air		Water / Water	
Conn.	Name	Signal	1 Circuit 1 Compressor	1 Circuit 2 Compressors	1 Circuit 1 Compressor	1 Circuit 2 Compressors
<b>Analog input</b>						
J2-2	B1	4..20mA / 0-5V / NTC	Condensation Pressure	Condensation Pressure	Condensation Temperature	Condensation Temperature
J2-3	B2	---	-- / Remote setpoint adjustment / outdoor temp. sensor	-- / Remote setpoint adjustment / outdoor temp. sensor	-- / Remote setpoint adjustment / outdoor temp. sensor	-- / Remote setpoint adjustment / outdoor temp. sensor

J2-4	B3	NTC	Evaporator inlet water temperature	Evaporator inlet water temperature	Evaporator inlet water temperature	Evaporator inlet water temperature
J2-5	B4	NTC	Evaporator outlet water temperature	Evaporator outlet water temperature	Evaporator outlet water temperature	Evaporator outlet water temperature
<b>Analog Output</b>						
J3-1	Y1	0..10 V	Fan control	Fan control	---	---
J3-2	Y2	0..10 V	---	---	---	---
J3-3	Y3	PWM	Fan control	Fan control	---	---
<b>Digital Input</b>						
J4-1	ID1	No-voltage contact	---	---	---	---
J4-2	ID2	No-voltage contact	Water flow switch alarm	Water flow switch alarm	Water flow switch alarm	Water flow switch alarm
J4-3	ID3	No-voltage contact	High-pressure alarm triggered by pressure sensor	High-pressure alarm triggered by pressure sensor	High-pressure alarm triggered by pressure sensor	High-pressure alarm triggered by pressure sensor
J4-4	ID4	No-voltage contact	Low-pressure alarm triggered by pressure sensor	Low-pressure alarm triggered by pressure sensor	Low-pressure alarm triggered by pressure sensor	Low-pressure alarm triggered by pressure sensor
J4-5	ID5	No-voltage contact	Remote On/Off	Remote On/Off	Remote On/Off	Remote On/Off
J4-6	ID6	No-voltage contact	Serious alarm / Secondary Setpoint	Serious alarm / Secondary Setpoint	Serious alarm / Secondary Setpoint	Serious alarm / Secondary Setpoint
<b>Digital Output</b>						
J9-2	NO1	NO relay	Compressor 1	Compressor 1	Compressor 1	Compressor 1
J9-3	NO2	NO relay	Electric heating element	Compressor 2	Electric heating element	Compressor 2
J9-4	NO3	NO relay	Pump ON/OFF	Pump ON/OFF	Pump ON/OFF	Pump ON/OFF
J10-2	NO4	NO relay	---	---	---	---
J11-1	NO5	NO relay	Global alarm / Serious alarm / Non-serious alarm	Global alarm / Serious alarm / Non-serious alarm	Global alarm / Serious alarm / Non-serious alarm	Global alarm / Serious alarm / Non-serious alarm

• Heat pump

Heat Pump – pcoXS			Water / Air		Water / Water	
Conn.	Name	Signal	1 Circuit 1 Compressor	1 Circuit 2 Compressors	1 Circuit 1 Compressor	1 Circuit 2 Compressors
<b>Analog input</b>						
J2-2	B1	4..20mA / 0-5V / NTC	Condensation Pressure	Condensation Pressure	Condensation Temperature	Condensation Temperature
J2-3	B2	---	-- / Remote setpoint adjustment / outdoor temp. sensor	-- / Remote setpoint adjustment / outdoor temp. sensor	-- / Remote setpoint adjustment / outdoor temp. sensor	-- / Remote setpoint adjustment / outdoor temp. sensor
J2-4	B3	NTC	Evaporator inlet water temperature	Evaporator inlet water temperature	Evaporator inlet water temperature	Evaporator inlet water temperature
J2-5	B4	NTC	Evaporator outlet water temperature	Evaporator outlet water temperature	Evaporator outlet water temperature	Evaporator outlet water temperature
<b>Analog Output</b>						
J3-1	Y1	0..10 V	Fan control	Fan control	---	---
J3-2	Y2	0..10 V	---	---	---	---
J3-3	Y3	PWM	Fan control	Fan control	---	---
<b>Digital Input</b>						
J4-1	ID1	No-voltage contact	Summer/Winter Changeover	Summer/Winter Changeover	Summer/Winter Changeover	Summer/Winter Changeover
J4-2	ID2	No-voltage contact	Water flow switch alarm	Water flow switch alarm	Water flow switch alarm	Water flow switch alarm
J4-3	ID3	No-voltage contact	High-pressure alarm triggered by pressure sensor	High-pressure alarm triggered by pressure sensor	High-pressure alarm triggered by pressure sensor	High-pressure alarm triggered by pressure sensor
J4-4	ID4	No-voltage contact	Low-pressure alarm triggered by pressure sensor	Low-pressure alarm triggered by pressure sensor	Low-pressure alarm triggered by pressure sensor	Low-pressure alarm triggered by pressure sensor
J4-5	ID5	No-voltage contact	Remote On/Off	Remote On/Off	Remote On/Off	Remote On/Off
J4-6	ID6	No-voltage contact	Serious alarm / Secondary Setpoint	Serious alarm / Secondary Setpoint	Serious alarm / Secondary Setpoint	Serious alarm / Secondary Setpoint
<b>Digital Output</b>						
J9-2	NO1	NO relay	Compressor 1	Compressor 1	Compressor 1	Compressor 1

J9-3	NO2	NO relay	Electric heating element	Compressor 2	Electric heating element	Compressor 2
J9-4	NO3	NO relay	Pump ON/OFF	Pump ON/OFF	Pump ON/OFF	Pump ON/OFF
J10-2	NO4	NO relay	4-way valve	4-way valve	4-way valve	4-way valve
J11-1	NO5	NO relay	Global alarm / Serious alarm / Non-serious alarm	Global alarm / Serious alarm / Non-serious alarm	Global alarm / Serious alarm / Non-serious alarm	Global alarm / Serious alarm / Non-serious alarm

### 8.3 INPUT/OUTPUT OVERRIDE

Once the function for overriding the inputs/outputs of the electronic controller have been enabled (*Maintenance menu* → *Manual Control* → *M1*), they can be manually set from the *Inputs/Outputs menu* → *I/O Override*.

Below is an example of how digital inputs are overridden

```

t_io_forz_14
+-----+
DIGITAL OUTPUTS      Ee
      Override
NO1 : AUTO  ↕
NO2 : AUTO  ↕
NO3 : AUTO  ↕
NO4 : MAN   ↕
NO5 : MAN   ↓
+-----+

```

The “Override” column shows the logical value that will be used for the respective digital output. In this example only NO4 and NO5 are actually overridden since the “MAN” (manual) option has been selected. In the other cases the value of the outputs will depend on the control logic.

# 9 SUPERVISION

## 9.1 MAIN PARAMETERS

The configuration of the supervision logic can be set from the *User menu* → *LAN and Supervision* → *J6* and involves defining:

- communication protocol
- communication speed
- serial address of the unit

You can select from among the following Communication Protocols:

- Carel RS485 (Local Supervisor Protocol for communication with Carel supervision systems)
- Modbus
- LonWorks
- RS 232 (analog modem)
- GSM (GSM modem)

Communication Speed (baud rate)

- 1200 baud
- 2400 baud
- 4800 baud (only speed possible with LonWorks network)
- 9600 baud
- 19200 baud

Address of peripheral unit in the network

- 1..200

## 9.2 CONNECTION WITH CAREL / MODBUS PROTOCOL

The connection for supervision with the Carel or Modbus protocol is achieved via an RS485 (Figure 30) serial card, available on request in the pCO controller

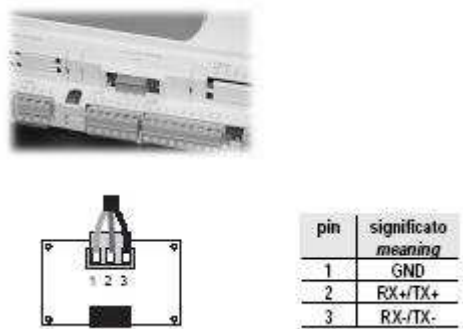
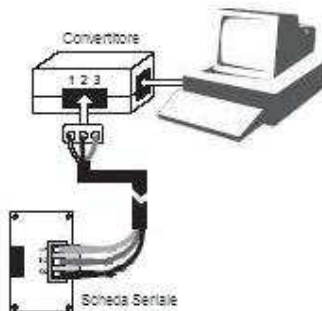
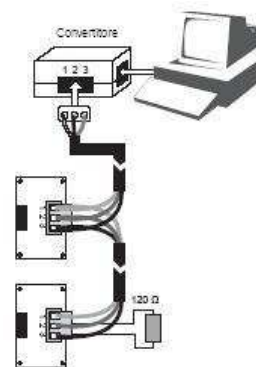

Figure 30: RS485 Serial Card

In order to make a connection to the supervisor terminal, the unit must be connected to an RS485/RS232 converter (or similar device) using a suitable cable (2 wires + shield AWG22-24) and then from the converter to the computer itself.



1 unit under supervision



2 or more units under supervision

## 9.3 CONNECTION WITH LONWORKS PROTOCOL

A connection can be made to the LonWorks network using the connector with extractable terminals, provided on request on the circuit board (Figure 31) as an alternative to the one used for the Carel and Modbus protocols:

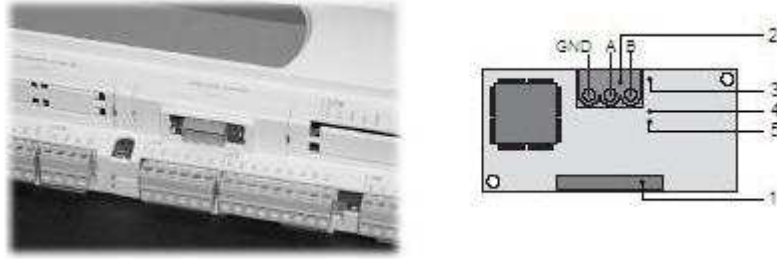

Figure 31: LON card

1. connector for connection to pCO;
2. terminals for connection to LonWorks (GND, A, B);
3. service pin;
4. Green service LED;
5. Red fault warning LED.

To activate the service pin it is sufficient to short circuit the two pins for an instant using the tip of a screwdriver or similar means. Activation will be signalled by the lighting up of the service LED.

The service LED:

- signals the status of the node as per the LonWorks protocol;
- remains lit during activation of the service pin;
- remains lit for one second on receiving a WINK command from the network.

The fault warning LED signals the impossibility of connecting on the pCO side. If the red fault warning LED lights up, check whether the baud rate of the serial communication with the pCO is set on 4800.

The physical connection to the LonWorks network must be made as per LonWorks instructions and specifications.

## 9.4 GSM PROTOCOL

Selecting the GSM protocol will enable the user to send and receive SMS messages to and from GSM phones, thanks to the aid of a GSM Modem.

The following will thus be managed:

- Alarm messages
- info messages concerning the unit's status
- info messages concerning the parameters that can be set via GSM
- parameter setting messages

### 9.4.1 Alarm Message

If an alarm occurs in the Master unit or any unit connected to the LAN, a message will be sent to the configured phone number. The message will contain the following information:

- Unit in alarm status (U1..U4)
- Software application installed in the chiller
- Inlet and outlet water temperatures (or where 2 evaporators are present, the average temperature as shown on the main screen)
- Circuit pressures
- Alarm description
- Alarm date and time

**EX: Text of SMS message received:** V: CS 1.00 D:05/07 IN: 09.7C OUT: 07.6C Press1: 15.2bars Press2: 14.9bars  
Alarm Unit:01 Al.from Dig. Input 18:36 08/03/07

**Meaning:**

- Unit 1
- Alarm present: Alarm from Digital Input
- Inlet water temperature: 9.7°C
- Evaporator 1 outlet temperature. 7.6°C

- Circuit 1 pressure: 15.2bars
- Circuit 2 pressure: 14.9bars
- Software version installed: CS 1.00
- Software date: May '07

## 9.4.2 Unit Status Message

By sending a specific message to the unit installed with a modem it is possible to receive information about a chiller connected to the LAN. The information given in this message is:

- Number of the unit queried
- Operating status
- Alarm info
- Active setpoint
- Inlet and outlet water temperatures
- Circuit pressures

**EX: Text of SMS message:** Unit 1 Status:OFF Sup No Alarm SETPOINT: 10.0°C IN: 09.3°C OUT1: 07.5°C OUT2: ---  
'C Pres.1: 15.2bars Pres.2:14.7bars

**Meaning:**

- Information regarding unit 1
- Status: Off, determined by supervisor
- No alarm present
- Active setpoint = 10°C
- Inlet water temperature: 9.3°C
- Evaporator 1 outlet temperature. 7.5°C
- Evaporator 2 not present
- Circuit 1 pressure: 15.2bars
- Circuit 2 pressure: 14.7bars

## 9.4.3 Main Parameters Message

By sending a specific message to the unit installed with a modem it is possible to receive information about the parameters set on the Master unit and which can be edited via GSM. The information given in this message is:

- Setpoints
- Differentials

**ES: Text of SMS message:** Cool.Setp.:01.5°C Heat.Setp.:40.0°C Cool.Diff.:04.0°C Heat.Diff.:03.0°C  
2ndCool.Setp.:15.0°C 2ndHeat.Setp.:30.0°C

**Meaning:**

- Cooling Setpoint: 1.5°C
- Heating Setpoint: 40°C (Heat Pumps only)
- Cooling Differential: 4°C
- Heating Differential: 3°C(Heat Pumps only)
- Secondary Cooling Setpoint: 15°C
- Secondary Heating Setpoint: 30°C (Heat Pumps only)

## 9.4.4 Parameter Configuration Message

By sending correctly formatted SMS messages to the unit installed with a modem (the formatting procedure will be illustrated below), it is possible to set several chiller control parameters or activate the transmission of information. The table below shows the variables concerned, along with the type and address.

<b>Type</b>	<b>Address</b>	<b>Description</b>
D	1	On/Off via Supervisor
D	2	Summer/Winter changeover via Supervisor
D	50	request sending of message on status of selected unit
D	51	request sending of message with parameters via GSM
A	1	selection of unit for information retrieval
A	31	setpoint - cooling [°Cx10]
A	32	setpoint - heating [°Cx10]
A	33	setpoint differential - cooling [°Cx10]
A	34	setpoint differential - heating [°Cx10]
A	35	secondary setpoint - cooling [°Cx10]
A	36	secondary setpoint - heating [°Cx10]

The configuration message must be formatted as follows:

**.<header>.<password>.<type 1>.<address 1>.<value 1>....<type N>.<address N>.<value N>&**

where:

**header** = type of microcontroller (e.g.: pCO1)

**password** = modem password (modem configuration parameter set from User menu->LAN and Supervision ). It must be composed of 4 characters

**i<sup>th</sup> type** = type of the i<sup>th</sup> variable to be set. 'A' if analog, 'I' if integer, 'D' if digital.

**i<sup>th</sup> address** = address of the i<sup>th</sup> variable to be set. It must be composed of 3 characters

**i<sup>th</sup> value** = value to be assigned to the i<sup>th</sup> variable. It must be composed of 6 characters. (in the case of negative values the '-' symbol must be used in place of the first character; for digital variables the accepted values are 000000 or 000001)

**&** = message closing character

**Important:**

- the maximum number of parameters that can be set with a single message is 11
- There must be no spaces present in the message
- the message must start off with a '.'
- Each field must be separated by a '.'
- The message must end with the character '&' but it must not be preceded by a dot.

Let's see some examples:

1. To receive information on the status of unit 1, it is necessary to send a message in which the analog variable "selection of unit for information retrieval" is set as 1 and the digital variable "request sending of message on status of selected unit" is likewise set as 1. Assuming that the modem password has not been set, the message must be configured as follows:

**.pCO1.0000.A.001.000001.D.050.000001&**

Tipo:	Indirizzo	Descrizione
A	1	selezione unità per recupero informazioni

Tipo:	Indirizzo	Descrizione
D	50	richiesta invio messaggio stato unità selezionata

the reply message will be sent only to the phone number specified in the modem settings.

2. To receive a message containing the values of the control parameters editable via GSM it is necessary to send an SMS message configured as follows:

**.pCO1.0000.D.051.000001&**

Tipo:	Indirizzo	Descrizione
D	51	richiesta invio messaggio con parametri via GSM

3. You can send a message to set some control parameters (heating setpoint on 10.8°C and cooling differential on 1.5°C) and request another message to be sent reporting the values of these parameters (previous example)



**.pCO1.0000.A.033.000015.A.032.000108.D.051.000001&**

Tipo:	Indirizzo	Descrizione
A	32	setpoint - riscaldamento [°Cx10]
A	33	differenziale setpoint - raffreddamento [°Cx10]

Tipo:	Indirizzo	Descrizione
D	51	richiesta invio messaggio con parametri via GSM

4. You can send a message to switch on the unit (via the supervisor) in the heating mode and request a message to be sent reporting the unit's status.

**.pCO1.0000.D.002.000001.D.001.000001.A.001.000001.D.050.000001&**

Tipo:	Indirizzo	Descrizione
D	1	On/Off da Supervisione
D	2	Estate/Inverno da Supervisione

Tipo:	Indirizzo	Descrizione
A	1	selezione unità per recupero informazioni

Tipo:	Indirizzo	Descrizione
D	50	richiesta invio messaggio stato unità selezionata

5. You can send a message to switch off the unit and receive a message reporting the unit's status

**.pCO1.0000.D.001.000000.A.001.000001.D.050.000001&**

Tipo:	Indirizzo	Descrizione
D	1	On/Off da Supervisione

Tipo:	Indirizzo	Descrizione
A	1	selezione unità per recupero informazioni

Tipo:	Indirizzo	Descrizione
D	50	richiesta invio messaggio stato unità selezionata

**NB:** both ON/OFF switching and the configuration of setpoints and differentials are operations that can be performed only on the unit in which the modem kit is installed. In the case of LAN systems, this will have to be the Master unit and therefore these settings will not be propagated to the other units as well. However, as it is the Master unit which controls the entire system, the slave units will also be impacted by the new setting, with the exception of On/Off switching.

## 9.4.5 Software configuration

The configuration of the GSM protocol and of the modem are given in the *User menu* → *LAN and Supervision* → *J6-J7*. It is first necessary to set the type of protocol to be used:

- Communication protocol: GSM
- Communication speed: bps

Then the modem options:

- Number of rings
- Number of the mobile phone to which SMS messages will be sent
- Password for blocking incoming messages

## 9.4.6 Modem Configuration

The chiller that will be installed with the modem kit must be configured with the address pLAN 1; therefore, in the case of a LAN system, this unit will have to be the Master.



The SIM used in the GSM Modem requires the following steps to be carried out:

- Enable the data transfer function
- Disable the prompt to enter the PIN
- Delete all messages present
- Insert the SIM card in the modem using the holder provided.

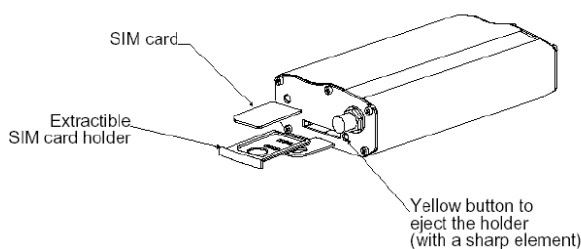

This kit requires the installation of an RS232 card in the pCO controller in order to make the connection with the kit itself. The card will have to be inserted in the only seat provided for a Serial Card.



## 9.4.7 Modem status

In the *Chiller Status menu* → *Devices* → *A8* you can find an indication as to the modem status.

## 9.5 OTHER SUPERVISION PROTOCOLS

Configuring the microcontroller with the Carel protocol allows the chiller to be interfaced with other types of networks using suitable serial cards.

Below is a list of the possible cards and the corresponding protocols supported:

- BACnet on RS485



(pCO Net)

- BACnet and SNTP on Ethernet network.



(pCO Web)

- Trend



## 9.6 LIST OF VARIABLES UNDER SUPERVISION

### Digital Variables

DIGITAL VARIABLES	TYPE	R/W	CAREL ADDRESS	MODBUS ADDRESS
On-Off via Supervisor	D	R/W	1	1
Sel. Summer/Winter changeover via Supervisor	D	R/W	2	2
DIN-High pressure from pressure switch – Circ 1	D	R	11	11
DIN-High pressure from pressure switch – Circ 2	D	R	12	12
DIN-Low pressure from pressure switch – Circ 1	D	R	13	13
DIN-Low pressure from pressure switch – Circ 2	D	R	14	14
DIN-Compressor thermal alarm - Circ 1	D	R	15	15
DIN-Compressor thermal alarm - Circ 2	D	R	16	16
DIN-Thermal alarm pump 1	D	R	17	17
DIN-Thermal alarm pump 2	D	R	18	18
DIN-Water flow switch alarm	D	R	19	19
DIN-Fan alarm series 1	D	R	20	20
DIN-Phase direction alarm	D	R	21	21
On_Off via Digital Input	D	R	22	22
Summer/Winter changeover via Input	D	R	23	23
DIN-Configurable input	D	R	24	24
Compressor 1	D	R	31	31
Compressor 2	D	R	32	32
Compressor 3	D	R	33	33
Compressor 4	D	R	34	34
Compressor 5	D	R	35	35
Compressor 6	D	R	36	36
Compressor 7	D	R	37	37
Compressor 8	D	R	38	38
Circuit 1 running	D	R	39	39
Circuit 1 running	D	R	40	40
Pump 1	D	R	41	41
Pump 2	D	R	42	42
Fans Series 1	D	R	43	43
Fans Series 2	D	R	44	44
Heating element	D	R	45	45
4-way valve – Circ 1	D	R	46	46
4-way valve – Circ 2	D	R	47	47
FC valve opening	D	R	48	48
FC valve closing	D	R	49	49
Configurable Alarm indication	D	R	50	50
Defrost Circ 1	D	R	56	56
Defrost Circ 2	D	R	57	57
Summer/Winter Mode	D	R	58	58
Chiller On	D	R	59	59
High Pressure Prevention Circ 1	D	R	60	60
High Pressure Prevention Circ 1	D	R	61	61
General alarm	D	R	62	62
Freecooling Status	D	R	63	63
Freecooling Valve Status	D	R	64	64
Freecooling Valve Override	D	R	65	65
Alarm from Digital Input	D	R	71	71
Thermal Alarm Pump 1	D	R	72	72
Thermal Alarm Pump 2	D	R	73	73
Evaporator Water Flow Alarm	D	R	74	74
Inlet Temp. Sensor Alarm	D	R	75	75
Outlet Water Temp. Sensor Alarm - Evaporator 1	D	R	76	76
Outlet Water Temp. Sensor Alarm - Evaporator 2	D	R	77	77
Press. Sensor Alarm – Circuit 1	D	R	78	78
Press. Sensor Alarm – Circuit 2	D	R	79	79

Freecooling Temp. Sensor Alarm	D	R	80	80
Setpoint Adjustment Sensor Alarm	D	R	81	81
Outdoor Temp. Sensor Alarm	D	R	82	82
Low Pressure Alarm - Circuit 1	D	R	83	83
Low Pressure Alarm - Circuit 2	D	R	84	84
High Pressure Alarm - Circuit 1	D	R	85	85
High Pressure Alarm - Circuit 2	D	R	86	86
Low Press. Alarm from Sensor – Circuit 1	D	R	87	87
Low Press. Alarm from Sensor – Circuit 2	D	R	88	88
High Press. Alarm from Sensor – Circuit 1	D	R	89	89
High Press. Alarm from Sensor – Circuit 2	D	R	90	90
Compressor Thermal Alarm - Circuit1	D	R	91	91
Compressor Thermal Alarm - Circuit2	D	R	92	92
Fan Thermal Alarm – Series 1	D	R	93	93
Fan Thermal Alarm – Series 2	D	R	94	94
Maintenance Threshold Exceeded - Pump 1	D	R	95	95
Maintenance Threshold Exceeded - Pump 2	D	R	96	96
Phase Direction Alarm	D	R	97	97
Antifreeze Alarm – Evaporator 1	D	R	98	98
Antifreeze Alarm – Evaporator 2	D	R	99	99
Maintenance Threshold Exceeded Compr.1	D	R	100	100
Maintenance Threshold Exceeded Compr.2	D	R	101	101
Maintenance Threshold Exceeded Compr.3	D	R	102	102
Maintenance Threshold Exceeded Compr.4	D	R	103	103
Maintenance Threshold Exceeded Compr.5	D	R	104	104
Maintenance Threshold Exceeded Compr.6	D	R	105	105
Maintenance Threshold Exceeded Compr.7	D	R	106	106
Maintenance Threshold Exceeded Compr.8	D	R	107	107
Clock Malfunction	D	R	108	108
Freecooling Fault	D	R	109	109
DRV 1: Automatic/Manual mode	D	R	110	110
DRV 2: Automatic/Manual mode	D	R	111	111
DRV 1: Low SH	D	R	112	112
DRV 2: Low SH	D	R	113	113
DRV 1: HtCond.	D	R	114	114
DRV 2: HtCond.	D	R	115	115
DRV 1: LOP	D	R	116	116
DRV 2: LOP	D	R	117	117
DRV 1: MOP	D	R	118	118
DRV 2: MOP	D	R	119	119
Outlet Water Temp. Sensor Alarm - Condenser 1	D	R	120	120
Outlet Water Temp. Sensor Alarm - Condenser 2	D	R	121	121

## Analog Variables

VARIABLE	TYPE	R/W	CAREL ADDRESS	MODBUS ADDRESS
Condensation Pressure – Circ 1	A	R	1	1
Condensation Pressure – Circ 2	A	R	2	2
Inlet Water Temperature	A	R	3	3
Outlet Water Temperature – Evaporator 1	A	R	4	4
Outlet Water Temperature – Evaporator 2	A	R	5	5
Outdoor Temperature	A	R	6	6
Freecooling Temperature	A	R	7	7
Active Setpoint	A	R	8	8
Condensation Ctrl Setp.	A	R	9	9
Condensation Ctrl Diff.	A	R	10	10
Evaporation Ctrl Setp.	A	R	11	11
Evaporation Ctrl Diff.	A	R	12	12
Min setpoint - Cooling	A	R	13	13
Max setpoint - Cooling	A	R	14	14

Min setpoint - Heating	A	R	15	15
Max setpoint - Heating	A	R	16	16
Setpoint Adjustment	A	R	17	17
Setpoint - Cooling	A	R/W	31	31
Setpoint - Heating	A	R/W	32	32
Control Band - Cooling	A	R/W	33	33
Control Band - Heating	A	R/W	34	34
Secondary Setpoint - Cooling	A	R/W	35	35
Secondary Setpoint - Heating	A	R/W	36	36
Setpoint in time zone - Cooling	A	R/W	37	37
Setpoint outside time zone - Cooling	A	R/W	38	38
Setpoint in time zone - Heating	A	R/W	39	39
Setpoint outside time zone - Heating	A	R/W	40	40
DRV 1: SuperHeat	A	R	100	100
DRV 2: SuperHeat	A	R	101	101
DRV 1: Superheating time	A	R	102	102
DRV 2: Superheating time	A	R	103	103
DRV 1: Evaporation press.	A	R	104	104
DRV 2: Evaporation press.	A	R	105	105
DRV 1: Saturat. evap. temp.	A	R	106	106
DRV 2: Saturat. evap. temp.	A	R	107	107
DRV 1: Cond.temp.	A	R	108	108
DRV 2: Cond.temp.	A	R	109	109

### Integer Variables

VARIABLE	TYPE	R/W	CAREL ADDRESS	MODBUS ADDRESS
Unit Status	I	R	1	129
Running hours Compressor 1 - H	I	R	2	130
Running hours Compressor 1 - L	I	R	3	131
Running hours Compressor 2 - H	I	R	4	132
Running hours Compressor 2 - L	I	R	5	133
Running hours Compressor 3 - H	I	R	6	134
Running hours Compressor 3 - L	I	R	7	135
Running hours Compressor 4 - H	I	R	8	136
Running hours Compressor 4 - L	I	R	9	137
Running hours Compressor 5 - H	I	R	10	138
Running hours Compressor 5 - L	I	R	11	139
Running hours Compressor 6 - H	I	R	12	140
Running hours Compressor 6 - L	I	R	13	141
Running hours Compressor 7 - H	I	R	14	142
Running hours Compressor 7 - L	I	R	15	143
Running hours Compressor 8 - H	I	R	16	144
Running hours Compressor 8 - L	I	R	17	145
Running hours Pump 1 - H	I	R	18	146
Running hours Pump 1 - L	I	R	19	147
Running hours Pump 2 - H	I	R	20	148
Running hours Pump 2 - L	I	R	21	149
Analog Output Y1	I	R	22	150
Analog Output Y2	I	R	23	151
Analog Output Y3	I	R	24	152
Analog Output Y4	I	R	25	153
DRV 1: Cooling, Heating or Defrost mode	I	R	100	228
DRV 2: Cooling, Heating or Defrost mode	I	R	101	229
DRV 1: Valve position	I	R	102	230
DRV 2: Valve position	I	R	103	231
DRV 1: Capacity required (%)	I	R	104	232
DRV 2: Capacity required (%)	I	R	105	233

# 10 LAN

## 10.1 LAN LOGIC (USER MENU -> LAN AND SUPERVISION )

(User menu → LAN and Supervision → J3)

### 10.1.1 Control Logic

Connecting a number of chillers in a LAN (up to a maximum of 4, of the same type) makes it possible to adopt a logic whereby thermal demands are distributed in a more efficient manner than when each chiller simply works on its own with its own temperature measurements and setpoints.

The two different control strategies of the control logic are:

- **Step Control**
- **Cascade**

Based on the number of units present in the LAN and the total number of compressors, the Master unit computes the control steps within the temperature range defined by the programmed setpoint and differential.

Specifically, in the Step Control mode, the logic used will switch on the compressors, based on the growing demand for resources, as it interrogates the units from time to time; in the Cascade mode, on the other hand, another chiller will be called into action only when running the compressors of all the units already active is not sufficient.

For greater clarity, below we illustrate the control logics by means of an example.

### Example

- 2 units connected
- 2 compressors per unit
- Total cooling steps = 4
- MASTER Setpoint (unit 1) = 12°C
- MASTER differential band (unit 1) = 4°C
- MASTER hysteresis (unit 1) = 100%



### • STEP CONTROL

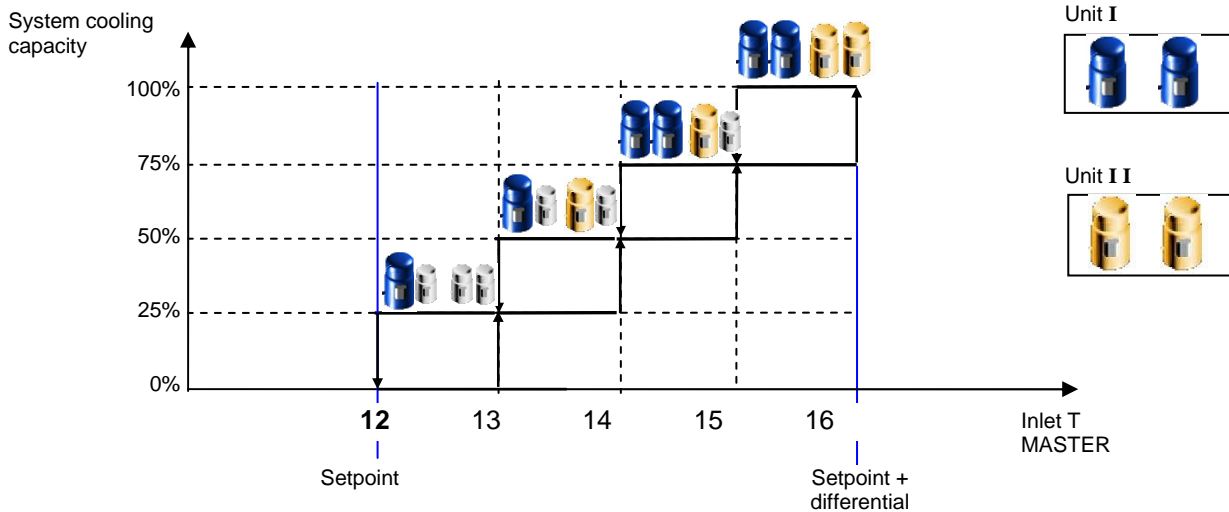

In the overall operation of the system, the passage from 0% to 100% will see the switching on, in sequence, of: 1<sup>st</sup> compressor of unit I, 1<sup>st</sup> of unit II, 2<sup>nd</sup> of unit I, 2<sup>nd</sup> of unit II.

- CASCADE**

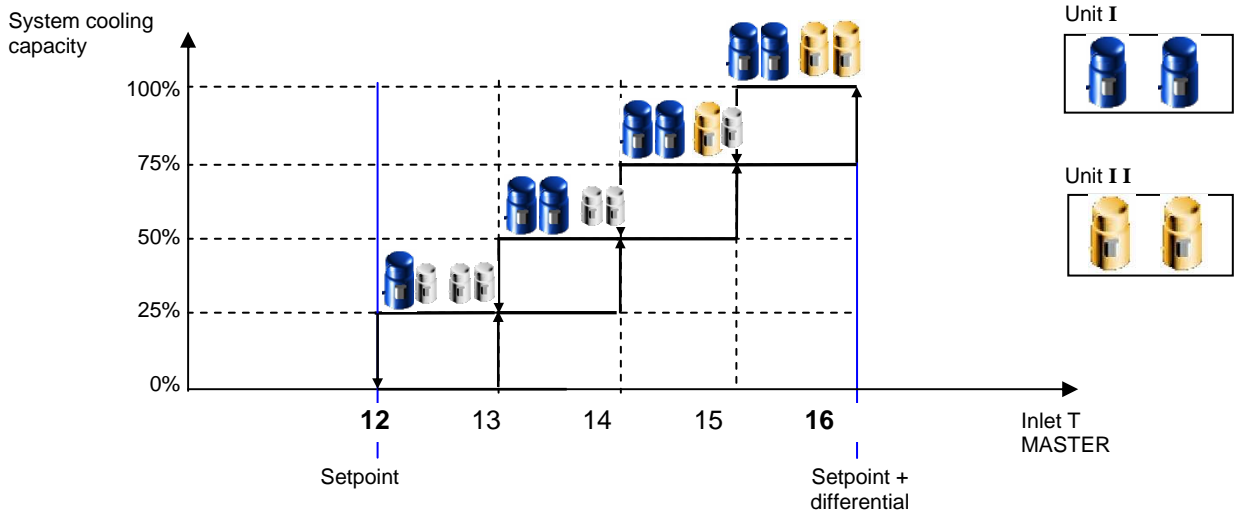

In the overall operation of the system, the passage from 0% to 100% will see the switching on, in sequence, of: 1<sup>st</sup> and 2<sup>nd</sup> compressors of unit I ; 1<sup>st</sup> and 2<sup>nd</sup> compressors of unit II.

### 10.1.2 Rotation Logic

In addition to the two logics adopted to divide the duty loads between units, you can also select which type of rotation to adopt. When the rotation function is active, the unit identified as “I” in the previous examples will not necessarily be the chiller having the LAN address 1 but will rather be the first unit in the list of priorities, as defined on each occasion by the rotation logic.

The 3 rotation options are (*User menu → LAN and Supervision → J4*):

- No Rotation**

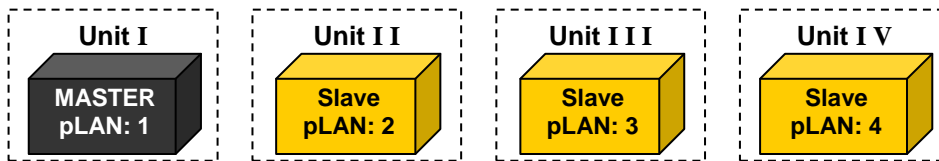

- Standard Rotation**

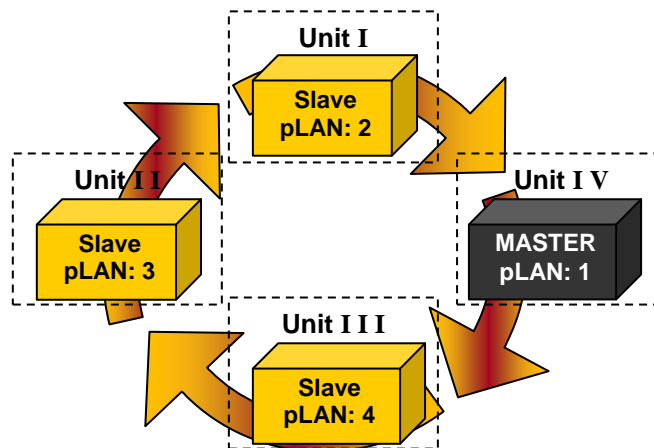

- **Rotation with Stand-by**

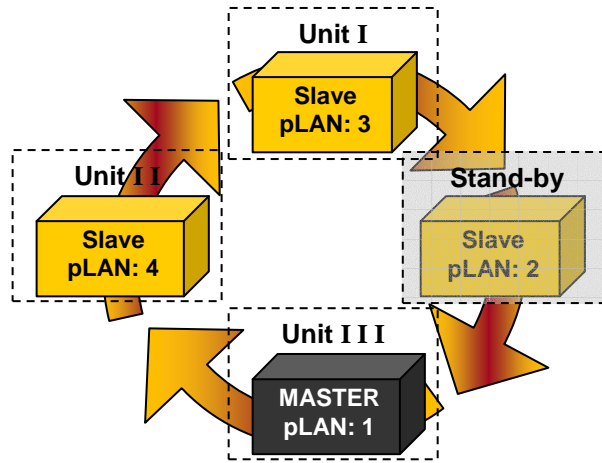

Unlike the standard rotation mode, rotation with standby provides for one of the chillers controlled by the LAN logic to be placed on standby by the Master. This status implies that both compressors and pump will be switched off.

If the Master unit is the one on standby, the inlet water temperature used to govern the system will be computed as the average value of the other units.

### 10.1.3 LAN dynamics

The Master constantly monitors the LAN to adapt the control functions to changes in the number of available units. If a chiller is disconnected from the LAN due to:

- an interruption in the serial connection
- switching off of the unit by means of the keys
- disabling of the LAN logic
- a serious alarm

the Master will re-compute the number of compressors to be switched on based on the control band and the number of compressors available. If a serious alarm has caused the unit to be cut off from the LAN (and placed back in a stand-alone status), the Master will disable the rotation with stand-by logic, if this option was selected, and switch to a standard rotation logic.

The Master unit continues to perform its control function for the entire system unless it is physically disconnected or the LAN logic is disabled. In such cases the other units will likewise resume operation on a stand-alone basis.

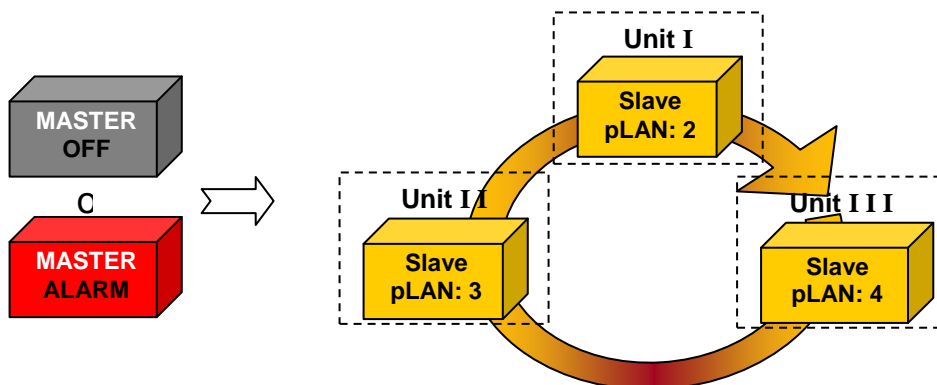

## 10.2 SYSTEM CONFIGURATION

The steps to be carried out to set up the system correctly according to the LAN logic are as follows:

1. Set the addresses of the various units connected to the LAN
2. Physically connect the units together
3. Enable and configure the LAN logic in the various units
4. Switch on the units concerned

Each individual step will be analysed in depth here below.



## 10.2.1 Address Settings

In order to define a LAN network, you must set the addresses of the elements making it up.

The maximum logic is defined as the case of 4 interconnected units plus a shared remote display terminal; below we provide a table of reference for assigning the respective addresses.

	List of Addresses	
	pCO address	Display Terminal Address
<b>Unit 1</b>	1	25
<b>Unit 2</b>	2	26
<b>Unit 3</b>	3	27
<b>Unit 4</b>	4	28
<b>Shared display</b>	-	32

**Table 1 – LAN addresses**

### Example1

Description: 2 units with 2 private displays

- pCO of unit 1

```

+-----+
|P:01 Adr Priv/Shared|
|Trm1 25 Pr          |
|Trm2 None --       |
|Trm3 None -- Ok?No |
+-----+

```

- pCO of unit 2

```

+-----+
|P:02 Adr Priv/Shared|
|Trm1 26 Pr          |
|Trm2 None --       |
|Trm3 None -- Ok?No |
+-----+

```

### Example 2

Description: 2 units with 1 private display each and a shared display terminal

- pCO of unit 1

```

+-----+
|P:01 Adr Priv/Shared|
|Trm1 25 Pr          |
|Trm2 32 Sh          |
|Trm3 None -- Ok?No |
+-----+

```

- pCO of unit 2

```

+-----+
|P:02 Adr Priv/Shared|
|Trm1 26 Pr          |
|Trm2 32 Sh          |
|Trm3 None -- Ok?No |
+-----+

```

The unit's pLAN address will also be shown on the main screen

```

main
+-----+
|U1 08:00 01/01/00|
|IN 12.0°C|
|OUT 12.5°C|
|OFF by Keyboard|
+-----+

```

## 10.2.2 Electrical Connection

**Type of Connection:** serial line

**Connection Cable:** two wires + shield AWG22-24

**Connector:**

- pCO1: J11 ( Rx-/Tx- , Rx+/Tx+, GND)
- pCO XS:J6 ( Rx-/Tx- , Rx+/Tx+, GND)

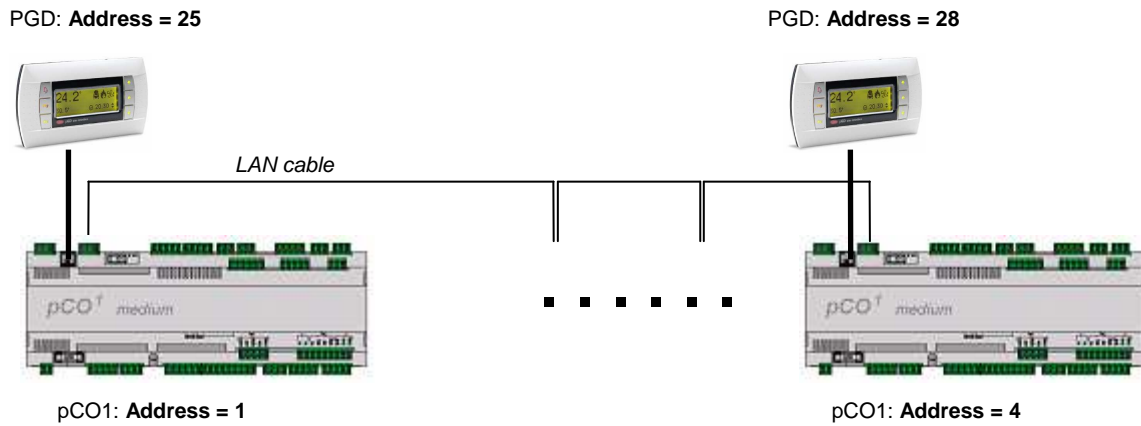

**10.2.3 Configuration of LAN Application**

- Enable the LAN function : select “yes” for the parameter shown in the following mask of the (*User menu → LAN and Supervision → J3*) in all units. (NB: this parameter can be changed only when the chiller is OFF)

```

t_user_lan_3
+-----+
| LAN LOGIC           J3 |
| Enable : no        |
+-----+
  
```

- Configure the LAN function (*User menu → LAN and Supervision → J3*) in the Master unit (unit with address = 1) by setting:

- Control Logic

```

t_user_lan_3
+-----+
| LAN LOGIC           J3 |
| Enable : no        |
| Switch ON Logic:   |
| Cascade            |
+-----+
  
```

- Rotation time

```

t_user_lan_4
+-----+
| LAN LOGIC           J4 |
| LAN Units rotation |
| -> standard        |
| Rotat. time: 0000 h |
+-----+
  
```

- o Management of non-simultaneous compressor start-ups

```

t_user_lan_5
+-----+
| LAN MANAGEMENT FOR J5 |
| STARTUP COMPRESSORS |
| Delay 000s |
+-----+

```

where the Delay represents the time that elapses between compressor starts enabled by the Master unit in response to simultaneous requests.

### 10.2.4 LAN Status

An immediate indication of the LAN status of the chiller can be found at the top of the main screen.

```

main
+-----+
| U1 08:00 01/01/00 |
| IN 14.0°C |
| OUT 12.5°C |
| * ON |
+-----+

```

This indication will be present in the Master unit once the LAN has been enabled (see 10.2.3); in the Slave units it will be present only if the presence of the Master unit is detected.

**NB:** We shall again note that a unit can function as Master if:

- o its address is pLAN 1
- o it has enabled the LAN logic

More detailed indications can be found in the *Chiller Status menu* → LAN → C1 where it is possible to view the LAN status.

```

t_sm_lan_01
+-----+
| pLAN C1 |
| Unit 1:Off Line |
| Unit 2:Off Line |
| Unit 3:Off Line |
| Unit 4:Off Line |
+-----+

```

The possible indications for each unit making up the system are:

- o *Unit 'k': Off Line* : the unit with the kth address is not present in the system or is not connected to the chiller you are working on
- o *Unit 'k': On Line Alone.*: the unit with the kth address is connected via the LAN to the chiller you are working on but is operating in the Stand-Alone mode
- o *Unit 'k': On Line Master/Slave*: the unit with the kth address is connected via the LAN to the chiller you are working on and has the function of Master or Slave

### 10.2.5 Switching on Units

Unlike in the case of Stand Alone operation, where units are connected in a LAN it will only be possible to choose the operating mode (Cooling – Heating) for the Master unit. For the other units, the operating mode will be displayed but it will not be possible to change it since all units will work according to the mode set on the Master unit.

If the Master unit is turned on at a later time and in the meanwhile has been switched to a different mode than that applied up to that time across the system, this will automatically cause the other units to go into a temporary standby status, after which they will be switched on again with the new operating mode selected.

An indication of the mode transmitted by the Master unit to the Slave units can be found in the *Chiller Status menu* → LAN → C3

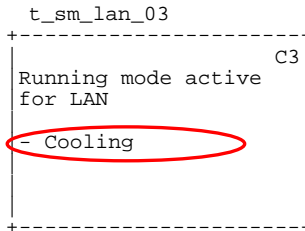

## 10.2.6 Shared Display Terminal

In addition to correctly configuring the pLAN address, in order to assure correct use of the shared display terminal it is necessary to set the latter as "Shared" in each chiller making up the LAN (see 5.3).

The physical connection can be made as when connecting a simple remote terminal to one of the chillers in the network.

From the shared terminal you can access the different chillers by keeping the **Esc** key pressed down and repeatedly pressing the  key. If a chiller goes into an alarm status the shared terminal will automatically display the parameters of that specific unit.

# 11 ADVANCED OPTIONS

## 11.1 LOW LOAD LOGIC

(Manufacturer's menu → Parameters → Tw-Tx )

This logic provides for an increase in the control differential in low load situations (often tied to a configuration without storage reservoir), considered such when a single compressor is running and is switched off before a certain time threshold has elapsed. Once active, this reference threshold for maintaining the condition will be recomputed as follows:

$$\text{threshold}' = \frac{\text{threshold set by user} \quad \bullet \quad \text{low load differential}}{\text{standard differential}}$$

The causes leading this logic to be deactivated are:

- the single compressor remains on beyond the control threshold ( threshold' )
- more than one compressor is switched on

The Low Load Logic can be configured with the following parameters:

- enable Low Load logic
- select mode (you can choose whether to use this low load logic in one or more chiller operating modes)
- control threshold
- differentials with Low Load Logic enabled

**EX:**

- operation in Cooling Mode only
- Differential: 4°
- Low Load Differential: 6°

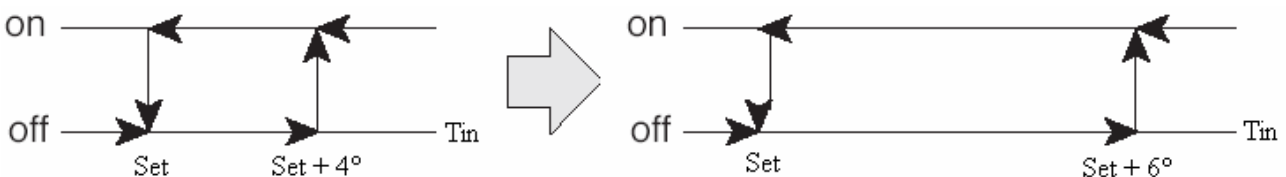

**EX:**

- Heat Pump operation
- Differential: 4°
- Low Load Differential: 6°

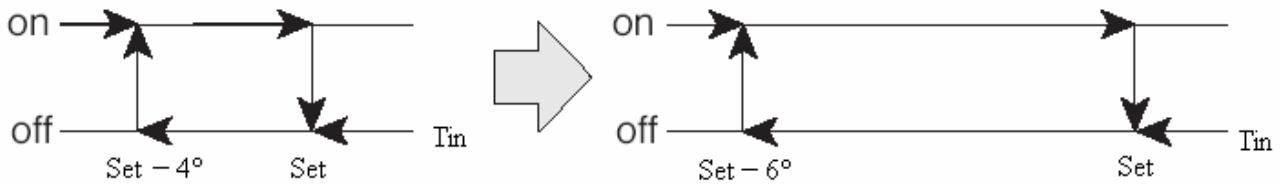

## 11.2 HIGH PRESSURE PREVENTION FUNCTION

This function, which can be selected in the *Manufacturer's menu* → *Alarms* → *Ue*, serves to prevent the circuits from being shut down due to the tripping of a high-pressure alarm.

The parameters are:

- setpoint (bars)
- differential (bars)
- delay time (s)

The function consists in inhibiting the operation of one compressor in the circuit concerned in order to prevent the unit from running at full capacity. The compressor inhibited changes each time the prevention function is activated.

When the condensation pressure exceeds the activation value (setpoint) this logic is used until the pressure falls below the deactivation value (setpoint – differential).

**Prevention of High Pressure Alarm**

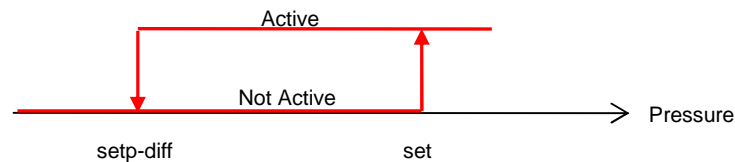

A delay time is set to prevent the logic from being activated in cases where the pressure falls below the deactivation threshold before the set time has elapsed.

In the case of a single-compressor circuit it is also necessary to configure the number of prevention attempts that must be made before the function itself is disabled (*Manufacturer's menu* → *Alarms* → *Uf*). This is because inhibiting the operation of the sole compressor will have the effect of switching off and on the entire circuit (though the fans will continue to run according to their control logic for conditions under pressure).

The number of attempts will be reset as soon as the compressor is switched off under normal chiller control conditions, indicating that correct operation has resumed.

## 11.3 ELECTRONIC VALVE

To each unit it is possible to connect (internally) up to 2 EVD400 drivers for controlling the electronic valves, one for each cooling circuit.



Two different types of drivers can be used, based on the connection with the electronic controller; each involves a specific hardware configuration. A detailed description of the two solutions is provided below.

## 11.3.1 EVD 400 – tLAN

### 11.3.1.1 Address setting

The drivers must be configured with a specific tLAN address

Driver	Address
Driver for circuit 1	1
Driver for circuit 2	2

the address can be configured using the “EDV4-UI address” application, after connecting the PC to the driver. The connection is made by means of a suitable converter

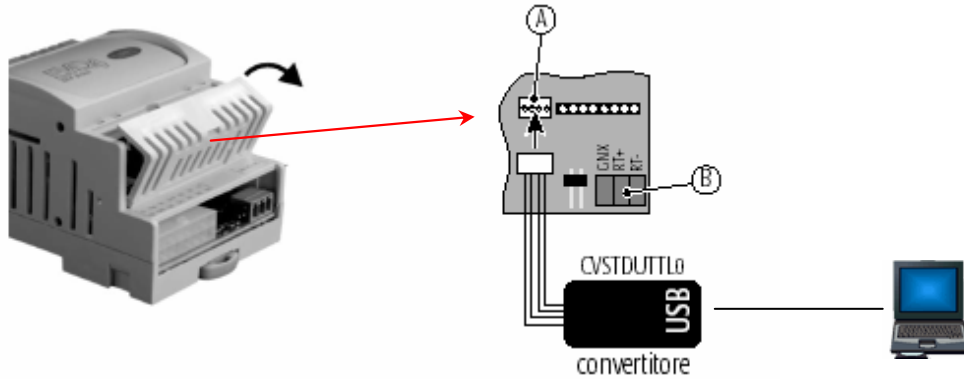

Alternatively, the driver can be configured using a programming key.

**NB:** since the tLAN connection is independent of the pLAN connection, even in the case of chillers linked together in a network the driver addresses of individual chillers will always be the same (this does not apply in the case of EVD in pLAN).

### 11.3.1.2 Physical Connection

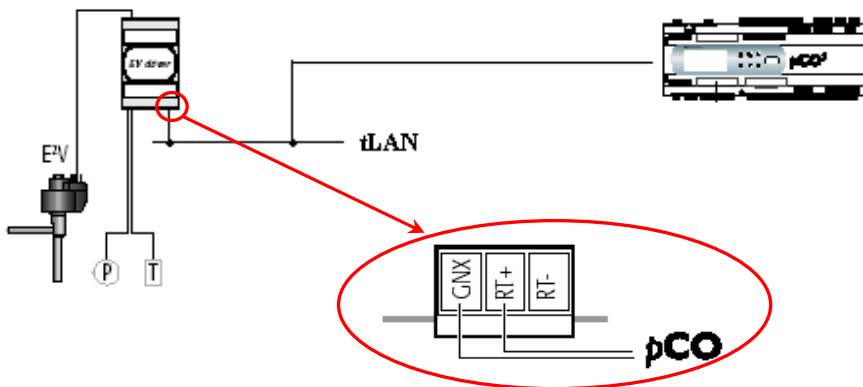
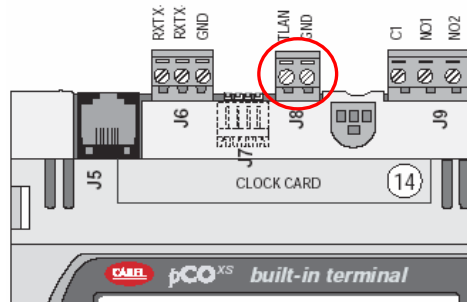
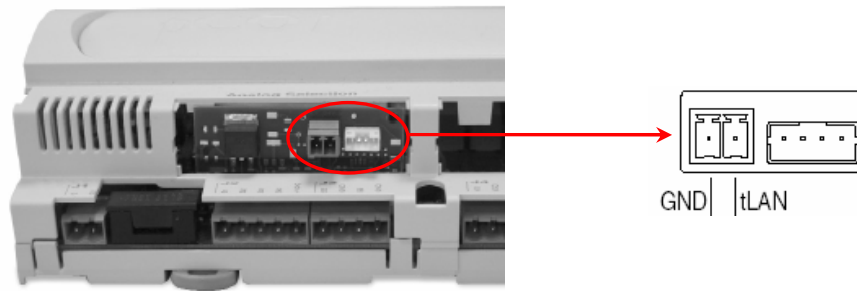

Figure 32 Connection between EVD400 and pCO1

Whereas a tLAN connector (J8) is already present for pCOXS controllers



in the case of pCO1 controllers it is necessary to install a specific tLAN serial card, to be used for the connection to the EVD400



## 11.3.2 EVD 400 – pLAN

### 11.3.2.1 Address setting

Where the pLAN connection is used both to connect the drivers to the controller and to connect any units to be controlled via a LAN logic, the EVD 400 address will depend on the address of the pCO to which the drivers are connected.

A reference table is provided below

	Addresses			
	Address pCO	Address Driver EVD1	Address Driver EVD2	Address 10 Display
	<i>Config. via display</i>	<i>Config. via PC or key</i>	<i>Config. via PC or key</i>	<i>Config. via display</i>
<b>Unit 1</b>	1	5	6	25
<b>Unit 2</b>	2	7	8	26
<b>Unit 3</b>	3	9	10	27
<b>Unit 4</b>	4	11	12	28

The configuration must be made using the “EDV4-UI address” application as for the t-LAN version.

### 11.3.2.2 Physical Connection

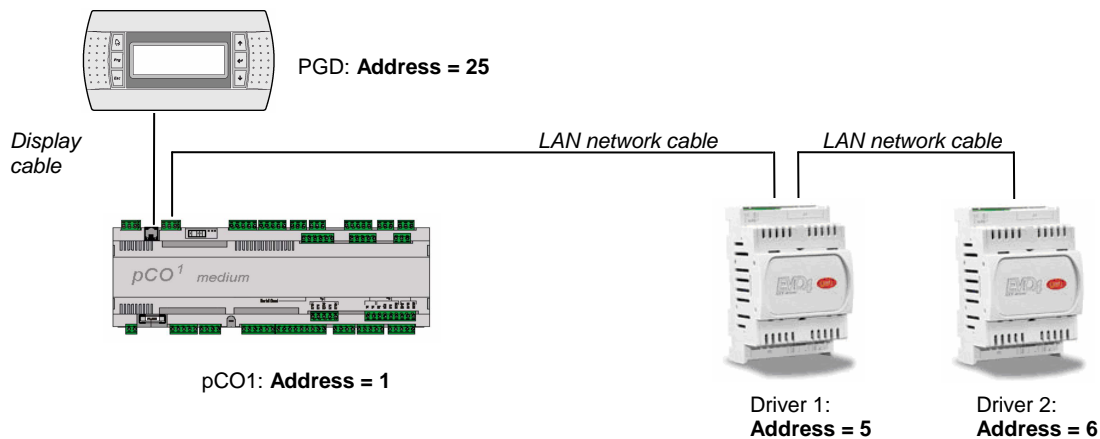

## 11.3.3 Software Management

Once the driver addresses have been configured and the drivers connected to the pCO controller, from the display it will be possible to configure and completely monitor the operation of the electronic valves.

### Unit Valve Configuration

From the *Manufacturer's menu* → *Unit Config.* → *Sg-Si* it is necessary to set:

- Number of Drivers installed : 0-2
- Type of connection used: tLAN – pLAN
- Type of Sensors used for control purposes
- PID Control Direction: Direct – Reverse
- Valve Type: Carel, Sporlan
- Battery enabling

## Configuration of Valve Parameters

From the *Manufacturer's menu* → *Carel EXV Drivers* it is necessary to configure:

- **Main Parameters**
  - Steps in Stand-by
  - Sensor working range
  - Alarm Delay Times
- **Autosetup Parameters**
  - percentage of opening at start-up
  - type of compressors and capacity control
  - type of evaporator
  - saturation temperature thresholds
  - alarm thresholds

Advanced parameters are also present for custom configuration of driver functions in the 3 possible operating modes:

- Chiller
- Pump
- Defrost

## Valve Management

The valve operating status can be viewed in the *Chiller Status menu* → *Elect. Valve*

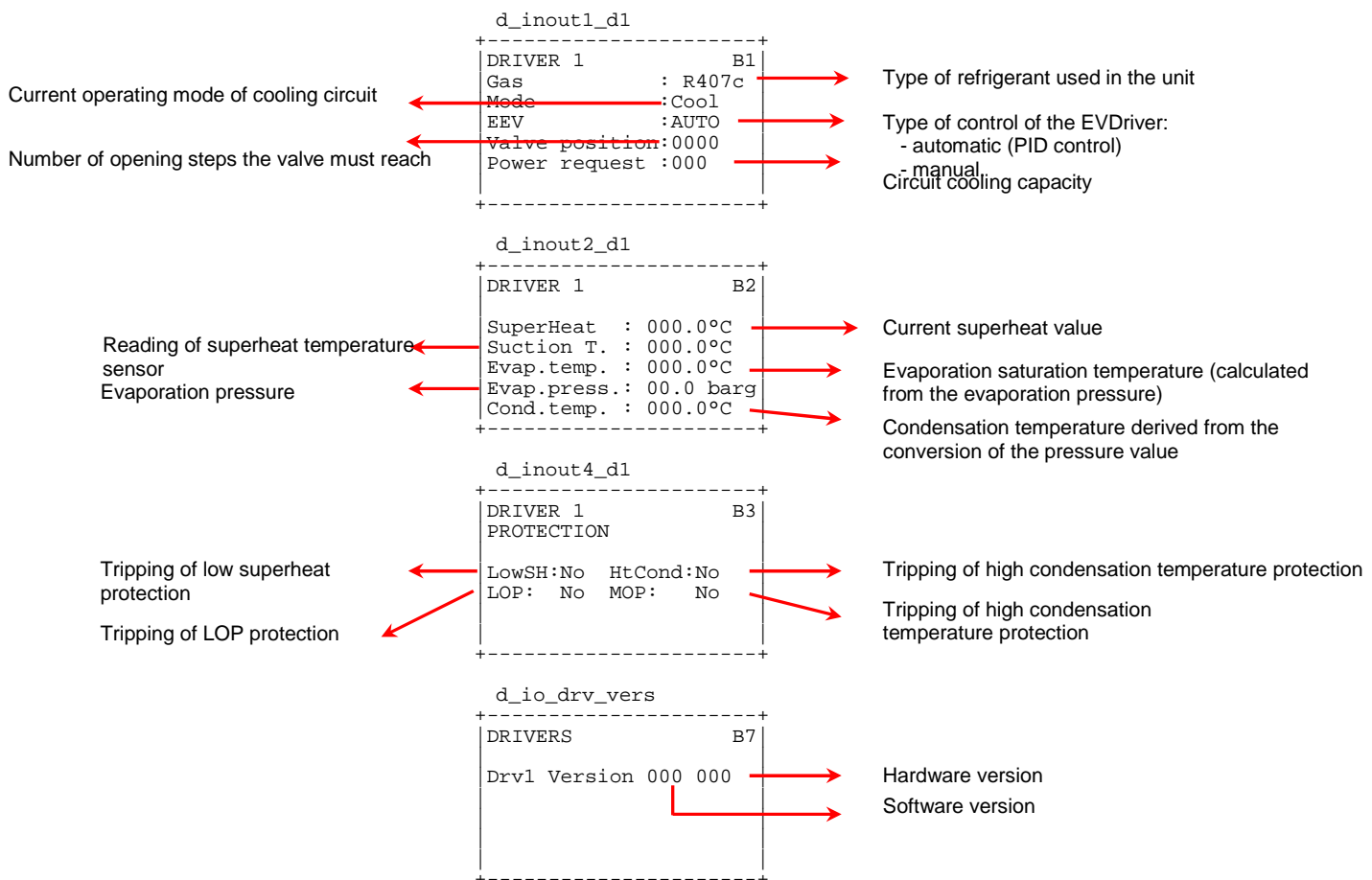



It is also possible to manually override valve settings from the screens of *Maintenance menu* → *Manual Control*

```
d_manual_d1
+-----+
| MANUAL CONTROL      M4 |
| DRIVER 1           |
|                   |
| EEV Mode           AUTO |
| Requested steps    0000 |
| EEV Position       0000 |
+-----+
```

By selecting MAN you can set the required valve steps

Valve steps requested in manual operation

Number of opening steps the valve must reach, read-only value

Any valve faults will be indicated in the next screen, along with the options for managing them.

```
d_gohead_d1
+-----+
| DRIVER 1 STATUS    M5 |
|                   |
| No Warnings        |
+-----+
```





