



MONO SYSTEM



Leister Technologies AG
Galileo-Strasse 10
CH-6056 Kaegiswil/Switzerland

Tel. +41 41 662 74 74
Fax +41 41 662 74 16

www.leister.com
sales@leister.com

	Size	3	
	Wiring Diagram	4	
D	Deutsch	Bedienungsanleitung	5
GB	English	Operating Instructions	13
I	Italiano	Istruzioni d'uso	21
F	Français	Instructions d'utilisation	29
E	Espanol	Instrucciones de funcionamiento	37
P	Português	Manual de instruções	45
TR	Türkçe	Kullanım Kılavuzu	53
CZ	Česky	Návod k obsluze	61
RUS	Русский	Инструкция по эксплуатации	69
CN	中文	使用手册	77
J	日本語	取扱説明書	85

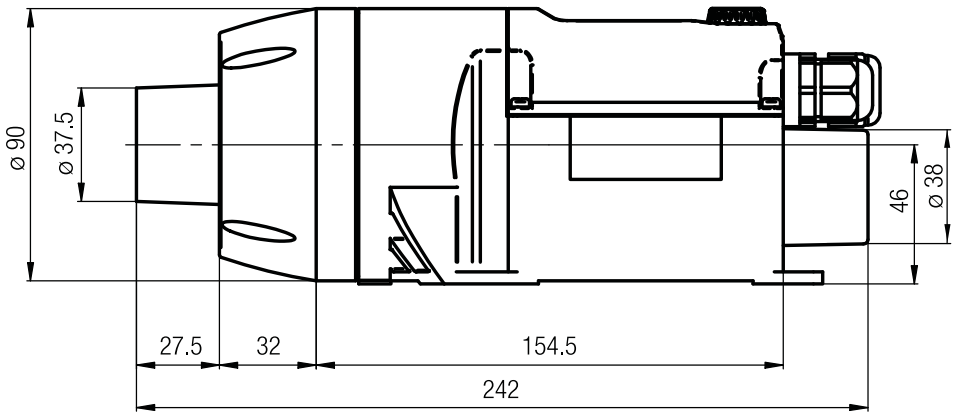
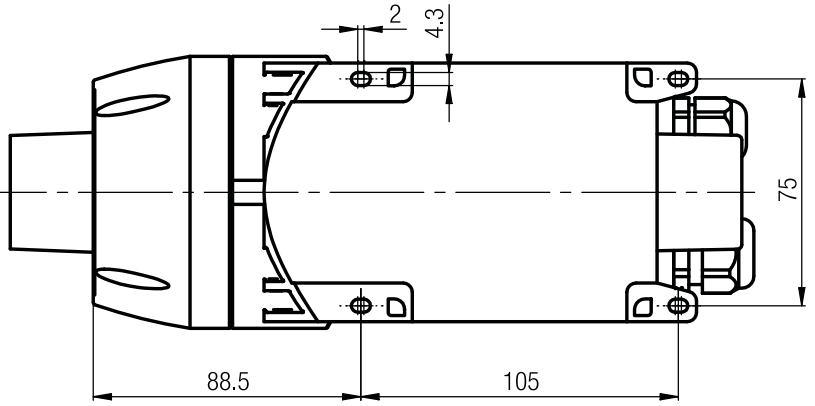

Wiring diagram

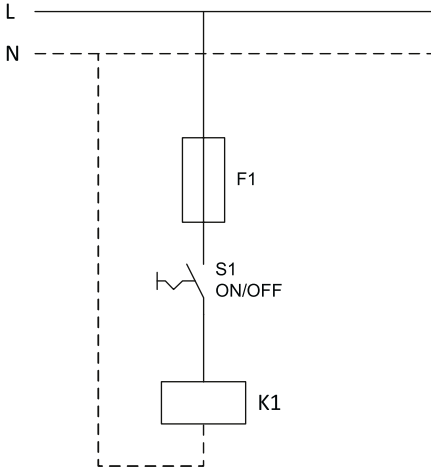

Input 0 - 10V

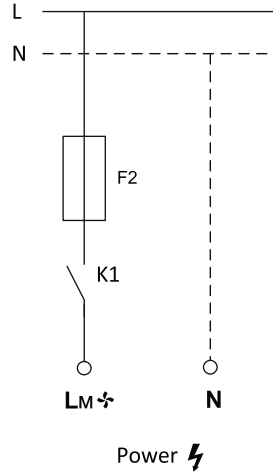

Input 4 - 20mA

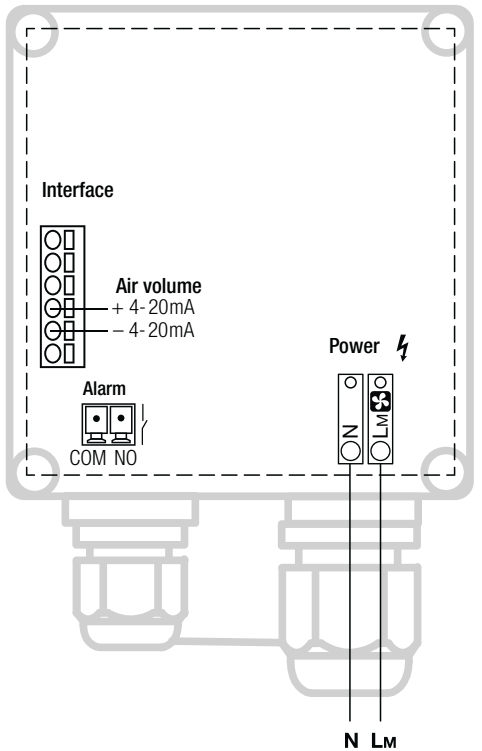
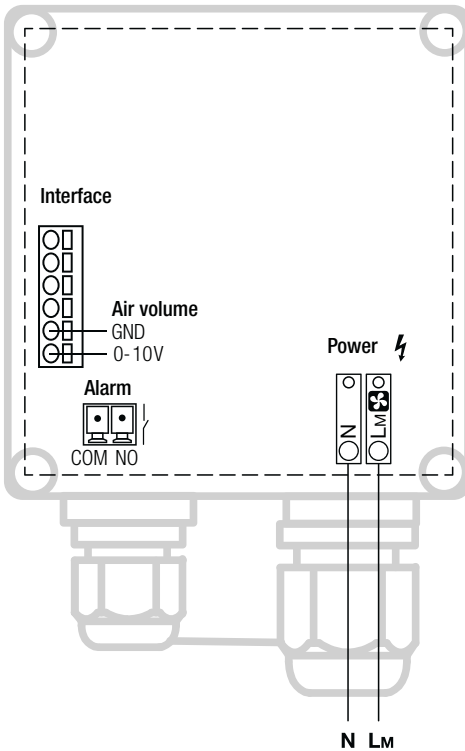



Bedienungsanleitung vor Inbetriebnahme aufmerksam lesen und zur weiteren Verfügung aufbewahren.

Hochdruck-Gebläse MONO SYSTEM

Anwendung

Das Leister Gebläse MONO eignet sich für den Einbau in Maschinen, Anlagen oder Geräte und ist für den wartungsfreien Dauerbetrieb ausgelegt.

- Luftversorgung von Leister Lufterhitzern, für Frischluftzufuhr und zum Kühlen.
- Ist geeignet zur Förderung von Luft, nicht brennbaren, nicht aggressiven und nicht explosiven Gasen.



Warnung



Lebensgefahr beim Öffnen des Gerätes, da spannungsführende Komponenten und Anschlüsse freigelegt werden. Vor dem Öffnen des Gerätes muss dieses allpolig vom Netz getrennt werden.



Vorsicht



Nennspannung, die auf dem Gerät angegeben ist, muss mit der Netzspannung übereinstimmen.



Gerät **muss beobachtet** betrieben werden. Gerät darf nur von **ausgebildeten Fachleuten** oder unter deren Aufsicht benützt werden. Kindern ist die Benützung gänzlich untersagt.



Gerät **vor Feuchtigkeit und Nässe schützen**.

Einbauerklärung

(Im Sinne der EG-Maschinenrichtlinie 2006/42; Anhang II B)

Leister Technologies AG, Galileo-Strasse 10, CH-6056 Kaegiswil/Schweiz erklärt hiermit, dass die unvollständige Maschine

Bezeichnung: **Hochdruck-Gebläse**

Typ: **MONO**

Ausführung: **SYSTEM**

– soweit es vom Lieferumfang her möglich ist – den anwendbaren grundlegenden Anforderungen der EG-Maschinenrichtlinie (2006/42) entspricht.

Die unvollständige Maschine entspricht überdies den Anforderungen der folgenden EG-Richtlinie(n):

EG-Richtlinie(n): Elektromagnetische Verträglichkeit 2004/108

Niederspannungsrichtlinie 2006/95

RoHS-Richtlinie 2011/65

Harmonisierte Normen: EN 12100, EN 55014-1, EN 55014-2, EN 61000-6-2, EN 61000-3-2,

EN 61000-3-3, EN 62233, EN 60335-1, EN 50581

Ferner erklären wir, dass für diese unvollständige Maschine die speziellen technischen Unterlagen gemäss Anhang VII (Teil B) erstellt wurden und verpflichten uns, diese auf begründetes Verlangen den Marktüberwachungsbehörden elektronisch zu übermitteln.

Name des Dokumentationsbevollmächtigten: Volker Pohl, Manager Product Conformity

Die Inbetriebnahme der unvollständigen Maschine wird so lange untersagt, bis gegebenenfalls festgestellt wurde, dass die Maschine, in die die unvollständige Maschine eingebaut wurde, den Bestimmungen der EG-Maschinenrichtlinie (2006/42) entspricht.

Kaegiswil, 24.06.2015

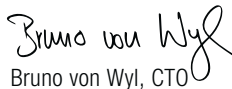
Bruno von Wyl, CTO

Andreas Kathriner, GM

Entsorgung



Elektrowerkzeuge, Zubehör und Verpackungen sollen einer umweltgerechten Wiederverwertung zugeführt werden. **Nur für EU-Länder:** Werfen Sie Elektrowerkzeuge nicht in den Hausmüll! Gemäß der Europäischen Richtlinie 2002/96 über Elektro- und Elektronik-Altgeräte und ihrer Umsetzung in nationales Recht müssen nicht mehr gebrauchsfähige Elektrowerkzeuge getrennt gesammelt und einer umweltgerechten Wiederverwertung zugeführt werden.

Technische Daten

Motorausführung		Bürstenloser Motor	
Spannung	V~	120	230
Leistung	W	120	120
Frequenz	Hz	50 / 60	
Max. Lufteintrittstemperatur	°C	60	
Max. Umgebungstemperatur	°C	65	
Max. Luftmenge (20 °C Umgebung)	l/min.	250 – 600	
Max. Statischer Druck	kPa	3.5	
Emissionspegel	dB(A)	65	
Gewicht	kg	1.0	
Schnittstelle (potentialfrei)		4 – 20 mA & 0 – 10 V für Luftmenge, Alarmausgang	
Masse (Size)		Seite 3	
Konformitätszeichen		 (ErP n/a)	
Schutzklasse II			

Technische Änderungen vorbehalten

Technische Daten Gerätefunktion

MONO 6	SYSTEM
e-Drive-Bedieneinheit	•
Geräteschutz	•
Alarmausgang (Relaiskontakt)	•
Fernsteuer-Schnittstelle für Luftmengenvorgabe	•
Display	•

Technische Daten Schnittstelle

Allgemein	Isolation IEC/EN 60747-5-2	AC 1414 Vpeak
	Verpolungsschutz	
	Nullpunkt Korrektur	
Spannungseingänge	Spannung 0 – 10 V	DC 0...10 V (Rippel < 0.4 V bei 5 % Auflösung)
	Max. Eingangsspannung	DC 12 V
	Nenn- Eingangswiderstand	33.7 kOhm
Stromeingänge	Strom 4–20 mA (2-Leiter Technik)	DC 4...20 mA (Rippel < 0.7 mA bei 5 % Auflösung)
	Max. Eingangsstrom	DC 22 mA
	Nenn- Eingangswiderstand	159 Ohm
Alarmausgang (Relaiskontakt)	Max. Spannungen	AC 250 V, DC 30 V
	Max. Ströme	AC 3 A, DC 3 A
	Max. Kontaktwiderstand	100 mOhm bei DC 24 V / 1 A
	Kontaktart	SPST-NO
	Isolation Kontakt zu Spule	AC 4000 V 1 min.
Isolation Kontakt zu Kontakt	AC 1000 V 1 min.	

Technische Daten Funktionen

e-Drive oder
Schnittstelle

Luftmenge

Luftmengen-Vorgabe 1, 5...100 %;
5 % Auflösung

Temperatur-/Luftmengen-Diagramm

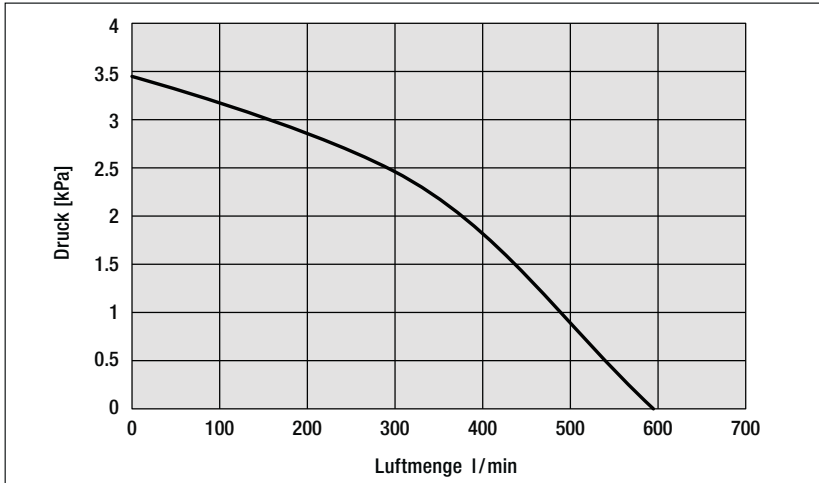

Schnittstelle / Ansteuerung

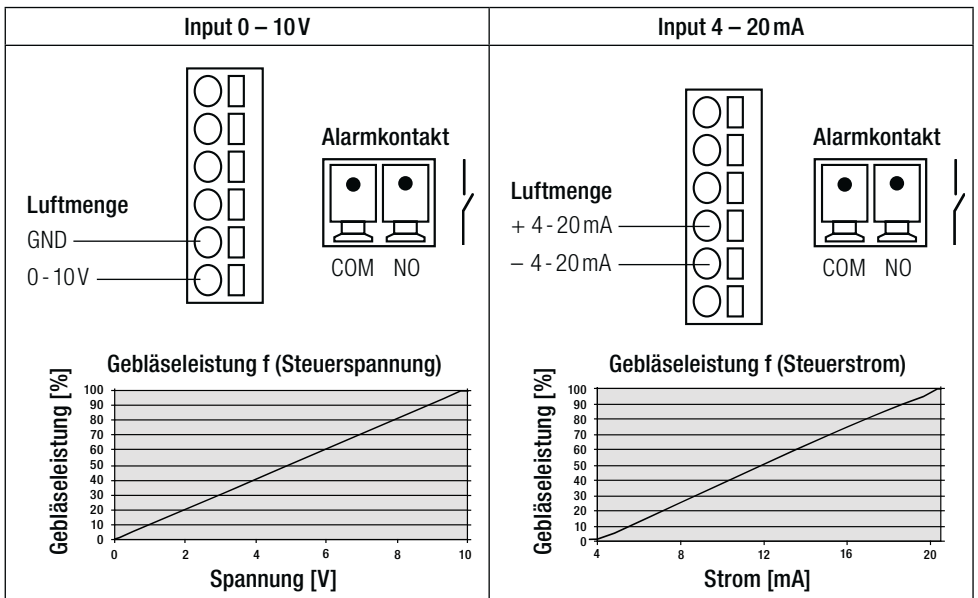

ACHTUNG:

Bei Verwendung als Einbaugerät muss im Netzanschluss eine geeignete Vorrichtung zur **allpoligen Trennung** vom Netz mit einem **Kontaktabstand von mindestens 3 mm** vorhanden sein.

Gerätebeschreibung

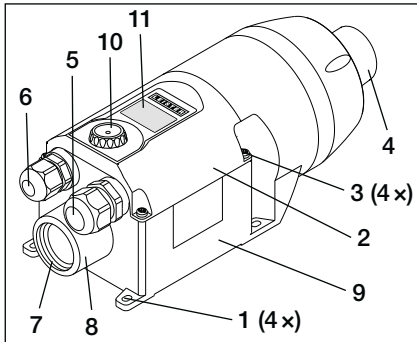

- 1 Montagelaschen
- 2 Abdeckung Anschlussgehäuse
- 3 Schrauben für Anschlussgehäuse
- 4 Ausblasöffnung / Schlauchanschluss \varnothing 38 mm
- 5 Kabelverschraubung für Netzanschluss
- 6 Kabelverschraubung für Schnittstelle
- 7 Lufteinlassflansch mit Innengewinde G 1"
- 8 Anschluss \varnothing 38 für Luftschlauch oder Edelstahlfilter
- 9 Anschlussgehäuse
- 10 e-Drive für Lufteinstellung
- 11 Display

Vorbereitung

- MONO aus der Verpackung entnehmen.
- Durch Lösen der **Schrauben (3)** die **Abdeckung Anschlussgehäuse (2)** öffnen.
- **Kabelverschraubung für Netzanschluss (5)** lösen.
- Bei Bedarf die **Kabelverschraubung für Schnittstelle (6)** lösen.







Einbau

- Gerät darf nur von ausgebildeten Fachleuten eingebaut werden.
- Die Umgebungstemperatur darf nicht höher als 60 °C entsprechen
- Der Einbau muss gewährleisten, dass
 - nur kalte Luft zugeführt wird.
 - das Gerät nicht vom Heissluftstrahl eines anderen Gerätes angeströmt wird.
- Bei staubhaltiger Luft Leister-Edelstahlfilter (siehe Zubehör) verwenden und auf den **Anschluss \varnothing 38 für Luftschlauch oder Edelstahlfilter (8)** aufschieben.
- Bei besonders kritischen Stäuben (z. B. Metall- elektrisch leitenden oder feuchten Stäuben) müssen spezielle Filter verwendet werden, um Kurzschlüsse im Gerät zu vermeiden.
- MONO vor mechanischen Vibrationen und Erschütterungen schützen.
- MONO mit vier Schrauben \varnothing M4 an den **Montagelaschen (1)** befestigen.
- Einbaumasse siehe Seite 3 (Size)

Anschluss

- Der MONO muss durch Fachpersonen angeschlossen werden.
- Im Netzanschluss muss eine geeignete Vorrichtung zur allpoligen Trennung vom Netz vorhanden sein!
- Das Gerät muss gemäss dem Anschlussschema und der Klemmanordnung auf Seite 4, (Wiring Diagram) der Bedienungsanleitung angeschlossen werden:
 - Verdrahtung im **Anschlussgehäuse (9)** vornehmen.
- **Kabelverschraubung für Netzanschluss (5)** und **Kabelverschraubung für Schnittstelle (6)** anziehen.
- **Abdeckung Anschlussgehäuse (2)** mit den **Schrauben (3)** montieren.
- Luftschlauch an **Ausblasöffnung (4)** mit Schlauchbride montieren. Möglichst kurze Schläuche verwenden, um Luftmengenverluste zu vermeiden.
- MONO an das elektrische Netz anschliessen.
- Netz einschalten.

Displaybeschreibung

Symbole		Symbole	
	Unterspannung		Leister Service-Stelle kontaktieren
	Standby		Gebläse aktiv
	Indikatorfeld zur Darstellung von Einheiten oder Informationen für das Servicemenü		
	Wertefeld zur Darstellung der Soll- und Istwerte. Dabei handelt es sich um eine vierstellige Segmentanzeige ohne Dezimalpunkt		

Die Balkenanzeige symbolisiert in 5 Stufen die Gebläsedrehzahl.
Gleichzeitig erscheint die Anzeige in % (1 P – 100 P)



Funktion Geräteschutz

Überhitzt das Gerät (zu warme Luft Eintrittstemperatur oder Wärmerückstau) wird der Motor ausgeschaltet und gleichzeitig der Arbeitskontakt des Alarmrelais geöffnet. Spricht der Geräteschutz an, sind aus Sicherheitsgründen für die Rückstellung des Gerätes folgende Schritte zu beachten:



MONO SYSTEM

- A Gerät abkühlen lassen
- B Gerät vom elektrischen Netz trennen
- C Gerät nach 10 Sek. wieder am elektrischen Netz anschliessen
- D Lufteintritt, Luftaustritts-Öffnung überprüfen und gegebenenfalls reinigen.

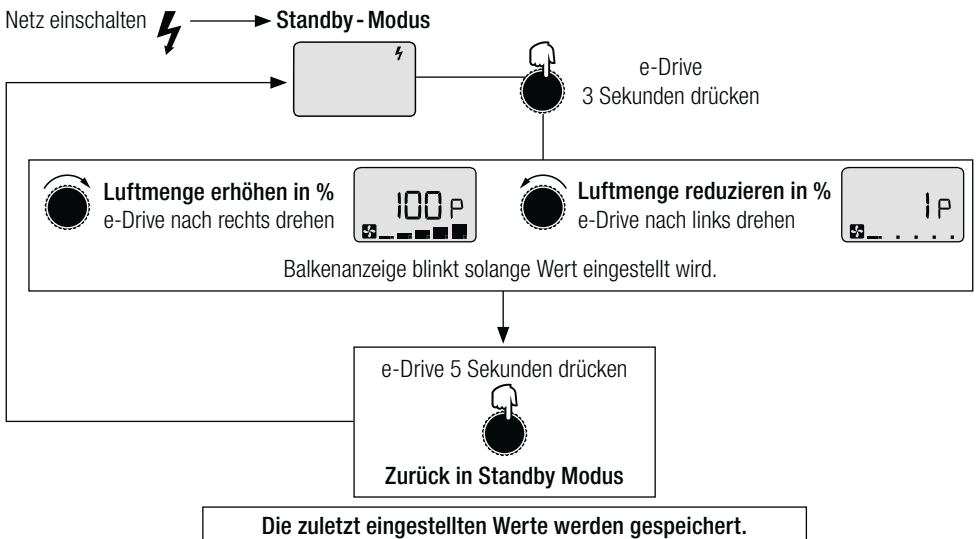
Bedienung



Konfiguration Setup-Menü

e-Drive	Funktion	e-Drive	Funktion
	1× kurz drücken = aktivieren		nach rechts drehen
	3 Sekunden drücken = bestätigen		nach links drehen





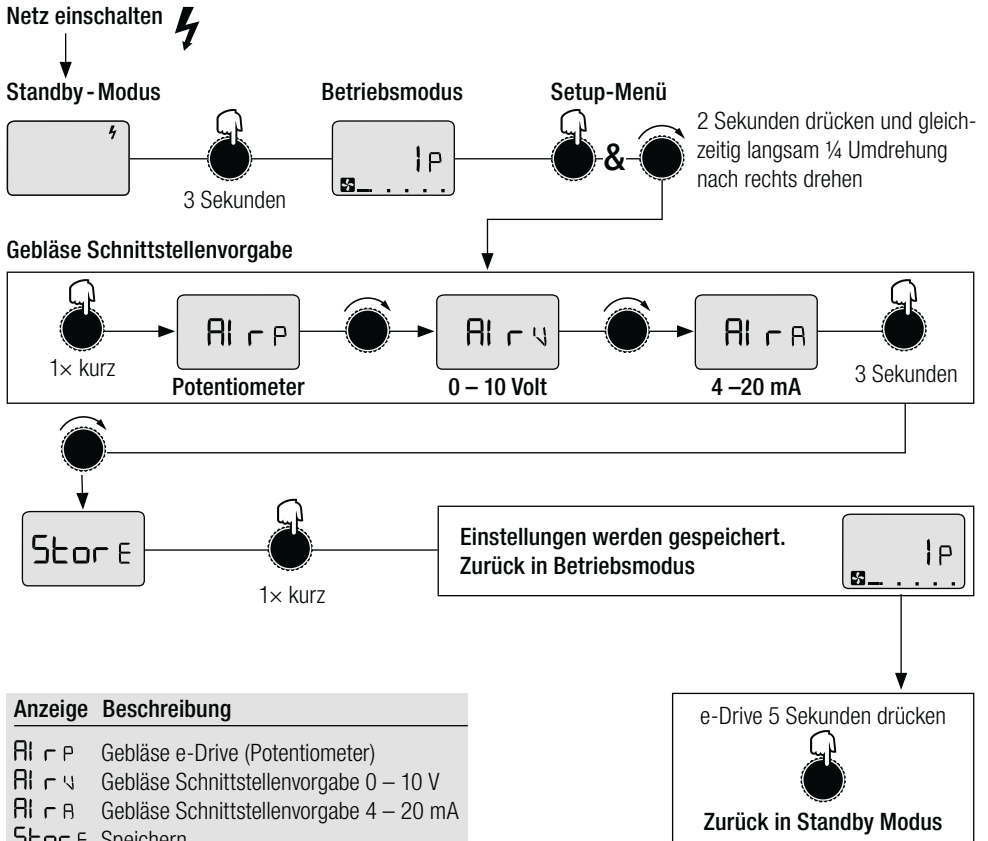

Hinweis:

Wird e-Drive 1× kurz gedrückt ohne zu bestätigen, werden die Werte nicht gespeichert.



Fehlermeldungen

Anzeige	Bezeichnung	Fehlerursache	Fehlerbehebung
E005 	Unterspannung	Netzspannung < 20 % der Nennspannung	Netzspannung überprüfen
		Gerät defekt	Leister Service-Stelle kontaktieren
E004 	Leister Service-Stelle kontaktieren		
E007 			
E009 			

Schulung

Leister Technologies AG sowie deren autorisierte Service-Stellen bieten kostenlose Kurse im Bereich der Anwendungen an. Informationen unter www.leister.com

3D Zeichnungen

3D-Zeichnungen sind bei ihrer Service-Stelle oder auf www.leister.com erhältlich.

Zubehör

- Es darf nur Leister-Zubehör verwendet werden.
- Leister bietet ein grosses Sortiment an Zubehör, z.B.
 - Schlauchbride
 - Luftschlauch ø 38 mm aus PVC
 - Edelstahlfilter, aufschiebbar auf Ansaugstutzen
- Zubehör unter www.leister.com

Service und Reparatur

- Reparaturen sind ausschliesslich von autorisierten Leister Service-Stellen ausführen zu lassen. Diese gewährleisten innert nützlicher Frist einen fachgerechten und zuverlässigen Reparatur-Service mit Original-Ersatzteilen gemäss Schaltplänen und Ersatzteillisten.

Gewährleistung

- Für dieses Gerät gelten die vom direkten Vertriebspartner/Verkäufer gewährten Garantie- oder Gewährleistungsrechte ab Kaufdatum. Bei einem Garantie- oder Gewährleistungsanspruch (Nachweis durch Rechnung oder Lieferschein) werden Herstellungs- oder Verarbeitungsfehler vom Vertriebspartner durch Ersatzlieferung oder Reparatur beseitigt. Heizelemente sind von der Gewährleistung oder Garantie ausgeschlossen.
- Weitere Garantie- oder Gewährleistungsansprüche werden im Rahmen des zwingenden Rechts ausgeschlossen.
- Schäden, die auf natürliche Abnutzung, Überlastung oder unsachgemässe Behandlung zurückzuführen sind, werden von der Gewährleistung ausgeschlossen.
- Keine Garantie- oder Gewährleistungsansprüche bestehen bei Geräten, die vom Käufer umgebaut oder verändert wurden.



Read the operating manual carefully before commissioning and keep it on hand for later consultation.

High-pressure blower MONO SYSTEM

Application

The Leister MONO blower is suitable for installation in machines, plants or devices and is designed for continuous maintenance-free operation.

- Air supply by Leister air heaters, for supplying fresh air and for cooling.
- Is suitable for conveying air, non-flammable, non-aggressive and non-explosive gases.



Warning



Danger to life when opening the device as live components and connections are then exposed. The device must be disconnected from the mains for all poles before the it is opened.



Caution



The **nominal voltage**, specified on the device must match the mains voltage.



Device **is not permitted to be operated** unsupervised. Device may be used only by **trained specialists** or under their supervision. Children are not permitted to operate the equipment under any circumstances.



Protect the device **against humidity and dampness**.

Installation declaration

(Pursuant to EC Machinery Directive 2006/42; Appendix II B)

Leister Technologies AG, Galileo-Strasse 10, CH-6056 Kaegiswil / Switzerland hereby declares that the incomplete machine

Designation: **High-pressure blower**

Model: **MONO**

Version: **SYSTEM**

- insofar as is possible with respect to the scope of delivery - is in compliance with applicable basic requirements of the EC Machinery Directive (2006/42).

The incomplete machine is furthermore in compliance with the requirements of the following EC Directive(s):

EC Guideline(s): Electromagnetic Tolerance 2004/108

Low-voltage Directive 2006/95

RoHS Directive 2011/65

Harmonized standards: EN 12100, EN 55014-1, EN 55014-2, EN 61000-6-2, EN 61000-3-2,

EN 61000-3-3, EN 62233, EN 60335-1, EN 50581

Furthermore, we declare that the special technical documents according to Annex VII (Part B) were prepared for these incomplete machines, and we agree to transmit them electronically to the market surveillance authorities upon justified request.

Name of the authorized document official: Volker Pohl, Manager Product Conformity

Commissioning of the incomplete machine is forbidden until it has been determined if need be that the machine that was installed in the incomplete machine is in compliance with the stipulations of the EC Machinery Directive (2006/42).

Kaegiswil, 6/24/2015

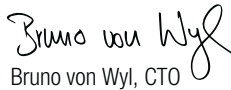
Bruno von Wyl, CTO

Kathrine G.
Andreas Kathriner, GM

Disposal



Electrical equipment, accessories and packagings should be subjected to environmentally friendly recycling. **For EU countries only:** Do not dispose of electrical equipment with household refuse! In accordance with European Guideline 2002/96 regarding waste electrical and electronic equipment (WEEE) and its implementation in national laws, electrical equipment that can no longer be used must be collected separately and subjected to environmentally friendly recycling.

Technical data

Motor version		Brushless motor	
Voltage	V~	120	230
Power	W	120	120
Frequency	Hz	50 / 60	
Max. air inlet temperature	°C	60	
Max. ambient temperature	°C	65	
Max. air volume (20°C ambient area)	l/min.	250 – 600	
Max. static pressure	kPa	3.5	
Emission levels	dB(A)	65	
Weight	kg	1.0	
Interface (potential free)		4 – 20 mA & 0 – 10 V for air volume, alarm output	
Dimensions (size)		Page 3	
Mark of conformity		 (ErP n/a)	
Protection class II			

We reserve the right to make technical changes

Technical data device function

MONO 6	SYSTEM
e-Drive operating unit	•
Tool protection	•
Alarm output (relay contact)	•
Remote control interface for air volume specification	•
Display	•

Technical data interfaces

General	Insulation IEC/EN 60747-5-2	AC 1414 V _{peak}
	Polarity protection	
	Zero point correction	
Voltage entry	Voltage 0 – 10 V	DC 0...10 V (Ripple < 0.4 V at 5% resolution)
	Max. input voltage	DC 12 V
	Index input impedance	33.7 kOhm
Current input	Current 4–20 mA (2-wire technology)	DC 4...20 mA (Ripple < 0.7 mA at 5% resolution)
	Max. input current	DC 22 mA
	Index input impedance	159 Ohm
Alarm output (relay contact)	Max. live voltage	AC 250 V, DC 30 V
	Max. currents	AC 3 A, DC 3 A
	Max. contact impedance	100 mOhm at DC 24 V / 1 A
	Contact type	SPST-NO
	Insulation contact to spool	AC 4000 V 1 min.
Insulation contact to contact	AC 1000 V 1 min.	

Technical data Functions

e-drive or interface

Air volume

Air volume specification 1, 5...100%;
5% resolution

Temperature/air volume diagram

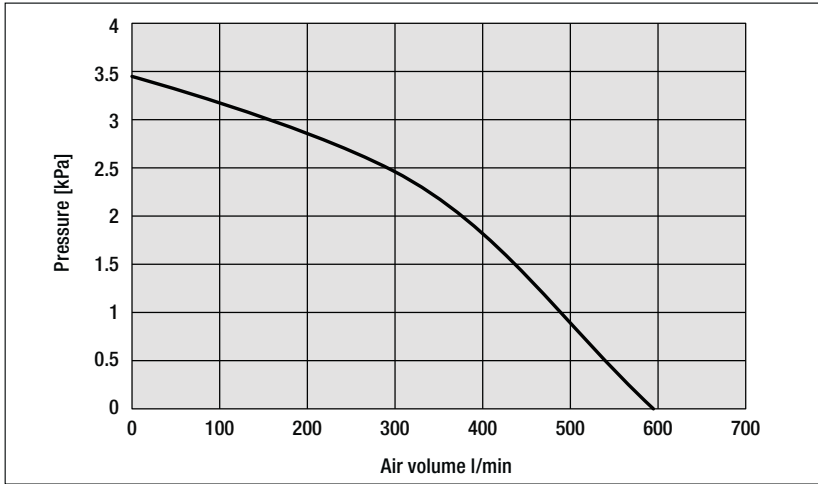

Interface / activation

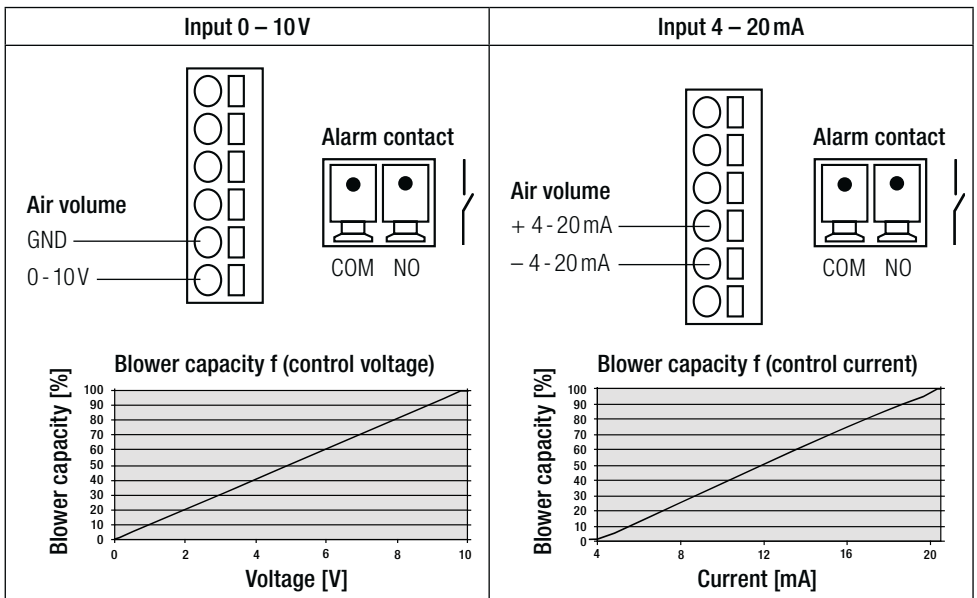

CAUTION:

When using the device as a built-in unit, a suitable mechanism **for disconnecting all poles** from the mains with a **contact space of at least 3 mm** must be present in the power supply cord.

Device description

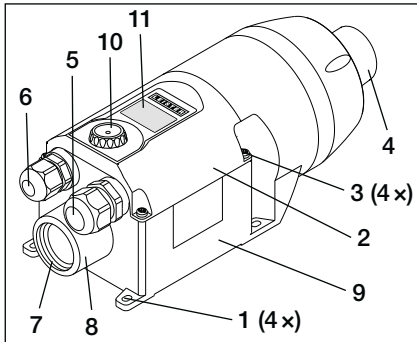

- 1 Mounting tabs
- 2 Connection housing cover
- 3 Screws for connection housing
- 4 Air outlet / hose connection \varnothing 38 mm
- 5 Cable gland for power supply cord
- 6 Cable gland for interface
- 7 Air inlet valve with internal thread G 1"
- 8 Connection \varnothing 38 for air hose or stainless steel filter
- 9 Connection housing
- 10 e-drive for air settings
- 11 Display

Preparation

- Remove MONO from the packaging.
- Loosen the **screws (3)** to **open the cover of the connection housing (2)** .
- **Loosen the cable gland for the power supply (5)** .
- If needed, loosen the **cable gland for interface (6)** .







Installation

- The device may only be installed by a trained technician.
- The surrounding temperature may not be higher than 60 °C
- The installation must ensure that
 - only cold air is taken in.
 - the device is not exposed to the flow of hot air from another device.
- If the air is filled with dust, use the Leister stainless steel filter (see accessories) and push onto **connection \varnothing 38 for air hose or stainless steel filter (8)**.
- In cases of particularly critical dusts (e.g. metal, electrically conductive or moist dusts), special filters must be used in order to avoid short circuits in the device.
- Protect MONO against mechanical vibrations and shocks.
- Attach MONO with four \varnothing M4 screws to the **mounting tabs (1)**.
- For installation dimensions, see page 3 (Size)

Connection

- The MONO must be connected by a trained technician.
- A suitable apparatus for disconnecting the device from the mains for all poles must be present in the power supply cord!
- The device must be connected in accordance with the Wiring Diagram on page 4 of the Operating Manual:
 - Carry out the wiring in the **connection housing (9)** .
- **Tighten the cable gland for the power supply cord (5)** and **the cable gland for the interface (6)** .
- **Attach the cover for the connection housing (2)** using the **screws (3)** .
- Mount the air hose to the **air outlet (4)** with a hose clip. Use hoses that are as short as possible in order to avoid air volume losses.
- Connect MONO to the mains.
- Switch on the mains.

Display description

Symbols		Symbols	
	Undervoltage		Contact a Leister service center
	Standby		Active blower
	Indicator field for displaying units or information for the service menu		
	Field for displaying the target and actual values. This is a four-digit segment display without decimal points.		

The bar display symbolizes the blower speed at 5 levels.
At the same time, it appears in % (1 P–100 P)



Tool protection function

If the device overheats (air intake temperature is too warm or warm air back pressure), the motor is switched off while at the same time the work contact of the alarm relay opens. If the tool protection signals, the following steps should be carried out to reset the device for safety reasons:

MONO SYSTEM

- A** Let the device cool
- B** Disconnect the power cord from the mains
- C** After 10 seconds, plug the device into the mains again
- D** Check air intake, air output opening and clean if necessary.

Operation

Switch on the mains  → Stand-by mode

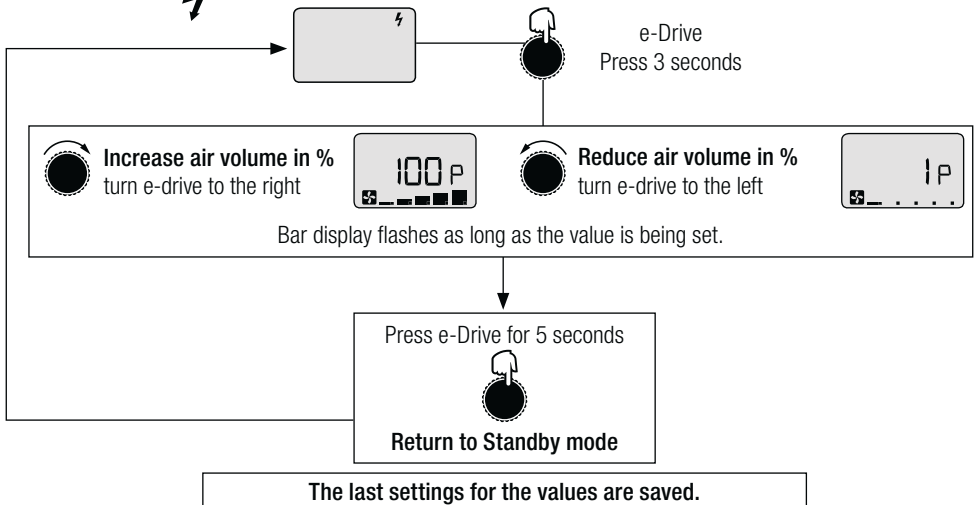

Configuration Setup menu

e-Drive	Function	e-drive	Function
	Press briefly 1 x = activate		turn to the right
	Press 3 seconds = confirm		turn to the left



Note:

If the e-drive is pressed briefly 1x without confirming it, the values will not be saved.

Switch on the mains

Stand-by mode



Operating mode



Set-up menu



Press 2 seconds and at the same time slowly give it a ¼ turn to the right

Blower interface target

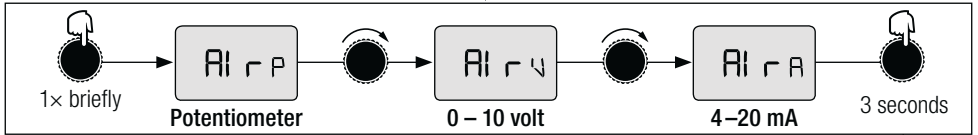

1x briefly

Potentiometer

0 - 10 volt

4 - 20 mA

3 seconds



Settings are saved.
Return to operating mode.







Press e-Drive for 5 seconds



Return to Standby mode

Display	Description
AI r P	Blower e-drive (potentiometer)
AI r V	Blower interface target 0 - 10 V
AI r A	Blower interface target 4 - 20 mA
Stor E	Save

Error messages

Display	Designation	Cause of error	Elimination of error
E005  	Undervoltage	Nominal voltage < 20% of the nominal voltage	Check nominal voltage
		Device defective	Contact a Leister Service outlet
E004 	Contact a Leister service center		
E007 			
E009 			

Training course

Leister Technologies AG and its authorized Service centers offer free courses in the area of applications. Information at www.leister.com

3D drawings

3D models and drawings are available from your Service center or at www.leister.com.

Accessories

- Only Leister accessories may be used.
- Leister offers a wide range of accessories, e.g.
 - Hose clip
 - Air hose \varnothing 38 mm made of PVC
 - Stainless steel filter, push-fit onto intake fitting
- Accessories at www.leister.com

Service and repair

- Repairs shall be assigned exclusively to authorized Leister Service centers. These guarantee a professional and reliable repair service within a useful deadline with original spare parts in accordance with circuit diagrams and spare parts lists.

Warranty

- The guarantee or warranty rights granted for this device by the direct distribution partner/salesman apply after the date of purchase. In the event of a guarantee or warranty claim (verification by invoice or delivery note), manufacturing or processing errors will be rectified by the sales partner through replacement delivery or repair. Heating elements shall be excluded from warranty obligations or guarantees.
- Other guarantee or warranty claims are excluded within the framework of mandatory law.
- Damages resulting from natural wear, overload or improper handling are excluded from the warranty.
- No guarantee or warranty claims exist for devices that have been converted or modified by the purchaser.



Prima della messa in servizio leggere attentamente le presenti istruzioni per l'uso e conservarle per una futura consultazione.

Soffiante ad alta pressione MONO SYSTEM

Applicazione

Il soffiante MONO è adatto al montaggio su macchine, impianti o apparecchi ed è progettato per il funzionamento continuo senza manutenzione.

- Alimentazione d'aria dei riscaldatori Leister, per l'apporto di aria fresca e per il raffreddamento.
- Adatto all'apporto d'aria e di gas non infiammabili, non aggressivi e non esplosivi.



Avvertenza



Pericolo di morte in caso di apertura dell'apparecchio: contiene componenti e contatti sotto tensione non protetti. Prima di aprire l'apparecchio, accertarsi della sua disinserzione onnipolare.



Attenzione



Tensione nominale: quella indicata sull'apparecchio deve corrispondere alla tensione di rete.



L'apparecchio deve essere **azionato** sotto controllo visivo. L'impiego dell'apparecchio è **consentito esclusivamente** a personale qualificato o sotto il monitoraggio di quest'ultimo.
È tassativamente vietato l'impiego da parte dei bambini.



Proteggere l'apparecchio dall'umidità e da ambienti bagnati.

Dichiarazione di montaggio

(ai sensi della Direttiva macchine 2006/42/CE, Allegato II B)

Leister Technologies AG, Galileo-Strasse 10, CH-6056 Kaegiswil / Svizzera dichiara che la quasi-macchina

Descrizione: **Soffiante ad alta pressione**

Tipo: **MONO**

Modello: **SYSTEM**

– soddisfa i requisiti essenziali applicabili della Direttiva macchine CE (2006/42) consentiti dalle possibilità previste dalla fornitura.

La quasi-macchina soddisfa inoltre i requisiti della/e direttiva/e CE riportata/e di seguito:

Direttive CE: Compatibilità elettromagnetica 2004/108

Direttiva bassa tensione 2006/95

Direttiva RoHS 2011/65

Norme armonizzate: EN 12100, EN 55014-1, EN 55014-2, EN 61000-6-2, EN 61000-3-2, EN 61000-3-3, EN 62233, EN 60335-1, EN 50581

Inoltre si dichiara di avere prodotto la documentazione tecnica speciale ai sensi dell'Allegato VII (parte B) per la presente quasi-macchina con l'obbligo di fornirla su espressa richiesta in formato elettronico alle competenti autorità di vigilanza del mercato.

Nome del responsabile della documentazione: Volker Pohl, Manager Product Conformity

La messa in servizio della quasi-macchina è vietata fino quando non sia stato eventualmente stabilito che la macchina in cui è stata installata la quasi-macchina soddisfi le disposizioni della direttiva macchine CE (2006/42).

Kägiswil (Svizzera), 24/06/2015

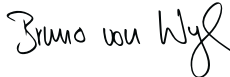

Bruno von Wyl, CTO



Andreas Kathriner, GM



Smaltimento



Gli apparecchi elettrici, gli accessori e gli imballaggi devono essere riciclati nel rispetto dell'ambiente.

Solo per i Paesi UE: non smaltire gli apparecchi elettrici insieme ai rifiuti domestici! Ai sensi della direttiva europea 2002/96 sui rifiuti di apparecchiature elettriche ed elettroniche (RAEE) e del relativo recepimento nella legislazione nazionale, è necessario raccogliere separatamente gli apparecchi elettrici non più utilizzabili e conferirli in un sistema di riciclaggio a basso impatto ambientale.

Specifiche tecniche

Tipologia motore		Motore senza carboncini	
Tensione	V~	120	230
Potenza	W	120	120
Frequenza	Hz	50/60	
Temperatura max. aria in entrata	°C	60	
Temperatura ambiente max.	°C	65	
Portata aria max. (20 °C temp. ambiente)	l/min.	250-600	
Pressione statica max.	kPa	3,5	
Livello di emissione	dB(A)	65	
Peso	kg	1,0	
Interfaccia (priva di potenziale)		4-20 mA e 0-10 V per portata aria e uscita allarme	
Dimensioni e ingombri		Pagina 3	
Marchio di omologazione		 (ErP n/a)	
Classe di protezione II			

Modifiche tecniche riservate

Specifiche tecniche Funzionalità dell'apparecchio

MONO 6	SYSTEM
Unità di controllo e-Drive	•
Protezione dell'apparecchio	•
Uscita allarme (contatto relè)	•
Interfaccia telecomandata per indicazione della portata d'aria	•
Display	•

Specifiche tecniche interfaccia

Generale	Protezione IEC/EN 60747-5-2	CA 1414V di picco
	Protezione contro inversione di polarità	
	Compensazione del punto neutro	
Ingressi tensione	Tensione 0- 10 V	CC 0...10 V (Fattore di cresta < 0,4 V con 5% di risoluzione)
	Tensione d'ingresso max.	CC 12 V
	Resistenza d'ingresso nominale	33,7 kOhm
Ingressi corrente	Corrente 4-20 mA (tecnica a 2 conduttori)	CC 4...20 mA (Fattore di cresta < 0,7 mA con 5% di risoluzione)
	Corrente d'ingresso max.	CC 22 mA
	Resistenza d'ingresso nominale	159 Ohm
Uscita allarme (Contatto relè)	Tensioni max.	CA 250 V, CC 30 V
	Correnti max.	CA 3 A, CC 3 A
	Massima resistenza di contatto	100 mOhm a CC 24 V / 1 A
	Tipo di contatto	SPST-NO
	Contatto isolamento - bobina	CA 4000 V 1 min.
Contatto isolamento - contatto	CA 1000 V 1 min.	

Specifiche tecniche Funzionalità

e-Drive o interfaccia

Portata d'aria

Indicazione della portata d'aria 1, 5...100%;
risoluzione 5%

Schema temperatura / portata aria

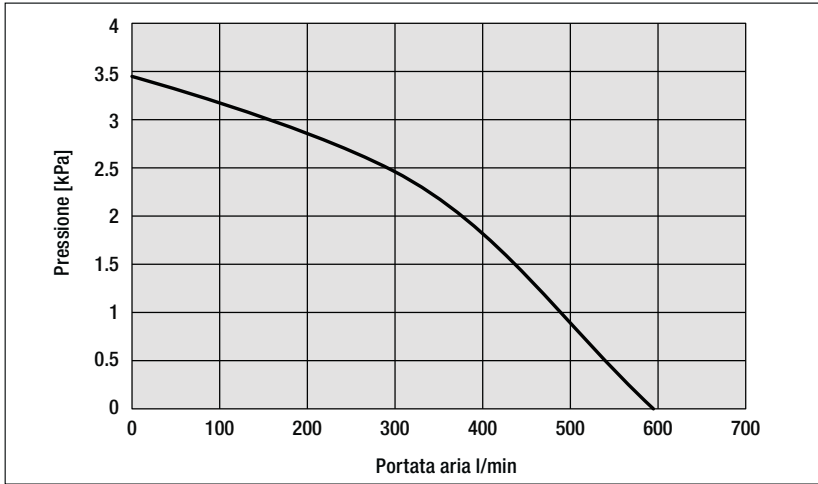

Interfaccia / Comando

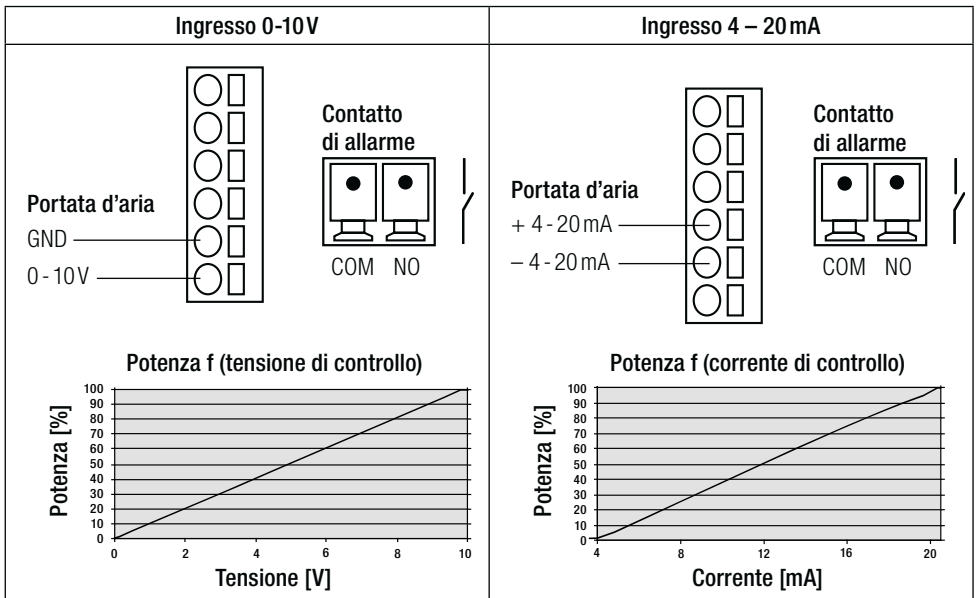

ATTENZIONE:

Se l'apparecchio viene montato in un impianto, prevedere nel collegamento alla rete un idoneo **dispositivo per la disinserzione onnipolare** della rete **almeno con 3 mm di distanza** dai contatti.

Descrizione dell'apparecchio

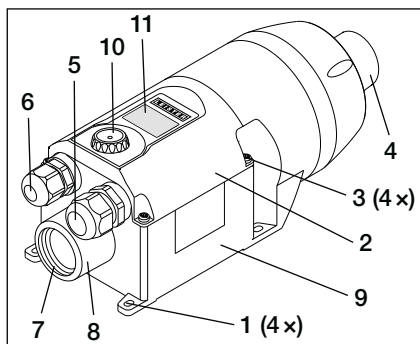

- 1 Squadrette asolate
- 2 Coperchio vano di collegamento
- 3 Viti per vano di collegamento
- 4 Uscita dell'aria / raccordo tubo \varnothing 38 mm
- 5 Pressacavo per allacciamento elettrico
- 6 Pressacavo per interfaccia
- 7 Flangia per presa d'aria con filettatura interna G 1"
- 8 Raccordo \varnothing 38 per tubi flessibili pneumatici o filtri in acciaio inox
- 9 Vano di collegamento
- 10 e-Drive per le impostazioni dell'aria
- 11 Display

Operazioni preliminari

- Estrarre l'apparecchio MONO dall'imballaggio.
- Aprire il coperchio **del vano di collegamento (2)** allentando **le viti (3)**.
- **Allentare il pressacavo per l'allacciamento elettrico (5)**.
- Se necessario, **allentare il pressacavo per l'interfaccia (6)**.







Montaggio

- L'apparecchio deve essere installato solo da personale qualificato.
- La temperatura non deve superare 60 °C
- L'installazione deve garantire che
 - l'apparecchio sia alimentato solo da aria fredda
 - l'apparecchio non sia interessato da getti di aria calda emessi da altri dispositivi
- Se l'aria contiene polveri, applicare il filtro in lega d'acciaio inox Leister (vedere accessori) e inserirlo nel **raccordo \varnothing 38 per tubi flessibili pneumatici o filtri in lega d'acciaio inox (8)**.
- Per polveri particolarmente critiche (per es. metalliche, elettroconduttrici o umide) è necessario impiegare filtri speciali che evitano cortocircuiti nell'apparecchio.
- Proteggere l'apparecchio MONO da vibrazioni e sollecitazioni di natura meccanica.
- Fissare l'apparecchio MONO mediante quattro viti \varnothing M4 alle **squadrette asolate (1)**.
- Dimensioni di ingombro: vedere pagina 3 (Dimensioni)

Collegamento

- L'apparecchio MONO deve essere collegato alla rete solo da personale qualificato.
- Nell'allacciamento alla rete deve essere presente un idoneo dispositivo per il distacco onnipolare dalla rete!
- L'apparecchio deve essere collegato secondo lo schema di collegamento e la piedinatura indicati a pagina 4 (schema elettrico) delle istruzioni per l'uso:
 - Effettuare il cablaggio **nel vano di collegamento (9)**.
- **Serrare il pressacavo per l'allacciamento elettrico (5) e il pressacavo per l'interfaccia (6)**.
- **Applicare il coperchio del vano di collegamento (2)** mediante **le viti (3)**.
- Montare il tubo flessibile dell'aria all'**uscita dell'aria (4)** mediante l'apposita fascetta di serraggio. Usare tubi il più possibile corti per evitare perdite di carico dell'aria.
- Collegare l'apparecchio MONO alla rete elettrica.
- Inserire l'alimentazione elettrica.

Descrizione dei simboli sul display

Legenda		Legenda	
	Bassa tensione		Contattare il centro di assistenza Leister
	Standby		Soffiante in funzione
	Campo che visualizza unità o informazioni per il menu di assistenza		
	Campo che visualizza i valori nominali e reali. Le indicazioni vengono espresse in un segmento a quattro valori senza separatore decimale		

L'indicatore a barre mostra il regime del soffiante su 5 livelli.
Contemporaneamente, appare l'indicazione in % (1 P – 100 P)



Regime del ventilatore 100 % max.



Regime del ventilatore 1 % min.

Funzionalità di protezione dell'apparecchio

Se l'apparecchio si surriscalda (temperatura dell'aria in entrata troppo elevata oppure riflusso caldo), il motore viene disattivato e contemporaneamente aperto il contatto NA del relè di allarme. Per ragioni di sicurezza, se si attiva la protezione dell'apparecchio, è necessario osservare la seguente procedura di azzeramento dell'apparecchio:

MONO SYSTEM

- A** Fare raffreddare l'apparecchio
- B** Scollegare l'apparecchio dalla rete
- C** Dopo 10 secondi, allacciare nuovamente l'apparecchio alla rete
- D** Controllare le bocchette di aspirazione e di scarico dell'aria e pulirle se necessario.

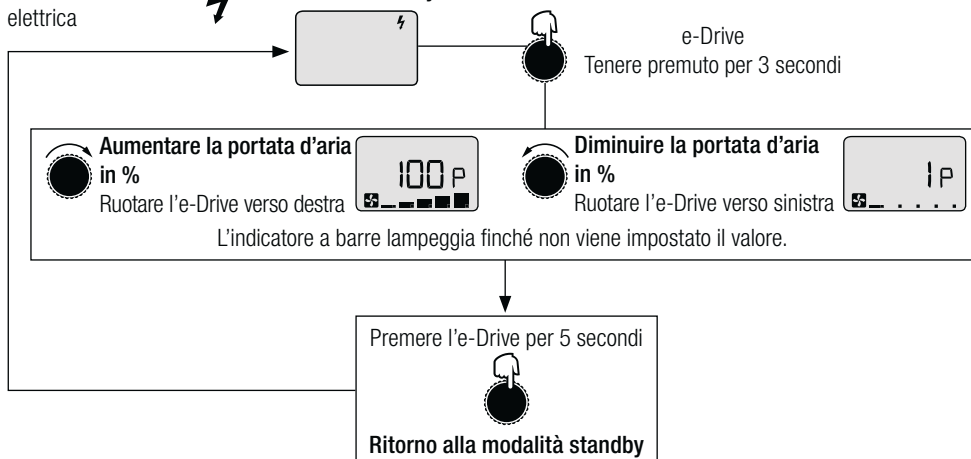

Utilizzo

Inserire l'alimentazione elettrica  → **Modalità standby**



Gli ultimi valori impostati vengono memorizzati.

Menu di configurazione

e-Drive	Funzione	e-Drive	Funzione
	Breve pressione singola = attivazione		rotazione verso destra
	Pressione per 3 secondi = conferma		rotazione verso sinistra



Nota:

Se l'e-Drive viene premuto 1 volta brevemente senza confermare, i dati non verranno salvati.

Inserire l'alimentazione elettrica 

Modalità standby



Modalità di funzionamento



Menu Set-up

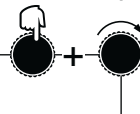

Premere per 2 secondi e, al contempo, ruotare lentamente verso destra per ¼ di giro

Indicazione interfaccia ventilatore

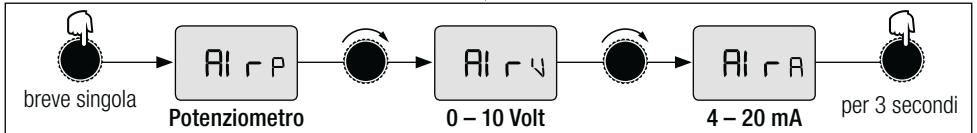

breve singola

Potenziometro



AI r V
0 - 10 Volt



AI r A
4 - 20 mA



per 3 secondi



Stor E



Le impostazioni vengono salvate. Ritorno alla modalità di funzionamento







Premere l'e-Drive per 5 secondi



Ritorno alla modalità standby

Indicazione	Descrizione
AI r P	Soffiante, e-Drive (potenziometro)
AI r V	Soffiante, indicazione interfaccia 0 - 10 V
AI r A	Soffiante, indicazione interfaccia 4 - 20 mA
Stor E	Salvataggio

Messaggi di errore

Schermata	Descrizione	Causa errore	Soluzione
E005 	Bassa tensione	Tensione di rete < 20% della tensione nominale	Verificare la tensione di rete
		Guasto dell'apparecchio	Contattare il centro di assistenza Leister
E004 	Contattare il centro di assistenza Leister		
E007 			
E009 			

Formazione

Leister Technologies AG e i rispettivi centri di assistenza autorizzati offrono corsi gratuiti nell'ambito delle applicazioni. Ulteriori informazioni sono disponibili alla pagina www.leister.com

Disegni in 3D

I disegni in 3D sono disponibili presso il centro assistenza o all'indirizzo www.leister.com.

Accessori

- Utilizzare esclusivamente accessori Leister.
- Leister offre una vasta gamma di accessori, tra cui:
 - fascetta di serraggio per tubo flessibile
 - tubo flessibile dell'aria \varnothing 38 mm in PVC
 - filtro in lega d'acciaio, inseribile sulle bocchette di aspirazione
- Accessori disponibili alla pagina www.leister.com

Assistenza e riparazioni

- Le riparazioni devono essere eseguite esclusivamente dai centri di assistenza autorizzati da LEISTER. Questi assicurano riparazioni sicure e affidabili in tempi rapidi, con parti di ricambio originali come da schemi elettrici ed elenco parti di ricambio.

Garanzia legale

- A questo prodotto si applicano i diritti previsti per la garanzia concessi dal partner di distribuzione/rivenditore diretto, a partire dalla data di acquisto. In caso di ricorso alla garanzia (fanno fede la fattura o la bolla di consegna), sono previste la fornitura sostitutiva o la riparazione di difetti di fabbricazione o di lavorazione a cura del partner di distribuzione. La garanzia non si applica agli elementi riscaldanti.
- È esclusa qualsiasi ulteriore garanzia non espressamente prevista dalle vigenti norme di diritto cogente.
- Sono esclusi dalla garanzia i danni riconducibili alla naturale usura, al sovraccarico o alla scorretta manipolazione.
- Il ricorso alla garanzia decade per gli apparecchi sottoposti a modifiche o alterazioni da parte dell'acquirente.



Lire attentivement la présente notice d'utilisation avant la mise en service et la conserver pour consultation ultérieure.

Soufflerie à haute pression MONO SYSTEM

Application

La soufflerie MONO de Leister est idéale pour le montage dans des machines, des installations ou des appareils et est conçue en vue d'un fonctionnement permanent sans entretien.

- Alimentation en air des chauffe-air Leister pour apport d'air frais et pour refroidir.
- Convient pour le transport de l'air et de gaz non inflammables, non agressifs et non explosifs.



Avertissement



Danger de mort en cas d'ouverture de l'appareil, en raison de l'exposition de composants et de connexions sous tension. Avant d'ouvrir l'appareil, celui-ci doit être déconnecté du réseau électrique sur tous les pôles.



Prudence



La **tension nominale**, indiquée sur l'appareil doit être identique à la tension du secteur.



L'appareil **ne doit pas être utilisé sans surveillance**. L'appareil doit uniquement être utilisé par des **spécialistes qualifiés** ou sous leur surveillance. L'utilisation de l'appareil par des enfants est absolument interdite.



Protéger l'appareil **de l'humidité et des liquides**.

Déclaration d'incorporation

(au sens de la directive machine CE 2006/42; annexe II B)

Leister Technologies AG, Galileo-Strasse 10, CH-6056 Kaegiswil/Suisse déclare par le présent document que la quasi-machine

Désignation : **Soufflerie à haute pression**

Modèle : **MONO**

Version : **SYSTEM**

est conforme aux exigences fondamentales applicables de la directive CE relative aux machines (2006/42), dans la mesure où l'étendue de la livraison le permet.

La quasi-machine est par ailleurs conforme aux exigences des directives européennes suivantes :

Directives européennes : Compatibilité électromagnétique 2004/108

Directive basse tension 2006/95

Directive RoHS 2011/65

Normes harmonisées : EN 12100, EN 55014-1, EN 55014-2, EN 61000-6-2, EN 61000-3-2,

EN 61000-3-3, EN 62233, EN 60335-1, EN 50581

Nous déclarons en outre que la documentation technique pertinente relative à cette quasi-machine a été constituée conformément à l'annexe VII (partie B) et nous nous engageons à la communiquer par voie électronique aux autorités de surveillance du marché sur demande motivée.

Nom du responsable de la documentation : Volker Pohl, Manager Product Conformity

La mise en service de cette quasi-machine est interdite jusqu'à ce qu'il ait été constaté que la machine dans laquelle la quasi-machine est incorporée satisfait aux exigences de la directive CE relative aux machines (2006/42).

Kaegiswil, le 24/06/2015

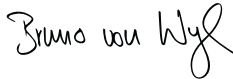

Bruno von Wyl, CTO

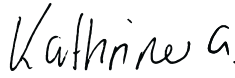



Andreas Kathriner, GM

Recyclage



Les outils électriques, les accessoires et les emballages doivent être recyclés en respectant l'environnement. **Pour les pays de l'UE uniquement** : ne pas jeter les outils électriques dans les ordures ménagères ! Selon la directive européenne 2002/96 relative aux déchets d'équipements électriques et électroniques et à leur application en droit national, les appareils électriques usagés doivent être collectés séparément et faire l'objet d'un recyclage écologique.

Caractéristiques techniques

Modèle du moteur		Moteur sans balais	
Tension	V~	120	230
Puissance	W	120	120
Fréquence	Hz	50 / 60	
Température d'entrée de l'air max.	°C	60	
Température ambiante max.	°C	65	
Débit d'air max. (air ambiant à 20 °C)	l/min	250 – 600	
Pression statique max.	kPa	3,5	
Niveau sonore	dB(A)	65	
Poids	kg	1,0	
Interface (libre de potentiel)		4 – 20 mA et 0 – 10 V pour débit d'air, sortie d'alarme	
Dimensions (cotes)		Page 3	
Label de conformité		 (ErP n/a)	
Classe de protection II			

Sous réserve de modifications techniques

Caractéristiques techniques fonction de l'appareil

MONO 6	SYSTEM
Unité de commande e-Drive	•
Protection de l'appareil	•
Sortie d'alarme (contact relais)	•
Interface de télécommande de la consigne de débit d'air	•
Écran	•

Caractéristiques techniques interface

Généralités	Isolation CEI/EN 60747-5-2	AC 1414 V _{peak}
	Protection contre l'inversion de polarité	
	Correction du point zéro	
Entrées de tension	Tension 0 – 10 V	DC 0...10 V (Ondulation < 0,4 V avec résolution 5 %)
	Tension d'entrée max.	DC 12 V
	Résistance d'entrée nominale	33,7 kohm
Entrées de courant	Courant 4–20 mA (technique 2 fils)	DC 4...20 mA (Ondulation < 0,7 mA avec résolution 5 %)
	Courant d'entrée max.	DC 22 mA
	Résistance d'entrée nominale	159 ohms
Sortie d'alarme (contact relais)	Tensions max.	AC 250 V, DC 30 V
	Courants max.	AC 3 A, DC 3 A
	Résistance de contact	100 MOhm à DC 24 V / 1 A
	Type de contact	SPST-NO
	Isolation contact avec bobine	AC 4000 V 1 min
	Isolation contact avec contact	AC 1000 V 1 min

Caractéristiques techniques fonctions

e-Drive ou interface

Débit d'air

Consigne de débit d'air 1, 5...100 % ;
résolution 5 %

Graphique température/débit d'air

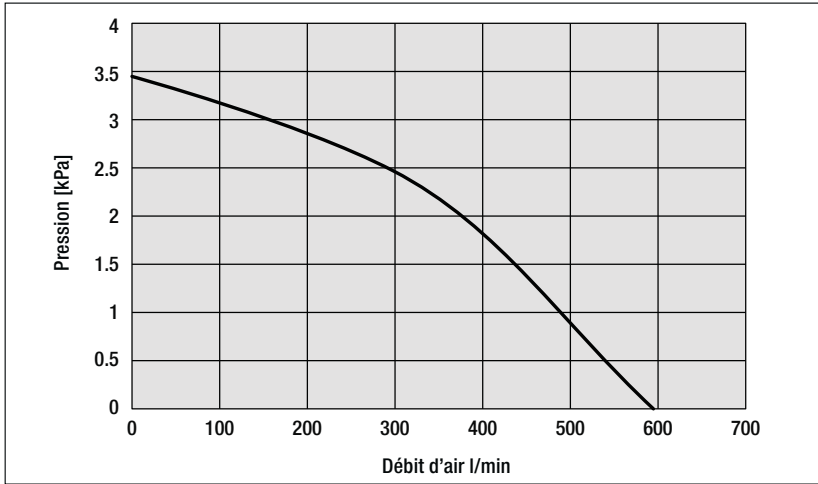

Interface / commande

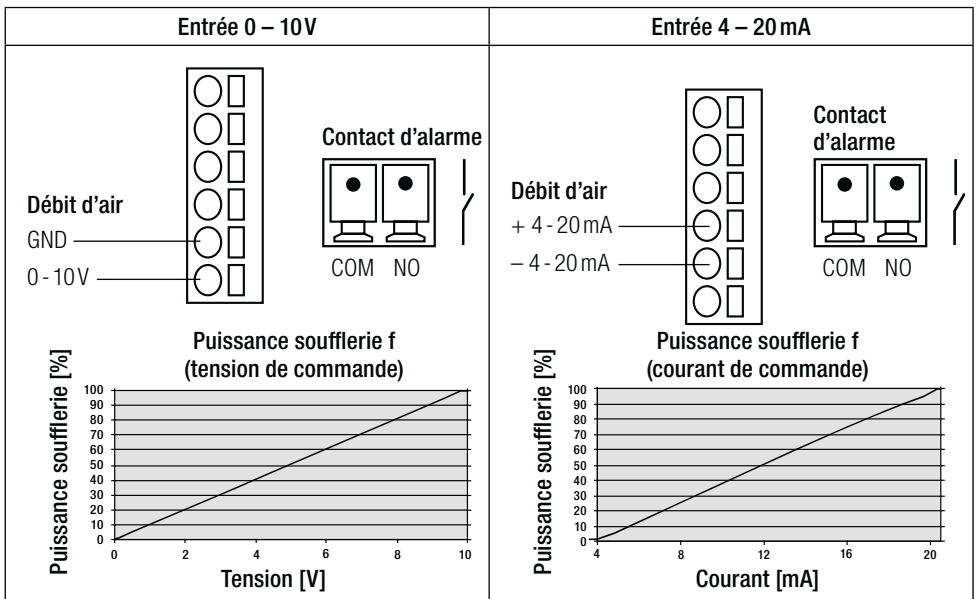

ATTENTION :

En cas d'incorporation de l'appareil, un dispositif adéquat doit être disponible dans le raccordement au secteur pour une séparation omnipolaire du secteur avec une distance de contact d'au moins 3 mm.

Description de l'appareil

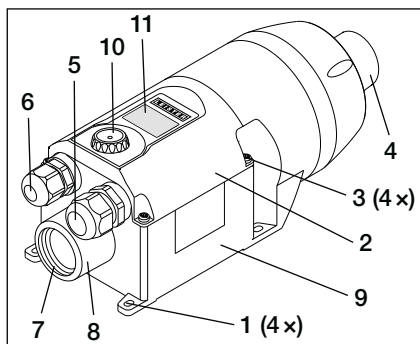

- 1 Éclisses de montage
- 2 Recouvrement du boîtier de raccordement
- 3 Vis du boîtier de raccordement
- 4 Sortie d'air / raccord de tuyau \varnothing 38 mm
- 5 Raccord fileté pour la connexion au secteur
- 6 Raccord fileté de l'interface
- 7 Bride d'arrivée d'air avec filetage femelle G 1"
- 8 Raccord de \varnothing 38 pour tuyau d'air ou filtre en acier inoxydable
- 9 Boîtier de raccordement
- 10 e-Drive pour le réglage du débit d'air
- 11 Écran

Préparation

- Sortir le MONO de l'emballage.
- Desserrer les **vis (3)** pour ouvrir **recouvrement du boîtier de raccordement (2)**.
- **Desserrer le raccord fileté du raccordement au secteur (5)**.
- Si nécessaire, desserrer le **raccord fileté de l'interface (6)**.







Montage

- Cet appareil ne doit être monté que par des spécialistes dûment formés.
- La température ambiante ne doit pas être supérieure à 60 °C
- Le montage doit garantir
 - que l'appareil ne sera alimenté qu'en air froid,
 - que l'appareil ne sera pas soumis au flux d'air chaud d'un autre appareil.
- Si l'air est chargé en poussière, utiliser le filtre en acier inoxydable Leister (voir Accessoires) et l'engager sur le **raccord de \varnothing 38 pour tuyau d'air ou filtre en acier inoxydable (8)**.
- En présence de poussières particulièrement critiques (par ex., poussières métalliques, conductrices d'électricité ou humides), des filtres spéciaux doivent être utilisés pour éviter les courts-circuits dans l'appareil.
- Protéger le MONO des vibrations mécaniques et des secousses.
- Fixer le MONO au **éclisses de montage (1)** par quatre vis \varnothing M4.
- Voir les dimensions d'installation en page 3 (cotes).

Raccordement

- Le MONO doit être raccordé par des spécialistes.
- Dans le raccordement au secteur, un dispositif de coupure du réseau électrique omnipolaire doit être présent !
- L'appareil doit être raccordé selon le schéma de raccordement et la disposition des bornes à la page 4 (schéma de câblage) du mode d'emploi :
 - Réaliser le câblage dans le **boîtier de raccordement (9)**.
- **Serrer le raccord fileté pour la connexion au secteur (5)** et le **raccord fileté de l'interface (6)**.
- **Monter le recouvrement du boîtier de raccordement (2)** avec les **vis (3)**.
- Monter le tuyau d'air sur l'**ouverture d'aspiration (4)** à l'aide d'une bride pour flexible. Utiliser les plus petites longueurs de tuyaux possibles afin d'éviter les pertes de débit d'air.
- Raccorder le MONO au secteur.
- Mettre sous tension.

Description de l'écran

Symboles		Symboles	
	Minima de tension		Contacter le centre de service Leister
	Standby		Soufflerie active
	Champ indicateur pour indiquer les unités ou des informations pour le menu Service		
	Champ de valeur indiquant les valeurs de consigne et les valeurs réelles. Il s'agit d'un affichage à segment à quatre positions sans point décimal		

L'affichage à barres symbolise le régime de la soufflerie par 5 niveaux.
Dans le même temps, l'affichage en % (1 P – 100 P) apparaît

Régime de la soufflerie 100 % max.

Régime de la soufflerie 1 % min.

Fonction protection de l'appareil

Si l'appareil est en surchauffe (température d'entrée de l'air trop élevée ou accumulation de chaleur), le moteur est arrêté et le contact de travail du relais d'alarme est ouvert en même temps. Si la protection de l'appareil est activée, la procédure ci-dessous pour remettre l'appareil en marche est à suivre pour des raisons de sécurité.



MONO SYSTEM

- A Laisser refroidir l'appareil
- B Débrancher l'appareil du réseau électrique
- C Rebrancher l'appareil au réseau électrique après 10 secondes
- D Contrôler l'entrée d'air, l'orifice de sortie d'air et les nettoyer au besoin

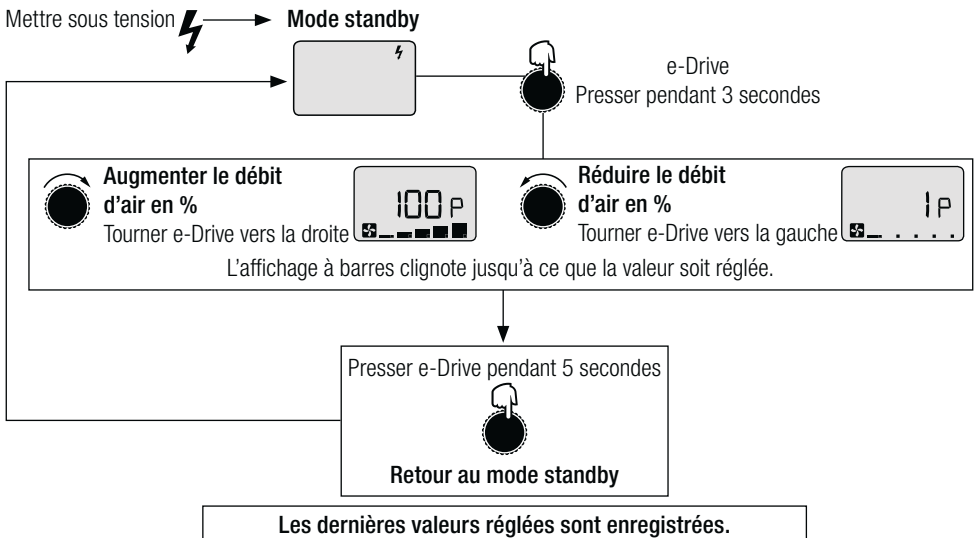
Commande



Configuration menu Setup

e-Drive	Fonction	e-Drive	Fonction
	Presser 1× brièvement = activer		Tourner vers la droite
	Presser 3 secondes = confirmer		Tourner vers la gauche



Indication :

si vous pressez e-Drive 1× brièvement sans confirmer, les valeurs ne seront pas enregistrées.

Mettre sous tension 

Mode standby



3 secondes

Mode de service



Menu Setup



Presser 2 secondes et tourner en même temps lentement d'1/4 de tour vers la droite

Soufflerie consigne de l'interface

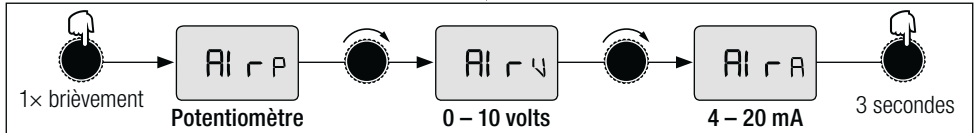

1× brièvement

Potentiomètre

0 - 10 volts

4 - 20 mA

3 secondes



1× brièvement

Les réglages sont enregistrés. Retour au mode de service

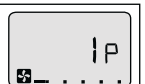





Affichage	Description
AI r P	Soufflerie e-Drive (potentiomètre)
AI r V	Soufflerie consigne de l'interface 0 - 10 V
AI r A	Soufflerie consigne de l'interface 4 - 20 mA
Stor E	Enregistrer

Presser e-Drive pendant 5 secondes



Retour au mode standby

Messages d'erreur

Affichage	Désignation	Cause de l'erreur	Élimination de l'erreur
E005  	Sous-tension	Tension du secteur < 20 % de la tension nominale	Contrôler la tension du secteur
		Appareil défectueux	Contacteur le centre de service Leister
E004 	Contacter le centre de service Leister		
E007 			
E009 			

Formation

Leister Technologies AG ainsi que ses centres de service agréés proposent des cours gratuits traitant des différentes applications. Informations sur le site www.leister.com

Dessins en 3D

Les dessins en 3D sont disponibles auprès de votre centre de service ou sur www.leister.com.

Accessoires

- Seuls des accessoires Leister doivent être utilisés.
- Leister propose un grand assortiment d'accessoires, comme
 - Bride de serrage
 - Tuyau d'air ø 38 mm en PVC
 - Filtre en acier inoxydable, emboîtable sur le manchon d'aspiration
- Pour les accessoires, voir www.leister.com

Service et réparations

- Les réparations doivent uniquement être effectuées par des centres de service Leister agréés. Ils garantissent un service de réparation professionnel et fiable dans un délai raisonnable, avec des pièces de rechange d'origine conformes aux schémas de connexion et listes de pièces de rechange.

Garantie

- Les droits au titre de la garantie fabricant ou de la garantie légale octroyés par le partenaire commercial/revendeur direct s'appliquent à cet appareil à compter de la date d'achat. En cas de recours en garantie (justifié par la facture ou le bordereau de livraison), les défauts de fabrication ou de main-d'œuvre feront l'objet soit d'une réparation, soit d'un remplacement par le partenaire commercial. Les éléments chauffants sont exclus de la garantie.
- Toute autre prétention à la garantie fabricant ou à la garantie légale dans le cadre du droit en vigueur est exclue.
- Les dommages résultant d'une usure naturelle, d'une surcharge ou d'un traitement non conforme sont exclus de la garantie.
- Aucun droit à revendication n'est accordé pour les appareils qui auront été transformés ou modifiés par l'acheteur.



Leer las instrucciones de servicio con atención antes de la puesta en servicio y conservarlas para futuras consultas.

Soplante de alta presión MONO SYSTEM

Aplicación

El soplador MONO de Leister es adecuado para el montaje en máquinas, instalaciones o equipos y fue diseñado para un funcionamiento continuo que no necesita mantenimiento.

- Abastecimiento de aire de los calentadores de aire de Leister para la alimentación de aire fresco y para la refrigeración.
- Adecuado para la impulsión de aire y gases no inflamables, explosivos ni agresivos.



Advertencia



Peligro de muerte al abrir el equipo, ya que podrá accederse a componentes y a conexiones conductores de tensión. Antes de abrir el equipo debe desconectarlo de la red en todos los polos.



Precaución



La **tensión nominal** indicada en el equipo debe coincidir con la tensión de red.



El dispositivo debe operarse **con supervisión**. El equipo solo lo puede manejar personal especializado formado **o personas que estén bajo su supervisión**. Los niños no están autorizados a emplear el equipo bajo ningún concepto.



Proteger **el equipo** de la humedad.

Declaración de montaje

(Según lo estipulado en la Directiva de máquinas 2006/42/CE, anexo II B)

Leister Technologies AG, Galileo-Strasse 10, CH-6056 Kaegiswil/Suiza declara por la presente que la máquina incompleta

Denominación: **soplante de alta presión**

Modelo: **MONO**

Versión: **SYSTEM**

, siempre que lo permita el volumen de suministro, cumple los requisitos básicos aplicables de la Directiva de máquinas (2006/42/CE).

Además, la máquina incompleta cumple los requisitos de las siguientes directiva(s) europea(s):

Directiva(s) CE: Compatibilidad electromagnética 2004/108

Directiva de material eléctrico destinado a utilizarse con determinados límites de tensión 2006/95

Directiva sobre restricciones a la utilización de determinadas sustancias peligrosas en aparatos eléctricos y electrónicos 2011/65

Normas armonizadas: EN 12100, EN 55014-1, EN 55014-2, EN 61000-6-2, EN 61000-3-2, EN 61000-3-3, EN 62233, EN 60335-1, EN 50581

Además, declaramos que hemos elaborado la documentación técnica especial para esta máquina incompleta de conformidad con el anexo VII (parte B) y nos comprometemos a facilitársela por vía electrónica a las autoridades de inspección de mercado previa petición debidamente justificada.

Nombre del apoderado de la documentación: Volker Pohl, Manager Product Conformity

Queda prohibida la puesta en servicio de la máquina incompleta hasta que se haya comprobado que la máquina en la que se ha montado cumple las disposiciones de la Directiva de máquinas (2006/42/CE).

Kaegiswil, 24/06/2015

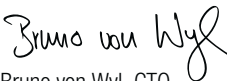
Bruno von Wyl, CTO



Andreas Kathriner, GM

Eliminación



Las herramientas eléctricas, los accesorios y los embalajes deben reciclarse y reutilizarse de forma adecuada para proteger el medioambiente. **Solo para países de la Unión Europea:** no deseché jamás herramientas eléctricas en la basura doméstica. Conforme a la Directiva europea 2002/96/CE sobre residuos de aparatos eléctricos y electrónicos y su aplicación en las leyes nacionales, las herramientas eléctricas inservibles deben guardarse por separado y desecharse y reciclarse de forma adecuada para proteger el medio ambiente.

Datos técnicos

Ejecución de motor		Motor sin escobillas	
Tensión	V~	120	230
Potencia	W	120	120
Frecuencia	Hz	50/60	
Temperatura máxima de entrada de aire	°C	60	
Temperatura ambiente máx.	°C	65	
Flujo de aire máx. (20 °C ambiente)	l/min.	250 – 600	
Presión estática máx.	kPa	3,5	
Caudal de emisiones	dB(A)	65	
Peso	kg	1,0	
Interfaz (libre de potencial)		4 – 20 mA & 0 – 10 V para flujo de aire, salida de alarma	
Dimensiones (Size)		Página 3	
Marca de conformidad		 (ErP n/a)	
Clase de protección II			

Sujeto a modificaciones técnicas

Datos técnicos acerca del funcionamiento del equipo

MONO 6	SYSTEM
Unidad de mando e-Drive	•
Protección del equipo	•
Salida de alarma (contacto de relé)	•
Interfaz de control remoto para especificaciones de flujo de aire	•
Pantalla	•

Datos técnicos Interfaz

General	Aislamiento IEC/EN 60747-5-2	CA 1414 Vpeak
	Protección contra inversiones de polaridad	
	Corrección de punto cero	
Entradas de tensión	Tensión 0 – 10 V	CC 0...10 V (Rippel < 0,4 V con 5 % resolución)
	Tensión máx. de entrada	CC 12 V
	Resistencia de entrada nominal	33,7 kΩ
Entradas de corriente	Corriente 4 – 20 mA (tecnología de 2 conductores)	CC 4...20 mA (Rippel < 0,7 mA con 5 % resolución)
	Corriente máx. de entrada	CC 22 mA
	Resistencia de entrada nominal	159 Ω
Salida de alarma (contacto de relé)	Tensiones máximas	CA 250 V, CC 30 V
	Corrientes máximas	CA 3 A, CC 3 A
	Resistencia máxima de contacto	100 mΩ con CC 24 V/1 A
	Tipo de contacto	SPST-NO
	Contacto de aislamiento para bobina	CA 4000 V 1 min.
Contacto de aislamiento para contacto	CA 1000 V 1 min.	

Datos técnicos Funciones

e-Drive o interfaz

Flujo de aire

Especificaciones de flujo de aire 1, 5...100 %;
5 % resolución

Diagrama de temperatura/flujo de aire

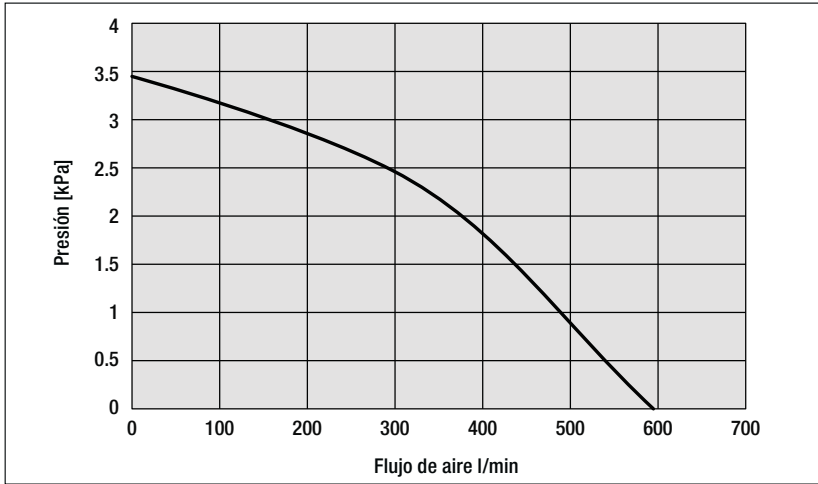

Interfaz/sistema de mando

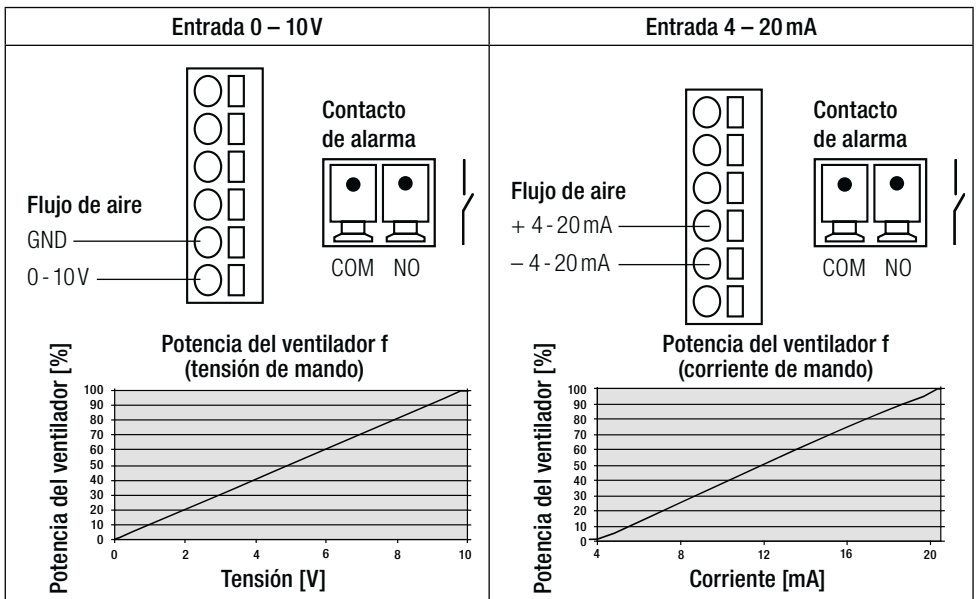

ATENCIÓN:

En caso de que se utilice como unidad incorporada, en la conexión debe haber un dispositivo **para la desconexión de todos los polos** de la red con una **distancia entre los contactos de 3 mm como mínimo**.

Descripción del equipo

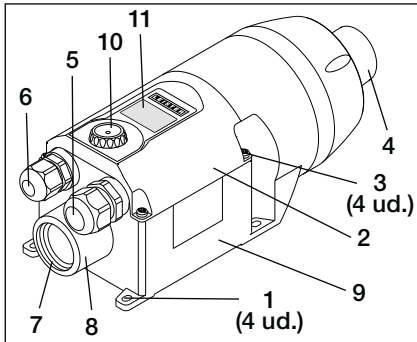

- 1 Lengüetas de montaje
- 2 Tapa de la caja de empalme
- 3 Tornillos para caja de empalme
- 4 Orificio de soplado/conexión de la manguera Ø 38 mm
- 5 Cable tipo racor para conexión de red
- 6 Cable tipo racor para interfaz
- 7 Brida de entrada del aire con rosca interior G 1"
- 8 Conexión Ø 38 para manguera de aire o filtro de acero inoxidable
- 9 Caja de empalme
- 10 e-Drive para el ajuste del flujo de aire
- 11 Pantalla

Preparación

- Retirar MONO del embalaje.
- Abrir la **tapa de la caja de empalme (2)** aflojando los **tornillos (3)**.
- Aflojar el **cable tipo racor para la conexión de red (5)**.
- Si fuera necesario, **soltar el cable tipo racor para la interfaz (6)**.







Montaje

- La instalación del equipo únicamente se autoriza a personal especializado con la debida formación.
- La temperatura ambiente no debe ser superior a 60 °C
- Dicha instalación deberá garantizar que:
 - la alimentación únicamente se produzca con aire frío.
 - el equipo no se someta al chorro de aire caliente de otro equipo.
- En caso de que el aire contenga polvo, utilizar el filtro de acero inoxidable de Leister (véanse accesorios) y colocarlo sobre la **conexión Ø 38 para manguera de aire o filtro de acero inoxidable (8)**.
- Si se trata de polvo especialmente complicado (p. ej. polvo metálico, conductor de electricidad o polvo húmedo), deben utilizarse filtros especiales para evitar que se produzcan cortocircuitos en el equipo.
- MONO a prueba de vibraciones mecánicas y sacudidas.
- MONO con cuatro tornillos Ø M4 en las **lengüetas de montaje (1)**.
- Ver las dimensiones de instalación en la página 3 (Size)

Conexión

- La conexión de MONO únicamente la puede realizar personal especializado.
- El cable de alimentación principal deberá constar de un dispositivo adecuado para la desconexión de todos los polos de la red.
- El equipo debe conectarse conforme al esquema de conexión y a la colocación de los terminales referidos en la página 4 ("Wiring Diagram") de las instrucciones de servicio:
 - Efectuar el cableado **de la caja de empalme (9)**.
- Tender el **cable tipo racor para la alimentación principal (5)** y el **cable tipo racor para la interfaz (6)**.
- Montar la **tapa de la caja de empalme (2)** con los **tornillos (3)**.
- Montar la manguera de aire en el **orificio de soplado (4)** con la abrazadera para manguera. A ser posible, utilizar mangueras cortas para evitar que se pierda flujo de aire.
- Conectar MONO a la red eléctrica.
- Conectar la red.

Descripción de pantalla

Símbolos	Símbolos
 Subtensión	 Ponerse en contacto con el servicio técnico de Leister
 Standby	 Soplador activado
 Campo del indicador para la representación de unidades o información para el menú de servicio	
 Cuadro de valor para la representación de los valores teóricos y reales. Se trata de un indicador de cuatro segmentos sin punto decimal	

El diagrama de barras representa las revoluciones del soplador en 5 etapas.
Al mismo tiempo, aparece la indicación en % (1 P – 100 P)

 Revoluciones del soplador 100 % máx.

 Revoluciones del soplador 1 % máx.

Función protección del equipo

Si se sobrecalienta el equipo (temperatura de entrada de aire demasiado elevada o acumulación de calor), se desconectará el motor y se abrirá al mismo tiempo el contacto de alarma del relé. Si se quema la protección del equipo, deben tenerse en cuenta los siguientes pasos para el reinicio del equipo por motivos de seguridad:



MONO SYSTEM

- A Dejar enfriar el equipo
- B Desconectar el equipo de la red
- C Volver a conectar el equipo a la red eléctrica transcurridos 10 s
- D Comprobar el orificio de entrada/salida de aire y limpiarlo si fuese necesario.

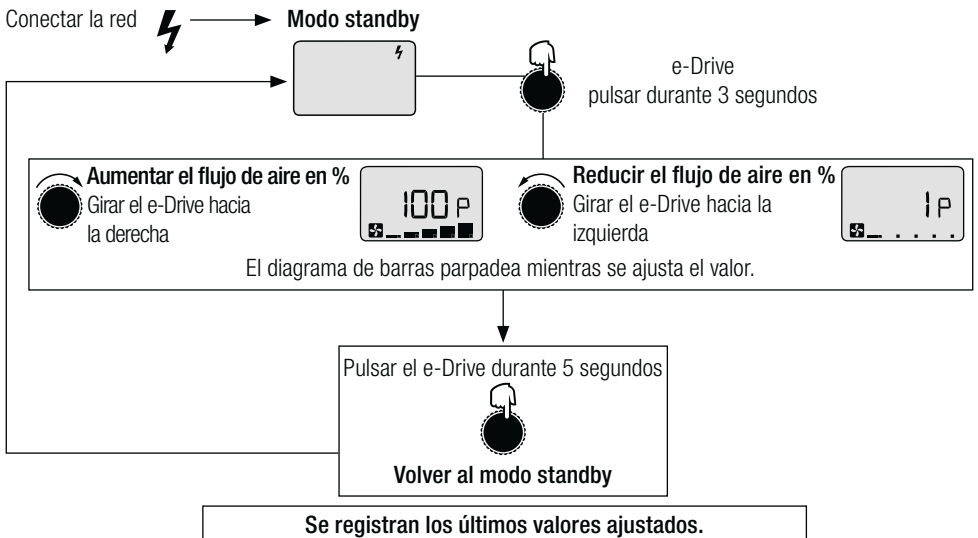
Manejo



Configuración menú setup

e-Drive	Función	e-Drive	Función
	pulsar una vez brevemente = activación		girar hacia la derecha
	pulsar durante 3 segundos = confirmación		girar hacia la izquierda





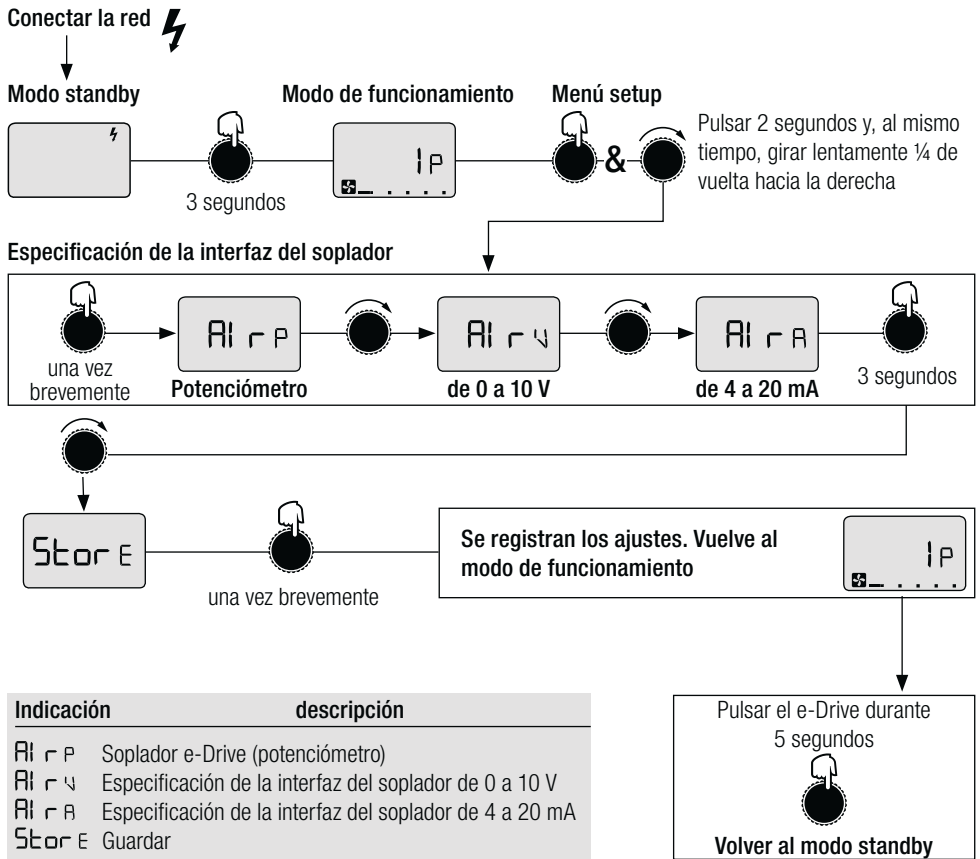

Indicación:

Si el e-Drive se pulsa brevemente una vez sin confirmación, los valores no se registran.



Mensajes de error

Indicación	Denominación	Causa del error	Corrección del error
E005  	Subtensión	Tensión de red < 20 % de la tensión nominal	Comprobar tensión de red
		Equipo defectuoso	Ponerse en contacto con el servicio técnico de Leister
E004 	Ponerse en contacto con el servicio técnico de Leister		
E007 			
E009 			

Formación

Leister Technologies AG y el servicio técnico autorizado ofrecen cursos gratuitos para familiarizarse con su utilización. Más información en www.leister.com

Planos en 3D

Están disponibles planos en 3D en su servicio técnico de Leister o en www.leister.com.

Accesorios

- Solo se deben emplear accesorios de Leister.
- Leister ofrece una amplia gama de accesorios, p. ej.,
 - Abrazadera para manguera
 - Manguera de aire \varnothing 38 mm de PVC
 - Filtro de acero inoxidable, deslizable en las tubuladuras de aspiración
- Accesorios en www.leister.com

Asistencia y reparaciones

- Solo el servicio técnico de Leister está autorizado a realizar reparaciones en el dispositivo. Este garantiza un servicio de reparación profesional y de confianza en un plazo razonable con piezas de repuesto originales conforme a los esquemas de conexiones y a las listas de piezas de repuesto.

Garantía

- Para este dispositivo tienen validez los derechos de garantía comercial o legal concedidos por el socio de distribución directo/el vendedor a partir de la fecha de compra. En caso de que exista derecho de garantía comercial o legal (certificación mediante factura o albarán de entrega), el socio de distribución subsanará los daños de fabricación o tratamiento con una entrega de reposición o una reparación. Las resistencias están excluidas de la garantía.
- Cualquier otro derecho de garantía comercial o legal se excluirá en el marco del derecho imperativo.
- Los daños provocados por el desgaste natural del equipo, sobrecarga o manejos inadecuados quedan excluidos de la garantía.
- No habrá ningún derecho de garantía comercial o legal en el caso de los dispositivos que hayan sido alterados o modificados por el comprador.



Antes da colocação em funcionamento, leia atentamente o manual de instruções e guarde-o para futuras consultas.

Soprador de alta pressão MONO SYSTEM

Utilização

O soprador MONO da Leister é adequado para montagem em máquinas, instalações ou equipamentos, e foi projetado para operação contínua sem manutenção.

- Alimentação de ar de aquecedores de ar Leister, para suprimento de ar fresco e para refrigeração.
- É adequado para transporte de ar e de gases não inflamáveis, não agressivos e não explosivos.



Aviso



Perigo de vida ao abrir o equipamento, caso os componentes e as conexões sob tensão fiquem expostos. Antes de abrir o equipamento, todos os polos deste devem ser desconectados da rede.



Cuidado



Tensão nominal, que está especificada no aparelho, deve coincidir com a tensão da rede.



O aparelho **deve ser operado** sob supervisão. O aparelho deve ser utilizado somente por **profissionais treinados** ou sob supervisão deles. A utilização por crianças é totalmente proibida.



Proteger o aparelho **contra umidade e água**.

Declaração de incorporação

(Na acepção da Diretriz de Máquinas CE 2006/42; anexo II B)

A Leister Technologies AG, Galileo-Strasse 10, CH-6056 Kaegiswil/Suíça declara que a máquina incompleta

Designação: **Soprador de alta pressão**

Tipo: **MONO**

Modelo: **SYSTEM**

– desde que possível no âmbito do fornecimento – atende aos requisitos básicos aplicáveis da Diretriz de Máquinas CE (2006/42).

Além disso, a máquina incompleta atende aos requisitos das seguintes Diretrizes CE:

Diretrizes CE: Compatibilidade eletromagnética 2004/108

Diretriz de Baixa Tensão 2006/95

Diretriz de Restrição ao Uso de Certas Substâncias Perigosas 2011/65

Normas harmonizadas: EN 12100, EN 55014-1, EN 55014-2, EN 61000-6-2, EN 61000-3-2,

EN 61000-3-3, EN 62233, EN 60335-1, EN 50581

Além disso, esclarecemos que, para esta máquina incompleta, os documentos técnicos especiais foram elaborados de acordo com o anexo VII (parte B) e nos comprometemos a transmiti-los eletronicamente às autoridades de fiscalização do mercado, mediante pedido devidamente fundamentado.

Nome do gestor da documentação: Volker Pohl, Manager Product Conformity

A colocação em funcionamento da máquina incompleta é proibida até que eventualmente tenha sido constatado que a máquina, na qual foi instalada a máquina incompleta, atende aos requisitos da Diretriz de Máquinas CE (2006/42).

Kaegiswil, 24/06/2015

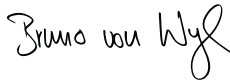

Bruno von Wyl, CTO

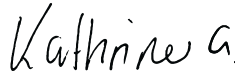



Andreas Kathriner, GM

Descarte



Ferramentas elétricas, acessórios e embalagens devem ser conduzidos para uma reciclagem compatível com o ambiente. **Somente para países da UE:** Não jogue ferramentas elétricas no lixo doméstico! De acordo com a Diretriz Europeia 2002/96 sobre resíduos de equipamentos elétricos e eletrônicos e sua transposição para a legislação nacional, as ferramentas elétricas não mais utilizáveis devem ser coletadas separadamente e conduzidas para uma reciclagem compatível com o ambiente.

Dados técnicos

Versão de motor		Motor sem escovas	
Tensão	V~	120	230
Potência	W	120	120
Frequência	Hz	50 / 60	
Temperatura máx. de entrada do ar	°C	60	
Temperatura ambiente máx.	°C	65	
Volume máx. de ar (20°C ambiente)	l/min.	250 – 600	
Pressão estática máx.	kPa	3,5	
Nível de emissão	dB(A)	65	
Peso	kg	1,0	
Interface (sem potencial)		4 – 20 mA & 0 – 10 V volume de ar, Saída de alarme	
Dimensões (tamanho)		Página 3	
Marca de conformidade		 (ErP n/a)	
Classe de proteção II			

Sujeito a alterações técnicas

Dados técnicos Funcionamento do aparelho

MONO 6	SYSTEM
Unidade de operação e-Drive	•
Proteção do aparelho	•
Saída de alarme (contato de relé)	•
Interface de controle remoto para especificação de volume de ar	•
Display	•

Dados técnicos Interface

Geral	Isolamento IEC/EN 60747-5-2	CA 1414 Vpico
	Proteção contra inversão de polaridade	
	Correção do ponto zero	
Entradas de tensão	Tensão 0 – 10 V	CC 0...10 V (ondulação < 0,4 V com resolução de 5%)
	Tensão máx. de entrada	CC 12 V
	Resistência nominal de entrada	33,7 kOhm
Entradas de corrente	Corrente 4–20 mA (tecnologia de 2 condutores)	CC 4...20 mA (ondulação < 0,7 mA com resolução de 5%)
	Corrente máx. de entrada	CC 22 mA
	Resistência nominal de entrada	159 Ohm
Saída de alarme (contato de relé)	Tensões máx.	CA 250 V, CC 30 V
	Correntes máx.	CA 3 A, CC 3 A
	Resistência máx. de contato	100 mOhm em CC 24 V / 1 A
	Tipo de contato	Um polo, uma posição - NA
	Isolamento contato para bobina	CA 4000 V 1 min
	Isolamento contato para contato	CA 1000 V 1 min

Dados técnicos Funções

e-drive ou interface

Volume de ar

Especificação de volume de ar 1, 5...100%;
5% de resolução

Diagrama de temperatura/volume de ar

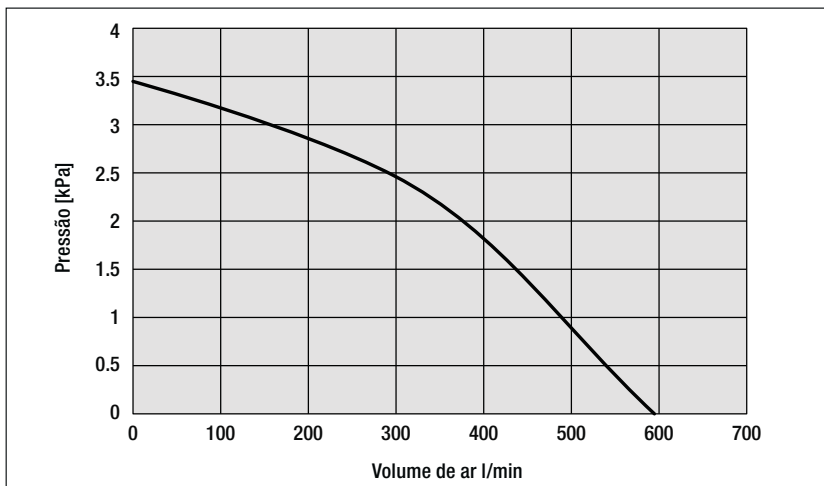

Interface / ativação

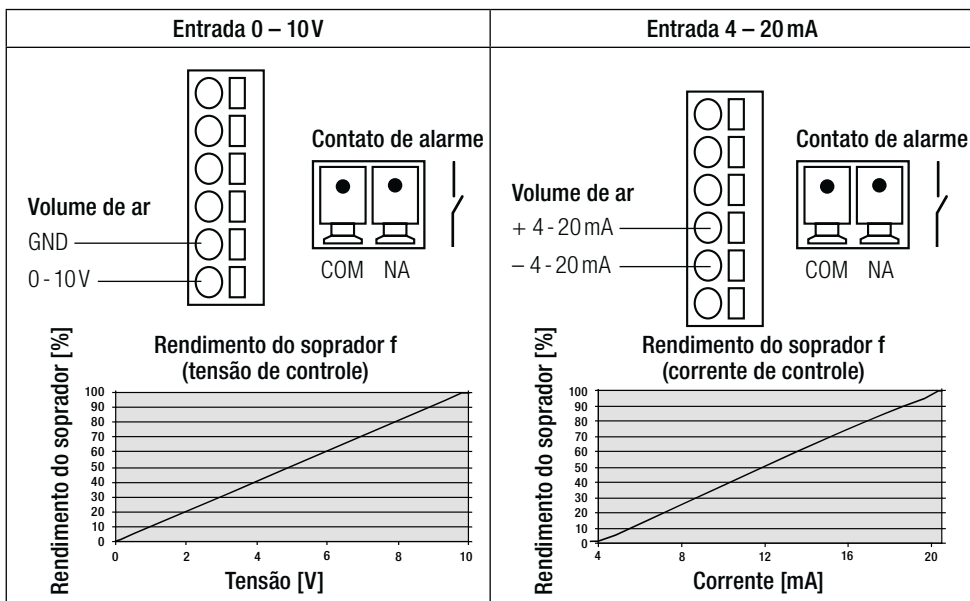

ATENÇÃO:

Em caso de utilização como aparelho de incorporação, na conexão à rede deve haver um dispositivo adequado para a desconexão de todos os polos da rede elétrica com uma distância de contato de no mínimo 3mm.

Descrição do aparelho

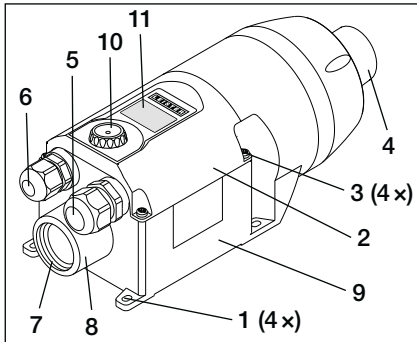

- 1 Abas de montagem
- 2 Tampa da caixa de conexões
- 3 Parafusos para caixa de conexões
- 4 Saída do ar de exaustão / conexão do tubo \varnothing 38 mm
- 5 União roscada do cabo para conexão à rede
- 6 União roscada do cabo para interface
- 7 Flange de entrada de ar com rosca interna G 1"
- 8 Conexão \varnothing 38 para tubo de ar ou filtro de aço inoxidável
- 9 Caixa de conexões
- 10 e-drive para ajuste de ar
- 11 Display

Preparação

- Retirar o MONO da embalagem.
- Soltando os **parafusos (3)**, abrir a **tampa da caixa de conexões (2)**.
- Soltar a **união roscada do cabo para conexão à rede (5)**.
- Se necessário, soltar a **união roscada do cabo para interface (6)**.







Montagem

- O aparelho deve ser instalado somente por profissionais treinados.
- A temperatura ambiente não pode ser superior a 60°C
- A montagem deve garantir que
 - seja fornecido apenas ar frio.
 - nenhum jato de ar quente de outro equipamento passe através do aparelho.
- Em ar com teor de poeira utilizar filtro de aço inoxidável Leister (ver Acessórios) e colocar sobre a **conexão \varnothing 38 para tubo de ar ou filtro de aço inoxidável (8)**.
- Em caso de pó particularmente crítico (p. ex. pó metálico, condutor ou úmido), devem ser utilizados filtros especiais para evitar curtos-circuitos no aparelho.
- Proteger o MONO contra vibrações e choques mecânicos.
- Fixar o MONO com quatro parafusos \varnothing M4 nas **abas de montagem (1)**.
- Dimensões de montagem, ver página 3 (tamanho)

Conexão

- O MONO deve ser conectado por pessoal qualificado.
- Na conexão à rede, deve haver um dispositivo adequado para a desconexão de todos os polos da rede elétrica!
- O aparelho deve ser conectado de acordo com o esquema de conexões e a disposição dos bornes na página 4 (circuito elétrico) do manual de instruções:
 - Executar a fiação na **caixa de conexões (9)**.
- Apertar a **união roscada do cabo para conexão à rede (5)** e **união roscada do cabo para interface (6)**.
- Montar a **tampa da caixa de conexões (2)** com os **parafusos (3)**.
- Montar o tubo de ar na **saída do ar de exaustão (4)** com braçadeira de tubo. Use tubos mais curtos possíveis para evitar perdas de volume de ar.
- Conectar o MONO à rede elétrica.
- Ligar a rede elétrica.

Descrição do display

Símbolos	Símbolos
 Subtensão	 Entrar em contato com o serviço de assistência Leister
 Stand-by	 Soprador ativo
	Campo do indicador para representação de unidades ou informações para o menu de serviço
	Campo de valores para representação dos valores nominais e reais. Trata-se de um display de segmentos de 4 dígitos sem ponto decimal

A barra de progresso simboliza a velocidade de rotação do soprador em 5 níveis. Ao mesmo tempo aparece a exibição em % (1 P – 100P)

 Velocidade de rotação do soprador 100% máx.

 Velocidade de rotação do soprador 1% mín.

Função Proteção do aparelho

Se o aparelho superaquecer (temperatura de entrada de ar muito elevada ou contrafluxo quente), o motor é desligado e ao mesmo tempo é aberto o contato de trabalho do relé de alarme. Se a proteção do aparelho atuar, por motivos de segurança devem ser observados os seguintes passos para o reset do aparelho:



MONO SYSTEM

- A Deixar o aparelho resfriar
- B Desconectar o aparelho da rede elétrica
- C Reconectar o aparelho à rede elétrica após 10 segundos
- D Verificar a entrada de ar, orifício de saída de ar e, se necessário, limpar.

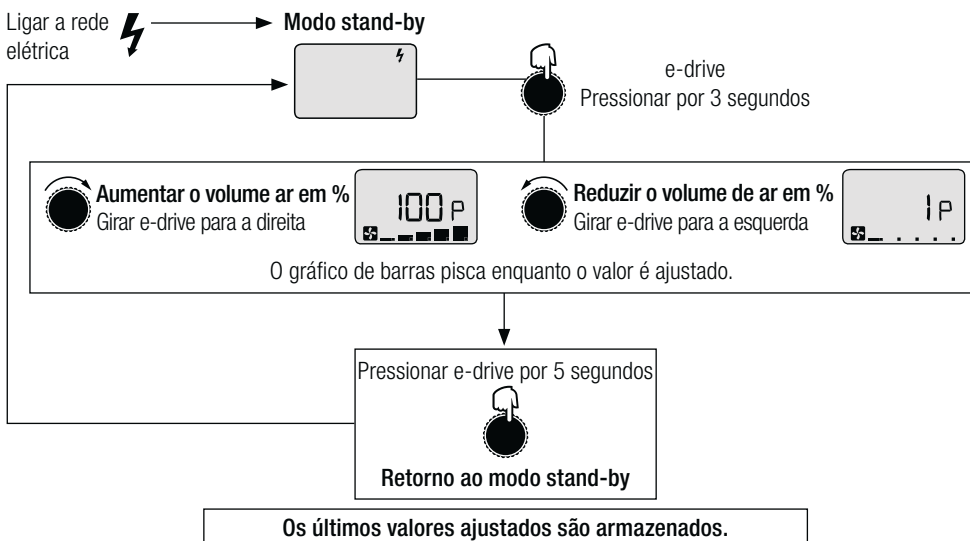
Operação



Menu setup de configuração

e-drive	Função	e-drive	Função
	pressionar brevemente uma vez = ativar		girar para a direita
	pressionar por 3 segundos = confirmar		girar para a esquerda



Observação:

Se o e-drive for pressionado brevemente uma vez sem confirmar, os valores não serão armazenados.

Ligar a rede elétrica 

Modo stand-by



Modo de operação



Menu de configuração



Pressionar por 2 segundos e ao mesmo tempo girar lentamente ¼ de volta para a direita

Especificação da interface do soprador

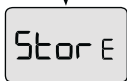
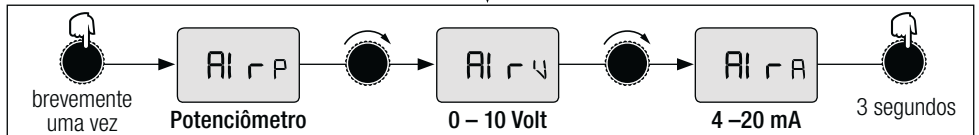

Os ajustes são armazenados. Retorno ao modo de operação



Exibição Descrição





AI r P	Soprador e-drive (potenciômetro)
AI r V	Especificação da interface para soprador 0 - 10 V
AI r A	Especificação da interface para soprador 4 - 20 mA
Stor E	Armazenar

Pressionar e-drive por 5 segundos



Retorno ao modo stand-by

Mensagens de erro

Indicação	Designação	Causa do erro	Solução do erro
E005  	Subtensão	Tensão da rede < 20% da tensão nominal	Verificar a tensão da rede
		Aparelho com defeito	Entrar em contato com o serviço de assistência Leister
E004 	Entrar em contato com o serviço de assistência Leister		
E007 			
E009 			

Treinamento

A Leister Technologies AG bem como seu serviço de assistência autorizado oferecem cursos gratuitos na área das aplicações. Informações em www.leister.com

Desenhos 3D

Desenhos 3D estão disponíveis no seu serviço de assistência ou em www.leister.com.

Acessórios

- Somente podem ser utilizados acessórios Leister.
- A Leister oferece uma vasta gama de acessórios, p.ex.
 - braçadeira de tubo flexível
 - tubo flexível de ar \varnothing 38 mm de PVC
 - filtro de aço inoxidável, adaptável ao bocal de aspiração
- Acessórios em www.leister.com

Serviço e reparo

- Os reparos devem ser executados exclusivamente por serviços de assistência Leister autorizados. Eles garantem um serviço de reparo preciso e confiável, dentro de um tempo razoável, com peças de reposição originais conforme os circuitos elétricos e as listas de peças de reposição.

Garantia

- Para este aparelho são válidos os direitos de garantia e de garantia adicional assegurados diretamente pelo distribuidor/vendedor, a partir da data de compra. No caso de uma reivindicação de garantia ou garantia adicional (comprovação através de nota fiscal ou nota de entrega) as falhas do fabricante ou de montagem do distribuidor são corrigidas com o fornecimento de peças de reposição ou reparo. As resistências estão excluídas da garantia ou garantia adicional.
- Outras pretensões de garantia ou garantia adicional ficam excluídas, no âmbito do direito imperativo.
- Danos causados por desgaste natural, sobrecarga ou manuseio incorreto estão excluídos da garantia.
- Não existe direito a reclamação ao abrigo da garantia ou garantia adicional em casos em que os aparelhos tenham sido reformados ou modificados pelo comprador.



İşletime almadan önce kullanım kılavuzunu dikkatli bir şekilde okuyun ve ileride başvurmak için saklayın.

Yüksek Basıncılı Fan MONO SYSTEM

Uygulama

Leister'in MONO fanı makine, tesis veya cihazlara montaj için uygun olup, bakım gerektirmeyen sürekli çalışma için tasarlanmıştır.

- Leister hava ısıtıcılarının hava beslemesi, temiz hava sağlama ve soğutma için.
- Havanın, yanıcı, aşındırıcı ve patlayıcı olmayan gazların pompalanması için uygundur.



Uyarı



Cihazın açılması sırasında, akım taşıyan bileşenler ve bağlantı elemanlarının muhafazası kalkacağından **ölüm tehlikesi**. Cihaz açılmadan önce tüm kutupların şebeke akımı ile bağlantılarının kesilmiş olması gerekir.



İkaz



Cihazın üzerinde belirtilen **çalışma voltajı**, şebeke voltajı ile aynı olmalıdır.



Cihaz **gözetimli olarak** kullanılmalıdır. Cihaz sadece **eğitim almış uzmanlar** tarafından veya onların gözetimi altında kullanılmalıdır. Cihazın çocuklar tarafından kullanılması tamamen yasaktır.



Cihazı **nem ve ıslaklıktan koruyun**.

İmalatçı beyanı

(2006/42 sayılı AT Makine direktifi Ek II B anlamında)

İşbu beyan ile, "Galileo-Strasse 10, CH-6056 Kaegiswil/Schweiz" adresinde mukim Leister Technologies AG firması, kısmen tamamlanmış makinenin

Tanım: **Yüksek Basıncılı Fan**

Tip: **MONO**

Model: **SYSTEM**

AT Makine direktifinin (2006/42) uygulanabilir temel gereksinimlerini - tedarik kapsamı elverdiğince - karşıladığını beyan eder.

Bunun haricinde kısmen tamamlanmış makine aşağıdaki AT direktif(ler)ini karşılar:

AT direktif(ler): 2004/108 Elektromanyetik Uyumluluk Direktifi

2006/95 Alçak Gerilim Direktifi

2011/65 RoHS Direktifi

Uyumlaştırılmış standartlar: EN 12100, EN 55014-1, EN 55014-2, EN 61000-6-2, EN 61000-3-2,

EN 61000-3-3, EN 62233, EN 60335-1, EN 50581

Ayrıca, kısmen tamamlanmış bu makine için Ek VII (Kısım B) uyarınca bazı özel teknik belgelerin hazırlanmış olduğunu beyan eder, bunları piyasa denetim makamlarına elektronik olarak iletmeyi taahhüt ederiz.

Dokümantasyon yetkilisinin adı: Volker Pohl, Manager Product Conformity

Kısmen tamamlanmış bu makinenin işleme alınması, gereğinde, kısmen tamamlanmış bu makinenin içine takıldığı makinenin AT Makine direktifine (2006/42) uygun olduğu tespit edilene kadar yasaktır.

Kaegiswil, 24.06.2015

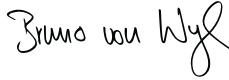

Bruno von Wyl, CTO



Andreas Kathriner, GM



Bertaraf etme



Elektrikli aletler, aksesuarlar ve ambalajlar çevre dostu geri kazanım için diğer atıklardan ayrı atılmalıdır.

Sadece AB ülkeleri için: Elektrikli aletleri evsel atıklar ile birlikte atmayın! Atık elektrikli ve elektronik cihazlar hakkındaki 2002/96 sayılı Avrupa Birliği direktifine ve buna uygun hale getirilmiş ulusal hükümlere göre, artık kullanıma uygun halde olmayan elektrikli cihazların ayrı toplanması ve çevre dostu geri kazanım için sevk edilmesi gerekmektedir.

Teknik veriler

Motor tasarımı		Fırçasız motor	
Gerilim	V~	120	230
Güç	W	120	120
Frekans	Hz	50 / 60	
Maks. hava giriş sıcaklığı	°C	60	
Maks. çevre sıcaklığı	°C	65	
Maks. hava miktarı (20 °C çevre)	l/min.	250 – 600	
Maks. statik basınç	kPa	3,5	
Emisyon seviyesi	dB(A)	65	
Ağırlık	kg	1,0	
Arayüz (potansiyelsiz)		4 – 20 mA & 0 – 10 V hava miktarı, alarm çıkışı için	
Kütle (Size)		Sayfa 3	
Uygunluk işareti		 (ErP n/a)	
Koruma sınıfı II			

Teknik değişiklik yapma hakkı mahfuzdur

Cihazın işleviyle ilgili teknik veriler

MONO 6	SYSTEM
e-Drive kumanda birimi	•
Cihaz koruması	•
Alarm çıkışı (Röle kontağı)	•
Hava miktarı bilgisi için uzaktan kumanda portu	•
Ekran	•

Bağlantı noktası teknik verileri

Genel	Yalıtım IEC/EN 60747-5-2	AC 1414 Vpeak
	Ters kutuplanma koruması	
	Sıfır nokta düzeltmesi	
Gerilim girişleri	Gerilim 0 – 10 V	DC 0...10 V (%5 çözünürlükte kırışıklık < 0.4 V)
	Maksimum giriş gerilimi	DC 12 V
	Nominal giriş direnci	33,7 kOhm
Akım girişleri	Akım 4–20 mA (2 iletken teknolojis)	DC 4...20 mA (%5 çözünürlükte kırışıklık < 0.7 mA)
	Maksimum giriş akımı	DC 22 mA
	Nominal giriş direnci	159 Ohm
Alarm çıkışı (Röle kontağı)	Maksimum gerilimler	AC 250 V, DC 30 V
	Maksimum akımlar	AC 3 A, DC 3 A
	Maksimum kontak direnci	DC 24 V / 1 A için 100 mOhm
	Kontakt türü	SPST-NO
	Kontaktan bobine yalıtım	AC 4000 V 1 dakika
Kontaktan kontakta yalıtım	AC 1000 V 1 dakika	

Teknik veriler işlevler

e-Drive veya arayüz

Hava miktarı

Hava miktarı öngörüsü 1, 5...100 %,
5 % çözünürlük

Sıcaklık/ hava miktarı grafiği

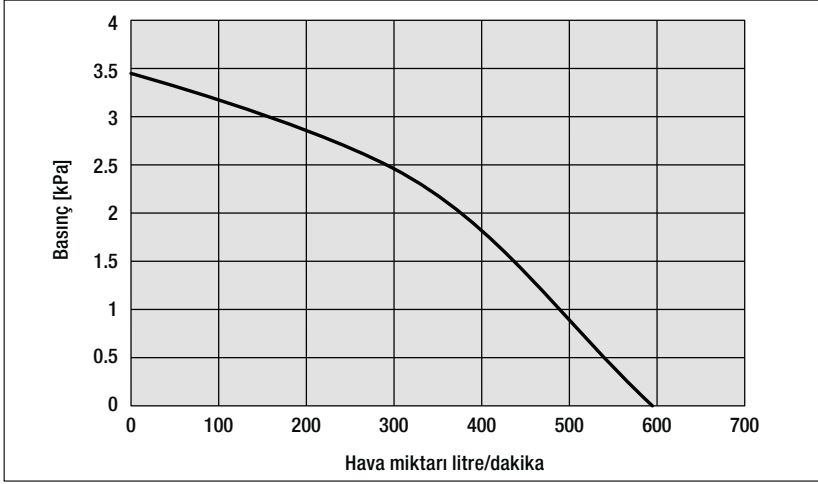

Bağlantı noktası / kumanda

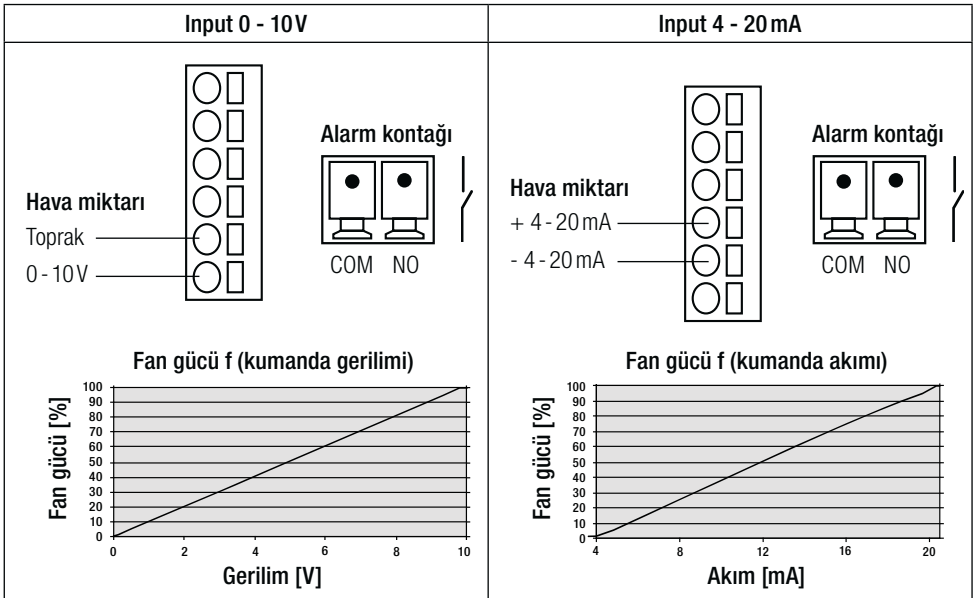

DİKKAT:

Bir ankastre cihaz olarak kullanıldığında elektrik şebekesine bağlantı noktasında **3 mm kontak aralığına sahip** bağlantıyı şebekeden **tüm kutuplarda kesen** uygun bir düzeneğin mevcut olması gerekir.

Cihaz tanımı

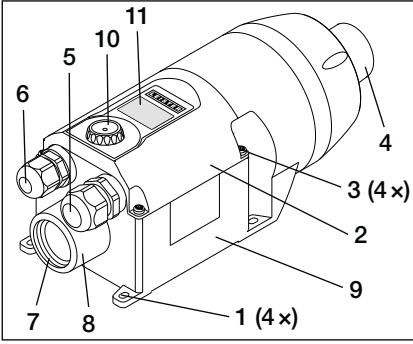

- 1 Montaj kulakları
- 2 Bağlantı muhafazası kapağı
- 3 Bağlantı muhafazası civataları
- 4 Üfleme ağzı / Hortum bağlantısı \varnothing 38 mm
- 5 Elektrik bağlantısının kablo rakorü
- 6 Bağlantı noktasının kablo rakorü
- 7 G 1 inç dışı hava giriş flanşı
- 8 Bağlantı \varnothing 38 , hava hortumu veya paslanmaz çelik filtre için
- 9 Bağlantı muhafazası
- 10 Sıcaklık/hava ayarı için e-Drive
- 11 Ekran

Hazırlık

- MONO'yu ambalajından çıkarın.
- Civataları (3) çözerek **bağlantı muhafazasının kapağını (2)** açın.
- **Elektrik bağlantısının kablo rakorunu (5)** çözün.
- Gerekirse **bağlantı noktasının kablo rakorunu (6)** çözün.







Montaj

- Cihaz yalnızca eğitimli teknik elemanlar tarafından takılabilir.
Çevre sıcaklığı 60 °C'yi geçmemelidir
- Montaj işlemi şunları sağlamalıdır:
 - Sadece soğuk hava girmeli.
 - Cihaza başka bir aletin sıcak hava akışı gelmemelidir.
- Tozlu havada Leister paslanmaz çelik filtresini (bkz. aksesuarlar) kullanın ve **hava hortumu veya paslanmaz çelik filtrenin (8) \varnothing 38 bağlantısına** takın.
- Cihazda kısa devreyi önlemek için özellikle (örneğin metal, elektriksel iletken veya nemli tozlar gibi) kritik tozlarda özel filtrelerin kullanılması gerekir.
- MONO'yu mekanik titreşimlerden ve sarsıntılardan koruyun.
- MONO'yu dört adet \varnothing M4 civatayla **montaj kulaklarına (1)** tutturun.
- Montaj ölçüleri için 3. sayfaya bakın (Size)

Bağlantı

- MONO, teknik personel tarafından bağlanmalıdır.
- Elektrik şebekesinden gerekli tüm kutuplu ayırımın sağlanması için elektrik bağlantısında uygun bir düzenek bulunmalıdır!
- Kullanım kılavuzunun 4. sayfasında bulunan bağlantı şemasına ve terminal düzenine (Wiring Diagram) göre cihazın bağlantısı yapılmalıdır:
 - Tesisat işlemine **bağlantı muhafazasında (9)** başlayın.
- **Elektrik bağlantısının kablo rakorunu (5)** ve **bağlantı noktasının kablo rakorunu (6)** sıkın.
- **Bağlantı muhafazasının (2) kapağını** civatalarla (3) monte edin.
- **Üfleme ağzındaki (4)** hava hortumunu, hortum kelepçesi kullanarak monte edin. Hava miktarında kayıpları önlemek için, olduğunca kısa hortumlar kullanın.
- MONO'yu elektrik şebekesine bağlayın.
- Şebekeyi açın.

Ekran açıklaması

Semboller	Semboller
 Düşük voltaj	 Leister servis merkeziyle irtibata geçin
 Standby	 Fan etkin
 Birimleri veya servis menüsü bilgilerini gösteren indikatör alanı	
 Nominal ve gerçek değerleri gösteren değer alanı. Burada ondalık işareti olmayan dört haneli bir gösterge söz konusudur	

Çubuk gösterge, 5 kademede fan devrini gösterir.
Aynı zamanda gösterge % olarak görünür (1 P – 100 P)



Fonksiyon Cihaz koruması

Cihaz aşırı ısındığında (çok yüksek hava giriş sıcaklığı veya ısı yığılması) motor kapatılır ve aynı zamanda alarm rölesinin çalışma kontağı açılır. Cihaz koruması devreye girdiğinde güvenlik tedbirleri gereği cihazın geri yüklemesi için aşağıdaki adımlara dikkat edilmelidir:



MONO SYSTEM

- Cihazı soğumaya bırakın
- Cihazı elektrik şebekesinden ayırın
- Cihazı 10 saniye sonra yeniden elektrik şebekesine bağlayın
- Hava giriş ve çıkış kapılarını kontrol edin ve gerekirse temizleyin.

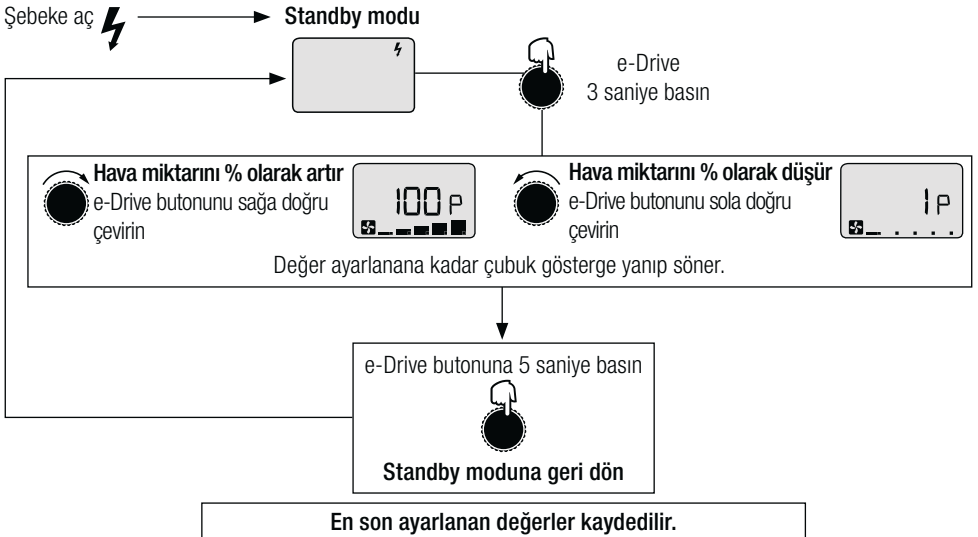
Kullanım



Ayar menüsü konfigürasyonu

e-Drive	Fonksiyon	e-Drive	Fonksiyon
	1 kez kısa basın = etkinleştir		sağa doğru çevirin
	3 saniye basın = onayla		sola doğru çevirin



Uyarı:

e-Drive butonuna onaylamadan 1 kez kısaca basılırsa değerler kaydedilmez.

Şebeke aç 

Standby modu



3 saniye

Çalışma modu



Ayar menüsü



2 saniyeliğine basın ve aynı anda yavaşça ¼ tur sağa doğru çevirin

Fan bağlantı noktası bilgisi

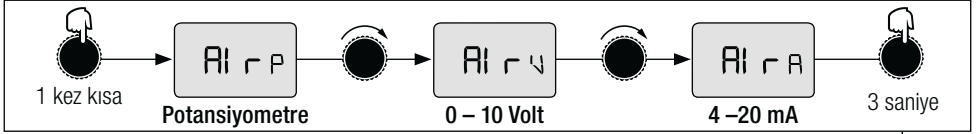

1 kez kısa

Potansiyometre

0 - 10 Volt

4 -20 mA

3 saniye



1 kez kısa

Ayarlar kaydedilir. Çalışma moduna geri dön



e-Drive butonuna 5 saniye basın







Standby moduna geri dön

Gösterge Açıklama

- AI r P Fan e-Drive (Potansiyometre)
- AI r V Fan bağlantı noktası bilgisi 0 - 10 V
- AI r A Fan bağlantı noktası bilgisi 4 - 20 mA
- Store Kaydet

Hata mesajları

Gösterge	Tanım	Hata nedeni	Hata giderme
E005 	Düşük voltaj	Şebeke gerilimi < %20 nominal gerilimden	Şebeke voltajını kontrol edin
		Cihaz arızalı	Leister servis merkeziyle irtibata geçin
E004 	Leister servis merkeziyle irtibata geçin		
E007 			
E009 			

Eğitim

Leister Technologies AG ve yetkili servis merkezleri uygulamalar konusunda ücretsiz kurslar sunmaktadır. • Bilgilere www.leister.com adresinden ulaşabilirsiniz

3 boyutlu çizimler

3 boyutlu çizimleri servis merkezinizden veya www.leister.com adresinden edinebilirsiniz.

Aksesuarlar

- Yalnızca Leister aksesuarları kullanılmalıdır.
- Leister geniş bir aksesuar yelpazesi sunmaktadır, ör.
 - Hortum kelepçesi
 - PVC'den hava hortumu \varnothing 38 mm
 - Emme ağzına takılabilir paslanmaz çelik filtre
- Aksesuarlara www.leister.com adresinden ulaşabilirsiniz

Servis ve Onarım

- Onarımların sadece yetkili Leister servis merkezlerine yaptırılması gerekmektedir. Bu servis merkezleri size, makul bir süre içinde, devre şemaları ile yedek parça listelerine uygun orijinal yedek parça kullanarak uzman ve güvenilir bir onarım hizmeti vermeyi garanti ederler.

Garanti

- Bu cihaz için doğrudan satış acentesi/satıcı tarafından sağlanan teminat ve garanti hakları satış tarihinden itibaren geçerlidir. Bir teminat veya garanti talebinde (sevk irsaliyesi veya faturayla belgelendirilmiş olmak kaydıyla) üretim veya işleme hataları distribütör tarafından, cihazı yenisi ile değiştirme veya onarma suretiyle giderilir. Isıtma elemanları teminat veya garanti kapsamı dışındadır.
- Ek teminat veya garanti talepleri zorunlu kanun kapsamı dışındadır.
- Normal aşınma, aşırı yüklenme veya yanlış kullanım nedeniyle oluşan hasarlar garanti kapsamı dışındadır.
- Üzerinde satın alan tarafından değişiklik veya tadilat yapılmış olan cihazlar teminat veya garanti kapsamı dışındadır.



Před uvedením do provozu si pozorně přečtěte návod k obsluze a uschovejte jej pro další použití.

Vysokotlaké dmychadlo MONO SYSTEM

Použití

Dmychadlo Leister MONO je vhodné k namontování do strojů, zařízení nebo přístrojů a je dimenzováno pro bezúdržbový trvalý provoz.

- K přivádění vzduchu do vzduchových ohřivačů Leister, k přivádění čerstvého vzduchu a k chlazení.
- Je vhodné k přivádění vzduchu, nehořlavých, neagresivních a nevýbušných plynů.



Výstraha



Smrtelné nebezpečí při otevření přístroje, protože se tím odkryjí součásti a přípojky pod napětím. Před otevřením přístroje se nejprve musí všemi póly odpojit od sítě.



Pozor



Jmenovité napětí, které je uvedeno na přístroji, se musí shodovat s napětím sítě.



Přístroj **musí být provozován** pod dohledem. Přístroj směř používat pouze **vyšškolení odborníci** nebo pracovníci pod jejich dohledem. Děti nesmějí přístroj používat za žádných okolností.



Chraňte **přístroj před vlhkostí a mokrem**.

Prohlášení o montáži

(ve smyslu směrnice ES o strojních zařízeních 2006/42; přílohy II B)

Společnost Leister Technologies AG, Galileo-Strasse 10, CH-6056 Kaegiswil / Švýcarsko tímto prohlašuje, že nekompletní stroj

Označení: **Vysokotlaké dmychadlo**

Typ: **MONO**

Provedení: **SYSTEM**

– pokud je to z rozsahu dodávky možné – vyhovuje aplikovatelným základním požadavkům směrnice ES o strojních zařízeních (2006/42).

Nekompletní stroj kromě toho vyhovuje požadavkům následujících směrnic ES:

Směrnice ES: Elektromagnetická kompatibilita 2004/108

Směrnice o nízkém napětí 2006/95

Směrnice RoHS 2011/65

Harmonizované normy: EN 12100, EN 55014-1, EN 55014-2, EN 61000-6-2, EN 61000-3-2,

EN 61000-3-3, EN 62233, EN 60335-1, EN 50581

Dále prohlašujeme, že pro tento nekompletní stroj byly vypracovány speciální technické podklady podle přílohy VII (část B) a zavazujeme se, že je na základě odůvodněné žádosti předáme v elektronické podobě úřadům pro sledování trhu.

Jméno zmocněnce pro dokumentaci: Volker Pohl, Manager Product Conformity

Uvést nekompletní stroj do provozu je zakázáno do té doby, dokud nebude zajištěno, že stroj, do něhož se nekompletní stroj namontuje, vyhovuje ustanovením směrnice ES o strojních zařízeních (2006/42).

Kaegiswil, 24.6.2015

Bruno von Wyl, CTO



Andreas Kathriner, GM

Likvidace



Elektrické nářadí, příslušenství a obaly se musí ekologicky recyklovat. **Pouze pro členské státy EU:** Nevyhazujte elektrické nářadí do domovního odpadu! Podle evropské směrnice 2002/96 o starých elektrických a elektronických zařízeních a jejího aplikování v národní legislativě se již nepoužitelné elektrické nářadí musí shromažďovat odděleně a ekologicky recyklovat.

Technické údaje

Provedení motoru		bezkartáčový elektromotor	
Napětí	V~	120	230
Výkon	W	120	120
Frekvence	Hz	50 / 60	
Max. vstupní teplota vzduchu	°C	60	
Max. teplota prostředí	°C	65	
Max. množství vzduchu (při teplotě prostředí 20 °C)	l/min.	250 – 600	
Max. statický tlak	kPa	3,5	
Hladina emisí	dB(A)	65	
Hmotnost	kg	1,0	
Rozhraní (izolované)		4 – 20 mA & 0 – 10 V pro množství vzduchu, výstup alarmu	
Rozměry (Size)		strana 3	
Značka shody		 (ErP n/a)	
Třída ochrany II			

Technické změny vyhrazeny

Technické údaje k funkci přístroje

MONO 6	SYSTEM
Ovládací jednotka e-Drive	•
ochrana přístroje	•
Výstup alarmu (reléový kontakt)	•
Rozhraní dálkového ovládání pro nastavení množství vzduchu	•
Displej	•

Technické údaje rozhraní

Obecně	Izolace IEC/EN 60747-5-2	AC 1414 V peak
	Ochrana proti přepólování	
	Korekce nulového bodu	
Napěťové vstupy	Napětí 0 – 10 V	DC 0...10 V (zvlnění < 0,04 V při rozlišení 5 %)
	Max. vstupní napětí	DC 12 V
	Jmenovitý vstupní odpor	33,7 kOhm
Proudové vstupy	Proud 4–20 mA (dvouvodičová technika)	DC 4...20 mA (zvlnění < 0,07 V při rozlišení 5 %)
	Max. vstupní proud	DC 22 mA
	Jmenovitý vstupní odpor	159 Ohm
Výstup alarmu (reléový kontakt)	Max. napětí	AC 250 V, DC 30 V
	Max. proud	AC 3 A, DC 3 A
	Max. kontaktní odpor	100 mOhm při DC 24 V / 1 A
	Druh kontaktu	SPST-NO
	Izolace kontaktu k cívice	AC 4000 V 1 min.
Izolace kontaktu ke kontaktu	AC 1000 V 1 min.	

Technické údaje funkcí

e-Drive nebo rozhraní Množství vzduchu

Nastavení množství vzduchu 1, 5...100 %;
rozdílení 5 %

Diagram teploty / množství vzduchu

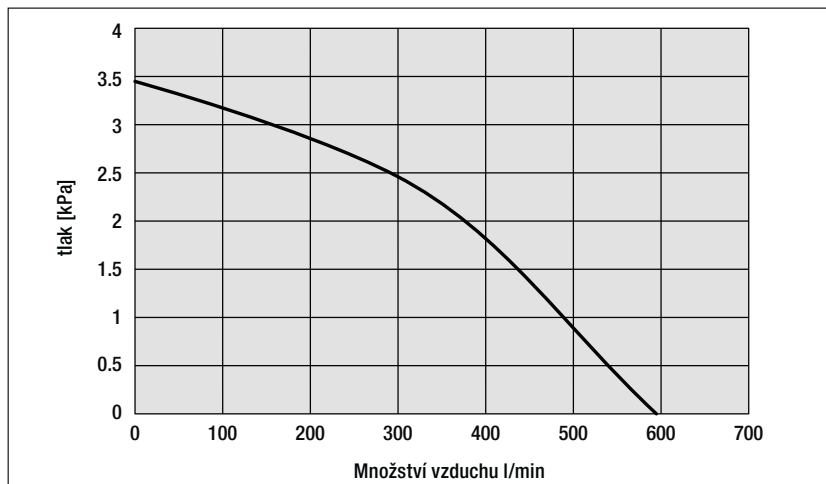

Rozhraní/řízení

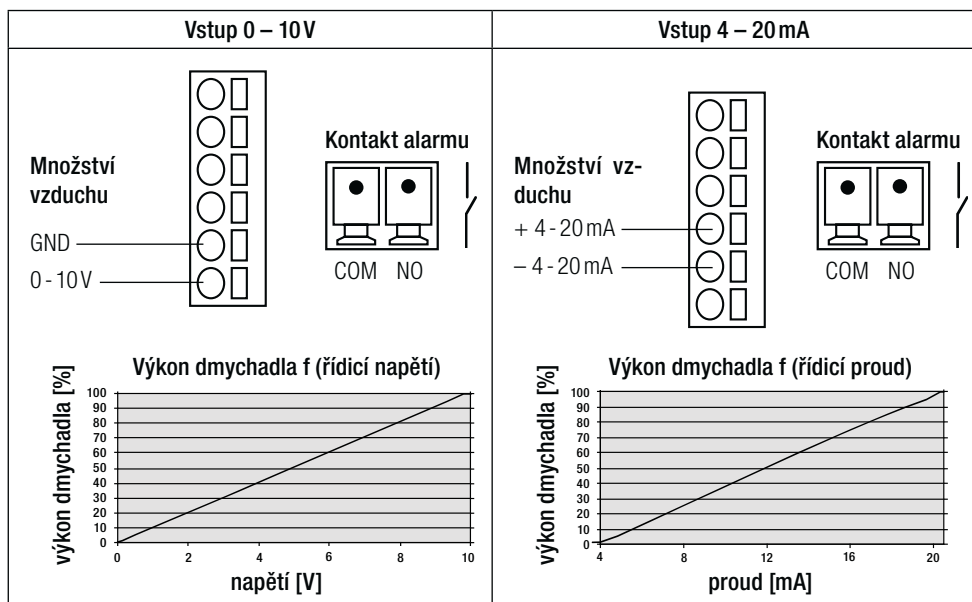

POZOR:

V případě používání jako vestavného přístroje musí být v síťové přípojce nainstalováno vhodné zařízení **pro odpojení od sítě** na všech pólech se vzdáleností mezi kontakty alespoň 3 mm.

Popis přístroje

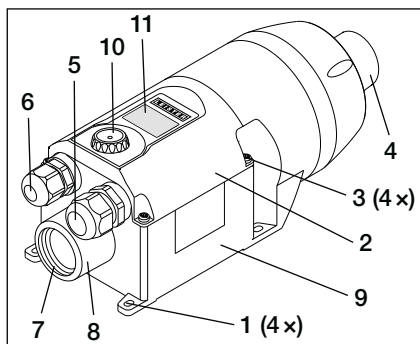

- 1 montážní úchyty
- 2 kryt připojovací skříně
- 3 šrouby připojovací skříně
- 4 výfukový otvor / hadicová přípojka \varnothing 38 mm
- 5 kabelové šroubení pro síťovou přípojku
- 6 kabelové šroubení pro rozhraní
- 7 příruba přívodu vzduchu s vnitřním závitem G 1"
- 8 přípojka \varnothing 38 pro vzduchovou hadici nebo nerezový filtr
- 9 připojovací skříň
- 10 regulátor e-Drive pro nastavení vzduchu
- 11 displej

Příprava

- Vyměňte přístroj MONO z obalu.
- Povolením **šroubů (3)** otevřete **kryt připojovací skříně (2)**.
- **Povolte kabelové šroubení pro síťovou přípojku (5)**.
- V případě potřeby povolte **kabelové šroubení pro rozhraní (6)**.







Montáž

- Přístroj smějí montovat pouze vyškolení odborníci.
- Teplota prostředí nesmí být vyšší než 60 °C.
- Montáž musí zaručit, že
 - bude přiváděn jen studený vzduch.
 - na přístroj nebude foukat proud horkého vzduchu z jiného zařízení.
- V případě vzduchu s obsahem prachu použijte nerezový filtr Leister (viz příslušenství), který nasuňte na **přípojku \varnothing 38 pro vzduchovou hadici nebo nerezový filtr (8)**.
- V případě zvláště kritického prachu (např. kovový, elektricky vodivý nebo vlhký prach) se musejí použít speciální filtry, aby v přístroji nedocházelo ke zkratům.
- Chraňte přístroj MONO před mechanickými vibracemi a otřesy.
- Připevněte přístroj MONO čtyřmi šrouby \varnothing M4 vloženými do **montážních úchytlů (1)**.
- Montážní rozměry viz strana 3 (Size).

Připojení

- Přístroj MONO musejí připojovat odborníci.
- V síťové přípojce musí být nainstalováno vhodné zařízení pro odpojení od sítě na všech pólech!
- Přístroj se musí připojit podle schématu zapojení a uspořádání svorek na straně 4 (Wiring Diagram) návodu k obsluze:
 - Provedte propojení v **připojovací skříni (9)**.
- **Utáhněte kabelové šroubení síťové přípojky (5) a kabelové šroubení rozhraní (6)**.
- **Namontujte kryt připojovací skříně (2) pomocí šroubů (3)**.
- Pomocí hadicové spony namontujte na **výfukový otvor (4)** vzduchovou hadici. Použijte co nejkratší hadice, aby nedocházelo ke ztrátám objemu vzduchu.
- Připojte přístroj MONO k elektrické síti.
- Zapněte síťové napětí.

Popis symbolů na displeji

Symboly	Symboly
 podpětí	 Kontaktujte servisní středisko Leister.
 Pohotovostní režim	 dmychadlo aktivováno
 indikační pole pro zobrazení jednotek nebo informací pro servisní menu	
 pole hodnot pro zobrazení požadovaných a skutečných hodnot Zde se jedná o čtyřmístný segmentový displej bez desetinné čárky.	

Sloupcový ukazatel symbolizuje v 5 stupních otáčky dmychadla.
Současně se zobrazuje údaj v % (1 P – 100 P).



Otáčky dmychadla 100 % max.



Otáčky dmychadla 1 % min.

Funkce ochrany přístroje

Dojde-li k přehřátí přístroje (příliš vysoká teplota vstupního vzduchu nebo hromadění tepla), motor se vypne a zároveň se otevře pracovní kontakt relé alarmu. Zareaguje-li ochrana přístroje, je při vynulování přístroje nutné z bezpečnostních důvodů respektovat následující kroky.

SYSTÉM MONO



- A Nechte přístroj ochladit.
- B Přístroj odpojte z elektrické sítě.
- C Přístroj znovu připojte po 10 sekundách k elektrické síti
- D Zkontrolujte vstup vzduchu a výstupní otvor vzduchu, podle potřeby jej vyčistěte.

Obsluha

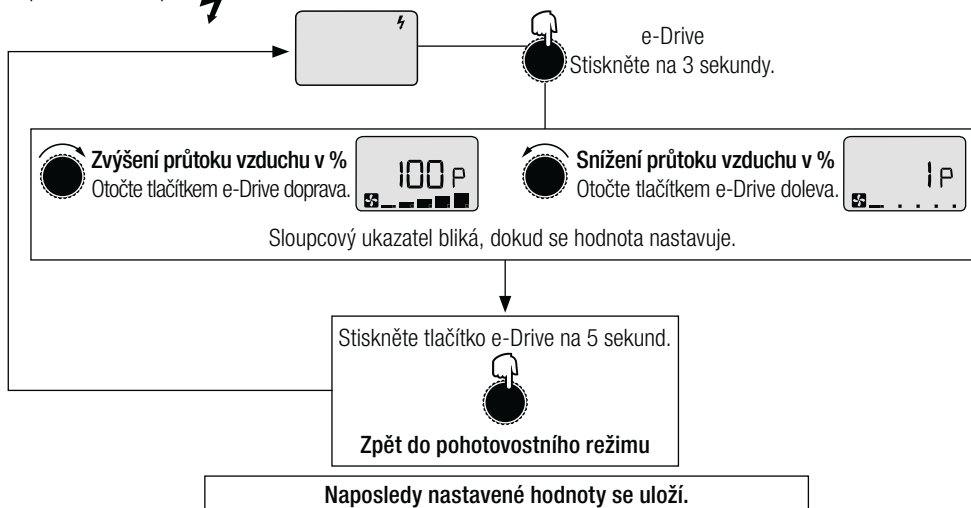
Zapněte síťové napětí.  → **Pohotovostní režim**



Konfigurační menu Setup

e-Drive	Funkce	e-Drive	Funkce
	1 krátké stisknutí = aktivace		otáčení doprava
	stisknutí na 3 sekundy = potvrzení		otáčení doleva



Upozornění:

Stisknete-li tlačítko e-Drive 1× krátce bez potvrzení, hodnoty se neuloží.

Zapněte síťové napětí. ⚡

Pohotovostní režim



3 sekundy

Provozní režim



Menu Setup



Stiskněte tlačítko na dobu 2 sekund a současně jím pomalu otočte o ¼ otočení doprava

Zadání rozhraní dmychadla

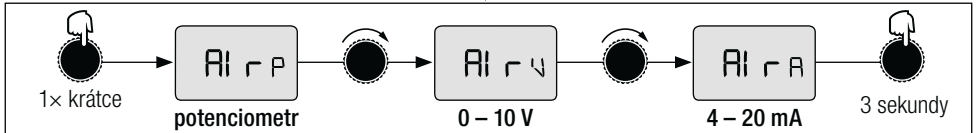

1× krátce

potenciometr



AI r V

0 - 10 V



AI r A

4 - 20 mA



3 sekundy



1× krátce

Nastavení se uloží. Zpět do provozního režimu



Indikace Popis





AI r P	Dmychadlo přes e-Drive (potenciometr)
AI r V	dmychadlo přes rozhraní 0 - 10 V
AI r A	dmychadlo přes rozhraní 4 - 20 mA
Stor E	uložení

Stiskněte tlačítko e-Drive na 5 sekund.



Zpět do pohotovostního režimu

Chybová hlášení

Zobrazení	Označení	Příčina závady	Odstranění závady
E005  	podpětí	Napětí sítě < 20 % jmenovitého napětí	Zkontrolujte síťové napětí
		Přístroj je vadný	Kontaktujte servisní středisko Leister
E004 	Kontaktujte servisní středisko Leister.		
E007 			
E009 			

Školení

Společnost Leister Technologies AG a její autorizovaná servisní střediska nabízejí bezplatné kurzy v oblasti aplikací. Další informace najdete na adrese www.leister.com.

3D výkresy

3D výkresy získáte u svého servisního střediska nebo na adrese www.leister.com.

Příslušenství

- Používat se smí pouze příslušenství firmy Leister.
- Leister nabízí široký sortiment příslušenství, např.
 - hadicová spona
 - vzduchová hadice ø 38 mm z PVC
 - nerezový filtr, nasouvací na sací hrdlo
- Příslušenství najdete na adrese www.leister.com.

Servis a opravy

- Opravy nechte provádět výhradně autorizovanými servisními středisky Leister. Pouze ta zaručí v rozumné době odbornou a spolehlivou opravu pomocí originálních náhradních dílů v souladu se schémata zapojení a katalogy náhradních dílů.

Odpovědnost za vady

- Pro tento přístroj platí práva ohledně záruky nebo odpovědnosti za vady, poskytnutá přímým odbytovým partnerem / prodejcem od data koupě. V případě záručního nároku nebo nároku z odpovědnosti za vady (prokázání fakturou nebo dodacím listem) jsou výrobní vady nebo chyby při zpracování odstraněny odbytovým partnerem prostřednictvím dodávky náhradních dílů nebo opravou. Topná tělesa jsou vyloučena z odpovědnosti za vady nebo záruky.
- Další záruční nároky nebo nároky z odpovědnosti za vady jsou vyloučeny v rámci kogentního práva.
- Škody vzniklé přirozeným opotřebením, přetížením nebo neodbornou manipulací jsou z odpovědnosti za vady vyloučeny.
- U přístrojů, na nichž kupující provedl úpravy nebo změny, nelze uplatnit žádné záruční nároky nebo nároky z odpovědnosti za vady.



Перед вводом в эксплуатацию следует внимательно прочитать данное руководство по эксплуатации и сохранить его для дальнейшего использования.

Высоконапорный нагнетатель MONO SYSTEM

Использование

Нагнетатель MONO компании Leister подходит для монтажа в машины, установки или устройства и предназначен для длительной эксплуатации без технического обслуживания.

- Подача воздуха для подогревателей воздуха компании Leister, для подвода свежего воздуха и для охлаждения.
- Подходит для транспортировки воздуха, невоспламеняющихся, неагрессивных и невзрывоопасных газов.



Предупреждение



Опасность для жизни при открывании устройства, так как находящиеся под напряжением компоненты и подключения ничем не закрыты. Перед тем как открыть устройство, необходимо отключить от сети все его полюса.



Внимание



Номинальное напряжение, указанное на устройстве, должно соответствовать сетевому напряжению.



Работающее устройство **должно находиться** под присмотром персонала. Устройство разрешается использовать только **квалифицированным специалистам** или под их надзором. Данный прибор категорически запрещено использовать детям.



Защитить устройство от влаги и сырости

Декларация о соответствии требованиям ЕС по монтажу

(согласно Директиве ЕС по машиностроению 2006/42; приложение II B).

Leister Technologies AG, Galileo-Strasse 10, CH-6056 Kaegiswil / Switzerland настоящим подтверждает, что некомплектная машина

Название: **высоконапорный нагнетатель**

Тип: **MONO**

Исполнение: **SYSTEM**

– если это позволяет объем поставки – соответствует применимым основополагающим требованиям Директивы ЕС по машиностроению (2006/42).

Данная некомплектная машина также соответствует требованиям следующих директив ЕС:

Директива(-ы) ЕС: Директива ЕС по электромагнитной совместимости 2004/108
Директива ЕС по низковольтному оборудованию 2006/95
Директива по ограничению содержания вредных веществ 2011/65

Гармонизированные

стандарты: EN 12100, EN 55014-1, EN 55014-2, EN 61000-6-2, EN 61000-3-2,
EN 61000-3-3, EN 62233, EN 60335-1, EN 50581

Кроме того, мы подтверждаем, что для данной некомплектной машины были составлены специальные технические документы согласно Приложению VII (часть B), и обязуемся предоставить их в электронном формате по обоснованному требованию государственных органов надзора за рынком.

Лицо, ответственное за документацию: Фолькер Поль, менеджер по соответствию продукции

Ввод данной некомплектной машины в эксплуатацию запрещается до тех пор, пока не будет установлено, что установка, в которую монтирована данная некомплектная машина, соответствует указаниям Директивы ЕС по машиностроению (2006/42).

Кегисвиль, 24.06.2015

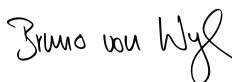

Бруно фон Вил (Bruno von Wyl),
руководитель технического отдела





Андреас Катринер (Andreas Kathriner),
генеральный директор

Утилизация



Электроинструменты, принадлежности и упаковки должны утилизироваться в соответствии с требованиями по охране окружающей среды. **Только для стран ЕС:** не выбрасывайте электроинструменты в хозяйственный мусор! В соответствии с Директивой Европейского Союза 2002/96 об отходах электрического и электронного оборудования и ее применением в международном праве электроинструменты, не пригодные для использования, необходимо собирать отдельно от других отходов и утилизировать в соответствии с требованиями по охране окружающей среды.

Технические характеристики

Исполнение двигателя		Бесщеточный двигатель	
Напряжение	В~	120	230
Мощность	Вт	120	120
Частота	Гц	50 / 60	
Макс. температура воздуха на входе	°С	60	
Макс. температура окружающей среды	°С	65	
Макс. расход воздуха (окр. среда 20 °С)	л/мин.	250 – 600	
Макс. статическое давление	кПа	3,5	
Уровень эмиссии	дБ(А)	65	
Вес	кг	1,0	
Интерфейс (беспотенциальный)		4 – 20 мА и 0 – 10 В для расхода воздуха, вывод аварийных сигналов	
Размеры (габариты)		Стр. 3	
Знак соответствия		 (ErP n/a)	
Класс защиты II			

Оставляем за собой право на технические изменения

Технические характеристики и функционирование устройства

MONO 6	SYSTEM
Устройство управления e-Drive	•
Защита устройства	•
Вывод аварийных сигналов (релейный контакт)	•
Интерфейс дистанционного управления для установки расхода воздуха	•
Дисплей	•

Технические характеристики интерфейса

Общие данные	Изоляция IEC/EN 60747-5-2	AC 1414 Vpeak
	Защита от неправильной полярности	
	Коррекция нуля	
Потенциальные входы	Напряжение 0 – 10 В	DC 0...10 В (допуск помех < 0.4 В при размыкании 5 %)
	Макс. входное напряжение	DC 12 В
	Номинальное входное сопротивление	33.7 кОм
Токовые входы	Ток 4–20 мА (2-провод. техника)	DC 4...20 мА (допуск помех < 0.7 мА при размыкании 5 %)
	Макс. входной ток	DC 22 мА
	Номинальное входное сопротивление	159 Ом
Вывод аварийных сигналов (контакт реле)	Макс. напряжение	AC 250 В, DC 30 В
	Макс. токи	AC 3 А, DC 3 А
	Макс. контактное сопротивление	100 мОм при DC 24 В/1 А
	Тип контакта	SPST-NO
	Изоляция контакта на катушку	AC 4000 В 1 мин.
Изоляция контакта на контакт	AC 1000 В 1 мин.	

Технические характеристики функций

e-Drive или интерфейс

Расход воздуха

Заданное значение расхода воздуха 1, 5...100 %; размыкание 5 %

Диаграмма температуры/ расхода воздуха

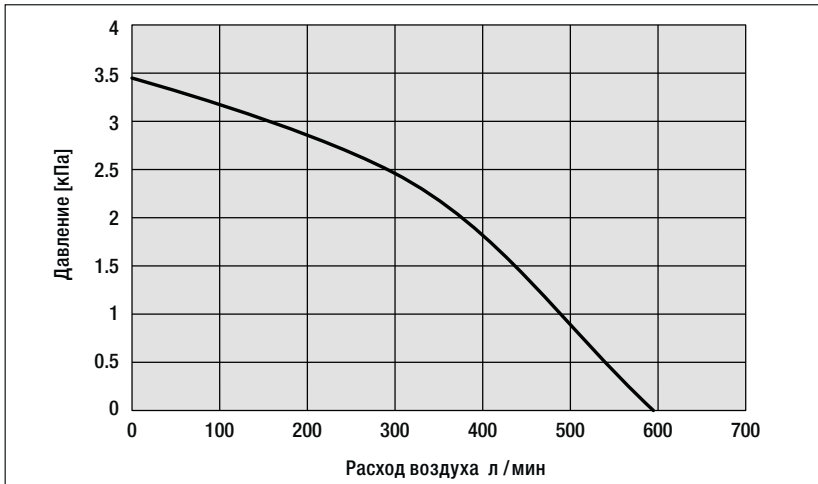

Интерфейс / настройка

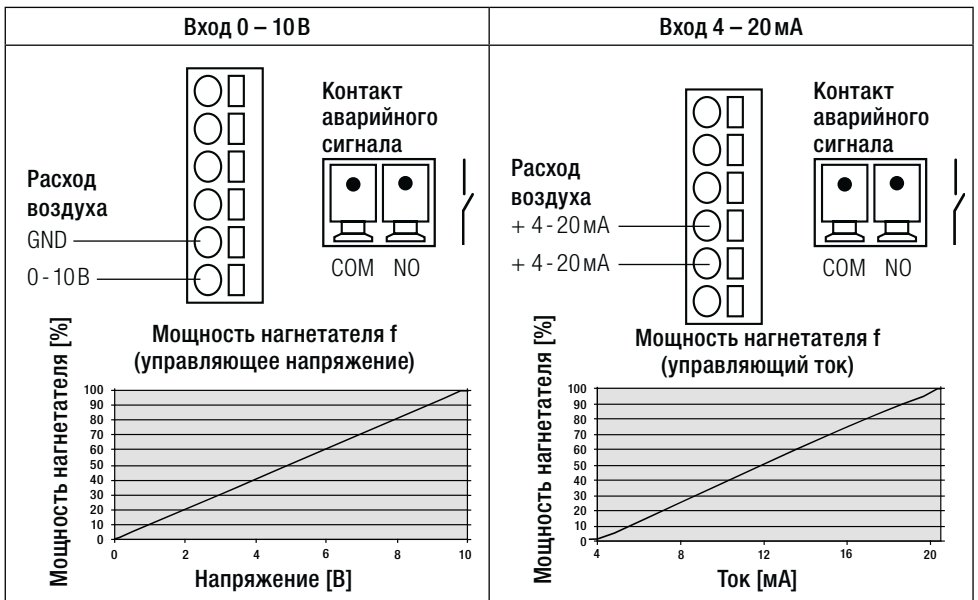

ВНИМАНИЕ!

При использовании для монтажа в другие установки гнездо подключения к сети должно быть оборудовано соответствующим устройством для разъединения от сети по всем полюсам с зазором между контактами как минимум 3 мм.

Описание прибора

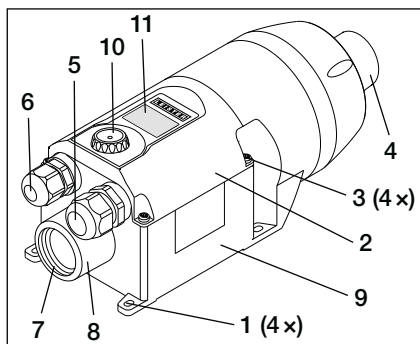

- 1 Монтажные петли
- 2 Крышка соединительного корпуса
- 3 Болты для соединительного корпуса
- 4 Отверстие для выхода воздуха / соединение для шланга \varnothing 38 мм
- 5 Кабельный ввод для сетевого соединения
- 6 Кабельный ввод для интерфейса
- 7 Фланец забора воздуха с внутренней резьбой G 1"
- 8 Соединение диаметром \varnothing 38 для шланга подачи воздуха или фильтра из нержавеющей стали
- 9 Соединительный корпус
- 10 e-Drive для регулировки подачи воздуха
- 11 Дисплей

Подготовка

- Вынуть устройство MONO из упаковки.
- Отвинтив болты (3), открыть крышку соединительного корпуса (2).
- Ослабить кабельный ввод для подключения к сети (5).
- При необходимости ослабить кабельный ввод для интерфейса (6).







Установка

- Монтаж устройства должен осуществляться только квалифицированным персоналом.
- Температура окружающей среды не должна превышать 60 °C
- При монтаже устройства необходимо:
 - обеспечить подачу только холодного воздуха;
 - исключить возможность воздействия на устройство потоков горячего воздуха, генерируемых другими устройствами.
- Если воздух содержит пыль, использовать фильтр из высококачественной стали Leister (см. принадлежности) и надвинуть его на патрубок \varnothing 38 для шланга для подачи воздуха или фильтра из высококачественной стали (8).
- При особых характеристиках пыли (например, влажная пыль или пыль, содержащая металлические или токопроводящие частицы) необходимо использовать специальные коротки фильтры, чтобы избежать возникновения коротких замыканий в устройстве.
- Устройство MONO защищено от механических вибраций и ударов.
- MONO крепится посредством четырех болтов диаметром M4 на монтажные петли (1).
- Информация о монтажных размерах приведена на стр. 3 («Габариты»).

Подключение

- Подключение MONO к электросети должно производиться квалифицированным персоналом.
- Гнездо подключения к сети должно быть оборудовано соответствующим устройством для разъединения по всем полюсам!
- Подключение устройства производится в соответствии со схемой электрических соединений и схемой расположения клемм на стр. 4 настоящего руководства по эксплуатации («Схема электрических соединений»):
 - провести электропроводку в соединительном корпусе (9).
- Затянуть кабельный ввод для сетевого соединения (5) и кабельный ввод для интерфейса (6).
- Установить крышку соединительного корпуса (2) с помощью болтов (3).
- Монтировать шланг для подачи воздуха в отверстие для выхода воздуха (4) с помощью зажима. Использовать как можно более короткие шланги, чтобы избежать потери воздуха.
- Подключить MONO к электрической сети.
- Подключить к сети.

Описание дисплея

Используемые символы		Используемые символы	
	Низкое напряжение		Свяжитесь с сервисным центром компании Leister
	Режим ожидания		Нагнетатель активирован
	Поле индикатора для отображения единиц или информации для сервисного меню		
	Поле для отображения заданного и фактического значений. Данный сегментный дисплей предназначен для четырехзначных чисел без десятичного разделителя		

Шкальный индикатор отображает 5 ступеней скорости вращения нагнетателя.
Одновременно появляется информация на дисплее в процентном выражении (1 P – 100 P)

 Частота вращения нагнетателя 100% макс.

 Частота вращения нагнетателя 1% мин.

Функционирование системы защиты устройства

При перегреве устройства (слишком большая температура воздуха на входе или обратного потока теплого воздуха) двигатель выключается и одновременно размыкается рабочий контакт сигнального реле. При срабатывании системы защиты из соображений безопасности следует выполнить нижеуказанные шаги для возврата устройства в исходное состояние:

MONO SYSTEM

- A Дать устройству остыть
- B Отсоединить устройство от электросети
- C Через 10 сек. снова подключить устройство к электросети
- D Проверить и при необходимости очистить отверстия для входа и выхода воздуха

Управление

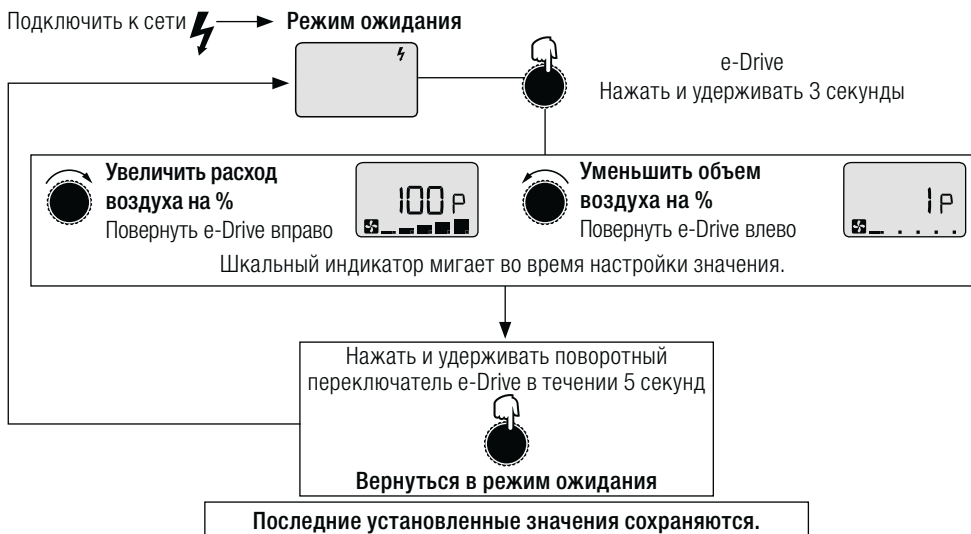

Конфигурация Меню настроек

e-Drive	Функция	e-Drive	Функция
	1× раз нажать и отпустить = активация		Повернуть вправо
	Нажать и удерживать 3 секунды = подтверждение		Повернуть влево



Примечание:

при однократном кратковременном нажатии поворотного переключателя e-Drive без последующего подтверждения значения не сохраняются.

Подключить к сети 

Режим ожидания



 Удерживать 3 секунды

Рабочий режим



Меню настроек



Нажать и удерживать в течении 2 секунд и одновременно медленно повернуть на ¼ оборота вправо

Заданные значения интерфейса нагревателя

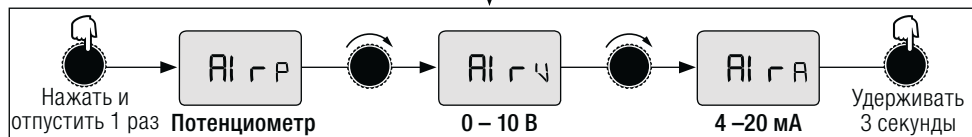

Нажать и отпустить 1 раз

AI r P Потенциометр

AI r Ч 0 – 10 В

AI r A 4 – 20 мА

Удерживать 3 секунды



Stor E

 Нажать и отпустить 1 раз

Настройки сохраняются. Вернуться в рабочий режим



Индикация

Описание





AI r P	e-Drive нагревателя (потенциометр)
AI r Ч	заданное значение интерфейса нагревателя 0 - 10 В
AI r A	заданное значение интерфейса нагревателя 4 – 20 мА
Stor E	сохранение

Нажать и удерживать поворотный переключатель e-Drive в течении 5 секунд



Вернуться в режим ожидания

Сообщения об ошибках

Индикация	Наименование	Причина ошибки	Устранение ошибки
E005 	Низкое напряжение	Сетевое напряжение < 20 % номинального напряжения	Проверить сетевое напряжение
		Устройство повреждено	Свяжитесь с сервисным центром компании Leister
E004 	Свяжитесь с сервисным центром компании Leister		
E007 			
E009 			

Обучение

Компания Leister Technologies AG и ее авторизованные сервисные центры предлагают пройти бесплатные курсы по возможностям применения. Подробная информация на сайте www.leister.com

Чертежи 3D

Чертежи 3D доступны в сервисных центрах и на сайте www.leister.com.

Принадлежности

- Разрешено использовать только оригинальные принадлежности Leister.
- Компания Leister предлагает широкий ассортимент принадлежностей, например:
 - зажим для шлангов;
 - шланг для подачи воздуха \varnothing 38 мм из ПВХ;
 - фильтр из высококачественной стали, устанавливаемый на впускной патрубке.
- Подробная информация о принадлежностях — www.leister.com

Сервисное обслуживание и ремонт

- Поручать проведение ремонтных работ только авторизованным сервисным центрам компании Leister. Эти центры гарантируют своевременное выполнение всех необходимых работ по ремонту и техобслуживанию с использованием оригинальных запасных частей согласно электрическим схемам и ведомостям запасных частей.

Гарантия

- На данное устройство, начиная с даты покупки, распространяются гарантийные обязательства или поручительство прямого дистрибьютора/продавца. При получении претензий по гарантии или поручительству (с предоставлением счета или накладной) производственные дефекты и дефекты обработки устраняются путем ремонта или замены устройства. Данная гарантия или поручительство не распространяется на нагревательные элементы.
- Другие претензии по гарантии или обязательству исключаются на основании императивных правовых норм.
- Данная гарантия не распространяется на неполадки, возникшие в результате естественного износа, перегрузки или ненадлежащего использования.
- Гарантия или поручительство теряет свою силу, если покупатель переоборудовал устройство или внес в него изменения.



投入运行之前 真 操作明
并妥善保存以备 使用。

高 鼓风机 MONO SYSTEM

用

丹的 MONO 鼓风机适用于安装在机器、装置或设备中，设 可 工作且无需 护。

- 丹 风机提供风源，用于输送新 空气以及冷却。
- 适用于输送非易燃、非腐 性和非爆炸性气体。



警告



打 设备会造成**生命危险**，因 裸露出 电部件和接口。打 设备之前必 其从电源上全极 。



小心



电源电 必 与设备上出的 定电 一致。



仪器**必在照管下**投入使用。可由**经培的 业人** 或在其 督下使用本 设备。
儿童 不可使用。



防止**设备受到潮** 。

安装明

(根据 盟机械指令 2006/42；附 II B)

Leister Technologies AG, Galileo-Strasse 10, CH-6056 Kaegiswil / Schweiz 声明，此非完整版机器

名： **高 鼓风机**
型号： **MONO**
设型： **SYSTEM**

— 只要供范允 — 符合适用的 盟机械指令 (2006/42) 的基本要求。

此非完整版机器符合下列 盟指令的要求：

盟指令： 电磁兼容性 2004/108
 低 指令 2006/95
 RoHS 指令 2011/65

统一 准： EN 12100、EN 55014-1、EN 55014-2、EN 61000-6-2、
 EN 61000-3-2、EN 61000-3-3、EN 62233、EN 60335-1、EN 50581

此外我 已按照附 VII (B 部分) 此非完整版机器 建了有技 料，并 合理要求 其以电子形式 提交市 督部门。

文献全 代表姓名：Volker Pohl，品 部经理

若集成此非完整版机器的设备不符合 盟机械指令 (2006/42)，不可 此非完整版机器在其 上安装。

Kaegiswil, 2015/6/24

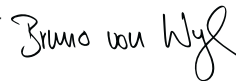

Bruno von Wyl, CTO





Andreas Kathriner, GM

物处理



电动工具、附件及包装均以 保方式 行回收。 **盟国家：**不要 电动工具按家庭垃圾 处理！根据 盟 于 电子电气设备的指令 2002/96 及相 实施的国家法律，无法再 使用的电动工具必 收集，并以 保方式回收处理。

技 据

电机 格		无刷电机	
电	V~	120	230
功率	W	120	120
率	Hz	50 / 60	
最高 风温度	°C	60	
最高 境温度	°C	65	
最大风量 (20 °C 境)	l/min.	250 – 600	
最大 风	kPa	3.5	
噪声等	dB (A)	65	
重量	kg	1.0	
接口 (不 电)		4 – 20 mA & 0 – 10 V 用于风量, 警 输出	
尺寸 (格)		第 3 页	
合格		 (ErP 无效)	
安全防护等 II			

保留技 更改

设备功能技 据

MONO 6	SYSTEM
e-Drive 操作 元	.
设备保护	.
警 输出 (电器触点)	.
风量 设值的 控接口	.
示器	.

接口技 据

常	IEC/EN 60747-5-2	AC 1414 Vpeak
	反极性保护	
	零点校正	
电 输入	电 0 – 10 V	DC 0...10 V (波动 < 0.4 V, 精度度 5 %)
	最大输入电	DC 12 V
	定输入电阻	33.7 kOhm
电流输入	电流 4–20 mA (2 技)	DC 4...20 mA (波动 < 0.7 mA, 精度度 5 %)
	最大输入电流	DC 22 mA
	定输入电阻	159 Ohm
可发出警 (电器触点)	最大电	AC 250 V, DC 30 V
	最大电流	AC 3 A, DC 3 A
	最大接触电阻	100 mΩ, DC 24 V / 1 A
	触点类型	SPST-NO
	到 圈的 接触	AC 4000 V 1 min.
到触点的 接触	AC 1000 V 1 min.	

功能技 据

e-Drive 或者接口

风量

风量 设值 1, 5...100 % ; 5 % 精准度

温度/风量

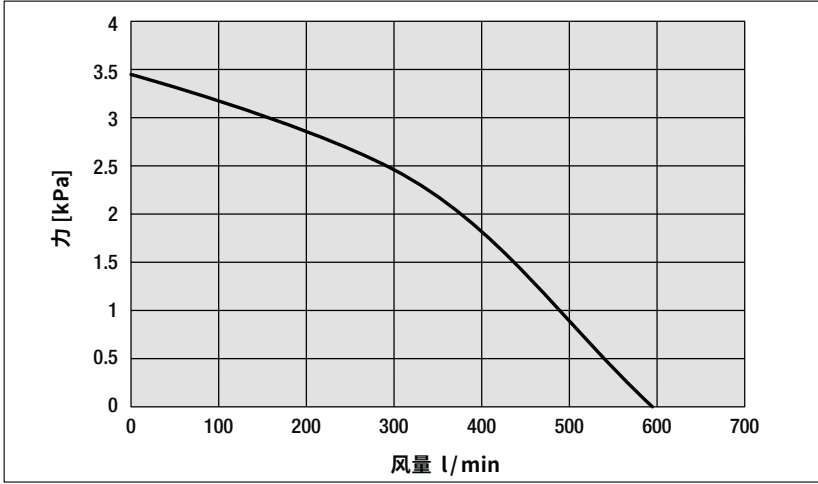

接口 / 控制

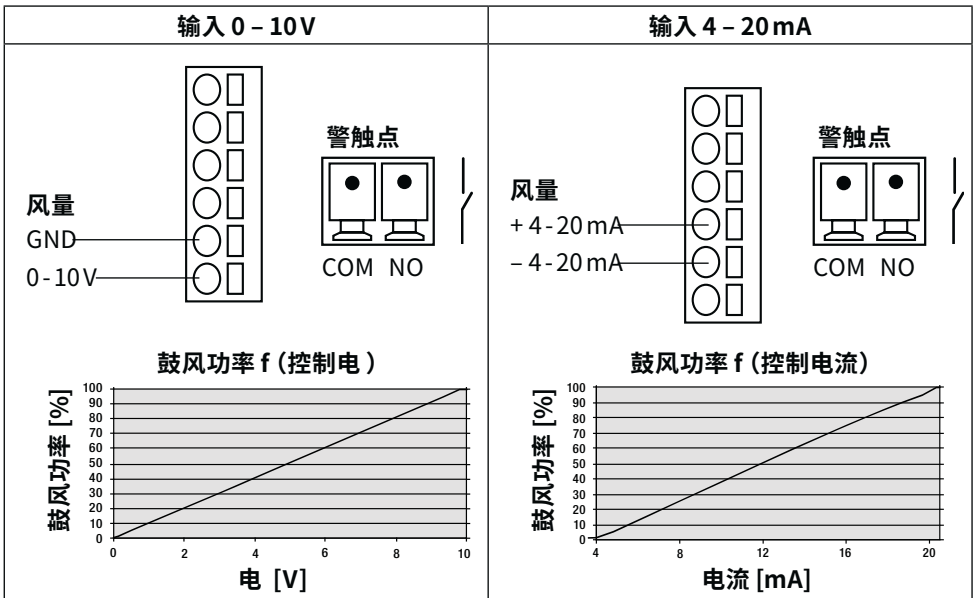

注意:

作集成装设备使用, 在电源接中必配备适的装置用于全极电源, 且触点距离至少 3mm。

设备明

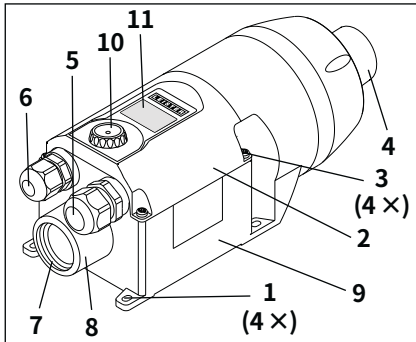

- 1 安装接片
- 2 密封外壳的罩盖
- 3 密封外壳的螺栓
- 4 出风口 / 管接口 $\varnothing 38\text{mm}$
- 5 电源的电缆接头
- 6 接口的电缆接头
- 7 气法，螺 G 1"
- 8 接口 $\varnothing 38$ ，用于风管或不钢器
- 9 密封外壳
- 10 e-Drive，用于 温度/风量
- 11 示器

准备

- MONO 从包装中取出。
- 松 螺栓 (3)，密封外壳 (2) 的罩盖打。
- 松 电源 (5) 的电缆接头。
- 若有需要，松 接口 (6) 的电缆接头。







装配

- 可由经培的业人 装配设备。
- 境温度不能高于 60°C
- 装配 必 确保
 - 送入冷风。
 - 其他装置的气流不可流经 设备。
- 若空气中含有灰，要使用丹的不钢器 (见附件) 并推到空气管或不钢器的接口 $\varnothing 38$ (8) 上。
- 于特重的灰 (例如金属电或潮的粉) 必使用特殊器，以避免设备短路。
- 防止 MONO 受到机械振动和冲。
- 用四个 $\varnothing M4$ 螺栓 MONO 固定在安装接片 (1) 上。
- 安装尺寸 参见第 3 页 (尺寸)

接

- 必由业人 接 MONO。
- 电源电路中必有适的全电极隔离装置!
- 必按照本使用手中第 4 页的路和接分布行接:
 - 在密封外壳 (9) 中接路。
- 上电源接 (5) 和接口 (6) 的电缆接头。
- 密封外壳 (2) 的罩盖用螺栓 (3) 。
- 使用管风管安装在出风口 (4) 处。量使用短管，以避免失风量。
- MONO 接上电源。
- 接通电源。

示明

	欠		联系 丹服务部门
	待机		鼓风激活
	指示字段，用于 示部件或服务菜 的信息		
	值字段，用于 示 定和实际值。 此处 出 四位 的字段 示，有 小点。		

条形 以 5 个 表示出鼓风 速。
同 以 % 形式 示 (1P-100P)



鼓风 速 100% 最大



鼓风 速 1% 最小

设备保护功能

如果设备 (风温度高或者空气回流聚), 电机 并同打 警 电器的工作触点。如果设备保护功能触发, 出于安全考, 行设备复位 要注意以下步:



MONO SYSTEM

- A 设备冷却
- B 设备电源
- C 10 秒后重新 设备接上电源
- D 查 风口和出风口, 必要 清洁。

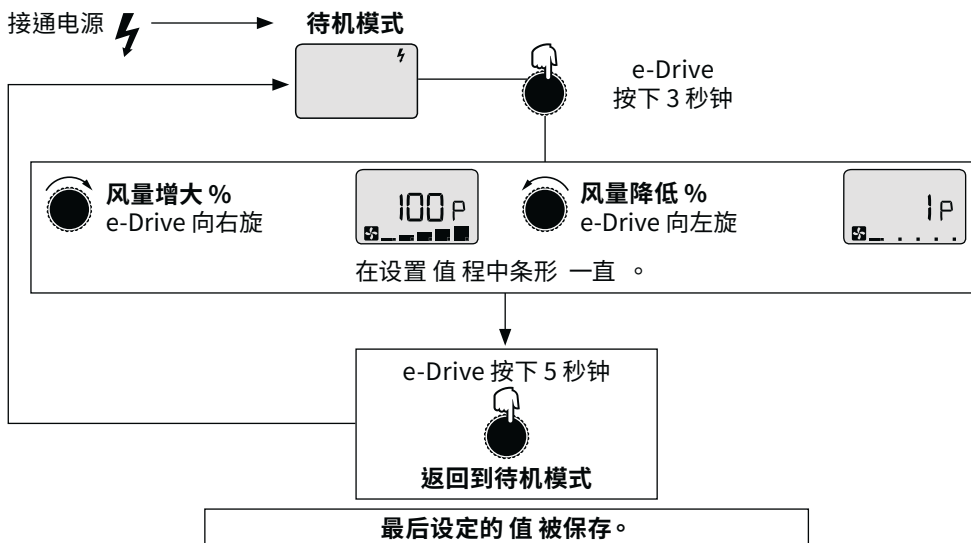
操作



设定菜 配置

e-Drive	功能	e-Drive	功能
	短按下 1 次 = 激活		向右旋
	按下 3 秒钟 = 确		向左旋



提示：

如果短按下 e-Drive 1 次但并未确，不会保存此值。

接通电源 

待机模式



3 秒钟

运行模式



设定菜



按下 2 秒钟，并同 慢向右旋 1/4 圈

鼓风机接口 设置

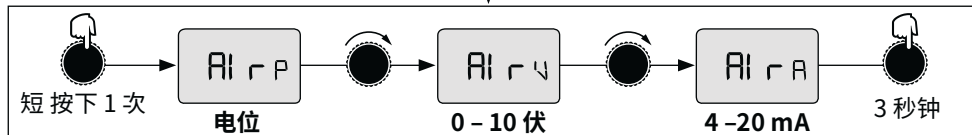

Stor E

短按下 1 次

保存设定。返回运行模式

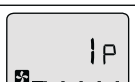

e-Drive 按下 5 秒钟







返回到待机模式

示 明

Al r P 鼓风机 e-Drive (电位)
 Al r V 鼓风机接口 设置 0 - 10 V
 Al r A 鼓风机接口 设置 4 - 20 mA
 Stor E 保存

故障信息

示	名	故障原因	故障排除
E005 	欠	电源电 < 20 % 定电	查电源电
		设备 坏	丹服务部门 联系
E004 	联系 丹服务部门		
E007 			
E009 			

培

丹科技公司及其授的服务部门 各种用提供免培。信息见 www.leister.com

3D

3D 可从您的服务部门或 www.leister.com 处取。

附件

- 可使用 丹附件。
- 丹提供大量附件，例如
 - 管
 - PVC 材的 空气管 $\varnothing 38 \text{ mm}$
 - 不 钢 器，可安装在 风口管上
- 附件 见 www.leister.com

服务和 修

- 可由授的 丹服务部门 行 修。些部门可在有效期限 确保按照电路 和备件表提供包括原装备 件在 的可靠的 业 修服务。

保修

- 此设备自 之日起适用直 代理/ 售商提供的担保或保修 利。如果因生 或加工 提出担保或 保修要求（通 或供 明），此类 由经 商通 更 备件或 修予以解决。加 元件不属于担保或 保修范。
- 其他担保或保修要求均依照强制性法 予以排除。
- 由正常磨 、 或不 操作造成的 坏不可享受保修服务。
- 若 者 设备 行 改装或更改，不再享受担保或保修服务。



ご使用を開始する前に、取扱説明書を必ずよくお読みください。
また、取扱説明書は捨てずに保管してください。

高圧ブロワー モノシステム

用途

ライスターの「モノ」ブロワーは機械や設備装置の取り付けに適しており、メンテナンスフリーで長時間使用することが可能です。

- ライスター製ヒーターを用いた空気供給で送風、冷却
- 空気および気体 (不燃性、非腐食性、非爆発性であること) を送るのに適しています



警告



通電している構成部品および接続部が露出するため、装置を開く際に**生命の危険あり**。装置を開ける前に、必ず**全極**を電源から遮断してください。



注意



装置記載の**定格電圧**は、電源電圧と一致する必要があります。



装置からは決して目を離さず使用してください。装置の取り扱いは**専門の作業員が自ら行うか**、当該作業員の監視なしに行うことはできません。
子どもには決して手を触れさせないでください。



機器を**湿気や水分から保護**してください。

半完成機械類の組み込みの適合宣言書

(EC 機械指令 2006/42; 附属書 II B に基づく)

Leister Technologies AG, Galileo-Strasse 10, CH-6056 Kaegiswil / Schweizは、半完成機械である

名称: 熱風器
型式: モノ (MONO)
仕様: システム

が、商品の出荷時点に於いて EC 機械指令 (2006/42) が規定するところの要件に適合していることを宣言します。

併せて、本半完成機械は以下の EC 指令が定める条項を満たしています。

EC 指令: 電磁両立性 2004/108
低電圧指令 2006/95
RoHS 指令 2011/65

整合規格: EN 12100, EN 55014-1, EN 55014-2, EN 61000-6-2, EN 61000-3-2, EN 61000-3-3, EN 62233, EN 60335-1, EN 50581

更に、本半完成機械に付随する技術文書は 附属書 VII (Part B) に適合しており、合理的な要求があれば各国当局に電子データとして提出に応じることを宣言します。

文書管理責任者: フォルカー・ポール、製品企画責任者

本半完成機械は EC 機械指令 (2006/42) が定める要件に従って組み付けが完成したことを宣言するまで、始動することはできません。

Kaegiswil, 2015/06/24

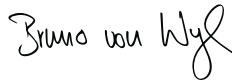
Bruno von Wyl, CTO

Andreas Kathriner, GM

廃棄について



電気工具、アクセサリ、梱包材は、環境に配慮し必ず分別の上リサイクルしてください。EU 諸国において、電気工具を一般ごみで廃棄することは固く禁じられています。EC 指令 2002/96、いわゆる WEEE 指令（電気・電子機器廃棄物に関する欧州議会及び理事会指令）において、使用不可能な電気工具は分別収集の上、環境に配慮しリサイクルすることが定められています。

テクニカルデータ

モーター型式		無整流子モーター
電圧	V~	120 230
出力	W	120 120
周波数	Hz	50 / 60
最高吸気温度	°C	60
最高周囲温度	°C	65
最大風量 (20°C 周辺温度)	l/min.	250 - 600
最大静圧	kPa	3.5
騒音レベル	dB(A)	65
重量	kg	1.0
インターフェース (ポテンシャルフリー)		風量アラーム出力用4 - 20 mA および 0 - 10 V
寸法 (サイズ)		3ページ
適合規格マーク		CE (ErP n/a)
保護クラスII		

技術的な変更の可能性があります

技術仕様、機器機能

モノ 6	システム
eドライブ操作ユニット	•
装置保護	•
アラーム出力 (リレーコンタクト)	•
風量設定用リモコンインターフェース	•
ディスプレイ	•

インターフェース 技術仕様

一般	絶縁材 IEC/EN 60747-5-2	AC 1414 Vpeak
	逆極性保護	
	ゼロ位補正	
電圧入力	電圧 0 ~ 10 V	DC 0~10 V (5% 作動でリップル < 0.4 V)
	最大入力電圧	DC 12 V
	定格入力抵抗	33.7 kΩ
電流入力	電流 4 ~ 20 mA (2コンダクター式)	DC 4~20 mA (5% 作動でリップル < 0.7 mA)
	最大入力電流	DC 22 mA
	定格入力抵抗	159 Ω
アラームアウトプ ット (リレーコンタク ト)	最大電圧	AC 250 V, DC 30 V
	最大電流	AC 3 A, DC 3 A
	接触抵抗最大値	100 mΩ (DC 24 V / 1 A 時)
	接触タイプ	SPST-NO
	コンタクトコイル間の絶縁性	AC 4000 V 1 min.
コンタクトコンタクト間の絶縁性	AC 1000 V 1 min.	

機能技術仕様

eドライブまたはインターフェース

風量

風量設定 1, 5...100 %; 5 % 作動

温度/風量チャート

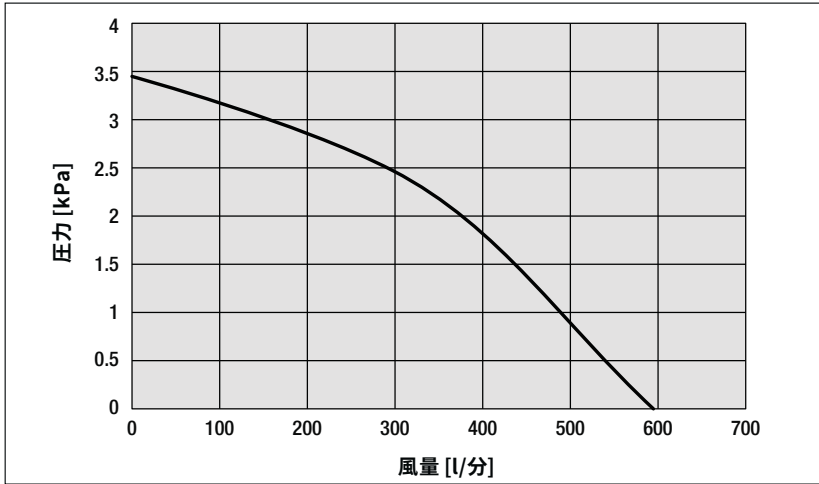

インターフェース / コントロール

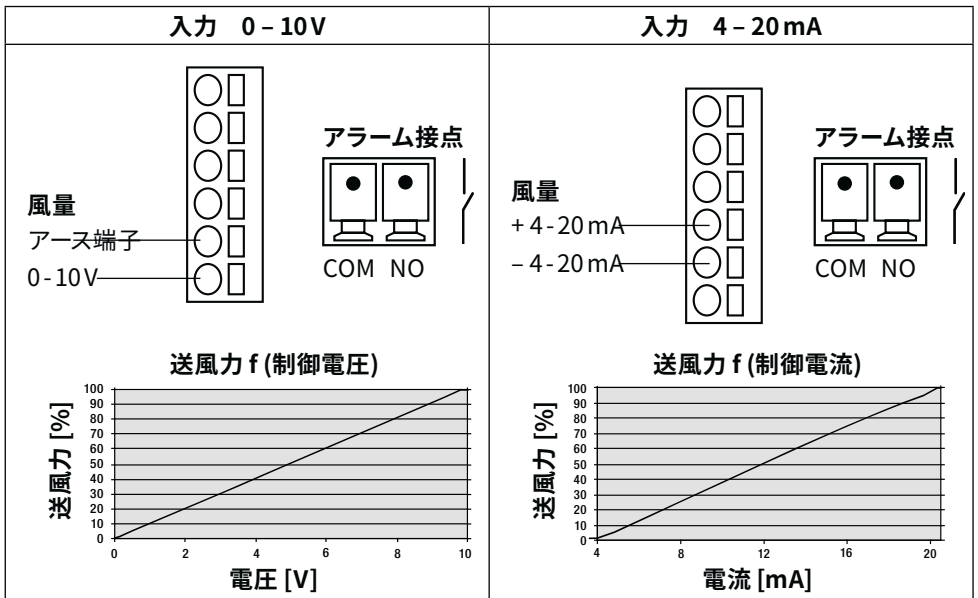

注意事項:

組み込み装置として使用する場合、電源接続部に全極遮断できる適正な装置を接点間隔 3mm以上を確保して装備する必要があります。

各部の名称

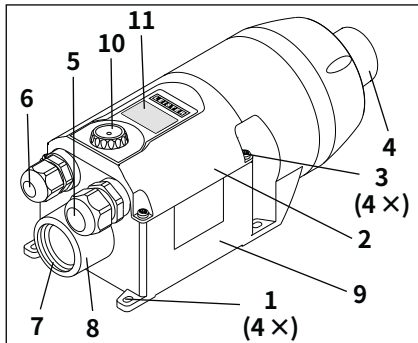

- 1 取付ラッチ
- 2 接続箱ハウジングのカバー
- 3 接続箱ハウジング用ネジ
- 4 吹出口 / ホース接続部 (ø 38mm)
- 5 電源接続ケーブル用ネジ
- 6 インターフェースケーブル用ネジ
- 7 空気取入口フランジ、含 内ネジ G 1"
- 8 コネクター (ø 38)、エアホースまたはステンレスフィルター用
- 9 接続箱ハウジング
- 10 eドライブ (温度/風量調節用)
- 11 ディスプレイ

準備

- モノを梱包から取り出してください。
- **ネジ (3)** を緩めて、**接続箱のカバー (2)** を開きます。
- **ケーブルネジ、電源用 (5)** を緩めます。
- 必要に応じて**ケーブルネジ、インターフェース用 (6)** を緩めます。







取付

- 機器の取り付けは、専門要員のみが許されています。
- 周囲温度は60 °C以下でなければなりません。
- 取り付けにより、冷めた空気のみが供給されます。
 - 機器が、他の機器の熱風に曝されないようにする必要があります。
- 空気に埃が含まれている場合は、Leisterステンレス製フィルター (アクセサリ参照) を使用し、エアホースまたはステンレスフィルター用の**コネクター ø 38 (8)** にはめ込みます。
- 危険性のある粉塵 (金属性、導電性、湿度のある埃など) は、機器のショートを防ぐために特殊フィルターを装着する必要があります。
- モノを振動や衝撃から保護してください。
- モノを ø M4のボルト4本で**取付ラッチ (1)** に固定します。
- 取付寸法は p3 (サイズ)を参照

接続

- モノの接続は専門の技術者以外に行うことはできません。
- 電源接続には、全極遮断できる適正な装置が必要となります!
- 装置は、取扱説明書 p 4 (配線図) の結線図およびピン配列に従って接続してください。
 - 配線を **接続箱ハウジング (9)** でする。
- **ケーブルネジ留め、電源 (5) 用** および **ケーブルネジ留め、インターフェース (6) 用** を引き締めます。
- **接続箱カバー (2)** mit den **ネジ (3)** で取り付けます。
- エアホースを、ホースクリップで**吹出口 (4)** に取り付けます。風量を損なわないよう、ホースはなるべく短いものを使用してください。
- モノを電源に接続します。
- 電源を入れます。

ディスプレイの説明

アイコン	アイコン
 低電圧	 弊社サービス代理店にご連絡ください
 スタンドバイ	 ブロワーがアクティブ
	ユニットやサービスメニューの情報表示用のインジケータ欄
	目的値および現在値表示用の欄 小数点なしの4桁セグメント表示です

バーグラフは、5段階でブロワーの回転数を表示します。
同時に% (1P - 100P) でも表示されます

ブロワーの回転数 100% 最大値

ブロワーの回転数 1% 最小値

装置保護機能

装置の過熱 (高すぎる吸気温度または熱の滞留)により、モーターがオフになり、同時にアラームリレーの常時開接点が開きます。装置保護が作動した場合、安全上の理由により、装置をリセットするには以下のステップに従ってください。

モノシステム

- 装置を冷まします
- 装置を電源から分離します
- 10秒後に装置を再び電源に接続します。
- 吸気口および排気口を点検し、必要に応じて清掃します。

操作

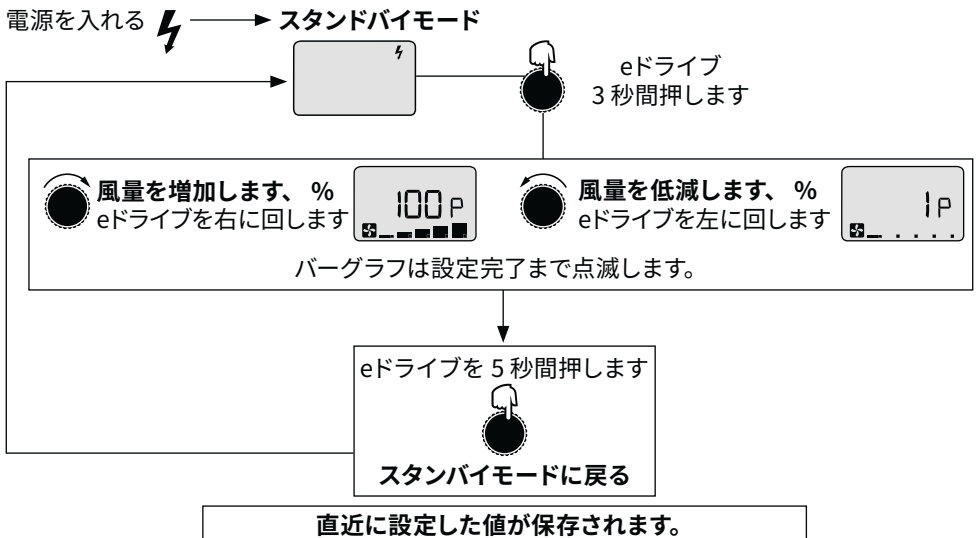

セットアップメニューの設定

eドライブ	機能	eドライブ	機能
	1 回短く押す=アクティブ化		右に回す
	3 秒間押す=確定		左に回す



注記:

eドライブを 1 回短く押し確定をしない場合は、値は保存されません。

電源を入れる 

スタンバイモード



3 秒間

運転モード

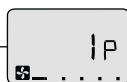

セットアップメニュー



2 秒間押し、同時にゆっくりと右に¼回転する

ブLOWER、インターフェース指定値

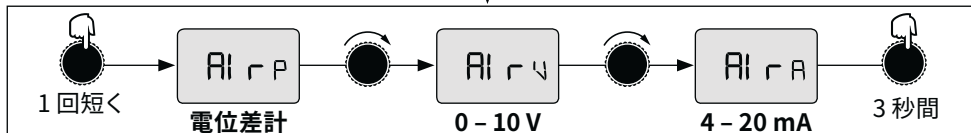

1 回短く

Al r P
電位差計



Al r V
0 - 10 V



Al r A
4 - 20 mA



3 秒間



Stor E



1 回短く

設定は保存されます。運転モード
に戻る



eドライブを 5 秒間押します







スタンバイモードに戻る

表示 説明

Al r P	ブLOWER、eドライブ (電位差計)
Al r V	ブLOWER、インターフェース指定値 0 - 10 V
Al r A	ブLOWER、インターフェース指定値 4 - 20 mA
Stor E	保存

エラーメッセージ

表示	名称	故障原因	故障排除
E005 	低電圧	電源電圧 < 20 % 電源電圧	電源電圧を点検します
		機器の故障	ライスター社のサービス代理店にご連絡ください
E004 	弊社サービス代理店にご連絡ください		
E007 			
E009 			

研修

Leister Technologies AG および正規サービス代理店では、使い方に関する無料研修を実施しております。詳しい情報は当社ホームページをご覧ください：www.leister.com

3D 図面

お近くのサービス代理店または当社ウェブサイト (www.leister.com) で、3Dの図面をご用意しております。

アクセサリー

- ライスター純正アクセサリー以外は使用しないでください。
- ライスターではアクセサリーを豊富にご用意しています。一例：ホースクリップ
 - エアホース \varnothing 38 mm (PVC 製)
 - ステンレスフィルター (吸入口への差込式)
- アクセサリーの検索は、www.leister.com でどうぞ

サービスと修理

- 修理は必ず、当社認定のライスターサービス代理店にお任せください。正規サービス代理店では、専門作業員が回路図とスペア部品リストに基づく純正部品を使用し、適性な期限内に確実な修理を行います。

保証

- 当機器には直接の販売店パートナーにより保証または保証サービス権利がお買い上げの日付より有効となります。保証または保証サービスを請求なさる場合には（領収書または納品書等の証明書が必要）、製造ミスまたは加工ミスが販売パートナーにより交換品をお届けするか、または修理するなどで処理されます。ヒーターエレメントは保証サービスまたは保証内容から外されています。
- その他の保証および保証サービスの請求は、強行法規の範囲内で認められません。
- 使用の過程で生じる自然な摩耗、過負荷、不適切な使用に起因する損傷は保証の対象外となります。
- お客様が改造や変更を行った場合、当社では一切の責任を負いかねます。また、このような製品も保証の対象外となります。



Your authorised Service Centre is:

A large, empty rectangular box with a thin black border, intended for the user to write the name and address of their authorized service center.

Leister Technologies AG
Galileo-Strasse 10
CH-6056 Kaegiswil/Switzerland
Tel. +41 41 662 74 74
Fax +41 41 662 74 16
www.leister.com
sales@leister.com