

Optical eye for reading and configuration

Graphical flow indicator

Type number
(includes information on meter size,
overall length etc.)

Serial number and production year

Configuration
(with information on display
resolution and encryption level etc.)

Accuracy class 2 according to OIML R 49,
Electrical E2 and Mechanical M1 according to MID,
ambient class B and C according to OIML R 49
(indoors/outdoors)

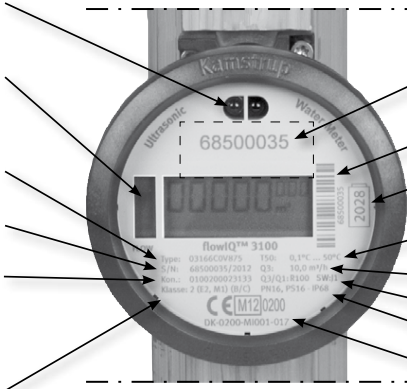

Optional customer label,
e.g. water company logo (15x38 mm)

Bar code with serial number

Expiry year of battery

Temperature class according to OIML R 49

Meter size Q3

Software version and dynamic range

Pressure stage and protection class

CE-marking according to MID

55121182_B1_GB_08.2014

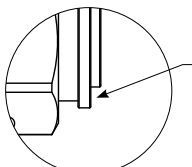

The sealing surface
of the threaded
connection must be
clean and level

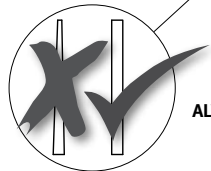
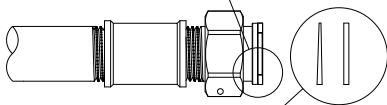

ALWAYS use new gaskets.

The piping must be parallel and fit the meter.

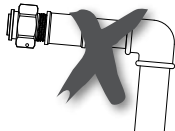
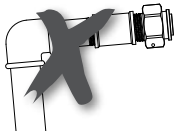
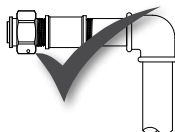
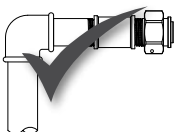

Installation guide for flowIQ™ 3100



Kamstrup

www.kamstrup.com

1. General information

Read this guide before installing the water meter.

flowIQ™ 3100 is a compact electronic water meter used for water consumption measurement in the tap water supply of homes, commercial and industrial buildings. The meter is watertight and thus well suited for mounting in small pump stations and meter wells, which are frequently filled with water. flowIQ™ 3100 has been constructed for maintenance-free operation for up to 16 years. flowIQ™ 3100 is hermetically closed, and it is, therefore, not possible to service the meter without breaking the seal. This means that all service including battery change, must be carried out by an authorized Kamstrup Service Centre. Certain changes of configuration, however, are possible via the built-in optical eye without dismounting the meter from the installation. Further details appear from data sheet and technical description.

1.1 Permissible operating conditions / measuring ranges

Temperature of medium water meter:	0.1°C...50°C
Pressure stage:	PN16
Mechanical environment:	M1 (MID) Fixed installation with minimum vibration.
Electromagnetic environmental class:	E1 and E2 (MID). Housing and trade.
Protection class:	IP68
Climatic environment:	2°C...55°C. Condensing humidity. (indoors mounted in utility rooms and outdoors in meter wells). Installation in direct sunlight ought to be avoided.

1.2 Installation requirements

Prior to installation of flowIQ™ 3100 the system should be flushed while a fitting piece replaces the meter. Please check that stop valves are tight and operate as intended and that the pipe system is without corrosion and damages. Damaged components, if any, must be replaced. Close the main stop valve in front of the meter and let a tap run until the pressure in the system has been equalized. Close the stop valve after the meter before disassembling the pipe system. Having assembled the pipe system, all sealing surfaces of existing couplings must be cleaned to remove possible remaining pieces of gasket. Remove adhesive wafers from the meter's inlet and outlet and mount the meter. Always use new gaskets in original quality.

The flow direction is indicated by an arrow on the side of the meter. Install the meter with an orientation that makes it easy for the consumer to read the display.

During installation it must be secured that the meter is mounted without mechanical bias in the connection pipes. Do not attempt to correct oblique piping by means of the meter.

At the same time make sure that the threaded length of the couplings does not prevent proper tightening of the sealing surface and that PN10 or PN16 couplings are used.

If meters are mounted in meter wells or outdoors, both the meter well and the meter must be protected against freezing.

Thread meters – sizes 4.0, 6.3 and 10.0 m³/h of the flowIQ™ 3100 series – are prepared for mounting of a coarse-mesh strainer (filter) in the meter's inlet connection. Furthermore, a nonreturn valve can be mounted in the meter's outlet connection.

Service

When the meter has been mounted in the system neither welding nor freezing is allowed. Dismount the meter from the system before starting such work.

In order to facilitate replacement of the meter, closing valves should be mounted on either side of the meter.

Under normal operating conditions no pipe strainer is required in front of the meter. Nonreturn valves must be mounted in accordance with local regulations.

1.3 Installation angle of flowIQ™ 3100

flowIQ™ 3100 can be mounted at all angles and positions. Kamstrup A/S recommend that the display is mounted so that it is easy to read, if possible.

Thus, the meter can be mounted in a usual horizontal installation. It can be mounted vertically on an ascending pipe, it can be mounted at any angle and it can be mounted with its display pointing downwards, e.g. under a roof.

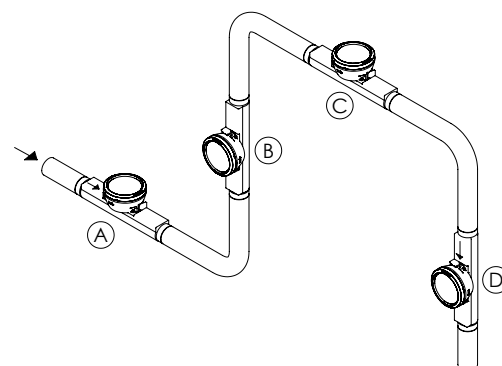

- A** Recommended water meter position.
- B** Recommended water meter position.
- C** Used for "well installation". Air build-up may occur.
- D** The meter functions optimally, but the display is "upside down".

1.4 Straight inlet

flowIQ™ 3100 requires neither straight inlet nor straight outlet to meet the Measuring Instruments Directive (MID) 2004/22/ EF and OIML R49. A straight inlet section will only be necessary in case of heavy flow disturbances before the meter.

1.5 Operating pressure

In order to avoid cavitation and secure correct measurement under all conditions, the operating pressure in the pipe system must observe the test conditions of OIML R 49, which means that the static pressure immediately after the meter (downstream) must always be minimum 0.03 MPa (0.3 bar).

1.6 Info codes and display

When flowIQ™ 3100 leaves Kamstrup A/S, it has been tested and verified and the counter has been reset.

M³ are displayed by five big digits. The small digits are decimals after the dot.

A number of info codes can be displayed, of which DRY and RADIO OFF will be activated and will flash upon delivery. Furthermore, the two small squares in the bottom right-hand corner will flash to indicate that the meter is active. Info code DRY indicates that there is air in the meter, the info code disappears when the meter is water-filled. As long as the meter is not water-filled nothing is measured. Blowing through the meter with air does not influence the meter either.

The info code RADIO OFF indicates that the meter is still in transport mode with the built-in radio transmitter turned off. The transmitter turns on automatically when the first litre of water has run through the meter. The radio transmitter remains on, and the info code signal in the display switches off.

The flow arrows in the left side of the display indicate water flow through the meter. If the water is stagnant, all arrows will be off.

The table below describes the different info codes in the display.

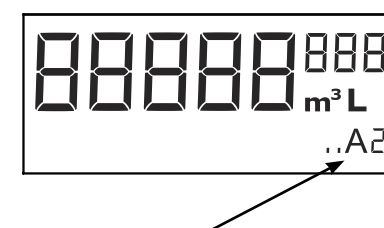

The figure after the "A" indicates how many times the meter has been adjusted or reset. In a completely new meter both of these indicators will be switched off.

Laboratories which have reverified and adjusted or reset the meter, shall attach a label with information on the valid adjustment number to the meter.

Info code flashes in display	Meaning
LEAK	During the latest 24 hours the water in the meter has not been stagnant for minimum one continuous hour. This can indicate a leakage in the pipe system.
BURST	The water flow has exceeded a preprogrammed limit for minimum 30 minutes which is a sign of a burst pipe.
TAMPER	Tampering attempt. The meter is no longer valid for billing purposes.
DRY	The meter is not water-filled.
REVERSE	The water flows in the wrong direction through the meter.
RADIO OFF	The meter is still in transport mode with the built-in radio transmitter turned off. The transmitter turns on automatically when the first litre of water has run through the meter.
.. (two square "dots")	Two small squares that flash alternately indicate that the meter is active.