



**INSTRUCTIONS FOR USER,
INSTALLER AND TECHNICAL SERVICE
CENTRE**

NEREIX

ICI Kronos

ICI Kronos REV. 6 (FW 0.1) 08/04/2010



Dear user,
thank you for choosing our product. ICI Kronos comes from a non-stop research and state of the art technology. Genuine quality materials and components make our device a very reliable product. Our range of products follows all UNI, CEI and EN directives related to safety and electromagnetic compatibility (Directive 72/23/EEC relating to electrical equipment designed for use within certain voltage limits and Directive 89/336/CEE relating to electromagnetic compatibility). We recommend to follow the instructions in this manual with great care.

ICI Kronos controller allows the control and reading of the NEREIX metering stations.

INDEX

1	MAIN DISPLAY	3
2	MENU	4
2.1	SEASON AND TEMPERATURES	4
2.2	PROGRAM	5
2.3	VACATION.....	5
2.4	DISPLAY CONSUMPTION.....	6
2.5	DISPLAY TEMPERATURES	6
2.6	DATE AND TIME	7
2.7	ALARMS	7
2.8	CONFIGURATION AND LANGUAGE SETTINGS.....	7
2.9	MOBILE PHONE CONTROLS VIA SMS.....	8
2.10	VISUAL MODE	8
3	CONNECTION (ONLY FOR INSTALLERS AND TECHNICAL SERVICE CENTRES).....	9
4	WALL MOUNTING (ONLY FOR INSTALLERS AND TECHNICAL SERVICE CENTRES)	11

1 MAIN DISPLAY

The buttons have variable functions related to the icons shown in the different displays.

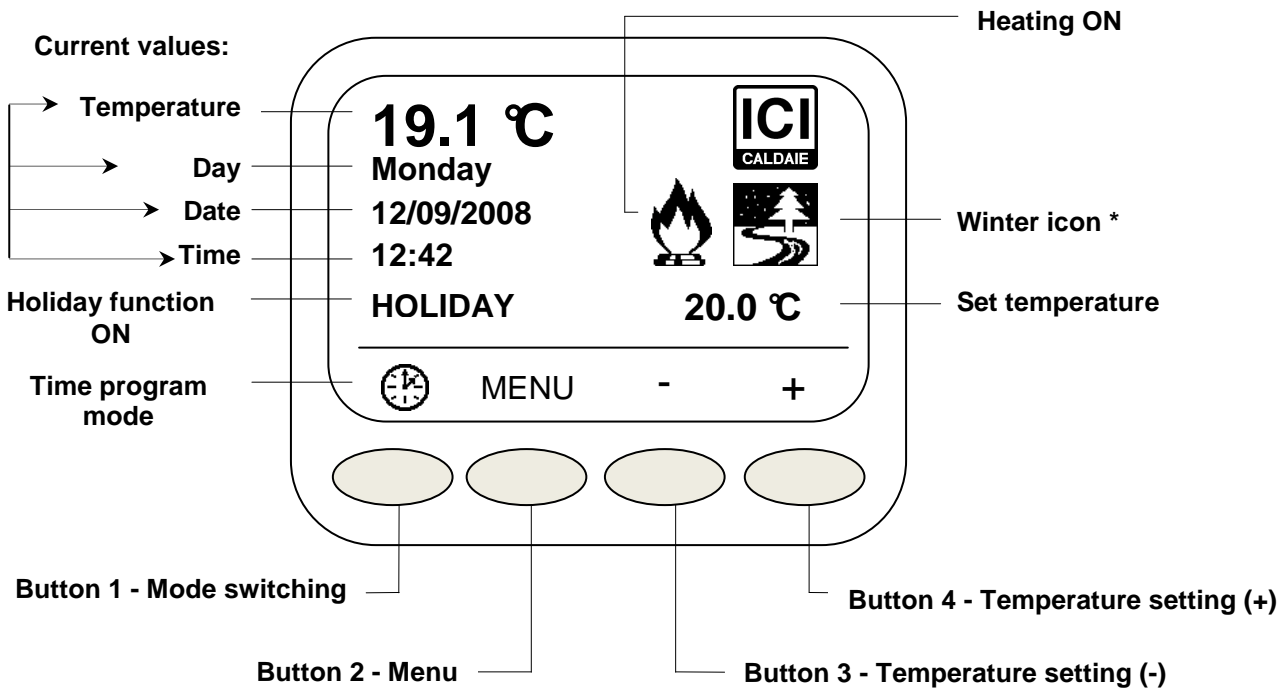

*If the controller is set on "SUMMER" (see par. 3.1) the icons on the main display will be:



Summer icon



Cooling operation activate

Mode switching, by pushing the button the different modes are shown.



Time program mode, temperatures are kept according to those set in the program,.



Manual mode. The temperature is kept constantly referring to the one set on the display. Temperature can be changed by pushing + and – keys.

Off General switch off mode. Only anti-frost function is active.



Hold down button to access the current day program; to modify it, see par. 2.2.

If Anti-frost mode is active, in the main screen will appear only Heating icon and not appear or the set temperature or the + and –



2 MENU

Push the menu button to access to the list and use the arrows ▲▼ to show all.

- Season - Temperatures
- Program
- Vacation
- Display consumption
- Display temperatures
- Date and time
- Active alarms
- Configuration
- Language settings

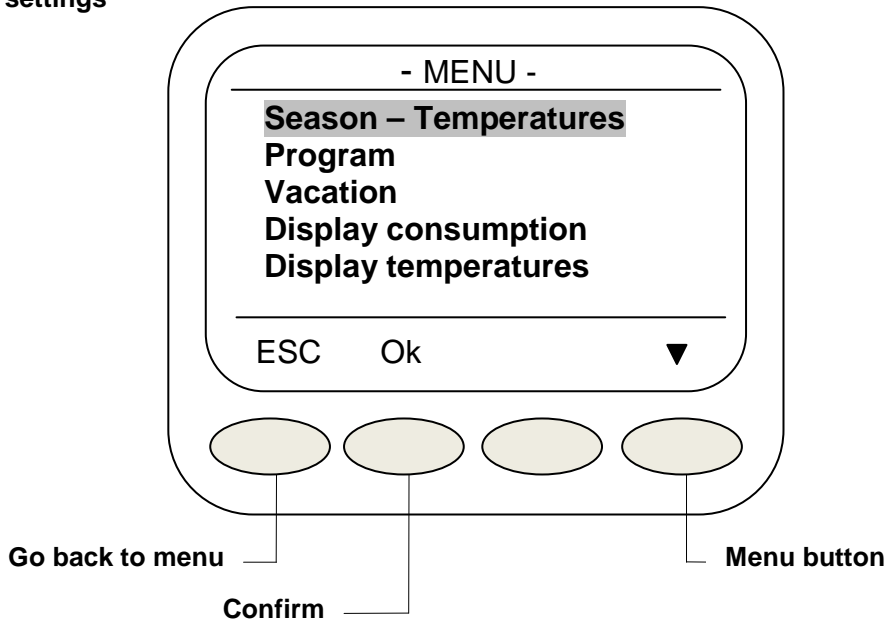

To access each single menu, select it and press **Ok**.

2.1 SEASON AND TEMPERATURES

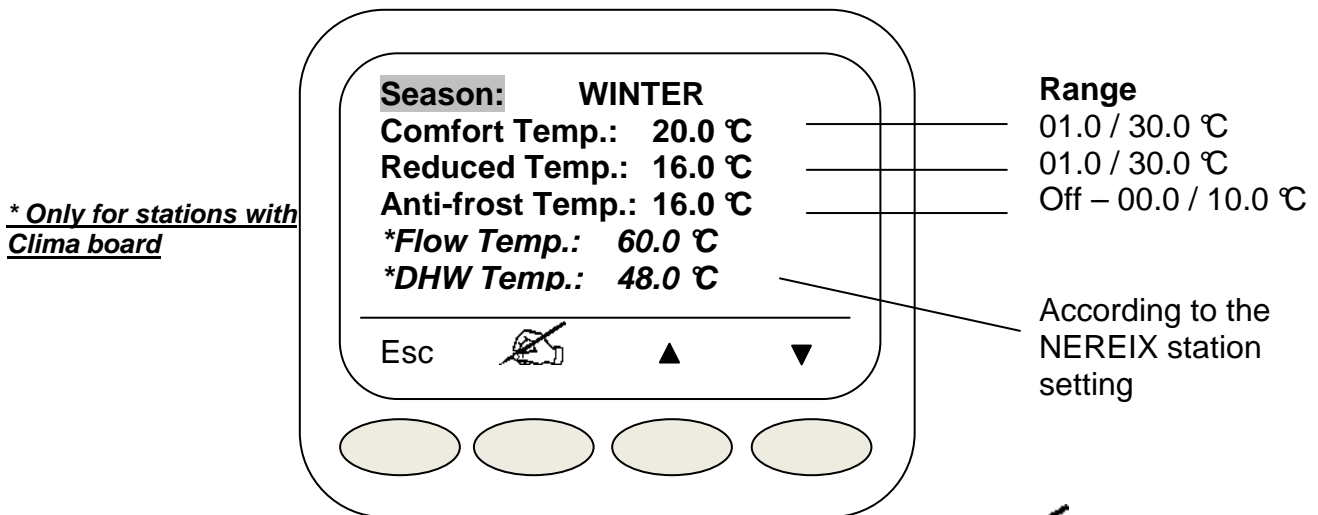

To modify the single values, select them by acting on the arrow buttons and push . Once selected, use the arrows to modify and push **Ok** to confirm.

Attention:

Anti-frost temperature can be set to **Off**. In this case the function is not active. Flow and DHW temperatures can be modified according to the limits set in the board.

2.2 PROGRAM

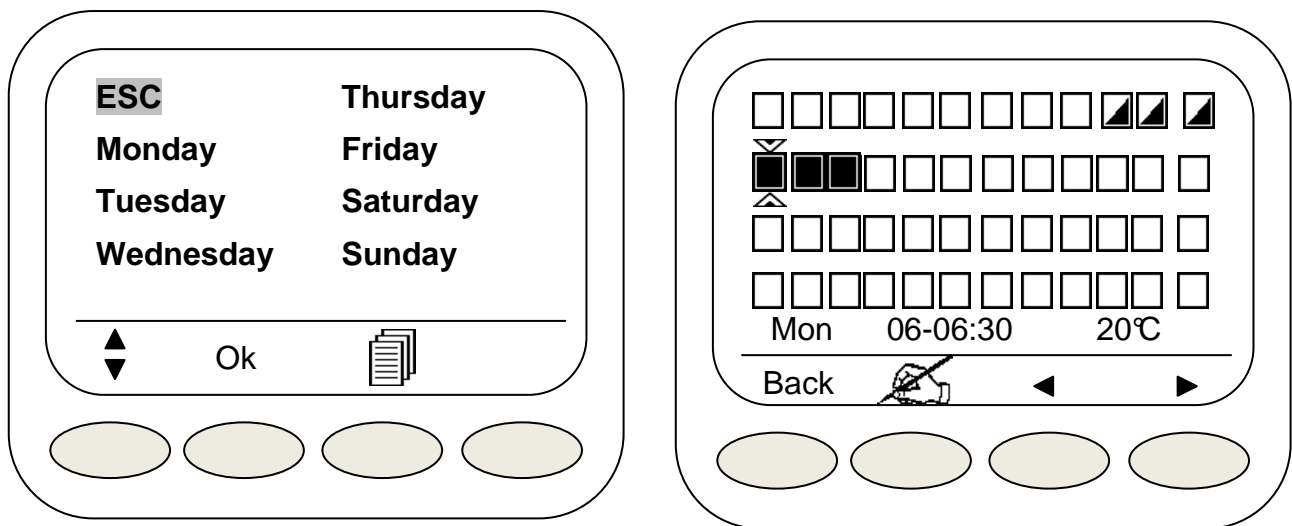

To set time brackets, select the day by pushing the buttons and press **Ok**.
A display will show squares representing each single 30 minutes of the day.

Full squares represent comfort temperature mode.

Half full squares represent reduced temperature mode.

Empty squares represent the switch off (or frost protection mode; when active)

Select the time by pushing the arrow buttons; press to adjust the desired temperature (comfort, reduced or anti-frost); the icon will be replaced by +/- ; **ESC** button will change to **Ok**.

Press **Ok** to confirm. By pushing the arrow buttons, the same setting will be copied to the next or previous time bracket.

From the main display of the **SETTINGS** menu it is possible to copy the setting from one day to the other.

After selecting with the button the day you want to copy, push ; a dot will appear on the left side of the day.

Select the day you need to program using the key; the icon will appear on the bottom left.

Push the button referring to the icon to overwrite the selected day with the setting highlighted by the dot.

Repeat the operation selecting other days of the week.

2.3 VACATION

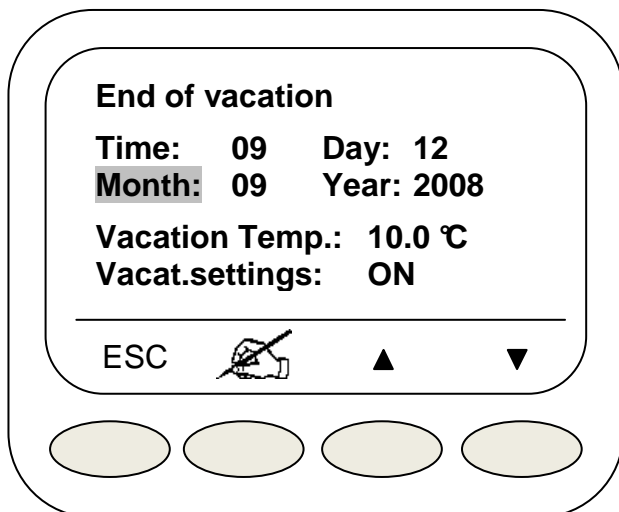

Select using the arrow keys then press and modify by pressing + and - buttons.

Press **Ok** to confirm.

If you choose **ON** in the Holiday mode field, the temperature will be kept till the set time and date.

Holiday ended, operation mode will return to that before the holidays.

Press **ESC** to return to the previous display.

2.4 DISPLAY CONSUMPTION

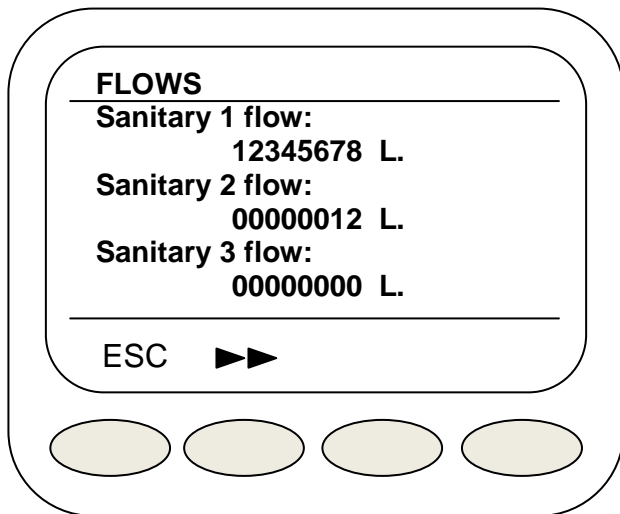
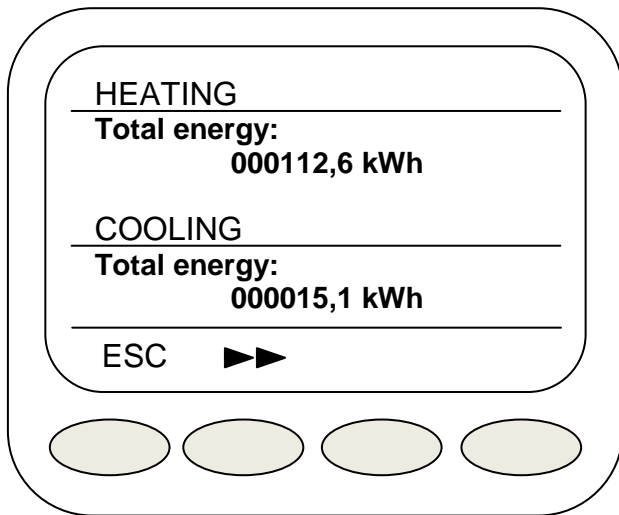

Use the arrow key to scroll through the displays and **ESC** to exit.

2.5 DISPLAY TEMPERATURES

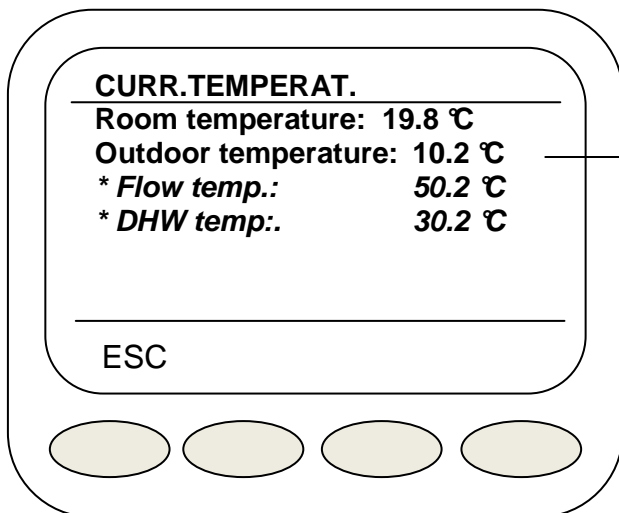



Available if the Master or the single Slave unit are provided with an outdoor probe.

**** Only for stations with Clima board***

Press **ESC** to exit.

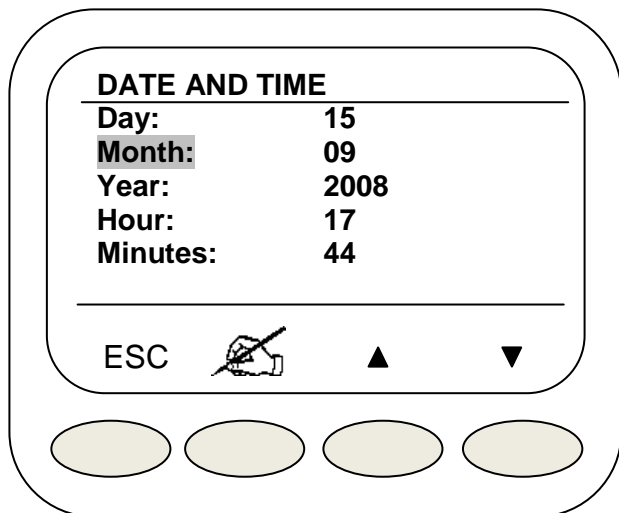
2.6 DATE AND TIME



To modify, select with the arrow keys, then press  and modify by pushing + and - buttons.

Press **Ok** to confirm.

Press simultaneously buttons 3 and 4 for five seconds to enter in the "Visual" mode (see 2.10).

Press **ESC** to exit.

Note: when a Master unit is installed, date and time cannot be modified and display 3.6 is not available. Date and time are set by the central unit.

2.7 ALARMS

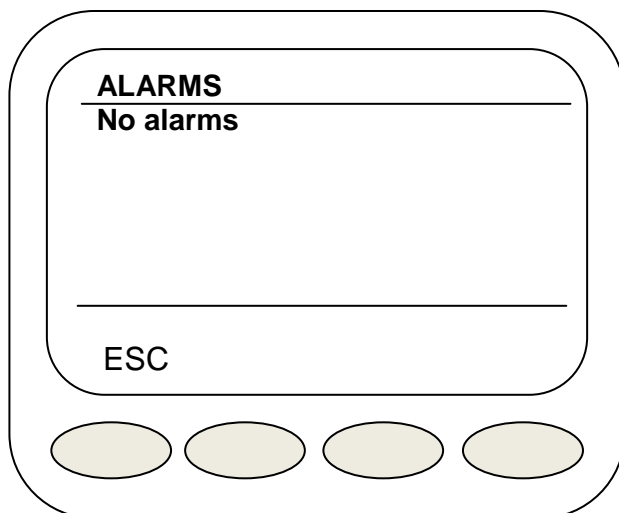

Possible failures are displayed here by pressing simultaneously buttons 3 and 4 for five seconds. All alarms must be reported to the technical service centre.

Press **ESC** to exit.

2.8 CONFIGURATION AND LANGUAGE SETTINGS

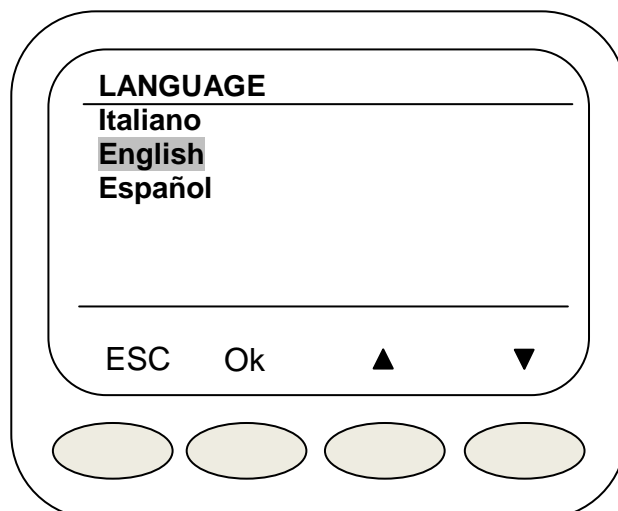
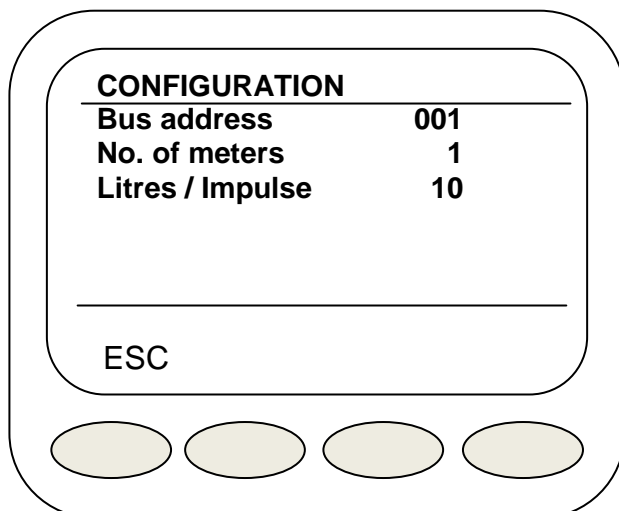

Bus address: Values between 1 and 250

No. of meters: Values between 1 and 3

Litres/Impulse: Values of 1/10/100/1000 Litres/Impulse

2.9 MOBILE PHONE CONTROLS VIA SMS

Using the "SMS code" generated or entered manually (see Clima Slave and Heat Metering Slave screens), it is possible to send some controls to the Slave unit via SMS. To use this function, the Slave must absolutely be connected to an ICI Kronos and to a Master provided with modem)

Control syntax which can be sent via SMS:

#SMS code "space" MAN "space" desired temperature:

ICI Kronos goes manually to the desired temperature

#SMS code "space" AUTO

ICI Kronos goes to automatic mode according on the program entered.

#SMS code "space" OFF

ICI Kronos turns OFF

#SMS code "space" ANTIFZ

ICI Kronos goes to anti-freeze mode

Example: If the SMS code was "555555", this command: "#555555 MAN 20" brings operating mode to manual with a temperature set of 20 °C.

2.10 VISUAL MODE

Access to Visual mode is possible from DATE AND TIME menu by pressing simultaneously buttons 3 and 4. With this mode on it is not possible to make any requests or changes, but only display data from the following menu:

- Show meters
- Show temperatures
- Date and time
- Set language (unique modifiable setting)

Now initial shown display is:

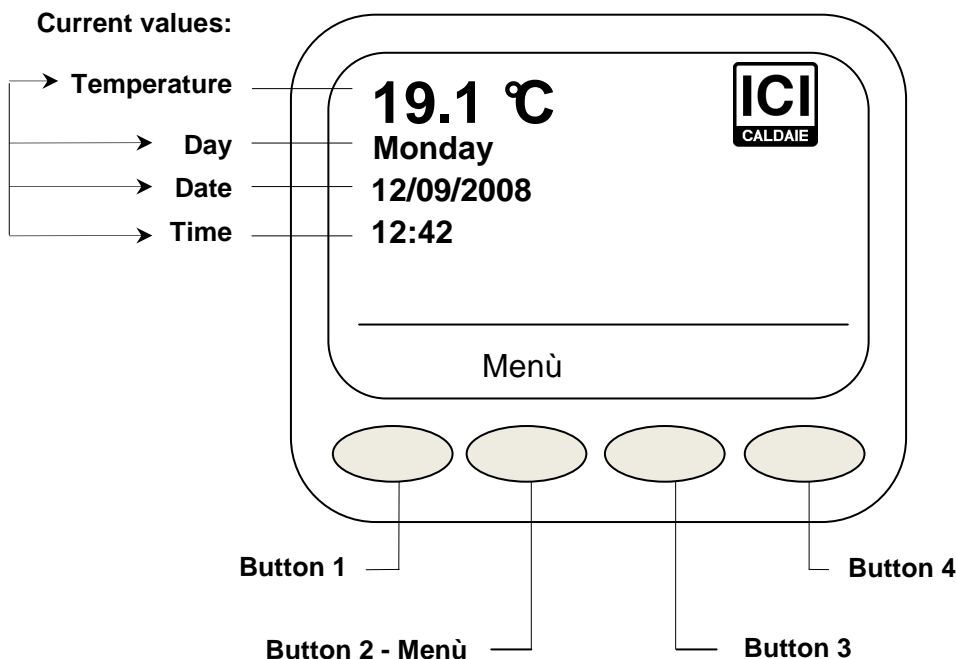

To return to the previous mode go to DATE AND TIME MENU and hold down AGAIN buttons 3 and 4 for five seconds.

3 CONNECTION (ONLY FOR INSTALLERS AND TECHNICAL SERVICE CENTRES)

Communication between ICI Kronos and NEREIX metering station is provided by bus cable; the connection must be ensured with tripolar shielded cable (section of 3x0,35 mm²) up to 90 meters long. Never place in the same corrugated cables for transmitting data and power cables. Anyway, Master BUS cables and ICI Kronos cables can be placed in the same corrugated.

Note: In case of power polarity inversion, the board fuse can eventually burn out – Restore the correct polarity and replace the fuse.

CONNECTING THE BOARDS WITH THE TERMINAL BOX

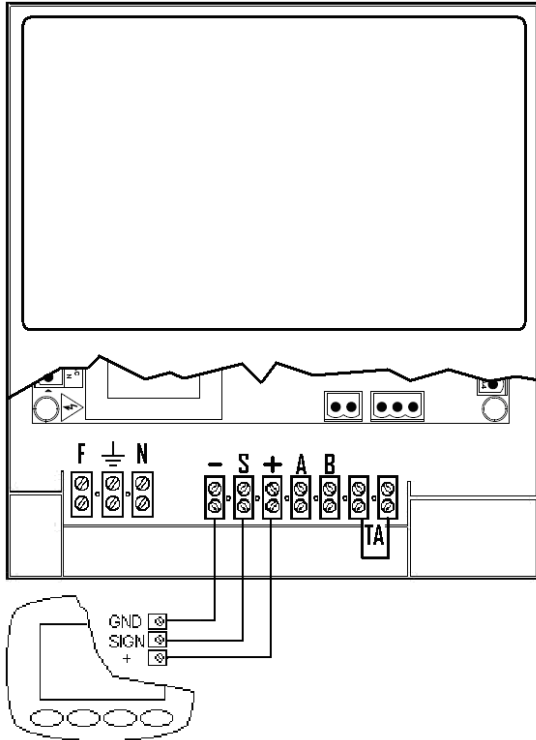

CONNECTING ICI KRONOS TO METERING BOARDS WITH TERMINAL BOX

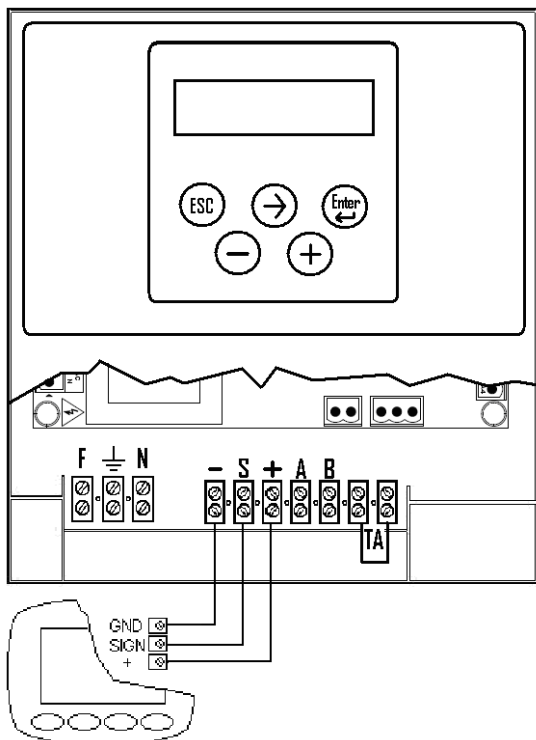

CONNECTING ICI KRONOS TO "CLIMA" BOARDS WITH TERMINAL BOX

CONNECTING BOARDS WITHOUT TERMINAL BOXES

A resistance of 330 Ohm (1/4 Watt) must be fitted in parallel between the negative pole (marked with a “-”) and the signal (marked with an “S”).

Metering boards are usually preset with a resistance and are fitted in a proper terminal box. Fitting of “Clima” boards must be carried out when wiring the ICI Kronos.

Unstable communication between board and ICI Kronos can occur if no resistance is installed.

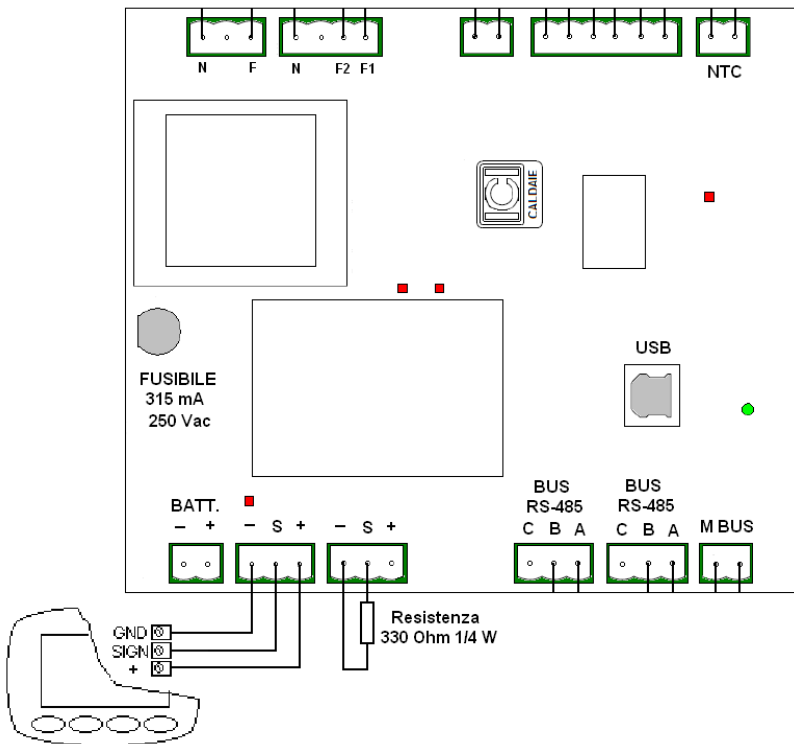

CONNECTING ICI KRONOS TO NEREIX METERING BOARDS WITHOUT TERMINAL BOX

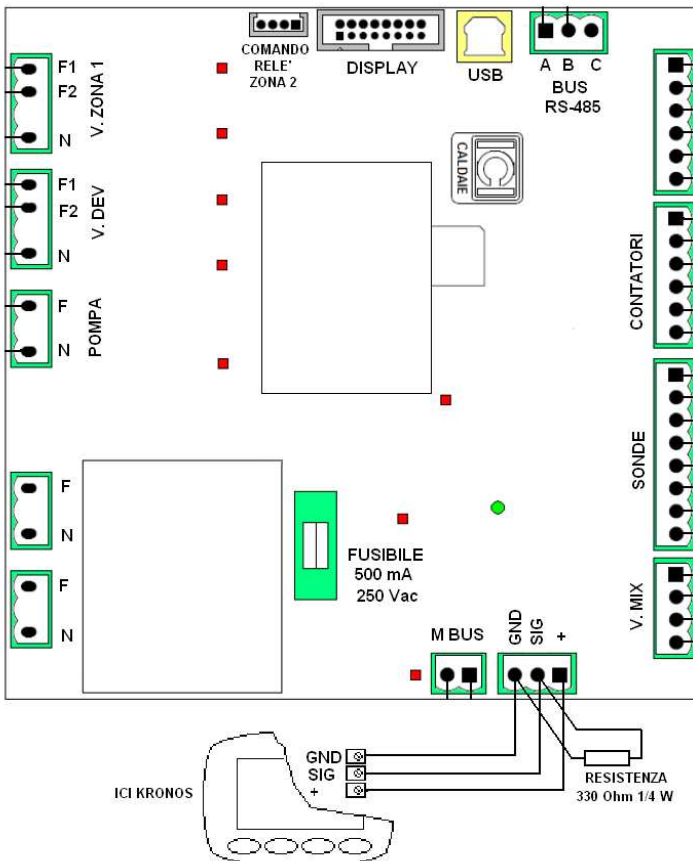

CONNECTING ICI KRONOS TO NEREIX BOARDS WITHOUT TERMINAL BOX

4 WALL MOUNTING (ONLY FOR INSTALLERS AND TECHNICAL SERVICE CENTRES)

Mounting procedure:

Separate the outer cover (1) pushing gently with a screwdriver on one of the two side slots (2).

Fix the back part of the device with two \varnothing 6 mm nogs.

The square hole is preset for cable passage (section of $3 \times 0,35 \text{ mm}^2$) which will exit from the corrugate located in the wall.

Side venting grates (3) must be fitted to the left.

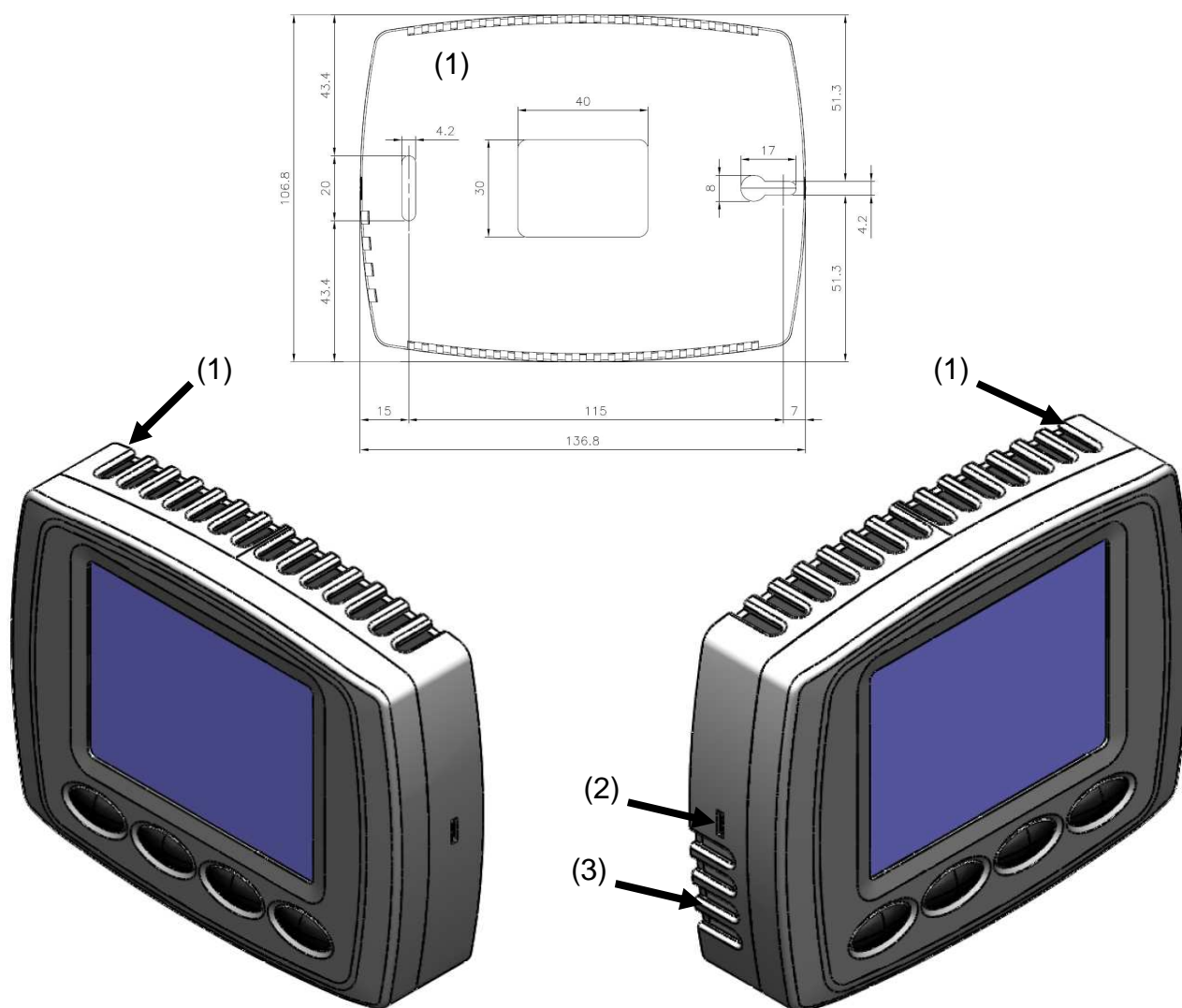

Remove the tripolar terminal box from the device and connect the conductors following the diagrams on the previous pages.

Insert the cabled terminal box and fix the device to its back cover.

IMPORTANT:

ICI Kronos is powered directly by the NEREIX multi-autonomous station board.

During maintenance, the NEREIX board must be de-energised.

In case of power outage, data are automatically saved by the device microprocessor.



Appartenente al Gruppo Finluc, iscritto R.I. VR n. 02245640236

Via G. Pascoli, 38 - 37059 Zevio - fraz. Campagnola - VERONA - ITALIA

Tel. 045/8738511 - Fax 045/8731148

info@icicaldaie.com - www.icicaldaie.com

The data reported are indicative only and are not binding. Our company reserves the right to introduce alterations at any time as it deems fit and proper for the development of the product.