

HITACHI

Inspire the Next

HARC-MODBUS

HITACHI

Installation and operation manual
 Manual de instalación y funcionamiento
 Installations- und Betriebshandbuch
 Manuel d'installation et de fonctionnement
 Manuale d'installazione e d'uso

Manual de instalação e de funcionamento
 Bruger- og monteringsvejledning
 Installatie- en bedieningshandleiding
 Handbok för installation och användning
 Εγχειρίδιο εγκατάστασης αι λειτουργίας

HARC-MODBUS - Operation and installation manual



HITACHI
 Inspire the Next

PMML0175A-rev.1 - 6/2008 - Printed in Spain

PMML0175A-rev.1 - 6/2008

Do not perform installation work, without referring to this installation manual.
 No realice la instalación de este equipo, sin antes consultar este manual de instalación.
 Bei der Installation unbedingt die Hinweise in der Installationsanleitung beachten.
 Consulter notre manuel avant de réaliser une quelconque installation.
 Realizzare l'installazione, seguendo quanto indicato in questo manuale.
 Não inicie os trabalhos de montagem, sem consultar o nosso manual de montagem.
 Udfør ikke installationsarbejder uden først at konsultere vores vejledning.
 Voer geen enkele handeling uit om de apparatuur alvorens deze handleiding te hebben doorgelezen.
 Utför inte några installationsarbeten utan att först läsa var installationsmanual
 Μην ήσετε στην εγκατάσταση, χωρίς πριν να έχετε συμβουλευθεί αυτο το εγχειρίδιο εγκατάστασης

Specifications in this manual are subject to change without notice in order that HITACHI may bring the latest innovations to their customers.

Whilst every effort is made to ensure that all specifications are correct, printing errors are beyond Hitachi's control; Hitachi cannot be held responsible for these errors.

Las especificaciones de este manual están sujetas a cambios sin previo aviso a fin de que HITACHI pueda ofrecer las últimas innovaciones a sus clientes.

A pesar de que se hacen todos los esfuerzos posibles para asegurarse de que las especificaciones sean correctas, los errores de impresión están fuera del control de HITACHI, a quien no se hará responsable de ellos.

Bei den technischen Angaben in diesem Handbuch sind Änderungen vorbehalten, damit HITACHI seinen Kunden die jeweils neuesten Innovationen präsentieren kann.

Sämtliche Anstrengungen wurden unternommen, um sicherzustellen, dass alle technischen Informationen ohne Fehler veröffentlicht worden sind. Für Druckfehler kann HITACHI jedoch keine Verantwortung übernehmen, da sie außerhalb ihrer Kontrolle liegen.

Les caractéristiques publiées dans ce manuel peuvent être modifiées sans préavis, HITACHI souhaitant pouvoir toujours offrir à ses clients les dernières innovations.

Bien que tous les efforts sont faits pour assurer l'exactitude des caractéristiques, les erreurs d'impression sont hors du contrôle de HITACHI qui ne pourrait en être tenu responsable.

Le specifiche di questo manuale sono soggette a modifica senza preavviso affinché HITACHI possa offrire ai propri clienti le ultime novità.

Sebbene sia stata posta la massima cura nel garantire la correttezza dei dati, HITACHI non è responsabile per eventuali errori di stampa che esulano dal proprio controllo.

As especificações apresentadas neste manual estão sujeitas a alterações sem aviso prévio, de modo a que a HITACHI possa oferecer aos seus clientes, da forma mais expedita possível, as inovações mais recentes.

Apesar de serem feitos todos os esforços para assegurar que todas as especificações apresentadas são correctas, quaisquer erros de impressão estão fora do controlo da HITACHI, que não pode ser responsabilizada por estes erros eventuais.

Specificationerne i denne vejledning kan ændres uden varsel, for at HITACHI kan bringe de nyeste innovationer ud til kunderne.

På trods af alle anstrengelser for at sikre at alle specificationer er korrekte, har Hitachi ikke kontrol over trykfejl, og Hitachi kan ikke holdes ansvarlig herfor.

De specificaties in deze handleiding kunnen worden gewijzigd zonder verdere kennisgeving zodat HITACHI zijn klanten kan voorzien van de nieuwste innovaties.

Iedere poging wordt ondernomen om te zorgen dat alle specificaties juist zijn. Voorkomende drukfouten kunnen echter niet door Hitachi worden gecontroleerd, waardoor Hitachi niet aansprakelijk kan worden gesteld voor deze fouten.

Specificationererna i den här handboken kan ändras utan föregående meddelande för att HITACHI ska kunna leverera de senaste innovationerna till kunderna.

Vi på Hitachi gör allt vi kan för att se till att alla specifikationer stämmer, men vi har ingen kontroll över tryckfel och kan därför inte hållas ansvariga för den typen av fel.

Οι προδιαγραφές του εγχειριδίου μπορούν να αλλάξουν χωρίς προειδοποίηση, προκειμένου η HITACHI να παρέχει τις τελευταίες καινοτομίες στους πελάτες της.

Αν και έχει γίνει κάθε προσπάθεια προκειμένου να εξασφαλιστεί ότι οι προδιαγραφές είναι σωστές, η Hitachi δεν μπορεί να ελέγξει τα τυπογραφικά λάθη και, ως εκ τούτου, δεν φέρει καμία ευθύνη για αυτά τα λάθη.

Contents

1.	Safety Summary _____	4
2.	Component names _____	4
3.	Specifications _____	5
4.	Installation work _____	6
4.1	Dimensional data _____	6
4.2	Fastening _____	6
5.	Wiring connections _____	7
5.1	Electrical wiring _____	7
5.2	DIP switch setting _____	8
6.	Operation _____	12
6.1	PACKAGED: Data available _____	12
6.2	CHILLER: Data available _____	15
6.3	Alarm code list for CHILLER _____	16
6.3.1	CHILLER alarms code list _____	16
6.3.2	Cycle alarms code list _____	17
7.	Troubleshooting _____	18

**Note:**

This manual provides basic information for installing and wiring HARC-MODBUS.

1. Safety Summary



Caution:
Do not connect voltage input to the control system before installation is correctly done.

Read this manual carefully before performing installation work.

Read this manual in order to configure the HARC-MODBUS.



Attention:
Do not install HARC-MODBUS in places... :

- with vapour, oil or dispersed liquids.
- with heat sources nearby (sulphuric surroundings).
- where accumulation, generation or leaks of inflammable gases has been detected.
- that are near the sea, in saline, acid or alkaline surroundings.



Attention:
Install HARC-MODBUS away from possible sources of electromagnetic waves.

Respect local electrical standards.

Use a power circuit that is not subject to peak demands.

Ensure that there is enough free space around the HARC-MODBUS (see figure) so that the heat may dissipate adequately (refer to "Installation Work").

If you install the HARC-MODBUS in vertical position, install the power supply in the lower part.

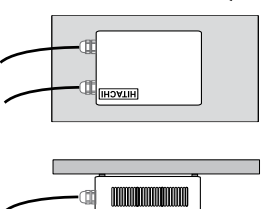

2. Component names

The figure shows the names of the HARC-MODBUS components.

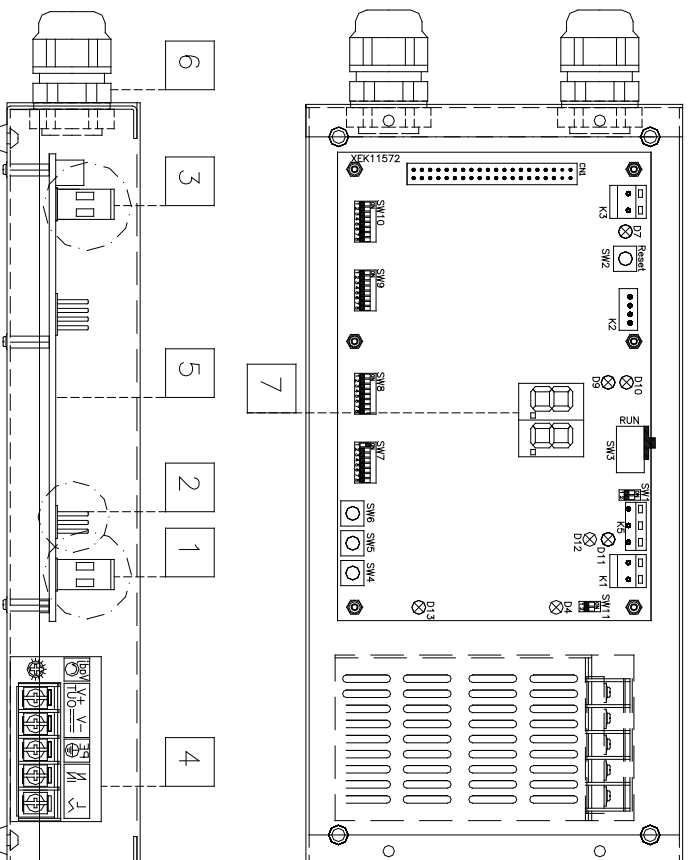

- 1 K1: H-LINK Connector:
Connected to CSNET WEB
- 2 K5: Serial port RS485
- 3 K3: +5V DC Power connection
- 4 Power source: 230V AC / 5V DC
- 5 H-LINK PCB
- 6 Packing glands (2)
- 7 7-segments

3. Specifications

Hardware Specifications

Item	Specifications
Power supply	1~230V ±10% 50Hz
Consumption	25W (maximum)
Outer dimensions	Width: 143mm, Depth: 302mm, Height: 76mm
Weight	1.75kg
Assembling conditions	Indoors (in a control panel or desktop)
Ambient temperature	0~40°C
Humidity	20~85% (Without condensation)

MODBUS - Communication with upper system

Item	Specifications
K5	Serial Port RS485 (3 Pins connector) - MODBUS Protocol
Communication line	Twisted pair cable. Polarity
Communication system	Half-duplex, multipoint serial connection
Communication method	Non parity or odd/even parity selection. Data length: 8 bits (see chapter 5)
Baud rate transmission	19200/9600 Baud (see chapter 5)
Length	max. 1200m according EIA-485

H-LINK - Communication with units

Item	Specifications
Communication with	HITACHI PACKAGED/CHILLER
Communication line	Twisted pair shielded cable, non polarity
Communications system	Half-duplex
Communication method	Asynchronous
Speed of transmission	9600 Bauds
Length of wiring	1000m maximum (total length of HLINK I/O bus)
Maximum number of HARC MODBUS	8 HARC-MODBUS/H-LINK SYSTEM (PACKAGED) 1 HARC-MODBUS/H-LINK SYSTEM (CHILLER)



Attention::

HARC-MODBUS cannot operate Indoor Units without any Remote Control Switch connected.

4. Installation work

When unpacking the HARC-MODBUS, check that it has not suffered damage during transport.

4.1 Dimensional data

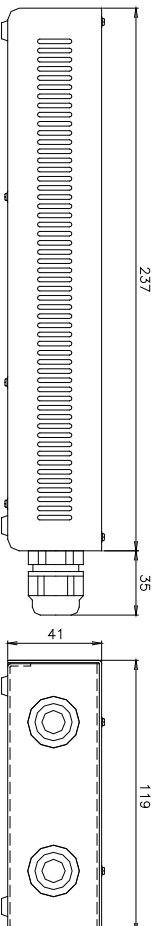

4.2 Fastening

Perform the following procedure:

- 1 Remove the rubber supports.
- 2 Unscrew the 4 screws from the top cover and remove it.
- 3 Attach the box to the rear vertical board from the inside with M4 screws (not provided) and place 3mm washers on the outside to separate the box from the wall.
- 4 Reinstall the top cover. Be careful to position it correctly.
- 5 Keep free grated area for ventilation and cable connection.

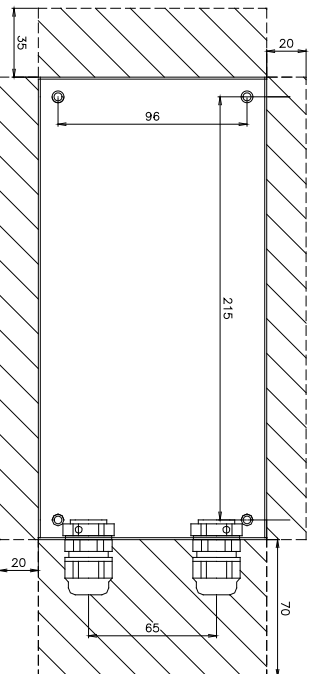

⚠ Attention:

- Before applying power and turning on HARC-MODBUS you must ensure that:
 1. All circuits to be connected are correctly applied.
 2. All H-Link connections have been set up.
 3. Follow the local regulations for the electrical installation of HARC-MODBUS and associated circuits.

Any unit that is not connected or is not under power when turning on HARC-MODBUS, will not be recognised and will have to be configured later.

⚠ Caution:

- The signals' cables should be as short as possible. Keep a distance of more than 150 mm from other power cables. Don't wire them together (although they may intersect). If they must necessarily be installed together, take the following measures to avoid noise:
 - Protect the signal cable with a metal tube which is earthed at one end.
 - For communications, use shielded wire which is earthed at one end.

⚠ Danger:

- Always disconnect the power supply for HARC-MODBUS when handling the machine, in order to avoid electrical discharges.
- Do not connect the interface to the power supply until the installation has been completed.
- Comply strictly with local security codes and regulations when connecting the machine to the electric network.
- You will need a three-wire cable (two cores and earth) with a suitable plug at one end.

5. Wiring connections

5.1 Electrical wiring

In order to run, HARC-MODBUS must be connected to the corresponding input and output signals, power supply cables and H-LINK.

No.	Connection	Cable Specifications
1	Power supply circuit 1~ 230V 50Hz 25W (With protection circuit)	Select wires according local regulations (recommended minimum 1.5mm ² H05RN-F)
2	MODBUS	3 cables harness 0.75mm ² (H05RN-F type). Use different colour for each cable. (Serial Port RS485)
3	H-LINK	Communication cables for the connection of HARC-MODBUS to an Hitachi installation, via CSNET WEB or any Hitachi unit using same H-LINK terminals. Twisted pair shielded cable 0.75mm ² (H05RN-F TYPE). Shield must be grounded in one side only.
4	PCBs Power supply +5V DC. I _{max} = 5A DC	Pair cable 0.75mm ² (H05RN-F TYPE)



Note:

All cables, except 4 are field supplied.

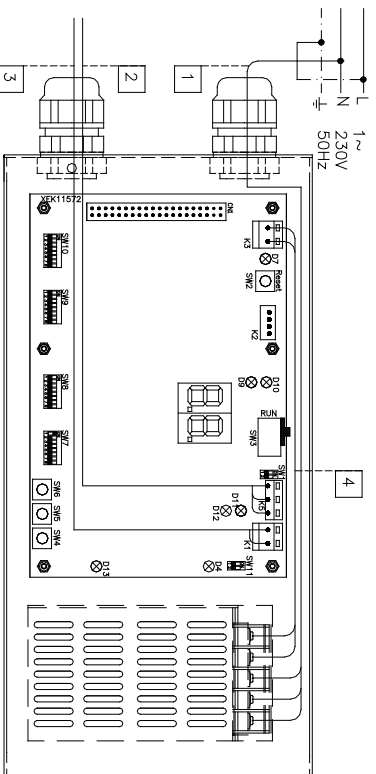

Field supplied Protections:

CB/EF: 5A

ELB: 2/40A/30mA

CB: Circuit Breaker

EF: Electric Fuse





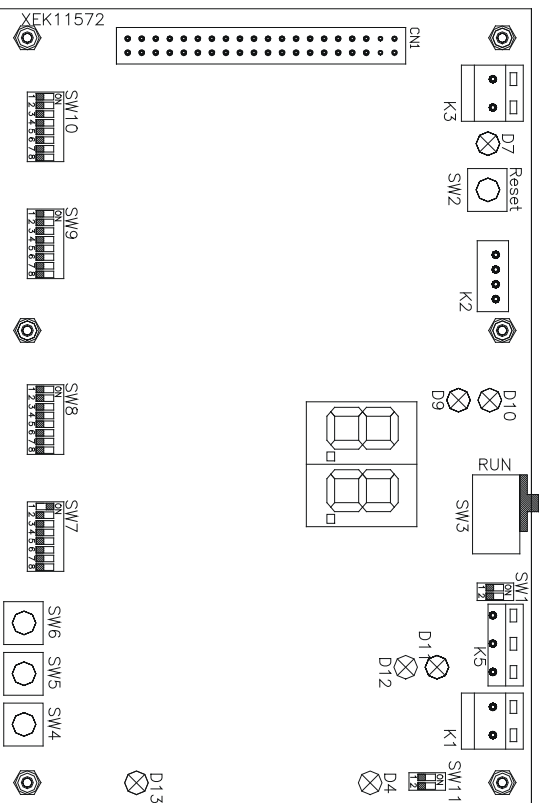

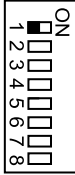

ELB: Earth Leakage Breaker

5.2 DIP switch setting



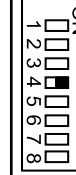

Name	Function	Factory setting	Description
SW1	Not available	ON 1 2	All in off (no function)
SW2	Reset	–	Reset button. To be used in case of program has been locked
SW3 (TELE)	Not available	RUN	Factory purposes. Never change it
SW4	Configuration	–	Setting functions
SW5	Configuration	–	Setting functions
SW6	Configuration	–	Setting functions
SW7	Options 2	ON 1 2 3 4 5 6 7 8	SW7-1: OFF-SLAVE / ON-MASTER. To be used in case of several HARC-MODBUS in the same H-LINK address SW7-2: OFF - EVENT CONTROL / ON - CHANGE CONTROL SW7-3: OFF - Parity disabled / ON - Parity enabled SW7-4: OFF - Even parity / ON - Odd parity SW7-5: OFF - 19200 Bps / ON - 9600 Bps SW7-(6~8): Not used
SW8	Options 1 (Application type)	ON 1 2 3 4 5 6 7 8	SW8-1: OFF-PACKAGED / ON-CHILLER. To be set according units application SW8-2~8: Not used
SW9	Not available	ON 1 2 3 4 5 6 7 8	All in off (no function)
SW10	HARC MODBUS address	ON 1 2 3 4 5 6 7 8	HARC MODBUS address from 1 to 32 by pins 1 to 5
SW11	H-LINK DSW	ON 1 2	2-Pins DSW SW11-1: H-LINK end resistance SW11-2: H-LINK fuse protection
D4, D11	H-LINK	–	H-LINK transmission
D7	Power	–	Power supply ON/OFF
D9/D10	Not used	–	–
D12	MODBUS	–	Modbus communication in RS485
D13	Operation	–	Normal software operation

■ SW7 – FUNCTIONS SETTING 1

SW7	Description
 	<p>Configuration as MASTER/SLAVE: MASTER: SW7-1=ON Only one HARC-MODBUS can be set as a MASTER HARC-MODBUS Setting by default</p> <p>SLAVE: SW7-1= OFF It should be 1 HARC-MODBUS configured as MASTER, all the rest of HARC-MODBUS must be configured as SLAVE in the same H-LINK</p>
 	<p>Data Refresh Mode Configuration as EVENT CONTROL: SW7-2:OFF Parameters are refreshed to the IU each time BMS writes a setting parameter (even if no value is changed); Setting by default</p> <p>Configuration as CHANGE CONTROL: SW7-2:ON Parameters are refreshed to the IU only when some values are changed</p>
 	<p>Parity configuration SW7-3: OFF : No parity configuration</p> <p>SW7-3: ON: Parity communication (see SW7-4 configuration for parity type)</p>
 	<p>Parity type configuration SW7-4: OFF : Even parity (if SW7-3 is ON) SW7-4: ON: Odd parity (if SW7-3 is ON)</p>
 	<p>Communication Baud rate SW7-5: OFF 19200 Bps SW7-5: ON 9600 Bps</p>

■ SW8 – FUNCTIONS SETTING 2

SW8	Description
 	<p>Configuration for PACKAGED / CHILLER PACKAGED Applications: SW8-1: OFF CHILLER Applications: SW8-1: ON</p>

- SW10 – HARC address H-LINK (Same concept of O.U./Refrigerant cycle address)

SW10				Description
Address: 1 ON <input type="checkbox"/> <input type="checkbox"/> <input type="checkbox"/> <input type="checkbox"/> <input type="checkbox"/> <input type="checkbox"/> <input type="checkbox"/> <input type="checkbox"/> 1 2 3 4 5 6 7 8	Address: 2 ON <input type="checkbox"/> <input type="checkbox"/> <input type="checkbox"/> <input type="checkbox"/> <input type="checkbox"/> <input type="checkbox"/> <input type="checkbox"/> <input type="checkbox"/> 1 2 3 4 5 6 7 8	Address: 3 ON <input type="checkbox"/> <input type="checkbox"/> <input type="checkbox"/> <input type="checkbox"/> <input type="checkbox"/> <input type="checkbox"/> <input type="checkbox"/> <input type="checkbox"/> 1 2 3 4 5 6 7 8	Address: 4 ON <input type="checkbox"/> <input type="checkbox"/> <input type="checkbox"/> <input type="checkbox"/> <input type="checkbox"/> <input type="checkbox"/> <input type="checkbox"/> <input type="checkbox"/> 1 2 3 4 5 6 7 8	Configuration of HARC Address HARC-MODBUS address used by MODBUS system SW10 pins 1~5 must be set according the corresponding drawing of the desired address SW10 pins 6~8 must be kept in OFF
Address: 5 ON <input type="checkbox"/> <input type="checkbox"/> <input type="checkbox"/> <input type="checkbox"/> <input type="checkbox"/> <input type="checkbox"/> <input type="checkbox"/> <input type="checkbox"/> 1 2 3 4 5 6 7 8	Address: 6 ON <input type="checkbox"/> <input type="checkbox"/> <input type="checkbox"/> <input type="checkbox"/> <input type="checkbox"/> <input type="checkbox"/> <input type="checkbox"/> <input type="checkbox"/> 1 2 3 4 5 6 7 8	Address: 7 ON <input type="checkbox"/> <input type="checkbox"/> <input type="checkbox"/> <input type="checkbox"/> <input type="checkbox"/> <input type="checkbox"/> <input type="checkbox"/> <input type="checkbox"/> 1 2 3 4 5 6 7 8	Address: 8 ON <input type="checkbox"/> <input type="checkbox"/> <input type="checkbox"/> <input type="checkbox"/> <input type="checkbox"/> <input type="checkbox"/> <input type="checkbox"/> <input type="checkbox"/> 1 2 3 4 5 6 7 8	
Address: 9 ON <input type="checkbox"/> <input type="checkbox"/> <input type="checkbox"/> <input type="checkbox"/> <input type="checkbox"/> <input type="checkbox"/> <input type="checkbox"/> <input type="checkbox"/> 1 2 3 4 5 6 7 8	Address: 10 ON <input type="checkbox"/> <input type="checkbox"/> <input type="checkbox"/> <input type="checkbox"/> <input type="checkbox"/> <input type="checkbox"/> <input type="checkbox"/> <input type="checkbox"/> 1 2 3 4 5 6 7 8	Address: 11 ON <input type="checkbox"/> <input type="checkbox"/> <input type="checkbox"/> <input type="checkbox"/> <input type="checkbox"/> <input type="checkbox"/> <input type="checkbox"/> <input type="checkbox"/> 1 2 3 4 5 6 7 8	Address: 12 ON <input type="checkbox"/> <input type="checkbox"/> <input type="checkbox"/> <input type="checkbox"/> <input type="checkbox"/> <input type="checkbox"/> <input type="checkbox"/> <input type="checkbox"/> 1 2 3 4 5 6 7 8	
Address: 13 ON <input type="checkbox"/> <input type="checkbox"/> <input type="checkbox"/> <input type="checkbox"/> <input type="checkbox"/> <input type="checkbox"/> <input type="checkbox"/> <input type="checkbox"/> 1 2 3 4 5 6 7 8	Address: 14 ON <input type="checkbox"/> <input type="checkbox"/> <input type="checkbox"/> <input type="checkbox"/> <input type="checkbox"/> <input type="checkbox"/> <input type="checkbox"/> <input type="checkbox"/> 1 2 3 4 5 6 7 8	Address: 15 ON <input type="checkbox"/> <input type="checkbox"/> <input type="checkbox"/> <input type="checkbox"/> <input type="checkbox"/> <input type="checkbox"/> <input type="checkbox"/> <input type="checkbox"/> 1 2 3 4 5 6 7 8	Address: 16 ON <input type="checkbox"/> <input type="checkbox"/> <input type="checkbox"/> <input type="checkbox"/> <input type="checkbox"/> <input type="checkbox"/> <input type="checkbox"/> <input type="checkbox"/> 1 2 3 4 5 6 7 8	
Address: 17 ON <input type="checkbox"/> <input type="checkbox"/> <input type="checkbox"/> <input type="checkbox"/> <input type="checkbox"/> <input type="checkbox"/> <input type="checkbox"/> <input type="checkbox"/> 1 2 3 4 5 6 7 8	Address: 18 ON <input type="checkbox"/> <input type="checkbox"/> <input type="checkbox"/> <input type="checkbox"/> <input type="checkbox"/> <input type="checkbox"/> <input type="checkbox"/> <input type="checkbox"/> 1 2 3 4 5 6 7 8	Address: 19 ON <input type="checkbox"/> <input type="checkbox"/> <input type="checkbox"/> <input type="checkbox"/> <input type="checkbox"/> <input type="checkbox"/> <input type="checkbox"/> <input type="checkbox"/> 1 2 3 4 5 6 7 8	Address: 20 ON <input type="checkbox"/> <input type="checkbox"/> <input type="checkbox"/> <input type="checkbox"/> <input type="checkbox"/> <input type="checkbox"/> <input type="checkbox"/> <input type="checkbox"/> 1 2 3 4 5 6 7 8	
Address: 21 ON <input type="checkbox"/> <input type="checkbox"/> <input type="checkbox"/> <input type="checkbox"/> <input type="checkbox"/> <input type="checkbox"/> <input type="checkbox"/> <input type="checkbox"/> 1 2 3 4 5 6 7 8	Address: 22 ON <input type="checkbox"/> <input type="checkbox"/> <input type="checkbox"/> <input type="checkbox"/> <input type="checkbox"/> <input type="checkbox"/> <input type="checkbox"/> <input type="checkbox"/> 1 2 3 4 5 6 7 8	Address: 23 ON <input type="checkbox"/> <input type="checkbox"/> <input type="checkbox"/> <input type="checkbox"/> <input type="checkbox"/> <input type="checkbox"/> <input type="checkbox"/> <input type="checkbox"/> 1 2 3 4 5 6 7 8	Address: 24 ON <input type="checkbox"/> <input type="checkbox"/> <input type="checkbox"/> <input type="checkbox"/> <input type="checkbox"/> <input type="checkbox"/> <input type="checkbox"/> <input type="checkbox"/> 1 2 3 4 5 6 7 8	
Address: 25 ON <input type="checkbox"/> <input type="checkbox"/> <input type="checkbox"/> <input type="checkbox"/> <input type="checkbox"/> <input type="checkbox"/> <input type="checkbox"/> <input type="checkbox"/> 1 2 3 4 5 6 7 8	Address: 26 ON <input type="checkbox"/> <input type="checkbox"/> <input type="checkbox"/> <input type="checkbox"/> <input type="checkbox"/> <input type="checkbox"/> <input type="checkbox"/> <input type="checkbox"/> 1 2 3 4 5 6 7 8	Address: 27 ON <input type="checkbox"/> <input type="checkbox"/> <input type="checkbox"/> <input type="checkbox"/> <input type="checkbox"/> <input type="checkbox"/> <input type="checkbox"/> <input type="checkbox"/> 1 2 3 4 5 6 7 8	Address: 28 ON <input type="checkbox"/> <input type="checkbox"/> <input type="checkbox"/> <input type="checkbox"/> <input type="checkbox"/> <input type="checkbox"/> <input type="checkbox"/> <input type="checkbox"/> 1 2 3 4 5 6 7 8	
Address: 29 ON <input type="checkbox"/> <input type="checkbox"/> <input type="checkbox"/> <input type="checkbox"/> <input type="checkbox"/> <input type="checkbox"/> <input type="checkbox"/> <input type="checkbox"/> 1 2 3 4 5 6 7 8	Address: 30 ON <input type="checkbox"/> <input type="checkbox"/> <input type="checkbox"/> <input type="checkbox"/> <input type="checkbox"/> <input type="checkbox"/> <input type="checkbox"/> <input type="checkbox"/> 1 2 3 4 5 6 7 8	Address: 31 ON <input type="checkbox"/> <input type="checkbox"/> <input type="checkbox"/> <input type="checkbox"/> <input type="checkbox"/> <input type="checkbox"/> <input type="checkbox"/> <input type="checkbox"/> 1 2 3 4 5 6 7 8	Address: 32 ON <input type="checkbox"/> <input type="checkbox"/> <input type="checkbox"/> <input type="checkbox"/> <input type="checkbox"/> <input type="checkbox"/> <input type="checkbox"/> <input type="checkbox"/> 1 2 3 4 5 6 7 8	

■ Example

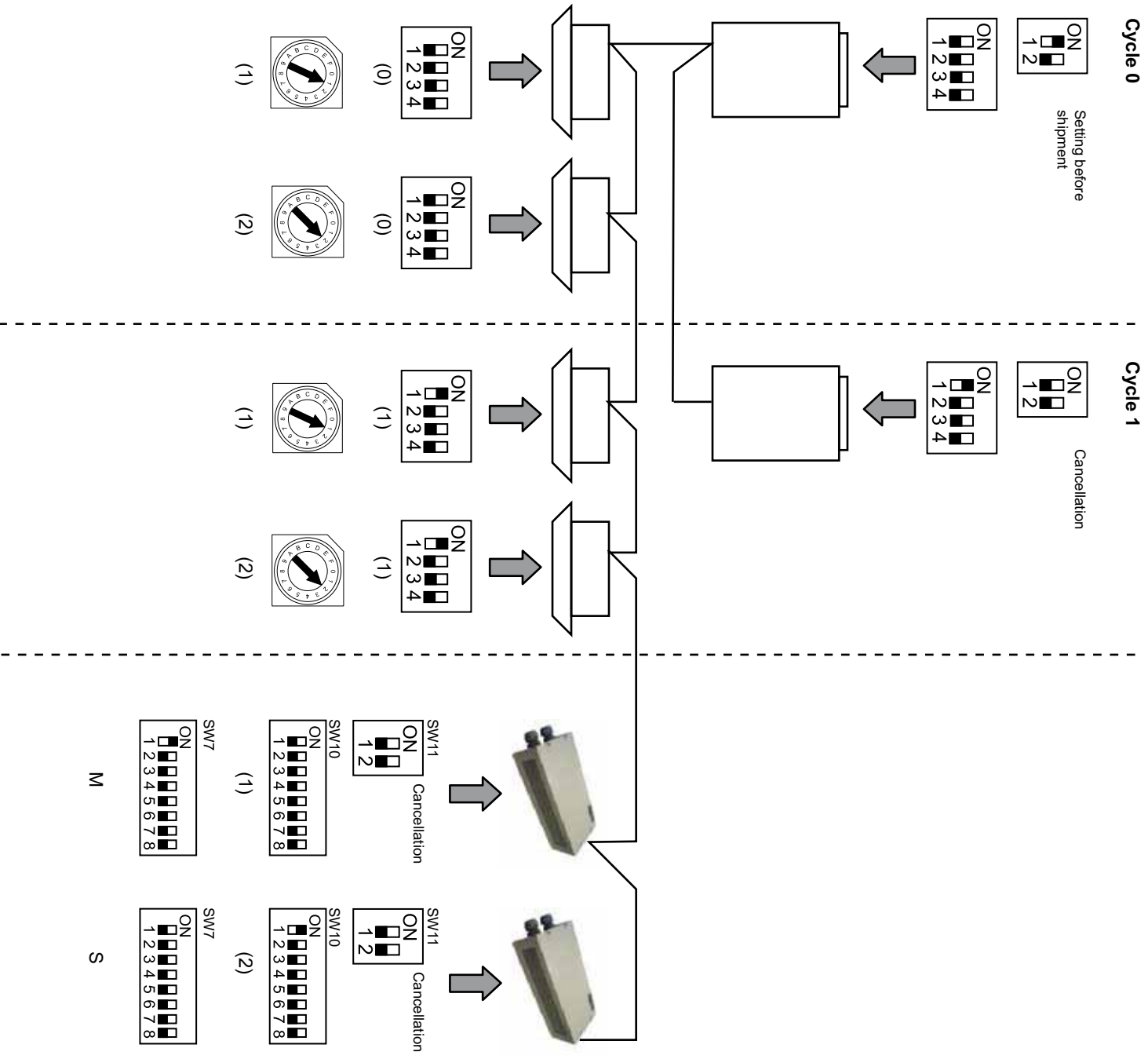

6. Operation

6.1 PACKAGED: Data available

Address (Note 1)	Name	Description	Read/Write
0	EXIST	EXIST: 0: Not exist 1: Exist	Read
1	SYSTEM_ADDRESS	System Address: 0 ~ 15 in H-LINK 1	Read
2	UNIT_ADDRESS	Unit Address: 0 ~ 15 in H-LINK1	Read
3	SET_ONOFF	On/Off setting order: 0: Stop 1: Run	Read/Write
4	SET_MODE	Mode Setting order: 0: Cool 2: Fan 4: Auto	Read/Write
5	SET_FAN	Fan Setting order: 0: Low 2: High 1: Medium	Read/Write
6	SET_TSET	Setting Temperature: 17°C ~ 30°C	Read/Write
7	SET_LOUVER	Louver Setting: 0 ~ 8 (8 is Auto)	Read/Write
8	SET_CENTRAL	Central Setting Bit 0: On/Off (always can be stopped) Bit 1: Mode Bit 2: Setting Temp Bit 3: Fan	Read/Write
9	READ_ONOFF	On/Off Read: 0: Off 1: On	Read
10	READ_MODE	Mode Read 0: Cool 2: Fan 4: Auto 1: Dry 3: Heat	Read
11	READ_FAN	Fan Read 0: Low 2: High 1: Medium	Read
12	READ_TSET	Setting Temperature Read (17°C to 30°C)	Read
13	READ_LOUVER	Louver Read 0 ~ 8 (8 is Auto)	Read
14~18	(Not used)	(Not used)	(Not used)
19	ERROR_CODE	Alarm Code	Read
20~21	(Not used)	(Not used)	(Not used)
22	OPER_CONDITION	Unit Operation Condition 0: OFF 2: Thermo ON 1: Thermo OFF 3: Alarm	Read
23~31	(Not used)	(Not used)	(Not used)

Note 1: Offset Position is: 20000 + N*32 + Address as shown in table, where N is Indoor Unit Address.

■ Configuration method

Every HARC-MODBUS can control up to 32 I.U, considering that in the same H-LINK can be connected up to 128 I.U, it must be set which indoor units are selected for each HARC-MODBUS.

This configuration is not required in case of CHILLER application.

Setting concept consist in an "id" table listing up to 32 numbers for the assignation of each OU+IU addresses as shows next:

Id	Refrigerant cycle address	Indoor unit address
00	00	00
01	00	01
02	00	02
03	00	03
04	00	04
05	00	05
06	00	06
07	00	07
08	00	08
09	00	09
10	00	10
11	00	11
12	00	12
13	00	13
14	00	14
15	00	15

Id	Refrigerant cycle address	Indoor unit address
16	01	00
17	01	01
18	01	02
19	01	03
20	01	04
21	01	05
22	01	06
23	01	07
24	01	08
25	01	09
26	01	10
27	01	11
28	01	12
29	01	13
30	01	14
31	01	15



Note:

- It can be selected for 1 HARC-MODBUS up to 32 I.U from 16 different refrigerant cycles or 32 I.U from the same refrigerant cycle.



Caution:

- Be sure not to set same Indoor Unit to more than one HARC-MODBUS. This error is undetectable and can cause undesired operations.

No.	Action	7 segments (display)	Remarks
1	Press SW4 for 3 seconds	id	Configuration mode selected
2	Press SW4	00	Id selection (IU No.) from 0 to 31 by pushing SW5 ▲ or SW6 ▼
3	Press SW4	all	Refrigerant cycle address
4	Press SW4	---→00	Refrigerant cycle address selection from 0 to 15 (e.g. 00) (by pushing SW5 ▲ & SW6 ▼)
5	Press SW4	all	Indoor unit address
6	Press SW4	---→00	Indoor unit address selection from 0 to 15 (e.g. 00) (by pushing SW5 ▲ & SW6 ▼)
For "Id" 01 repeat steps 1 to 6			
7	Press SW4 for 3 seconds	id	Configuration mode selected
8	Press SW4	00→01	Id selection (IU No.) from 0 to 31 by pushing SW5 ▲ or SW6 ▼
9	Press SW4	all	Refrigerant cycle address
10	Press SW4	---→00	Refrigerant cycle address selection from 0 to 15 (e.g. 00) (by pushing SW5 ▲ & SW6 ▼)
11	Press SW4	all	Indoor unit address
12	Press SW4	---→01	Indoor unit address selection from 0 to 15 (e.g. 01; push SW5 once) (by pushing SW5 ▲ & SW6 ▼)
... Repeat steps 1 to 6 for all the rest "Id"			
187	Press SW4 for 3 seconds	id	Configuration mode selected
188	Press SW4	00→31	Id selection (IU No.) from 0 to 31 by pushing SW5 ▲ or SW6 ▼
189	Press SW4	all	Refrigerant cycle address
190	Press SW4	---→01	Refrigerant cycle address selection from 0 to 15 (e.g. 01; push SW5 once) (by pushing SW5 ▲ & SW6 ▼)
191	Press SW4	all	Indoor unit address
192	Press SW4	---→15	Indoor unit address selection from 0 to 15 (e.g. 15; push SW6 once) (by pushing SW5 ▲ & SW6 ▼)

6.2 CHILLER: Data available

Address	Name	Description	Values	Read/Write
0	EXIST	Exist	0: Not exist 1: Exist	Read
1	SYSTEM_ADDRESS	Chiller Address	0~ 15 in H-LINK 1	Read
2	(Not used)	(Not used)	(Not used)	(Not used)
3	ONOFF_SET	On/Off setting order:	0: Stop 1: Run	Read/Write
4	MODE_SET	Mode Setting order	0: Cool 1: Heat	Read/Write
5	TEMP_SET_C	COOL setting temperature	(see note *)	Read/Write
6	TEMP_SET_H	HEAT setting temperature		
7	CENTRAL_SET	Central Setting	0: Local 1: Remote	Read/Write
8	ONOFF_STATUS	On/Off Status	0: Off 1: On	Read
9	MODE_STATUS	Mode Status	0: Cool 1: Heat	Read
10	TEMP_C_STATUS	COOL Setting Temperature Status		Read
11	TEMP_H_STATUS	HEAT Setting Temperature Status		Read
12	WATER_INLET	Inlet temperature		Read
13	WATER_OUTLET	Outlet temperature		Read
14	AMBIENT_TEMPERATURE	Ambient temperature		Read
15	OPER_CONDITION	Unit operation condition	0: OFF 1: Thermo OFF 2: Thermo ON 3: Alarm	Read
16	ERROR_CODE_CH	Alarm code for general CHILLER alarm		Read
17~22	ERROR_CODE_CYC	Alarm code for cycle alarm (1~6)		Read
23~31	(Not used)	(Not used)	(Not used)	(Not used)

 **Notes:**

- Offset Position is: $40000 + N*32 + \text{Address}$ as shown in table, where N is Water Chiller Address.
- Status (real value) and Set (value ordered) parameters have usually the same value but, in some cases, some of them can be different. It is recommended to use Set parameters for normal control.
- *) When Temperature Setting and Operation Mode are changed at the same time, order first the operation mode change and later set the desired temperature.

6.3 Alarm code list for CHILLER

6.3.1 CHILLER alarms code list

CHILLER alarm		Description	H-LINK
7SEG1	7SEG2		Code
11	11	Failure of Water Inlet Temperature Thermistor	20
12	12	Failure of Water Outlet Temperature Thermistor (only for single cycle unit)	21
22	22	Failure of Ambient Temperature Thermistor (open/short)	24
5P	5P	No Feedback Signal from Water Pump	26
13	13	Activation of Freeze Protection Control (only for single cycle unit)	27
6C	6C	Alarm of Water Failure (Differential Pressure Switch or Flow Switch Option)-Condenser	28
6E	6E	Alarm of Water Failure (Differential Pressure Switch or Flow Switch Option)-Evaporator	29
14	14	Activation of Thermostat for excessively High Water Temperature (Only single cycle units)	30
RP	RP	Activation of additional protection device	31
05	05	Phase Abnormally	32
CP	CP	Error Communication between Control PCB (PCB _{C1} , PCB _{C2})	33
03	03	Error communication between Chiller and Remote Controller (H-LINK)	34
EU	EU	Error Communication between Expansion Valve PCB and Control PCB	36
40	40	Incorrect Operation	40~45, 47,47,54

6.3.2 Cycle alarms code list

Cycle alarm		Description	H-LINK
7SEG1	7SEG2		Code
L _n	H _n	Activation of High Pressure Switch	1
L _n	L _n	Activation of Low Pressure Control	2
L _n	n _n	Activation of Compressor Internal Thermostat	3
L _n	B _n	Activation of Discharge Gas Thermistor	4
L _n	S _n	Activation of Thermal Relay for Compressor or Malfunction of Auxiliary Relay ARm	5
L _n	F ₀	Incorrect Setting of Fan Number	6
L _n	4 _n	Activation of Fan Motor Internal Thermostat	7
L _n	L _n	Excessively Low Pressure	8
L _n	9 _n	Excess Low Temperature of Cooler Inlet Refrigerant	10
L _n	2 _n	Failure of Discharge Gas Pressure Sensor (open/short)	11
L _n	2 _B	Failure of Suction Gas Pressure Sensor (open/short)	12
L _n	1 ₂	Failure of Water Outlet Temperature Thermistor (for non single cycle unit)	14
L _n	2 ₃	Failure of Discharge Gas Thermistor (open/short)	15
L _n	2 ₆	Failure of Suction Gas Thermistor (open/short)	16
L _n	0 ₅	Phase Abnormally	17
L _n	2 ₁	Failure of Cooler Inlet Refrigerant Thermistor (open/Short)	19
L _n	L _n	Activation of Suction Gas Thermistor	20
L _n	1 ₃	Activation of Freeze Protection Control (for non single cycle unit)	21
L _n	2 ₄	Failure of Thermistor set before Expansion Valve (open/short)	23
L _n	2 ₅	Failure of Water Outlet Thermistor - Cooler Backside (open/short)	24
F _n	5 ₁	Inverter power Supply abnormally	34

7. Troubleshooting

N°	Alarm Code	Description	Countermeasure
1	EE → 5 1	Indoor Units have not communicated with HARC-MODBUS for more than 10 min.	<ol style="list-style-type: none"> 1. Ensure that H-LINK connection is correctly done in HARC (K1) and also Indoor Units. 2. Ensure that Power are supplied to Air Conditioners.
2	EE → 5 3	Indoor Units have never communicated with HARC-MODBUS	<ol style="list-style-type: none"> 1. Ensure that H-LINK connection is correctly done in HARC (K1) and also in Indoor Units. 2. Ensure that Power are supplied to Air Conditioners.
3	D7 is always OFF	No LED is flickering on PCB and 7 segments are OFF	<p> Notes:</p> <ul style="list-style-type: none"> - Power source output DC signal has a rotary switch that must be correctly set to get +5V DC. - D7 must be in ON.
4	D12 is never flickering	HARC-MODBUS is not reading/ sending data (D12 is never flickering)	<ol style="list-style-type: none"> 1. Check connection between MODBUS devices and K5.
5	D12 is not flickering	HARC is not operating (D13 is not flickering)	<ol style="list-style-type: none"> 1. Check SW3 is in RUN position. If no, set RUN and push reset.
6	D4 & D11 are not flickering	There is no H-LINK communication from HARC-MODBUS	<ol style="list-style-type: none"> 1. D4 is flickering but D11 is not flickering. → See line N°6, countermeasure 1. 2. D4 neither D11 are not flickering. → See line N°3, countermeasure 1.

Contenido

1.	Resumen de seguridad _____	20
2.	Nombres de los componentes _____	20
3.	Especificaciones _____	21
4.	Instalación _____	22
4.1	Datos de dimensiones _____	22
4.2	Sujeción _____	22
5.	Conexión del cableado _____	23
5.1	Cableado eléctrico _____	23
5.2	Ajuste del conmutador DIP _____	24
6.	Funcionamiento _____	28
6.1	PACKAGED: datos disponibles _____	28
6.2	CHILLER: datos disponibles _____	31
6.3	Lista de códigos de alarma del CHILLER _____	32
6.3.1	Lista de códigos de alarma del CHILLER _____	32
6.3.2	Lista de códigos de alarma del ciclo _____	33
7.	Resolución de problemas _____	34

**Nota:**

Este manual proporciona información básica para la instalación y cableado del HARC-MODBUS.

1. Resumen de seguridad

⚠️ Precaución:

No conecte la entrada de voltaje al sistema de control antes de terminar correctamente la instalación.

Lea este manual con atención antes de llevar a cabo la instalación.

Lea este manual para configurar el HARC-MODBUS.

⚠️ Atención:

No instale el HARC-MODBUS en lugares... :

- Con vapor, aceite o líquidos dispersos.
- Donde haya fuentes de calor en las proximidades (entornos sulfuricos).
- Donde se detecte generación, acumulación o fugas de gases inflamables.
- Cercanos al mar, en entornos salinos, ácidos o alcalinos.

⚠️ Atención:

Instale el HARC MODBUS lejos de posibles fuentes de ondas electromagnéticas.

Respete las normas eléctricas locales.

Use un circuito de alimentación que no sufra demandas máximas.

Asegúrese de que deja espacio suficiente alrededor del HARC MODBUS (véase la figura) para que el calor se pueda disipar correctamente (véase "Instalación").

Si instala el HARC MODBUS en posición vertical, coloque la fuente de alimentación en la parte inferior.

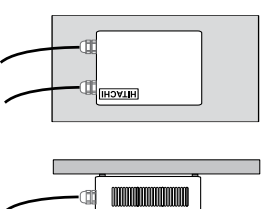

2. Nombres de los componentes

La figura muestra los nombres de los componentes del HARC-MODBUS.

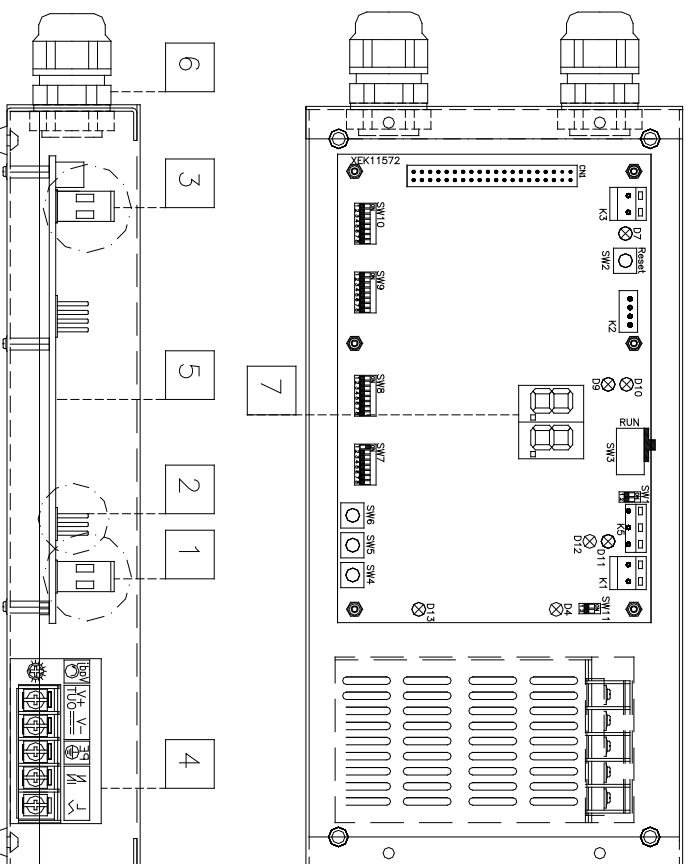

- 1 K1: Conector H-LINK: Conectado a CSNET WEB
- 2 K5: Puerto serie RS485
- 3 K3: Conexión de alimentación de +5 Vcc
- 4 Fuente de alimentación: 230 Vca/5 Vcc
- 5 PCB H-LINK
- 6 Prensasestopas (2)
- 7 segmentos

3. Especificaciones

Especificaciones del hardware

Elemento	Especificaciones
Fuente de alimentación	1 fase, 230 V \pm 10%, 50 Hz
Consumo	25 W (máximo)
Dimensiones exteriores	Ancho: 143 mm, fondo: 302 mm, altura: 76 mm
Peso	1,75 kg
Condiciones de montaje	En interiores (en un panel de control o sobremesa)
Temperatura ambiente	0~40 °C
Humedad	20~85% (sin condensación)

MODBUS - Comunicación con el sistema superior

Elemento	Especificaciones
K5	Puerto serie RS485 (conector de 3 patillas) - Protocolo MODBUS
Línea de comunicación	Cable de par trenzado. Polaridad
Sistema de comunicación	Conexión serie multipunto, semidúplex
Método de comunicación	Sin paridad o selección de paridad par/impar. Longitud de los datos: 8 bits (véase el capítulo 5)
Velocidad en baudios de transmisión	19200/9600 baudios (véase el capítulo 5)
Longitud	máx. 1200 m de acuerdo con EIA-485

H-LINK - Comunicación con las unidades

Elemento	Especificaciones
Comunicación con	HITACHI PACKAGED/CHILLER
Línea de comunicación	Cable de par trenzado blindado, sin polaridad
Sistema de comunicaciones	Semidúplex
Método de comunicación	Asíncrono
Velocidad de transmisión	9600 baudios
Longitud del cableado	1000 m máximo (longitud total del bus H-LINK I/O)
Número máximo de HARC-MODBUS	8 HARC-MODBUS/SISTEMA H-LINK (PACKAGED) 1 HARC-MODBUS/SISTEMA H-LINK (CHILLER)



Atención:

HARC-MODBUS no puede hacer funcionar unidades interiores sin un mando a distancia conectado.

4. Instalación

Cuando desembale el HARC-MODBUS, compruebe que no ha sufrido daño alguno durante el transporte.

4.1 Datos de dimensiones

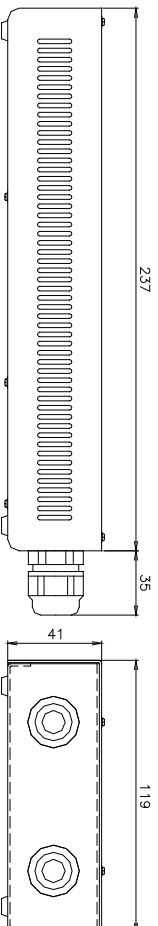

4.2 Sujeción

Lleve a cabo el procedimiento siguiente:

- 1 Retire los soportes de caucho.
- 2 Quite los 4 tornillos de la tapa superior y retírela.
- 3 Sujete la caja a la placa vertical posterior desde el interior con tornillos M4 (no suministrados) y ponga arandelas de 3 mm en el exterior para separar la caja de la pared.
- 4 Vuelva a colocar la tapa. Asegúrese de colocarla correctamente.
- 5 Mantenga libre el área de rejilla para ventilación y conexión de cables.

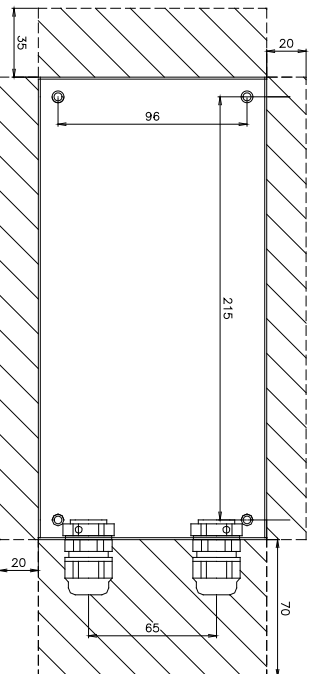

⚠ Atención:

- Antes de aplicar alimentación y encender el HARC-MODBUS, debe asegurarse de lo siguiente:

1. Todos los circuitos están conectados correctamente.
2. Se han realizado todas las conexiones H-Link.
3. Siga las normativas locales para la instalación eléctrica del HARC-MODBUS y los circuitos asociados.

Cualquier unidad no conectada o que no reciba alimentación cuando encienda el HARC-MODBUS no será reconocida y deberá configurarse posteriormente.

⚠ Precaución:

- Los cables de señales deben ser tan cortos como sea posible.

Deje una distancia de más de 150 mm entre otros cables de alimentación. No los conecte juntos (aunque pueden cruzarse). Si es necesario instalarlos juntos, tome las siguientes medidas para evitar el ruido:

- Proteja el cable de señales con un tubo metálico conectado a tierra en un extremo.
- Para comunicaciones, utilice cable blindado conectado a tierra en un extremo.

⚠ Peligro:

- Desconecte siempre la fuente de alimentación del HARC-MODBUS cuando manipule la máquina para evitar descargas eléctricas.

- No conecte la interfaz a la fuente de alimentación hasta que haya terminado la instalación.

- Respete estrictamente los códigos y normas de seguridad locales cuando conecte la máquina a la red eléctrica.

- Necesitará un cable con tres hilos (dos núcleos y tierra) con un enchufe adecuado en un extremo.

5. Conexión del cableado

5.1 Cableado eléctrico

Para que funcione, el HARC-MODBUS debe conectarse a las señales de entrada y salida, cables de fuente de alimentación y H-LINK correspondientes.

Nº	Especificaciones de los cables
1	Circuito de la fuente de alimentación 1 fase, 230 V, 50 Hz, 25 W (con circuito de protección)
2	MODBUS
3	H-LINK
4	Fuente de alimentación de las PCBs +5 Vcc. Imáx = 5 A cc



Nota:

No instale el HARC-MODBUS en lugares, excepto 4, suministrados por el instalador.

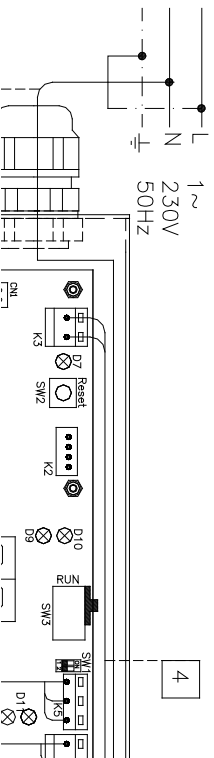

Protecciones suministradas por el instalador:
CB/EF: 5 A
ELB: 2/40 A/30 mA

CB: Disyuntor
EF: Fusible eléctrico
ELB: Disyuntor de fuga a tierra

5.2 Ajuste del conmutador DIP

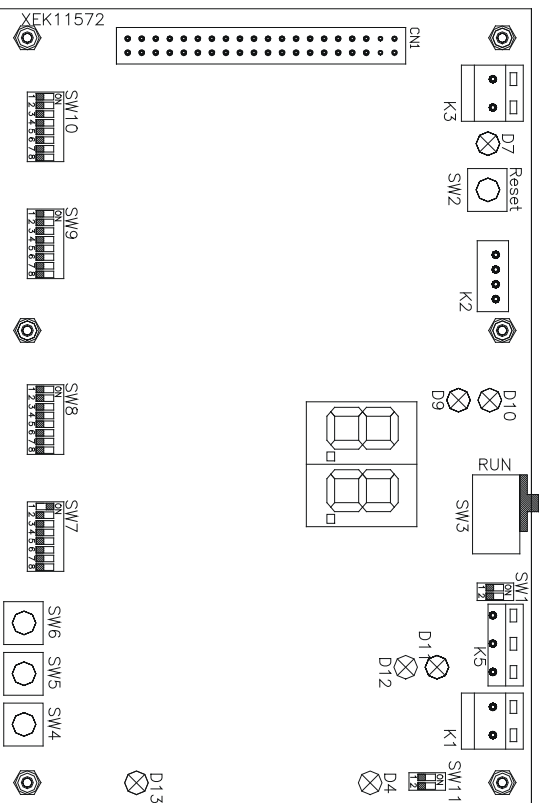

Nombre	Función	Ajuste de fábrica	Descripción
SW1	No disponible	ON 1 2	Todos en off (ninguna función)
SW2	Reinicializar	-	Botón de reinicialización. Para su uso en caso de que se bloquee el programa
SW3 (TELE)	No disponible	RUN	Para ajustes en fábrica. No lo cambie nunca
SW4	Configuración	-	Ajuste de funciones
SW5	Configuración	-	Ajuste de funciones
SW6	Configuración	-	Ajuste de funciones
SW7	Opciones 2	ON 1 2 3 4 5 6 7 8	SW7-1: OFF-SLAVE / ON-MASTER. Para utilizar en caso de existir varios HARC-MODBUS en la misma dirección H-LINK SW7-2: OFF-EVENT CONTROL/ON-CHANGE CONTROL SW7-3: OFF - Paridad desactivada/ON - Paridad activada SW7-4: OFF - Paridad par/ON - Paridad impar SW7-5: OFF - 19200 Bps/ON - 9600 Bps SW7-(6~8): No se utiliza
SW8	Opciones 1 (tipo de aplicación)	ON 1 2 3 4 5 6 7 8	SW8-1: OFF-PACKAGED / ON-CHILLER. Para ajustar de acuerdo con la aplicación de las unidades SW8-2~8: No se utiliza
SW9	No disponible	ON 1 2 3 4 5 6 7 8	Todos en off (ninguna función)
SW10	Dirección de HARC-MODBUS	ON 1 2 3 4 5 6 7 8	Dirección de HARC-MODBUS de 1 a 32 con las patillas 1 a 5
SW11	H-LINK DSW	ON 1 2	DSW de 2 patillas SW11-1: Resistencia final de H-LINK SW11-2: Protección de fusibles de H-LINK
D4, D11	H-LINK	-	Transmisión H-LINK
D7	Línea	-	Encendido/apagado de la fuente de alimentación
D9/D10	No se utiliza	-	-
D12	MODBUS	-	Comunicación de Modbus en RS485
D13	Funcionamiento	-	Modo de software normal

■ SW7 – AJUSTE DE FUNCIONES 1

SW7	Descripción
<p>Configuración como MAESTRO/ESCLAVO:</p> <p>MAESTRO: SW7-1=ON Sólo se puede configurar un HARC-MODBUS como HARC MODBUS maestro Ajustes predeterminados</p> <p>ESCLAVO: SW7-1 = OFF Debe configurarse 1 HARC-MODBUS como MAESTRO y el resto de HARC-MODBUS del mismo H-LINK como ESCLAVOS</p>	<p>Modo de actualización de datos</p> <p>Configuración de CONTROL DE INCIDENCIAS: SW7-2: OFF Los parámetros se actualizan en la UI cada vez que BMS escribe un parámetro de ajuste (aunque no se cambie ningún valor). Ajustes predeterminados</p> <p>Configuración de CONTROL DE CAMBIOS: SW7-2: ON Los parámetros se actualizan en la UI sólo se cuando se cambian algunos valores</p>
<p>Configuración de paridad</p> <p>SW7-3: OFF: Configuración sin paridad</p> <p>SW7-3: Activado: Configuración con paridad (véase la configuración de SW7-4 para conocer el tipo de paridad)</p>	<p>Configuración del tipo de paridad</p> <p>SW7-4: OFF: Paridad par (si SW7-3: ON) SW7-4: Activado: Paridad impar (si SW7-3: ON)</p>
<p>Velocidad en baudios de la comunicación</p> <p>SW7-5: OFF 19200 Bps SW7-5: ON 9600 Bps</p>	

■ SW8 – AJUSTE DE FUNCIONES 2

SW8	Descripción
<p>Configuración para PACKAGED /CHILLER</p> <p>Aplicaciones PACKAGED: SW8-1: OFF Aplicaciones CHILLER: SW8-1: ON</p>	

■ SW10 – Dirección de HARC (el mismo concepto que la dirección de la U. E./ciclo de refrigerante)

SW10				Descripción
Dirección: 1 ON <input type="checkbox"/> <input type="checkbox"/> <input type="checkbox"/> <input type="checkbox"/> <input type="checkbox"/> <input type="checkbox"/> <input type="checkbox"/> <input type="checkbox"/> 1 2 3 4 5 6 7 8	Dirección: 2 ON <input type="checkbox"/> <input type="checkbox"/> <input type="checkbox"/> <input type="checkbox"/> <input type="checkbox"/> <input type="checkbox"/> <input type="checkbox"/> <input type="checkbox"/> 1 2 3 4 5 6 7 8	Dirección: 3 ON <input type="checkbox"/> <input type="checkbox"/> <input type="checkbox"/> <input type="checkbox"/> <input type="checkbox"/> <input type="checkbox"/> <input type="checkbox"/> <input type="checkbox"/> 1 2 3 4 5 6 7 8	Dirección: 4 ON <input type="checkbox"/> <input type="checkbox"/> <input type="checkbox"/> <input type="checkbox"/> <input type="checkbox"/> <input type="checkbox"/> <input type="checkbox"/> <input type="checkbox"/> 1 2 3 4 5 6 7 8	Configuración de la dirección de HARC Dirección de HARC-MODBUS usada por el sistema MODBUS Las patillas 1~5 del SW10 deben ajustarse de acuerdo con el diagrama correspondiente de la dirección deseada Las patillas 6~8 del SW10 deben mantenerse en OFF
Dirección: 5 ON <input type="checkbox"/> <input type="checkbox"/> <input type="checkbox"/> <input type="checkbox"/> <input type="checkbox"/> <input type="checkbox"/> <input type="checkbox"/> <input type="checkbox"/> 1 2 3 4 5 6 7 8	Dirección: 6 ON <input type="checkbox"/> <input type="checkbox"/> <input type="checkbox"/> <input type="checkbox"/> <input type="checkbox"/> <input type="checkbox"/> <input type="checkbox"/> <input type="checkbox"/> 1 2 3 4 5 6 7 8	Dirección: 7 ON <input type="checkbox"/> <input type="checkbox"/> <input type="checkbox"/> <input type="checkbox"/> <input type="checkbox"/> <input type="checkbox"/> <input type="checkbox"/> <input type="checkbox"/> 1 2 3 4 5 6 7 8	Dirección: 8 ON <input type="checkbox"/> <input type="checkbox"/> <input type="checkbox"/> <input type="checkbox"/> <input type="checkbox"/> <input type="checkbox"/> <input type="checkbox"/> <input type="checkbox"/> 1 2 3 4 5 6 7 8	
Dirección: 9 ON <input type="checkbox"/> <input type="checkbox"/> <input type="checkbox"/> <input type="checkbox"/> <input type="checkbox"/> <input type="checkbox"/> <input type="checkbox"/> <input type="checkbox"/> 1 2 3 4 5 6 7 8	Dirección: 10 ON <input type="checkbox"/> <input type="checkbox"/> <input type="checkbox"/> <input type="checkbox"/> <input type="checkbox"/> <input type="checkbox"/> <input type="checkbox"/> <input type="checkbox"/> 1 2 3 4 5 6 7 8	Dirección: 11 ON <input type="checkbox"/> <input type="checkbox"/> <input type="checkbox"/> <input type="checkbox"/> <input type="checkbox"/> <input type="checkbox"/> <input type="checkbox"/> <input type="checkbox"/> 1 2 3 4 5 6 7 8	Dirección: 12 ON <input type="checkbox"/> <input type="checkbox"/> <input type="checkbox"/> <input type="checkbox"/> <input type="checkbox"/> <input type="checkbox"/> <input type="checkbox"/> <input type="checkbox"/> 1 2 3 4 5 6 7 8	
Dirección: 13 ON <input type="checkbox"/> <input type="checkbox"/> <input type="checkbox"/> <input type="checkbox"/> <input type="checkbox"/> <input type="checkbox"/> <input type="checkbox"/> <input type="checkbox"/> 1 2 3 4 5 6 7 8	Dirección: 14 ON <input type="checkbox"/> <input type="checkbox"/> <input type="checkbox"/> <input type="checkbox"/> <input type="checkbox"/> <input type="checkbox"/> <input type="checkbox"/> <input type="checkbox"/> 1 2 3 4 5 6 7 8	Dirección: 15 ON <input type="checkbox"/> <input type="checkbox"/> <input type="checkbox"/> <input type="checkbox"/> <input type="checkbox"/> <input type="checkbox"/> <input type="checkbox"/> <input type="checkbox"/> 1 2 3 4 5 6 7 8	Dirección: 16 ON <input type="checkbox"/> <input type="checkbox"/> <input type="checkbox"/> <input type="checkbox"/> <input type="checkbox"/> <input type="checkbox"/> <input type="checkbox"/> <input type="checkbox"/> 1 2 3 4 5 6 7 8	
Dirección: 17 ON <input type="checkbox"/> <input type="checkbox"/> <input type="checkbox"/> <input type="checkbox"/> <input type="checkbox"/> <input type="checkbox"/> <input type="checkbox"/> <input type="checkbox"/> 1 2 3 4 5 6 7 8	Dirección: 18 ON <input type="checkbox"/> <input type="checkbox"/> <input type="checkbox"/> <input type="checkbox"/> <input type="checkbox"/> <input type="checkbox"/> <input type="checkbox"/> <input type="checkbox"/> 1 2 3 4 5 6 7 8	Dirección: 19 ON <input type="checkbox"/> <input type="checkbox"/> <input type="checkbox"/> <input type="checkbox"/> <input type="checkbox"/> <input type="checkbox"/> <input type="checkbox"/> <input type="checkbox"/> 1 2 3 4 5 6 7 8	Dirección: 20 ON <input type="checkbox"/> <input type="checkbox"/> <input type="checkbox"/> <input type="checkbox"/> <input type="checkbox"/> <input type="checkbox"/> <input type="checkbox"/> <input type="checkbox"/> 1 2 3 4 5 6 7 8	
Dirección: 21 ON <input type="checkbox"/> <input type="checkbox"/> <input type="checkbox"/> <input type="checkbox"/> <input type="checkbox"/> <input type="checkbox"/> <input type="checkbox"/> <input type="checkbox"/> 1 2 3 4 5 6 7 8	Dirección: 22 ON <input type="checkbox"/> <input type="checkbox"/> <input type="checkbox"/> <input type="checkbox"/> <input type="checkbox"/> <input type="checkbox"/> <input type="checkbox"/> <input type="checkbox"/> 1 2 3 4 5 6 7 8	Dirección: 23 ON <input type="checkbox"/> <input type="checkbox"/> <input type="checkbox"/> <input type="checkbox"/> <input type="checkbox"/> <input type="checkbox"/> <input type="checkbox"/> <input type="checkbox"/> 1 2 3 4 5 6 7 8	Dirección: 24 ON <input type="checkbox"/> <input type="checkbox"/> <input type="checkbox"/> <input type="checkbox"/> <input type="checkbox"/> <input type="checkbox"/> <input type="checkbox"/> <input type="checkbox"/> 1 2 3 4 5 6 7 8	
Dirección: 25 ON <input type="checkbox"/> <input type="checkbox"/> <input type="checkbox"/> <input type="checkbox"/> <input type="checkbox"/> <input type="checkbox"/> <input type="checkbox"/> <input type="checkbox"/> 1 2 3 4 5 6 7 8	Dirección: 26 ON <input type="checkbox"/> <input type="checkbox"/> <input type="checkbox"/> <input type="checkbox"/> <input type="checkbox"/> <input type="checkbox"/> <input type="checkbox"/> <input type="checkbox"/> 1 2 3 4 5 6 7 8	Dirección: 27 ON <input type="checkbox"/> <input type="checkbox"/> <input type="checkbox"/> <input type="checkbox"/> <input type="checkbox"/> <input type="checkbox"/> <input type="checkbox"/> <input type="checkbox"/> 1 2 3 4 5 6 7 8	Dirección: 28 ON <input type="checkbox"/> <input type="checkbox"/> <input type="checkbox"/> <input type="checkbox"/> <input type="checkbox"/> <input type="checkbox"/> <input type="checkbox"/> <input type="checkbox"/> 1 2 3 4 5 6 7 8	
Dirección: 29 ON <input type="checkbox"/> <input type="checkbox"/> <input type="checkbox"/> <input type="checkbox"/> <input type="checkbox"/> <input type="checkbox"/> <input type="checkbox"/> <input type="checkbox"/> 1 2 3 4 5 6 7 8	Dirección: 30 ON <input type="checkbox"/> <input type="checkbox"/> <input type="checkbox"/> <input type="checkbox"/> <input type="checkbox"/> <input type="checkbox"/> <input type="checkbox"/> <input type="checkbox"/> 1 2 3 4 5 6 7 8	Dirección: 31 ON <input type="checkbox"/> <input type="checkbox"/> <input type="checkbox"/> <input type="checkbox"/> <input type="checkbox"/> <input type="checkbox"/> <input type="checkbox"/> <input type="checkbox"/> 1 2 3 4 5 6 7 8	Dirección: 32 ON <input type="checkbox"/> <input type="checkbox"/> <input type="checkbox"/> <input type="checkbox"/> <input type="checkbox"/> <input type="checkbox"/> <input type="checkbox"/> <input type="checkbox"/> 1 2 3 4 5 6 7 8	

■ Ejemplo

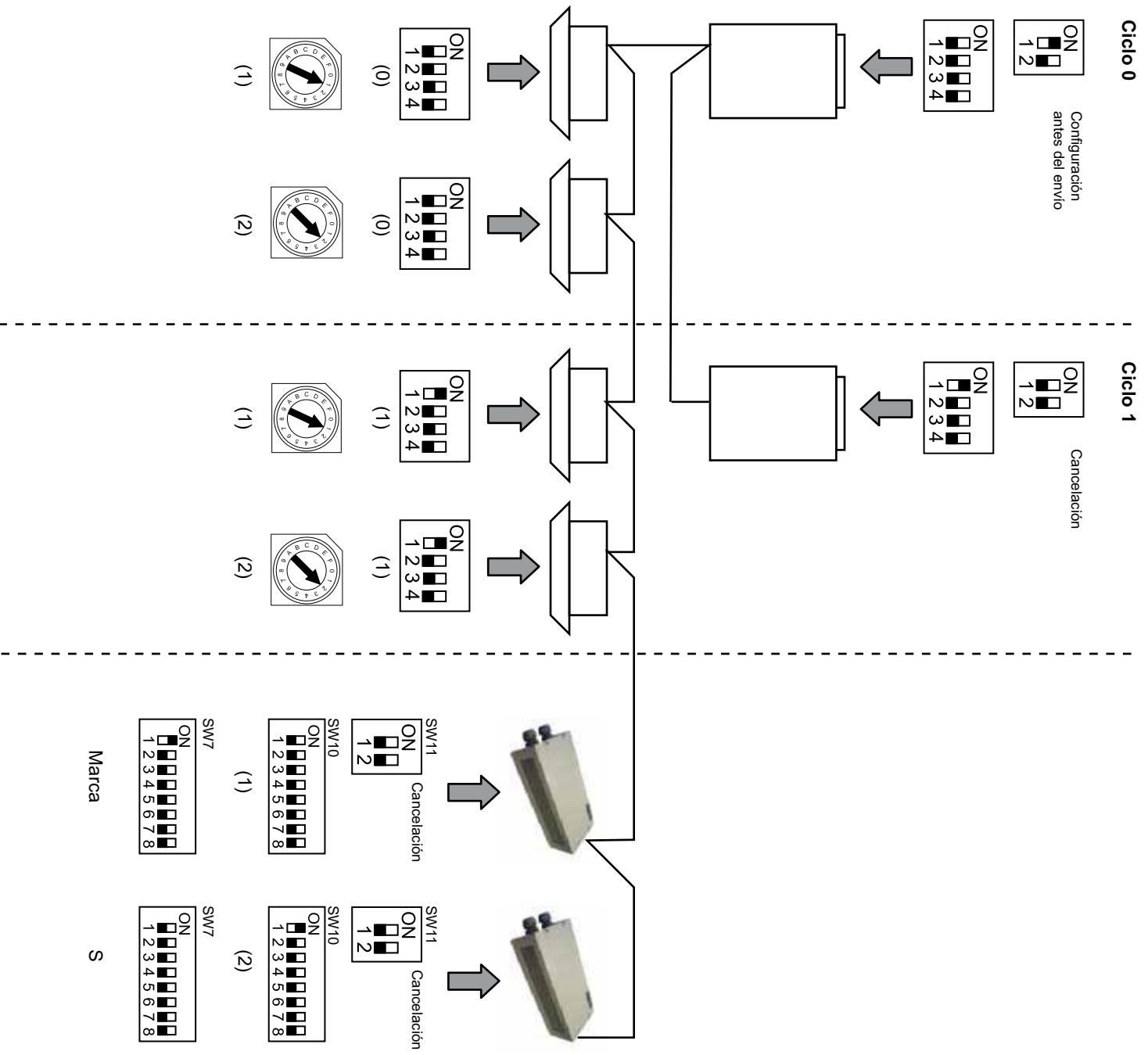

6. Funcionamiento

6.1 PACKAGED: datos disponibles

Dirección (Nota 1)	Nombre	Descripción	Lectura/escritura
0	EXIST	EXIST: 0: No existe 1: Existe	Lectura
1	SYSTEM_ADDRESS	Dirección del sistema: 0 ~ 15 en H-LINK 1	Lectura
2	UNIT_ADDRESS	Dirección de la unidad: 0 ~ 15 en H-LINK1	Lectura
3	SET_ONOFF	Orden de ajuste de marcha/parada 0: Parar 1: Marcha	Lectura/escritura
4	SET_MODE	Orden de ajuste del modo: 0: Enfriamiento 2: Ventilador 4: Automático 1: Deshumidificación 3: Calefacción	Lectura/escritura
5	SET_FAN	Orden de ajuste del ventilador: 0: Baja 2: Alta 1: Media	Lectura/escritura
6	SET_TSET	Temperatura de ajuste: 17 °C ~ 30 °C	Lectura/escritura
7	SET_LOUVER	Ajuste del deflector: 0 ~ 8 (8 es automático)	Lectura/escritura
8	SET_CENTRAL	Ajuste central Bit 0: Encendido/apagado (siempre se puede parar) Bit 1: Modo Bit 2: Temp. ajustada Bit 3: Ventilador	Lectura/escritura
9	READ_ONOFF	Encendido/apagado de lectura: 0: Desactivado 1: Activado	Lectura
10	READ_MODE	Lectura de modo 0: Enfriamiento 2: Ventilador 4: Automático 1: Deshumidificación 3: Calefacción	Lectura
11	READ_FAN	Lectura de ventilador 0: Baja 2: Alta 1: Media	Lectura
12	READ_TSET	Lectura de la temperatura ajustada (17 °C a 30 °C)	Lectura
13	READ_LOUVER	Lectura de deflector 0 ~ 8 (8 es automático)	Lectura
14~18	(no se utiliza)	(no se utiliza)	(no se utiliza)
19	ERROR_CODE	Código de alarma	Lectura
20~21	(no se utiliza)	(no se utiliza)	(no se utiliza)
22	OPER_CONDITION	Condición de funcionamiento de las unidades 0: OFF 2: Termostato encendido 1: Termostato apagado 3: Alarma	Lectura
23~31	(no se utiliza)	(no se utiliza)	(no se utiliza)

Nota 1: Posición de desfase: 20000 + N*32 + dirección indicada en la tabla, donde N representa la dirección de la unidad interior.

■ **Método de configuración**

Cada HARC-MODBUS puede controlar hasta 32 U.I., teniendo en cuenta que en el mismo H-LINK se pueden conectar hasta 128 U.I., se debe ajustar qué unidades interiores se seleccionan para cada HARC-MODBUS.

Esta configuración no es necesaria en el caso de la aplicación CHILLER.

El concepto de ajuste consiste en una tabla de identificadores que lista hasta 32 números para la asignación de cada dirección de U.E.+U.I., como se indica a continuación:

Id.	Dirección del ciclo de refrigerante	Dirección de la unidad interior
00	00	00
01	00	01
02	00	02
03	00	03
04	00	04
05	00	05
06	00	06
07	00	07
08	00	08
09	00	09
10	00	10
11	00	11
12	00	12
13	00	13
14	00	14
15	00	15

Id.	Dirección del ciclo de refrigerante	Dirección de la unidad interior
16	01	00
17	01	01
18	01	02
19	01	03
20	01	04
21	01	05
22	01	06
23	01	07
24	01	08
25	01	09
26	01	10
27	01	11
28	01	12
29	01	13
30	01	14
31	01	15



Nota:

- Se pueden seleccionar para 1 HARC-MODBUS hasta 32 U.I. de 16 ciclos de refrigerante o 32 U.I. del mismo ciclo de refrigerante.



Precaución:

- Asegúrese de que no ajusta la misma unidad interior a más de un HARC-MODBUS. Este error no se puede detectar y puede provocar funcionamientos imprevistos.

Nº	Acción	Pantalla de 7 segmentos	Observaciones
1	Pulse SW4 durante 3 segundos	1d	Modo de configuración seleccionado
2	Pulse SW4	00	Selección de id. (nº de U.I.) de 0 a 31 pulsando SW5 ▲ o SW6 ▼
3	Pulse SW4	011	Dirección del ciclo de refrigerante
4	Pulse SW4	---→00	Selección de la dirección del ciclo de refrigerante de 0 a 15 (p. ej., 00) (pulsando SW5 ▲ y SW6 ▼)
5	Pulse SW4	11	Dirección de la unidad interior
6	Pulse SW4	---→00	Selección de la dirección de la unidad interior de 0 a 15 (p. ej., 00) (pulsando SW5 ▲ y SW6 ▼)
Para la "id" 01, repita los pasos del 1 al 6			
7	Pulse SW4 durante 3 segundos	1d	Modo de configuración seleccionado
8	Pulse SW4	00→01	Selección de id. (nº de U.I.) de 0 a 31 pulsando SW5 ▲ o SW6 ▼
9	Pulse SW4	011	Dirección del ciclo de refrigerante
10	Pulse SW4	---→00	Selección de la dirección del ciclo de refrigerante de 0 a 15 (p. ej., 00) (pulsando SW5 ▲ y SW6 ▼)
11	Pulse SW4	11	Dirección de la unidad interior
12	Pulse SW4	---→01	Selección de la dirección de la unidad interior de 0 a 15 (p. ej., 01; pulse SW5 una vez) (pulsando SW5 ▲ y SW6 ▼)
... Repita los pasos del 1 al 6 para el resto de id			
187	Pulse SW4 durante 3 segundos	1d	Modo de configuración seleccionado
188	Pulse SW4	00→31	Selección de id. (nº de U.I.) de 0 a 31 pulsando SW5 ▲ o SW6 ▼
189	Pulse SW4	011	Dirección del ciclo de refrigerante
190	Pulse SW4	---→01	Selección de la dirección del ciclo de refrigerante de 0 a 15 (p. ej., 01; pulse SW5 una vez) (pulsando SW5 ▲ y SW6 ▼)
191	Pulse SW4	11	Dirección de la unidad interior
192	Pulse SW4	---→15	Selección de la dirección de la unidad interior de 0 a 15 (p. ej., 15; pulse SW6 una vez) (pulsando SW5 ▲ y SW6 ▼)

6.2 CHILLER: datos disponibles

Dirección	Nombre	Descripción	Valores	Lectura/escritura
0	EXIST	Existe	0: No existe 1: Existe	Lectura
1	SYSTEM_ADDRESS	Dirección de enfriador	0~ 15 en H-LINK 1	Lectura
2	(no se utiliza)	(no se utiliza)	(no se utiliza)	(no se utiliza)
3	ONOFF_SET	Orden de ajuste de marcha/parada	0: Parar 1: Marcha	Lectura/escritura
4	MODE_SET	Orden de ajuste del modo	0: Enfriamiento 1: Calefacción	Lectura/escritura
5	TEMP_SET_C	Temperatura de ajuste en COOL	(véase la nota *)	Lectura/escritura
6	TEMP_SET_H	Temperatura de ajuste en HEAT		
7	CENTRAL_SET	Ajuste central	0: Local 1: Remoto	Lectura/escritura
8	ONOFF_STATUS	Estado de marcha/parada	0: Desactivado 1: Activado	Lectura
9	MODE_STATUS	Estado del modo	0: Enfriamiento 1: Calefacción	Lectura
10	TEMP_C_STATUS	Estado de la temperatura de ajuste en COOL		Lectura
11	TEMP_H_STATUS	Estado de la temperatura de ajuste en HEAT		Lectura
12	WATER_INLET	Temperatura de entrada		Lectura
13	WATER_OUTLET	Temperatura de salida		Lectura
14	AMBIENT_TEMPERATURE	Temperatura ambiente		Lectura
15	OPER_CONDITION	Condición de funcionamiento de las unidades	0: OFF 1: Termostato apagado 2: Termostato encendido 3: Alarma	Lectura
16	ERROR_CODE_CH	Código de alarma general para el enfriador		Lectura
17~22	ERROR_CODE_CYC	Código de alarma para el ciclo (1~6)		Lectura
23~31	(no se utiliza)	(no se utiliza)	(no se utiliza)	(no se utiliza)



Notas:

- Posición de desfase: $40000 + N*32 + \text{dirección indicada en la tabla, donde } N \text{ representa la dirección del enfriador de agua.}$
- Los parámetros de estado (valor real) y ajuste (valor definido) suelen tener el mismo valor pero, en algunos casos, algunos de ellos pueden ser distintos. Se recomienda el uso de parámetros de ajuste para el control normal.
- *) Cuando el ajuste de temperatura y el modo de funcionamiento se cambian al mismo tiempo, realice en primer lugar el cambio del modo de funcionamiento y a continuación ajuste la temperatura que desee.

6.3 Lista de códigos de alarma del CHILLER

6.3.1 Lista de códigos de alarma del CHILLER

Alarma del CHILLER		Descripción	H-LINK
7SEG1	7SEG2		Código
11	11	Fallo del termistor de la temperatura de entrada del agua	20
12	12	Fallo del termistor de temperatura de la salida del agua (sólo para unidades con 1 ciclo)	21
22	22	Fallo del termistor de temperatura ambiente (abierto/cerrado)	24
5P	5P	Ninguna señal devuelta por la bomba de agua	26
13	13	Activación del control de protección contra congelación (sólo para unidades con 1 ciclo)	27
6E	6E	Alarma por fallo del agua (opción de conmutador de presión diferencial o de conmutador de caudal) - condensador	28
6E	6E	Alarma por fallo del agua (opción de conmutador de presión diferencial o de conmutador de caudal) - evaporador	29
14	14	Activación de termostato por temperatura demasiado alta del agua (sólo para unidades con 1 ciclo)	30
RP	RP	Activación de dispositivo de protección adicional	31
05	05	Error de fases	32
CP	CP	Error de comunicaciones entre la PCB de control (PCB _{g1} , PCB _{g2})	33
03	03	Error de comunicaciones entre el enfriador y el mando a distancia (H-LINK)	34
EU	EU	Error de comunicaciones entre la PCB de la válvula de expansión y la PCB de control	36
40	40	Operación incorrecta	40~45, 47,47,54

6.3.2 Lista de códigos de alarma del ciclo

Alarma del ciclo		Descripción	H-LINK
7SEG1	7SEG2		Código
<i>L_n</i>	<i>H_n</i>	Activación de presostato de alta presión	1
<i>L_n</i>	<i>L_n</i>	Activación del control de presión baja	2
<i>L_n</i>	<i>H_n</i>	Activación del termostato interno del compresor	3
<i>L_n</i>	<i>B_n</i>	Activación del termistor de descarga de Gas	4
<i>L_n</i>	<i>S_n</i>	Activación del relé térmico para el compresor o funcionamiento incorrecto del relé auxiliar Ann	5
<i>L_n</i>	<i>F0</i>	Ajuste incorrecto del número de ventilador	6
<i>L_n</i>	<i>4_n</i>	Activación termostato ventilador	7
<i>L_n</i>	<i>L_n</i>	Presión excesivamente baja	8
<i>L_n</i>	<i>9_n</i>	Temperatura demasiado baja en la entrada de refrigerante al enfriador	10
<i>L_n</i>	<i>27</i>	Fallo del sensor de presión del gas de descarga (abierto/cerrado)	11
<i>L_n</i>	<i>28</i>	Fallo del sensor de presión del gas de aspiración (abierto/cerrado)	12
<i>L_n</i>	<i>12</i>	Fallo del termistor de temperatura de la salida del agua (sólo para unidades con 1 ciclo)	14
<i>L_n</i>	<i>23</i>	Fallo del termistor del gas de descarga (abierto/cortocircuito)	15
<i>L_n</i>	<i>26</i>	Fallo del termistor del gas de aspiración (abierto/cerrado)	16
<i>L_n</i>	<i>05</i>	Error de fases	17
<i>L_n</i>	<i>21</i>	Fallo del termistor del refrigerante de entrada del enfriador (abierto/cortocircuito)	19
<i>L_n</i>	<i>L_n</i>	Activación del termistor de gas de aspiración	20
<i>L_n</i>	<i>13</i>	Activación del control de protección contra congelación (sólo para unidades con 1 ciclo)	21
<i>L_n</i>	<i>24</i>	Fallo del termistor ajustado antes que la válvula de expansión (abierto/cortocircuito)	23
<i>L_n</i>	<i>25</i>	Fallo del termistor de entrada de agua, parte posterior del enfriador (abierto/cortocircuito)	24
<i>F_n</i>	<i>51</i>	Anomalia en la fuente de alimentación del Inverter	34

7. Resolución de problemas

Nº	Código de alarma	Descripción	Contramedida
1	EE → B 1	Las unidades interiores no se han comunicado con el HARC-MODBUS durante más de 10 minutos	<ol style="list-style-type: none"> Asegúrese de que la conexión H-LINK está bien hecha en HARC (C1) y también en las unidades interiores. Compruebe que se suministra alimentación a los acondicionadores de aire.
2	EE → B3	Las unidades interiores nunca se han comunicado con el HARC-MODBUS	<ol style="list-style-type: none"> Asegúrese de que la conexión H-LINK está bien hecha en HARC (C1) y también en las unidades interiores. Compruebe que se suministra alimentación a los acondicionadores de aire.
3	D7 debe estar en la posición OFF	Ningún LED está parpadeando en la PCB y la pantalla de 7 segmentos está apagada	 <p>Notas:</p> <ul style="list-style-type: none"> La señal de salida de corriente continua de la fuente de alimentación dispone de un interruptor giratorio que debe colocarse correctamente para obtener +5 Vcc. D7 debe estar en la posición ON.
4	D12 nunca parpadea	HARC-MODBUS no está leyendo/enviando datos (D12 nunca parpadea)	<ol style="list-style-type: none"> Compruebe la conexión entre los dispositivos MODBUS y K5.
5	D12 no parpadea	HARC no está funcionando (D13 no parpadea)	<ol style="list-style-type: none"> Compruebe que SW3 está en la posición RUN. En caso contrario, ajuste RUN y pulse RESET.
6	D4 y D11 no parpadean	No hay comunicación entre H-LINK y HARC-MODBUS	<ol style="list-style-type: none"> D4 parpadea pero D11 no lo hace. → Véase la línea nº 6, contramedida 1. D4 y D11 no parpadean. → Véase la línea nº 3, contramedida 1.

Inhalt

1.	Sicherheitsübersicht _____	36
2.	Bezeichnungen der Komponenten _____	36
3.	Technische Beschreibung _____	37
4.	Installation _____	38
4.1	Abmessungen _____	38
4.2	Befestigung _____	38
5.	Kabelanschlüsse _____	39
5.1	Verkabelung _____	39
5.2	Einstellung DIP-Schalter _____	40
6.	Betrieb _____	44
6.1	PACKAGED: Daten verfügbar _____	44
6.2	CHILLER: Daten verfügbar _____	47
6.3	Alarmodeliste für CHILLER _____	48
6.3.1	CHILLER - Alarmodeliste _____	48
6.3.2	Liste der Kreilaufalarmcodes _____	49
7.	Fehlerbehebung _____	50

**Hinweis:**

Dieses Handbuch enthält grundsätzliche Informationen zur Installation und zur Verkabelung von HARC-MODBUS.

1. Sicherheitsübersicht



Vorsicht!

Schließen Sie den Spannungseingang erst nach Abschluss der korrekten Installation an das Steuerungssystem an.

Lesen Sie dieses Handbuch vor der Installation sorgfältig durch.

Lesen Sie dieses Handbuch bevor Sie HARC-MODBUS konfigurieren.



Achtung:

Installieren Sie HARC-MODBUS in ausreichender Entfernung zu möglichen Quellen elektromagnetischer Wellen.

Halten Sie die vor Ort geltenden Elektrovorschriften ein. Verwenden Sie einen Stromkreis, der keinen Lastspitzen ausgesetzt ist.

Sorgen Sie für ausreichend Freiraum um HARC-MODBUS herum (siehe Abbildung), damit entstehende Wärme leicht entweichen kann (siehe „Installation“).

Wenn Sie HARC-MODBUS in einer senkrechten Position installieren, muss die Stromversorgung unten liegen.

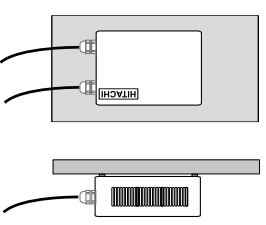

Achtung:

Installieren Sie HARC-MODBUS nicht an Orten... :

- mit Dampf, Öl oder sich fein verteilenden Flüssigkeiten.
- mit Hitzequellen in der Nähe (schwefelsäurehaltige Umgebungen).
- mit Aufstaubung, Erzeugung, oder Leakage von entzündbaren Gasen
- in Meeresnähe, in salzhaltigen, säurehaltigen oder alkalischen Umgebungen.

2. Bezeichnungen der Komponenten

Die Abbildung zeigt die Bezeichnungen der HARC-MODBUS-Komponenten.

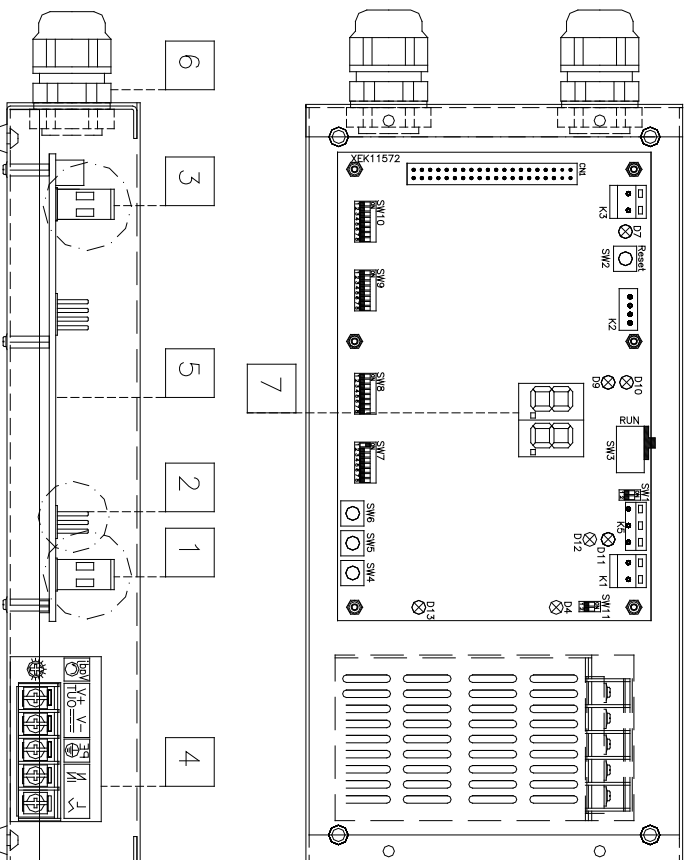

- 1 K1: H-LINK-Anschluss: angeschlossen an CSNET WEB
- 2 K5: Serieller Anschluss RS485
- 3 K3: +5 V GS Netzanschluss
- 4 Stromquelle: 230 V WS / 5 V GS
- 5 H-LINK PCB
- 6 Stopfbüchsenabdeckungen (2)
- 7 7-Segmentlanze

3. Technische Beschreibung

Technische Beschreibung der Hardware

Element	Technische Beschreibung
Stromversorgung	1~230 V \pm 10% 50 Hz
Verbrauch	25 W (maximal)
Außenabmessungen	Breite: 143 mm, Tiefe: 302 mm, Höhe: 76 mm
Gewicht	1,75 kg
Montagebedingungen	Innen (in einer Bedienungsstafel oder als Tischgerät)
Umgebungstemperatur	0~40 °C
Luftfeuchtigkeit	20~85% (ohne Kondensation)

MODBUS - Kommunikation mit dem oberen System

Element	Technische Beschreibung
K5	Serieller Anschluss RS485 (3-Pin-Anschluss) - MODBUS-Protokoll
Kommunikationsleitung	Torsionskabel: Polarität
Kommunikationssystem	Halbduplex, serieller Mehrpunktanschluss
Kommunikationsmethode	Auswahl zwischen keine Parität und gerade/ungerade: Datenlänge: 8 Bit (siehe Kapitel 5)
Baudrate der Übertragung	19200/9600 Baud (siehe Kapitel 5)
Länge	max. 1200 m entsprechend EIA-485

H-LINK - Kommunikation mit Geräten

Element	Technische Beschreibung
Kommunikation mit	HITACHI PACKAGED/CHILLER
Kommunikationsleitung	Abgeschirmtes, paarverselltes Kabel, ohne Polarität
Kommunikationssystem	Halbduplex
Kommunikationsmethode	Asynchron
Übertragungsgeschwindigkeit	9600 Bauds
Kabellänge	1000 m maximal (Gesamtlänge des HLINK I/O-Busses)
Maximale Anzahl von HARC MODBUS	8 HARC MODBUS-/H-LINK SYSTEME (PACKAGED) 1 HARC MODBUS-/H-LINK SYSTEM (CHILLER)



Achtung:

HARC-MODBUS kann ohne angeschlossene Fernbedienung keine Innengeräte steuern:

4. Installation

Überprüfen Sie beim Auspacken des HARC-MODBUS, dass das Gerät keine Transportschäden aufweist.

4.1 Abmessungen

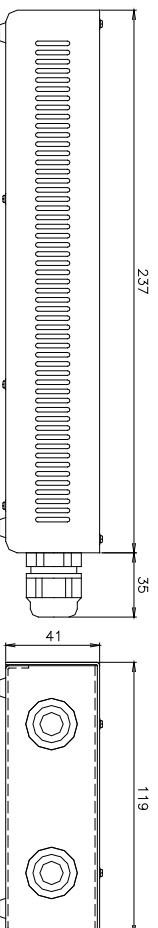

4.2 Befestigung

Gehen Sie nach folgendem Verfahren vor:

- 1 Entfernen Sie die GummifüÙe.
- 2 Lösen Sie die 4 Schrauben von der oberen Abdeckung und entfernen Sie diese.
- 3 Befestigen Sie das Gehäuse mit M4-Schrauben (nicht mitgeliefert) von innen an der senkrechten hinteren Platte und bringen Sie an der Außenseite 3 mm-Unterlegscheiben an, um einen Abstand zwischen Gehäuse und Wand zu schaffen.
- 4 Montieren Sie die obere Abdeckung wieder. Achten Sie darauf, dass die Montageposition korrekt ist.
- 5 Halten Sie den schraffierten Bereich frei für Belüftung und Kabelanschlüsse.

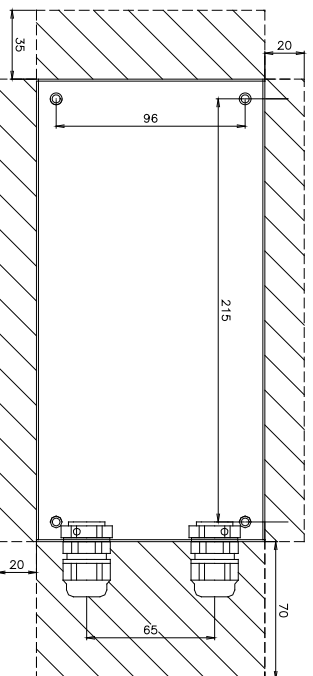

! Achtung:

- Stellen Sie vor Anlegen einer Spannung und Einschalten des HARC-MODBUS Folgendes sicher:
 1. Alle anzuschließenden Kreisläufe sind korrekt verbunden.
 2. Alle H-Link-Verbindungen wurden eingerichtet.
 3. Beachten Sie die örtlichen Vorschriften für den elektrischen Anschluss von HARC-MODBUS und den dazugehörigen Kreisläufen.
- Geräte, die beim Einschalten des HARC-MODBUS nicht angeschlossen oder mit Strom versorgt sind, werden später erkannt und müssen später konfiguriert werden.

! Vorsicht:

- Die Signalkabel sollten so kurz wie möglich sein. Halten Sie einen Abstand von mehr als 150 mm zu anderen spannungsführenden Kabeln. Verlegen Sie sie nicht zusammen (sie können sich allerdings überkreuzen). Sollte es notwendig sein, sie gemeinsam zu verlegen, treffen Sie zur Vermeidung von Störungen folgende Maßnahmen:
 - Schützen Sie das Signalkabel mit einem Metallrohr, das an einem Ende geerdet ist.
 - Verwenden Sie für die Kommunikation abgeschirmte, an einem Ende geerdete Kabel.

! Gefahr:

- Unterbrechen Sie vor eventuellen Arbeiten am Gerät immer die Stromversorgung zum HARC-MODBUS, um einen elektrischen Schlag zu vermeiden.
- Schließen Sie die Schnittstelle nicht an die Stromversorgung an, solange die Installation nicht abgeschlossen ist.
- Befolgen Sie die örtlichen Sicherheitsvorschriften und Bestimmungen, wenn Sie das Gerät an das Stromnetz anschließen.
- Sie benötigen ein Dreileiterkabel (doppelpolrig und Erdung) mit einem geeigneten Stecker an einem Ende.

5. Kabelanschlüsse

5.1 Verkabelung

Damit HARC-MODBUS korrekt funktioniert, muss es an den entsprechenden Leitungen für Eingangs- und Ausgangssignale, an die Netzkabel und H-LINK angeschlossen sein.

Nr.	Anschluss	Technische Beschreibung der Kabel
1	Netzanschluss 1 ~ 230 V 50 Hz 25 W (mit Schutzschaltung)	Auswahl der Kabel gemäß örtlichen Vorschriften (empfohlene Mindeststärke: 1,5 mm ² H05RN-F)
2	MODBUS	3 Kabelbündel 0,75 mm ² (Typ H05RN-F). Unterschiedliche Farben für jedes Einzelkabel verwenden. (Serieller Anschluss RS485)
3	H-LINK	Kommunikationskabel für die Verbindung des HARC-MODBUS an eine Hitachi-Anlage, per CSNET WEB oder einem anderen Hitachi-Gerät unter Verwendung derselben H-LINK-Anschlüsse. Abgeschirmtes, paarversitetes Kabel, 0,75 mm ² (Typ H05RN-F). Die Abschirmung darf nur an einer Kabelseite geerdet sein.
4	PCB-Stromversorgung +5 V GS, I _{max} = 5 A GS	Paarkabel, 0,75 mm ² (Typ H05RN-F).



Hinweis:

Alle Kabel, außer 4 werden vor Ort bereitgestellt.

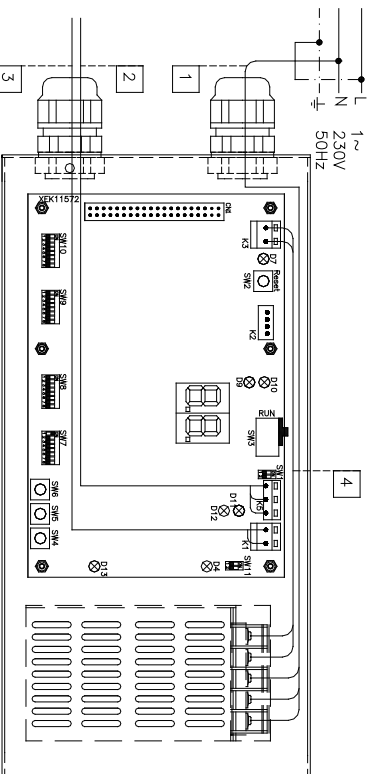

Nicht mitgelieferte
Sicherungseinrichtungen:

CB/EF: 5 A

ELB: 2/40 A/30 mA

CB: Trennschalter

EF: Elektrische Schutzsicherung

ELB: FI-Schutzschalter

5.2 Einstellung DIP-Schalter

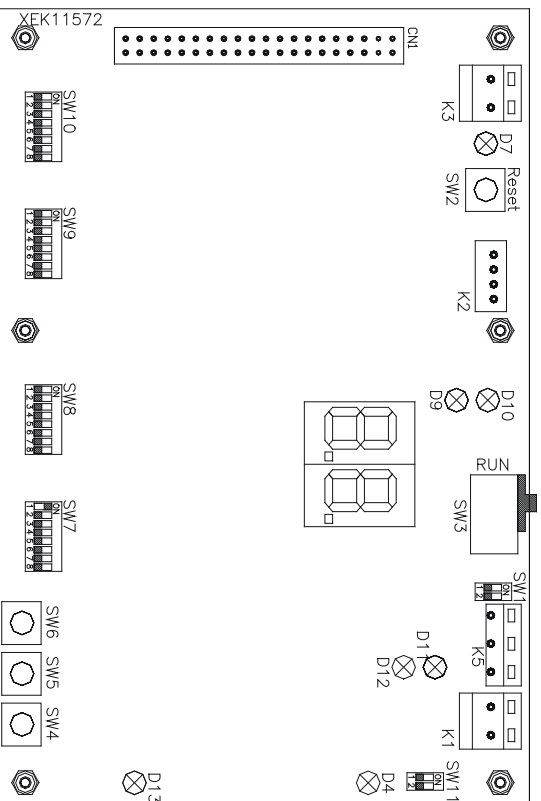

Name	Funktion	Werkseitige Einstellung	Beschreibung
SW1	Nicht verfügbar	ON 1 2	Alle auf Aus (ohne Funktion)
SW2	Reset	-	Resetaste. Drücken, wenn das Programm nicht mehr reagiert
SW3 (TELE)	Nicht verfügbar	RUN	Für werkseitige Prüfzwecke. Auf keinen Fall umstellen
SW4	Konfiguration	-	Einstellen der Funktionen
SW5	Konfiguration	-	Einstellen der Funktionen
SW6	Konfiguration	-	Einstellen der Funktionen
SW7	Optionen 2	ON 1 2 3 4 5 6 7 8	SW7-1: OFF-SLAWE / ON-MASTER. Zur Verwendung bei mehreren HARC-MODBUS an derselben H-LINK-Adresse SW7-2: OFF-EVENT CONTROL/ON-CHANGE CONTROL SW7-3: OFF - Parität deaktiviert / ON - Parität aktiviert SW7-4: OFF - Gerade Parität / ON - Ungerade Parität SW7-5: OFF - 19200 Byte/s / ON - 9600 Byte/s SW7-(6~8): Nicht verwendet
SW8	Optionen 1 (Anwendungsart)	ON 1 2 3 4 5 6 7 8	SW8-1: OFF-PACKAGED / ON-CHILLER. Einzustellen gemäß Geräteanwendung SW8-2~8: Nicht verwendet
SW9	Nicht verfügbar	ON 1 2 3 4 5 6 7 8	Alle auf Aus (ohne Funktion)
SW10	HARC MODBUS Adresse	ON 1 2 3 4 5 6 7 8	HARC-MODBUS Adresse von 1 bis 32 über Pins 1 bis 5
SW11	H-LINK DSW	ON 1 2	2-Pin-DSW SW11-1: H-LINK-Endwiderstand SW11-2: H-LINK-Sicherungsschutz
D4, D11	H-LINK	-	H-LINK-Übertragung
D7	Leistung	-	Stromversorgung ON/OFF
D9/D10	Nicht verwendet	-	-
D12	MODBUS	-	Modbus-Kommunikation in RS485
D13	Betrieb	-	Normaler Softwarebetrieb

■ SW7 – EINSTELLUNG DER FUNKTIONEN 1

SW7	Beschreibung
<p>Konfiguration als MASTER/SLAVE:</p> <p>MASTER: SW7-1=ON Nur ein HARC-MODBUS kann als MASTER HARC-MODBUS eingestellt werden Standardmäßige Einstellung</p> <p>SLAVE: SW7-1= OFF 1 HARC-MODBUS sollte als MASTER konfiguriert werden, alle übrigen HARC-MODBUS müssen in dem selben H-LINK als SLAVE konfiguriert werden</p> <p>Datenaktualisierungsmodus</p> <p>Konfiguration als EVENT CONTROL: SW7-2:OFF Parameter werden für IG jedesmal aktualisiert, wenn BMS einen Einstellparameter schreibt (selbst wenn kein Wert geändert wurde). Standardmäßige Einstellung</p> <p>Konfiguration als CHANGE CONTROL: SW7-2:ON Parameter werden für IG nur dann aktualisiert, wenn Werte geändert werden</p>	
<p>Konfiguration der Parität</p> <p>SW7-3: OFF (AUS): Konfiguration von keine Parität</p> <p>SW7-3: ON (EIN): Paritätskommunikation (siehe Konfiguration von SW7-4 für den Paritätstyp)</p> <p>Konfiguration des Paritätstyps</p> <p>SW7-4: OFF (AUS): Gerade Parität (wenn SW7-3 auf ON steht) SW7-4: ON (EIN): Ungerade Parität (wenn SW7-3 auf ON steht)</p>	
<p>Baudrate der Kommunikation</p> <p>SW7-5: OFF 19200 Byte/s SW7-5: ON 9600 Byte/s</p>	

■ SW8 – EINSTELLUNG DER FUNKTIONEN 2

SW8	Beschreibung
<p>Konfiguration für PACKAGED / CHILLER</p> <p>PACKAGED Anwendungen: SW8-1: OFF CHILLER Anwendungen: SW8-1: ON</p>	

■ SW10 – HARC-Adresse H-LINK (dasselbe Konzept wie bei AG/Kühnkreislauf-Adresse)

SW10				Beschreibung
Adresse: 1 ON <input type="checkbox"/> <input type="checkbox"/> <input type="checkbox"/> <input type="checkbox"/> <input type="checkbox"/> <input type="checkbox"/> <input type="checkbox"/> <input type="checkbox"/> 1 2 3 4 5 6 7 8	Adresse: 2 ON <input type="checkbox"/> <input type="checkbox"/> <input type="checkbox"/> <input type="checkbox"/> <input type="checkbox"/> <input type="checkbox"/> <input type="checkbox"/> <input type="checkbox"/> 1 2 3 4 5 6 7 8	Adresse: 3 ON <input type="checkbox"/> <input type="checkbox"/> <input type="checkbox"/> <input type="checkbox"/> <input type="checkbox"/> <input type="checkbox"/> <input type="checkbox"/> <input type="checkbox"/> 1 2 3 4 5 6 7 8	Adresse: 4 ON <input type="checkbox"/> <input type="checkbox"/> <input type="checkbox"/> <input type="checkbox"/> <input type="checkbox"/> <input type="checkbox"/> <input type="checkbox"/> <input type="checkbox"/> 1 2 3 4 5 6 7 8	<p>Konfiguration der HARC-Adresse</p> <p>HARC-MODBUS-Adresse, die das MODBUS-System verwendet</p> <p>SW10-Pins 1~5 müssen gemäß der entsprechenden Zeichnung der gewünschten Adresse eingestellt werden</p> <p>SW10-Pins 6~8 müssen auf OFF gestellt bleiben</p>
Adresse: 5 ON <input type="checkbox"/> <input type="checkbox"/> <input type="checkbox"/> <input type="checkbox"/> <input type="checkbox"/> <input type="checkbox"/> <input type="checkbox"/> <input type="checkbox"/> 1 2 3 4 5 6 7 8	Adresse: 6 ON <input type="checkbox"/> <input type="checkbox"/> <input type="checkbox"/> <input type="checkbox"/> <input type="checkbox"/> <input type="checkbox"/> <input type="checkbox"/> <input type="checkbox"/> 1 2 3 4 5 6 7 8	Adresse: 7 ON <input type="checkbox"/> <input type="checkbox"/> <input type="checkbox"/> <input type="checkbox"/> <input type="checkbox"/> <input type="checkbox"/> <input type="checkbox"/> <input type="checkbox"/> 1 2 3 4 5 6 7 8	Adresse: 8 ON <input type="checkbox"/> <input type="checkbox"/> <input type="checkbox"/> <input type="checkbox"/> <input type="checkbox"/> <input type="checkbox"/> <input type="checkbox"/> <input type="checkbox"/> 1 2 3 4 5 6 7 8	
Adresse: 9 ON <input type="checkbox"/> <input type="checkbox"/> <input type="checkbox"/> <input type="checkbox"/> <input type="checkbox"/> <input type="checkbox"/> <input type="checkbox"/> <input type="checkbox"/> 1 2 3 4 5 6 7 8	Adresse: 10 ON <input type="checkbox"/> <input type="checkbox"/> <input type="checkbox"/> <input type="checkbox"/> <input type="checkbox"/> <input type="checkbox"/> <input type="checkbox"/> <input type="checkbox"/> 1 2 3 4 5 6 7 8	Adresse: 11 ON <input type="checkbox"/> <input type="checkbox"/> <input type="checkbox"/> <input type="checkbox"/> <input type="checkbox"/> <input type="checkbox"/> <input type="checkbox"/> <input type="checkbox"/> 1 2 3 4 5 6 7 8	Adresse: 12 ON <input type="checkbox"/> <input type="checkbox"/> <input type="checkbox"/> <input type="checkbox"/> <input type="checkbox"/> <input type="checkbox"/> <input type="checkbox"/> <input type="checkbox"/> 1 2 3 4 5 6 7 8	
Adresse: 13 ON <input type="checkbox"/> <input type="checkbox"/> <input type="checkbox"/> <input type="checkbox"/> <input type="checkbox"/> <input type="checkbox"/> <input type="checkbox"/> <input type="checkbox"/> 1 2 3 4 5 6 7 8	Adresse: 14 ON <input type="checkbox"/> <input type="checkbox"/> <input type="checkbox"/> <input type="checkbox"/> <input type="checkbox"/> <input type="checkbox"/> <input type="checkbox"/> <input type="checkbox"/> 1 2 3 4 5 6 7 8	Adresse: 15 ON <input type="checkbox"/> <input type="checkbox"/> <input type="checkbox"/> <input type="checkbox"/> <input type="checkbox"/> <input type="checkbox"/> <input type="checkbox"/> <input type="checkbox"/> 1 2 3 4 5 6 7 8	Adresse: 16 ON <input type="checkbox"/> <input type="checkbox"/> <input type="checkbox"/> <input type="checkbox"/> <input type="checkbox"/> <input type="checkbox"/> <input type="checkbox"/> <input type="checkbox"/> 1 2 3 4 5 6 7 8	
Adresse: 17 ON <input type="checkbox"/> <input type="checkbox"/> <input type="checkbox"/> <input type="checkbox"/> <input type="checkbox"/> <input type="checkbox"/> <input type="checkbox"/> <input type="checkbox"/> 1 2 3 4 5 6 7 8	Adresse: 18 ON <input type="checkbox"/> <input type="checkbox"/> <input type="checkbox"/> <input type="checkbox"/> <input type="checkbox"/> <input type="checkbox"/> <input type="checkbox"/> <input type="checkbox"/> 1 2 3 4 5 6 7 8	Adresse: 19 ON <input type="checkbox"/> <input type="checkbox"/> <input type="checkbox"/> <input type="checkbox"/> <input type="checkbox"/> <input type="checkbox"/> <input type="checkbox"/> <input type="checkbox"/> 1 2 3 4 5 6 7 8	Adresse: 20 ON <input type="checkbox"/> <input type="checkbox"/> <input type="checkbox"/> <input type="checkbox"/> <input type="checkbox"/> <input type="checkbox"/> <input type="checkbox"/> <input type="checkbox"/> 1 2 3 4 5 6 7 8	
Adresse: 21 ON <input type="checkbox"/> <input type="checkbox"/> <input type="checkbox"/> <input type="checkbox"/> <input type="checkbox"/> <input type="checkbox"/> <input type="checkbox"/> <input type="checkbox"/> 1 2 3 4 5 6 7 8	Adresse: 22 ON <input type="checkbox"/> <input type="checkbox"/> <input type="checkbox"/> <input type="checkbox"/> <input type="checkbox"/> <input type="checkbox"/> <input type="checkbox"/> <input type="checkbox"/> 1 2 3 4 5 6 7 8	Adresse: 23 ON <input type="checkbox"/> <input type="checkbox"/> <input type="checkbox"/> <input type="checkbox"/> <input type="checkbox"/> <input type="checkbox"/> <input type="checkbox"/> <input type="checkbox"/> 1 2 3 4 5 6 7 8	Adresse: 24 ON <input type="checkbox"/> <input type="checkbox"/> <input type="checkbox"/> <input type="checkbox"/> <input type="checkbox"/> <input type="checkbox"/> <input type="checkbox"/> <input type="checkbox"/> 1 2 3 4 5 6 7 8	
Adresse: 25 ON <input type="checkbox"/> <input type="checkbox"/> <input type="checkbox"/> <input type="checkbox"/> <input type="checkbox"/> <input type="checkbox"/> <input type="checkbox"/> <input type="checkbox"/> 1 2 3 4 5 6 7 8	Adresse: 26 ON <input type="checkbox"/> <input type="checkbox"/> <input type="checkbox"/> <input type="checkbox"/> <input type="checkbox"/> <input type="checkbox"/> <input type="checkbox"/> <input type="checkbox"/> 1 2 3 4 5 6 7 8	Adresse: 27 ON <input type="checkbox"/> <input type="checkbox"/> <input type="checkbox"/> <input type="checkbox"/> <input type="checkbox"/> <input type="checkbox"/> <input type="checkbox"/> <input type="checkbox"/> 1 2 3 4 5 6 7 8	Adresse: 28 ON <input type="checkbox"/> <input type="checkbox"/> <input type="checkbox"/> <input type="checkbox"/> <input type="checkbox"/> <input type="checkbox"/> <input type="checkbox"/> <input type="checkbox"/> 1 2 3 4 5 6 7 8	
Adresse: 29 ON <input type="checkbox"/> <input type="checkbox"/> <input type="checkbox"/> <input type="checkbox"/> <input type="checkbox"/> <input type="checkbox"/> <input type="checkbox"/> <input type="checkbox"/> 1 2 3 4 5 6 7 8	Adresse: 30 ON <input type="checkbox"/> <input type="checkbox"/> <input type="checkbox"/> <input type="checkbox"/> <input type="checkbox"/> <input type="checkbox"/> <input type="checkbox"/> <input type="checkbox"/> 1 2 3 4 5 6 7 8	Adresse: 31 ON <input type="checkbox"/> <input type="checkbox"/> <input type="checkbox"/> <input type="checkbox"/> <input type="checkbox"/> <input type="checkbox"/> <input type="checkbox"/> <input type="checkbox"/> 1 2 3 4 5 6 7 8	Adresse: 32 ON <input type="checkbox"/> <input type="checkbox"/> <input type="checkbox"/> <input type="checkbox"/> <input type="checkbox"/> <input type="checkbox"/> <input type="checkbox"/> <input type="checkbox"/> 1 2 3 4 5 6 7 8	

■ Beispiel

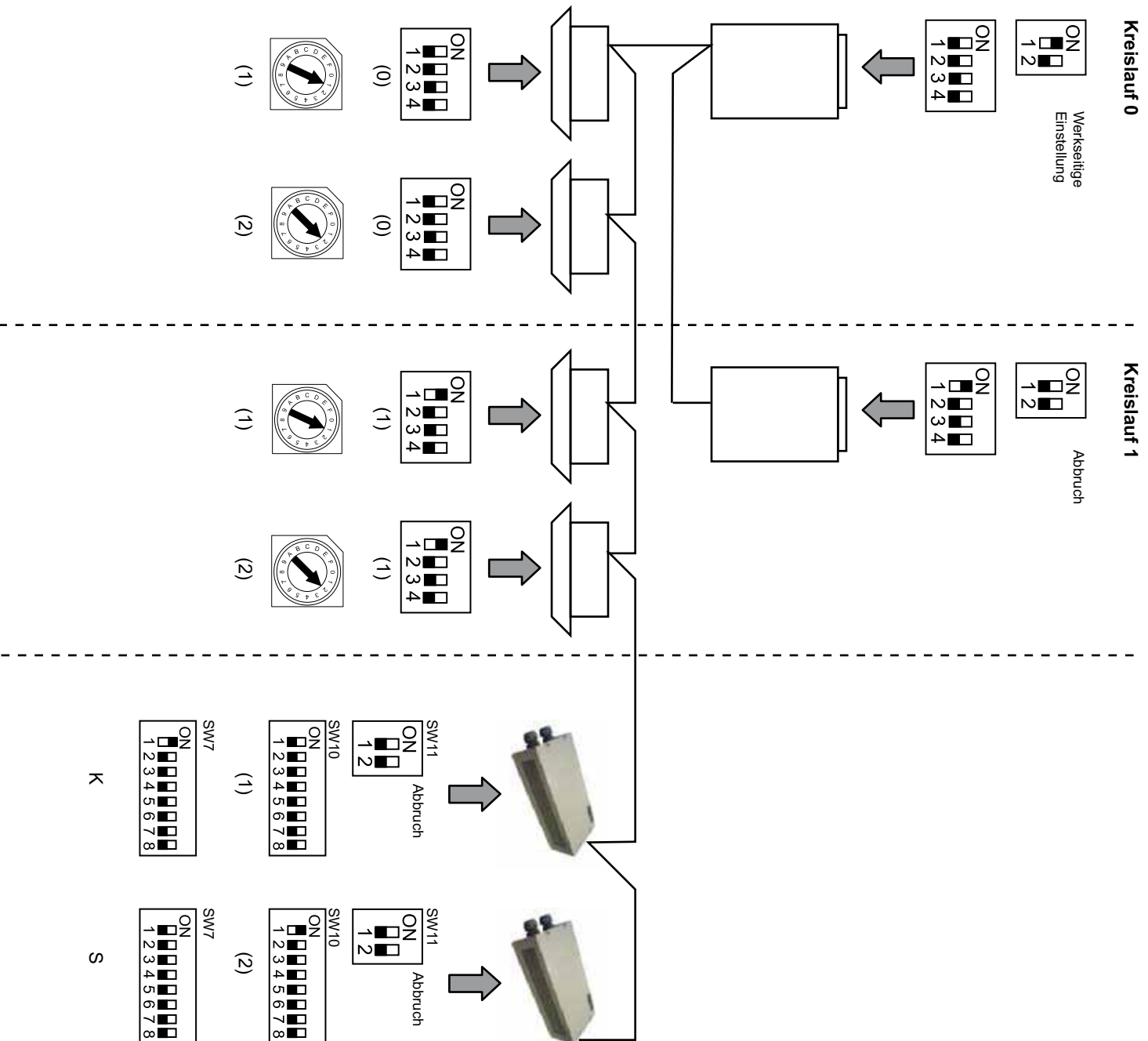

6. Betrieb

6.1 PACKAGED: Daten verfügbar

Adresse (Hinweis 1)	Name	Beschreibung	Lesen/Schreiben
0	EXIST	EXIST: 0: Nicht existieren 1: Existieren	Lesen
1	SYSTEM_ADDRESS	Systemadresse: 0 ~ 15 in H-LINK 1	Lesen
2	UNIT_ADDRESS	Geräteadresse: 0 ~ 15 in H-LINK1	Lesen
3	SET_ONOFF	Ein/Aus-Einstellbefehl: 0: Stopp 1: In Betrieb	Lesen/Schreiben
4	SET_MODE	Modus Einstellbefehl: 0: Kühlen 2: Lüfter 3: Heizen 4: Auto	Lesen/Schreiben
5	SET_FAN	Lüftereinstellbefehl: 0: Langsam 2: Schnell 1: Mittel	Lesen/Schreiben
6	SET_TSET	Temperaturreinstellung: 17 °C ~ 30 °C	Lesen/Schreiben
7	SET_LOUVER	Luftklappenreinstellung: 0 ~ 8 (8 ist Auto)	Lesen/Schreiben
8	SET_CENTRAL	Zentraleinstellung Bit 0: Ein/Aus (kann jederzeit gestoppt werden) Bit 1: Betriebsart Bit 2: Temperaturreinstellung Bit 3: Lüfter	Lesen/Schreiben
9	READ_ONOFF	Ein/Aus Lesen: 0: Aus 1: Ein	Lesen
10	READ_MODE	Modus Lesen 0: Kühlen 2: Lüfter 3: Heizen 4: Auto	Lesen
11	READ_FAN	Lüfter Lesen 0: Langsam 2: Schnell 1: Mittel	Lesen
12	READ_TSET	Temperaturreinstellung Lesen (17 °C bis 30 °C)	Lesen
13	READ_LOUVER	Luftklappe Lesen 0 ~ 8 (8 ist Auto)	Lesen
14~18	(nicht verwendet)	(nicht verwendet)	(nicht verwendet)
19	ERROR_CODE	Alarmcode	Lesen
20~21	(nicht verwendet)	(nicht verwendet)	(nicht verwendet)
22	OPER_CONDITION	Gerätebetriebszustand 0: OFF 2: Thermo ON 1: Thermo OFF 3: Alarm	Lesen
23~31	(nicht verwendet)	(nicht verwendet)	(nicht verwendet)

Hinweis 1: Die Offset-Position ist: 20000 + N*32 + Adresse gemäß Tabelle, wobei N die Innengeräteadresse ist.

■ Konfigurationsverfahren

Jeder HARC-MODBUS kann bis zu 32 IG steuern. Da am selben H-LINK bis zu 128 IG angeschlossen werden können, muss eingestellt werden, welche Innengeräte für jeden HARC-MODBUS ausgewählt werden.

Diese Konfiguration ist im Falle einer CHILLER-Anwendung nicht erforderlich.

Das Einstellungskonzept besteht aus einer „ID“-Tabelle mit bis zu 32 Nummern für die Zuweisung der einzelnen AG+IG-Adressen, was wie folgt aussieht:

ID	Kühlkreislaufadresse	Innengeräteadresse
00	00	00
01	00	01
02	00	02
03	00	03
04	00	04
05	00	05
06	00	06
07	00	07
08	00	08
09	00	09
10	00	10
11	00	11
12	00	12
13	00	13
14	00	14
15	00	15

ID	Kühlkreislaufadresse	Innengeräteadresse
16	01	00
17	01	01
18	01	02
19	01	03
20	01	04
21	01	05
22	01	06
23	01	07
24	01	08
25	01	09
26	01	10
27	01	11
28	01	12
29	01	13
30	01	14
31	01	15



Hinweis:

- Für 1 HARC-MODBUS können bis zu 32 IG von 16 verschiedenen Kühlkreisläufen oder 32 IG von demselben Kühlkreislauf ausgewählt werden.



Vorsicht:

- Schließen Sie ein Innengerät nicht an mehr als einen HARC-MODBUS an. Dieser Fehler ist nicht erkennbar und kann zu unerwünschten Arbeitsgängen führen.

Nr.	Verfahrensschritt	7 Segmente (Anzeige)	Bemerkungen
1	SW4 für 3 Sekunden drücken	10	Konfigurationsmodus ausgewählt
2	Drücken Sie SW4	00	ID-Auswahl (G-Nr.) von 0 bis 31 durch Drücken von SW5 ▲ oder SW6 ▼
3	Drücken Sie SW4	all	Kühlkreislaufadresse
4	Drücken Sie SW4	--->00	Auswahl der Kühlkreislaufadresse von 0 bis 15 (z. B. 00) (durch Drücken von SW5 ▲ & SW6 ▼)
5	Drücken Sie SW4	11	Innengeräteadresse
6	Drücken Sie SW4	--->00	Auswahl der Innengeräteadresse von 0 bis 15 (z. B. 00) (durch Drücken von SW5 ▲ & SW6 ▼)
Wiederholen Sie für „ID“ 01 die Schritte 1 bis 6			
7	SW4 für 3 Sekunden drücken	10	Konfigurationsmodus ausgewählt
8	Drücken Sie SW4	00->01	ID-Auswahl (G-Nr.) von 0 bis 31 durch Drücken von SW5 ▲ oder SW6 ▼
9	Drücken Sie SW4	all	Kühlkreislaufadresse
10	Drücken Sie SW4	--->00	Auswahl der Kühlkreislaufadresse von 0 bis 15 (z. B. 00) (durch Drücken von SW5 ▲ & SW6 ▼)
11	Drücken Sie SW4	11	Innengeräteadresse
12	Drücken Sie SW4	--->01	Auswahl der Innengeräteadresse von 0 bis 15 (z. B. 01; drücken Sie einmal auf SW5) (durch Drücken von SW5 ▲ & SW6 ▼)
... Wiederholen Sie die Schritte 1 bis 6 für alle verbleibenden „IDs“			
187	SW4 für 3 Sekunden drücken	10	Konfigurationsmodus ausgewählt
188	Drücken Sie SW4	00->31	ID-Auswahl (G-Nr.) von 0 bis 31 durch Drücken von SW5 ▲ oder SW6 ▼
189	Drücken Sie SW4	all	Kühlkreislaufadresse
190	Drücken Sie SW4	--->01	Auswahl der Kühlkreislaufadresse von 0 bis 15 (z. B. 01; drücken Sie einmal auf SW5) (durch Drücken von SW5 ▲ & SW6 ▼)
191	Drücken Sie SW4	11	Innengeräteadresse
192	Drücken Sie SW4	--->15	Auswahl der Innengeräteadresse von 0 bis 15 (z. B. 15; drücken Sie einmal auf SW6) (durch Drücken von SW5 ▲ & SW6 ▼)

6.2 CHILLER: Daten verfügbar

Adresse	Name	Beschreibung	Werte	Lesen/ Schreiben
0	EXIST	Existieren	0: Nicht existieren 1: Existieren	Lesen
1	SYSTEM_ADDRESS	Chiller-Adresse	0~ 15 in H-LINK 1	Lesen
2	(nicht verwendet)	(nicht verwendet)	(nicht verwendet)	(nicht verwendet)
3	ONOFF_SET	Ein/Aus-Einstellbefehl:	0: Stopp 1: In Betrieb	Lesen/ Schreiben
4	MODE_SET	Modus Einstellbefehl	0: Kühlen 1: Heizen	Lesen/ Schreiben
5	TEMP_SET_C	TemperaturEinstellung COOL	(siehe Hinweis *)	Lesen/ Schreiben
6	TEMP_SET_H	TemperaturEinstellung HEAT		Lesen/ Schreiben
7	CENTRAL_SET	ZentralEinstellung	0: Intern 1: Fernbedienung	Lesen/ Schreiben
8	ONOFF_STATUS	ON/OFF-Status	0: Aus 1: Ein	Lesen
9	MODE_STATUS	Modusstatus	0: Kühlen 1: Heizen	Lesen
10	TEMP_C_STATUS	Temperaturstatus COOL		Lesen
11	TEMP_H_STATUS	Temperaturstatus HEAT		Lesen
12	WATER_INLET	Einlasstemperatur		Lesen
13	WATER_OUTLET	Auslasstemperatur		Lesen
14	AMBIENT_TEMPERATURE	Umgebungstemperatur		Lesen
15	OPER_CONDITION	Gerätebetriebszustand	0: OFF 1: Thermo OFF 2: Thermo ON 3: Alarm	Lesen
16	ERROR_CODE_CH	Alarmcode für allgemeinen CHILLER-Alarm		Lesen
17~22	ERROR_CODE_CVC	Alarmcode für Kreislaufalarm (1~6)		Lesen
23~31	(nicht verwendet)	(nicht verwendet)	(nicht verwendet)	(nicht verwendet)

**Hinweise:**

- Die Offset-Position ist: 40000 + N*32 + Adresse gemäß Tabelle, wobei N die Wasserkühleradresse ist.
- Die Parameter für Status (realer Wert) und Set (angeforderter Wert) besitzen in der Regel denselben Wert, in bestimmten Fällen können jedoch einige Werte unterschiedlich sein. Es empfiehlt sich, für die normale Steuerung Set-Parameter zu verwenden.
- *) Wenn die Temperatureinstellung und der Betriebsmodus gleichzeitig verändert werden sollen, ändern Sie zuerst den Betriebsmodus und stellen Sie später die entsprechende Temperatur ein.

6.3 Alarmcodeliste für CHILLER

6.3.1 CHILLER - Alarmcodeliste

CHILLER-Alarm		Beschreibung	H-LINK
7SEG1	7SEG2		Code
11	11	Fehler bei Thermistor für Wassereinlassstemperatur	20
12	12	Fehler bei Wassertemperaturthermistor (Nur bei 1-Kreislauf-Gerät)	21
22	22	Fehler bei Thermistor Umgebungstemperatur (offen/kurz)	24
5P	5P	Kein Rückmeldungssignal von Wasserpumpe	26
13	13	Frostschutzsteuerung aktiviert (nur bei 1-Kreislauf-Gerät)	27
6C	6C	Alarmanzeige für ungenügende Wassermenge (Option Differenzdruckschalter oder Durchflussschalter) im Kondensator	28
6E	6E	Alarmanzeige für ungenügende Wassermenge (Option Differenzdruckschalter oder Durchflussschalter) im Verdampfer	29
14	14	Aktivierung des Thermostats für extrem hohe Wassertemperatur (Nur bei 1-Kreislauf-Geräten)	30
RP	RP	Aktivierung der zusätzlichen Schutzvorrichtung	31
05	05	Phasenfehler	32
CP	CP	Kommunikationsfehler zwischen Steuer-PCB (PCB _{g1} , PCB _{g2})	33
03	03	Kommunikationsfehler zwischen Kältekompressor und Fernbedienung (H-LINK)	34
EU	EU	Kommunikationsfehler zwischen Expansionsventil-PCB und Steuer-PCB	36
40	40	Fehlerhafter Betrieb	40-45, 47,47,54

6.3.2 Liste der Kreilaufalarmcodes

Kreislufalarm		Beschreibung	H-LINK
7SEG1	7SEG2		Code
L _n	H _n	Aktivierung des Hochdruckschalters	1
L _n	L _n	Aktivierung der Niederdrucksteuerung	2
L _n	n _n	Aktivierung des kompressorinternen Thermostats	3
L _n	B _n	Aktivierung des Abgasthermistors	4
L _n	S _n	Aktivierung des Thermorelais für Kompressor oder Störung des Hilfsrelais ARm	5
L _n	F0	Falsche Einstellung der Lüfternummer	6
L _n	4 _n	Aktivierung des internen Lüftermotorthermostats	7
L _n	L _n	Extrem niedriger Druck	8
L _n	9 _n	Übermäßig niedrige Temperatur des Einlasskältemittels des Kühlers	10
L _n	2 _n	Fehler bei Abgasdruck-Sensor (offen/kurz)	11
L _n	2 _B	Fehler bei Sauggasdruck-Sensor (offen/kurz)	12
L _n	1 ₂	Fehler bei Wassertemperaturthermistor (bei Nicht-1-Kreislauf-Gerät)	14
L _n	2 ₃	Fehler bei Abgasthermistor (offen/kurz)	15
L _n	2 ₆	Fehler bei Thermistor Sauggas (offen/kurz)	16
L _n	0 ₅	Phasenfehler	17
L _n	2 ₁	Fehler bei Kühlwasser-Einlassthermistor (offen/kurz)	19
L _n	b _n	Aktivierung des Sauggasthermistors	20
L _n	1 ₃	Frostschutzsteuerung aktiviert (für Nicht-1-Kreislauf-Gerät)	21
L _n	2 ₄	Fehler bei Thermistor-Einstellung vor Expansionsventil (offen/ kurz)	23
L _n	2 ₅	Fehler bei Wasserauslass-Thermistor - Kühlerückseite (offen/kurz)	24
F _n	5 ₁	Störung bei Inverter-Stromversorgung	34

7. Fehlerbehebung

Nr.	Alarmcode	Beschreibung	Gegenmassnahme
1	EE → B 1	Die Innengeräte haben seit über 10 Minuten nicht mehr mit HARC-MODBUS kommuniziert	<ol style="list-style-type: none"> 1. Prüfen Sie, ob die H-LINK-Verbindung bei HARC (K1) und den Innengeräten korrekt hergestellt ist. 2. Stellen Sie sicher, dass die Stromversorgung der Klimaanlage funktioniert.
2	EE → B 3	Innengeräte haben nie mit HARC-MODBUS kommuniziert	<ol style="list-style-type: none"> 1. Prüfen Sie, ob die H-LINK-Verbindung bei HARC (K1) und den Innengeräten korrekt hergestellt ist. 2. Stellen Sie sicher, dass die Stromversorgung der Klimaanlage funktioniert.
3	D7 ist immer auf OFF	Kein LED blinkt an der PCB und 7 Segmente sind OFF	<ol style="list-style-type: none"> 1. Stellen Sie sicher, dass die Stromquelle 230 erhält. 2. Stellen Sie sicher, dass K3 +5V DC erhält. <p> Hinweise:</p> <ul style="list-style-type: none"> - Das Ausgangssignal der DC-Stromversorgung muss mit dem Drehschalter +5V DC eingestellt werden. - D7 muss auf ON eingestellt sein.
4	D12 blinkt nie	HARC-MODBUS liest/sendet keine Daten (D12 blinkt nie)	<ol style="list-style-type: none"> 1. Prüfen Sie die Verbindung zwischen MODBUS-Geräten und K5.
5	D12 blinkt nicht	HARC arbeitet nicht (D13 blinkt nicht)	<ol style="list-style-type: none"> 1. Prüfen Sie, ob SW3 in Position RUN ist. Wenn nicht, stellen Sie RUN ein und drücken Sie auf Reset.
6	D4 & D11 blinken nicht	Keine H-LINK-Kommunikation vom HARC-MODBUS	<ol style="list-style-type: none"> 1. D4 blinkt, aber D11 blinkt nicht. → Siehe Zeile 6, Gegenmassnahme 1. 2. Weder D4 noch D11 blinkt. → Siehe Zeile 3, Gegenmassnahme 1.

Sommaire

1.	Sommaire des dispositifs de sécurité	52
2.	Nom des composants	52
3.	Caractéristiques	53
4.	Travaux d'installation	54
4.1	Dimensions	54
4.2	Fixation	54
5.	Connexions des câbles électriques	55
5.1	Câblage électrique	55
5.2	Réglage du commutateur DIP	56
6.	Fonctionnement	60
6.1	PACKAGED : Données disponibles	60
6.2	CHILLER : Données disponibles	63
6.3	Liste des codes d'alarme pour CHILLER	64
6.3.1	Liste des codes des alarmes du CHILLER	64
6.3.2	Liste des codes des alarmes du cycle	65
7.	Dépannage	66

**Remarque :**

Ce manuel fournit l'information de base nécessaire pour l'installation et le câblage de HARC-MODBUS.

1. Sommaire des dispositifs de sécurité



Attention:

Ne connectez pas la tension d'alimentation au système de commande avant d'avoir terminé correctement l'installation.

Veillez lire ce manuel soigneusement avant de réaliser les travaux d'installation.

Lisez ce manuel pour configurer le HARC-MODBUS.



Attention:

Installez HARC-MODBUS à l'écart de sources possibles d'ondes électromagnétiques.

Respectez les normes électriques locales.

Utilisez un circuit d'alimentation qui ne soit pas sujet à des demandes de pointe.

Assurez-vous qu'il y a suffisamment de place autour de HARC-MODBUS (voir figure) pour permettre la dissipation correcte de la chaleur (reportez-vous aux « Travaux d'installation »).

En cas d'installation du HARC-MODBUS en position verticale, installez l'alimentation dans la partie inférieure.

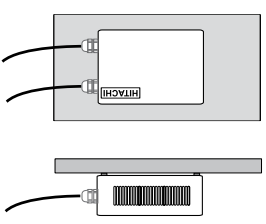

Attention:

N'installez jamais le HARC-MODBUS... :

- en présence de vapeur, d'huile ou de liquides répandus.
- près de sources de chaleur (milieux sulphuriques).
- là où ont été détectées une accumulation, une génération ou des fuites de gaz inflammables.
- à des endroits qui sont près de la mer, dans des milieux salins, acides ou alcalins.

2. Nom des composants

Le schéma indique les noms des composants de HARC-MODBUS.

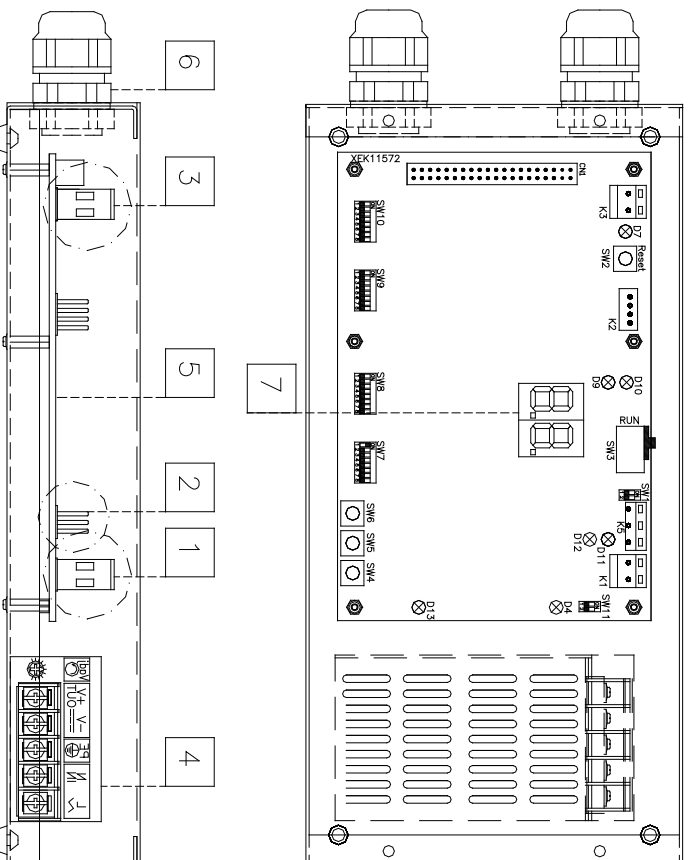

- 1 K1 : Connecteur H-LINK :
Connecté au CSNET WEB
- 2 K5 : Port série RS485
- 3 K3 : Connecteur
d'alimentation +5 V DC
- 4 Alimentation : 230 V c.a. / 5 V c.c.
- 5 PCB H-LINK
- 6 Foudroirs (2)
- 7 segments

3. Caractéristiques

Caractéristiques du hardware

Élément	Caractéristiques
Alimentation	1~230 V \pm 10% 50 Hz
Consommation	25 W (maximum)
Dimensions extérieures	Largeur : 143 mm, Profondeur : 302 mm, Hauteur : 76 mm
Poids	1,75 kg
Conditions d'assemblage	À l'intérieur (dans un panneau de commandes ou un ordinateur de bureau)
Température ambiante	0~40 °C
Humidité	20~85% (Sans condensation)

MODBUS - Communication avec le système supérieur

Élément	Caractéristiques
K5	Port série RS485 (connecteur 3 broches) - Protocole MODBUS
Ligne de communication	Câble à paire torsadée. Polarité
Système de communication	Connection en série multipoints et semi-duplex
Méthode de communication	Pas de parité ou sélection parité paire/impaire. Longueur des données : 8 bits (voir chapitre 5)
Transmission débit en bauds	19200/9600 bauds (voir chapitre 5)
Longueur	max. 1200 m conformément à EIA-485

H-LINK - Communication avec les unités

Élément	Caractéristiques
Communication avec	HITACHI PACKAGED/CHILLER
Ligne de communication	Câble blindé à paire torsadée, pas de polarité
Système de communication	Semi-duplex
Méthode de communication	Asynchrone
Vitesse de transmission	9600 Bauds
Longueur du câblage	1000 m maximum (longueur totale du bus HLINK I/O)
Nombre maximum de HARC MODBUS	8 HARC-MODBUS/H-LINK SYSTEM (PACKAGED) 1 HARC-MODBUS/H-LINK SYSTEM (CHILLER)



Attention :

Pour le fonctionnement d'unités intérieures avec HARC-MODBUS, une télécommande au moins est nécessaire.

4. Travaux d'installation

Lors de son déballage, vérifiez que le HARC-MODBUS n'a souffert aucun dommage au cours du transport.

4.1 Dimensions

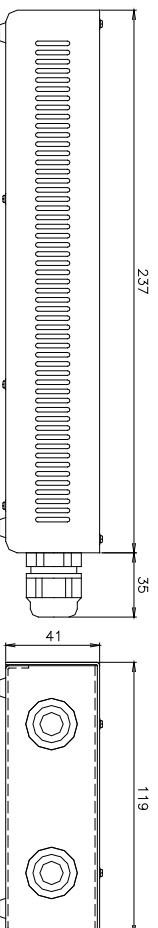

4.2 Fixation

Réalisez la procédure suivante :

- 1 Retirez les supports en caoutchouc.
- 2 Dévissez les 4 vis du panneau supérieur et enlevez-le.
- 3 Depuis son intérieur, fixez le boîtier à la plaque verticale arrière au moyen de vis M4 (non fournies), et placez des rondelles de 3 mm à l'extérieur pour séparer le boîtier du mur.
- 4 Réinstallez le panneau supérieur. Veillez à bien le positionner.
- 5 Veiller à ce que la zone à grille reste libre pour la ventilation et la connection du câble.

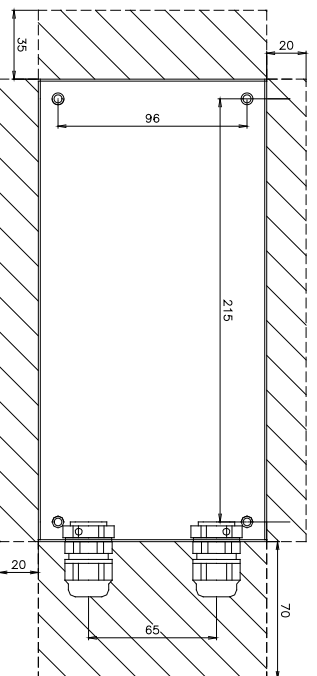

⚠ Attention :

- Avant de mettre le HARC-MODBUS sous alimentation et de le démarre, vous devez vérifier que :
 1. Tous les circuits à connecter ont été appliqués correctement.
 2. Toutes les connexions H-Link ont été configurées.
 3. Respectez les réglagements locaux pour l'installation électrique du HARC-MODBUS et les circuits associés.
- Les unités qui ne sont pas connectées ou qui ne se trouvent pas sous tension lors du démarrage du HARC-MODBUS ne seront pas identifiées et devront être configurées à posteriori.

⚠ Attention :

- Les câbles des signaux doivent être aussi courts que possible. Maintenez-les éloignés d'autres câbles d'alimentation d'au moins 150 mm. Ne les attachez pas ensemble (mais ils peuvent se croiser). S'il est nécessaire de les installer ensemble, adoptez les mesures suivantes pour éviter les bruits électriques :
 - Protégez le câble de signal par un tube en métal dont une extrémité est reliée à la terre.
 - Pour les communications, utilisez du câble blindé dont une extrémité est reliée à la terre.

⚠ Danger :

- Débranchez toujours l'alimentation électrique du HARC-MODBUS lorsque vous manipulez la machine, afin d'éviter les décharges électriques.
- Ne connectez l'interface à l'alimentation électrique qu'une fois l'installation terminée.
- Observez rigoureusement les normes et réglagements locaux lorsque vous connectez la machine au réseau électrique.
- Vous aurez besoin d'un câble à trois brins (deux phases et terre) avec une prise adéquate à une extrémité.

5. Connexions des câbles électriques

5.1 Câblage électrique

Pour pouvoir fonctionner, HARC-MODBUS doit être connecté aux signaux d'entrée et de sortie correspondants, aux câbles d'alimentation électrique et au H-LINK.

N°	Connexion	Caractéristiques du câble
1	Circuit d'alimentation 1~ 230 V 50 Hz 25 W (Avec circuit de protection)	Sélectionnez les câbles conformément aux réglementations locales (minimum recommandé 1,5 mm ² type H05RN-F)
2	MODBUS	Faisceau 3 câbles 0,75 mm ² (type H05RN-F). Utilisez une couleur différente pour chaque câble. (Port série RS485)
3	H-LINK	Câbles de communication pour connecter le HARC-MODBUS à une installation Hitachi, via CSNET WEB ou toute autre unité Hitachi qui utilise les mêmes terminaux H-LINK. Câble blindé à paire torsadée de 0,75 mm ² (type H05RN-F). Le câble blindé doit être connecté à la terre d'un seul côté.
4	Alimentation des PCB +5 V c.c. I _{max} = 5 A.c.c.	Câble à paire de 0,75 mm ² (type H05RN-F)



Remarque :

Tous les câbles, sauf 4 sont fournis sur site.

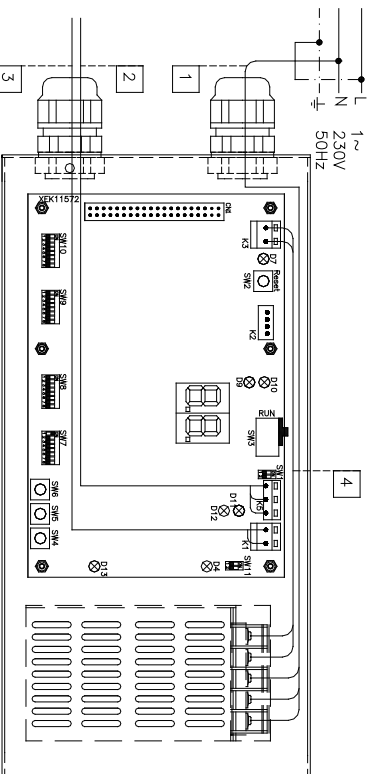

Protections fournies sur site :

CB/EF : 5 A

ELB : 2/40 A/30 mA

CB : Disjoncteur

EF : Fusible

ELB : Disjoncteur de fuite à la terre

5.2 Réglage du commutateur DIP

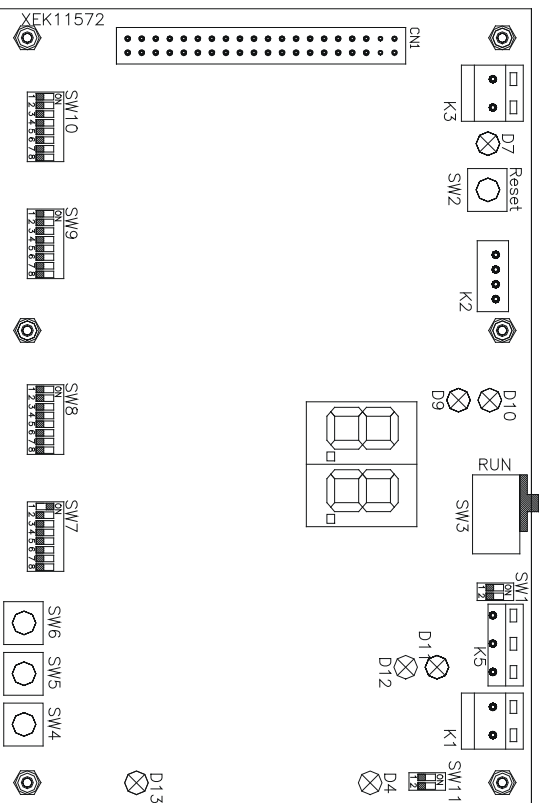

Nom	Fonction	Réglage d'usine	Description
SW1	Non disponible	ON 1 2	Mode off (désactivé)
SW2	Réinitialiser	-	Bouton de réinitialisation. À utiliser en cas de blocage du programme
SW3 (TELE)	Non disponible	RUN	Pour utilisation en usine. À ne jamais modifier
SW4	Configuration	-	Réglage de fonctions
SW5	Configuration	-	Réglage de fonctions
SW6	Configuration	-	Réglage de fonctions
SW7	Options 2	ON 1 2 3 4 5 6 7 8	SW7-1 : OFF-SLAVE / ON-MASTER. À utiliser si plusieurs HARC-MODBUS sont associés à la même adresse H-LINK SW7-2 : OFF-EVENT CONTROL/ON-CHANGE CONTROL SW7-3 : OFF - Parité désactivée / ON - Parité activée SW7-4 : OFF - Parité paire / ON - Parité impaire SW7-5 : OFF - 19200 Bps / ON - 9600 Bps SW7-(6~8) : Non utilisé
SW8	Options 1 (Type d'application)	ON 1 2 3 4 5 6 7 8	SW8-1 : OFF-PACKAGED / ON-CHILLER. À régler selon l'utilisation des unités SW8-2 à 8 : Non utilisé
SW9	Non disponible	ON 1 2 3 4 5 6 7 8	Mode off (désactivé)
SW10	Adresse HARC MODBUS	ON 1 2 3 4 5 6 7 8	Adresse HARC-MODBUS de 1 à 32 par broches 1 à 5
SW11	DSW du H-LINK	ON 1 2	DSW à 2 broches SW11-1 : Résistance d'extrémité H-LINK SW11-2 : Protection des fusibles H-LINK
D4, D11	H-LINK	-	Transmission du H-LINK
D7	Alimentation	-	Alimentation ON/OFF
D9/D10	Non utilisé	-	-
D12	MODBUS	-	Communication Modbus en RS485
D13	Fonctionnement	-	Fonctionnement logiciel normal

■ SW7 – RÉGLAGE DE FONCTIONS 1

SW7	Description
<p>Configuration en tant que MAÎTRE/ESCLAVE :</p> <p>MAÎTRE : SW7-1=ON Seul un HARC-MODBUS peut être configuré en HARC-MODBUS MAÎTRE Réglage par défaut</p> <p>ESCLAVE : SW7-1= OFF Une fois le HARC-MODBUS MAÎTRE configuré, les autres HARC-MODBUS doivent être configurés en tant qu'ESCLAVE dans le même H-LINK</p> <p>Mode rafraîchissement de données</p> <p>Configuration en tant qu'EVENT CONTROL : SW7-2= OFF Les paramètres envoyés aux UI sont mis à jour dès que le BMS écrit un paramètre de réglage (même si aucune valeur n'est modifiée); Réglage par défaut</p> <p>Configuration en tant que CHANGE CONTROL : SW7-2= ON Les paramètres envoyés aux UI sont mis à jour uniquement lorsque les valeurs sont modifiées</p>	
<p>Configuration de la parité</p> <p>SW7-3 : OFF : Pas de configuration de la parité</p> <p>SW7-3 : ON : Communication de la parité (voir configuration SW7-4 pour le type de parité)</p> <p>Configuration type de parité</p> <p>SW7-4 : OFF : Parité paire (si SW7-3 est sur ON)</p> <p>SW7-4 : ON : Parité impaire (si SW7-3 est sur ON)</p>	
<p>Débit de communication en bauds</p> <p>SW7-5 : OFF 19200 Bps</p> <p>SW7-5 : ON 9600 Bps</p>	

■ SW8 – RÉGLAGE DE FONCTIONS 2

SW8	Description
<p>Configuration pour les applications PACKAGED / CHILLER</p> <p>Applications PACKAGED : SW8-1 : OFF</p> <p>Applications CHILLER : SW8-1 : MARCHÉ</p>	

■ SW10 – adresse HARC H-LINK (Même concept que pour l'adresse G.E./Cycle frigorifique)

SW10				Description
Adresse : 1 ON <input type="checkbox"/> <input type="checkbox"/> <input type="checkbox"/> <input type="checkbox"/> <input type="checkbox"/> <input type="checkbox"/> <input type="checkbox"/> <input type="checkbox"/> 1 2 3 4 5 6 7 8	Adresse : 2 ON <input type="checkbox"/> <input type="checkbox"/> <input type="checkbox"/> <input type="checkbox"/> <input type="checkbox"/> <input type="checkbox"/> <input type="checkbox"/> <input type="checkbox"/> 1 2 3 4 5 6 7 8	Adresse : 3 ON <input type="checkbox"/> <input type="checkbox"/> <input type="checkbox"/> <input type="checkbox"/> <input type="checkbox"/> <input type="checkbox"/> <input type="checkbox"/> <input type="checkbox"/> 1 2 3 4 5 6 7 8	Adresse : 4 ON <input type="checkbox"/> <input type="checkbox"/> <input type="checkbox"/> <input type="checkbox"/> <input type="checkbox"/> <input type="checkbox"/> <input type="checkbox"/> <input type="checkbox"/> 1 2 3 4 5 6 7 8	<p>Configuration de l'adresse HARC</p> <p>Adresse HARC-MODBUS utilisée par le système MODBUS</p> <p>Les broches 1 à 5 du SW10 doivent être réglées en fonction du schéma correspondant de l'adresse souhaitée</p> <p>Les broches 6 à 8 du SW10 doivent être réglées sur OFF</p>
Adresse : 5 ON <input type="checkbox"/> <input type="checkbox"/> <input type="checkbox"/> <input type="checkbox"/> <input type="checkbox"/> <input type="checkbox"/> <input type="checkbox"/> <input type="checkbox"/> 1 2 3 4 5 6 7 8	Adresse : 6 ON <input type="checkbox"/> <input type="checkbox"/> <input type="checkbox"/> <input type="checkbox"/> <input type="checkbox"/> <input type="checkbox"/> <input type="checkbox"/> <input type="checkbox"/> 1 2 3 4 5 6 7 8	Adresse : 7 ON <input type="checkbox"/> <input type="checkbox"/> <input type="checkbox"/> <input type="checkbox"/> <input type="checkbox"/> <input type="checkbox"/> <input type="checkbox"/> <input type="checkbox"/> 1 2 3 4 5 6 7 8	Adresse : 8 ON <input type="checkbox"/> <input type="checkbox"/> <input type="checkbox"/> <input type="checkbox"/> <input type="checkbox"/> <input type="checkbox"/> <input type="checkbox"/> <input type="checkbox"/> 1 2 3 4 5 6 7 8	
Adresse : 9 ON <input type="checkbox"/> <input type="checkbox"/> <input type="checkbox"/> <input type="checkbox"/> <input type="checkbox"/> <input type="checkbox"/> <input type="checkbox"/> <input type="checkbox"/> 1 2 3 4 5 6 7 8	Adresse : 10 ON <input type="checkbox"/> <input type="checkbox"/> <input type="checkbox"/> <input type="checkbox"/> <input type="checkbox"/> <input type="checkbox"/> <input type="checkbox"/> <input type="checkbox"/> 1 2 3 4 5 6 7 8	Adresse : 11 ON <input type="checkbox"/> <input type="checkbox"/> <input type="checkbox"/> <input type="checkbox"/> <input type="checkbox"/> <input type="checkbox"/> <input type="checkbox"/> <input type="checkbox"/> 1 2 3 4 5 6 7 8	Adresse : 12 ON <input type="checkbox"/> <input type="checkbox"/> <input type="checkbox"/> <input type="checkbox"/> <input type="checkbox"/> <input type="checkbox"/> <input type="checkbox"/> <input type="checkbox"/> 1 2 3 4 5 6 7 8	
Adresse : 13 ON <input type="checkbox"/> <input type="checkbox"/> <input type="checkbox"/> <input type="checkbox"/> <input type="checkbox"/> <input type="checkbox"/> <input type="checkbox"/> <input type="checkbox"/> 1 2 3 4 5 6 7 8	Adresse : 14 ON <input type="checkbox"/> <input type="checkbox"/> <input type="checkbox"/> <input type="checkbox"/> <input type="checkbox"/> <input type="checkbox"/> <input type="checkbox"/> <input type="checkbox"/> 1 2 3 4 5 6 7 8	Adresse : 15 ON <input type="checkbox"/> <input type="checkbox"/> <input type="checkbox"/> <input type="checkbox"/> <input type="checkbox"/> <input type="checkbox"/> <input type="checkbox"/> <input type="checkbox"/> 1 2 3 4 5 6 7 8	Adresse : 16 ON <input type="checkbox"/> <input type="checkbox"/> <input type="checkbox"/> <input type="checkbox"/> <input type="checkbox"/> <input type="checkbox"/> <input type="checkbox"/> <input type="checkbox"/> 1 2 3 4 5 6 7 8	
Adresse : 17 ON <input type="checkbox"/> <input type="checkbox"/> <input type="checkbox"/> <input type="checkbox"/> <input type="checkbox"/> <input type="checkbox"/> <input type="checkbox"/> <input type="checkbox"/> 1 2 3 4 5 6 7 8	Adresse : 18 ON <input type="checkbox"/> <input type="checkbox"/> <input type="checkbox"/> <input type="checkbox"/> <input type="checkbox"/> <input type="checkbox"/> <input type="checkbox"/> <input type="checkbox"/> 1 2 3 4 5 6 7 8	Adresse : 19 ON <input type="checkbox"/> <input type="checkbox"/> <input type="checkbox"/> <input type="checkbox"/> <input type="checkbox"/> <input type="checkbox"/> <input type="checkbox"/> <input type="checkbox"/> 1 2 3 4 5 6 7 8	Adresse : 20 ON <input type="checkbox"/> <input type="checkbox"/> <input type="checkbox"/> <input type="checkbox"/> <input type="checkbox"/> <input type="checkbox"/> <input type="checkbox"/> <input type="checkbox"/> 1 2 3 4 5 6 7 8	
Adresse : 21 ON <input type="checkbox"/> <input type="checkbox"/> <input type="checkbox"/> <input type="checkbox"/> <input type="checkbox"/> <input type="checkbox"/> <input type="checkbox"/> <input type="checkbox"/> 1 2 3 4 5 6 7 8	Adresse : 22 ON <input type="checkbox"/> <input type="checkbox"/> <input type="checkbox"/> <input type="checkbox"/> <input type="checkbox"/> <input type="checkbox"/> <input type="checkbox"/> <input type="checkbox"/> 1 2 3 4 5 6 7 8	Adresse : 23 ON <input type="checkbox"/> <input type="checkbox"/> <input type="checkbox"/> <input type="checkbox"/> <input type="checkbox"/> <input type="checkbox"/> <input type="checkbox"/> <input type="checkbox"/> 1 2 3 4 5 6 7 8	Adresse : 24 ON <input type="checkbox"/> <input type="checkbox"/> <input type="checkbox"/> <input type="checkbox"/> <input type="checkbox"/> <input type="checkbox"/> <input type="checkbox"/> <input type="checkbox"/> 1 2 3 4 5 6 7 8	
Adresse : 25 ON <input type="checkbox"/> <input type="checkbox"/> <input type="checkbox"/> <input type="checkbox"/> <input type="checkbox"/> <input type="checkbox"/> <input type="checkbox"/> <input type="checkbox"/> 1 2 3 4 5 6 7 8	Adresse : 26 ON <input type="checkbox"/> <input type="checkbox"/> <input type="checkbox"/> <input type="checkbox"/> <input type="checkbox"/> <input type="checkbox"/> <input type="checkbox"/> <input type="checkbox"/> 1 2 3 4 5 6 7 8	Adresse : 27 ON <input type="checkbox"/> <input type="checkbox"/> <input type="checkbox"/> <input type="checkbox"/> <input type="checkbox"/> <input type="checkbox"/> <input type="checkbox"/> <input type="checkbox"/> 1 2 3 4 5 6 7 8	Adresse : 28 ON <input type="checkbox"/> <input type="checkbox"/> <input type="checkbox"/> <input type="checkbox"/> <input type="checkbox"/> <input type="checkbox"/> <input type="checkbox"/> <input type="checkbox"/> 1 2 3 4 5 6 7 8	
Adresse : 29 ON <input type="checkbox"/> <input type="checkbox"/> <input type="checkbox"/> <input type="checkbox"/> <input type="checkbox"/> <input type="checkbox"/> <input type="checkbox"/> <input type="checkbox"/> 1 2 3 4 5 6 7 8	Adresse : 30 ON <input type="checkbox"/> <input type="checkbox"/> <input type="checkbox"/> <input type="checkbox"/> <input type="checkbox"/> <input type="checkbox"/> <input type="checkbox"/> <input type="checkbox"/> 1 2 3 4 5 6 7 8	Adresse : 31 ON <input type="checkbox"/> <input type="checkbox"/> <input type="checkbox"/> <input type="checkbox"/> <input type="checkbox"/> <input type="checkbox"/> <input type="checkbox"/> <input type="checkbox"/> 1 2 3 4 5 6 7 8	Adresse : 32 ON <input type="checkbox"/> <input type="checkbox"/> <input type="checkbox"/> <input type="checkbox"/> <input type="checkbox"/> <input type="checkbox"/> <input type="checkbox"/> <input type="checkbox"/> 1 2 3 4 5 6 7 8	

■ Exemple

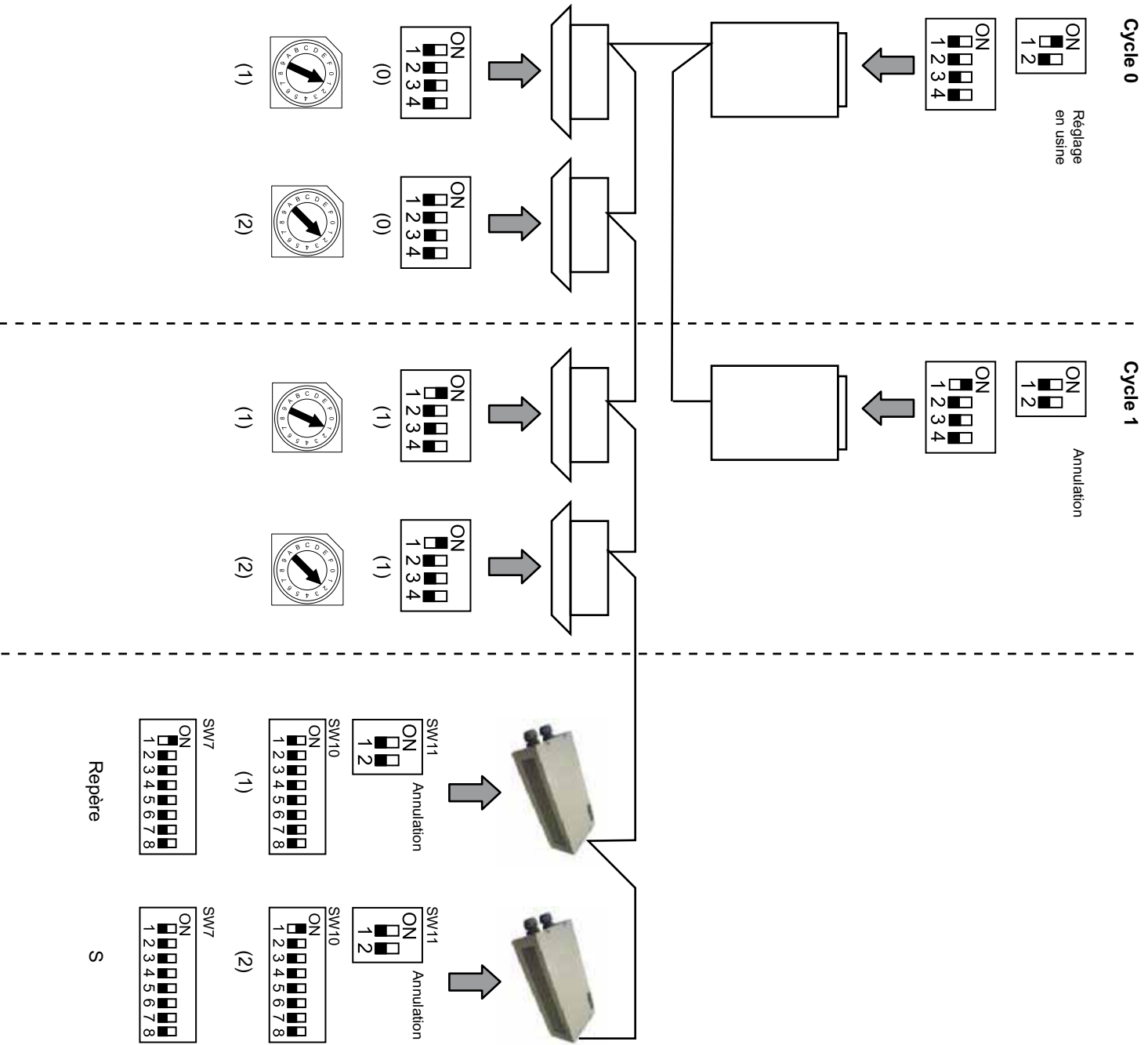

6. Fonctionnement

6.1 PACKAGED : Données disponibles

Adresse (remarque 1)	Nom	Description	Lecture/Écriture
0	EXIST	EXIST : 0: Absent 1: Présent	Lecture
1	SYSTEM_ADDRESS	Adresse du système : 0 à 15 sur H-LINK 1	Lecture
2	UNIT_ADDRESS	Adresse de l'unité : 0 à 15 sur H-LINK1	Lecture
3	SET_ONOFF	Réglage du mode On/Off 0: Arrêt 1: Marche	Lecture/Écriture
4	SET_MODE	Ordre de réglage des modes : 0: Froid 2: Ventilateur 3: Chauffage 4: Auto	Lecture/Écriture
5	SET_FAN	Réglage du ventilateur : 0: Lent 2: Rapide 1: Moyen	Lecture/Écriture
6	SET_TSET	Réglage de la température : 17 °C à 30 °C	Lecture/Écriture
7	SET_LOUVER	Réglage du déflecteur : 0 à 8 (8 correspond à Auto)	Lecture/Écriture
8	SET_CENTRAL	Réglage centralisé Bit 0 : On/Off (peut être arrêté à tout moment) Bit 1 : Mode Bit 2 : Réglage Temp Bit 3 : Ventilateur	Lecture/Écriture
9	READ_ONOFF	Lecture On/Off : 0: Off 1: On	Lecture
10	READ_MODE	Mode Lecture 0: Froid 2: Ventilateur 3: Chauffage 4: Auto 1: Déshumidification 3: Chauffage	Lecture
11	READ_FAN	Lecture Ventilateur 0: Lent 2: Rapide 1: Moyen	Lecture
12	READ_TSET	Lecture réglage température (17 °C à 30 °C)	Lecture
13	READ_LOUVER	Lecture déflecteur 0 à 8 (8 correspond à Auto)	Lecture
14~18	(Non utilisé)	(Non utilisé)	(Non utilisé)
19	ERROR_CODE	Code d'alarme	Lecture
20~21	(Non utilisé)	(Non utilisé)	(Non utilisé)
22	OPER_CONDITION	Conditions de fonctionnement de l'unité 0: OFF 2: Thermo ON 1: Thermo OFF 3: Alarme	Lecture
23~31	(Non utilisé)	(Non utilisé)	(Non utilisé)

Remarque 1 : Pour calculer la position du différentiel : 20000 + N*32 + adresse lue dans le tableau, avec N représentant l'adresse de l'unité intérieure.

■ Configuration

Chaque HARC-MODBUS peut commander jusqu'à 32 UI, et un même H-LINK peut être connecté à jusqu'à 128 UI. Vous devez donc sélectionner les unités intérieures à connecter à chacun des HARC-MODBUS.

Cette configuration n'est pas nécessaire pour l'application CHILLER.

Le concept de réglage consiste en un tableau « id » énumérant jusqu'à 32 nombres pour l'assignation de chaque adresse G.E.+UI tel qu'indiqué ci-dessous :

Id	Adresse du cycle frigorifique	Adresse de l'unité intérieure
00	00	00
01	00	01
02	00	02
03	00	03
04	00	04
05	00	05
06	00	06
07	00	07
08	00	08
09	00	09
10	00	10
11	00	11
12	00	12
13	00	13
14	00	14
15	00	15

Id	Adresse du cycle frigorifique	Adresse de l'unité intérieure
16	01	00
17	01	01
18	01	02
19	01	03
20	01	04
21	01	05
22	01	06
23	01	07
24	01	08
25	01	09
26	01	10
27	01	11
28	01	12
29	01	13
30	01	14
31	01	15



Remarque :

- Vous pouvez sélectionner jusqu'à 32 UI provenant de 16 cycles frigorifiques différents pour 1 HARC-MODBUS, ou 32 UI du même cycle frigorifique.



Attention :

- Assurez-vous de ne pas configurer une unité intérieure pour plus d'un HARC-MODBUS. Cette erreur est indétectable, et peut provoquer des réactions indésirables.

N°	Action	7 segments (afficheur)	Remarques
1	Appuyez sur SW4 pendant 3 secondes	id	Mode de configuration sélectionné
2	Appuyez sur SW4	00	Sélection de l'Id (N° UI) de 0 à 31 en appuyant sur SW5 ▲ ou SW6 ▼
3	Appuyez sur SW4	01	Adresse du cycle frigorifique
4	Appuyez sur SW4	---→00	Sélection de l'adresse du cycle frigorifique de 0 à 15 (par ex. 00) (en appuyant sur SW5 ▲ et SW6 ▼)
5	Appuyez sur SW4	11	Adresse de l'unité intérieure
6	Appuyez sur SW4	---→00	Sélection de l'adresse de l'unité intérieure de 0 à 15 (par ex. 00) (en appuyant sur SW5 ▲ et SW6 ▼)
Pour l'« Id » 01, répétez les étapes 1 à 6			
7	Appuyez sur SW4 pendant 3 secondes	id	Mode de configuration sélectionné
8	Appuyez sur SW4	00→01	Sélection de l'Id (N° UI) de 0 à 31 en appuyant sur SW5 ▲ ou SW6 ▼
9	Appuyez sur SW4	01	Adresse du cycle frigorifique
10	Appuyez sur SW4	---→00	Sélection de l'adresse du cycle frigorifique de 0 à 15 (par ex. 00) (en appuyant sur SW5 ▲ et SW6 ▼)
11	Appuyez sur SW4	11	Adresse de l'unité intérieure
12	Appuyez sur SW4	---→01	Sélection de l'adresse de l'unité intérieure de 0 à 15 (par ex. 01, appuyez une fois sur SW5) (en appuyant sur SW5 ▲ et SW6 ▼)
... Répétez les étapes 1 à 6 pour les autres « Id »			
187	Appuyez sur SW4 pendant 3 secondes	id	Mode de configuration sélectionné
188	Appuyez sur SW4	00→31	Sélection de l'Id (N° UI) de 0 à 31 en appuyant sur SW5 ▲ ou SW6 ▼
189	Appuyez sur SW4	01	Adresse du cycle frigorifique
190	Appuyez sur SW4	---→01	Sélection de l'adresse du cycle frigorifique de 0 à 15 (par ex. 01, appuyez une fois sur SW5) (en appuyant sur SW5 ▲ et SW6 ▼)
191	Appuyez sur SW4	11	Adresse de l'unité intérieure
192	Appuyez sur SW4	---→15	Sélection de l'adresse de l'unité intérieure de 0 à 15 (par ex. 15, appuyez une fois sur SW6) (en appuyant sur SW5 ▲ et SW6 ▼)

6.2 CHILLER : Données disponibles

Adresse	Nom	Description	Valeurs	Lecture/ Écriture
0	EXIST	Présent	0: Absent 1: Présent	Lecture
1	SYSTEM_ADDRESS	Adresse du CHILLER	0 à 15 sur H-LINK 1	Lecture
2	(Non utilisé)	(Non utilisé)	(Non utilisé)	(Non utilisé)
3	ONOFF_SET	Réglage du mode On/Off	0: Arrêt 1: Marche	Lecture/ Écriture
4	MODE_SET	Réglage des modes	0: Froid 1: Chauffage	Lecture/ Écriture
5	TEMP_SET_C	Température du réglage COOL	(voir note *)	Lecture/ Écriture
6	TEMP_SET_H	Température du réglage HEAT		Lecture/ Écriture
7	CENTRAL_SET	Réglage centralisé	0: Local 1: À distance	Lecture/ Écriture
8	ONOFF_STATUS	État ON/OFF	0: Off 1: On	Lecture
9	MODE_STATUS	Mode État	0: Froid 1: Chauffage	Lecture
10	TEMP_C_STATUS	État température du réglage COOL		Lecture
11	TEMP_H_STATUS	État température du réglage HEAT		Lecture
12	WATER_INLET	Température d'admission		Lecture
13	WATER_OUTLET	Température à la sortie		Lecture
14	AMBIENT_TEMPERATURE	Température ambiante		Lecture
15	OPER_CONDITION	Conditions de fonctionnement de l'unité	0: OFF 1: Thermo OFF 2: Thermo ON 3: Alarme	Lecture
16	ERROR_CODE_CH	Code d'alarme pour l'alarme CHILLER générale		Lecture
17~22	ERROR_CODE_CYC	Code d'alarme pour alarme cycle (1 à 6)		Lecture
23~31	(Non utilisé)	(Non utilisé)	(Non utilisé)	(Non utilisé)



Remarques :

- Pour calculer la position du différentiel : $40000 + N*32 + \text{adresse lue dans le tableau, avec } N \text{ représentant l'adresse du Réfrigérant d'eau.}$
- Les paramètres Status (valeur réelle) et Set (valeur commandée) ont normalement la même valeur. Toutefois, ils peuvent différer dans certains cas. Il est recommandé d'utiliser les paramètres Set pour un fonctionnement normal.
- *) Pour modifier à la fois la température et le mode de fonctionnement, commencez par configurer le mode de fonctionnement puis définissez la température souhaitée.

6.3 Liste des codes d'alarme pour CHILLER

6.3.1 Liste des codes des alarmes du CHILLER

Alarme du CHILLER		Description	H-LINK
7SEG1	7SEG2		Code
11	11	Défaillance de la thermistance de l'entrée de l'eau	20
12	12	Défaillance de la thermistance de la sortie d'eau (unité cycle simple uniquement)	21
22	22	Défaillance de la thermistance de la température ambiante (ouvert/court-circuit)	24
5P	5P	Aucun signal de retour de la pompe à eau	26
13	13	Activation du contrôle de la protection antigivre (unité cycle simple uniquement)	27
6C	6C	Alarme de défaillance de l'eau (option interrupteur de pression différentielle de l'eau ou interrupteur de débit)-Condenseur	28
6E	6E	Alarme de défaillance de l'eau (option interrupteur de pression différentielle de l'eau ou interrupteur de débit)-Évaporateur	29
14	14	Activation du thermostat en cas de température de l'eau excessivement élevée (unités cycle simple uniquement)	30
RP	RP	Déclenchement du dispositif de protection supplémentaire	31
05	05	Anomalie de phase	32
CP	CP	Erreur de communication entre PCB de commande (PCB _{cs1} , PCB _{cs2})	33
03	03	Erreur de communication entre le réfrigérant et la télécommande (H-LINK)	34
EU	EU	Erreur de communication entre la PCB du détendeur électronique et la commande PCB	36
40	40	Fonctionnement incorrect	40-45, 47,47,54

6.3.2 Liste des codes des alarmes du cycle

Alarme du cycle		Description	H-LINK
7SEG1	7SEG2		Code
E_n	H_n	Activation du pressostat haute pression	1
E_n	L_n	Activation de la commande de basse pression	2
E_n	7_n	Activation du thermostat interne du compresseur	3
E_n	6_n	Activation de la thermistance de refoulement du gaz	4
E_n	5_n	Activation du relais thermique du compresseur ou dysfonctionnement du relais auxiliaire ARn	5
E_n	$F0$	Réglage incorrect du numéro du ventilateur	6
E_n	4_n	Activation du thermostat du moteur du ventilateur intérieur	7
E_n	L_n	Basse pression excessive	8
E_n	9_n	Température excessivement basse du frigorigène à l'entrée du refroidisseur	10
E_n	27	Défaillance du capteur de pression du gaz au refoulement (ouvert/court-circuit)	11
E_n	28	Défaillance du capteur de pression du gaz d'aspiration (ouvert/court-circuit)	12
E_n	12	Défaillance de la thermistance de la sortie d'eau (unité cycle pas unique)	14
E_n	23	Défaillance de la thermistance du gaz de refoulement (ouvert/court-circuit)	15
E_n	26	Défaillance de la thermistance du gaz d'aspiration (ouvert/court-circuit)	16
E_n	05	Anomalie de phase	17
E_n	21	Défaillance de la thermistance de l'entrée du réfrigérant (ouvert/court-circuit)	19
E_n	6_n	Activation de la thermistance du gaz d'aspiration	20
E_n	13	Activation du contrôle de la protection antigivre (unité cycle non unique)	21
E_n	24	Défaillance de la thermistance réglée avant le détendeur (ouvert/court-circuit)	23
E_n	25	Défaillance de la thermistance de l'arrivée d'eau - partie arrière du refroidisseur (ouvert/court-circuit)	24
F_n	51	Anomalie de l'alimentation électrique de l'inverter	34

7. Dépannage

N°	Code d'alarme	Description	Contre-mesure
1	EE → B !	Les unités intérieures n'ont pas communiqué avec le HARC-MODBUS pendant plus de 10 minutes	<ol style="list-style-type: none"> Assurez-vous que la connection H-LINK au HARC (K1) et aux unités intérieures est correctement réalisée. Assurez-vous que les climatiseurs sont sous tension.
2	EE → B3	Les unités intérieures n'ont jamais communiqué avec le HARC-MODBUS	<ol style="list-style-type: none"> Assurez-vous que la connection H-LINK au HARC (K1) et aux unités intérieures est correctement effectuée. Assurez-vous que les climatiseurs sont sous tension.
3	D7 est toujours OFF	Aucun voyant DEL ne clignote au niveau de la PCB et 7 segments sont OFF	<ol style="list-style-type: none"> Assurez-vous que la source d'alimentation est sur 230. Assurez-vous que K3 reçoit +5 V c.c. <p> Remarques :</p> <ul style="list-style-type: none"> Le signal c.c. de l'entrée d'alimentation comporte un commutateur rotatif qui doit être correctement configuré pour fournir +5 V c.c. D7 doit être sur ON.
4	D12 ne clignote jamais	HARC-MODBUS ne lit pas/n'envoie pas de données (D12 ne clignote jamais)	<ol style="list-style-type: none"> Vérifiez le branchement entre les dispositifs MODBUS et K5.
5	D12 ne clignote pas	HARC ne fonctionne pas. (D13 ne clignote pas)	<ol style="list-style-type: none"> Vérifiez que SW3 est en position RUN. Dans le cas contraire, placez-le sur RUN puis appuyez sur Reset.
6	D4 et D11 ne clignotent pas	Il n'y a pas de communication H-LINK depuis HARC-MODBUS	<ol style="list-style-type: none"> D4 clignote mais D11 ne clignote pas. → Voir ligne N°6, contre-mesure 1. D4 et D11 ne clignotent pas. → Voir ligne N°3, contre-mesure 1.

Sommario

1.	Precauzioni per la sicurezza	68
2.	Nomi dei componenti	68
3.	Specifiche tecniche	69
4.	Lavori di installazione	70
4.1	Disegni quotati	70
4.2	Fissaggio	70
5.	Collegamenti elettrici	71
5.1	Collegamenti elettrici	71
5.2	Impostazioni interruttore DIP	72
6.	Funzionamento	76
6.1	PACKAGED: Dati disponibili	76
6.2	CHILLER: Dati disponibili	79
6.3	Elenco codici di allarme per CHILLER	80
6.3.1	Elenco codici allarmi CHILLER	80
6.3.2	Elenco codici allarmi ciclo	81
7.	Risoluzione dei problemi	82

**Nota:**

Questo manuale fornisce informazioni di base per l'installazione e il cablaggio di HARC-MODBUS.

1. Precauzioni per la sicurezza



Attenzione:

Completare in modo corretto l'installazione prima di collegare la tensione di ingresso al sistema di controllo.

Leggere il presente manuale con attenzione prima di eseguire l'installazione.

Leggere il presente manuale per configurare HARC-MODBUS.



Attenzione:

Installare HARC-MODBUS lontano da possibili fonti di onde elettromagnetiche.

Rispettare gli standard elettrici locali.

Utilizzare un circuito di alimentazione che non sia soggetto a sovraccarichi.

Assicurarsi che lo spazio attorno a HARC-MODBUS sia sufficiente (vedere figura) in modo tale che il calore venga disperso in modo adeguato (fare riferimento alla sezione "Lavori di installazione").

Se si installa HARC-MODBUS in posizione verticale, installare l'alimentazione nella parte inferiore.

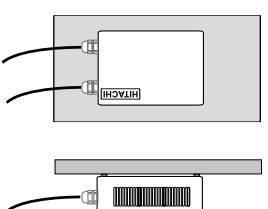

Attenzione:

Non installare HARC-MODBUS in prossimità di punti in cui:

- Si rileva vapore, olio o dispersione di liquidi.
- Vi siano fonti di calore nelle vicinanze (ambiente solforico).
- Si rileva accumulo, generazione o perdita di gas infiammabili.
- Si rileva un ambiente alcalino, acido o salino, vicino al mare.

2. Nomi dei componenti

L'immagine mostra il nome dei componenti di HARC-MODBUS.

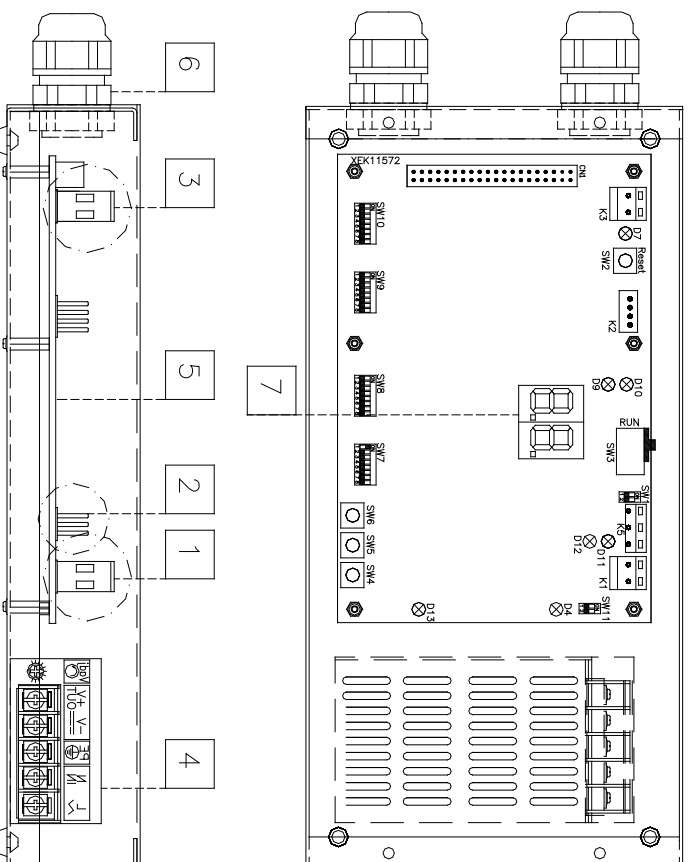

- 1 K1: Connettore H-LINK: Collegato a CSNET WEB
- 2 K5: Porta seriale RS485
- 3 K3: Collegamento alimentazione +5Vc.c.
- 4 Alimentazione elettrica: 230Vc.a. / 5Vc.c.
- 5 H-LINK PCB
- 6 Premistoppa (2)
- 7 segmenti

3. Specifiche tecniche

Specifiche dell'Hardware

Elemento	Specifiche tecniche
Alimentazione	1~230 V \pm 10% 50 Hz
Consumo	25 W (massimo)
Dimensioni esterne	Larghezza: 143 mm, Profondità: 302 mm, Altezza: 76 mm
Peso	1,75 kg
Condizioni di montaggio	Interni (in un pannello di controllo o desktop)
Temperatura ambiente	0~40 °C
Umidità	20~85% (senza condensa)

MODBUS - Comunicazione con il sistema superiore

Elemento	Specifiche tecniche
K5	Porta seriale RS485 (connettore a 3 pin) - Protocollo MODBUS
Linea di comunicazione	Doppio ritorno. Polarità
Sistema di comunicazione	Semiduplex, connessione seriale multipunto
Metodo di comunicazione	Selezione di nessuna parità o parità pari/dispari Lunghezza dati: 8 bit (vedere capitolo 5)
Trasmissione velocità in baud	19200/9600 baud (vedere capitolo 5)
Lunghezza	max. 1200 m in base ad EIA-485

H-LINK - Comunicazione con le unità

Elemento	Specifiche tecniche
Comunicazione con	HITACHI PACKAGED/CHILLER
Linea di comunicazione	Doppio ritorno schermato, senza polarità
Sistema di comunicazione	Semiduplex
Metodo di comunicazione	Asincrono
Velocità di trasmissione	9600 Baud
Lunghezza del cablaggio	1000 m massimo (lunghezza totale di HLINK I/O bus)
Numero massimo di HARC MODBUS	8 HARC-MODBUS/H-LINK SYSTEM (PACKAGED) 1 HARC-MODBUS/H-LINK SYSTEM (CHILLER)



Attenzione:

HARC-MODBUS non può funzionare in unità interne senza un interruttore di controllo remoto collegato.

4. Lavori di installazione

Quando si procede al disimballaggio di HARC-MODBUS, controllare che non abbia subito danni durante il trasporto.

4.1 Disegni quotati

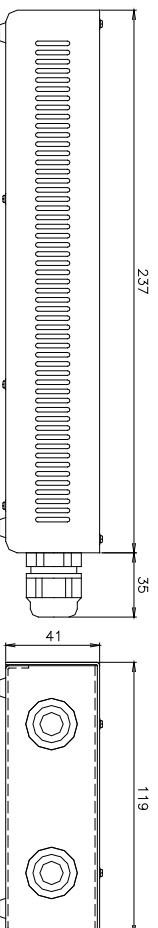

4.2 Fissaggio

Procedere come indicato di seguito:

- 1 Rimuovere i supporti di gomma.
- 2 Svitare le 4 viti dal coperchio superiore e rimuoverle.
- 3 Fissare la scatola al pannello verticale posteriore dall'interno con viti M4 (non fornite) e collocare rosette di 3 mm sul lato esterno per separare la scatola dalla parete.
- 4 Installare nuovamente il coperchio superiore. Fare attenzione e collocarlo nella posizione corretta.
- 5 Mantenere libera l'area della griglia per garantire la ventilazione e permettere il collegamento del cavo.

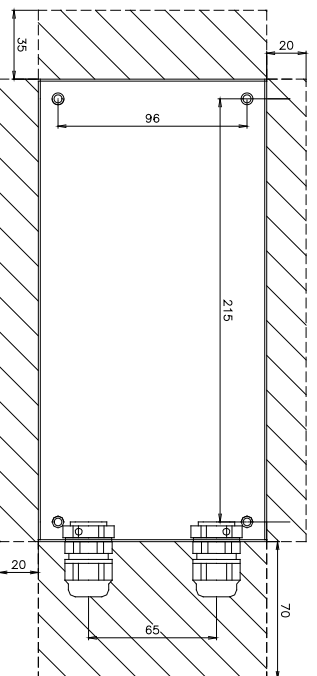

⚠ Attenzione:

- Prima di applicare l'alimentazione e accendere HARC-MODBUS è necessario controllare che:
 1. Tutti i circuiti da collegare sono applicati in modo corretto.
 2. Tutte le connessioni H-Link sono state impostate.
 3. Seguire la normativa locale vigente per l'installazione dei collegamenti elettrici di HARC-MODBUS e dei circuiti associati.

Le unità non collegate o che non si trovano sotto tensione nel momento in cui viene attivato HARC-MODBUS, non verranno riconosciute e dovranno essere configurate in seguito.

⚠ Attenzione:

- Accorciare il più possibile i cavi dei segnali. Mantenere una distanza superiore ai 150 mm da altri cavi di alimentazione. Non cablarli insieme (anche se possono incrociarsi). Se fosse necessario installarli insieme, prendere le seguenti precauzioni per evitare disturbi:
 - Proteggere il cavo di segnale con un tubo metallico con messa a terra a un'estremità.
 - Per le comunicazioni, utilizzare un cavo schermato con messa a terra a un'estremità.

⚠ Pericolo:

- Scollegare sempre l'alimentazione di HARC-MODBUS quando la macchina viene manipolata, per evitare scariche elettriche.
- Non collegare l'interfaccia all'alimentazione prima di aver portato a termine l'installazione.
- Seguire strettamente i codici e i regolamenti di sicurezza locali quando si collega la macchina a una rete elettrica.
- Sarà necessario un cavo a filo triplo (due nuclei e terra) con una spina adeguata in una delle estremità.

5. Collegamenti elettrici

5.1 Collegamenti elettrici

Per funzionare, HARC-MODBUS deve essere collegato ai segnali di ingresso e uscita corrispondenti, ai cavi di alimentazione e ad H-LINK.

N.	Collegamento	Specifiche del cavo
1	Circuito di alimentazione 1~ 230 V 50 Hz 25 W (con circuito di protezione)	Selezionare i cavi in base alla normativa locale vigente (minimo consigliato 1,5 mm ² H05RN-F)
2	MODBUS	3 cavi cablaggio preassemblato 0,75 mm ² (tipo H05RN-F). Utilizzare un colore diversa per ogni cavo. (Porta seriale RS485)
3	H-LINK	Cavi di comunicazione per il collegamento di HARC MODBUS a un'installazione Hitachi, via CSNET WEB o a qualsiasi unità Hitachi utilizzando gli stessi terminali H-LINK Doppino ritorto schermato 0,75 mm ² (tipo H05RN-F) I cavi schermati devono essere messi a terra solo su un lato
4	Alimentazione PCB +5 V c.c. I _{max} = 5 A c.c.	Doppino 0,75 mm ² (tipo H05RN-F)



Nota:

Tutti i cavi, eccetto 4, sono forniti sul campo.

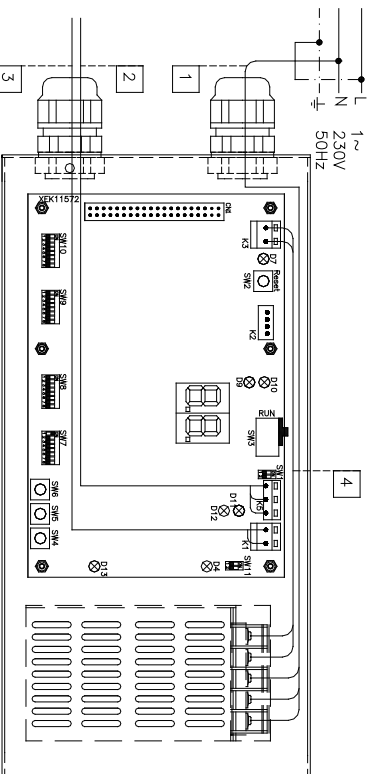

Protezioni non in dotazione:

CB/EF: 5 A

ELB: 2/40 A/30 mA

CB: Interruttore di circuito

EF: Fusibile elettrico





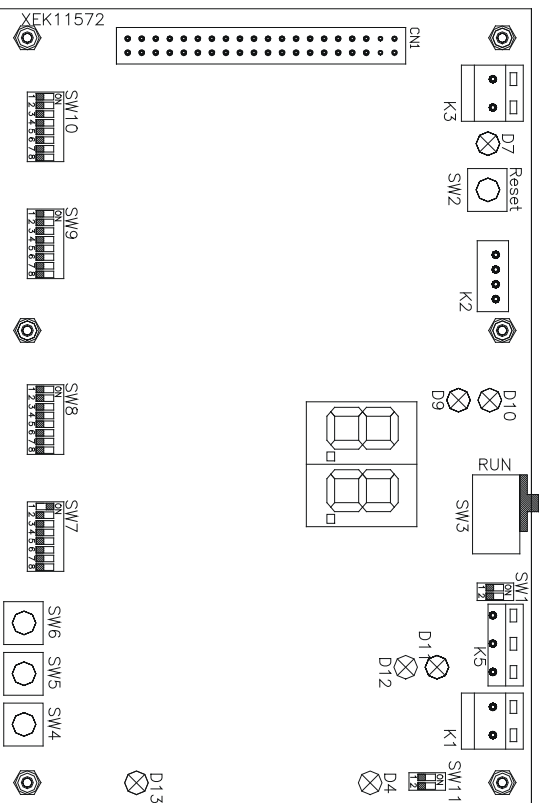

ELB: Interruttore differenziale

5.2 Impostazioni interruttore DIP



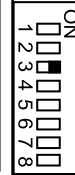
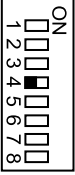
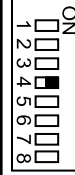

Nome	Funzione	Impostazione di fabbrica	Descrizione
SW1	Non disponibile	ON 1 2	Tutti su OFF (nessuna funzione)
SW2	Reset	-	Pulsante di ripristino. Da utilizzare in caso di blocco del programma
SW3 (TELE)	Non disponibile	RUN	Scopi di fabbrica. Non modificare
SW4	Configurazione	-	Impostazione delle funzioni
SW5	Configurazione	-	Impostazione delle funzioni
SW6	Configurazione	-	Impostazione delle funzioni
SW7	Opzioni 2	ON 1 2 3 4 5 6 7 8	SW7-1: OFF-SLAVE / ON-MASTER. Da utilizzare nel caso di diversi HARC-MODBUS nello stesso indirizzo H-LINK SW7-2: OFF-EVENT CONTROL/ON-CHANGE CONTROL SW7-3: OFF - Parità disattivata / ON - Parità attivata SW7-4: OFF - Parità pari / ON - Parità dispari SW7-5: OFF - 19200 Bps / ON - 9600 Bps SW7-(6~8): Non utilizzato
SW8	Opzioni 1 (tipo applicazione)	ON 1 2 3 4 5 6 7 8	SW8-1: OFF-PACKAGED / ON-CHILLER. Da impostare in base all'applicazione unità SW8-2~8: Non utilizzato
SW9	Non disponibile	ON 1 2 3 4 5 6 7 8	Tutti su OFF (nessuna funzione)
SW10	Indirizzo HARC MODBUS	ON 1 2 3 4 5 6 7 8	Indirizzo HARC-MODBUS da 1 a 32 pin da 1 a 5
SW11	H-LINK DSW	ON 1 2	DSW a 2 Pin SW11-1: Resistenza terminale H-LINK SW11-2: Protezione fusibile H-LINK
D4, D11	H-LINK	-	Trasmissione H-LINK
D7	Potenza	-	Alimentazione ON/OFF
D9/D10	Non utilizzato	-	-
D12	MODBUS	-	Comunicazione Modbus in RS485
D13	Funzionamento	-	Funzionamento del software normale

■ SW7 – IMPOSTAZIONE DELLE FUNZIONI 1

SW7	Descrizione
 	<p>Configurazione come MASTER/SLAVE:</p> <p>MASTER: SW7-1=ON È possibile impostare un solo HARC-MODBUS come MASTER HARC-MODBUS Impostazione predefinita</p> <p>SLAVE: SW7-1= OFF Un HARC-MODBUS deve essere configurato come MASTER, mentre gli altri HARC-MODBUS devono essere configurati come SLAVE nello stesso H-LINK</p>
 	<p>Modalità aggiornamento dati</p> <p>Configurazione come EVENT CONTROL: SW7-2:OFF I parametri sono aggiornati nell'U.I. ogni volta che BMS scrive un parametro di impostazione (anche se non viene cambiato nessun valore). Impostazione predefinita</p> <p>Configurazione come CHANGE CONTROL: SW7-2:ON I parametri sono aggiornati nell'U.I. solo quando vengono cambiati alcuni valori</p>
 	<p>Configurazione di parità</p> <p>SW7-3: OFF : Nessuna configurazione di parità</p> <p>SW7-3: ON: Comunicazione di parità (vedere la configurazione SW7-4 per il tipo di parità)</p>
 	<p>Configurazione del tipo di parità</p> <p>SW7-4: OFF : Parità pari (se SW7-3 è ON)</p> <p>SW7-4: ON: Parità dispari (se SW7-3 è ON)</p>
 	<p>Velocità di comunicazione in baud</p> <p>SW7-5: OFF 19200 Bps</p> <p>SW7-5: ON 9600 Bps</p>

■ SW8 – IMPOSTAZIONE DELLE FUNZIONI 2

SW8	Descrizione
 	<p>Configurazione per PACKAGED / CHILLER</p> <p>Applicazioni PACKAGED: SW8-1: OFF</p> <p>Applicazioni CHILLER: SW8-1: ON</p>

■ SW10 – Indirizzo HARC H-LINK (stesso principio dell'indirizzo di U.E./ciclo refrigerante)

SW10				Descrizione
Indirizzo: 1 ON <input type="checkbox"/> <input type="checkbox"/> <input type="checkbox"/> <input type="checkbox"/> <input type="checkbox"/> <input type="checkbox"/> <input type="checkbox"/> <input type="checkbox"/> 1 2 3 4 5 6 7 8	Indirizzo: 2 ON <input type="checkbox"/> <input type="checkbox"/> <input type="checkbox"/> <input type="checkbox"/> <input type="checkbox"/> <input type="checkbox"/> <input type="checkbox"/> <input type="checkbox"/> 1 2 3 4 5 6 7 8	Indirizzo: 3 ON <input type="checkbox"/> <input type="checkbox"/> <input type="checkbox"/> <input type="checkbox"/> <input type="checkbox"/> <input type="checkbox"/> <input type="checkbox"/> <input type="checkbox"/> 1 2 3 4 5 6 7 8	Indirizzo: 4 ON <input type="checkbox"/> <input type="checkbox"/> <input type="checkbox"/> <input type="checkbox"/> <input type="checkbox"/> <input type="checkbox"/> <input type="checkbox"/> <input type="checkbox"/> 1 2 3 4 5 6 7 8	Configurazione dell'indirizzo HARC Indirizzo HARC-MODBUS utilizzato dal sistema MODBUS I pin SW10 dall'1 al 5 devono essere impostati in base al disegno corrispondente dell'indirizzo desiderato I pin SW10 dal 6 all'8 devono essere impostati su OFF
Indirizzo: 5 ON <input type="checkbox"/> <input type="checkbox"/> <input type="checkbox"/> <input type="checkbox"/> <input type="checkbox"/> <input type="checkbox"/> <input type="checkbox"/> <input type="checkbox"/> 1 2 3 4 5 6 7 8	Indirizzo: 6 ON <input type="checkbox"/> <input type="checkbox"/> <input type="checkbox"/> <input type="checkbox"/> <input type="checkbox"/> <input type="checkbox"/> <input type="checkbox"/> <input type="checkbox"/> 1 2 3 4 5 6 7 8	Indirizzo: 7 ON <input type="checkbox"/> <input type="checkbox"/> <input type="checkbox"/> <input type="checkbox"/> <input type="checkbox"/> <input type="checkbox"/> <input type="checkbox"/> <input type="checkbox"/> 1 2 3 4 5 6 7 8	Indirizzo: 8 ON <input type="checkbox"/> <input type="checkbox"/> <input type="checkbox"/> <input type="checkbox"/> <input type="checkbox"/> <input type="checkbox"/> <input type="checkbox"/> <input type="checkbox"/> 1 2 3 4 5 6 7 8	
Indirizzo: 9 ON <input type="checkbox"/> <input type="checkbox"/> <input type="checkbox"/> <input type="checkbox"/> <input type="checkbox"/> <input type="checkbox"/> <input type="checkbox"/> <input type="checkbox"/> 1 2 3 4 5 6 7 8	Indirizzo: 10 ON <input type="checkbox"/> <input type="checkbox"/> <input type="checkbox"/> <input type="checkbox"/> <input type="checkbox"/> <input type="checkbox"/> <input type="checkbox"/> <input type="checkbox"/> 1 2 3 4 5 6 7 8	Indirizzo: 11 ON <input type="checkbox"/> <input type="checkbox"/> <input type="checkbox"/> <input type="checkbox"/> <input type="checkbox"/> <input type="checkbox"/> <input type="checkbox"/> <input type="checkbox"/> 1 2 3 4 5 6 7 8	Indirizzo: 12 ON <input type="checkbox"/> <input type="checkbox"/> <input type="checkbox"/> <input type="checkbox"/> <input type="checkbox"/> <input type="checkbox"/> <input type="checkbox"/> <input type="checkbox"/> 1 2 3 4 5 6 7 8	
Indirizzo: 13 ON <input type="checkbox"/> <input type="checkbox"/> <input type="checkbox"/> <input type="checkbox"/> <input type="checkbox"/> <input type="checkbox"/> <input type="checkbox"/> <input type="checkbox"/> 1 2 3 4 5 6 7 8	Indirizzo: 14 ON <input type="checkbox"/> <input type="checkbox"/> <input type="checkbox"/> <input type="checkbox"/> <input type="checkbox"/> <input type="checkbox"/> <input type="checkbox"/> <input type="checkbox"/> 1 2 3 4 5 6 7 8	Indirizzo: 15 ON <input type="checkbox"/> <input type="checkbox"/> <input type="checkbox"/> <input type="checkbox"/> <input type="checkbox"/> <input type="checkbox"/> <input type="checkbox"/> <input type="checkbox"/> 1 2 3 4 5 6 7 8	Indirizzo: 16 ON <input type="checkbox"/> <input type="checkbox"/> <input type="checkbox"/> <input type="checkbox"/> <input type="checkbox"/> <input type="checkbox"/> <input type="checkbox"/> <input type="checkbox"/> 1 2 3 4 5 6 7 8	
Indirizzo: 17 ON <input type="checkbox"/> <input type="checkbox"/> <input type="checkbox"/> <input type="checkbox"/> <input type="checkbox"/> <input type="checkbox"/> <input type="checkbox"/> <input type="checkbox"/> 1 2 3 4 5 6 7 8	Indirizzo: 18 ON <input type="checkbox"/> <input type="checkbox"/> <input type="checkbox"/> <input type="checkbox"/> <input type="checkbox"/> <input type="checkbox"/> <input type="checkbox"/> <input type="checkbox"/> 1 2 3 4 5 6 7 8	Indirizzo: 19 ON <input type="checkbox"/> <input type="checkbox"/> <input type="checkbox"/> <input type="checkbox"/> <input type="checkbox"/> <input type="checkbox"/> <input type="checkbox"/> <input type="checkbox"/> 1 2 3 4 5 6 7 8	Indirizzo: 20 ON <input type="checkbox"/> <input type="checkbox"/> <input type="checkbox"/> <input type="checkbox"/> <input type="checkbox"/> <input type="checkbox"/> <input type="checkbox"/> <input type="checkbox"/> 1 2 3 4 5 6 7 8	
Indirizzo: 21 ON <input type="checkbox"/> <input type="checkbox"/> <input type="checkbox"/> <input type="checkbox"/> <input type="checkbox"/> <input type="checkbox"/> <input type="checkbox"/> <input type="checkbox"/> 1 2 3 4 5 6 7 8	Indirizzo: 22 ON <input type="checkbox"/> <input type="checkbox"/> <input type="checkbox"/> <input type="checkbox"/> <input type="checkbox"/> <input type="checkbox"/> <input type="checkbox"/> <input type="checkbox"/> 1 2 3 4 5 6 7 8	Indirizzo: 23 ON <input type="checkbox"/> <input type="checkbox"/> <input type="checkbox"/> <input type="checkbox"/> <input type="checkbox"/> <input type="checkbox"/> <input type="checkbox"/> <input type="checkbox"/> 1 2 3 4 5 6 7 8	Indirizzo: 24 ON <input type="checkbox"/> <input type="checkbox"/> <input type="checkbox"/> <input type="checkbox"/> <input type="checkbox"/> <input type="checkbox"/> <input type="checkbox"/> <input type="checkbox"/> 1 2 3 4 5 6 7 8	
Indirizzo: 25 ON <input type="checkbox"/> <input type="checkbox"/> <input type="checkbox"/> <input type="checkbox"/> <input type="checkbox"/> <input type="checkbox"/> <input type="checkbox"/> <input type="checkbox"/> 1 2 3 4 5 6 7 8	Indirizzo: 26 ON <input type="checkbox"/> <input type="checkbox"/> <input type="checkbox"/> <input type="checkbox"/> <input type="checkbox"/> <input type="checkbox"/> <input type="checkbox"/> <input type="checkbox"/> 1 2 3 4 5 6 7 8	Indirizzo: 27 ON <input type="checkbox"/> <input type="checkbox"/> <input type="checkbox"/> <input type="checkbox"/> <input type="checkbox"/> <input type="checkbox"/> <input type="checkbox"/> <input type="checkbox"/> 1 2 3 4 5 6 7 8	Indirizzo: 28 ON <input type="checkbox"/> <input type="checkbox"/> <input type="checkbox"/> <input type="checkbox"/> <input type="checkbox"/> <input type="checkbox"/> <input type="checkbox"/> <input type="checkbox"/> 1 2 3 4 5 6 7 8	
Indirizzo: 29 ON <input type="checkbox"/> <input type="checkbox"/> <input type="checkbox"/> <input type="checkbox"/> <input type="checkbox"/> <input type="checkbox"/> <input type="checkbox"/> <input type="checkbox"/> 1 2 3 4 5 6 7 8	Indirizzo: 30 ON <input type="checkbox"/> <input type="checkbox"/> <input type="checkbox"/> <input type="checkbox"/> <input type="checkbox"/> <input type="checkbox"/> <input type="checkbox"/> <input type="checkbox"/> 1 2 3 4 5 6 7 8	Indirizzo: 31 ON <input type="checkbox"/> <input type="checkbox"/> <input type="checkbox"/> <input type="checkbox"/> <input type="checkbox"/> <input type="checkbox"/> <input type="checkbox"/> <input type="checkbox"/> 1 2 3 4 5 6 7 8	Indirizzo: 32 ON <input type="checkbox"/> <input type="checkbox"/> <input type="checkbox"/> <input type="checkbox"/> <input type="checkbox"/> <input type="checkbox"/> <input type="checkbox"/> <input type="checkbox"/> 1 2 3 4 5 6 7 8	

■ Esempio

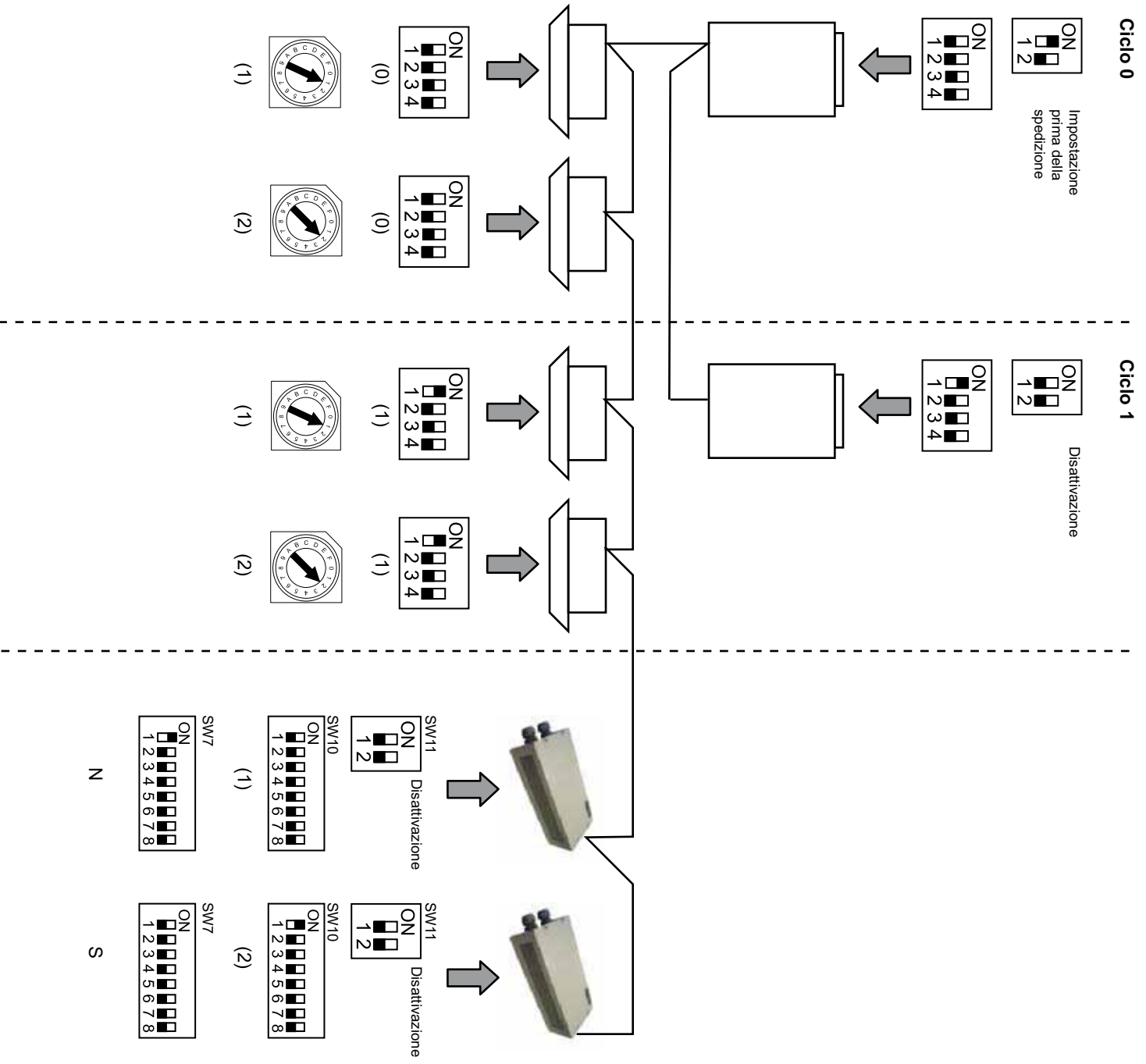

6. Funzionamento

6.1 PACKAGED: Dati disponibili

Indirizzo (Nota 1)	Nome	Descrizione	Letture/Scrittura
0	EXIST	EXIST: 0: Non esiste 1: Esiste	Letture
1	SYSTEM_ADDRESS	Indirizzo sistema: Da 0 a 15 in H-LINK 1	Letture
2	UNIT_ADDRESS	Indirizzo unità: Da 0 a 15 in H-LINK 1	Letture
3	SET_ONOFF	Ordine acceso/spento: 0: Arresto 1: Esecuzione	Letture/Scrittura
4	SET_MODE	Ordine impostazione modalità: 0: Freddo 2: Ventola 3: Caldo 4: Auto	Letture/Scrittura
5	SET_FAN	Ordine impostazione ventola: 0: Bassa 2: Alta 1: Media	Letture/Scrittura
6	SET_TSET	Impostazione temperatura: da 17 °C a 30 °C	Letture/Scrittura
7	SET_LOUVER	Impostazione feritoia: da 0 a 8 (8 è Auto)	Letture/Scrittura
8	SET_CENTRAL	Impostazione centrale Bit 0: On/Off (può essere sempre arrestato) Bit 1: Modalità Bit 2: Temperatura impostazione Bit 3: Ventola	Letture/Scrittura
9	READ_ONOFF	Letture On/Off: 0: Off 1: On	Letture
10	READ_MODE	Modo Lettura 0: Freddo 2: Ventola 3: Caldo 4: Auto	Letture
11	READ_FAN	Letture Ventola 0: Bassa 2: Alta 1: Media	Letture
12	READ_TSET	Letture temperatura impostazione (da 17 °C a 30 °C)	Letture
13	READ_LOUVER	Letture feritoia da 0 a 8 (8 è Auto)	Letture
14~18	(Non utilizzato)	(Non utilizzato)	(Non utilizzato)
19	ERROR_CODE	Codice allarme	Letture
20~21	(Non utilizzato)	(Non utilizzato)	(Non utilizzato)
22	OPER_CONDITION	Condizione funzionamento unità 0: OFF 2: Richiesta termica ON 1: Richiesta Termica OFF 3: Allarme	Letture
23-31	(Non utilizzato)	(Non utilizzato)	(Non utilizzato)

Nota 1: La posizione di compensazione è: 20000 + N°32 + Indirizzo come mostrato nella tabella, dove N è l'indirizzo unità interna.

■ Metodo di configurazione

Ogni HARC-MODBUS può controllare fino a 32 unità interne, considerando che nello stesso H-LINK possono essere collegate fino a 138 unità interne, devono essere impostate le unità interne selezionate per ogni HARC-MODBUS.

Questa configurazione non è richiesta nel caso dell'applicazione CHILLER.

Il principio di impostazione consiste in una tabella "d" contenente fino a 32 numeri per l'assegnazione di ciascun indirizzo UE+UI come mostrato di seguito:

Id	Indirizzo ciclo di refrigerazione	Indirizzo unità interna
00	00	00
01	00	01
02	00	02
03	00	03
04	00	04
05	00	05
06	00	06
07	00	07
08	00	08
09	00	09
10	00	10
11	00	11
12	00	12
13	00	13
14	00	14
15	00	15

Id	Indirizzo ciclo di refrigerazione	Indirizzo unità interna
16	01	00
17	01	01
18	01	02
19	01	03
20	01	04
21	01	05
22	01	06
23	01	07
24	01	08
25	01	09
26	01	10
27	01	11
28	01	12
29	01	13
30	01	14
31	01	15



Nota:

- È possibile selezionare per 1 HARC-MODBUS fino a 32 unità interne da 16 cicli refrigeranti differenti o 32 unità interne dallo stesso ciclo refrigerante.



Attenzione:

- Non impostare la stessa unità interna su più di un HARC-MODBUS. Questo errore non può essere rilevato e può provocare funzionamenti non desiderati.

N.	Azione	Display a 7 segmenti	Note
1	Premere SW4 durante 3 secondi	ld	Modalità di configurazione selezionata
2	Premere SW4	00	Selezione Id (N, UI) da 0 a 31 premendo SW5 ▲ o SW6 ▼
3	Premere SW4	all	Indirizzo ciclo di refrigerazione
4	Premere SW4	--->00	Selezione dell'indirizzo del ciclo di refrigerazione da 0 a 15 (ad es. 00) (premendo SW5 ▲ e SW6 ▼)
5	Premere SW4	ll	Indirizzo unità interna
6	Premere SW4	--->00	Selezione dell'indirizzo dell'unità interna da 0 a 15 (ad es. 00) (premendo SW5 ▲ e SW6 ▼)
Per "ld" 01 ripetere i passi da 1 a 6			
7	Premere SW4 durante 3 secondi	ld	Modalità di configurazione selezionata
8	Premere SW4	00->01	Selezione Id (N, UI) da 0 a 31 premendo SW5 ▲ o SW6 ▼
9	Premere SW4	all	Indirizzo ciclo di refrigerazione
10	Premere SW4	--->00	Selezione dell'indirizzo del ciclo di refrigerazione da 0 a 15 (ad es. 00) (premendo SW5 ▲ e SW6 ▼)
11	Premere SW4	ll	Indirizzo unità interna
12	Premere SW4	--->01	Selezione dell'indirizzo dell'unità interna da 0 a 15 (ad es. 01; premere SW5 una volta) (premendo SW5 ▲ e SW6 ▼)
... Ripetere i passi da 1 a 6 per gli altri "ld"			
187	Premere SW4 durante 3 secondi	ld	Modalità di configurazione selezionata
188	Premere SW4	00->31	Selezione Id (N, UI) da 0 a 31 premendo SW5 ▲ o SW6 ▼
189	Premere SW4	all	Indirizzo ciclo di refrigerazione
190	Premere SW4	--->01	Selezione dell'indirizzo del ciclo di refrigerazione da 0 a 15 (ad es. 01; premere SW5 una volta) (premendo SW5 ▲ e SW6 ▼)
191	Premere SW4	ll	Indirizzo unità interna
192	Premere SW4	--->15	Selezione dell'indirizzo dell'unità interna da 0 a 15 (ad es. 15; premere SW6 una volta) (premendo SW5 ▲ e SW6 ▼)

6.2 CHILLER: Dati disponibili

Indirizzo	Nome	Descrizione	Valori	Letture/ Scrittura
0	EXIST	Esiste	0: Non esiste 1: Esiste	Letture
1	SYSTEM_ADDRESS	Indirizzo Chiller (Non utilizzato)	Da 0 a 15 in H-LINK 1 (Non utilizzato)	Letture (Non utilizzato)
2	ONOFF_SET	Ordine acceso/spento:	0: Arresto 1: Avvio	Letture/ Scrittura
3	MODE_SET	Ordine impostazione modalità	0: Freddo 1: Caldo	Letture/ Scrittura
4	TEMP_SET_C	Impostazione temperatura COOL	(vedere nota *)	Letture/ Scrittura
5	TEMP_SET_H	Impostazione temperatura HEAT		
6	CENTRAL_SET	Impostazione centrale	0: Locale 1: Remoto	Letture/ Scrittura
7	ONOFF_STATUS	Stato ACCESO/SPENTO	0: Off 1: On	Letture
8	MODE_STATUS	Stato modalità	0: Freddo 1: Caldo	Letture
9	TEMP_C_STATUS	Stato impostazione temperatura COOL		Letture
10	TEMP_H_STATUS	Stato impostazione temperatura HEAT		Letture
11	WATER_INLET	Temperatura ingresso		Letture
12	WATER_OUTLET	Temperatura uscita		Letture
13	AMBIENT_TEMPERATURE	Temperatura ambiente		Letture
14	OPER_CONDITION	Condizione funzionamento unità	0: OFF 1: Richiesta Termica OFF	Letture
15			2: Richiesta termica ON 3: Allarme	
16	ERROR_CODE_CH	Codice allarme per allarme generale CHILLER		Letture
17~22	ERROR_CODE_CYC	Codice allarme per allarme ciclo (1-6)		Letture
23~31				(Non utilizzato)

**Note:**

- La posizione di compensazione è: $40000 + N*32 + \text{Indirizzo come mostrato nella tabella, dove } N \text{ è l'indirizzo refrigeratore d'acqua.}$
- I parametri Status (valore reale) e Set (valore ordinato) hanno solitamente lo stesso valore ma talvolta alcuni di essi possono avere valori differenti. Si consiglia di utilizzare i parametri Set per un controllo normale.
- *)Quando l'impostazione della temperatura e la modalità di funzionamento sono modificate contemporaneamente, ordinare prima la modifica della modalità di funzionamento e in seguito impostare la temperatura desiderata.

6.3 Elenco codici di allarme per CHILLER

6.3.1 Elenco codici allarmi CHILLER

Allarme CHILLER		Descrizione	H-LINK
7SEG1	7SEG2		Codice
11	11	Guasto termistore temperatura ingresso acqua	20
12	12	Guasto termistore temperatura uscita acqua (solo per unità a ciclo singolo)	21
22	22	Guasto al termistore della temperatura ambiente (aperto/controlcircuito)	24
5P	5P	Nessun feedback dalla pompa dell'acqua	26
13	13	Attivazione controllo di protezione antigelo (solo per unità a ciclo singolo)	27
6C	6C	Allarme per guasto idraulico (Interruttore differenziale per la pressione o regolatore del flusso (optional) - Condensatore	28
6E	6E	Allarme per guasto idraulico (Interruttore differenziale per la pressione o regolatore del flusso (optional) - Evaporatore	29
14	14	Attivazione del termostato per temperatura dell'acqua eccessivamente elevata (solo per unità a ciclo singolo)	30
RP	RP	Attivazione del dispositivo di protezione aggiuntivo	31
05	05	Irregolarità di fase	32
CP	CP	Errore di comunicazione tra PCB di controllo (PCB _{cr} , PCB _{cs2})	33
03	03	Errore di comunicazione tra refrigeratore e controllo remoto (H-LINK)	34
EU	EU	Errore di comunicazione tra valvola di espansione PCB e comando PCB	36
40	40	Funzionamento anomalo	40-45, 47,47,54

6.3.2 Elenco codici allarmi ciclo

Allarme ciclo		Descrizione	H-LINK
7SEG1	7SEG2		Codice
L _n	H _n	Attivazione dell'interruttore di alta pressione	1
L _n	L _n	Attivazione del dispositivo di controllo bassa pressione	2
L _n	H _n	Attivazione del termostato interno del compressore	3
L _n	B _n	Attivazione del termistore del gas di scarico	4
L _n	S _n	Attivazione del relè termico del compressore o Cattivo funzionamento del relè ausiliare ARrn	5
L _n	F ₀	Impostazione errata del numero della ventola	6
L _n	Y _n	Attivazione del termostato interno al motore della ventola	7
L _n	L _n	Pressione eccessivamente bassa	8
L _n	Y _n	Bassa temperatura eccessiva in ingresso refrigerante al raffreddatore	10
L _n	Z _n	Guasto al sensore per il rilevamento della pressione del gas di scarico (aperto/cortocircuitato)	11
L _n	Z _B	Guasto al sensore per il rilevamento della pressione del gas di aspirazione (aperto/cortocircuitato)	12
L _n	I ₂	Guasto termistore temperatura uscita acqua (per unità non a ciclo singolo)	14
L _n	Z ₃	Guasto al termistore del gas di scarico (aperto/cortocircuitato)	15
L _n	Z ₆	Guasto al termistore del gas di aspirazione (aperto/cortocircuitato)	16
L _n	O ₅	Irregolarità di fase	17
L _n	Z ₁	Guasto al termistore del refrigerante di ingresso nel raffreddatore (aperto/cortocircuitato)	19
L _n	L _n	Attivazione del termistore del gas di aspirazione	20
L _n	I ₃	Attivazione controllo di protezione antigelo (per unità non a ciclo singolo)	21
L _n	Z ₄	Guasto al gruppo termistore prima della valvola di espansione (aperto/cortocircuitato)	23
L _n	Z ₅	Guasto al termistore della temperatura di uscita dell'acqua - Retro refrigeratore (aperto/cortocircuitato)	24
F _n	S ₁	Alimentazione inverter anomala	34

7. Risoluzione dei problemi

N.	Codice allarme	Descrizione	Provvedimento
1	EE → B 1	Le unità interne non comunicano con HARC-MODBUS da più di 10 minuti	<ol style="list-style-type: none"> 1. Verificare che la connessione H-LINK sia correttamente impostata in HARC (K1) e anche nelle unità interne. 2. Verificare che i condizionatori d'aria siano alimentati.
2	EE → B3	Non vi mai stata comunicazione tra le unità interne e HARC-MODBUS	<ol style="list-style-type: none"> 1. Verificare che la connessione H-LINK sia correttamente impostata in HARC (K1) e anche nelle unità interne. 2. Verificare che i condizionatori d'aria siano alimentati.
3	D7 è sempre OFF	Nessun LED lampeggiante su PCB e 7 segmenti sono OFF	<p> Note:</p> <ul style="list-style-type: none"> - Il segnale di uscita dell'alimentazione è dotato di un commutatore rotante che deve essere impostato correttamente per ottenere +5 V c.c. - D7 deve essere ON.
4	D12 non lampeggia mai	HARC-MODBUS non legge/invia dati (D12 non lampeggia mai)	<ol style="list-style-type: none"> 1. Controllare la connessione tra i dispositivi MODBUS e K5.
5	D12 non lampeggia	HARC non funziona (D13 non lampeggia)	<ol style="list-style-type: none"> 1. Controllare che SW3 sia in posizione RUN. In caso contrario, impostare RUN e premere Reset.
6	D4 e D11 non lampeggiano	Nessuna comunicazione di H-LINK da HARC-MODBUS	<ol style="list-style-type: none"> 1. D4 lampeggia ma non D11. → Vedere riga N. 6, provvedimento 1. 2. D4 e D11 non lampeggiano. → Vedere riga N. 3, provvedimento 1.

Índice

1.	Resumo da segurança	84
2.	Nomes dos componentes	84
3.	Especificações	85
4.	Trabalho de instalação	86
4.1	Dados dimensionais	86
4.2	Aperto	86
5.	Ligações eléctricas	87
5.1	Ligações eléctricas	87
5.2	Ajuste do micro interruptor	88
6.	Funcionamento	92
6.1	PACKAGED: Dados disponíveis	92
6.2	CHILLER: Dados disponíveis	95
6.3	Lista de códigos de alarme de CHILLER	96
6.3.1	Lista de códigos de alarme de CHILLER	96
6.3.1	Lista de códigos de alarme de ciclo	97
7.	Resolução de problemas	98

**Nota:**

Este manual proporciona informação básica acerca da instalação e das ligações do HARC-MODBUS.

1. Resumo da segurança



Cuidado:

Não ligue a entrada de tensão ao sistema de controlo antes da instalação estar correctamente executada.

Leia cuidadosamente este manual antes de executar o trabalho de instalação.

Leia este manual a fim de configurar o HARC-MODBUS.



Atenção:

Instale o HARC-MODBUS longe de possíveis fontes de ondas electromagnéticas.

Respeite as normas eléctricas locais.

Utilize um circuito de alimentação que não esteja sujeito a picos de solicitação.

Assegure que existe espaço livre suficiente em torno do HARC-MODBUS (veja a figura) para que o calor se possa dissipar adequadamente (consulte "Trabalho de instalação").

Se instalar o HARC-MODBUS em posição vertical, instale a fonte de alimentação na parte inferior.

- Atenção:**
- Não instale o HARC-MODBUS em locais... :
- com vapores, óleos ou líquidos dispersos.
 - com fontes de calor na proximidade (ambientes sulfúricos).
 - onde tiver sido detectada acumulação, geração ou fuga de gases inflamáveis.
 - perto do mar, em ambientes salinos, ácidos ou alcalinos.

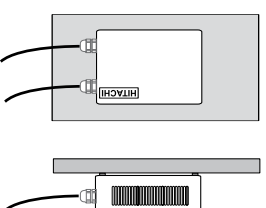

2. Nomes dos componentes

A figura mostra os nomes dos componentes do HARC-MODBUS.

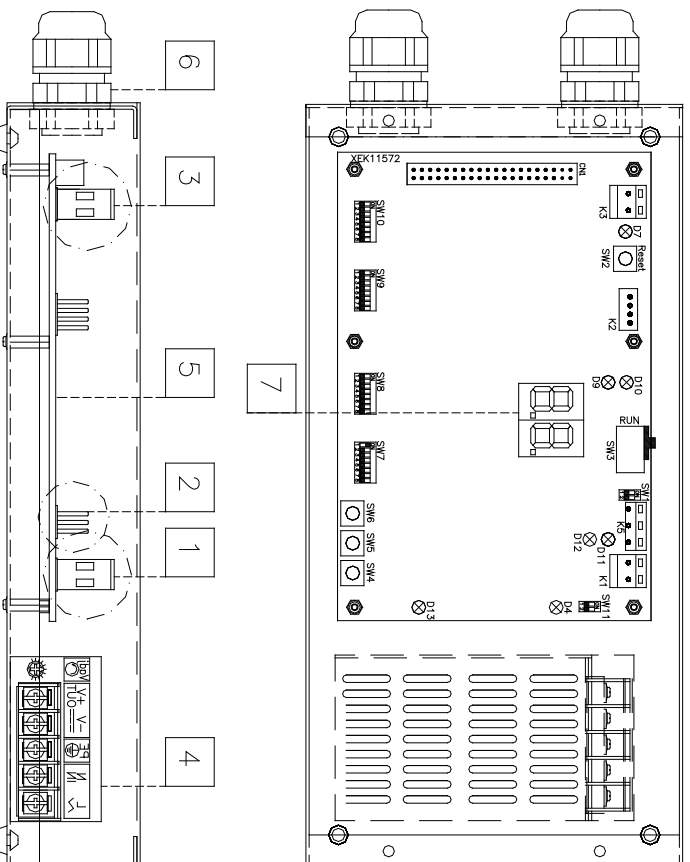

- 1 K1: Conector H-LINK:
Ligado ao CSNET WEB
- 2 K5: Porta série RS485
- 3 K3: Ligação de energia +5V CC
- 4 Fonte de alimentação:
230 V CA / 5 V CC
- 5 PCB do H-LINK
- 6 Bucins (2)
- 7 Segmentos

3. Especificações

Especificações de hardware

Item	Especificações
Fonte de alimentação	1~230 V \pm 10% 50 Hz
Consumo	25 W (máximo)
Dimensões exteriores	Largura: 143 mm, Profundidade: 302 mm, Altura: 76 mm
Peso	1,75 kg
Condições de montagem	No interior (num painel de controlo ou numa secretária)
Temperatura ambiente	0~40 °C
Humidade	20~85% (não condensada)

MODBUS - Comunicação com sistema superior

Item	Especificações
K5	Porta série RS485 (conector com 3 pinos) - Protocolo MODBUS
Linha de comunicação	Cabo torcido de dois condutores. Polaridade
Sistema de comunicações	Ligação série, multiponto, half-duplex
Método de comunicação	Sem paridade ou selecção de paridade ímpar/par. Comprimento dos dados: 8 bits (consulte o capítulo 5)
Velocidade de transmissão	19200/9600 Bauds (consulte o capítulo 5)
Comprimento	máx. de 1200 m, segundo EIA-485

H-LINK - Comunicação com unidades

Item	Especificações
Comunicação com	HITACHI PACKAGED/CHILLER
Linha de comunicação	Cabo torcido blindado com dois condutores, sem polaridade
Sistema de comunicações	Half-duplex
Método de comunicação	Assíncrona
Velocidade de transmissão	9600 Bauds
Comprimento da cablagem	1000 m, no máximo (comprimento total do bus do HLINK I/O)
Número máximo de HARC-MODBUS	8 HARC-MODBUS/SISTEMA H-LINK (PACKAGED) 1 HARC-MODBUS/SISTEMA H-LINK (CHILLER)



Atención:

O HARC-MODBUS não pode comandar unidades interiores sem um controlo remoto ligado.

4. Trabalho de instalação

Ao desembalar o HARC-MODBUS, verifique se este não sofreu quaisquer danos durante o transporte.

4.1 Dados dimensionais

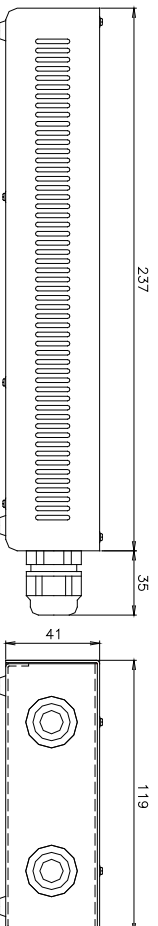

4.2 Aperto

Execute o seguinte procedimento:

- 1 Remova os suportes em borracha.
- 2 Desaparafuse os 4 parafusos da tampa superior e remova-a.
- 3 Fixe a caixa à placa vertical traseira, a partir do lado de dentro, com parafusos M4 (não fornecidos) e coloque anilhas de 3 mm no exterior, para separar a caixa da parede.
- 4 Volte a montar a tampa superior. Verifique que a tampa ficou montada correctamente.
- 5 Assegure uma zona livre para ventilação e ligação de cabos.

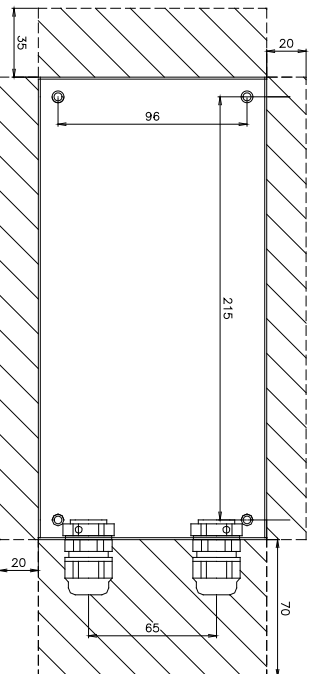

⚠️ Atenção:

- Antes de ligar a alimentação eléctrica e ligar o HARC-MODBUS, é necessário assegurar que:

1. Todos os circuitos estão correctamente ligados.
2. Todas as ligações do H-Link estão configuradas.
3. Foram cumpridos os regulamentos locais para a instalação eléctrica do HARC-MODBUS e dos circuitos associados.

Ao ligar o HARC-MODBUS, qualquer unidade que não esteja ligada não será reconhecida e terá que ser configurada posteriormente.

⚠️ Cuidado:

- Os cabos de sinais devem ser o mais curtos possível. Assegure que os cabos ficam instalados com uma distância maior que 150 mm em relação aos cabos de alimentação. Não os monte juntos (embora possam existir intersecções). Se for necessário instalá-los juntos, tome as seguintes medidas para evitar ruído:

- Proteja o cabo de sinal com um tubo metálico, ligado à terra numa das extremidades.
- Para as comunicações, utilize cabo blindado com uma das extremidades ligada à terra.

⚠️ Perigo:

- Desligue sempre a fonte de alimentação do HARC-MODBUS antes de manipular a máquina, a fim de evitar choques eléctricos.

- Não ligue a interface à fonte de alimentação, antes da instalação estar terminada.

- Cumpra rigorosamente as normas locais de segurança ao ligar a máquina à rede eléctrica.
- Necessitará de um cabo com três condutores (dois condutores mais terra), com uma ficha adequada numa das extremidades.

5. Ligações eléctricas

5.1 Ligações eléctricas

Para que possa funcionar, o HARC-MODBUS tem que estar ligado aos sinais correspondentes de entrada e saída, aos cabos de alimentação e ao H-LINK.

N.º	Ligação	Especificações de cabo
1	Circuito de alimentação 1~ 230 V 50 Hz 25 W (com circuito de protecção)	Seleccione os cabos de acordo com os regulamentos locais (1,5 mm ² H05RN-F é o mínimo recomendado)
2	MODBUS	Cabo com bainha e 3 condutores de 0,75 mm ² (tipo H05RN-F). Os isolamentos dos condutores devem ter cores diferentes. (Porta série RS485)
3	H-LINK	Os cabos de comunicação para ligação do HARC-MODBUS a uma instalação Hitachi, via CSNET WEB ou qualquer unidade Hitachi, devem utilizar os mesmos terminais do H-LINK Cabo torcido blindado com dois condutores, 0,75 mm ² (TIPO H05RN-F) A blindagem deve estar ligada à terra numa das extremidades
4	Fonte de alimentação das PCB +5 V CC. Imáx = 5 A CC	Cabo com dois condutores, 0,75 mm ² (TIPO H05RN-F)



Nota:

Todos os cabos, excepto 4 não são fornecidos.

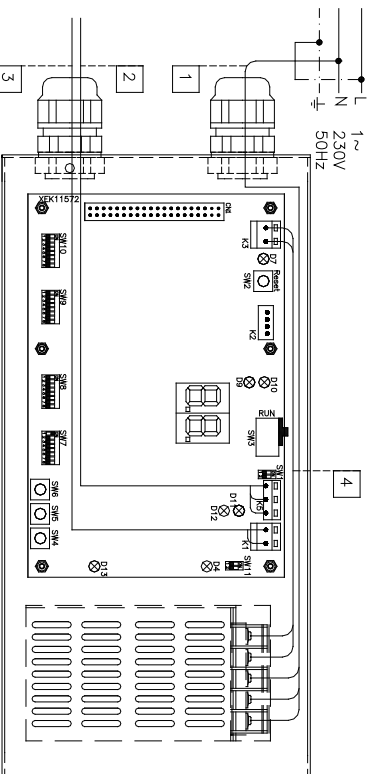

Protecções não fornecidas:

CB/EF: 5 A

ELB: 2/40 A / 30 mA

CB: Disjuntor

EF: Fusível eléctrico

ELB: Disjuntor de fuga de terra

5.2 Ajuste do micro interruptor

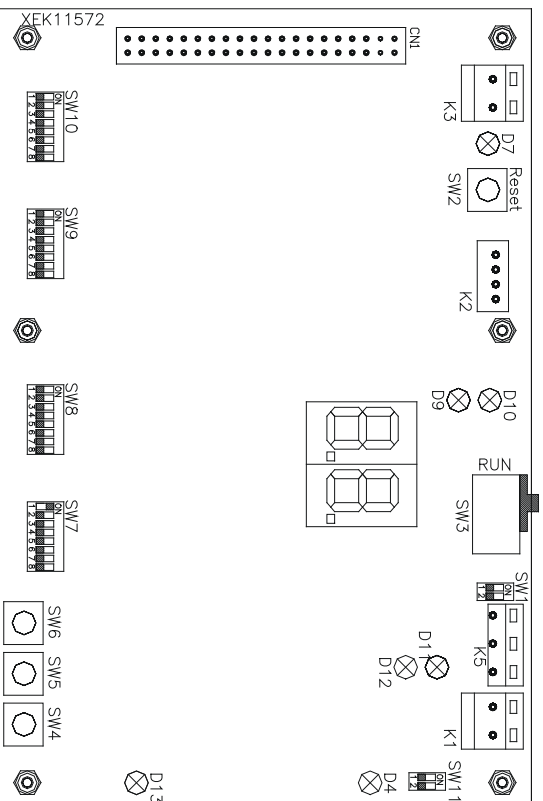

Nome	Função	Ajuste de fábrica	Descrição
SW1	Não disponível	ON 1 2	Todos em OFF (sem função)
SW2	Inicializar	-	Botão Reset (inicializar). Para ser utilizado se o programa estiver bloqueado
SW3 (TELE)	Não disponível	RUN	Para utilização na fábrica. Nunca deve ser alterado
SW4	Configuração	-	Funções para ajuste
SW5	Configuração	-	Funções para ajuste
SW6	Configuração	-	Funções para ajuste
SW7	Opções 2	ON 1 2 3 4 5 6 7 8	SW7-1: OFF - SLAVE / ON - MASTER. Para ser utilizado no caso de existirem vários HARC-MODBUS no mesmo endereço H-LINK SW7-2: OFF - CONTROLO DE EVENTOS/ON - ALTERAR CONTROLO SW7-3: OFF - Paridade desactivada / ON - Paridade activada SW7-4: OFF - Paridade par / ON - Paridade ímpar SW7-5: OFF - 19200 Bps / ON - 9600 Bps SW7-(6~8): Não utilizado
SW8	Opções 1 (tipo de aplicação)	ON 1 2 3 4 5 6 7 8	SW8-1: OFF-PACKAGED / ON-CHILLER. Para ser ajustado conforme a aplicação da unidade SW8-2~8: Não utilizado
SW9	Não disponível	ON 1 2 3 4 5 6 7 8	Todos em OFF (sem função)
SW10	Endereço de HARC MODBUS	ON 1 2 3 4 5 6 7 8	Endereço de HARC-MODBUS entre 1 e 32, mediante os pinos 1 a 5
SW11	Micro interruptor do H-LINK	ON 1 2	Micro interruptor com 2 pinos SW11-1: Resistência final do H-LINK SW11-2: Protecção com fusível do H-LINK
D4, D11	H-LINK	-	Transmissão do H-LINK
D7	Alimentação	-	LIG./DES. fonte de alimentação
D9/D10	Não utilizado	-	-
D12	MODBUS	-	Comunicação de MODBUS em RS485
D13	Funcionamento	-	Funcionamento normal do software

■ SW7 – AJUSTE DE FUNÇÕES 1

SW7	Descrição
<p>Configuração como MASTER/SLAVE:</p> <p>MASTER: SW7-1 = ON</p> <p>Apenas um HARC-MODBUS pode ser ajustado como MASTER HARC-MODBUS</p> <p>Ajuste predefinido</p> <p>SLAVE: SW7-1 = OFF</p> <p>Apenas deverá existir 1 HARC-MODBUS configurado como MASTER; todos os restantes HARC-MODBUS têm que estar configurados como SLAVE no mesmo H-LINK</p>	<p>Configuração como MASTER/SLAVE:</p> <p>MASTER: SW7-1 = ON</p> <p>Apenas um HARC-MODBUS pode ser ajustado como MASTER HARC-MODBUS</p> <p>Ajuste predefinido</p> <p>SLAVE: SW7-1 = OFF</p> <p>Apenas deverá existir 1 HARC-MODBUS configurado como MASTER; todos os restantes HARC-MODBUS têm que estar configurados como SLAVE no mesmo H-LINK</p>
<p>Modo de actualização de dados</p> <p>Configuração como EVENT CONTROL: SW7-2: OFF</p> <p>Os parâmetros da unidade interior são actualizados sempre que o BMS escreve um parâmetro de ajuste (mesmo que não tenha sido alterado nenhum valor). Ajuste predefinido</p> <p>Configuração como CHANGE CONTROL: SW7-2: ON</p> <p>Os parâmetros da unidade interior apenas são actualizados quando for alterado algum valor</p>	<p>Modo de actualização de dados</p> <p>Configuração como EVENT CONTROL: SW7-2: OFF</p> <p>Os parâmetros da unidade interior são actualizados sempre que o BMS escreve um parâmetro de ajuste (mesmo que não tenha sido alterado nenhum valor). Ajuste predefinido</p> <p>Configuração como CHANGE CONTROL: SW7-2: ON</p> <p>Os parâmetros da unidade interior apenas são actualizados quando for alterado algum valor</p>
<p>Configuração de paridade</p> <p>SW7-3: DESLIGAR: Sem configuração de paridade</p> <p>SW7-3: LIGAR: Paridade de comunicação (consulte a configuração de SW7-4 para informações sobre o tipo de paridade)</p>	<p>Configuração de paridade</p> <p>SW7-3: DESLIGAR: Sem configuração de paridade</p> <p>SW7-3: LIGAR: Paridade de comunicação (consulte a configuração de SW7-4 para informações sobre o tipo de paridade)</p>
<p>Configuração do tipo de paridade</p> <p>SW7-4: DESLIGAR: Paridade par (se o SW7-3 estiver em ON)</p> <p>SW7-4: LIGAR: Paridade ímpar (se o SW7-3 estiver em ON)</p>	<p>Configuração do tipo de paridade</p> <p>SW7-4: DESLIGAR: Paridade par (se o SW7-3 estiver em ON)</p> <p>SW7-4: LIGAR: Paridade ímpar (se o SW7-3 estiver em ON)</p>
<p>Velocidade de transmissão para comunicação</p> <p>SW7-5: OFF 19200 Bps</p> <p>SW7-5: ON 9600 Bps</p>	<p>Velocidade de transmissão para comunicação</p> <p>SW7-5: OFF 19200 Bps</p> <p>SW7-5: ON 9600 Bps</p>

■ SW8 – AJUSTE DE FUNÇÕES 2

SW8	Descrição
<p>Configuração para aplicações PACKAGED / CHILLER</p> <p>Aplicações PACKAGED: SW8-1: OFF</p> <p>Aplicações CHILLER: SW8-1: ON (ligado)</p>	<p>Configuração para aplicações PACKAGED / CHILLER</p> <p>Aplicações PACKAGED: SW8-1: OFF</p> <p>Aplicações CHILLER: SW8-1: ON (ligado)</p>

■ SW10 – Endereço de HARC em H-LINK (o mesmo conceito de unidade exterior/endereço de ciclo de refrigeração)

SW10				Descrição
Endereço: 1 ON 1 2 3 4 5 6 7 8	Endereço: 2 ON 1 2 3 4 5 6 7 8	Endereço: 3 ON 1 2 3 4 5 6 7 8	Endereço: 4 ON 1 2 3 4 5 6 7 8	<p>Configuração de endereço de HARC</p> <p>Endereço de HARC-MODBUS utilizado pelo sistema MODBUS</p> <p>Os pinos 1~5 do SW10 têm que ser ajustados de acordo com o desenho correspondente do endereço desejado</p> <p>Os pinos 6~8 do SW10 têm que ser ajustados em OFF</p>
Endereço: 5 ON 1 2 3 4 5 6 7 8	Endereço: 6 ON 1 2 3 4 5 6 7 8	Endereço: 7 ON 1 2 3 4 5 6 7 8	Endereço: 8 ON 1 2 3 4 5 6 7 8	
Endereço: 9 ON 1 2 3 4 5 6 7 8	Endereço: 10 ON 1 2 3 4 5 6 7 8	Endereço: 11 ON 1 2 3 4 5 6 7 8	Endereço: 12 ON 1 2 3 4 5 6 7 8	
Endereço: 13 ON 1 2 3 4 5 6 7 8	Endereço: 14 ON 1 2 3 4 5 6 7 8	Endereço: 15 ON 1 2 3 4 5 6 7 8	Endereço: 16 ON 1 2 3 4 5 6 7 8	
Endereço: 17 ON 1 2 3 4 5 6 7 8	Endereço: 18 ON 1 2 3 4 5 6 7 8	Endereço: 19 ON 1 2 3 4 5 6 7 8	Endereço: 20 ON 1 2 3 4 5 6 7 8	
Endereço: 21 ON 1 2 3 4 5 6 7 8	Endereço: 22 ON 1 2 3 4 5 6 7 8	Endereço: 23 ON 1 2 3 4 5 6 7 8	Endereço: 24 ON 1 2 3 4 5 6 7 8	
Endereço: 25 ON 1 2 3 4 5 6 7 8	Endereço: 26 ON 1 2 3 4 5 6 7 8	Endereço: 27 ON 1 2 3 4 5 6 7 8	Endereço: 28 ON 1 2 3 4 5 6 7 8	
Endereço: 29 ON 1 2 3 4 5 6 7 8	Endereço: 30 ON 1 2 3 4 5 6 7 8	Endereço: 31 ON 1 2 3 4 5 6 7 8	Endereço: 32 ON 1 2 3 4 5 6 7 8	

■ Exemplo

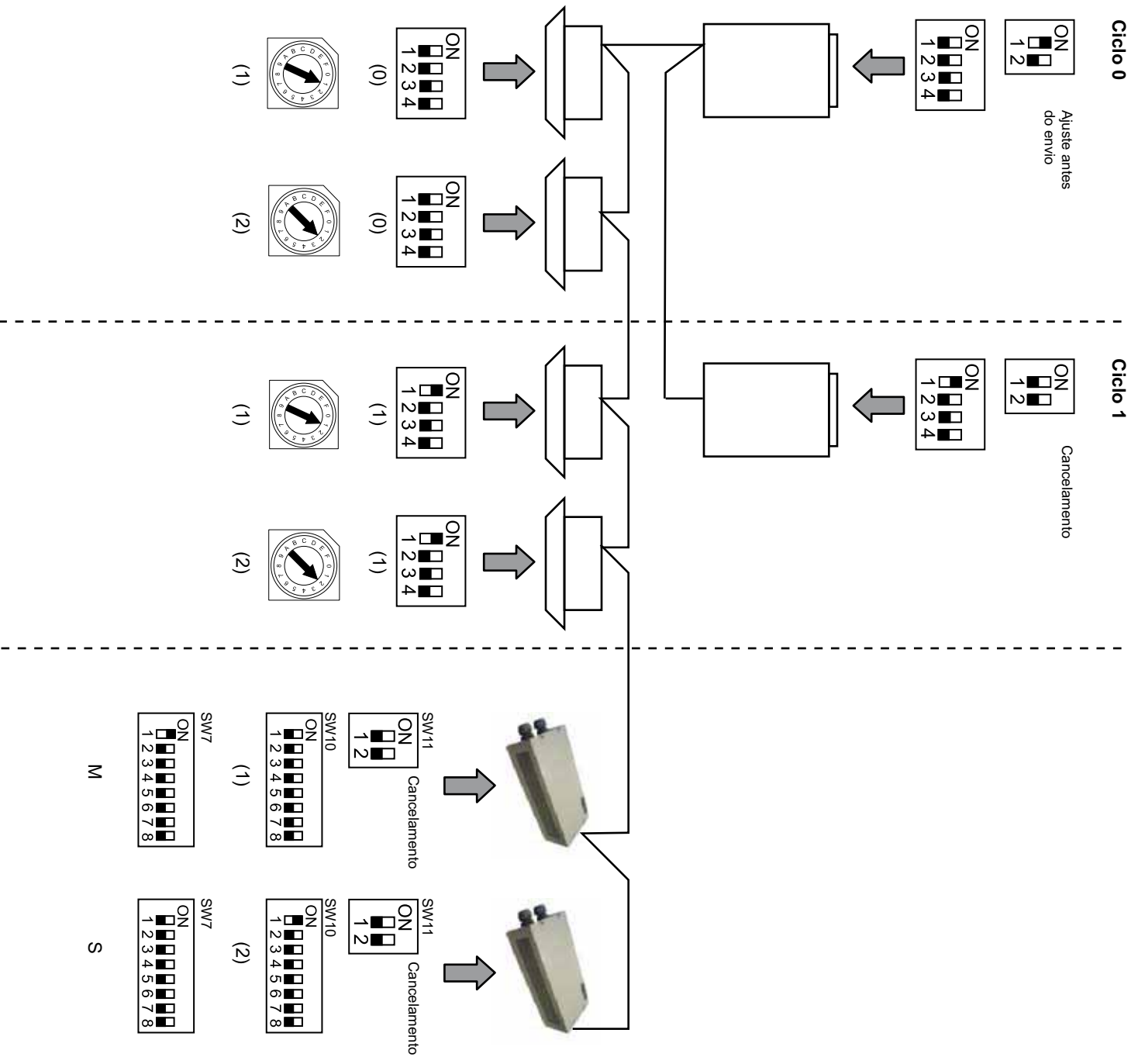

6. Funcionamento

6.1 PACKAGED: Dados disponíveis

Endereço (Nota 1)	Nome	Descrição	Ler/Escriver
0	EXIST	EXIST: 0: Não existe 1: Existe	Ler
1	SYSTEM_ADDRESS	Endereço de sistema: 0 ~ 15 no H-LINK 1	Ler
2	UNIT_ADDRESS	Endereço de unidade: 0 ~ 15 no H-LINK 1	Ler
3	SET_ONOFF	Ordem de ajuste para Ligar/Desligar: 0: Stop (parar) 1: Funcionamento	Ler/Escriver
4	SET_MODE	Ordem de modo de ajuste: 0: Arrefecimento 2: Ventilador 3: Aquecimento 4: Automático	Ler/Escriver
5	SET_FAN	Ordem de ajuste de ventilador: 0: Baixa 1: Média 2: Alta	Ler/Escriver
6	SET_TSET	Ajuste de temperatura: 17~30 °C	Ler/Escriver
7	SET_LOUVER	Ajuste do deflector: 0~8 (8 corresponde a Automático)	Ler/Escriver
8	SET_CENTRAL	Ajuste Central Bit 0: Ligar/Desligar (pode sempre ser parado) Bit 1: Modo Bit 2: Ajuste de temperatura Bit 3: Ventilador	Ler/Escriver
9	READ_ONOFF	Ligar/Desligar Leitura: 0: Des. 1: Lig.	Ler
10	READ_MODE	Leitura de modo 0: Arrefecimento 2: Ventilador 3: Aquecimento 4: Automático	Ler
11	READ_FAN	Leitura de ventilação 0: Baixa 1: Média 2: Alta	Ler
12	READ_TSET	Leitura de ajuste de temperatura (17 a 30 °C)	Ler
13	READ_LOUVER	Leitura de deflector 0~8 (8 corresponde a Automático)	Ler
14~18	(não utilizado)	(não utilizado)	(não utilizado)
19	ERROR_CODE	Código de alarme	Ler
20~21	(não utilizado)	(não utilizado)	(não utilizado)
22	OPER_CONDITION	Condição de funcionamento da unidade 0: OFF 1: Termóstato OFF 2: Termóstato ON 3: Alarme	Ler
23~31	(não utilizado)	(não utilizado)	(não utilizado)

Nota 1: A diferença de posição é: 20000 + N°32 + Endereço, como se apresenta na tabela, onde N é o endereço de unidade interior.

■ Método de configuração

Cada HARC-MODBUS pode controlar até 32 unidades interiores; considerando que cada H-LINK pode estar ligado a até 128 unidades interiores, é necessário ajustar quais são as unidades interiores seleccionadas para cada HARC-MODBUS.

Esta configuração não é necessária no caso de aplicação CHILLER.

O conceito de ajuste consiste numa tabela de "id" que lista até 32 números para atribuição de cada um dos endereços de unidade exterior + unidade interior, como se mostra a seguir:

Id	Endereço de ciclo de refrigeração	Endereço de unidade interior
00	00	00
01	00	01
02	00	02
03	00	03
04	00	04
05	00	05
06	00	06
07	00	07
08	00	08
09	00	09
10	00	10
11	00	11
12	00	12
13	00	13
14	00	14
15	00	15

Id	Endereço de ciclo de refrigeração	Endereço de unidade interior
16	01	00
17	01	01
18	01	02
19	01	03
20	01	04
21	01	05
22	01	06
23	01	07
24	01	08
25	01	09
26	01	10
27	01	11
28	01	12
29	01	13
30	01	14
31	01	15



Nota:

- Podem ser seleccionadas até 32 unidades interiores para 1 HARC-MODBUS de 16 ciclos de refrigeração diferentes ou 32 unidades interiores do mesmo ciclo de refrigeração.



Cuidado:

- Tenha cuidado para não ajustar a mesma unidade interior para mais do que um HARC-MODBUS. Este erro não é detectado automaticamente e pode provocar mau funcionamento.

N.º	Ação	7 segmentos (visor)	Observações
1	Prima o SW4 durante 3 segundos	id	Modo de configuração seleccionado
2	Prima SW4	00	Seleccção de id (N.º de unidade interior) entre 0 e 31, premiando SW5 ▲ ou SW6 ▼
3	Prima SW4	01	Endereço de ciclo de refrigeração
4	Prima SW4	---→00	Seleccção de endereço de ciclo de refrigeração entre 0 e 15 (por exemplo, 00) (premiando SW5 ▲ e SW6 ▼)
5	Prima SW4	11	Endereço de unidade interior
6	Prima SW4	---→00	Seleccção de endereço de unidade interior entre 0 e 15 (por exemplo, 00) (premiando SW5 ▲ e SW6 ▼)
Para "id" 01 repita os passos 1 até 6			
7	Prima o SW4 durante 3 segundos	id	Modo de configuração seleccionado
8	Prima SW4	00→01	Seleccção de id (N.º de unidade interior) entre 0 e 31, premiando SW5 ▲ ou SW6 ▼
9	Prima SW4	01	Endereço de ciclo de refrigeração
10	Prima SW4	---→00	Seleccção de endereço de ciclo de refrigeração entre 0 e 15 (por exemplo, 00) (premiando SW5 ▲ e SW6 ▼)
11	Prima SW4	11	Endereço de unidade interior
12	Prima SW4	---→01	Seleccção de endereço de unidade interior entre 0 e 15 (por exemplo, 01; prima SW5 uma vez) (premiando SW5 ▲ e SW6 ▼)
... Repita os passos 1 a 6 para todos os "id" restantes			
187	Prima o SW4 durante 3 segundos	id	Modo de configuração seleccionado
188	Prima SW4	00→31	Seleccção de id (N.º de unidade interior) entre 0 e 31, premiando SW5 ▲ ou SW6 ▼
189	Prima SW4	01	Endereço de ciclo de refrigeração
190	Prima SW4	---→01	Seleccção de endereço de ciclo de refrigeração entre 0 e 15 (por exemplo, 01; prima SW5 uma vez) (premiando SW5 ▲ e SW6 ▼)
191	Prima SW4	11	Endereço de unidade interior
192	Prima SW4	---→15	Seleccção de endereço de unidade interior entre 0 e 15 (por exemplo, 15; prima SW6 uma vez) (premiando SW5 ▲ e SW6 ▼)

6.2 CHILLER: Dados disponíveis

Endereço	Nome	Descrição	Valores	Ler/Escrever
0	EXIST	Existe	0: Não existe 1: Existe	Ler
1	SYSTEM_ADDRESS	Endereço do refrigerador	0-15 no H-LINK 1	Ler
2	(não utilizado)	(não utilizado)	(não utilizado)	(não utilizado)
3	ONOFF_SET	Ordem de ajuste para Ligar/Desligar.	0: Stop (parar) 1: Funcionamento	Ler/Escrever
4	MODE_SET	Ordem de modo de ajuste	0: Arrefecimento 1: Aquecimento	Ler/Escrever
5	TEMP_SET_C	Ajuste de temperatura de COOL (arrefecimento);	(ver nota*)	Ler/Escrever
6	TEMP_SET_H	Ajuste de temperatura de HEAT (aquecimento)		
7	CENTRAL_SET	Ajuste Central	0: Local 1: Remoto	Ler/Escrever
8	ONOFF_STATUS	Estado LIG./DES.	0: Des. 1: Lg.	Ler
9	MODE_STATUS	Estado de modo	0: Arrefecimento 1: Aquecimento	Ler
10	TEMP_C_STATUS	Estado de ajuste de temperatura de COOL (arrefecimento)		Ler
11	TEMP_H_STATUS	Estado de ajuste de temperatura de HEAT (aquecimento)		Ler
12	WATER_INLET	Temperatura de entrada		Ler
13	WATER_OUTLET	Temperatura de saída		Ler
14	AMBIENT_TEMPERATURE	Temperatura ambiente		Ler
15	OPER_CONDITION	Condição de funcionamento da unidade	0: OFF 1: Termóstato OFF 2: Termóstato ON 3: Alarme	Ler
16	ERROR_CODE_CH	Código de alarme para alarme geral de CHILLER		Ler
17~22	ERROR_CODE_CYC	Código de alarme para alarme de ciclo (1~6)		Ler
23~31	(não utilizado)	(não utilizado)	(não utilizado)	(não utilizado)



Notas:

- A diferença de posição é: $40000 + N \times 32 + \text{Endereço}$, como se apresenta na tabela, onde N é o endereço do refrigerador de água.
- Os parâmetros de Estado (valor real) e Ajuste (valor solicitado) têm, normalmente, o mesmo valor, mas, em alguns casos, alguns valores podem ser diferentes. Recomendamos utilizar Ajustar parâmetros para controlo normal.
- *) Quando pretender alterar simultaneamente o Ajuste de temperatura e o Modo de funcionamento, primeiro deve ser alterado o modo de funcionamento e, apenas depois, o ajuste de temperatura.

6.3 Lista de códigos de alarme de CHILLER

6.3.1 Lista de códigos de alarme de CHILLER

Alarme de CHILLER		Descrição	H-LINK
7SEG1	7SEG2		Código
11	11	Falha do termistor de temperatura de entrada de água	20
12	12	Falha do termistor de temperatura de saída de água (apenas para unidade com ciclo único)	21
22	22	Falha do termistor de temperatura ambiente (aberto/curto)	24
5P	5P	Nenhum sinal de resposta da bomba de água	26
13	13	Ativação do controlo de protecção de congelação (apenas para unidade com ciclo único)	27
6E	6E	Alarme de falha de água (pressostato diferencial ou opção de fluxostato) - Condensador	28
6E	6E	Alarme de falha de água (pressostato diferencial ou opção de fluxostato) - Evaporador	29
14	14	Ativação de termóstato para temperatura de água excessivamente elevada (apenas para unidades com ciclo único)	30
RP	RP	Ativação do dispositivo de protecção adicional	31
05	05	Anomalia de fase	32
CP	CP	Erro de comunicação entre PCB de controlo (PCB _{cr1} , PCB _{cr2})	33
03	03	Erro de comunicação entre o refrigerador e o controlo remoto (H-LINK)	34
EU	EU	Erro comunicação entre a PCB da válvula de expansão e a PCB de controlo	36
40	40	Operação incorrecta	40~45, 47,47,54

6.3.1 Lista de códigos de alarme de ciclo

Alarme de Ciclo		Descrição	H-LINK
7SEG1	7SEG2		Código
Ln	Hn	Ativação do pressostato de alta pressão	1
Ln	Ln	Ativação do controlo de baixa pressão	2
Ln	7n	Ativação do termostato interno do compressor	3
Ln	5n	Ativação do termistor de descarga de gás	4
Ln	5n	Ativação do relé térmico do compressor ou falha do braço do relé auxiliar	5
Ln	F0	Ajuste incorrecto do número de ventilador	6
Ln	4n	Ativação do motor do ventilador do termostato interno	7
Ln	Ln	Excesso de baixa pressão	8
Ln	9n	Excesso de baixa temperatura de refrigerante à entrada radiador	10
Ln	27	Falha do sensor de pressão de descarga de gás (aberto/curto)	11
Ln	28	Falha do sensor de pressão de sucção de gás (aberto/curto)	12
Ln	12	Falha do termistor de temperatura de saída de água (apenas para unidade não ciclo único)	14
Ln	23	Falha do termistor de descarga de gás (aberto/curto)	15
Ln	26	Falha do termistor de sucção de gás (aberto/curto)	16
Ln	05	Anomalia de fase	17
Ln	21	Falha de termistor de refrigerante à entrada do refrigerador (aberto/curto)	19
Ln	6n	Ativação do termistor de sucção de gás	20
Ln	13	Ativação do controlo de protecção de congelação (apenas para unidade não ciclo único)	21
Ln	24	Falha de ajuste do termistor antes da válvula de expansão (aberto/curto)	23
Ln	25	Falha do termistor de saída de água - Lado posterior do refrigerador (aberto/curto)	24
Fn	51	Anomalia de fonte de alimentação do inversor	34

7. Resolução de problemas

N.º	Código de alarme	Descrição	Contramedida
1	EE→B!	As unidades interiores não comunicaram com o HARC-MODBUS durante mais de 10 min.	<ol style="list-style-type: none"> 1. Certifique-se de que a ligação ao H-LINK está efectuada correctamente no HARC (K1) e também nas unidades interiores. 2. Certifique-se de que as máquinas de ar condicionado têm alimentação de energia eléctrica.
2	EE→B3	As unidades interiores nunca comunicaram com o HARC-MODBUS	<ol style="list-style-type: none"> 1. Certifique-se de que a ligação ao H-LINK está efectuada correctamente no HARC (K1) e também nas unidades interiores. 2. Certifique-se de que as máquinas de ar condicionado têm alimentação de energia eléctrica.
3	O D7 está sempre em OFF	Não existe nenhum LED a piscar na PCB e os 7 segmentos estão OFF	<p> Notas:</p> <ul style="list-style-type: none"> - O sinal de saída de CC da fonte de alimentação tem um comutador rotativo que tem que estar correctamente ajustado em +5 V CC. - O D7 tem que estar em ON.
4	O D12 nunca está a piscar	O HARC-MODBUS não está a ler/enviar dados (o D12 nunca está a piscar)	<ol style="list-style-type: none"> 1. Verifique a ligação entre os dispositivos MODBUS e K5.
5	O D12 não está a piscar	O HARC não está a funcionar (o D13 não está a piscar)	<ol style="list-style-type: none"> 1. Verifique se o SW3 está na posição RUN. No caso contrário, ajuste em RUN e prima RESET.
6	O D4 e o D11 não estão a piscar	Não existe comunicação com o H-LINK a partir do HARC-MODBUS	<ol style="list-style-type: none"> 1. O D4 está a piscar, mas o D11 não está a piscar. → Consulte a linha N.º 6, contramedida 1. 2. O D4 e o D11 não estão a piscar. → Consulte a linha N.º 3, contramedida 1.

Indhold

1.	Sikkerhedsoversigt _____	100
2.	Komponentnavne _____	100
3.	Specifikationer _____	101
4.	Monteringsarbejde _____	102
4.1	Mål _____	102
4.2	Fastgørelse _____	102
5.	Ledningsforbindelser _____	103
5.1	Elektrisk ledningsføring _____	103
5.2	Indstillinger for vippekontakter _____	104
6.	Drift _____	108
6.1	PACKAGED: Data tilgængelige _____	108
6.2	CHILLER: Data tilgængelige _____	111
6.3	Liste over alarmkode for CHILLER _____	112
6.3.1	Liste med CHILLER-alarmkode _____	112
6.3.2	Liste med kredsløbs-alarmkode _____	113
7.	Fejlfinding _____	114

**Bemærk:**

Denne vejledning indeholder grundlæggende oplysninger om montering og ledningsføring for HARC-MODBUS.

1. Sikkerhedsoversigt



Advarsel:

Tilslut ikke strøm til kontrolsystemet, før installationen er udført korrekt.

Læs denne vejledning grundigt før udførelse af monteringsarbejde.

Læs denne vejledning nøje, før du begynder at konfigurere HARC-MODBUS.



Bemærk:

Monter ikke HARC-MODBUS i nærheden af mulige kilder til elektromagnetiske bølger.

Overhold lokale elektricitetskrav.

Anvend en hovedstrømkreds, der ikke er underkastet spidsbelastninger.

Vær opmærksom på, at der skal være tilstrækkelig ledig plads rundt om HARC-MODBUS (se figur) til at varmen kan spredes på passende vis (se "Monteringsarbejde").

Hvis du installerer HARC-MODBUS i lodret position, skal du installere strømforsyningen i den nederste del.

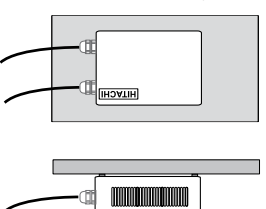

Bemærk:

Monter ikke HARC-MODBUS på steder :

- med damp, olie eller splidte væsker.
- med varmekilder i nærheden (svoilsure områder).
- hvor der er konstateret akkumulering, dannelse eller lækager af brandbare gasser.
- der ligger i nærheden af havet, i saltholdige, sure eller basiske omgivelser.

2. Komponentnavne

I figuren vises navnene på HARC-MODBUS-komponenterne.

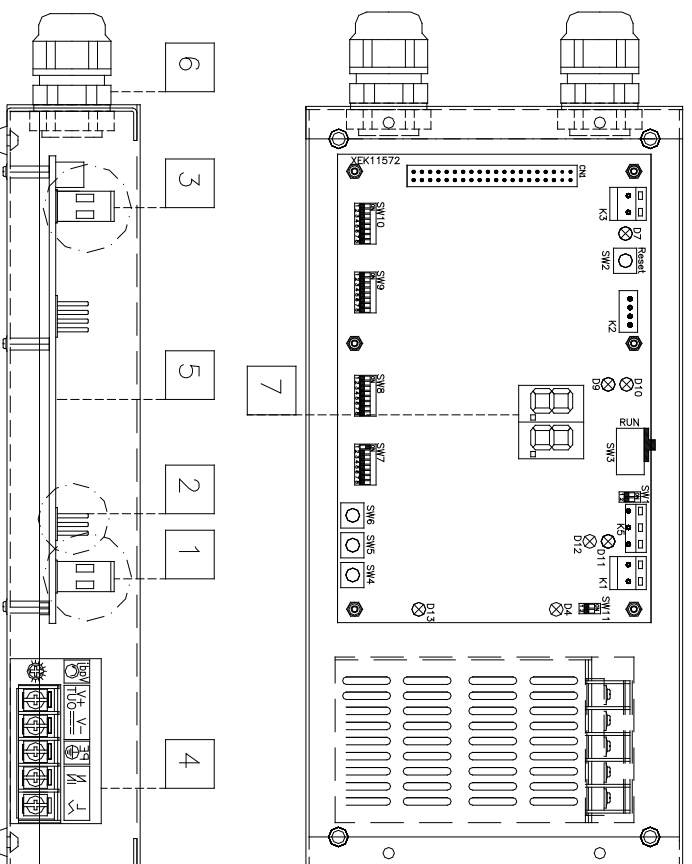

- 1 K1: H-LINK-stik:
- Tilsluttet til CSNET WEB
- 2 K5: Serial udgang RS485
- 3 K3: +5 V DC strømuttag
- 4 Strømkilde: 230 V AC / 5 V DC
- 5 H-LINK PCB
- 6 Pakninger (2)
- 7 7-delt indikator

3. Specifikationer

Hardwarespecifikationer

Punkt	Specifikationer
Strømforsyning	1~230 V ±10% 50 Hz
Forbrug	25 W (maks.)
Ydre mål	Bredde: 143 mm, Dybde: 302 mm, Højde: 76 mm
Vægt	1,75 kg
Monteringsforhold	Indendørs (i et kontrolpanel eller desktop)
Rumtemperatur	0~40 °C
Fugtighed	20~85% (Uden kondensation)

MODBUS - Kommunikation med øverste system

Punkt	Specifikationer
K5	Serial udgang RS485 (3-bens stik) - MODBUS-protokol
Kommunikationslinje	Parsoet kabel. Polartiet
Kommunikationssystem	Halv dupleks, multipunkts serial tilslutning
Kommunikationsmetode	Ingen paritet eller ulige/lige paritetsvalg. Datalængde: 8 bit (se kapitel 5)
Transmissionshastighed	19200/9600 bit (se kapitel 5)
Længde	maks. 1200 m i henhold til EIA-485

H-LINK - Kommunikation med enheder

Punkt	Specifikationer
Kommunikation med	HITACHI PACKAGED/CHILLER
Kommunikationslinje	Parsoet atskærmet kabel, ikke-polær
Kommunikationssystem	Halv dupleks
Kommunikationsmetode	Asynkron
Transmissionshastighed	9600 baud
Ledningslængde	Maks. 1000 m (samlet længde på HLINK I/O-skinne)
Højeste antal HARC MODBUS	8 HARC MODBUS-/H-LINK-SYSTEM (PACKAGED) 1 HARC MODBUS-/H-LINK-SYSTEM (CHILLER)



Bemærk:

HARC-MODBUS kan ikke fungere med indendørsenheder, hvis der ikke er tilsluttet nogen fjernbetjening.

4. Monteringsarbejde

Kontroller ved udpakning af HARC-MODBUS, at den ikke har lidt skade under transport.

4.1 Mål

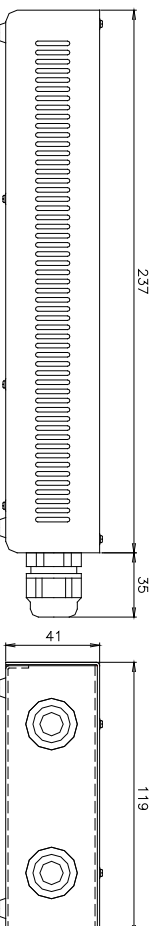

4.2 Fastgørelse

Følg nedenstående fremgangsmåde:

- 1 Fjern gummiunderstøtninger.
- 2 De 4 skruer løsnes fra toppækslet, som fjernes.
- 3 Monter boksen på den bagerste lodrette plade fra indersiden med M4-skruer (medfølger ikke), og anbring 3 mm skiver på ydersiden for at adskille boksen fra væggen.
- 4 Monter atter toppækslet. Vær opmærksom på, at det placeres korrekt.
- 5 Sørg for god plads omkring ventilationsåbningerne og kabelforbindelsen.

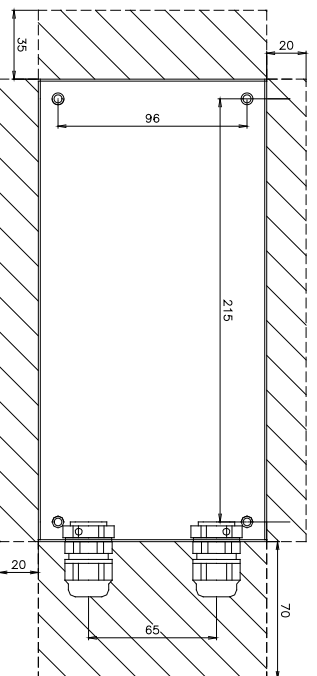

⚠ Bemærk:

- Inden der tændes for strømmen til HARC-MODBUS, sikres det at:
 1. Alle de nødvendige kredsløb er tilsluttet korrekt.
 2. Alle H-Link-forbindelser er blevet etableret.
 3. Overhold de lokale bestemmelser for elektrisk installationsarbejde, når HARC-MODBUS og de tilhørende kredsløb monteres.

Alle enheder, der ikke er tilsluttet eller ikke har strømtilførsel, når HARC-MODBUS slås til, vil ikke blive registreret og skal konfigureres senere.

⚠ Advarsel:

- Signalkablerne bør være så korte som muligt. Hold en afstand på over 150 mm fra andre strømkabler. Installer dem ikke sammen (omend de kan krydse hinanden). Hvis de nødvendigvis må installeres sammen, skal følgende forholdsregler tages for at undgå støj:
 - Beskyl signalkablet med et metalrør, der er forbundet til jord i den ene ende.
 - Til kommunikation anvendes et afskærmet kabel, der er forbundet til jord i den ene ende.

⚠ Fare:

- Afbryd altid strømforsyningen til HARC-MODBUS ved håndtering af apparatet for at undgå elektriske udladninger.
- Forbind ikke grænsefladen til strømforsyningen indtil monteringen er afsluttet.
- De lokale sikkerhedsregler skal strengt overholdes ved tilslutning af apparatet til elnettet.
- Der skal bruges et tre-trådet kabel (to kerner og jord) med et passende stik i den ene ende.

5. Ledningsforbindelser

5.1 Elektrisk ledningsføring

For at kunne fungere, skal HARC-MODBUS forbindes til de tilsvarende indgangs- og udgangssignaler, strømkabler og H-LINK.

Nr.	Forbindelse	Kabelspecifikationer
1	Strømkreds 1 ~ 230 V 50 Hz 25 W (Med kredsløbsbeskyttelse)	Vælg kabler, der overholder de lokale bestemmelser (anbefalet: min. 1,5 mm ² H05RN-F)
2	MODBUS	Ledningsnet med 3 stk. 0,75 mm ² ledninger (type H05RN-F). Brug forskellige farver til de forskellige ledninger. (Serial udgang RS485)
3	H-LINK	Kommunikationskabler til forbindelse af HARC-MODBUS til en Hitachi-installation, via CSNET WEB eller en hvilken som helst anden Hitachi-enhed, ved brug af de samme H-LINK-klemmer
4	PCB's strømforsyning +5 V DC. I _{max} = 5 A DC	Afskærmet parskoet 0,75 mm ² ledning (TYPE H05RN-F) Afskærminingen skal kun være jordet i den ene side Parskoet 0,75 mm ² ledning (TYPE H05RN-F).



Bemærk:

Alle ledninger, undtagen 4 leveres på stedet.

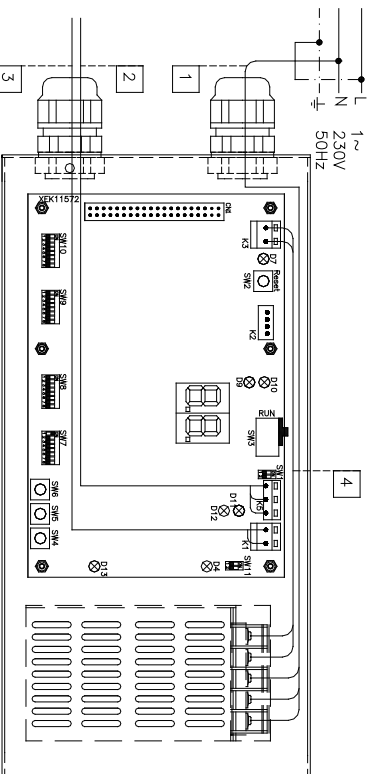

Ikke medfølgende beskyttelse:

CB/EF: 5 A

FSA: 2/40 A/30 mA

CB: Sikring

EF: Elektrisk sikring

FSA: Earth Leakage Breaker
(Føjstrømsafbryder)

5.2 Indstillinger for vippekontakter

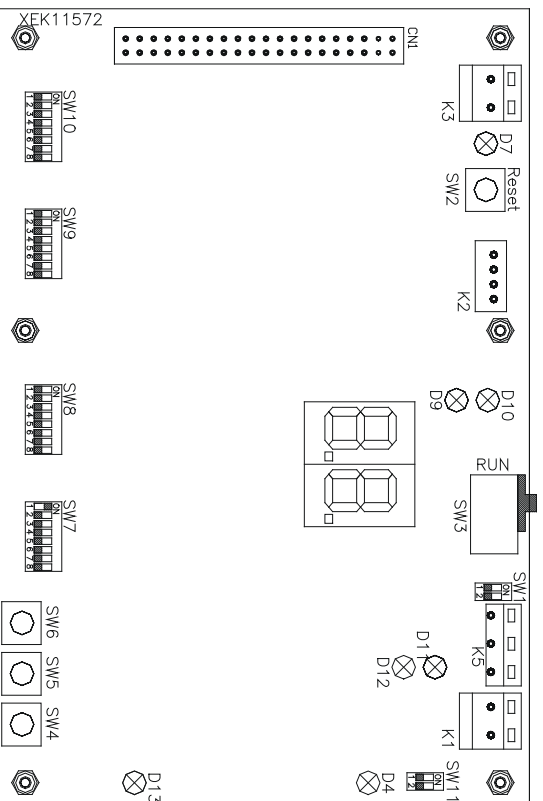

Navn	Funktion	Fabriksindstilling	Beskrivelse
SW1	Ikke tilgængelig	ON 1 2	Alle på Off (ingen funktion)
SW2	Nulstil	-	Nulstillingsknop. Anvendes ved blokering af programmet
SW3 (TELE)	Ikke tilgængelig	RUN	Fabriksformål. Må aldrig ændres
SW4	Konfiguration	-	Funktionsindstilling
SW5	Konfiguration	-	Funktionsindstilling
SW6	Konfiguration	-	Funktionsindstilling
SW7	Indstilling 2	ON 1 2 3 4 5 6 7 8	SW7-1: OFF-SLAVE/ON-MASTER. Anvendes i tilfælde af flere HARC-MODBUS på den samme H-LINK-adresse SW7-2: OFF-EVENT CONTROL/ON-CHANGE CONTROL SW7-3: OFF - Paritet deaktiveret / ON - Paritet aktiveret SW7-4: OFF - Lige deaktiveret / ON - Ulige aktiveret SW7-5: OFF - 19200 bit/sek / ON - 9600 bit/sek. SW7-(6~8): Ikke anvendt
SW8	Indstilling 1 (Programtype)	ON 1 2 3 4 5 6 7 8	SW8-1: OFF-PACKAGED/ON-CHILLER. Indstilles i henhold til enhedernes anvendelse SW8-2~8: Ikke anvendt
SW9	Ikke tilgængelig	ON 1 2 3 4 5 6 7 8	Alle på Off (ingen funktion)
SW10	HARC-MODBUS- adresse	ON 1 2 3 4 5 6 7 8	HARC-MODBUS-adresse fra 1 til 32 med kontakterne 1 til 5
SW11	H-LINK- vippekontakt	ON 1 2	2-bens-vippekontakt SW11-1: H-LINK's slutmodstand SW11-2: H-LINK's sikringsbeskyttelse
D4, D11	H-LINK	-	H-LINK-transmission
D7	Strøm	-	Strømforsyning ON/OFF
D9/D10	Ikke anvendt	-	-
D12	MODBUS	-	Modbus-kommunikation i RS485
D13	Drift	-	Normal softwaredrift

■ SW10 – HARC-adresse H-LINK (samme koncept som udendørsenhedens/kølekredsløbets adresse)

SW10				Beskrivelse
Adresse: 1 ON <input type="checkbox"/> <input type="checkbox"/> <input type="checkbox"/> <input type="checkbox"/> <input type="checkbox"/> <input type="checkbox"/> <input type="checkbox"/> <input type="checkbox"/> 1 2 3 4 5 6 7 8	Adresse: 2 ON <input type="checkbox"/> <input type="checkbox"/> <input type="checkbox"/> <input type="checkbox"/> <input type="checkbox"/> <input type="checkbox"/> <input type="checkbox"/> <input type="checkbox"/> 1 2 3 4 5 6 7 8	Adresse: 3 ON <input type="checkbox"/> <input type="checkbox"/> <input type="checkbox"/> <input type="checkbox"/> <input type="checkbox"/> <input type="checkbox"/> <input type="checkbox"/> <input type="checkbox"/> 1 2 3 4 5 6 7 8	Adresse: 4 ON <input type="checkbox"/> <input type="checkbox"/> <input type="checkbox"/> <input type="checkbox"/> <input type="checkbox"/> <input type="checkbox"/> <input type="checkbox"/> <input type="checkbox"/> 1 2 3 4 5 6 7 8	<p>Konfiguration af HARC-adresse</p> <p>HARC-MODBUS-adresse anvendes af MODBUS-system</p> <p>SW10 ben 1~4 skal indstilles i henhold til den tilsvarende tegning af den ønskede adresse</p> <p>SW10-ben 6-8 skal blive ved med at være indstillet til OFF</p>
Adresse: 5 ON <input type="checkbox"/> <input type="checkbox"/> <input type="checkbox"/> <input type="checkbox"/> <input type="checkbox"/> <input type="checkbox"/> <input type="checkbox"/> <input type="checkbox"/> 1 2 3 4 5 6 7 8	Adresse: 6 ON <input type="checkbox"/> <input type="checkbox"/> <input type="checkbox"/> <input type="checkbox"/> <input type="checkbox"/> <input type="checkbox"/> <input type="checkbox"/> <input type="checkbox"/> 1 2 3 4 5 6 7 8	Adresse: 7 ON <input type="checkbox"/> <input type="checkbox"/> <input type="checkbox"/> <input type="checkbox"/> <input type="checkbox"/> <input type="checkbox"/> <input type="checkbox"/> <input type="checkbox"/> 1 2 3 4 5 6 7 8	Adresse: 8 ON <input type="checkbox"/> <input type="checkbox"/> <input type="checkbox"/> <input type="checkbox"/> <input type="checkbox"/> <input type="checkbox"/> <input type="checkbox"/> <input type="checkbox"/> 1 2 3 4 5 6 7 8	
Adresse: 9 ON <input type="checkbox"/> <input type="checkbox"/> <input type="checkbox"/> <input type="checkbox"/> <input type="checkbox"/> <input type="checkbox"/> <input type="checkbox"/> <input type="checkbox"/> 1 2 3 4 5 6 7 8	Adresse: 10 ON <input type="checkbox"/> <input type="checkbox"/> <input type="checkbox"/> <input type="checkbox"/> <input type="checkbox"/> <input type="checkbox"/> <input type="checkbox"/> <input type="checkbox"/> 1 2 3 4 5 6 7 8	Adresse: 11 ON <input type="checkbox"/> <input type="checkbox"/> <input type="checkbox"/> <input type="checkbox"/> <input type="checkbox"/> <input type="checkbox"/> <input type="checkbox"/> <input type="checkbox"/> 1 2 3 4 5 6 7 8	Adresse: 12 ON <input type="checkbox"/> <input type="checkbox"/> <input type="checkbox"/> <input type="checkbox"/> <input type="checkbox"/> <input type="checkbox"/> <input type="checkbox"/> <input type="checkbox"/> 1 2 3 4 5 6 7 8	
Adresse: 13 ON <input type="checkbox"/> <input type="checkbox"/> <input type="checkbox"/> <input type="checkbox"/> <input type="checkbox"/> <input type="checkbox"/> <input type="checkbox"/> <input type="checkbox"/> 1 2 3 4 5 6 7 8	Adresse: 14 ON <input type="checkbox"/> <input type="checkbox"/> <input type="checkbox"/> <input type="checkbox"/> <input type="checkbox"/> <input type="checkbox"/> <input type="checkbox"/> <input type="checkbox"/> 1 2 3 4 5 6 7 8	Adresse: 15 ON <input type="checkbox"/> <input type="checkbox"/> <input type="checkbox"/> <input type="checkbox"/> <input type="checkbox"/> <input type="checkbox"/> <input type="checkbox"/> <input type="checkbox"/> 1 2 3 4 5 6 7 8	Adresse: 16 ON <input type="checkbox"/> <input type="checkbox"/> <input type="checkbox"/> <input type="checkbox"/> <input type="checkbox"/> <input type="checkbox"/> <input type="checkbox"/> <input type="checkbox"/> 1 2 3 4 5 6 7 8	
Adresse: 17 ON <input type="checkbox"/> <input type="checkbox"/> <input type="checkbox"/> <input type="checkbox"/> <input type="checkbox"/> <input type="checkbox"/> <input type="checkbox"/> <input type="checkbox"/> 1 2 3 4 5 6 7 8	Adresse: 18 ON <input type="checkbox"/> <input type="checkbox"/> <input type="checkbox"/> <input type="checkbox"/> <input type="checkbox"/> <input type="checkbox"/> <input type="checkbox"/> <input type="checkbox"/> 1 2 3 4 5 6 7 8	Adresse: 19 ON <input type="checkbox"/> <input type="checkbox"/> <input type="checkbox"/> <input type="checkbox"/> <input type="checkbox"/> <input type="checkbox"/> <input type="checkbox"/> <input type="checkbox"/> 1 2 3 4 5 6 7 8	Adresse: 20 ON <input type="checkbox"/> <input type="checkbox"/> <input type="checkbox"/> <input type="checkbox"/> <input type="checkbox"/> <input type="checkbox"/> <input type="checkbox"/> <input type="checkbox"/> 1 2 3 4 5 6 7 8	
Adresse: 21 ON <input type="checkbox"/> <input type="checkbox"/> <input type="checkbox"/> <input type="checkbox"/> <input type="checkbox"/> <input type="checkbox"/> <input type="checkbox"/> <input type="checkbox"/> 1 2 3 4 5 6 7 8	Adresse: 22 ON <input type="checkbox"/> <input type="checkbox"/> <input type="checkbox"/> <input type="checkbox"/> <input type="checkbox"/> <input type="checkbox"/> <input type="checkbox"/> <input type="checkbox"/> 1 2 3 4 5 6 7 8	Adresse: 23 ON <input type="checkbox"/> <input type="checkbox"/> <input type="checkbox"/> <input type="checkbox"/> <input type="checkbox"/> <input type="checkbox"/> <input type="checkbox"/> <input type="checkbox"/> 1 2 3 4 5 6 7 8	Adresse: 24 ON <input type="checkbox"/> <input type="checkbox"/> <input type="checkbox"/> <input type="checkbox"/> <input type="checkbox"/> <input type="checkbox"/> <input type="checkbox"/> <input type="checkbox"/> 1 2 3 4 5 6 7 8	
Adresse: 25 ON <input type="checkbox"/> <input type="checkbox"/> <input type="checkbox"/> <input type="checkbox"/> <input type="checkbox"/> <input type="checkbox"/> <input type="checkbox"/> <input type="checkbox"/> 1 2 3 4 5 6 7 8	Adresse: 26 ON <input type="checkbox"/> <input type="checkbox"/> <input type="checkbox"/> <input type="checkbox"/> <input type="checkbox"/> <input type="checkbox"/> <input type="checkbox"/> <input type="checkbox"/> 1 2 3 4 5 6 7 8	Adresse: 27 ON <input type="checkbox"/> <input type="checkbox"/> <input type="checkbox"/> <input type="checkbox"/> <input type="checkbox"/> <input type="checkbox"/> <input type="checkbox"/> <input type="checkbox"/> 1 2 3 4 5 6 7 8	Adresse: 28 ON <input type="checkbox"/> <input type="checkbox"/> <input type="checkbox"/> <input type="checkbox"/> <input type="checkbox"/> <input type="checkbox"/> <input type="checkbox"/> <input type="checkbox"/> 1 2 3 4 5 6 7 8	
Adresse: 29 ON <input type="checkbox"/> <input type="checkbox"/> <input type="checkbox"/> <input type="checkbox"/> <input type="checkbox"/> <input type="checkbox"/> <input type="checkbox"/> <input type="checkbox"/> 1 2 3 4 5 6 7 8	Adresse: 30 ON <input type="checkbox"/> <input type="checkbox"/> <input type="checkbox"/> <input type="checkbox"/> <input type="checkbox"/> <input type="checkbox"/> <input type="checkbox"/> <input type="checkbox"/> 1 2 3 4 5 6 7 8	Adresse: 31 ON <input type="checkbox"/> <input type="checkbox"/> <input type="checkbox"/> <input type="checkbox"/> <input type="checkbox"/> <input type="checkbox"/> <input type="checkbox"/> <input type="checkbox"/> 1 2 3 4 5 6 7 8	Adresse: 32 ON <input type="checkbox"/> <input type="checkbox"/> <input type="checkbox"/> <input type="checkbox"/> <input type="checkbox"/> <input type="checkbox"/> <input type="checkbox"/> <input type="checkbox"/> 1 2 3 4 5 6 7 8	

■ Eksempel

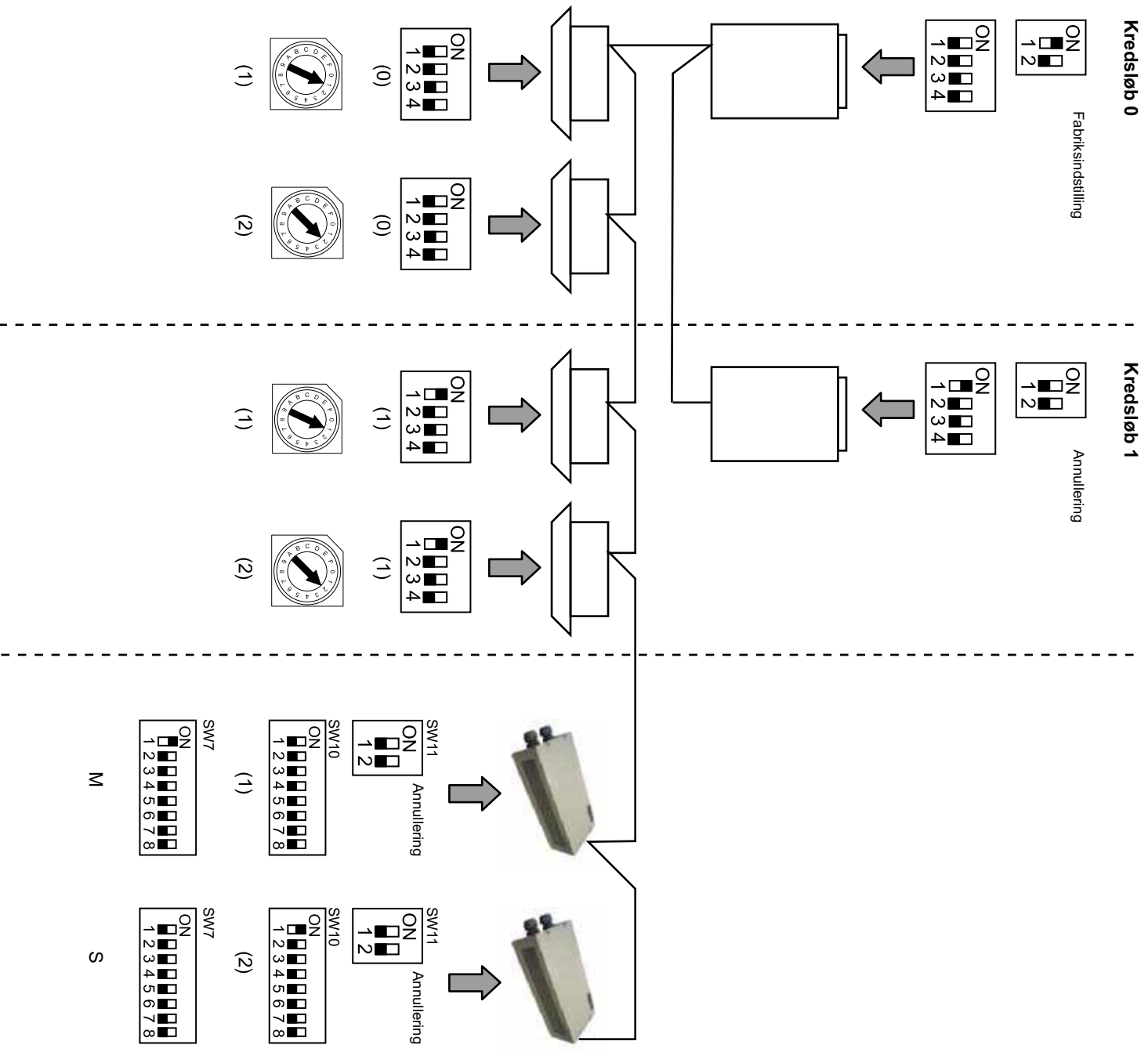

6. Drift

6.1 PACKAGED: Data tilgængelige

Adresse (Note 1)	Navn	Beskrivelse	Læs/Skriv
0	EXIST	EXIST: 0: Eksisterer ikke 1: Exist	Læs
1	SYSTEM_ADDRESS	Systemadresse: 0 ~ 15 i H-LINK 1	Læs
2	UNIT_ADDRESS	Enhedsadresse: 0 ~ 15 i H-LINK1	Læs
3	SET_ONOFF	On-/Off-indstillingens rækkefølge: 0: Stop 1: Run	Læs/Skriv
4	SET_MODE	Funktionsindstillingens rækkefølge: 0: Afkøling 2: Ventilation 3: Opvarmning 4: Auto. valg	Læs/Skriv
5	SET_FAN	Ventilatorindstillingens rækkefølge: 0: Lav 2: Høj 1: Mellem	Læs/Skriv
6	SET_TSET	Indstilling af temperatur: 17 °C ~ 30 °C	Læs/Skriv
7	SET_LOUVER	Indstilling af spjæld: 0 ~ 8 (8 er Auto.)	Læs/Skriv
8	SET_CENTRAL	Indstilling af centralenhed Bit 0: On/Off (kan altid stoppes) Bit 1: Tilstand Bit 2: Temperaturind. Bit 3: Ventilation	Læs/Skriv
9	READ_ONOFF	Læs On/Off: 0: Off 1: On	Læs
10	READ_MODE	Aftæsningsstilstand 0: Afkøling 2: Ventilation 4: Auto. valg 1: Tørring 3: Opvarmning	Læs
11	READ_FAN	Aftæsning af ventilatorstilstand 0: Lav 2: Høj 1: Mellem	Læs
12	READ_TSET	Aftæsning af temperaturindstilling (17 °C til 30 °C)	Læs
13	READ_LOUVER	Aftæsning af spjældstilstand 0 ~ 8 (8 er Auto.)	Læs
14~18	(Ikke anvendt)	(Ikke anvendt)	(Ikke anvendt)
19	ERROR_CODE	Alarmkode	Læs
20~21	(Ikke anvendt)	(Ikke anvendt)	(Ikke anvendt)
22	OPER_CONDITION	Enhedens driftstilstand 0: OFF 2: Thermo ON 1: Thermo OFF 3: Alarm	Læs
23~31	(Ikke anvendt)	(Ikke anvendt)	(Ikke anvendt)

Note 1: Offset-positionen er: 20000 + N*32 + adresse som vist i tabellen, hvor N er indendørsenhedens adresse.

■ Konfigurationsmetode

Hvert HARC-MODBUS-system kan styre op til 32 indendørsenheder, idet der kan tilsluttes op til 128 indendørsenheder til samme H-LINK. Det skal angives, hvilke indendørsenheder der vælges til de forskellige HARC-MODBUS-systemer.

Denne konfiguration er ikke nødvendig ved indstilling til CHILLER.

Indstillingskonceptet består af en "id"-tabel med op til 32 numre til tilknytning af adresserne for hver uendørsenhed/indendørsenhed som vist her:

Id	Kølekredsløbets adresse	Indendørsenhedens adresse
00	00	00
01	00	01
02	00	02
03	00	03
04	00	04
05	00	05
06	00	06
07	00	07
08	00	08
09	00	09
10	00	10
11	00	11
12	00	12
13	00	13
14	00	14
15	00	15

Id	Kølekredsløbets adresse	Indendørsenhedens adresse
16	01	00
17	01	01
18	01	02
19	01	03
20	01	04
21	01	05
22	01	06
23	01	07
24	01	08
25	01	09
26	01	10
27	01	11
28	01	12
29	01	13
30	01	14
31	01	15

 **Bemærk:** – Op til 32 indendørsenheder kan tilsluttes 1 HARC-MODBUS fra 16 forskellige kølekredsløb eller 32 indendørsenheder fra det samme kølekredsløb.

 **Forsigtig:** – Sørg for ikke at indstille den samme indendørsenhed til mere end én HARC-MODBUS. Denne fejl kan ikke opdages og kan resultere i uønskede hændelser.

Nr.	Handling	7-delt (display)	Bemærkninger
1	Tryk på SW4 i 3 sekunder	id	Konfigurationstilstand valgt
2	Tryk på SW4	00	Id-valg (IU-nr.) fra 0 til 31 ved at skubbe SW5 ▲ eller SW6 ▼
3	Tryk på SW4	all	Kølekrebsløbets adresse
4	Tryk på SW4	---→00	Kølekrebsløbets adressevalg fra 0 til 15 (f.eks. 00) (ved at skubbe SW5 ▲ og SW6 ▼)
5	Tryk på SW4	ll	Indendørsenhedens adresse
6	Tryk på SW4	---→00	Indendørsenhedens adressevalg fra 0 til 15 (f.eks. 00) (ved at skubbe SW5 ▲ og SW6 ▼)
For "id" 01 gentag trin 1 til 6			
7	Tryk på SW4 i 3 sekunder	id	Konfigurationstilstand valgt
8	Tryk på SW4	00→01	Id-valg (IU-nr.) fra 0 til 31 ved at skubbe SW5 ▲ eller SW6 ▼
9	Tryk på SW4	all	Kølekrebsløbets adresse
10	Tryk på SW4	---→00	Kølekrebsløbets adressevalg fra 0 til 15 (f.eks. 00) (ved at skubbe SW5 ▲ og SW6 ▼)
11	Tryk på SW4	ll	Indendørsenhedens adresse
12	Tryk på SW4	---→01	Indendørsenhedens adressevalg fra 0 til 15 (f.eks. 01, skub SW5 én gang) (ved at skubbe SW5 ▲ og SW6 ▼)
... Gentag trin 1 til 6 for alle resterende "id"			
187	Tryk på SW4 i 3 sekunder	id	Konfigurationstilstand valgt
188	Tryk på SW4	00→31	Id-valg (IU-nr.) fra 0 til 31 ved at skubbe SW5 ▲ eller SW6 ▼
189	Tryk på SW4	all	Kølekrebsløbets adresse
190	Tryk på SW4	---→01	Kølekrebsløbets adressevalg fra 0 til 15 (f.eks. 01, skub SW5 én gang) (ved at skubbe SW5 ▲ og SW6 ▼)
191	Tryk på SW4	ll	Indendørsenhedens adresse
192	Tryk på SW4	---→15	Indendørsenhedens adressevalg fra 0 til 15 (f.eks. 15, skub SW6 én gang) (ved at skubbe SW5 ▲ og SW6 ▼)

6.2 CHILLER: Data tilgængelige

Adresse	Navn	Beskrivelse	Værdier	Læs/Skriv
0	EXIST	Eksisterer	0: Eksisterer ikke 1: Eksisterer	Læs
1	SYSTEM_ADDRESS	Chiller-adresse	0~ 15 i H-LINK 1	Læs
2	(Ikke anvendt)	(Ikke anvendt)	(Ikke anvendt)	(Ikke anvendt)
3	ONOFF_SET	On-/Off-indstillingens rækkefølge:	0: Stop 1: Kør	Læs/Skriv
4	MODE_SET	Funktionsindstillingens rækkefølge	0: Afkøling 1: Opvarmning	Læs/Skriv
5	TEMP_SET_C	Valgt KØLE-temperatur	(se bemærkning *)	Læs/Skriv
6	TEMP_SET_H	Valgt OPVARMNINGS-temperatur		Læs/Skriv
7	CENTRAL_SET	Indstilling af centralenhed	0: Lokal 1: Fjern-	Læs/Skriv
8	ONOFF_STATUS	On/Off-status	0: Off 1: On	Læs
9	MODE_STATUS	Tilstandsstatus	0: Afkøling 1: Opvarmning	Læs
10	TEMP_C_STATUS	Status for valgt KØLE-temperatur		Læs
11	TEMP_H_STATUS	Status for valgt OPVARMNINGS-temperatur		Læs
12	WATER_INLET	Indløbsstemperatur		Læs
13	WATER_OUTLET	Udløbsstemperatur		Læs
14	AMBIENT_TEMPERATURE	Rumtemperatur		Læs
15	OPER_CONDITION	Enhedens drifttilstand	0: OFF 1: Thermo OFF 2: Thermo ON 3: Alarm	Læs
16	ERROR_CODE_CH	Alarmkode for generel CHILLER-alarm		Læs
17~22	ERROR_CODE_CYC	Alarmkode for kredsløbsalarm (1~6)		Læs
23~31	(Ikke anvendt)	(Ikke anvendt)	(Ikke anvendt)	(Ikke anvendt)

**Bemærkninger:**

- Offset-positionen er: 40000 + N*32 + adresse som vist i tabellen, hvor N er vand-chiller-adresse.
- Parametre for Status (virkelig værdi) og Indstillet (værdirækkefølge) har normalt samme værdi, men i nogle tilfælde kan nogle af dem være forskellige. Det anbefales at anvende Indstillet-parametre til normal kontrol.
- *) Hvis både temperaturindstillingen og driftstilstanden ændres, skal man begynde med at angive den ønskede driftstilstand og derefter angive temperaturen.

6.3 Liste over alarmkode for CHILLER

6.3.1 Liste med CHILLER-alarmkode

CHILLER-alarm		Beskrivelse	H-LINK
7SEG1	7SEG2		Kode
11	11	Fejl i termistor for vandets indløbstemperatur	20
12	12	Fejl i temperaturtermistor for vandafløb (kun for enhed med enkelt kredsløb)	21
22	22	Fejl i termistor for rumtemperatur (åben/kortslettet)	24
5P	5P	Inlet feedbacksignal fra vandpumpe	26
13	13	Aktivering af frostsikringskontrol (kun for enhed med enkelt kredsløb)	27
6C	6C	Alarm for vandfejil (differentialelektrykafbryder eller gennemstrømningskontakt)-kondensator	28
6E	6E	Alarm for vandfejil (differentialelektrykafbryder eller gennemstrømningskontakt)-fordamper	29
14	14	Aktivering af termostat for alt for høj vandtemperatur (Kun for enhed med enkelt kredsløb)	30
RP	RP	Aktivering af ekstra beskyttelsesenhed	31
05	05	Fejl i fase	32
CP	CP	Fejlkommunikation mellem kontrol-PCB (PCB _{G1} , PCB _{G2})	33
03	03	Kommunikationsfejil mellem køler og fjernbetjening (H-LINK)	34
EU	EU	Kommunikationsfejil mellem ekspansionsventil og PCB og kontrol-PCB	36
40	40	Forkert drift	40-45, 47,47,54

6.3.2 Liste med kredsløbs-alarmløse

Kredsløbsalarm		Beskrivelse	H-LINK
7SEG1	7SEG2		Kode
L _n	H _n	Aktivering af højtryksafbryder	1
L _n	L _n	Aktivering af beskyttelse af lavtrykskontrol	2
L _n	n _n	Aktivering af kompressorens interne termostat	3
L _n	b _n	Aktivering af udladningssagens termistor	4
L _n	S _n	Aktivering af varmerekø til kompressor eller fejlfunktion i hjælperæk ARm	5
L _n	F0	Forkert indstilling af ventilatornummer	6
L _n	4 _n	Aktivering af ventilatormotorens interne termostat	7
L _n	L _n	For lavt tryk	8
L _n	9 _n	For lav temperatur på kølerindløbet kølevæske	10
L _n	2 ₇	Fejl i udladningssagens tryksensor (åben/kortsluttet)	11
L _n	28	Fejl i sugegassens tryksensor (åben/kortsluttet)	12
L _n	12	Fejl i temperaturtermistor for vandtilførsel (til enheder med flere kredsløb)	14
L _n	23	Fejl ved gasudladningstermistor (åben/kortsluttet)	15
L _n	26	Fejl i sugegastermistor (åben/kortsluttet)	16
L _n	05	Fejl i fase	17
L _n	21	Fejl ved kølerindløbs kølemiddeltermistor (åben/kortsluttet)	19
L _n	b _n	Aktivering af sugegassens termistor	20
L _n	13	Aktivering af frostsikringskontrol (kun for enhed med enkelt kredsløb)	21
L _n	24	Fejl i termistor indstillet før ekspansionsventil (åben/kortsluttet)	23
L _n	25	Fejl ved vandtilførselstermistor - kølers bagside (åben/kortsluttet)	24
F _n	51	Fejl i inverterens strømforsyning	34

7. Fejlfinding

Nr.	Alarmkode	Beskrivelse	Forholdsregel
1		Indendørsenheder har ikke kommunikeret med HARC-MODBUS i mere end 10 minutter	<ol style="list-style-type: none"> Kontrollér, at H-LINK-tilslutning er korrekt udført i HARC (K1) og også indendørsenheder. Kontrollér, at airconditionenhederne får strøm.
2		Indendørsenheder har aldrig kommunikeret med HARC-MODBUS	<ol style="list-style-type: none"> Kontrollér, at H-LINK-tilslutning er korrekt udført i HARC (K1) og også i indendørsenheder. Kontrollér, at airconditionenhederne får strøm.
3	D7 er altid OFF	Ingen LED blinker på PCB, og 7-segmenter er OFF	<ol style="list-style-type: none"> Kontrollér, at der leveres +5 V jævnstrøm til K3. <p> Bemærkninger:</p> <ul style="list-style-type: none"> Strømkildens DC-indgangssignal har en drejekontakt, der skal indstilles korrekt for at få +5 V DC. D7 skal være ON.
4	D12 blinker aldrig	HARC-MODBUS læser/sender ikke data (D12 blinker aldrig)	<ol style="list-style-type: none"> Kontrollér tilslutning mellem MODBUS-enheder og K5.
5	D12 blinker ikke	HARC fungerer ikke (D13 blinker ikke)	<ol style="list-style-type: none"> Kontrollér, at SW3 er i RUN-stilling. Hvis ikke, så indstil RUN, og tryk på nulstil.
6	D4 og D11 blinker ikke	Der er ingen H-LINK-kommunikation fra HARC-MODBUS	<ol style="list-style-type: none"> D4 blinker, men D11 blinker ikke. → Se linje nr. 6, forholdsregel 1. Hverken D4 eller D11 blinker ikke. → Se linje nr. 3, forholdsregel 1.

Inhoud

1.	Overzicht veiligheid _____	116
2.	Namen van componenten _____	116
3.	Specificaties _____	117
4.	Installatiewerkzaamheden _____	118
4.1	Afmetingen _____	118
4.2	Bevestigen _____	118
5.	Aansluiting bedrading _____	119
5.1	Elektrische bedrading _____	119
5.2	Instelling van dip-schakelaar _____	120
6.	Bediening _____	124
6.1	PACKAGED: Beschikbare gegevens _____	124
6.2	CHILLER: Beschikbare gegevens _____	127
6.3	Alarmcodelijst voor CHILLER _____	128
6.3.1	Alarmcodelijst voor CHILLER _____	128
6.3.2	Alarmcodelijst voor cyclus _____	129
7.	Problemen oplossen _____	130

**Opmerking:**

Deze handleiding bevat de basisgegevens voor de installatie en aansluiting van HARC-MODBUS.

1. Overzicht veiligheid

⚠ Waarschuwing:

Sluit geen netspanning aan op het regelsysteem voordat de installatie correct is uitgevoerd.

Lees deze handleiding zorgvuldig door voordat u installeert.

Lees deze handleiding om de HARC-MODBUS te configureren.

⚠ Let op:

Installeer HARC-MODBUS niet op locaties... :

- met dampen, olie of in de lucht verspreide vloeistoffen.
- in de buurt van hittebronnen (in een zwavelige omgeving).
- waar accumulatie, opwekking of lekken van ontvlambare gassen is ontdekt.
- in de buurt van de zee, in zoute, zure of basische omgevingen.

⚠ Let op:

Installeer HARC-MODBUS niet in de buurt van mogelijke bronnen die elektromagnetische golven kunnen veroorzaken.

Respecteer de plaatselijke elektriciteitsvoorzieningen.

Gebruik een stroomcircuit dat niet onderhevig is aan piekbelastingen.

Zorg ervoor dat u voldoende vrije ruimte aanhoudt

rond de HARC-MODBUS

(zie figuur), zodat de hitte

voldoende kan worden afgevoerd (zie 'Installatiewerkzaamheden').

Als u de HARC-MODBUS

in verticale stand installeert,

moet u de netvoeding in het

onderste gedeelte installeren.

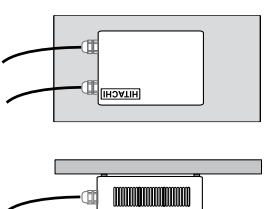

2. Namen van componenten

De onderstaande figuur toont de namen van de HARC-MODBUS-componenten.

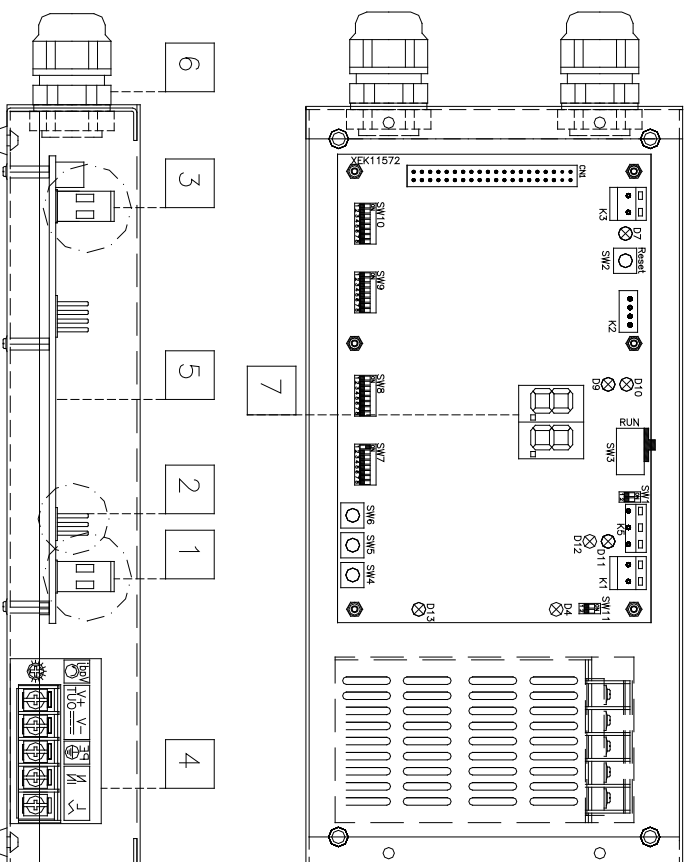

- 1 K1: H-LINK-aansluiting: aangesloten op CSNET WEB
- 2 K5: Serïële poort RS485
- 3 K3: +5 V gelijkstroomaansluiting
- 4 Voedingsbron: 230 V AC / 5 V DC
- 5 H-LINK PCB
- 6 Pakkingbussen (2)
- 7 7-segmenten

3. Specificaties

Hardwaregegevens

Element	Specificaties
Netvoeding	1~230 V \pm 10% 50 Hz
Verbruik	25 W (maximum)
Buitenafmetingen	Breedte: 143 mm, Diepte: 302 mm, Hoogte: 76 mm
Gewicht	1,75 kg
Opstellingsvoorwaarden	Binnen (op een bedieningspaneel of bureaublad)
Omgevingstemperatuur	0~40 °C
Luchtvochtigheid	20~85% (zonder condensatie)

MODBUS - Communicatie met bovenste systeem

Element	Specificaties
K5	Seriële poort RS485 (3-pensaansluiting) - MODBUS Protocol
Communicatieleiding	Gevlochten kabel. Polariteit
Communicatiesysteem	Half-duplex, meerpuntse seriële aansluiting
Communicatiemethode	Niet-pariteit of oneven/even pariteitselectie. Gegevenslengte: 8 bits (zie hoofdstuk 5)
Baud-snelheid transmissie	19200/9600 Baud (zie hoofdstuk 5)
Lengte	max. 1200 m volgens EIA-485

H-LINK - Communicatie met units

Element	Specificaties
Communicatie met	HITACHI PACKAGED/CHILLER
Communicatieleiding	Afgeschermde gevlochten kabel, geen polariteit
Communicatiesysteem	Half-duplex
Communicatiemethode	Asynchroon
Transmissiesnelheid	9600 Bauds
Kabellengte	Maximum 1000 m (totale lengte van HLINK I/O-bus)
Maximumaantal van HARC MODBUS	8 HARC-MODBUS/H-LINK-SYSTEEM (VERPAKT) 1 HARC-MODBUS/H-LINK-SYSTEEM (KOELMACHINE)

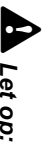

Let op:
HARC-MODBUS kan de binnenuits niet bedienen wanneer er geen afstandbedieningsschakelaar is aangesloten:

4. Installatiewerkzaamheden

Controleer wanneer u de HARC-MODBUS uitpakt of het apparaat tijdens het transport niet is beschadigd.

4.1 Afmetingen

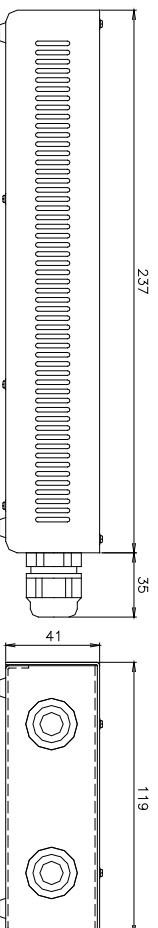

4.2 Bevestigen

Doe het volgende:

- 1 Verwijder de rubbersteunen.
- 2 Draai de 4 schroeven los van het bovendeksel en verwijder het.
- 3 Bevestig de kast aan de binnenkant van de achterste plaat met M4-schroeven (niet meegeleverd) en breng 3 mm afdichtingsringen aan de buitenkant aan om de kast van de muur te scheiden.
- 4 Plaats het bovendeksel terug. Zorg dat u het deksel juist terugplaatst.
- 5 Houd het rastergedeelte vrij voor de ventilatie en de kabelverbinding.

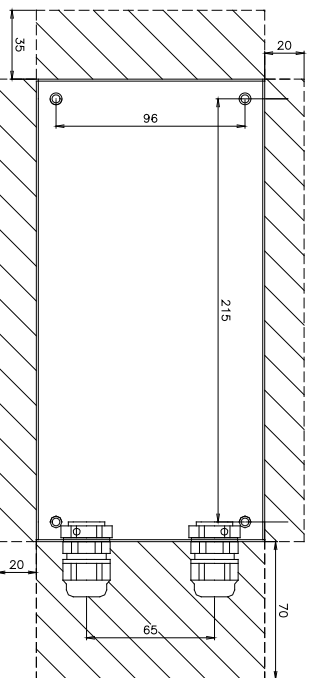

⚠ Let op:

- Voordat u de stroom inschakelt en de HARC-MODBUS aanzet, dient u ervoor te zorgen dat:
 1. Alle circuits die moeten worden aangesloten, correct zijn toegepast.
 2. Alle H-Link-aansluitingen zijn geïnstalleerd.
 3. Volg de lokale voorschriften voor de elektrische installatie van de HARC-MODBUS en gekoppelde circuits.

Een unit die niet is aangesloten of die geen stroom krijgt wanneer u de HARC-MODBUS aanzet, wordt niet herkend en moet later alsnog worden geconfigureerd.

⚠ Waarschuwing:

- Houd de signaalkabels zo kort mogelijk. Houd een afstand aan van meer dan 150 mm van andere netsnoeren. Sluit ze niet samen aan (hoewel ze door elkaar kunnen lopen). Als ze tezamen geïnstalleerd moeten worden, doe dan het volgende om ruis te voorkomen:

- Bescherm de signaalkabel met een metalen buis die aan één kant is geaard.
- Gebruik voor communicatie geïsoleerde kabels die aan één kant zijn geaard.

⚠ Gevaar:

- Haal altijd het netsnoer voor de HARC-MODBUS uit het stopcontact wanneer u de machine verplaatst, om elektrische schokken te voorkomen.
- Sluit de interface niet aan op de netvoeding totdat de installatie is voltooid.
- Volg nauwkeurig de plaatselijke veiligheidsbepalingen wanneer u de machine aansluit op het elektriciteitsnet.
- U hebt een kabel met drie draden nodig (twee kerndraden en één aarde) met een geschikte stekker aan één kant.

5. Aansluiting bedrading

5.1 Elektrische bedrading

Voor een correcte werking moet de HARC-MODBUS worden aangesloten op de bijbehorende in- en uitvoersignalen, voedingskabels en H-LINK.

nr.	Aansluiting	Kabelspecificaties
1	Netvoedingscircuit 1~ 230 V 50 Hz 25 W (met beveiligingscircuit)	Selecteer kabels overeenkomstig de lokale voorschriften (aanbevolen minimum 1,5 mm ² H05RN-F)
2	MODBUS	3 kabelbundels 0,75 mm ² (H05RN-F-type). Gebruik verschillende kleuren voor elke kabel. (Serïële poort RS485)
3	H-LINK	Communicatiekabels voor het aansluiten van de HARC-MODBUS op een Hitachi-installatie, via CSNET WEB of een andere Hitachi-unit waarop dezelfde H-LINK-terminals worden gebruikt Afgeschermde gevlochten kabel van 0,75 mm ² (H05RN-F-TYPE) Afscherming mag slechts aan één zijde geaard zijn
4	Netvoeding voor PCB's +5 V DC. I _{max} = 5 A DC	Gevlochten kabel van 0,75 mm ² (H05RN-F-TYPE)



Opmerking:

Alle kabels, behalve 4 dienen extern te worden aangeschaft.

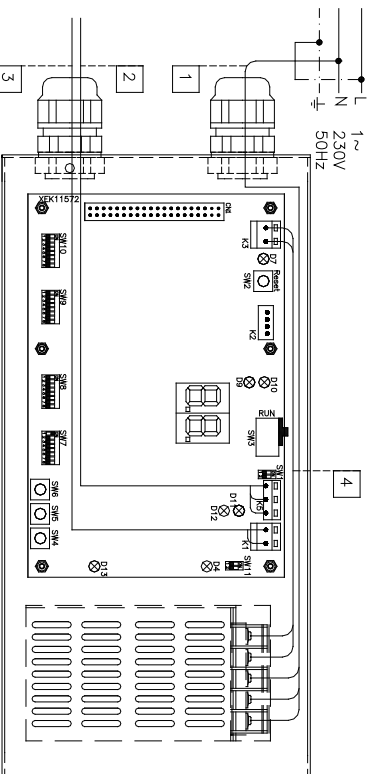

Niet-meegeleverde beschermingen:

CB/EF: 5 A

ALS: 2/40 A/30 mA

CO: Circuitonderbreker

EF: Elektrische zekering

ALS: aardlekschakelaar

5.2 Instelling van dip-schakelaar

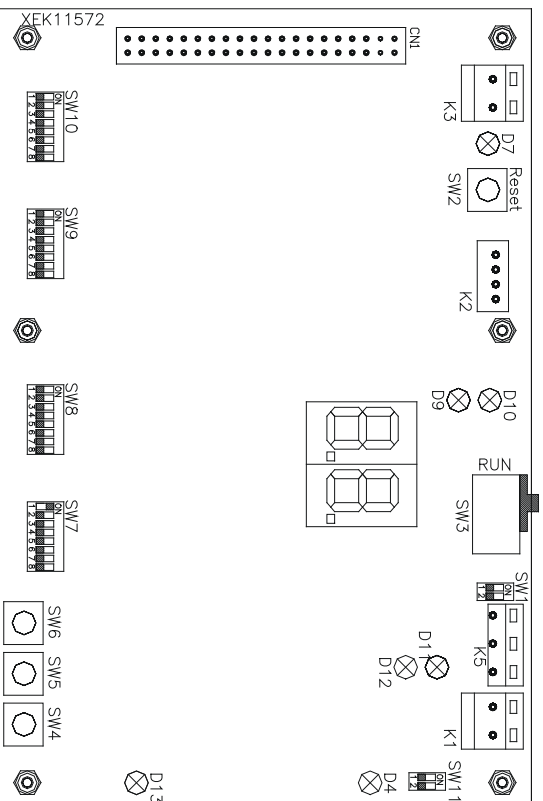

Item	Functie	Fabrieksinstelling	Beschrijving
SW1	Niet beschikbaar	ON 1 2	Alles uit (geen werking)
SW2	Reset	-	Reset-knop. Moet worden gebruikt indien het programma is vergrendeld
SW3 (TELE)	Niet beschikbaar	RUN	Fabriekstoepassingen. Wijzig deze nooit
SW4	Configuratie	-	Functies instellingen
SW5	Configuratie	-	Functies instellingen
SW6	Configuratie	-	Functies instellingen
SW7	Optie 2:	ON 1 2 3 4 5 6 7 8	SW7-1: OFF-SLAVE / ON-MASTER. Te gebruiken in geval van verschillende HARC-MODBUS op hetzelfde H-LINK-adres SW7-2: OFF-EVENT CONTROL/ON-CHANGE CONTROL SW7-3: OFF - Partiteit uitgeschakeld / ON - Partiteit ingeschakeld SW7-4: OFF - Even partiteit / ON - Oneven partiteit SW7-5: OFF - 19200 Bps / ON - 9600 Bps SW7-(6~8): Niet in gebruik
SW8	Optie 1: (Type toepassing)	ON 1 2 3 4 5 6 7 8	SW8-1: OFF-PACKAGED / ON-CHILLER. In te stellen volgens de toepassing van de units SW8-2~8: Niet in gebruik
SW9	Niet beschikbaar	ON 1 2 3 4 5 6 7 8	Alles uit (geen werking)
SW10	HARC MODBUS-adres	ON 1 2 3 4 5 6 7 8	HARC-MODBUS-adres van 1 tot 32 via penmen 1 tot 5
SW11	H-LINK DSW	ON 1 2	2-pen DSW SW11-1: H-LINK-eindweerstand SW11-2: H-LINK-zekeringsbescherming
D4, D11	H-LINK	-	H-LINK-transmissie
D7	Voedings-	-	Netvoeding AAN/UIT
D9/D10	Niet in gebruik	-	-
D12	MODBUS	-	Modbus-communicatie in RS485
D13	in bedrijf	-	Normale softwarebediening

■ SW7 – FUNCTIES INSTELLINGEN 1

SW7	Beschrijving
<p>Configuratie als MASTER/SLAVE:</p> <p>MASTER: SW7-1=ON Slechts één HARC-MODBUS kan als MASTER HARC-MODBUS worden ingesteld Standaardinstelling</p> <p>SLAVE: SW7-1= OFF 1 HARC-MODBUS moet worden geconfigureerd als MASTER. De rest van de HARC-MODBUS moet worden geconfigureerd als SLAVE in dezelfde H-LINK</p>	
<p>Vernieuwingsmodus</p> <p>Configuratie als EVENT CONTROL: SW7-2:OFF Parameters op de IU worden iedere keer vernieuwd wanneer de BMS een instellingsparameter wegschrijft (zelfs als de waarden niet zijn gewijzigd). Standaardinstelling</p> <p>Configuratie als CHANGE CONTROL: SW7-2:ON IU-parameters worden alleen vernieuwd wanneer waarden zijn gewijzigd</p>	
<p>Pariteitconfiguratie</p> <p>SW7-3: UIT: Geen pariteitconfiguratie</p> <p>SW7-3: AAN: Pariteitcommunicatie (zie SW7-4-configuratie voor pariteitstype)</p> <p>Pariteitstype configuratie</p> <p>SW7-4: UIT: Even pariteit (indien SW7-3 AAN is) SW7-4: AAN: Oneven pariteit (indien SW7-3 AAN is)</p>	
<p>Baud-snelheid van communicatie</p> <p>SW7-5: UIT 19200 Bps SW7-5: AAN 9600 Bps</p>	

■ SW8 – FUNCTIES INSTELLINGEN 2

SW8	Beschrijving
<p>ON <input type="checkbox"/> <input type="checkbox"/> <input type="checkbox"/> <input type="checkbox"/> <input type="checkbox"/> <input type="checkbox"/> <input type="checkbox"/> <input type="checkbox"/> <input type="checkbox"/> <input type="checkbox"/></p> <p>1 2 3 4 5 6 7 8</p> <p>ON <input type="checkbox"/> <input type="checkbox"/> <input type="checkbox"/> <input type="checkbox"/> <input type="checkbox"/> <input type="checkbox"/> <input type="checkbox"/> <input type="checkbox"/> <input type="checkbox"/> <input type="checkbox"/></p> <p>1 2 3 4 5 6 7 8</p> <p>ON <input type="checkbox"/> <input type="checkbox"/> <input type="checkbox"/> <input type="checkbox"/> <input type="checkbox"/> <input type="checkbox"/> <input type="checkbox"/> <input type="checkbox"/> <input type="checkbox"/> <input type="checkbox"/></p> <p>1 2 3 4 5 6 7 8</p>	<p>Configuratie voor PACKAGED / CHILLER</p> <p>PACKAGED-toepassingen: SW8-1: OFF (UIT)</p> <p>CHILLER-toepassingen: SW8-1: ON (AAN)</p>

■ SW10 – HARC-adres H-LINK (Zelfde concept van O.U./Adres koelmiddelcyclus)

SW10				Beschrijving
Adres: 1 ON 1 2 3 4 5 6 7 8	Adres: 2 ON 1 2 3 4 5 6 7 8	Adres: 3 ON 1 2 3 4 5 6 7 8	Adres: 4 ON 1 2 3 4 5 6 7 8	<p>Configuratie van HARC-adres HARC-MODBUS-adres gebruikt door MODBUS-systeem</p> <p>SW10-pennen 1~5 moeten worden ingesteld overeenkomstig de bijbehorende tekening van het gewenste adres</p> <p>SW10-pennen 5~8 moeten op OFF ingesteld blijven</p>
Adres: 5 ON 1 2 3 4 5 6 7 8	Adres: 6 ON 1 2 3 4 5 6 7 8	Adres: 7 ON 1 2 3 4 5 6 7 8	Adres: 8 ON 1 2 3 4 5 6 7 8	
Adres: 9 ON 1 2 3 4 5 6 7 8	Adres: 10 ON 1 2 3 4 5 6 7 8	Adres: 11 ON 1 2 3 4 5 6 7 8	Adres: 12 ON 1 2 3 4 5 6 7 8	
Adres: 13 ON 1 2 3 4 5 6 7 8	Adres: 14 ON 1 2 3 4 5 6 7 8	Adres: 15 ON 1 2 3 4 5 6 7 8	Adres: 16 ON 1 2 3 4 5 6 7 8	
Adres: 17 ON 1 2 3 4 5 6 7 8	Adres: 18 ON 1 2 3 4 5 6 7 8	Adres: 19 ON 1 2 3 4 5 6 7 8	Adres: 20 ON 1 2 3 4 5 6 7 8	
Adres: 21 ON 1 2 3 4 5 6 7 8	Adres: 22 ON 1 2 3 4 5 6 7 8	Adres: 23 ON 1 2 3 4 5 6 7 8	Adres: 24 ON 1 2 3 4 5 6 7 8	
Adres: 25 ON 1 2 3 4 5 6 7 8	Adres: 26 ON 1 2 3 4 5 6 7 8	Adres: 27 ON 1 2 3 4 5 6 7 8	Adres: 28 ON 1 2 3 4 5 6 7 8	
Adres: 29 ON 1 2 3 4 5 6 7 8	Adres: 30 ON 1 2 3 4 5 6 7 8	Adres: 31 ON 1 2 3 4 5 6 7 8	Adres: 32 ON 1 2 3 4 5 6 7 8	

■ Voorbeeld

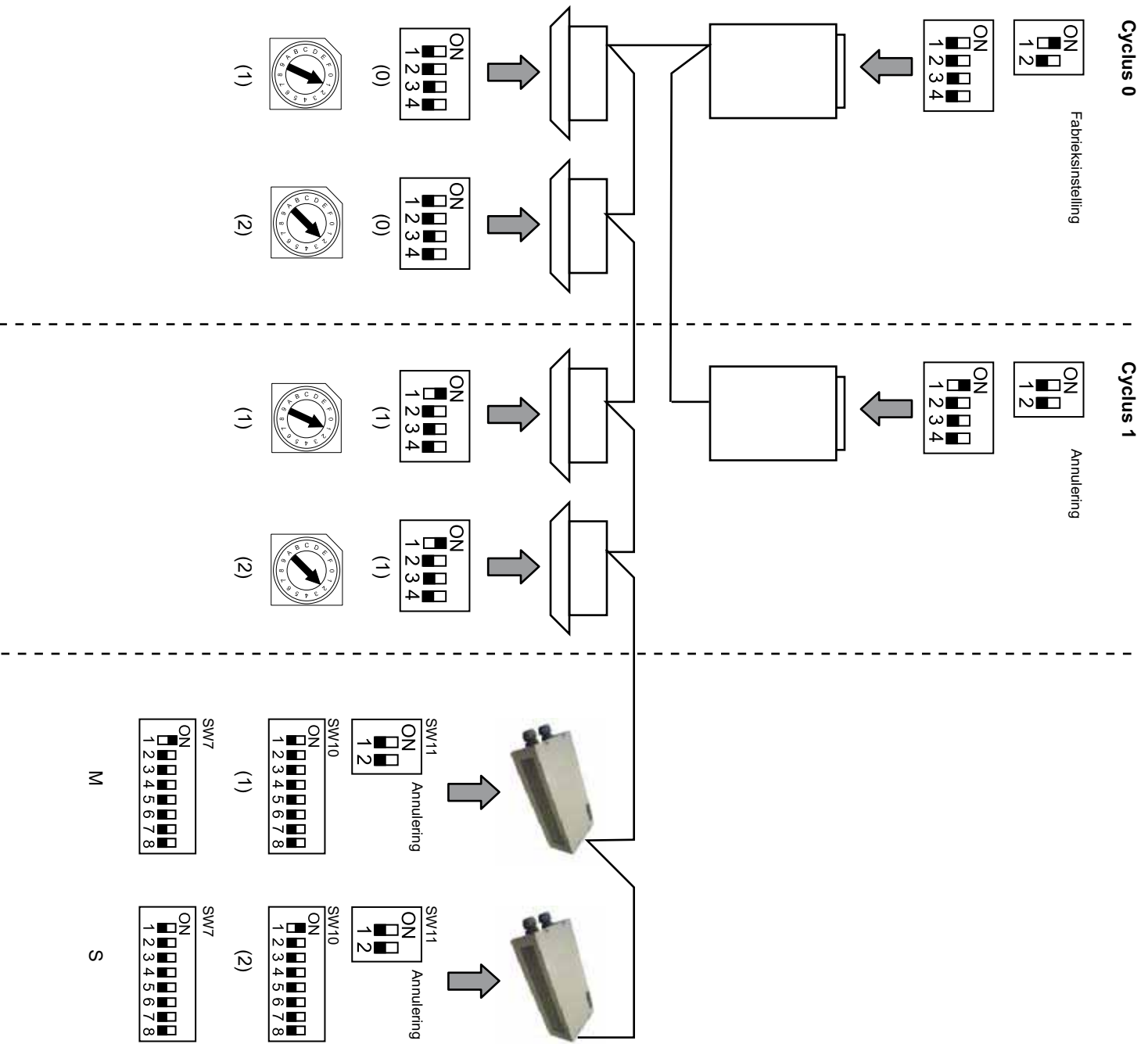

6. Bediening

6.1 PACKAGED: Beschikbare gegevens

Adres (Opmerking 1)	Item	Beschrijving	Lezen/Schrijven
0	EXIST	EXIST: 0: Bestaat niet 1: Bestaat	Lezen
1	SYSTEM_ADDRESS	Systeemadres: 0 ~ 15 in H-LINK 1	Lezen
2	UNIT_ADDRESS	Unitadres: 0 ~ 15 in H-LINK1	Lezen
3	SET_ONOFF	Aan/Uit-instellingsvolgorde: 0: stopgezet 1: Uitvoeren	Lezen/Schrijven
4	SET_MODE	Volgorde modusinstelling: 0: Koelen 2: Ventilator 3: Verwarmen 4: Auto	Lezen/Schrijven
5	SET_FAN	Volgorde ventilatorinstelling: 0: Laag 2: Hoog 1: Gemiddeld	Lezen/Schrijven
6	SET_TSET	Temperatuur instellen: 17 °C ~ 30 °C	Lezen/Schrijven
7	SET_LOUVER	Louwer-instelling: 0 ~ 8 (8 is Auto)	Lezen/Schrijven
8	SET_CENTRAL	Centrale instelling Bit 0: On/Off (kan altijd worden gestopt) Bit 1: Modus Bit 2: Temperatuurinstelling Bit 3: Ventilator	Lezen/Schrijven
9	READ_ONOFF	Aan/Uit lezen: 0: Uit 1: Aan	Lezen
10	READ_MODE	Modus lezen 0: Koelen 2: Ventilator 3: Verwarmen 4: Auto	Lezen
11	READ_FAN	Ventilator lezen 0: Laag 2: Hoog 1: Gemiddeld	Lezen
12	READ_TSET	Temperatuurinstelling lezen (17 °C tot 30 °C)	Lezen
13	READ_LOUVER	Louwer lezen 0 ~ 8 (8 is Auto)	Lezen
14~18	(Niet gebruikt)	(Niet gebruikt)	(Niet gebruikt)
19	ERROR_CODE	Alarmcode	Lezen
20~21	(Niet gebruikt)	(Niet gebruikt)	(Niet gebruikt)
22	OPER_CONDITION	Conditie unitbediening 0: OFF (UIT) 2: Thermo ON 1: Thermo OFF 3: Alarm	Lezen
23~31	(Niet gebruikt)	(Niet gebruikt)	(Niet gebruikt)

Opmerking 1: Offset-positie is: 20000 + N*32 + Adres in de tabel, waar N staat voor binneneenheidsadres.

■ Configuratiemethode

Iedere HARC-MODBUS kan maximaal 32 binnenunits bedienen. Omdat in dezelfde H-LINK maximaal 128 binnenunits kunnen worden aangesloten, moet worden ingesteld hoeveel binnenunits er zijn geselecteerd voor iedere HARC-MODBUS.

Deze configuratie is niet nodig in geval van CHILLER-toepassingen.

Conceptinstelling in een 'id'-tabel met maximaal 32 nummers voor de toewijzing van elk OU+IU-adressen zoals hier wordt weergegeven:

Id	Adres koelmiddelcyclus	Adres van binnenunit
00	00	00
01	00	01
02	00	02
03	00	03
04	00	04
05	00	05
06	00	06
07	00	07
08	00	08
09	00	09
10	00	10
11	00	11
12	00	12
13	00	13
14	00	14
15	00	15

Id	Adres koelmiddelcyclus	Adres van binnenunit
16	01	00
17	01	01
18	01	02
19	01	03
20	01	04
21	01	05
22	01	06
23	01	07
24	01	08
25	01	09
26	01	10
27	01	11
28	01	12
29	01	13
30	01	14
31	01	15



Opmerking:

- U kunt maximaal 32 binnenunits selecteren voor 1 HARC-MODBUS uit 16 verschillende koelmiddelcycli of 32 binnenunits van dezelfde koelmiddelcyclus.



Let op:

- Zorg ervoor dat u niet dezelfde binnenunit instelt voor meer dan één HARC-MODBUS. Deze fout kan niet worden gedetecteerd en kan ongewenste nevenwerkingen veroorzaken.

nr.	Actie	7-segment-display	Opmerkingen
1	Druk SW4 gedurende 3 seconden in	id	Configuratiemodus geselecteerd
2	Druk op SW4	00	ID-selectie (IU-nr.) van 0 tot 31 door te drukken op SW5 ▲ of SW6 ▼
3	Druk op SW4	011	Adres koelmiddelcyclus
4	Druk op SW4	---→00	Koelmiddelcyclus adressselectie van 0 tot 15 (bijv. 00) (door te drukken op SW5 ▲ & SW6 ▼)
5	Druk op SW4	11	Adres van binnenuit
6	Druk op SW4	---→00	Binnenuit adressselectie van 0 tot 15 (bijv. 00) (door te drukken op SW5 ▲ & SW6 ▼)
Herhaal voor 'id' 01 stap 1 tot 6			
7	Druk SW4 gedurende 3 seconden in	id	Configuratiemodus geselecteerd
8	Druk op SW4	00→01	ID-selectie (IU-nr.) van 0 tot 31 door te drukken op SW5 ▲ of SW6 ▼
9	Druk op SW4	011	Adres koelmiddelcyclus
10	Druk op SW4	---→00	Koelmiddelcyclus adressselectie van 0 tot 15 (bijv. 00) (door te drukken op SW5 ▲ & SW6 ▼)
11	Druk op SW4	11	Adres van binnenuit
12	Druk op SW4	---→01	Binnenuit adressselectie van 0 tot 15 (bijv. 01; druk eenmaal op SW5) (door te drukken op SW5 ▲ & SW6 ▼)
... Herhaal stap 1 tot 6 voor de rest van de 'id'			
187	Druk SW4 gedurende 3 seconden in	id	Configuratiemodus geselecteerd
188	Druk op SW4	00→31	ID-selectie (IU-nr.) van 0 tot 31 door te drukken op SW5 ▲ of SW6 ▼
189	Druk op SW4	011	Adres koelmiddelcyclus
190	Druk op SW4	---→01	Koelmiddelcyclus adressselectie van 0 tot 15 (bijv. 01; druk eenmaal op SW5) (door te drukken op SW5 ▲ & SW6 ▼)
191	Druk op SW4	11	Adres van binnenuit
192	Druk op SW4	---→15	Binnenuit adressselectie van 0 tot 15 (bijv. 15; druk eenmaal op SW6) (door te drukken op SW5 ▲ & SW6 ▼)

6.2 CHILLER: Beschikbare gegevens

Adres	Item	Beschrijving	Waarden	Lezen/ Schrijven
0	EXIST	Bestaat	0: Bestaat niet 1: Bestaat	Lezen
1	SYSTEM_ADDRESS	Chiller-adres	0~ 15 in H-LINK 1	Lezen
2	(Niet gebruikt)	(Niet gebruikt)	(Niet gebruikt)	(Niet gebruikt)
3	ONOFF_SET	Aan/Uit-instellingsvolgorde:	0: stopgezet 1: Run	Lezen/ Schrijven
4	MODE_SET	Volgorde modusinstelling	0: Koelen 1: Verwarmen	Lezen/ Schrijven
5	TEMP_SET_C	COOL temperatuur instellen	(zie opmerking*)	Lezen/ Schrijven
6	TEMP_SET_H	HEAT temperatuur instellen		Lezen/ Schrijven
7	CENTRAL_SET	Centrale instelling	0: Lokaal 1: Schakelaar	Lezen/ Schrijven
8	ONOFF_STATUS	Aan/uit-status	0: Uit 1: Aan	Lezen
9	MODE_STATUS	Modestatus	0: Koelen 1: Verwarmen	Lezen
10	TEMP_C_STATUS	COOL temperatuur instellen status		Lezen
11	TEMP_H_STATUS	HEAT temperatuur instellen status		Lezen
12	WATER_INLET	Inlaattemperatuur		Lezen
13	WATER_OUTLET	Uitlaattemperatuur		Lezen
14	AMBIENT_TEMPERATURE	Omgevingstemperatuur		Lezen
15	OPER_CONDITION	Conditie unitbediening	0: OFF (UIT) 1: Thermo OFF 2: Thermo ON 3: Alarm	Lezen
16	ERROR_CODE_CH	Alarmcode voor algemeen CHILLER-alarm		Lezen
17~22	ERROR_CODE_CYC	Alarmcode voor alarmcyclus (1~6)		Lezen
23~31	(Niet gebruikt)	(Niet gebruikt)	(Niet gebruikt)	(Niet gebruikt)



Opmerkingen:

- Offset-positie is: 40000 + N*32 + Adres in de tabel, waar N staat voor waterkoelmachinaadres.
- Status- (werkelijke waarde) en instellingsparameters (waarde gesorteerd) hebben doorgaans dezelfde waarde, maar in sommige gevallen zijn de waarden verschillend. Het wordt aanbevolen instellingsparameters te gebruiken voor normale bediening.
- *) Wanneer u de Temperatuurinstelling en bedieningsmodus voor de eerste keer wijzigt, wijzig eerst de bedieningsmodus en stel daarna de gewenste temperatuur in.

6.3 Alarmcodelijst voor CHILLER

6.3.1 Alarmcodelijst voor CHILLER

CHILLER-alarm		Beschrijving	H-LINK
7SEG1	7SEG2		Code
11	11	Storing in thermistor voor waterinlaattemperatuur	20
12	12	Storing in thermistor voor wateruitlaattemperatuur (alleen voor enkele cyclusunit)	21
22	22	Storing in thermistor voor omgevings temperatuur (open/kort)	24
5P	5P	Geen feedbacksignaal van waterpomp	26
13	13	Activering van antivriesregeling (alleen voor enkele cyclusunit)	27
6C	6C	Waterstoringsalarm (differentiaaldrukschakelaar of doorvoerschakelaaroptie) - Condensor	28
6E	6E	Waterstoringsalarm (differentiaaldrukschakelaar of doorvoerschakelaaroptie) - Verdamp(er)	29
14	14	Activering van thermostaat voor extreem hoge watertemperatuur (alleen voor enkele cyclusunits)	30
RP	RP	Activering van aanvullende beveiligingsinstallatie	31
05	05	Afwijking fase	32
CP	CP	Fout in communicatie tussen Controle PCB (PCB _{G1} , PCB _{G2})	33
03	03	Communicatiefout tussen koelmachine en afstandsbediening (H-LINK)	34
EU	EU	Communicatiefout tussen expansieventiel PCB en regeling PCB	36
40	40	Incorrecte werking	40-45, 47,47,54

6.3.2 Alarmcodelijst voor cyclus

Cyclusalarm		Beschrijving	H-LINK
7SEG1	7SEG2		Code
L _n	H _n	Activeren van hogedrukschakelaar	1
L _n	L _n	Activeren van lagedrukcontrole	2
L _n	n _n	Activeren van interne compressorthermostaat	3
L _n	b _n	Activeren van thermistor voor uitlaatgas	4
L _n	S _n	Activeren van Thermische relais voor compressor of storing in reserve-relais AR _n	5
L _n	F ₀	Incorrecte instelling van ventilatienummer	6
L _n	4 _n	Activeren van interne thermostaat voor de ventilatormotor	7
L _n	L _n	Te lage druk	8
L _n	9 _n	Te lage temperatuur van koelstofvoevoer koelmotor	10
L _n	2 ₇	Storing in druksensor voor uitlaatgas (open/kort)	11
L _n	2 ₈	Storing in druksensor voor zuiggas (open/kort)	12
L _n	1 ₂	Storing in thermistor voor wateruitlaattemperatuur (alleen voor niet-enkele cyclusunit)	14
L _n	2 ₃	Storing in Uiltlaagsthermistor (open/kort)	15
L _n	2 ₆	Storing in thermistor voor zuiggas (open/kort)	16
L _n	0 ₅	Afwijking fase	17
L _n	2 ₁	Storing in koelstofvoevoerthermistor (open/kort)	19
L _n	b _n	Activeren van thermistor voor zuiggas	20
L _n	1 ₃	Activering van antivriesregeling (alleen voor niet-enkele cyclusunit)	21
L _n	2 ₄	Storing in thermistor ingesteld voor expansieventiel (open/kort)	23
L _n	2 ₅	Storing in wateruitlaathermistor - achterkant van koelmachine (open/kort)	24
F _n	5 ₁	Afwijkende netvoedingsvormer	34

7. Problemen oplossen

Nr.	Alarmcode	Beschrijving	TEGENMAATREGEL
1	EE → B 1	Binnenumits hebben meer dan 10 minuten niet gecommuniceerd met HARC-MODBUS	<ol style="list-style-type: none"> 1. Controleer of de H-LINK-verbinding correct is uitgevoerd in HARC (K1) en de binnenumits. 2. Controleer of de air-conditioners van stroom worden voorzien.
2	EE → B 3	Binnenumits hebben nooit gecommuniceerd met HARC-MODBUS	<ol style="list-style-type: none"> 1. Controleer of de H-LINK-verbinding correct is uitgevoerd in HARC (K1) en de binnenumits. 2. Controleer of de air-conditioners van stroom worden voorzien.
3	D7 is altijd UIT	Geen knipperende LED op PCB en 7 segmenten zijn UIT	<p> Opmerkingen:</p> <ul style="list-style-type: none"> - DC-signaal van voedingsbron heeft een draaischakelaar die correct moet zijn ingesteld op +5 V DC. - D7 moet in de stand ON staan.
4	D12 knippert nooit	HARC-MODBUS leest/verzendt geen gegevens (D12 knippert nooit)	<ol style="list-style-type: none"> 1. Controleer de verbinding tussen MODBUS-apparaten en K5.
5	D12 knippert niet	HARC werkt niet (D13 knippert niet)	<ol style="list-style-type: none"> 1. Controleer of SW3 in de RUN-stand staat. Zo niet, stel dan in op RUN en druk op reset.
6	D4 & D11 knipperen niet	Er is geen H-LINK-communicatie van HARC-MODBUS	<ol style="list-style-type: none"> 1. D4 knippert, maar D11 knippert niet. → Zie regel 6, tegenmaatregel 1. 2. D4 en D11 knipperen niet. → Zie regel 3, tegenmaatregel 1.

Innehåll

1. Säkerhetsföreskrifter _____	132
2. Namn på komponenter _____	132
3. Specifikationer _____	133
4. Installationsarbete _____	134
4.1 Mätt _____	134
4.2 Fästande _____	134
5. Ledningsanslutningar _____	135
5.1 Elektriska ledningar _____	135
5.2 Inställning för dipkontakt _____	136
6. Drift _____	140
6.1 PACKAGED: Data tillgängliga _____	140
6.2 CHILLER: Data tillgängliga _____	143
6.3 CHILLER-larmkoder _____	144
6.3.1 Lista över CHILLER-larmkoder _____	144
6.3.2 Lista över cykellarmkoder _____	145
7. Felsökning _____	146

**Anmärkning:**

Den här handboken innehåller grundläggande information om hur du installerar och kopplar HARC-MODBUS.

1. Säkerhetsföreskrifter



Obs!

Anslut inte spänning till styrsystemet innan installationen är slutförd och kontrollerad.

Läs den här handboken noggrant innan du påbörjar installationen.

Läs igenom handboken innan du konfigurerar HARC-MODBUS.



Obs!

Installera HARC-MODBUS långt bort från möjliga källor till elektromagnetisk strålning.

Följ gällande föreskrifter om elsäkerhet.

Använd en strömkrets som inte utsätts för toppbelastning.

Försäkra dig om att det finns tillräckligt med utrymme runt omkring HARC-MODBUS (se illustrationen) så att värmen ventileras bort (se "Installation").

Om du installerar HARC-MODBUS i vertikalt läge installerar du strömförsörjningen i den nedre delen.

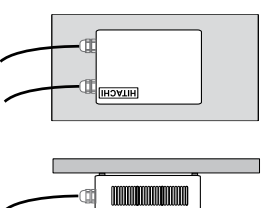

- Obs!** Installera inte HARC-MODBUS på platser... :
- där det finns ånga, olja eller lösta vätskor.
 - med värmekällor i närheten (svavelrika miljöer).
 - där ansamling eller alstring av lättantändliga gaser eller gasläckor har upptäckts.
 - som ligger nära havet eller i salthaltiga, sura eller alkaliska miljöer.

2. Namn på komponenter

Figuren visar namnen på HARC-MODBUS-komponenterna.

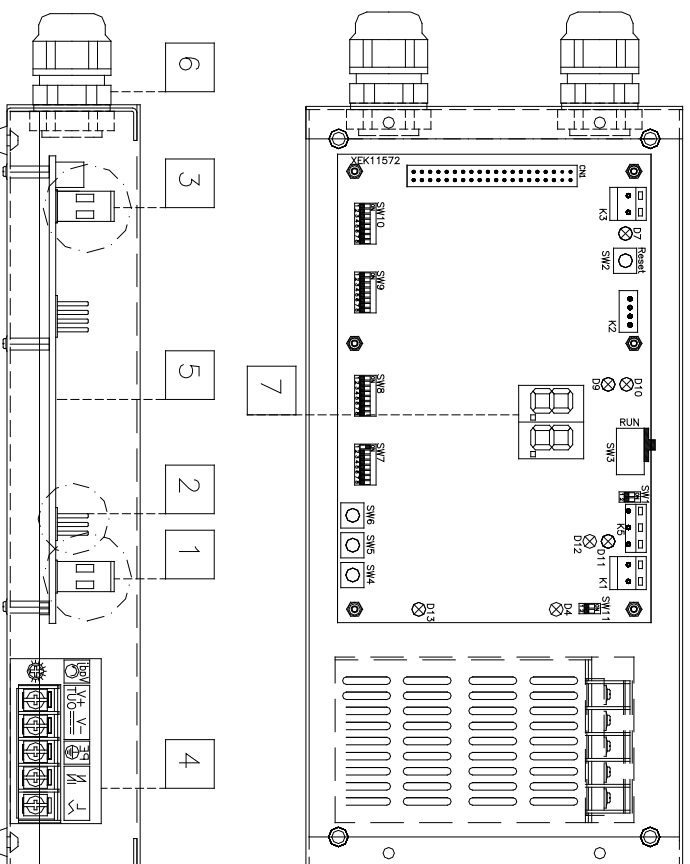

- 1 K1: H-LINK-anslutning: ansluts till CSNET WEB
- 2 K5: Serierport RS485
- 3 K3: +5 V DC strömförsörjning
- 4 Strömkälla: 230 V AC / 5 V DC
- 5 H-LINK PCB
- 6 Packringar (2)
- 7 Lägessindkering

3. Specifikationer

Specifikationer för maskinvara

Objekt	Specifikationer
Spänningsmatning	1~230 V \pm 10% 50Hz
Förbrukning	25 W (maximum)
Ytermått	Bredd: 143 mm, Djup: 302 mm, Höjd: 76 mm
Vikt	1,75 kg
Installationsvillkor	Inomhus (på en driftpanel eller ett skrivbord)
Omgivningstemperatur	0~40 °C
Fuktighet	20~85 % (utan kondensering)

MODBUS - kommunikation med översystem

Objekt	Specifikationer
K5:	Serieport RS485 (3-stiftsanslutning) - MODBUS-protokoll
Kommunikationslinje	Tvinnad parkabel. Polaritet
Kommunikationssystem	Halv duplex, flerpunkts seriell anslutning
Kommunikationsmetod	Ingen paritet eller udda/jämn paritet. Datalängd: 8 bitar (se kapitel 5)
Baudhastighet	19200/9600 Baud (se kapitel 5)
Längd	max. 1200 m enligt EIA-485

H-LINK - kommunikation med enheter

Objekt	Specifikationer
Kommunikation med	HITACHI PACKAGED/CHILLER
Kommunikationslinje	Skärmad tvinnad kabel, ingen polaritet
Kommunikationssystem	Envägs
Kommunikationsmetod	Asynkron
Överföringshastighet	9 600 baud
Ledningslängd	1000 m maximum (H-LINK I/O-bussens totala längd)
Maximalt antal HARC MODBUS	8 HARC MODBUS/H-LINK SYSTEM (PACKAGED) 1 HARC MODBUS/H-LINK SYSTEM (CHILLER)



Obs!

HARC-MODBUS kan inte styra inomhusenheter utan en ansluten fjärrkontroll.

4. Installationsarbete

Kontrollera att enheten inte har skadats under transporten när du packar upp den.

4.1 Mått

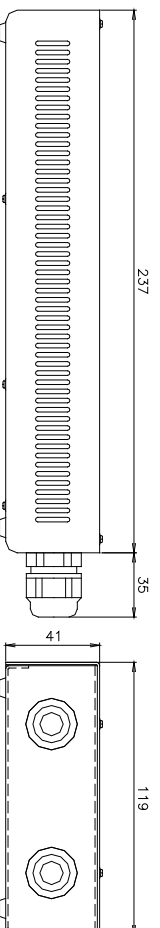

4.2 Fästande

Gör följande:

- 1 Ta bort gummistöden.
- 2 Skruva ur de 4 skruvarna på det övre höljet och ta bort det.
- 3 Fäst lådan vid den bakre lodräta panelen från insidan med M4-skravar (medföljer inte) och placera 3-rillimetersdistanser på utsidan för att skilja lådan från väggen.
- 4 Skruva fast det övre höljet igen. Försäkra dig om att det sitter rätt.
- 5 Håll galleret fritt för ventilation och kabelanslutningar.

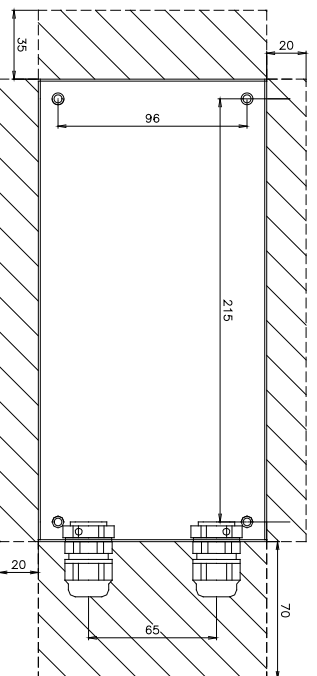

⚠ Obs!

- Innan du strömsätter och startar enheten måste du se till att:
 1. Alla kretsar är korrekt anslutna.
 2. Alla H-Link-anslutningar har installerats.
 3. Följ lokala föreskrifter för elektriskt installationsarbete, både när du arbetar med HARC-MODBUS och relevanta kopplingar.
- Enheter som inte är anslutna till eller inte har någon strömtillförsel när HARC-MODBUS slås på identifieras inte och måste konfigureras senare.

⚠ Obs!

- Signalkablarna ska vara så korta som möjligt. Håll dem på minst 150 mm avstånd från andra elkablar. Dra dem inte tillsammans (men de får korsas). Om de måste installeras tillsammans gör du följande för att undvika störningar:
 - Skydda signalkabeln med ett metallhölje som är jordat i ena änden.
 - För kommunikation används en skyddad ledning som är jordad i ena änden.

⚠ Far!

- Koppla alltid från spänningsmatningen för HARC-MODBUS när du hanterar maskinen för att undvika elektriska urladdningar.
- Anslut inte gränssnittet till spänningsmatningen förrän installationen är slutförd.
- Följ noggrant de lokala säkerhetsreglerna när du ansluter maskinen till det elektriska nätverket.
- Du behöver en trettådig kabel (två trådar och jordning) med en lämplig stickpropp i ena änden.

5. Ledningsanslutningar

5.1 Elektriska ledningar

Enheten måste anslutas till rätt in- och utsignaler innan start, samt till strömförsörjning och H-LINK.

Nr	Anslutning	Kabelspecifikationer
1	Strömförsörjningskrets 1 ~ 230 V 50 Hz 25 W (med skyddskrets)	Välj kablage enligt lokala föreskrifter (minimum 1,5 mm ² H05RN-F rekommenderas)
2	MODBUS	3 kabelskydd 0,75 mm ² (H05RN-F-typ). Använd separata färger för varje kabel. (Serieport RS485)
3	H-LINK	Kommunikationskablar för anslutning av HARC MODBUS till Hitachi-installationen, via CSNET WEB eller en Hitachi-enhet som använder samma H-LINK-kontakt. Tvinnad skärmad parkabel 0,75 mm ² (H05RN-F-TYP) Skärmmingen får endast vara jordad på ena sidan
4	Kretskortens strömförsörjning +5 V DC. I _{max} = 5 A DC	Parkabel 0,75 mm ² (H05RN-F-TYP)



Anmärkning:

Inga kablar medföljer utom 4

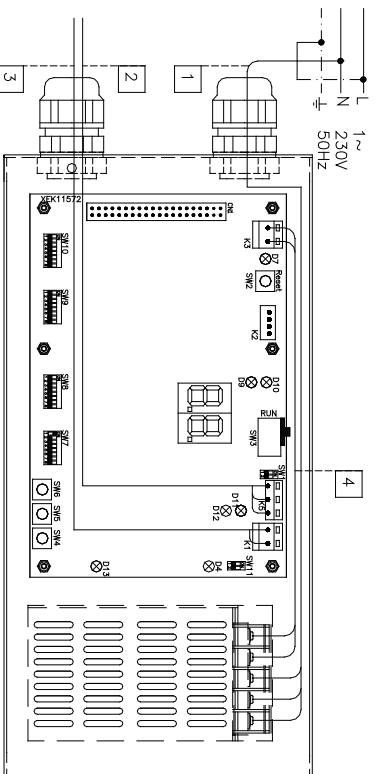

Säkringar (medföljer ej):

AS/ES: 5 A

JB: 2/40 A/30 mA

AS: Automatsäkring

ES: Elektrisk säkring

JB: Jordfelsbrytare

■ SW7 – FUNKTIONINSTÄLLNING 1

SW7	Beskrivning
<p>Konfiguration som PRIMÄR/SEKUNDÄR:</p> <p>PRIMÄR: SW7-1=ON Endast en HARC MODBUS kan ställas in som en primär HARC MODBUS Förinställning</p> <p>SEKUNDÄR: SW7-1= OFF En HARC-MODBUS skall konfigureras som primärenhet (MASTER). Alla andra HARC-MODBUS måste konfigureras som sekundärenheter (SLAVE) i samma H-LINK</p> <p>Datauppdateringsläge Konfiguration som SW7-2:OFF Parametrarna förnyas till inomhusenheten varje gång BMS skriver en inställningsparameter (även om inga värden ändras). Förinställning</p> <p>Konfiguration som CHANGE CONTROL: SW7-2:ON Parametrar förnyas till inomhusenheten endast när några värden ändras</p>	
<p>ON <input type="checkbox"/> <input type="checkbox"/> <input type="checkbox"/> <input type="checkbox"/> <input type="checkbox"/> <input type="checkbox"/> <input type="checkbox"/> <input type="checkbox"/> <input type="checkbox"/> <input type="checkbox"/></p> <p>1 2 3 4 5 6 7 8</p> <p>ON <input type="checkbox"/> <input type="checkbox"/> <input type="checkbox"/> <input type="checkbox"/> <input type="checkbox"/> <input type="checkbox"/> <input type="checkbox"/> <input type="checkbox"/> <input type="checkbox"/> <input type="checkbox"/></p> <p>1 2 3 4 5 6 7 8</p> <p>ON <input type="checkbox"/> <input type="checkbox"/> <input type="checkbox"/> <input type="checkbox"/> <input type="checkbox"/> <input type="checkbox"/> <input type="checkbox"/> <input type="checkbox"/> <input type="checkbox"/> <input type="checkbox"/></p> <p>1 2 3 4 5 6 7 8</p>	<p>Paritet</p> <p>SW7-3: AV: Ingen paritet</p> <p>SW7-3: PÅ: Paritet (se SW7-4 för konfiguration av paritetstyp)</p> <p>Paritetstyp</p> <p>SW7-4: AV: Jämn paritet (om SW7-3 är i läge ON)</p> <p>SW7-4: PÅ: Udda paritet (om SW7-3 är i läge ON)</p> <p>Baudhastighet</p> <p>SW7-5: OFF 19200 Bps</p> <p>SW7-5: ON 9600 Bps</p>

■ SW8 – FUNKTIONINSTÄLLNING 2

SW8	Beskrivning
<p>ON <input type="checkbox"/> <input type="checkbox"/> <input type="checkbox"/> <input type="checkbox"/> <input type="checkbox"/> <input type="checkbox"/> <input type="checkbox"/> <input type="checkbox"/> <input type="checkbox"/> <input type="checkbox"/></p> <p>1 2 3 4 5 6 7 8</p> <p>ON <input type="checkbox"/> <input type="checkbox"/> <input type="checkbox"/> <input type="checkbox"/> <input type="checkbox"/> <input type="checkbox"/> <input type="checkbox"/> <input type="checkbox"/> <input type="checkbox"/> <input type="checkbox"/></p> <p>1 2 3 4 5 6 7 8</p>	<p>Konfiguration av PACKAGED/CHILLER</p> <p>PACKAGED-tillämpningar: SW8-1: OFF</p> <p>CHILLER-tillämpningar: SW8-1: ON</p>

- SW10 – HARC-adress för H-LINK (samma princip som adresser till utomhusenheter/kylmediecykler)

SW10				Beskrivning
Address: 1 ON <input type="checkbox"/> <input type="checkbox"/> <input type="checkbox"/> <input type="checkbox"/> <input type="checkbox"/> <input type="checkbox"/> <input type="checkbox"/> <input type="checkbox"/> 1 2 3 4 5 6 7 8	Address: 2 ON <input type="checkbox"/> <input type="checkbox"/> <input type="checkbox"/> <input type="checkbox"/> <input type="checkbox"/> <input type="checkbox"/> <input type="checkbox"/> <input type="checkbox"/> 1 2 3 4 5 6 7 8	Address: 3 ON <input type="checkbox"/> <input type="checkbox"/> <input type="checkbox"/> <input type="checkbox"/> <input type="checkbox"/> <input type="checkbox"/> <input type="checkbox"/> <input type="checkbox"/> 1 2 3 4 5 6 7 8	Address: 4 ON <input type="checkbox"/> <input type="checkbox"/> <input type="checkbox"/> <input type="checkbox"/> <input type="checkbox"/> <input type="checkbox"/> <input type="checkbox"/> <input type="checkbox"/> 1 2 3 4 5 6 7 8	Konfiguration av HARC-adress HARC-MODBUS-adress som används av MODBUS-systemet SW10-stift 1~5 måste ställas in enligt motsvarande ritning för önskad adress SW10-stift 6~8 måste vara i läget OFF
Address: 5 ON <input type="checkbox"/> <input type="checkbox"/> <input type="checkbox"/> <input type="checkbox"/> <input type="checkbox"/> <input type="checkbox"/> <input type="checkbox"/> <input type="checkbox"/> 1 2 3 4 5 6 7 8	Address: 6 ON <input type="checkbox"/> <input type="checkbox"/> <input type="checkbox"/> <input type="checkbox"/> <input type="checkbox"/> <input type="checkbox"/> <input type="checkbox"/> <input type="checkbox"/> 1 2 3 4 5 6 7 8	Address: 7 ON <input type="checkbox"/> <input type="checkbox"/> <input type="checkbox"/> <input type="checkbox"/> <input type="checkbox"/> <input type="checkbox"/> <input type="checkbox"/> <input type="checkbox"/> 1 2 3 4 5 6 7 8	Address: 8 ON <input type="checkbox"/> <input type="checkbox"/> <input type="checkbox"/> <input type="checkbox"/> <input type="checkbox"/> <input type="checkbox"/> <input type="checkbox"/> <input type="checkbox"/> 1 2 3 4 5 6 7 8	
Address: 9 ON <input type="checkbox"/> <input type="checkbox"/> <input type="checkbox"/> <input type="checkbox"/> <input type="checkbox"/> <input type="checkbox"/> <input type="checkbox"/> <input type="checkbox"/> 1 2 3 4 5 6 7 8	Address: 10 ON <input type="checkbox"/> <input type="checkbox"/> <input type="checkbox"/> <input type="checkbox"/> <input type="checkbox"/> <input type="checkbox"/> <input type="checkbox"/> <input type="checkbox"/> 1 2 3 4 5 6 7 8	Address: 11 ON <input type="checkbox"/> <input type="checkbox"/> <input type="checkbox"/> <input type="checkbox"/> <input type="checkbox"/> <input type="checkbox"/> <input type="checkbox"/> <input type="checkbox"/> 1 2 3 4 5 6 7 8	Address: 12 ON <input type="checkbox"/> <input type="checkbox"/> <input type="checkbox"/> <input type="checkbox"/> <input type="checkbox"/> <input type="checkbox"/> <input type="checkbox"/> <input type="checkbox"/> 1 2 3 4 5 6 7 8	
Address: 13 ON <input type="checkbox"/> <input type="checkbox"/> <input type="checkbox"/> <input type="checkbox"/> <input type="checkbox"/> <input type="checkbox"/> <input type="checkbox"/> <input type="checkbox"/> 1 2 3 4 5 6 7 8	Address: 14 ON <input type="checkbox"/> <input type="checkbox"/> <input type="checkbox"/> <input type="checkbox"/> <input type="checkbox"/> <input type="checkbox"/> <input type="checkbox"/> <input type="checkbox"/> 1 2 3 4 5 6 7 8	Address: 15 ON <input type="checkbox"/> <input type="checkbox"/> <input type="checkbox"/> <input type="checkbox"/> <input type="checkbox"/> <input type="checkbox"/> <input type="checkbox"/> <input type="checkbox"/> 1 2 3 4 5 6 7 8	Address: 16 ON <input type="checkbox"/> <input type="checkbox"/> <input type="checkbox"/> <input type="checkbox"/> <input type="checkbox"/> <input type="checkbox"/> <input type="checkbox"/> <input type="checkbox"/> 1 2 3 4 5 6 7 8	
Address: 17 ON <input type="checkbox"/> <input type="checkbox"/> <input type="checkbox"/> <input type="checkbox"/> <input type="checkbox"/> <input type="checkbox"/> <input type="checkbox"/> <input type="checkbox"/> 1 2 3 4 5 6 7 8	Address: 18 ON <input type="checkbox"/> <input type="checkbox"/> <input type="checkbox"/> <input type="checkbox"/> <input type="checkbox"/> <input type="checkbox"/> <input type="checkbox"/> <input type="checkbox"/> 1 2 3 4 5 6 7 8	Address: 19 ON <input type="checkbox"/> <input type="checkbox"/> <input type="checkbox"/> <input type="checkbox"/> <input type="checkbox"/> <input type="checkbox"/> <input type="checkbox"/> <input type="checkbox"/> 1 2 3 4 5 6 7 8	Address: 20 ON <input type="checkbox"/> <input type="checkbox"/> <input type="checkbox"/> <input type="checkbox"/> <input type="checkbox"/> <input type="checkbox"/> <input type="checkbox"/> <input type="checkbox"/> 1 2 3 4 5 6 7 8	
Address: 21 ON <input type="checkbox"/> <input type="checkbox"/> <input type="checkbox"/> <input type="checkbox"/> <input type="checkbox"/> <input type="checkbox"/> <input type="checkbox"/> <input type="checkbox"/> 1 2 3 4 5 6 7 8	Address: 22 ON <input type="checkbox"/> <input type="checkbox"/> <input type="checkbox"/> <input type="checkbox"/> <input type="checkbox"/> <input type="checkbox"/> <input type="checkbox"/> <input type="checkbox"/> 1 2 3 4 5 6 7 8	Address: 23 ON <input type="checkbox"/> <input type="checkbox"/> <input type="checkbox"/> <input type="checkbox"/> <input type="checkbox"/> <input type="checkbox"/> <input type="checkbox"/> <input type="checkbox"/> 1 2 3 4 5 6 7 8	Address: 24 ON <input type="checkbox"/> <input type="checkbox"/> <input type="checkbox"/> <input type="checkbox"/> <input type="checkbox"/> <input type="checkbox"/> <input type="checkbox"/> <input type="checkbox"/> 1 2 3 4 5 6 7 8	
Address: 25 ON <input type="checkbox"/> <input type="checkbox"/> <input type="checkbox"/> <input type="checkbox"/> <input type="checkbox"/> <input type="checkbox"/> <input type="checkbox"/> <input type="checkbox"/> 1 2 3 4 5 6 7 8	Address: 26 ON <input type="checkbox"/> <input type="checkbox"/> <input type="checkbox"/> <input type="checkbox"/> <input type="checkbox"/> <input type="checkbox"/> <input type="checkbox"/> <input type="checkbox"/> 1 2 3 4 5 6 7 8	Address: 27 ON <input type="checkbox"/> <input type="checkbox"/> <input type="checkbox"/> <input type="checkbox"/> <input type="checkbox"/> <input type="checkbox"/> <input type="checkbox"/> <input type="checkbox"/> 1 2 3 4 5 6 7 8	Address: 28 ON <input type="checkbox"/> <input type="checkbox"/> <input type="checkbox"/> <input type="checkbox"/> <input type="checkbox"/> <input type="checkbox"/> <input type="checkbox"/> <input type="checkbox"/> 1 2 3 4 5 6 7 8	
Address: 29 ON <input type="checkbox"/> <input type="checkbox"/> <input type="checkbox"/> <input type="checkbox"/> <input type="checkbox"/> <input type="checkbox"/> <input type="checkbox"/> <input type="checkbox"/> 1 2 3 4 5 6 7 8	Address: 30 ON <input type="checkbox"/> <input type="checkbox"/> <input type="checkbox"/> <input type="checkbox"/> <input type="checkbox"/> <input type="checkbox"/> <input type="checkbox"/> <input type="checkbox"/> 1 2 3 4 5 6 7 8	Address: 31 ON <input type="checkbox"/> <input type="checkbox"/> <input type="checkbox"/> <input type="checkbox"/> <input type="checkbox"/> <input type="checkbox"/> <input type="checkbox"/> <input type="checkbox"/> 1 2 3 4 5 6 7 8	Address: 32 ON <input type="checkbox"/> <input type="checkbox"/> <input type="checkbox"/> <input type="checkbox"/> <input type="checkbox"/> <input type="checkbox"/> <input type="checkbox"/> <input type="checkbox"/> 1 2 3 4 5 6 7 8	

■ Exempel

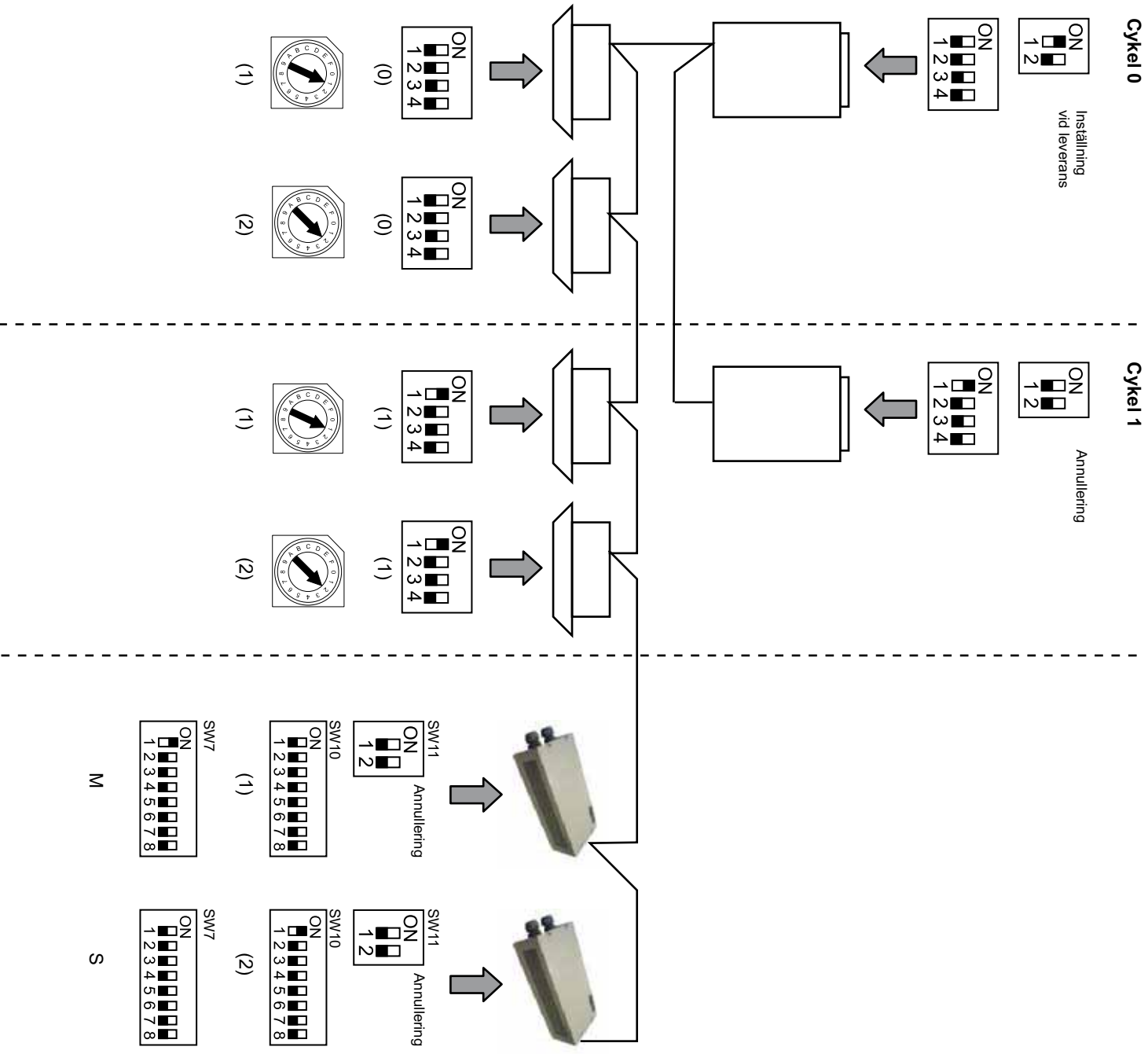

6. Drift

6.1 PACKAGED: Data tillgängliga

Adress (Anmärkning 1)	Benämning	Beskrivning	Läs/skriv
0	EXIST	EXIST: 0: Flins ej 1: Flins	Läs
1	SYSTEM_ADDRESS	Systemadress: 0 ~ 15 i H-LINK 1	Läs
2	UNIT_ADDRESS	Enhetsadress 0 ~ 15 in H-LINK1	Läs
3	SET_ONOFF	På/av-inställningsordning: 0: Stopp 1: Kör	Läs/skriv
4	SET_MODE	Inställningsordning för läge: 0: Svält 2: Fläkt 3: Varmt 4: Auto	Läs/skriv
5	SET_FAN	Inställningsordning för fläkt: 0: Låg 2: Hög 1: Mellan	Läs/skriv
6	SET_TSET	Temperaturinställning: 17 °C ~ 30 °C	Läs/skriv
7	SET_LOUVER	Spiällinställning: 0 ~ 8 (8 är Auto)	Läs/skriv
8	SET_CENTRAL	Centralinställning Del 0: På/av (kan alltid stoppas) Del 1: Läge Del 2: Temperaturinställning Del 3: Fläkt	Läs/skriv
9	READ_ONOFF	Läs på/av: 0: Av 1: På	Läs
10	READ_MODE	Läget Läs 0: Svält 2: Fläkt 3: Varmt 4: Auto	Läs
11	READ_FAN	Läs fläkt 0: Låg 2: Hög 1: Mellan	Läs
12	READ_TSET	Läs temperaturinställning (17 °C till 30 °C)	Läs
13	READ_LOUVER	Läs spiäll 0 ~ 8 (8 är Auto)	Läs
14~18	(Används ej)	(Används ej)	(Används ej)
19	ERROR_CODE	Larmkod	Läs
20~21	(Används ej)	(Används ej)	(Används ej)
22	OPER_CONDITION	Enhetens driftsvillkor 0: OFF 2: Termostat ON 1: Termostat OFF 3: Larm	Läs
23~31	(Används ej)	(Används ej)	(Används ej)

OBS! Offsetslägget är: 20000 + N*32 + adress enligt vad som visas i tabellen, där N är inomhusenhetens adress.

■ Konfigurationsmetod

Varje HARC-MODBUS kan kontrollera upp till 32 inomhusenheter. Med tanke på att upp till 128 inomhusenheter kan anslutas i samma H-LINK måste man ställa in vilka inomhusenheter som väljs för varje HARC-MODBUS.

Den här konfigurationen krävs inte för CHILLER-funktionen.

Inställningarna bygger på en ID-tabell med upp till 32 värden för tilldelning av varje inom- och utomhusenhets adress enligt följande:

Id	Kylmediecykeladress	Adress till inomhusenhet
00	00	00
01	00	01
02	00	02
03	00	03
04	00	04
05	00	05
06	00	06
07	00	07
08	00	08
09	00	09
10	00	10
11	00	11
12	00	12
13	00	13
14	00	14
15	00	15

Id	Kylmediecykeladress	Adress till inomhusenhet
16	01	00
17	01	01
18	01	02
19	01	03
20	01	04
21	01	05
22	01	06
23	01	07
24	01	08
25	01	09
26	01	10
27	01	11
28	01	12
29	01	13
30	01	14
31	01	15



Viktigt!

- För 1 HARC-MODBUS kan upp till 32 inomhusenheter från 16 olika kylmediecykler eller 32 inomhusenheter från samma kylmediecykel väljas.



Varning!

- Försäkra dig om att du inte ställer in samma inomhusenhet till fler än en HARC-MODBUS. Detta fel kan inte upptäckas och kan leda till oönskade åtgärder.

Nr	Åtgärd	Display (7 segment)	Kommentarer
1	Tryck på SW4 i 3 sekunder	1d	Konfigurationsläge valt
2	Tryck på SW4	00	Välj ID (inomhusenhet) från 0 31 genom att trycka SW5 ▲ eller SW6 ▼
3	Tryck på SW4	0U :	Kylmediecykeladress
4	Tryck på SW4	-->00	Välj kylmediecykeladress från 0 till 15 (t.ex. 00) (genom att trycka på SW5 ▲ och SW6 ▼)
5	Tryck på SW4	1U :	Adress till inomhusenhet
6	Tryck på SW4	-->00	Välj inomhusenhetens adress från 0 till 15 (t.ex. 00) (genom att trycka på SW5 ▲ och SW6 ▼)
För "ID" 01 upprepa steg 1 till 6			
7	Tryck på SW4 i 3 sekunder	1d	Konfigurationsläge valt
8	Tryck på SW4	00→01	Välj ID (inomhusenhet) från 0 31 genom att trycka SW5 ▲ eller SW6 ▼
9	Tryck på SW4	0U :	Kylmediecykeladress
10	Tryck på SW4	-->00	Välj kylmediecykeladress från 0 till 15 (t.ex. 00) (genom att trycka på SW5 ▲ och SW6 ▼)
11	Tryck på SW4	1U :	Adress till inomhusenhet
12	Tryck på SW4	-->01	Välj inomhusenhetens adress från 0 till 15 (t.ex. 01, tryck på SW5 en gång) (genom att trycka på SW5 ▲ och SW6 ▼)
.. Upprepa steg 1 till 6 för alla övriga "ID"			
187	Tryck på SW4 i 3 sekunder	1d	Konfigurationsläge valt
188	Tryck på SW4	00→31	Välj ID (inomhusenhet) från 0 31 genom att trycka SW5 ▲ eller SW6 ▼
189	Tryck på SW4	0U :	Kylmediecykeladress
190	Tryck på SW4	-->01	Välj kylmediecykeladress från 0 till 15 (t.ex. 01, tryck på SW5 en gång) (genom att trycka på SW5 ▲ och SW6 ▼)
191	Tryck på SW4	1U :	Adress till inomhusenhet
192	Tryck på SW4	-->15	Välj inomhusenhetens adress från 0 till 15 (t.ex. 15, tryck på SW6 en gång) (genom att trycka på SW5 ▲ och SW6 ▼)

6.2 CHILLER: Data tillgängliga

Address	Benämning	Beskrivning	Värden	Läs/skriv
0	EXIST	Finns	0: Finns ej 1: Finns	Läs
1	SYSTEM_ADDRESS	CHILLER-adress	0~ 15 i H-LINK 1	Läs
2	(Används ej)	(Används ej)	(Används ej)	(Används ej)
3	ONOFF_SET	På/av-inställningsordning:	0: Stopp 1: Kör	Läs/skriv
4	MODE_SET	Inställningsordning för läge	0: Svait 1: Varmt	Läs/skriv
5	TEMP_SET_C	COOL-temperatur	(se anmärkning*)	Läs/skriv
6	TEMP_SET_H	HEAT-temperatur		
7	CENTRAL_SET	Centralinställning	0: Lokal 1: Fjärr-	Läs/skriv
8	ONOFF_STATUS	AV/PÅ-status	0: Av 1: På	Läs
9	MODE_STATUS	Lägesstatus	0: Svait 1: Varmt	Läs
10	TEMP_C_STATUS	Status för COOL-temperatur		Läs
11	TEMP_H_STATUS	Status för HEAT-temperatur		Läs
12	WATER_INLET	Inloppstemperatur		Läs
13	WATER_OUTLET	Utloppstemperatur		Läs
14	AMBIENT_TEMPERATURE	Omgivningstemperatur		Läs
15	OPER_CONDITION	Enhetens driftsvillkor	0: OFF 1: Termostat OFF 2: Termostat ON 3: Larm	Läs
16	ERROR_CODE_CH	Larmkod för allmänt CHILLER-larm		Läs
17~22	ERROR_CODE_CYC	Larmkod för cykellarm (1-6)		Läs
23~31	(Används ej)	(Används ej)	(Används ej)	(Används ej)

**Anm:**

- Offsetläget är: 40000 + N*32 + adress enligt vad som visas i tabellen, där N är vattenkylarens adress.
- Parametrarna Status (faktiskt värde) och Set (börvärde) har oftast samma värde, men kan i vissa fall skilja sig åt. Du bör använda Set-parametrarna vid normaldrift.
- *) När temperaturinställning och driftsläge ändras vid samma tillfälle bör du först ändra driftsläget och därefter välja önskad temperatur.

6.3 CHILLER-larmkoder

6.3.1 Lista över CHILLER-larmkoder

CHILLER-larm		Beskrivning	H-LINK
7SEG1	7SEG2		Code
11	11	Fel i termistor för vatteninloppstemperatur	20
12	12	Fel i termistor för vattenutloppstemperatur (endast för enhet med en cykel)	21
22	22	Fel i termistor för omgivningstemperatur (öppen/sluten)	24
5P	5P	Ingen återkopplingsignal från vattenpump	26
13	13	Aktivering av frysskydd (endast för enheter med en cykel)	27
6E	6E	Vattenlarm (differentialtrycksbrytare eller flödesväxlare)-kondensor	28
6E	6E	Vattenlarm (differentialtrycksbrytare eller flödesväxlare)-evaporator	29
14	14	Aktivering av termostat för mycket hög vattentemperatur (endast för enhet med en cykel)	30
RP	RP	Aktivering av ytterligare skyddsanordning	31
05	05	Fasfel	32
EP	EP	Fel i kommunikation mellan styrkrets (PCB _{C1} , PCB _{C2})	33
03	03	Fel i kommunikation mellan kylare och fjärrkontroll (H-LINK)	34
EU	EU	Fel i kommunikation mellan expansionsventilkrets och styrkrets	36
40	40	Driftfel	40~45, 47,47,54

6.3.2 Lista över cykellarmkoder

Cykellarm		Beskrivning	H-LINK
7SEG1	7SEG2		Code
L _n	H _n	Aktivering av högttrycksvakt	1
L _n	L _n	Aktivering av styrning av lågtrycksvakt	2
L _n	n _n	Aktivering av kompressorns interna termostat	3
L _n	B _n	Aktivering av termistor för utloppsgas	4
L _n	S _n	Aktivering av termalrejä för kompressor eller feltfunktion på ARm-relå	5
L _n	F ₀	Felaktig inställning av fläktnummer	6
L _n	4 _n	Aktivering av fläktnorns interna termostat	7
L _n	L _n	För lågt tryck	8
L _n	9 _n	För låg temperatur på kylmedium för kylarlinlopp	10
L _n	2 ₇	Fel i tryckgivare för utloppsgas (öppen/kort)	11
L _n	2 ₈	Fel i tryckgivare för insugsgas (öppen/kort)	12
L _n	1 ₂	Fel i termistor för vattenutloppstemperatur (för enheter med fler än en cykel)	14
L _n	2 ₃	Fel i termistor för utloppsgas (öppen/kort)	15
L _n	2 ₆	Fel i termistor för insugsgas (öppen/kort)	16
L _n	0 ₅	Fasfel	17
L _n	2 ₁	Fel i termistor för kylmedium vid kylarlinlopp (öppen/kort)	19
L _n	b _n	Aktivering av termistor för insugsgas	20
L _n	1 ₃	Aktivering av frysskydd (för enheter med fler än en cykel)	21
L _n	2 ₄	Fel i termistorer före expansionsventil (öppen/kort)	23
L _n	2 ₅	Fel i termistor för vattenutlopp - kylarens baksida (öppen/kort)	24
F _n	5 ₁	Onormal strömförsörjning för växelriktare	34

7. Felsökning

Nr	Larmkod	Beskrivning	Åtgärd
1	EE→B!	Inomhusenheter har inte kommunicerat med HARC-MODBUS under de senaste 10 minuterna	<ol style="list-style-type: none"> Kontrollera att H-LINK-anslutningen mellan HARC (K1) och inomhusenheterna fungerar. Kontrollera att alla aggregat är strömsatta.
2	EE→B3	Inomhusenheter har aldrig kommunicerat med HARC-MODBUS	<ol style="list-style-type: none"> Kontrollera att H-LINK-anslutningen mellan HARC (K1) och inomhusenheterna fungerar. Kontrollera att alla aggregat är strömsatta.
3	D7 är alltid av	Ingen lysdiod blinkar på krets-kortet och alla 7 segmenten är släckta	 Anm: - Strömkällans utgående I/ksström har en vridomkopplare som måste ställas in på +5 V DC. - D7 måste vara på.
4	D12 blinkar aldrig	HARC-MODBUS läser eller skickar inte data (D12 blinkar aldrig)	<ol style="list-style-type: none"> Kontrollera anslutningen mellan MODBUS-enheterna och K5.
5	D12 blinkar inte	HARC fungerar inte (D13 blinkar inte)	<ol style="list-style-type: none"> Kontrollera att SW3 är i läget RUN. Ändra annars till läget RUN och tryck på RESET.
6	D4 och D11 blinkar inte	Det finns ingen H-LINK-kommunikation från HARC-MODBUS	<ol style="list-style-type: none"> D4 blinkar men inte D11. → Se rad 6, åtgärd 1. Vare sig D4 eller D11 blinkar. → Se rad 3, åtgärd 1.

Περιεχόμενα

1.	Σύνοψη ασφαλείας	148
2.	Ονομασίες εξαρτημάτων	148
3.	Προδιαγραφές	149
4.	Εργασίες εγκατάστασης	150
4.1	Στοιχεία διαστάσεων	150
4.2	Στρέψωση	150
5.	Συνδέσεις καλωδίων	151
5.1	Ηλεκτρική καλωδίωση	151
5.2	Ρύθμιση διακοπών εναλλαγής	152
6.	Λειτουργία	156
6.1	PACKAGED: Διάθεσιμα δεδομένα	156
6.2	CHILLER: Διάθεσιμα δεδομένα	159
6.3	Λίστα κωδικών προειδοποίησης CHILLER	160
6.3.1	Λίστα κωδικών προειδοποίησης CHILLER	160
6.3.2	Λίστα κωδικών προειδοποίησης κύκλου	161
7.	Αντιμετώπιση προβλημάτων	162



Σημείωση:

Το εγχειρίδιο αυτό παρέχει βασικές πληροφορίες για την εγκατάσταση και την καλωδίωση της συσκευής CSNET-WEB.

3. Προδιαγραφές

Προδιαγραφές υλικού

Στοιχείο	Προδιαγραφές
Τροφοδοσία ηλεκτρικού πεύματος	1~230 V ±10% 50 Hz
Κατανάλωση	25 W (μέγιστο)
Εξωτερικές διαστάσεις	Πλάτος: 143 mm, Βάθος: 302 mm, Ύψος: 76 mm
Βάρος	1,75 kg
Συνθήκες συναρμολόγησης	Σε εσωτερικό χώρο (σε πίνακα ελέγχου ή σε επιφάνεια εργασίας)
Θερμοκρασία περιβάλλοντος	0~40 °C
Υγρασία	20~85% (Χωρίς συμπύκνωση)

MODBUS - Επικοινωνία με το άνω σύστημα

Στοιχείο	Προδιαγραφές
K5	Σειριακή θύρα RS485 (Ακροδέκτης 3 ακίδων) - Πρωτόκολλο MODBUS
Γραμμή επικοινωνίας	Καλώδιο συνεστραμμένου ζεύγους. Πολικότητα
Σύστημα επικοινωνίας	Ημι-αμφίδρομη, πολυσημιακή σειριακή σύνδεση
Μέθοδος επικοινωνίας	Χωρίς ισοτιμία ή επιλογή περιτήζ/δρτιας ισοτιμίας Μήκος δεδομένων: 8 bit (βλ. κεφάλαιο 5)
Μετδδοση ρυθμού σε baud	19200/9600 Baud (βλ. κεφάλαιο 5)
Μήκος	μεγ. 1200 m κατά EIA-485

H-LINK - Επικοινωνία με μονάδες

Στοιχείο	Προδιαγραφές
Επικοινωνία με	HITACHI PACKAGED/CHILLER
Γραμμή επικοινωνίας	Θωρακισμένο καλώδιο συνεστραμμένου ζεύγους, χωρίς πολικότητα
Σύστημα επικοινωνίας	Ημι-αμφίδρομη
Μέθοδος επικοινωνίας	Ασύγχρονη
Ταχύτητα μετάδοσης	9600 Baud
Μήκος καλωδίωσης	1000 m μέγιστο (συνολικό μήκος του διαύλου HLINK I/O)
Μέγιστος αριθμός HARC MODBUS	8 HARC-MODBUS/H-LINK SYSTEM (PACKAGED) 1 HARC-MODBUS/H-LINK SYSTEM (CHILLER)



Προσοχή:

Το HARC-MODBUS δεν μπορεί να λειτουργήσει με εσωτερικές μονάδες αν δεν υπάρχει συνδεδεμένο χειριστήριο.

4. Εργασίες εγκατάστασης

Όταν ξεπакτιράτε το HARC-MODBUS, βεβαιωθείτε ότι δεν υπάρχει κάποια ζημιά από τη μεταφορά.

4.1 Στοιχεία διαστάσεων

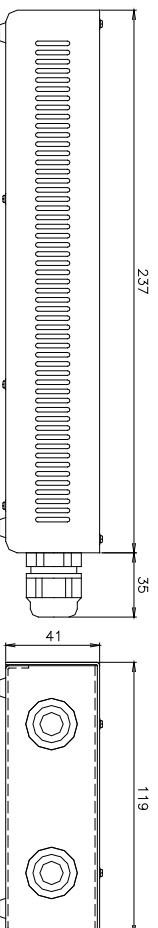

4.2 Στέψωση

Εκτελέστε την παρακάτω διαδικασία:

1. Αφαιρέστε τα ελαστικά στηρίγματα.
2. Ξεβιδώστε τις 4 βίδες από το επάνω κάλυμμα και αφαιρέστε το.
3. Προσαρμόστε το πλαίσιο στην στον πίσω κατακόρυφο πίνακα από το εσωτερικό με βίδες M5 (πωλούνται ξεχωριστά) και τοποθετήστε ροδέλες διαμέτρου 3 mm στο εξωτερικό για να διαχωρίσετε το πλαίσιο από τον τοίχο.
4. Τοποθετήστε και πάλι το επάνω κάλυμμα. Προσέξτε να το τοποθετήσετε σωστά.
5. Κρατήστε ελεύθερη την αποξεσμένη περιοχή για εξεραρισμό και σύνδεση καλωδίου.

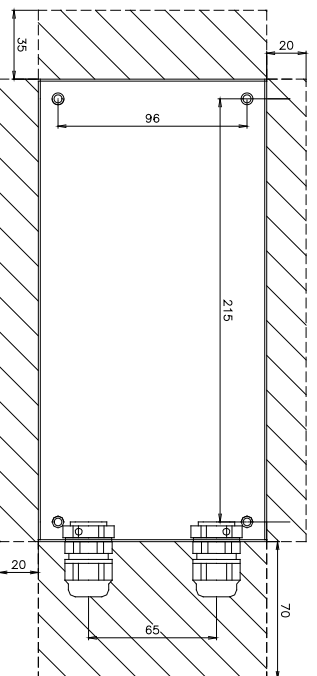

⚠ Προσοχή:

- Πρωτοῦ συνδέσετε το ρεύμα και ενεργοποιήστε το HARC-MODBUS θα πρέπει να βεβαιωθείτε ότι:

1. Όλα τα κυκλώματα προς σύνδεση έχουν τοποθετηθεί σωστά.

2. Έχουν γίνει όλες οι συνδέσεις H-Link.

3. Ακολουθήστε τους τοπικούς κανονισμούς για την ηλεκτρική εγκατάσταση του HARC-MODBUS και των σχετικών κυκλωμάτων.

Εάν κάποια μονάδα δεν είναι συνδεδεμένη ή δεν έχει προφοδοσία ρεύματος όταν ενεργοποιήσετε το HARC-MODBUS, η μονάδα δεν θα αναγνωριστεί και θα πρέπει να ρυθμιστεί αργότερα.

⚠ Προσοχή:

- Τα καλώδια σήματος θα πρέπει έχουν το μικρότερο δυνατό μήκος. Να κρατάτε σε απόσταση μεγαλύτερη από 150 mm από άλλα καλώδια ρεύματος. Μην τα συνδέετε μεταξύ τους (αν και μπορεί να διασταυρώνονται). Εάν θα πρέπει οπωσδήποτε να εγκατασταθούν μαζί, λάβετε τα παρακάτω μέτρα ώστε να αποφύγετε τη δημιουργία θορύβου:

- Προστατέψτε κάθε καλώδιο σήματος με έναν μεταλλικό σωλήνα ο οποίος είναι γειωμένος στην μια άκρη.

- Για την επικοινωνία, να χρησιμοποιείτε θωρακισμένο καλώδιο το οποίο είναι γειωμένο στην μια άκρη.

⚠ Κίνδυνος:

- Πάντα να αποσυνδέετε την προφοδοσία ρεύματος από το HARC-MODBUS όταν χειρίζεστε το μηχάνημα, ώστε να αποφευχθούν οι ηλεκτρικές εκκενώσεις.

- Μην συνδέετε τη διαταπή με την προφοδοσία ρεύματος, έως ότου ολοκληρωθεί η εγκατάσταση.

- Να τηρείτε αυστηρά τους τοπικούς κανονισμούς και διατάξεις ασφαλείας όταν συνδέετε το μηχάνημα με το δίκτυο ηλεκτροδοτήσεως.

- Θα χρειαστείτε ένα τρίτο καλώδιο (δυο καλώδια και μια γείωση) με κατάλληλο βύσμα στο ένα άκρο.

5. ΣΥΝΔΕΣΕΙΣ ΚΑΛΩΔΙΩΝ

5.1 ΗΛΕΚΤΡΙΚΗ ΚΑΛΩΔΙΩΣΗ

Για να λειτουργήσει, το HARC-MODBUS θα πρέπει να συνδεθεί με τα αντίστοιχα σημεία εισόδου και εξόδου, τα καλώδια παροχής ρεύματος και τη γραμμή ελέγχου H-Link.

Αρ.	Σύνδεση	Προδιαγραφές καλωδίου
1	Κύκλωμα παροχής ρεύματος 1~ 230 V 50 Hz 25 W (Με κύκλωμα προστασίας)	Επιλέξτε καλώδια σύμφωνα με τους τοπικούς κανονισμούς (ελάχιστο συνιστώμενο 1,5 mm ² H05RN-F)
2	MODBUS	καλώδιωση 3 καλωδίων 0,75 mm ² (τύπου H05RN-F). Χρησιμοποιήστε διαφορετικό χρώμα για κάθε καλώδιο. (Σειριακή θύρα RS485)
3	H-LINK	Καλώδια επικοινωνίας για τη σύνδεση του HARC MODBUS σε μια εγκατάσταση Hitachi μέσω CSNET WEB ή σε οποιαδήποτε μονάδα Hitachi μέσω ακροδεκτών H-LINK. Θωρακισμένο καλώδιο συνεστραμμένου ζεύγους 0,75 mm ² (ΤΥΠΟΥ H05RN-F). Η θωράκιση πρέπει να είναι γειωμένη μόνο στη μία πλάτη.
4	Παροχή ρεύματος σε πλάκες τυπωμένων κυκλωμάτων (PCB) +5 V DC. I _{max} = 5 A DC	Καλώδιο ζεύγους 0,75 mm ² (ΤΥΠΟΥ H05RN-F).



Σημείωση:

Όλα τα καλώδια, εκτός από 4 δεν παρέχονται.

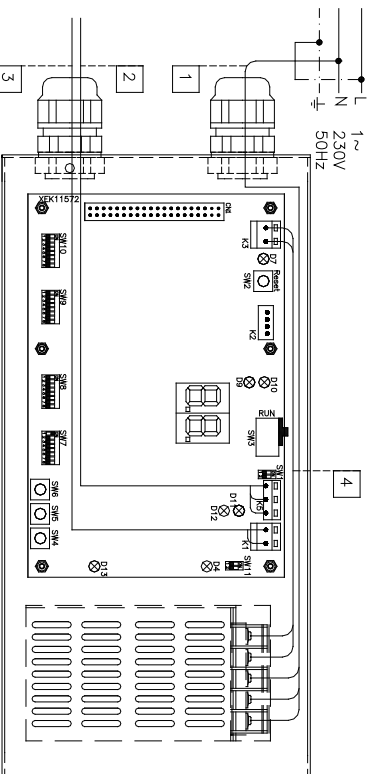

Μη παρεχόμενα μέσα προστασίας:

CB/EF: 5 A

ΔΔΓ: 2/40 A/30 mA

ΔΚ: Διακόπτης κυκλώματος

ΕF: Ηλεκτρική ασφάλεια



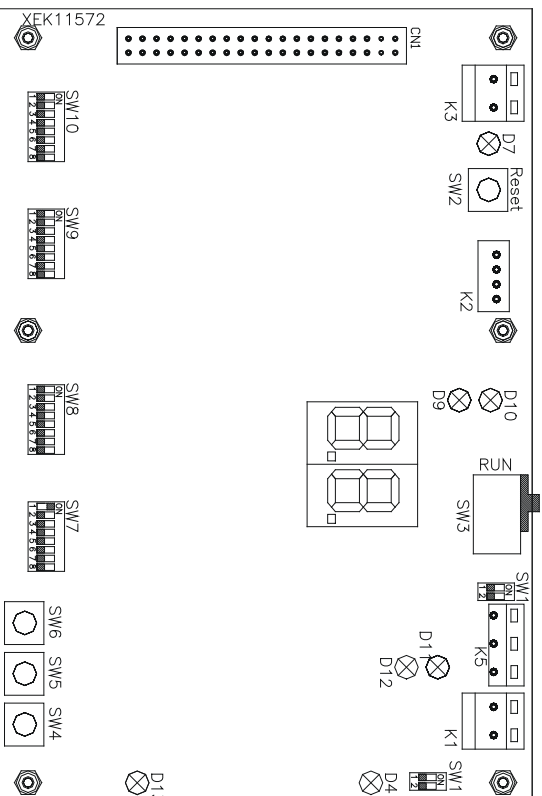

ΔΔΓ: Διακόπτης διαρροής ρεύματος

5.2 Ρύθμιση Διακοπών εναλλαγής

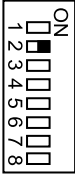

Όνομα	Λειτουργία	Εργοστασιακή ρύθμιση	Περιγραφή
SW1	Δεν διατίθεται	ON 1 2	Όλα σε off (καμία λειτουργία)
SW2	Επαναφορά	-	Κουμπι επαναφοράς. Προς Χρήση σε περίπτωση που κλειδωθεί το πρόγραμμα
SW3 (TELE)	Δεν διατίθεται	RUN	Κατασκευαστικοί λόγοι. Μην το αλλάζετε ποτέ
SW4	Ρύθμιση παραμέτρων	-	Ρύθμιση λειτουργιών
SW5	Ρύθμιση παραμέτρων	-	Ρύθμιση λειτουργιών
SW6	Ρύθμιση παραμέτρων	-	Ρύθμιση λειτουργιών
SW7	Επιλογές 2	ON 1 2 3 4 5 6 7 8	SW7-1: OFF-SLAVE / ON-MASTER. Χρησιμοποιείται σε περίπτωση ύπαρξης αγκερών HARC-MODBUS στην ίδια διεύθυνση H-LINK SW7-2: OFF-EVENT CONTROL/ON-CHANGE CONTROL SW7-3: OFF - Ανεργοποιημένη ισοτιμία / ON - Ενεργοποιημένη ισοτιμία SW7-4: OFF - Άρτια ισοτιμία / ON - Πιπτητή ισοτιμία SW7-5: OFF - 19200 Bps / ON - 9600 Bps SW7-(6-8): Δεν χρησιμοποιείται
SW8	Επιλογές 1 (Τύπος εφαρμογής)	ON 1 2 3 4 5 6 7 8	SW8-1: OFF-PAACKAGED / ON-CHILLER. Προς ρύθμιση σύμφωνα με την εφαρμογή μονάδων SW8-2~8: Δεν Χρησιμοποιείται
SW9	Δεν διατίθεται	ON 1 2 3 4 5 6 7 8	Όλα σε off (καμία λειτουργία)
SW10	Διεύθυνση HARC-MODBUS	ON 1 2 3 4 5 6 7 8	Διεύθυνση HARC-MODBUS από 1 έως 32 από ακίδες 1 έως 5
SW11	H-LINK DSW	ON 1 2	DSW 2 ακίδων SW11-1: πραγματική αντίσταση H-LINK SW11-2: Προστασία με ασφάλεια H-LINK
D4, D11	H-LINK	-	Μετάδοση H-LINK
D7	λογίς	-	Παροχή πέμματος ON/OFF
D9/D10	Δεν Χρησιμοποιείται	-	-
D12	MODBUS	-	Επικοινωνία Modbus σε RS485
D13	Λειτουργία	-	Κανονική Λειτουργία λογισμικού

■ SW7 – ΡΥΘΜΙΣΗ ΛΕΙΤΟΥΡΓΙΩΝ 1

SW7	Περιγραφή
 ON <input checked="" type="checkbox"/> <input type="checkbox"/> <input type="checkbox"/> <input type="checkbox"/> <input type="checkbox"/> <input type="checkbox"/> <input type="checkbox"/> <input type="checkbox"/> 1 2 3 4 5 6 7 8  ON <input checked="" type="checkbox"/> <input type="checkbox"/> <input type="checkbox"/> <input type="checkbox"/> <input type="checkbox"/> <input type="checkbox"/> <input type="checkbox"/> <input type="checkbox"/> 1 2 3 4 5 6 7 8	<p>Ρύθμιση ως MASTER/SLAVE: MASTER: SW7-1=ON Μόνο ένα HARC-MODBUS μπορεί να ρυθμιστεί ως MASTER HARC-MODBUS Ρύθμιση ως προεπιλογή</p> <p>SLAVE: SW7-1= OFF Θα πρέπει να διαμορφωθεί 1 HARC-MODBUS ως MASTER, όλα τα υπόλοιπα HARC-MODBUS πρέπει να διαμορφωθούν ως SLAVE στο ίδιο H-LINK</p> <p>Λειτουργία ανανέωσης δεδομένων Ρύθμιση ως EVENT CONTROL: SW7-2:OFF Οι παράμετροι ανανεώνονται στην Εσωτ. μον. κάθε φορά που το BMS εγγράφει μία παράμετρο ρύθμισης (ακόμα και αν δεν αλλάζει καμία τιμή). Ρύθμιση ως προεπιλογή</p> <p>Ρύθμιση ως CHANGE CONTROL: SW7-2:ON Οι παράμετροι ανανεώνονται στην Εσωτ. μον. μόνο όταν αλλάζουν ορισμένες τιμές</p>
 ON <input checked="" type="checkbox"/> <input type="checkbox"/> <input type="checkbox"/> <input type="checkbox"/> <input type="checkbox"/> <input type="checkbox"/> <input type="checkbox"/> <input type="checkbox"/> 1 2 3 4 5 6 7 8  ON <input checked="" type="checkbox"/> <input type="checkbox"/> <input type="checkbox"/> <input type="checkbox"/> <input type="checkbox"/> <input type="checkbox"/> <input type="checkbox"/> <input type="checkbox"/> 1 2 3 4 5 6 7 8  ON <input checked="" type="checkbox"/> <input type="checkbox"/> <input type="checkbox"/> <input type="checkbox"/> <input type="checkbox"/> <input type="checkbox"/> <input type="checkbox"/> <input type="checkbox"/> 1 2 3 4 5 6 7 8	<p>Ρύθμιση Ισοτιμίας SW7-3: OFF: Ρύθμιση χωρίς ισοτιμία SW7-3: ON: Επικοινωνία ισοτιμίας (βλ. SW7-4 ρύθμιση τύπου ισοτιμίας)</p> <p>Ρύθμιση τύπου ισοτιμίας SW7-4: OFF: Άρτια ισοτιμία (έάν SW7-3 είναι στη θέση ON) SW7-4: ON: Περιττή ισοτιμία (έάν SW7-3 είναι στη θέση ON)</p> <p>Ρυθμός επικοινωνίας σε baud SW7-5: OFF 19200 Bps SW7-5: ON 9600 Bps</p>

■ SW8 – ΡΥΘΜΙΣΗ ΛΕΙΤΟΥΡΓΙΩΝ 2

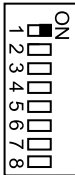
SW8	Περιγραφή
 ON <input checked="" type="checkbox"/> <input type="checkbox"/> <input type="checkbox"/> <input type="checkbox"/> <input type="checkbox"/> <input type="checkbox"/> <input type="checkbox"/> <input type="checkbox"/> 1 2 3 4 5 6 7 8  ON <input checked="" type="checkbox"/> <input type="checkbox"/> <input type="checkbox"/> <input type="checkbox"/> <input type="checkbox"/> <input type="checkbox"/> <input type="checkbox"/> <input type="checkbox"/> 1 2 3 4 5 6 7 8	<p>Πύθμιση παραμέτρων για εφαρμογές PACKAGED / CHILLER Εφαρμογές PACKAGED: SW8-1: OFF Εφαρμογές CHILLER: SW8-1: ON (Ενεργοποίηση)</p>

■ SW10 – H-LINK διεύθυνσης HARC (Ίδια σχεδίαση διεύθυνσης εξωτερικής μονάδας/κύκλου ψύξης)

SW10				Περιγραφή
Διεύθυνση: 1 ON 1 2 3 4 5 6 7 8	Διεύθυνση: 2 ON 1 2 3 4 5 6 7 8	Διεύθυνση: 3 ON 1 2 3 4 5 6 7 8	Διεύθυνση: 4 ON 1 2 3 4 5 6 7 8	<p>Διμόρφωση διεύθυνσης HARC Διεύθυνση HARC-MODBUS που Χρησιμοποιείται από το σύστημα MODBUS</p> <p>Οι ακίδες 1~5 του SW10 πρέπει να ρυθμιστούν σύμφωνα με το αντίστοιχο σχέδιο της επιθυμητής διεύθυνσης</p> <p>Οι ακίδες 6~8 του SW10 πρέπει να παραμείνουν σε OFF</p>
Διεύθυνση: 5 ON 1 2 3 4 5 6 7 8	Διεύθυνση: 6 ON 1 2 3 4 5 6 7 8	Διεύθυνση: 7 ON 1 2 3 4 5 6 7 8	Διεύθυνση: 8 ON 1 2 3 4 5 6 7 8	
Διεύθυνση: 9 ON 1 2 3 4 5 6 7 8	Διεύθυνση: 10 ON 1 2 3 4 5 6 7 8	Διεύθυνση: 11 ON 1 2 3 4 5 6 7 8	Διεύθυνση: 12 ON 1 2 3 4 5 6 7 8	
Διεύθυνση: 13 ON 1 2 3 4 5 6 7 8	Διεύθυνση: 14 ON 1 2 3 4 5 6 7 8	Διεύθυνση: 15 ON 1 2 3 4 5 6 7 8	Διεύθυνση: 16 ON 1 2 3 4 5 6 7 8	
Διεύθυνση: 17 ON 1 2 3 4 5 6 7 8	Διεύθυνση: 18 ON 1 2 3 4 5 6 7 8	Διεύθυνση: 19 ON 1 2 3 4 5 6 7 8	Διεύθυνση: 20 ON 1 2 3 4 5 6 7 8	
Διεύθυνση: 21 ON 1 2 3 4 5 6 7 8	Διεύθυνση: 22 ON 1 2 3 4 5 6 7 8	Διεύθυνση: 23 ON 1 2 3 4 5 6 7 8	Διεύθυνση: 24 ON 1 2 3 4 5 6 7 8	
Διεύθυνση: 25 ON 1 2 3 4 5 6 7 8	Διεύθυνση: 26 ON 1 2 3 4 5 6 7 8	Διεύθυνση: 27 ON 1 2 3 4 5 6 7 8	Διεύθυνση: 28 ON 1 2 3 4 5 6 7 8	
Διεύθυνση: 29 ON 1 2 3 4 5 6 7 8	Διεύθυνση: 30 ON 1 2 3 4 5 6 7 8	Διεύθυνση: 31 ON 1 2 3 4 5 6 7 8	Διεύθυνση: 32 ON 1 2 3 4 5 6 7 8	

■ Παράδειγμα

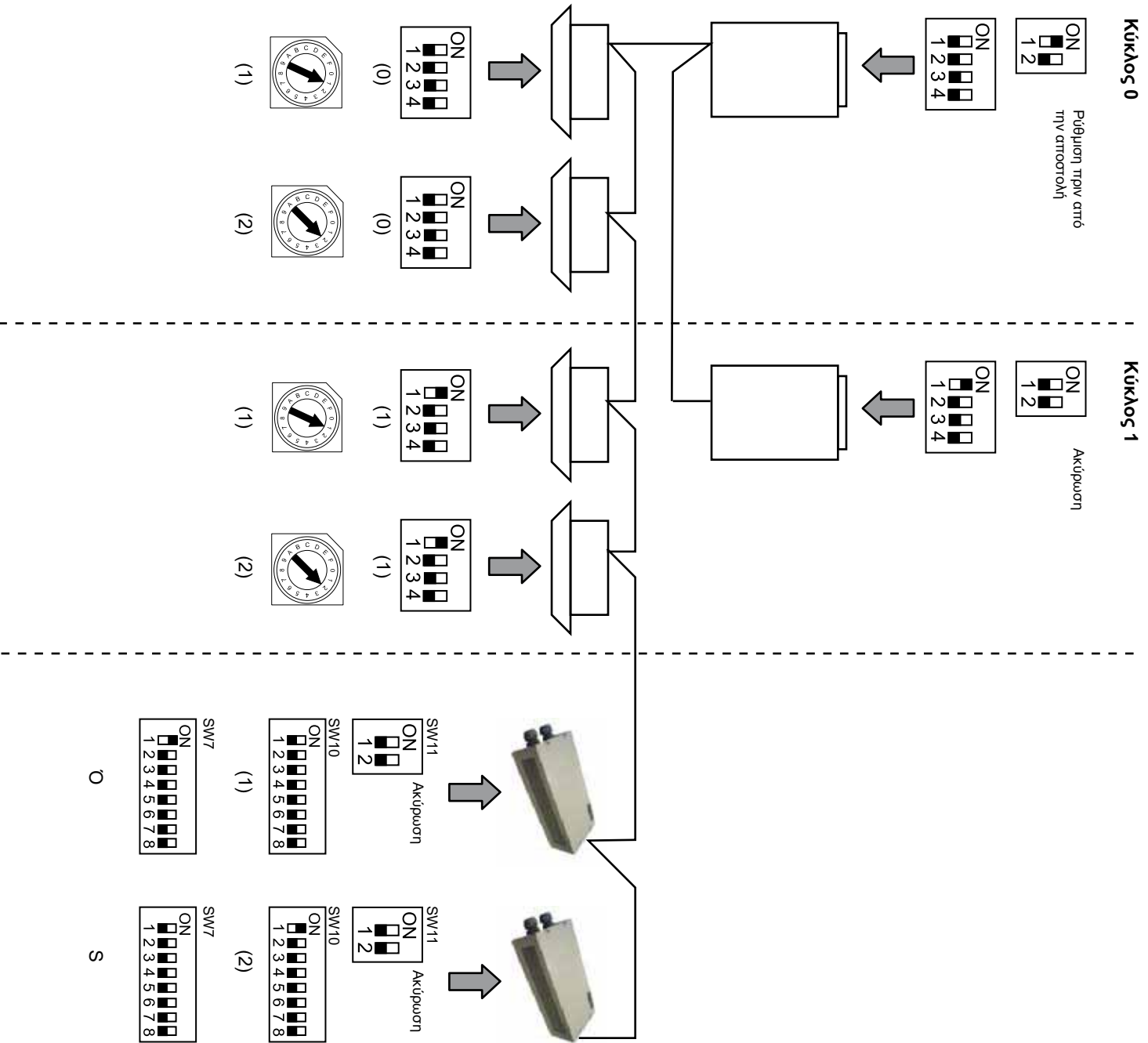

6. Λειτουργία

6.1 PACKAGED: Διαθέσιμα δεδομένα

Διεύθυνση (Σημείωση 1)	Όνομα	Περιγραφή	Ανάγνωση/Εγγραφή
0	EXIST	EXIST: 0: Δεν υπάρχει 1: Υπάρχει	Ανάγνωση
1	SYSTEM_ADDRESS	Διεύθυνση συστήματος: 0 ~ 15 σε H-LINK 1	Ανάγνωση
2	UNIT_ADDRESS	Διεύθυνση μονάδας: 0 ~ 15 σε H-LINK1	Ανάγνωση
3	SET_ONOFF	Εντολή ρύθμισης On/Off: 0: Διακοπή 1: Λειτουργία	Ανάγνωση/Εγγραφή
4	SET_MODE	Εντολή ρύθμισης κατάστασης λειτουργίας: 0: Ψύξη 2: Ανεμιστήρας 4: Αυτόματη	Ανάγνωση/Εγγραφή
5	SET_FAN	Εντολή ρύθμισης ανεμιστήρα: 0: Χαμηλή 2: Υψηλή 1: Μεσαία	Ανάγνωση/Εγγραφή
6	SET_TSET	Ρύθμιση θερμοκρασίας: 17 °C ~ 30 °C	Ανάγνωση/Εγγραφή
7	SET_LOUVER	Ρύθμιση περσίδων: 0 ~ 8 (το 8 είναι στην αυτόματη λειτουργία)	Ανάγνωση/Εγγραφή
8	SET_CENTRAL	Κεντρική ρύθμιση Bit 0: On/Off (μπορεί πάντα να σταματήσει) Bit 1: Κατάσταση Bit 2: Ρύθμιση θερμοκρασίας Bit 3: Ανεμιστήρας	Ανάγνωση/Εγγραφή
9	READ_ONOFF	Ανάγνωση On/Off: 0: Off 1: On	Ανάγνωση
10	READ_MODE	Ανάγνωση κατάστασης 0: Ψύξη 2: Ανεμιστήρας 3: Θέρμανση 4: Αυτόματη	Ανάγνωση
11	READ_FAN	Ανάγνωση ανεμιστήρα 0: Χαμηλή 2: Υψηλή 1: Μεσαία	Ανάγνωση
12	READ_TSET	Ρύθμιση ανάγνωσης θερμοκρασίας (17 °C έως 30 °C)	Ανάγνωση
13	READ_LOUVER	Ανάγνωση περσίδων 0 ~ 8 (το 8 είναι στην αυτόματη λειτουργία)	Ανάγνωση
14~18	(Δεν χρησιμοποιείται)	(Δεν χρησιμοποιείται)	(Δεν χρησιμοποιείται)
19	ERROR_CODE	Κωδικός προειδοποίησης	Ανάγνωση
20~21	(Δεν χρησιμοποιείται)	(Δεν χρησιμοποιείται)	(Δεν χρησιμοποιείται)
22	OPER_CONDITION	Κατάσταση λειτουργίας μονάδας 0: OFF 2: Θερμοστάτης ON 1: Θερμοστάτης OFF 3: Προειδοποίηση	Ανάγνωση
23~31	(Δεν χρησιμοποιείται)	(Δεν χρησιμοποιείται)	(Δεν χρησιμοποιείται)

Σημείωση 1: Η θέση ρύθμισης off είναι: διεύθυνση 20000 + N*32 + ότως φαίνεται στον πίνακα, όπου N είναι η διεύθυνση εσωτερικής μονάδας.

■ Μέθοδος ρύθμισης παραμέτρων

Κάθε HARC-MODBUS μπορεί να ελέγξει έως και 32 Εσωτ. μον., δεδομένου ότι στο ίδιο H-LINK μπορούν να συνδεθούν έως και 128 Εσωτ. μον., πρέπει να καθοριστούν ποιες εσωτερικές μονάδες επιλέγονται για κάθε HARC-MODBUS.

Δεν απαιτείται αυτή η ρύθμιση παραμέτρων σε περίπτωση εφαρμογής CHILLER.

Ο σχεδιασμός ρύθμισης συνίσταται σε έναν πίνακα «Id» στον οποίο παρατίθενται έως και 32 αριθμοί για την εκχώρηση κάθε διεύθυνσης Εξ. μον. και Εσ. Μον., όπως φαίνεται παρακάτω:

Id	Διεύθυνση κύκλου ψύξης	Διεύθυνση εσωτερικής μονάδας
00	00	00
01	00	01
02	00	02
03	00	03
04	00	04
05	00	05
06	00	06
07	00	07
08	00	08
09	00	09
10	00	10
11	00	11
12	00	12
13	00	13
14	00	14
15	00	15

Id	Διεύθυνση κύκλου ψύξης	Διεύθυνση εσωτερικής μονάδας
16	01	00
17	01	01
18	01	02
19	01	03
20	01	04
21	01	05
22	01	06
23	01	07
24	01	08
25	01	09
26	01	10
27	01	11
28	01	12
29	01	13
30	01	14
31	01	15



Σημείωση:

- Μπορεί να επιλεγούν για 1 HARC-MODBUS έως και 32 Εσωτ. μον. από 16 διαφορετικούς κύκλους ψύξης ή 32 Εσωτ. μον. από τον ίδιο κύκλο ψύξης.



Προσοχή:

- Βεβαιωθείτε ότι δεν έχει ρυθμιστεί η ίδια εσωτερική μονάδα σε περισσότερα από ένα HARC-MODBUS. Αυτό το σφάλμα είναι μη ανχνεύσιμο και μπορεί να προκαλέσει μη επιθυμητές λειτουργίες.

Αρ.	Ενέργεια	7 Τμήματα (οθόνη)	Παρατηρήσεις
1	Πατήστε το SW4 για 3 δευτερόλεπτα	id	Επιλεγμένη λειτουργία ρύθμισης
2	Πατήστε SW4	00	Επιλογή Id (Αρ. εσωτ. μον.) από 0 έως 31 πατώντας SW5 ▲ ή SW6 ▼
3	Πατήστε SW4	all	Διεύθυνση κύκλου ψύξης
4	Πατήστε SW4	---→00	Επιλογή διεύθυνσης κύκλου ψύξης από 0 έως 15 (π.Χ. 00) (πατώντας SW5 ▲ & SW6 ▼)
5	Πατήστε SW4	all	Διεύθυνση εσωτερικής μονάδας
6	Πατήστε SW4	---→00	Επιλογή διεύθυνσης εσωτερικής μονάδας από 0 έως 15 (π.Χ. 00) (πατώντας SW5 ▲ & SW6 ▼)
Για το «id» 01 επαναλάβετε τα βήματα 1 έως 6			
7	Πατήστε το SW4 για 3 δευτερόλεπτα	id	Επιλεγμένη λειτουργία ρύθμισης
8	Πατήστε SW4	00→01	Επιλογή Id (Αρ. εσωτ. μον.) από 0 έως 31 πατώντας SW5 ▲ ή SW6 ▼
9	Πατήστε SW4	all	Διεύθυνση κύκλου ψύξης
10	Πατήστε SW4	---→00	Επιλογή διεύθυνσης κύκλου ψύξης από 0 έως 15 (π.Χ. 00) (πατώντας SW5 ▲ & SW6 ▼)
11	Πατήστε SW4	all	Διεύθυνση εσωτερικής μονάδας
12	Πατήστε SW4	---→01	Επιλογή διεύθυνσης εσωτερικής μονάδας από 0 έως 15 (π.Χ. για 01; πατήστε το SW5 μία φορά) (πατώντας SW5 ▲ & SW6 ▼)
... Για όλα τα εντοπιζόμενα «id», επαναλάβετε τα βήματα 1 έως 6			
187	Πατήστε το SW4 για 3 δευτερόλεπτα	id	Επιλεγμένη λειτουργία ρύθμισης
188	Πατήστε SW4	00→31	Επιλογή Id (Αρ. εσωτ. μον.) από 0 έως 31 πατώντας SW5 ▲ ή SW6 ▼
189	Πατήστε SW4	all	Διεύθυνση κύκλου ψύξης
190	Πατήστε SW4	---→01	Επιλογή διεύθυνσης κύκλου ψύξης από 0 έως 15 (π.Χ. για 01; πατήστε το SW5 μία φορά) (πατώντας SW5 ▲ & SW6 ▼)
191	Πατήστε SW4	all	Διεύθυνση εσωτερικής μονάδας
192	Πατήστε SW4	---→15	Επιλογή διεύθυνσης εσωτερικής μονάδας από 0 έως 15 (π.Χ. για 15; πατήστε το SW6 μία φορά) (πατώντας SW5 ▲ & SW6 ▼)

6.2 CHILLER: Διαθέσιμα δεδομένα

Διεύθυνση	Όνομα	Περιγραφή	Τιμές	Ανάγνωση/ Εγγραφή
0	EXIST	Υπάρχει	0: Δεν υπάρχει 1: Υπάρχει	Ανάγνωση
1	SYSTEM_ADDRESS	Διεύθυνση Chiller	0~ 15 σε H-LINK 1	Ανάγνωση
2	(Δεν Χρησιμοποιείται)	(Δεν Χρησιμοποιείται)	(Δεν Χρησιμοποιείται)	(Δεν Χρησιμοποιείται)
3	ONOFF_SET	Εντολή ρύθμισης On/Off:	0: Διακοπή 1: Λειτουργία	Ανάγνωση/ Εγγραφή
4	MODE_SET	Εντολή ρύθμισης κατάστασης λειτουργίας	0: Ψύξη 1: Θέρμανση	Ανάγνωση/ Εγγραφή
5	TEMP_SET_C	Ρύθμιση θερμοκρασίας COOL	(βλ.πίε σημείωση *)	Ανάγνωση/ Εγγραφή
6	TEMP_SET_H	Ρύθμιση θερμοκρασίας HEAT		Ανάγνωση/ Εγγραφή
7	CENTRAL_SET	Κεντρική ρύθμιση	0: Τοπικό 1: Χειριστήριο	Ανάγνωση/ Εγγραφή
8	ONOFF_STATUS	Κατάσταση On/Off	0: Off 1: On	Ανάγνωση
9	MODE_STATUS	Κατάσταση λειτουργίας	0: Ψύξη 1: Θέρμανση	Ανάγνωση
10	TEMP_C_STATUS	Ρύθμιση κατάστασης θερμοκρασίας COOL		Ανάγνωση
11	TEMP_H_STATUS	Ρύθμιση κατάστασης θερμοκρασίας HEAT		Ανάγνωση
12	WATER_INLET	Θερμοκρασία εισόδου		Ανάγνωση
13	WATER_OUTLET	Θερμοκρασία εξόδου		Ανάγνωση
14	AMBIENT_TEMPERATURE	Θερμοκρασία περιβάλλοντος		Ανάγνωση
15	OPER_CONDITION	Κατάσταση λειτουργίας μονάδας	0: OFF 1: Θερμοστάτης OFF 2: Θερμοστάτης ON 3: Προειδοποίηση	Ανάγνωση
16	ERROR_CODE_CH	Κωδικός προειδοποίησης για γενική προειδοποίηση ψΥΚΤΗ		Ανάγνωση
17~22	ERROR_CODE_CYC	Κωδικός προειδοποίησης για προειδοποίηση κύκλου (1~6)		Ανάγνωση
23~31	(Δεν Χρησιμοποιείται)	(Δεν Χρησιμοποιείται)	(Δεν Χρησιμοποιείται)	(Δεν Χρησιμοποιείται)



Σημειώσεις:

- Η θέση ρύθμισης off είναι: Διεύθυνση 40000 + N*32 + όπως φαίνεται στον πίνακα, όπου N είναι η διεύθυνση του Ψύκτη νερού.
- Οι παράμετροι Κατάστασης (πραγματική τιμή) και Ρύθμισης (καθορισμένη τιμή) έχουν συνήθως την ίδια τιμή αλλά, σε ορισμένες περιπτώσεις, κάποιες παράμετροι μπορεί να διαφέρουν. Για κανονικό έλεγχο, συνιστάται η χρήση των παραμέτρων Ρύθμισης.
- *) Όταν η ρύθμιση θερμοκρασίας και η κατάσταση λειτουργίας μεταβάλλονται ταυτόχρονα, αλλάξτε πρώτα την κατάσταση λειτουργίας και μετά ρυθμίστε την επιθυμητή θερμοκρασία.

6.3 Λίστα κωδικών προειδοποίησης CHILLER

6.3.1 Λίστα κωδικών προειδοποίησης CHILLER

Προειδοποίηση CHILLER		Περιγραφή	H-LINK
7SEG1	7SEG2		Κωδικός
11	11	Βλάβη του θέρμοστορ θερμοκρασίας εξόδου νερού	20
12	12	Βλάβη του θέρμοστορ θερμοκρασίας εξόδου νερού (μόνο για μονάδα ενός κύκλου)	21
22	22	Αποτυχία του θέρμοστορ θερμοκρασίας περιβάλλοντος (ανοικτό/βραχυκυκλωμένο)	24
5P	5P	Δεν υπάρχει σήμα ανάδρασης από την αντλία νερού	26
13	13	Ενεργοποίηση ελέγχου προστασίας από πάγωμα (μόνο για μονάδα ενός κύκλου)	27
6C	6C	Προειδοποίηση σφάλματος νερού (Επιλογή διακόπτη διαφοράς πίεσης ή διακόπτη ποής)-Συμπυκνωτής	28
6E	6E	Προειδοποίηση σφάλματος νερού (Επιλογή διακόπτη διαφοράς πίεσης ή διακόπτη ποής)-Εξαρτηστής	29
14	14	Ενεργοποίηση θέρμοστατ για υπερβολικά υψηλή θερμοκρασία νερού (Μόνο για μονάδες ενός κύκλου)	30
AP	AP	Ενεργοποίηση πρόσθετης συσκευής προστασίας	31
05	05	Ανωμαλία φάσης	32
CP	CP	Σφάλμα επικοινωνίας μεταξύ χειριστηρίων PCB (PCB _{ci} , PCB _{ca})	33
03	03	Σφάλμα επικοινωνίας μεταξύ ψύκτη και τηλεχειριστηρίου (H-LINK)	34
EU	EU	Σφάλμα επικοινωνίας μεταξύ PCB βαλβίδας εκτόνωσης και PCB ελέγχου	36
40	40	Εσφαλμένη λειτουργία	40~45, 47,47,54

6.3.2 Λίστα κωδικών προειδοποίησης κύκλου

Προειδοποίηση κύκλου		Περιγραφή	H-LINK	
7SEG1	7SEG2		Κωδικός	
Ln	Hn	Ενεργοποίηση του διακόπτη Υψηλής πίεσης	1	
Ln	Ln	Ενεργοποίηση του ελέγχου χαμηλής πίεσης	2	
Ln	7n	Ενεργοποίηση εσωτερικού θερμοστάτη του συμπιεστή	3	
Ln	6n	Ενεργοποίηση του θερμίστορ κατάθλιψης αερίου	4	
Ln	5n	Ενεργοποίηση του θερμικού πελέ του συμπιεστή ή Βλάβη του βοηθητικού πελέ ARm	5	
Ln	F0	Εσφαλμένη ρύθμιση αριθμού ανεμιστήρων	6	
Ln	4n	Ενεργοποίηση εσωτερικού θερμοστάτη κινήτηρα ανεμιστήρα	7	
Ln	Ln	Υπερβολικά χαμηλή πίεση	8	
Ln	9n	Υπερβολικά χαμηλή θερμοκρασία ψυκτικού μέσου στην είσοδο του ψύκτη	10	
Ln	2n	Αποτυχία του αισθητήρα πίεσης αερίου στην κατάθλιψη (ανοικτό/βραχυκυκλωμένο)	11	
Ln	28	Αποτυχία του αισθητήρα πίεσης αερίου στην αναρρόφηση (ανοικτό/βραχυκυκλωμένο)	12	
Ln	12	Βλάβη του θερμίστορ θερμοκρασίας εξόδου νερού (για μονάδα πολλών κύκλων)	14	
Ln	23	Βλάβη θερμίστορ κατάθλιψης αερίου (ανοικτό/βραχυκυκλωμένο)	15	
Ln	26	Αποτυχία του θερμίστορ αερίου στην αναρρόφηση (ανοικτό/βραχυκυκλωμένο)	16	
Ln	05	Ανωμαλία φάσης	17	
Ln	21	Βλάβη θερμίστορ ψυκτικού στην είσοδο του ψύκτη (Ανοικτό/Βραχυκυκλωμένο)	19	
Ln	6n	Ενεργοποίηση του θερμίστορ αερίου αναρρόφησης	20	
Ln	13	Ενεργοποίηση ελέγχου προστασίας από πάγωμα (για μονάδα πολλών κύκλων)	21	
Ln	24	Αποτυχία ρύθμισης θερμίστορ τριαν την εκτονωτική βαλβίδα (ανοικτό/βραχυκυκλωμένο)	23	
Ln	25	Αποτυχία του θερμίστορ εξόδου νερού - Πισω μέρος ψύκτη (ανοικτό/βραχυκυκλωμένο)	24	
Fn	51	Ανωμαλία τροφοδοσίας μετατροπέα	34	

7. Αντιμετώπιση προβλημάτων

Αρ.	Κωδικός προβλοποίησης	Περιγραφή	Προληπτικό μέτρο
1	EE → B 1	Δεν έχει υπάρξει επικοινωνία των εσωτερικών μονάδων με τη συσκευή HARC-MODBUS για περισσότερα από 10 λεπτά	<ol style="list-style-type: none"> Βεβαιωθείτε ότι έχει γίνει σωστά η σύνδεση H-LINK στο HARC (Κ1) καθώς και στις εσωτερικές μονάδες. Βεβαιωθείτε ότι υπάρχει παροχή πύματος στα κλιματιστικά.
2	EE → B3	Δεν έχει υπάρξει επικοινωνία μεταξύ των εσωτερικών μονάδων και του HARC-MODBUS	<ol style="list-style-type: none"> Βεβαιωθείτε ότι έχει γίνει σωστά η σύνδεση H-LINK στο HARC (Κ1) καθώς και στις εσωτερικές μονάδες. Βεβαιωθείτε ότι υπάρχει παροχή πύματος στα κλιματιστικά.
3	Το D7 είναι πάντα OFF	Δεν αναβοσβήνει καμία λυχνία LED στην PCB και τα 7 τμήματα είναι OFF	 Σημειώσεις: <ul style="list-style-type: none"> Η έξοδος σήματος DC της παροχής πύματος διαθέτει προστασφαικό διακόπτη ο οποίος πρέπει να είναι σωστά πυθμισμένος για τη λήψη +5 V DC. Το D7 πρέπει να είναι στη θέση ON.
4	Το D12 δεν αναβοσβήνει ποτέ	Το HARC-MODBUS δεν πραγματοποιεί ανίχνευση/απαστολή δεδομένων (το D12 δεν αναβοσβήνει ποτέ)	<ol style="list-style-type: none"> Ελέγξτε τη σύνδεση μεταξύ των συσκευών MODBUS και του K5.
5	Το D12 δεν αναβοσβήνει	Το HARC δεν λειτουργεί (Το D13 δεν αναβοσβήνει)	<ol style="list-style-type: none"> Βεβαιωθείτε ότι το SW3 είναι σε θέση RUN. Εάν όχι, πυθμίστε σε RUN και πατήστε επαναρφορά.
6	Τα D4 & D11 δεν αναβοσβήνουν	Δεν υπάρχει επικοινωνία H-LINK από το HARC-MODBUS	<ol style="list-style-type: none"> Το D4 αναβοσβήνει αλλά το D11 δεν αναβοσβήνει. → Βλ. σειρά Νο6, προληπτικό μέτρο 1. Τα D4 και D11 δεν αναβοσβήνουν. → Βλ. σειρά Νο3, προληπτικό μέτρο 1.