

HITACHI PSC-5T

CONTROL TIMER (7-DAY TIMER)

INSTALLATION AND OPERATION MANUAL
MANUAL DE INSTALACIÓN Y FUNCIONAMIENTO
INSTALLATIONS- UND BETRIEBSHANDBUCH
MANUEL D'INSTALLATION ET DE
FUNCTIONNEMENT
MANUALE D'INSTALLAZIONE E D'USO

MANUAL DE INSTALAÇÃO E DE
FUNCIONAMENTO
BRUGER- OG MONTERINGSVEJLEDNING
INSTALLATIE- EN BEDIENINGSHANDLEIDING
HANDBOK FÖR INSTALLATION OCH ANVÄNDNING
ΕΓΧΕΙΡΙΔΙΟ ΕΓΚΑΤΑΣΤΑΣΗΣ ΚΑΙ ΛΕΙΤΟΥΡΓΙΑΣ



Do not perform installation work, without referring to our installation manual.
No realice la instalación de este equipo, sin antes consultar este manual de instalación.
Bei der Installation unbedingt die Hinweise in der Installationsanleitung beachten.
Consulter notre manuel avant de réaliser une quelconque installation.
Realizzare l'installazione, seguendo quanto indicato in questo manuale.
Nao inicie os trabalhos de montagem, sem consultar o nosso manual de montagem.
Udfor ikke installationsarbejder uden først at konsultere vores vejledning.
Voer geen enkele handeling uit om de apparatuur alvorens deze handleiding te hebben doorgelezen.
Utför inte några installationsarbeten utan att först läsa var installationsmanual
Μην ήσετε στην εγκατάσταση, χωρίς πριν να έχετε συμβουλευθεί αυτο το εγχειρίδιο εγκατάστασης

ENGLISH

ESPAÑOL

DEUTCH

FRANÇAIS

ITALIANO

PORTUGUES

DANSK

NEDERLANDS

SVENSKA

ΕΛΛΗΝΙΚΑ





DANGER – Immediate hazard which WILL result in severe injury or death.

PELIGRO – Riesgos inmediatos que PRODUCIRÁN lesiones personales graves e incluso la muerte.

GEFAHR – Unmittelbare Gefahrenquellen, die zu schweren Verletzungen oder zum Tod führen.

DANGER – Dangers instantanés de blessures corporelles sévères ou de mort.

PERICOLO – Pericolo immediato che PRODURRÀ ferite gravi o la morte.

PERIGO – Problemas imediatos que IRÃO resultar em graves ferimentos pessoais ou morte.

FARE – Overhængende fare, som VIL resultere i alvorlig personskade eller dødsfald.

GEVAAR – Onmiddellijke risico's die ernstige persoonlijk verwondingen of de dood ten gevolge kunnen hebben.

FARA – Omedelbar risk som medfór svår personskada eller död.

KINAYNO – Άμεσος κίνδυνος που ΘΑ έχει ως αποτέλεσμα σοβαρές σωματικές βλάβες ή θάνατο.



WARNING – Hazards or unsafe practices which COULD result in severe personal injuries or death.

AVISO – Riesgos o prácticas poco seguras que PODRÍAN producir lesiones personales e incluso la muerte.

WARNUNG – Gefährliche oder unsichere Anwendung, die zu schweren Körperverletzungen oder zum Tod führen kann.

ATTENTION – Utilisation dangereuse ou sans garantie de sécurité qui PEUT provoquer de sévères blessures personnelles ou la mort.

AVVISO – Pericoli o azioni pericolose che POTREBBERO avere come esito lesioni fisiche gravi o il decesso.

AVISO – Riesgos o prácticas poco seguras que PUEDEN producir lesiones personales e incluso la muerte

ADVARSEL – Farer eller farlig brug, som KAN resultere i alvorlig personskade eller dødsfald.

WAARSCHUWING – Gevaren of onveilige praktijken die ernstig persoonlijk letsel of de dood tot gevolg KUNNEN hebben.

VARNING – Risker eller osäkra tillvägagångssätt som KAN leda till svåra personskador eller dödsfall.

ΠΡΟΕΙΔΟΠΟΙΗΣΗ – Κίνδυνοι ή επικίνδυνες πρακτικές, οι οποίες ΜΠΟΡΕΙ να έχουν ως αποτέλεσμα σοβαρές σωματικές βλάβες ή θάνατο.



CAUTION – Hazards or unsafe practices which COULD result in minor personal injury or product or property damage.

PRECAUCIÓN – Riesgos o prácticas poco seguras que PODRÍAN provocar lesiones personales de menor importancia o daños en el producto u otros bienes.

VORSICHT – Gefährliche oder unsichere Anwendung, die geringfügigen Personen-, Produkt- oder Sachschaden verursachen kann.

PRECAUTION – Utilisation dangereuse ou sans garantie de sécurité qui PEUT provoquer des blessures mineures ou des dommages au produit ou aux biens.

ATTENZIONE – Pericoli o azioni pericolose che POTREBBERO avere come esito lesioni fisiche minori o danni al prodotto o ad altri beni.

CUIDADO – Perigos e procedimentos perigosos que PODERÃO PROVOCAR danos pessoais ligeiros ou danos em produtos e bens.

FORSIGTIG – Farer eller farlig brug, som KAN resultere i mindre skade på personer, produkt eller ejendom.

LET OP – Gevaren of onveilige praktijken die licht persoonlijk letsel of beschadiging van het product of eigendommen tot gevolg KUNNEN hebben.

VARSAMHET – Risker eller farliga tillvägagångssätt som KAN leda till mindre personskador eller skador på produkten eller på egendom.

ΠΡΟΣΟΧΗ – Κίνδυνοι ή επικίνδυνες πρακτικές, οι οποίες ΜΠΟΡΕΙ να έχουν ως αποτέλεσμα την πρόκληση ελαφρών σωματικών βλαβών ή καταστροφή περιουσίας.

ESPAÑOL

ESPAÑOL

DEUTSCH

FRANÇAIS

ITALIANO

PORTUGÊS

DANSK

NEDERLANDS

SVENSKA

ΕΛΛΗΝΙΚΑ

1. SAFETY SUMMARY



DANGER:

DO NOT pour water into the control timer (hereafter called "Timer"). This product is equipped with electrical parts. If poured, it will cause a serious electrical shock.



WARNING:

DO NOT perform installation work and electrical wiring connection by yourself. Contact your distributor or dealer of HITACHI and ask them for installation work and electrical wiring by service person.



CAUTION:

- DO NOT install the indoor unit, outdoor unit, Timer and cable at such places as;
 - where there is oil vapor and the oil is dispersed
 - where the hot springs are near (in a sulfuric environment)
 - where generation, flowing, staying or leaking of flammable gas is detected
 - where the sea is near (in the salty environment)
 - an acid or alkaline environment
- DO NOT install the indoor unit, outdoor unit, Timer and cable within approximately 3 meters from strong electromagnetic wave radiators such as medical equipment. In case that the Timer is installed in a place where there is electromagnetic wave radiation, shield the Timer and cables by covering with the steel box and running the cable through the metal conduit tube.
- In case that there is electric noise at the power source for the indoor unit, provide a noise filter.



2. INSTALLATION WORK

2.1. SELECTION OF INSTALLATION PLACE

- Select a suitable place for handling and determine the installation place of the Timer with the customer's acceptance.
- Do not install the Timer at such places as;
 - where children can touch
 - where the air from the air conditioner is directly discharged

2.2. BEFORE INSTALLATION

This packing contains the following parts:

| | | |
|---|---|--|
|  |  |  |
| Control Timer | 3 screws M4x16L For fixing the Holding Bracket onto the wall | Cable (1 m) |

2/2 INSTALLATION WORK

2.3. INSTALLATION SPACE

In case of installing the Timers in vertical line, keep a distance more than 50mm between the Timers vertically.
If the distance is insufficient, the front cover of the Timer can not open wide enough.

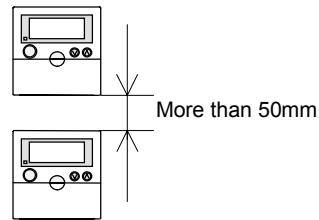

2.4. INSTALLATION PROCEDURES]

1. Insert the edge of the screwdriver into the groove parts at the bottom of the holding bracket, push and turn the screwdriver and remove the Timer from the holding bracket.

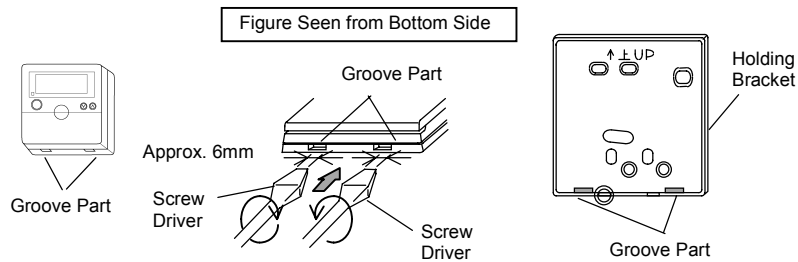

2. Attach the Timer to the holding bracket and connect the cable as follows.

■ In Case of Exposing Remote Control Cable

- 1 Fix the holding bracket onto the wall with screws (accessory).
- 2 Select and cut the knockout hole according to the direction for drawing out the cable.

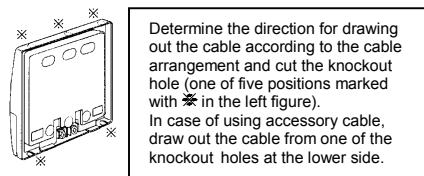
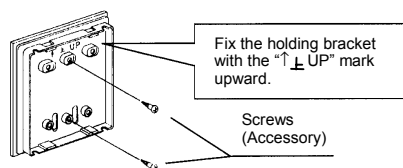

- ③ Lead the cable through the groove.

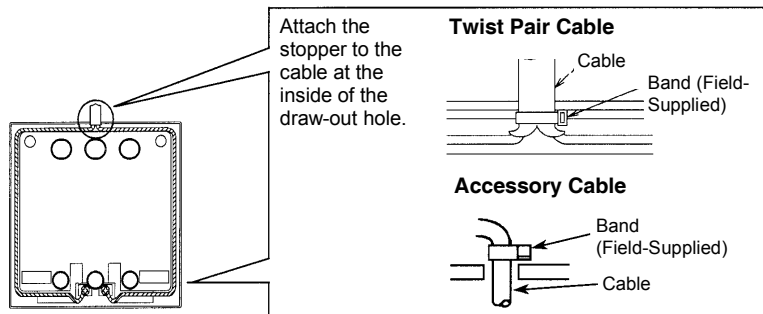

NOTE:

In case of connecting the accessory cable to the connector, remove the protection case.

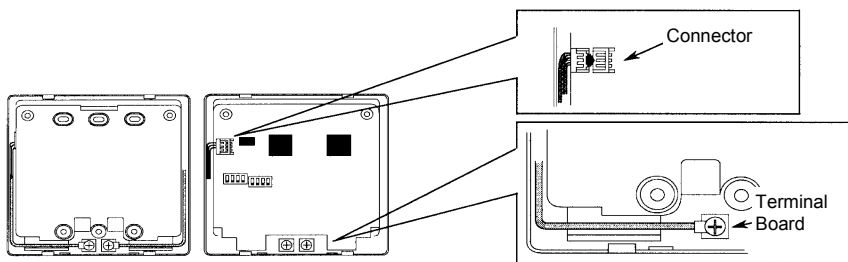

- ④ Attach the Timer onto the holding bracket.

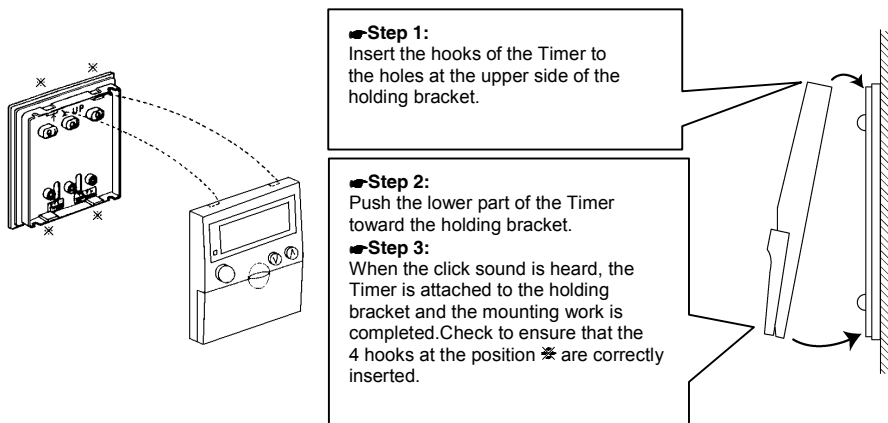

2/4 INSTALLATION WORK

■ When Using Switch Box

- ❶ Prepare a field-supplied JIS Box (JIS C 8336-1988).

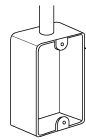

The following 5 types are available.

1. Switch Box for 1 Controller (Without Cover)
2. Switch Box for 2 Controllers (Without Cover)
3. Switch Box for 1 Controller (With Cover)
4. Switch Box for 2 Controllers (With Cover)
5. Outlet Box (With Cover)

- ❸ Attach the holding bracket onto the switch box.

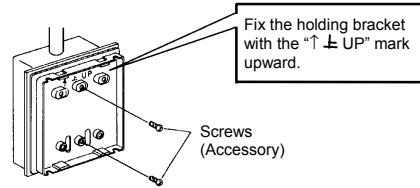

- ❹ Run the cable through the conduit tube in the wall.

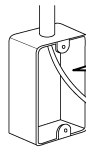

The cable is not exposed. Run the cable through the conduit tube in the wall and connect the cable inside the switch box.

- ❺ Connect the cable to the connector on PCB or the terminal.

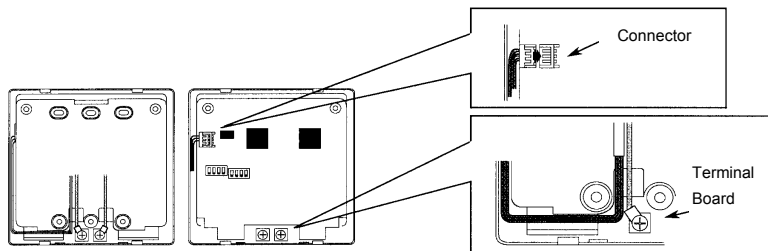

- ❻ Attach the Timer onto the holding bracket.

➡ **Step 1:**
Insert the hooks of the Timer to the holes at the upper side of the holding bracket.

➡ **Step 2:**
Push the lower part of the Timer toward the holding bracket.

➡ **Step 3:**
When a click sound is heard, the Timer is attached to the holding bracket and the mounting work is completed.

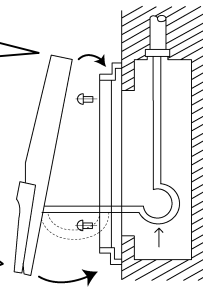

CAUTION:

Pay attention so that the cable may not be slack. If the cable is slack as shown in the right figure, the cable cord (especially the naked part) may be clamped at the hole and it may cause a faulty operation.

3. ELECTRICAL WIRING

Use this Timer with Remote Control Switch or Central Station.



CAUTION:

- Use the twist pair cable (1P-0.75mm²) as a transmitting wire cable for prevention of the malfunction. In case of a cable length less than 30 m also can be used:
 - Shielded pair cable (Shield connected to earth by one side)
 - Normal pair cable
- Keep a distance more than 30cm between the remote control cable and the transmission wire of indoor units.

■ Electrical Wiring

1. In case of using Timer with PC-P1HE

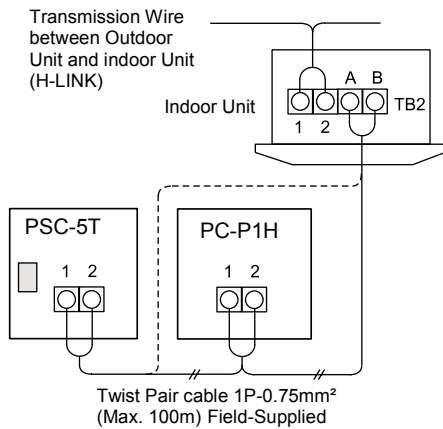

2. In case of using Timer with PC-2H2

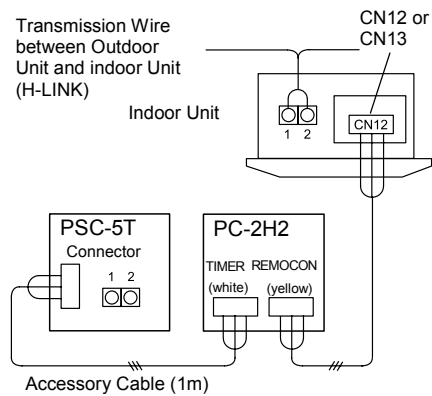

3. In case of using Timer with PSC-5S (Central Station)

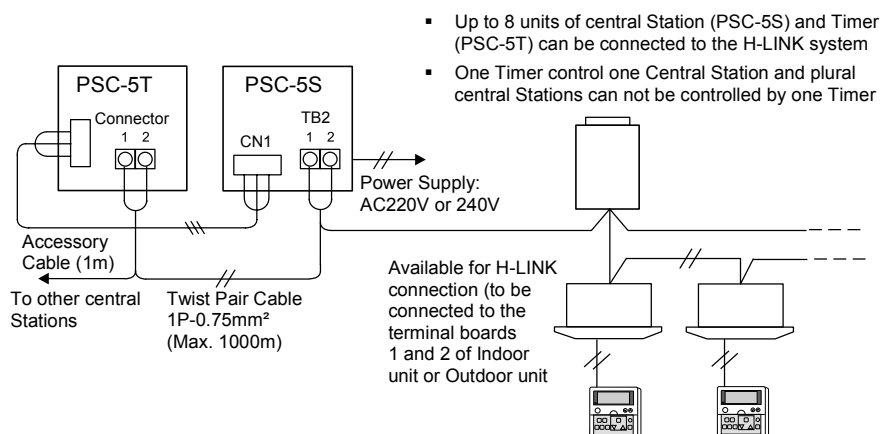

- Up to 8 units of central Station (PSC-5S) and Timer (PSC-5T) can be connected to the H-LINK system
- One Timer control one Central Station and plural central Stations can not be controlled by one Timer

Available for H-LINK connection (to be connected to the terminal boards 1 and 2 of Indoor unit or Outdoor unit)

4/6 SETTING OF DIP SWITCH

4. SETTING OF DIP SWITCH

Set the two dip switches on the PCB as follows.
(The factory-settings for dip switches of DSW1 and DSW2 are all OFF.)

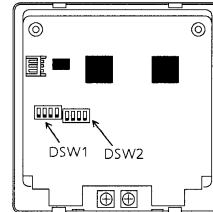

■ Dip Switch Setting

| Pin No. | Contents of Setting | DSW Setting | | Remarks |
|---------|---------------------|---------------------------|-----------------------|--|
| | | OFF | ON | |
| DSW1 | 1 | Refer to the table below. | | Setting is required only when the central station (PSC-5S) is used together. Set the address of the central station to be controlled. |
| | 2 | | | |
| | 3 | | | |
| | 4 | Except for PC-P1HE | PC-P1H | Set #4 pin ON when the remote control switch (PC-P1H) is used together. |
| DSW2 | 1 | Setting is not available. | Setting is available. | Remote control operation is not available after stopping at OFF TIME. Remote control operation is available again at ON TIME while stopping. (This setting is available only when the remote control switch (PC-P1HE) or the central station (PSC-5S) is used together.) |
| | 2 | PSC-5S | Except for PSC-5S | Set #2 pin according to the other controller used together. |
| | 3 | – | – | Do not change the setting (#3 pin: OFF). |
| | 4 | – | – | Do not change the setting (#4 pin: OFF). |

■ Setting of DSW1 (For Address Setting)

| Address | 0 | 1 | 2 | 3 |
|-----------------|---|---|---|---|
| Setting of DSW1 | | | | |
| Address | 4 | 5 | 6 | 7 |
| Setting of DSW1 | | | | |

NOTE:

The mark “■” indicates position of dips switches.

5. SWITCH NAMES AND FUNCTIONS

5.1. LIQUID CRYSTAL DISPLAY SECTION

The figure below shows all the indications for reference. The actual display during operation is different.

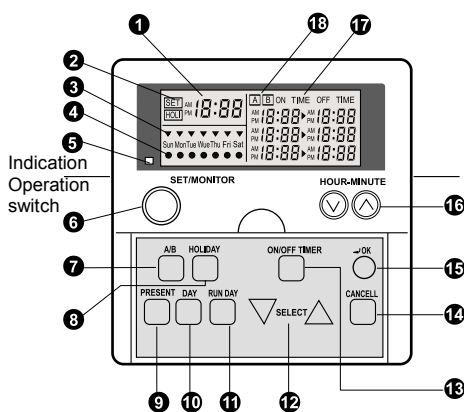

Model: PSC-5T
Order No:60299957

- 1 **Indication of Present Time**
- 2 **Indication of Setting Time and Holiday Day**
This indicates the Operation Mode, SET or MONITOR, and the Holiday day if it is selected.
- 3 **Indication of Present Day of the week**
- 4 **Indication of Running Day of the week**
Whenever the running day is set, this light is on.
- 5 **Run Indicator (Red Lamp)**
- 6 **Change Switch of Operation Mode (SET/MONITOR)**
By depressing this switch the control timer is changed to the setting mode, the "SET" indication is turned on and the "▼" mark is flickered. Depressing again the "SET" mode is turned off and the setting mode is changes to monitor mode.
- 7 **Change Switch of Setting Pattern (A/B)**
There are two (2) patterns (A and B) set for the weekly schedule. Each pattern can be set with three (3) times ON/OFF setting for each weekly day. By depressing this switch the pattern activated (A or B) is selected.
- 8 **Setting Switch of Holiday**
By depressing this switch when the "SET" indication is on, the "HOLI" indication is turned on and the selected day is set as "Holiday". Depressing it again, the holiday setting is canceled.

- 9 **Setting Switch of Present time**
By depressing this switch the "SET" indicator and "▼" mark are flickered and present time can be set.
- 10 **Setting Switch of Day of a Week**
Day of week is selected by this switch when "SET" display is flickering or indicated. Depressing this switch, the "▼" mark move in order of "Sun > Mon > ... > Sat". Depressing the DAY after "Sat", all the "▼" mark are selected. Depressing it again "▼" mark returns to "Sun".
- 11 **Setting Switch of Running Day (RUN DAY)**
By depressing the "RUN DAY" switch, the selected day is set as the running day and the "●" mark is turned on. Depressing again it is turned off and the selected day is cancelled
- 12 **Change Switch of SELECT Setting**
By depressing the "Δ SELECT ▼" switch the 1, 2 or 3 of ON TIME and OFF TIME is selected.
- 13 **Change Switch of ON/OFF TIMER Setting**
When "SET" display is flickering, by depressing the "ON/OFF TIMER" the timer is changing to the ON/OFF time setting mode and the "hour" indication of ON TIME is flickering.
- 14 **CANCEL Switch of Setting Time**
Depressing this switch when timer is set, the indication of ON TIME or OF TIME is changed to "._.".
 - 15 **OK Switch**
By depressing this switch the selection on setting process is accepted.
 - 16 **Setting Switch of HOUR-MINUTE**
By depressing "Δ" or "▼" the hour or minute is set when "SET" display is flickering or indicated.
 - 17 **Indication of ON TIME and OFF TIME Setting**
It is indicating the setting conditions of the selected day
 - 18 **Indication of Weekly Scheduled Pattern (A or B)**

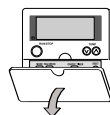



When opening the cover, pull the cover toward the arrow direction



NOTE:
The present time and the ON/OFF setting time are indicated by 12 hours units (AM 0:00-12:00, PM 0:00-12:00)

6. OPERATION PROCEDURE

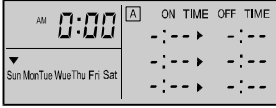
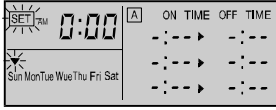
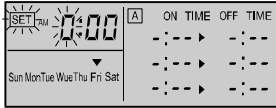
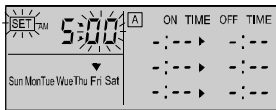
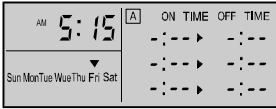
■ SETTING PRESENT DAY AND PRESENT TIME



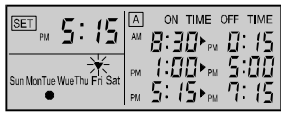
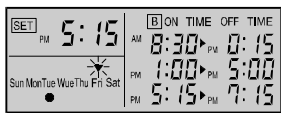

| | |
|--|--|
| (<Example> present Day: Friday, Present Time: 5:15 PM). | |
| During the setting mode, the setting of the present time is not available when depressing the "PRESENT" switch more than 3 seconds. |  ATTENTION: |
| 1. Supply power to the unit.  ATTENTION: <ul style="list-style-type: none"> - Supply power the unit more than 12 hours before unit operation for compressor protection. - Do not cut off power during the term of using air conditioner. The right figure shows the case of the present time at AM 0:00 on Sunday. (When the power is turned ON, the present time is not set.) |  |
| 2. Depress the "PRESENT" switch for more than 3 seconds. The display is changed to the present time setting mode, and the "SET" indicator and the "▼" mark are flickered. The right figure shows the case that ON time and OFF time are not set. |  |
| 3. Set the "▼" mark at the present day by depressing the "DAY" switch. Depress the "OK" switch after setting the present day, the "▼" mark is turned on and "hour" indication is flickered. The right figure shows the case of setting the day at "Friday". |  |
| 4. Set "hour" indication at the present hour by depressing the "HOUR/MINUTE" switch. Depress the "OK" switch after setting the present hour, "hour" indication is turned on and "minute" indication is flickered. The right figure shows the case of setting the hour at "PM 5". |  |
| 5. Set "minute" indication at the present minute by depressing the "HOUR/MINUTE" switch. Depress the "OK" switch after setting the present minute, the present day and the present time are fixed, and the present time setting mode is changed to the monitor mode. "minute" indication is turned on and the "SET" indication is turned off. The right figure shows the case of setting the minute at "15". |  |

■ CHANGING WEEKLY SCHEDULE PATTERN (A OR B)

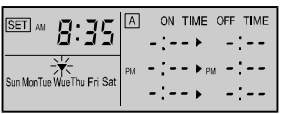
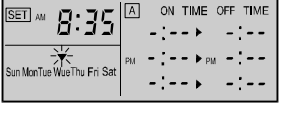

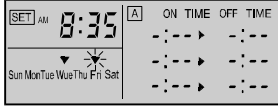
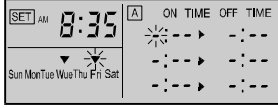
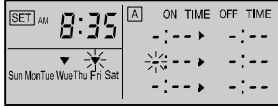

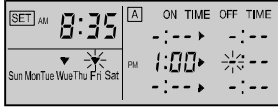
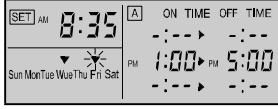
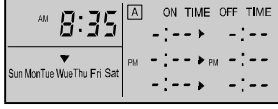
| | |
|--|--|
| <p>There are 2 (two) patterns (A or B) set for the weekly schedule. Each pattern can be set with 3 (three) times ON/OFF settings for each weekly day.</p> <p><Function></p> <p>To select the pattern for setting and operating the schedule. The schedule of A or B pattern can be set for each week and changed for a season.</p> | |
| <p>1. Depress the "SET/MONITOR" switch.</p> <p>The control timer is changed to the setting mode and the "SET" indication is turned on.</p> |  |
| <p>2. Depress the "A/B" switch.</p> <p>The set pattern is changed ("A" to "B") by depressing the "A/B" switch. The right figure shows the case of selecting the set pattern "B".</p> |  |
| <p>3. Depress the "SET/MONITOR" switch.</p> <p>The "SET" mode is turned off and the setting mode is changed to the monitor mode.</p> |  |

■ SETTING ON/OFF TIME



| | |
|--|---|
| <p><Example> "A" pattern, Friday, Setting 2, PM 1:00 (ON) / PM 5:00 (OFF)</p> | |
| <p>In case that the remote control switch (PC-P1H(E)) is used together, both setting of ON TIME and OFF TIME are required for setting a, 2 and 3. (The setting of ON TIME (or OFF TIME) only is not available).</p> <p>In case that the central station (PSC-5S) is used together, the setting of ON TIME (or OFF TIME) only is available.</p> |  <p>ATTENTION:</p> |
| <p>1. Depress the "SET/MONITOR" switch.</p> <p>The control timer is changed to the setting mode, the "SET" indication is turned on and the "▼" mark is flickered. The right figure shows the case of changing to the setting mode.</p> |  |
| <p>2. Select "A" or "B" pattern by depressing the "A/B" switch.</p> <p>Refer to "B". Changing weekly Schedule pattern A or B for changing the pattern</p> |  |





| | |
|--|--|
| <p>3. Select the weekly day to set ON/OFF control by depressing the “DAY” switch.</p> <p>By depressing the “DAY” switch, the flickering “▼” mark moves in order of “Sun → Mon → ... → Sat”. Depressing the “DAY” switch after “Sat”, all the “▼” marks (from “Sun” to “Sat”) are flickered. In this case, the setting is the same for all days of a week. Depressing the “DAY” switch once again, the flickering “▼” mark returns to the position of “Sun”.</p> |  |
| <p>4. Depress the “ON/OFF TIME” switch.</p> <p>The Timer is changed to the ON/OFF time setting mode and the “hour” indication of ON TIME is flickered.</p> <p>The right figure shows the case of changing to the ON/OFF time setting mode.</p> |  |
| <p>5. Select the setting 1,2 or 3 by depressing the “Δ SELECT ▽” switch.</p> <p>By depressing the “Δ SELECT ▽” switch, the “hour” indication moves flickering.</p> <p>The right figure shows the case of selecting the setting 2.</p> |  |
| <p>6. Set the “hour” indication of ON TIME by depressing the “HOUR/MINUTE ⬆ or ⬇” switch.</p> <p>After setting the “hour” indication, depress the “OK” switch and the “minute” indication of ON TIME to be set is flickered.</p> <p>The right figure shows the case of setting the hour “PM 1.—”.</p> |  |
| <p>7. Set the “minute” indication of ON TIME by depressing the “HOUR/MINUTE ⬆ or ⬇” switch.</p> <p>After setting the “minute” indication, depress the “OK” switch and the “hour” indication of OFF TIME to be set is flickered.</p> <p>The right figure shows the case of setting the hour “PM 1:00”.</p> |  |
| <p>8. Set the time of “OFF TIME” by the same procedure of setting the time of “ON TIME”.</p> <p>After setting the time of “OFF TIME”, the flickering indication of “OFF TIME” is turned on and the ON/OFF time setting mode is changed to the setting mode.</p> <p>The right figure shows the case of setting the hour “PM 5:00”.</p> |  |
| <p>9. Depress the “SET/MONITOR” switch.</p> <p>The “SET” indication is turned off and the control timer is changed to the monitor mode.</p> <p>The right figure shows the case of indicating the setting condition of the present day.</p> |  |
| <p>Depressing the “CANCEL” switch when setting ON time (procedure 6) or OFF time (procedure 8), the indication of ON TIME or OFF TIME is changed to “-:-”. Depressing the “OK” switch in this condition, the setting is canceled.</p> <p>In case of using the Timer together with other controller than the remote control switch. PC-P1HE and the central station PSC-5S, the setting of ON time and OFF time is required.</p> |  ATTENTION: |

■ SETTING RUNNING DAY

| | |
|--|--|
| <p><Function> To set the day for actual operation of the running schedule set before. (Though the ON time and OFF time are set, the schedule operation is not available unless the running day is set.)</p> <p><Example> "B" pattern, Tuesday</p> | |
| <p>1. Depress the "SET/MONITOR" switch. The timer is changed to the setting mode, the "SET" indication is turned on and the "▼" mark are flickered.</p> |  |
| <p>2. Select "A" or "B" pattern by depressing the "A/B" switch. The right figure shows the case of selecting the set pattern "B".</p> |  |
| <p>3. Select the running day by depressing the "DAY" switch. Refer to 3. of "Setting ON/OFF Time" for the indication of the "▼" mark. The right figure shows the case of selecting the day "Tuesday".</p> |  |
| <p>4. Depress the "RUN DAY" switch, the selected day is set as the running day and the "●" mark is turned on at the selected day. By depressing the "RUN DAY" switch again, the running day setting is canceled and the "●" mark is turned off. The right figure shows the case of selecting the day "Tuesday".</p> |  |
| <p>5. Depress the "SET/MONITOR". The "SET" indication is turned off and the control timer is changed to the monitor mode.</p> |  |

■ SETTING HOLIDAY

| | |
|---|--|
| <p><Function> To cancel the running schedule temporarily. The schedule operation is canceled only once at the day set as "holiday". After that, the schedule operation is available again. This function is used in case that there are any irregular holidays.</p> <p><Example> "B" pattern, Tuesday</p> | |
| <p>1. Depress the "SET/MONITOR" switch. The timer is changed to the setting mode, the "SET" indication is turned on and the "▼" mark are flickered.</p> |  |
| <p>2. Select "A" or "B" pattern by depressing the "A/B" switch. The right figure shows the case of selecting the set pattern "B".</p> |  |

| | |
|---|--|
| <p>3. Select the day to be set as "holiday" by depressing the "DAY" switch.</p> <p>Refer to 3. "Setting ON/OFF Time" for the indication of the "▼" mark. The right figure shows the case of selecting the day "Tuesday".</p> |  |
| <p>4. Depress the "HOLIDAY" switch, the "HOLI" indication is turned on and the selected day is set as "holiday".</p> <p>In the case that the selected day is not set as running day the "●" mark is turned off. The holiday setting is not available for the day. (In case that all days of a week are selected, only the running day is set as "holiday"). By depressing the "HOLIDAY" switch again, the holiday setting is canceled.</p> |  |
| <p>5. Depress the "SET/MONITOR".</p> <p>The "SET" indication is turned off and the control timer is changed to the monitor mode.</p> |  |
| <p>In case of setting the present day as "holiday", the "holiday" setting is available from that time and the schedule operation is canceled until the next day. In that case, the same day after a week is not "holiday".</p> |  ATTENTION: |

■ CHECKING CONTENTS OF SETTING

| | |
|---|--|
| <p>1. Depress the "DAY" switch at the monitor mode (when the "SET" indication is turned off), the "▼" mark moves and the setting contents of the day with the "▼" mark is indicated. The right figure shows the case of selecting the day "Tuesday".</p> |  |
|---|--|

⚠ CAUTION:

- The control timer has a built-in back-up battery and the clock function is available within 2 weeks in case of power failure. If the power failure continues more than 2 weeks, set the present time again.
- The RUN indicator is turned on at ON time and turned off at OFF time.
In case that the indoor unit operation is started or stopped by the remote control switch or the central station used together with the timer, the RUN indicator is not changed.
- The flickering of the RUN indicator shows the abnormal condition of the Timer. Check to ensure that the wiring connection and the setting of dip switches are correct. In the case that the RUN indicator is still flickered after checking, contact your distributor or dealer of HITACHI.

⚠ CAUTION:

- It may take approximately 15 seconds to start (or stop) operation after ON time (or OFF time) according to the controller used together.
- The operation can not be started or stopped during the setting mode condition. After the completion of setting, set the Timer at the monitor mode. (After 3 minutes with leaving the Timer at the setting mode, the Timer is changed to the monitor mode automatically.)
- In the case that the Timer is used with the central station (PSC-5S), the setting by the central station is required. Refer to the "Installation & Operation Manual of Central Station" for details.