

HITACHI**CSC-5S**

INSTALLATION AND OPERATION MANUAL
 MANUAL DE INSTALACIÓN Y FUNCIONAMIENTO
 INSTALLATIONS- UND BETRIEBSHANDBUCH
 MANUEL D'INSTALLATION ET DE
 FONCTIONNEMENT
 MANUALE D'INSTALLAZIONE E D'USO

MANUAL DE INSTALAÇÃO E DE
 FUNCIONAMENTO
 BRUGER- OG MONTERINGSVEJLEDNING
 INSTALLATIE- EN BEDIENINGSHANDLEIDING
 HANDBOK FÖR INSTALLATION OCH ANVÄNDNING
 ΕΓΧΕΙΡΙΔΙΟ ΕΓΚΑΤΑΣΤΑΣΗΣ ΚΑΙ ΛΕΙΤΟΥΡΓΙΑΣ



Do not perform installation work, without referring to our installation manual.
 No realice la instalación de este equipo, sin antes consultar este manual de instalación.
 Bei der Installation unbedingt die Hinweise in der Installationsanleitung beachten.
 Consulter notre manuel avant de réaliser une quelconque installation.
 Realizzare l'installazione, seguendo quanto indicato in questo manuale.
 Não inicie os trabalhos de montagem, sem consultar o nosso manual de montagem.
 Udfør ikke installationsarbejder uden først at konsultere vores vejledning.
 Voer geen enkele handeling uit om de apparatuur alvorens deze handleiding te hebben doorgelezen.
 Utför inte några installationsarbeten utan att först läsa var installationsmanual
 Μην ήσετε στην εγκατάσταση, χωρίς πριν να έχετε συμβουλευθεί αυτο το εγχειρίδιο εγκατάστασης

ENGLISH

ESPAÑOL

DEUTCH

FRANÇAIS

ITALIANO

PORTUGUES

DANSK

NEDERLANDS

SVENSKA

ΕΛΛΗΝΙΚΑ





DANGER – Immediate hazard which WILL result in severe injury or death.

PELIGRO – Riesgos inmediatos que PRODUCIRÁN lesiones personales graves e incluso la muerte.

GEFAHR – Unmittelbare Gefahrenquellen, die zu schweren Verletzungen oder zum Tod führen.

DANGER – Dangers instantanés de blessures corporelles sévères ou de mort.

PERICOLO – Pericolo immediato che PRODURRÀ ferite gravi o la morte.

PERIGO – Problemas imediatos que IRÃO resultar em graves ferimentos pessoais ou morte.

FARE – Overhængende fare, som VIL resultere i alvorlig personskade eller dødsfald.

GEVAAR – Onmiddellijke risico's die ernstige persoonlijke verwondingen of de dood ten gevolge kunnen hebben.

FARA – Omedelbar risk som medfór svår personskada eller död.

KINAYNO – Άμεσος κίνδυνος που ΘΑ έχει ως αποτέλεσμα σοβαρές σωματικές βλάβες ή θάνατο.



WARNING – Hazards or unsafe practices which COULD result in severe personal injuries or death.

AVISO – Riesgos o prácticas poco seguras que PODRÍAN producir lesiones personales e incluso la muerte.

WARNUNG – Gefährliche oder unsichere Anwendung, die zu schweren Körperverletzungen oder zum Tod führen kann.

ATTENTION – Utilisation dangereuse ou sans garantie de sécurité qui PEUT provoquer de sévères blessures personnelles ou la mort.

AVVISO – Pericoli o azioni pericolose che POTREBBERO avere come esito lesioni fisiche gravi o il decesso.

AVISO – Riesgos o prácticas poco seguras que PUEDEN producir lesiones personales e incluso la muerte

ADVARSEL – Farer eller farlig brug, som KAN resultere i alvorlig personskade eller dødsfald.

WAARSCHUWING – Gevaren of onveilige praktijken die ernstig persoonlijk letsel of de dood tot gevolg KUNNEN hebben.

VARNING – Risker eller osäkra tillvägagångssätt som KAN leda till svåra personskador eller dödsfall.

ΠΡΟΕΙΔΟΠΟΙΗΣΗ – Κίνδυνοι ή επικίνδυνες πρακτικές, οι οποίες ΜΠΟΡΕΙ να έχουν ως αποτέλεσμα σοβαρές σωματικές βλάβες ή θάνατο.



CAUTION – Hazards or unsafe practices which COULD result in minor personal injury or product or property damage.

PRECAUCIÓN – Riesgos o prácticas poco seguras que PODRÍAN provocar lesiones personales de menor importancia o daños en el producto u otros bienes.

VORSICHT – Gefährliche oder unsichere Anwendung, die geringfügigen Personen-, Produkt- oder Sachschaden verursachen kann.

PRECAUTION – Utilisation dangereuse ou sans garantie de sécurité qui PEUT provoquer des blessures mineures ou des dommages au produit ou aux biens.

ATTENZIONE – Pericoli o azioni pericolose che POTREBBERO avere come esito lesioni fisiche minori o danni al prodotto o ad altri beni.

CUIDADO – Perigos e procedimentos perigosos que PODERÃO PROVOCAR danos pessoais ligeiros ou danos em produtos e bens.

FORSIGTIG – Farer eller farlig brug, som KAN resultere i mindre skade på personer, produkt eller ejendom.

LET OP – Gevaren of onveilige praktijken die licht persoonlijk letsel of beschadiging van het product of eigendommen tot gevolg KUNNEN hebben.

VARSAMHET – Risker eller farliga tillvägagångssätt som KAN leda till mindre personskador eller skador på produkten eller på egendom.

ΠΡΟΣΟΧΗ – Κίνδυνοι ή επικίνδυνες πρακτικές, οι οποίες ΜΠΟΡΕΙ να έχουν ως αποτέλεσμα την πρόκληση ελαφρών σωματικών βλαβών ή καταστροφή περιουσίας.

ESPAÑOL

ESPAÑOL

DEUTSCH

FRANÇAIS

ITALIANO

PORTUGÊS

DANSK

NEDERLANDS

SVENSKA

ΕΛΛΗΝΙΚΑ

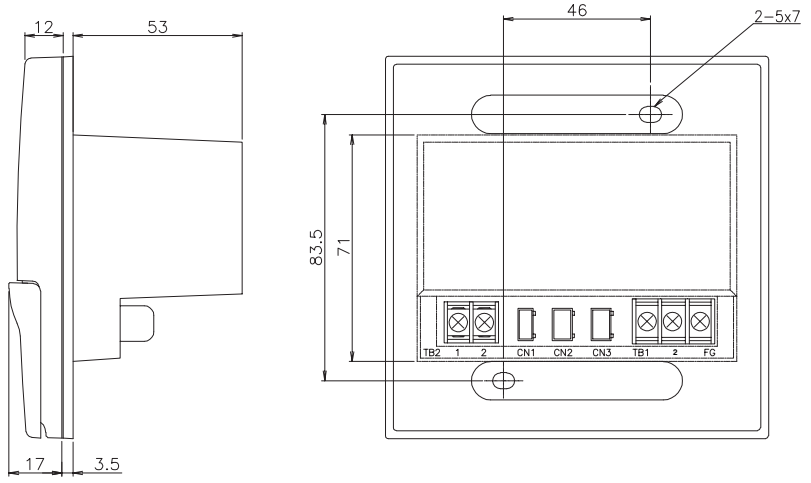
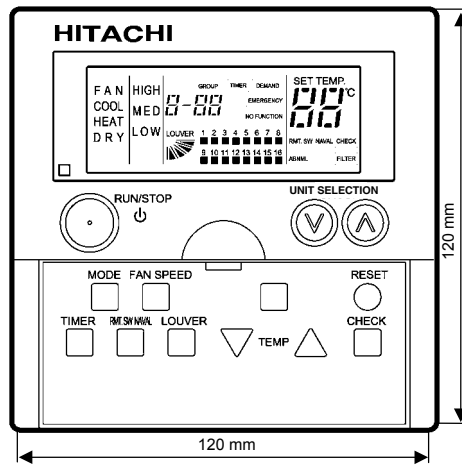

1. SAFETY SUMMARY



DANGER:

DO NOT pour water into the central station. This product is equipped with electrical parts. If poured, it will cause a serious electrical shock.



WARNING:

DO NOT perform installation work and electrical wiring connection by yourself. Contact your distributor or dealer of HITACHI and ask them for installation work and electrical wiring by service person.



CAUTION:

- DO NOT install the indoor unit, outdoor unit, central station and cable at such places as;
 - where there is oil vapor and the oil is dispersed
 - where the hot springs are near (in a sulfuric environment)
 - where generation, flowing, staying or leaking of flammable gas is detected
 - where the sea is near (in the salty environment)
 - an acid or alkaline environment
- DO NOT install the chiller unit, central station, and cable within approximately 3 meters from strong electromagnetic wave radiators such as medical equipment. In case that the central station is installed in a place where there is electromagnetic wave radiation, shield the controller and cables by covering with the steel box and running the cable through the metal conduit tube.
- In case that there is electric noise at the power source for the indoor unit, provide a noise filter.

2. INSTALLATION WORK



CAUTION:



Follow the national regulations for the right assembly of the CSC-5S in the wall.

2.1. SELECTION OF INSTALLATION PLACE

- Select a suitable place for handling and determine the installation place of the controller with the customer's acceptance.
- Do not install the central station at such places as;
 - where children can touch
 - where the air from the air conditioner is directly discharged

2.2. BEFORE INSTALLATION

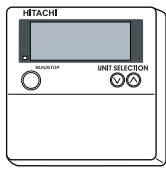
This packing contains the following parts:

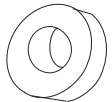
		
1 Central Station for operation control	2 screws M4x16L. For fixing the Holding Bracket onto the wall	1 Ring Core.

2 INSTALLATION WORK

2.3. INSTALLATION SPACE

In case of installing the controllers in vertical line keep a distance more than 50mm between the controllers vertically.
If the distance is insufficient, the front cover of the controller can not open wide enough

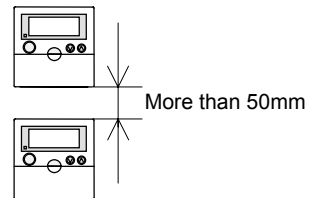

1. Insert the edge of the screwdriver into the slot parts at the bottom of the holding bracket, push and turn the screwdriver and remove the controller from the holding bracket. Do not insert the screwdriver into the nail near the slot part, or the nail will be damaged.

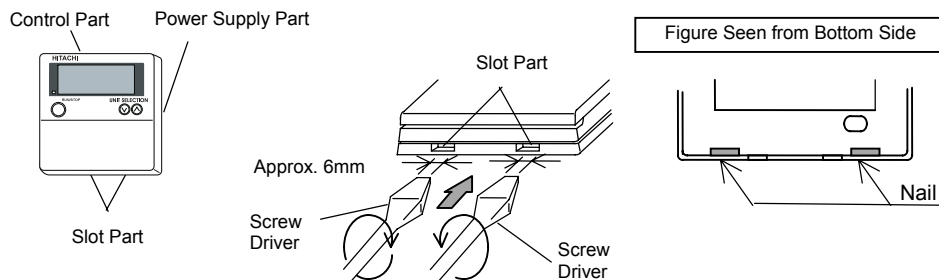

2. Attach the power supply part to the switch box.

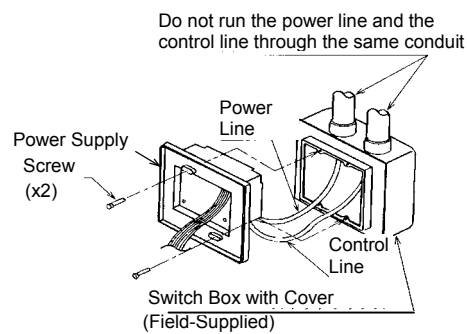

3. Attach the control part onto the power supply part. At first, attach the upper side, and then the lower side.

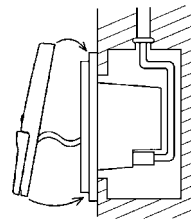

3. ELECTRICAL WIRING

3.1. ELECTRICAL WIRING

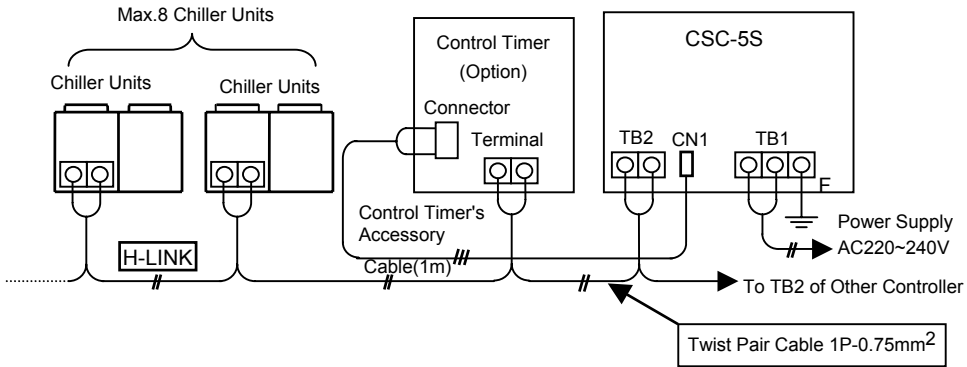

3.1.1. RECOMMENDABLE WIRING TYPES

Japan Cable Industrial Associations	Hitachi Cable Co., Ltd.	Japan Cable Co., Ltd.	Notes
JKEV	KPEV	KNPEV	Non-Shielded
JKEV-S	KPEV-S	KNPEV-S	Shielded (Copper Foil)
JKEV-SB	KPEV-SB	KNPEV-SB	Shielded (Twisted)

NOTE:

- The cable always use the Twist-Pair Cable.
- Connection Cable: Field-Supplied
- Connection Cable: 0.75mm² Twisted-Pair Cable
- Max. Wiring Length: 1000m (totally)
- Either of Shielded and Non-shielded can use.

3.2. SETTING OF DIP SWITCH

3.2.1. SETTING OF DIP SWITCHES (DSW1 AND DSW2)

- Set the dip switches (DSW1 and DSW2) as follows.
It is necessary to set address setting in case of connecting more than 2 controllers (max. 8 controllers).

4 ELECTRICAL WIRING

■ Dip Switch Setting

	Pin No.	Contents of Setting	DSW Setting		Remarks
			ON	OFF	
DSW1	1	For Address Setting	Refer to the table below.		It is necessary to set these switches in case of connecting more than 2 units.
	2				
3					
	4	For Checking Connection	Not Available	Available	H-Link (Chiller~CSC-5S)
DSW2	1	Control Mode	Multiple Control	Individual Control	
	2	Output Signal Time for Transmission	60 sec.	30 sec.	
	3	-	-	-	
	4	-	-	-	

■ Setting of DSW1 (For Address Setting)

Address 1 (Factory setting)	Address 2	Address 3	Address 4
Address 5	Address 6	Address 7	Address 8

- If power supply cable is connected to terminal board for transmission signal and power supply voltage is applied by incorrect connection, the fuse is broken to protect printed circuit board. In this case, this controller is possible to operate without fuse by setting No.2 pin of DSW3 at the ON side.

DSW3 (Fuse Recover) ON OFF
1 2

⚠ CAUTION:

- Incorrect connection will cause controller damage.
- If wiring work is performed by providing power supply to controller, the controller may be broken. Check to ensure that power supply for controller and chiller unit is not provided.
- Do not run all signal cables together with power supply cable and other signal cables. Noise from these cables may cause malfunction of the controller and chiller unit. If signal cables run through together with power supply cable and other signal cables, keep a distance more than 15 cm between signal wiring and others or run the signal cables through the metal conduit tube and earth the either end of tube.
- Set the same address No. for remote controller and control timer.
- Set the DSW of the control timer to factory setting (OFF condition), except the address.
- Set the availability of the control timer (ON/OFF) to each chiller unit connected in the remote controller. For details, please check the "Timer Operation Procedure".
- For control timer operation, please refer to the "Installation & Operation Manual Control Timer" attached in the controller PSC-5T.

4. GROUP REGISTRATION

Indication after turning ON power switch
 If group registration is not performed, the indication is changed as follows.

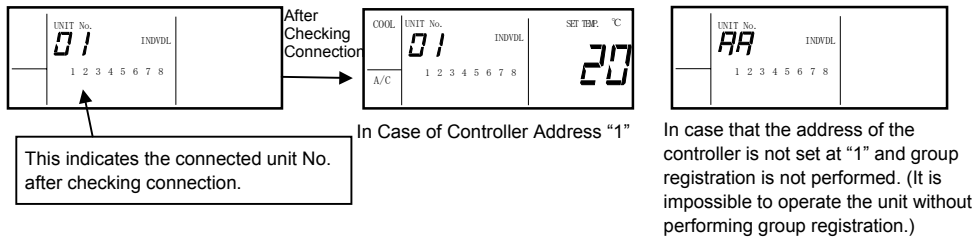

4.1. GROUP REGISTRATION PROCEDURE

■ Changing to Group Registration Mode

1. Press the "GROUP" switch for more than 3 seconds when all the units are stopped. If the mode is changed to group registration mode, the indication is changed as follows. Group registration mode is not available during operation. If this procedure is performed, "NO FUNC." is indicated on the LCD of controller.

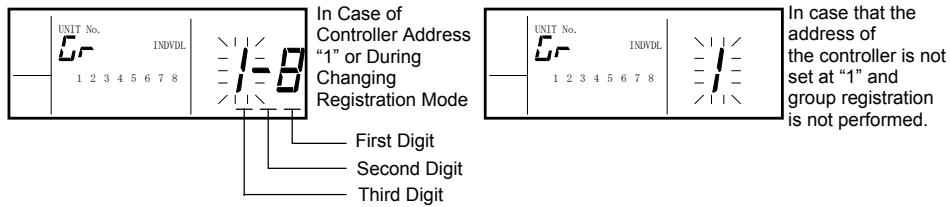

2. Set the min. controlled unit No. by pressing "△" or "▽" switch (third digit).
3. Press "GROUP" switch again.

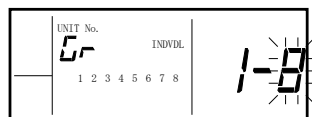

4. Set the max. controlled unit No. by pressing "△" or "▽" switch (first digit).
5. Press the "GROUP" switch for more than 3 seconds. The mode is changed from group registration mode to the normal mode.

6 GROUP REGISTRATION



CAUTION:

- If "RESET" switch is pressed or any switch is not pressed for more than 30 seconds, group registration mode is changed to the normal mode automatically. In this case, group registration is not available.
- Check to ensure that the same unit No. setting is not performed when two or more controllers are connected. In this case, it is necessary to set the controller address No. from the smaller unit No. If this procedure is not performed, the alarm code "E002" may occur. At that time, correct address No. of the controller having "E002" alarm code at first.

■ Example

1. Set address 1 on controller (add.1) for units Nos. 1 to 4.
2. Set address 2 on controller (add. 2) for units Nos. 4 to 7.
3. After setting group registration, "E002" alarm occurs in the controller address No. 2.
4. Correct the setting of the controller address No. 2 unit at Nos. 5 to 8.
5. "E002" alarm is cleared.

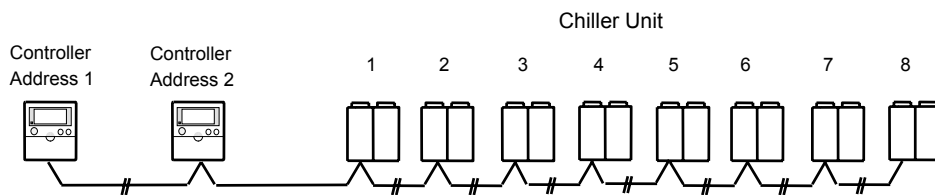

5. NAME OF EACH PART

■ Liquid Crystal Display Section

The figure below shows all the indications for reference. The actual display during operation is different.

Indication of Operating Unit (Page 10)	Indication of Individual Control (indicated during individual control) (Page 8)	Timer Indication (Page 16)	Indication of Emergency Stop (Page 17)
Indication of Each Unit Operation (Page 12)	Indication of Multiple Units Control (indicated during multiple units control) (Page 8)	Demand Indication (Page 17)	Indication of "No Function" (indicated in case of incorrect operation)

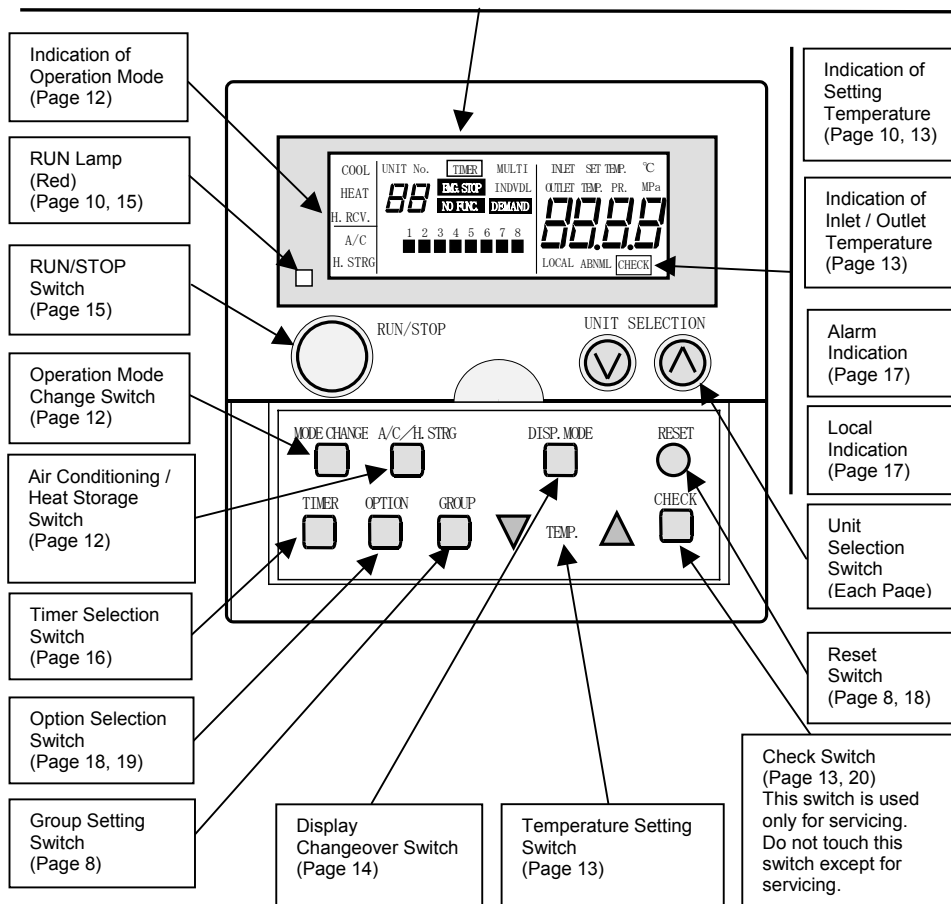

8 CONTROLS

■ Operation Switch Section

The above figure shows the central station with the cover opened. When opening the cover, pull the cover toward the arrow direction.

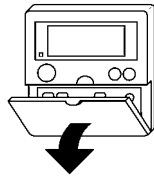

6. CONTROLS

Individual Control	<ul style="list-style-type: none"> - "INDVDL" is indicated at the display panel during this control. There are two controls available. One is group registration (see the item "Group Registration Procedure"). The control enables each unit control. The other is the simultaneous group control. By pressing the unit switch, the units Nos. are changed. "AA" indicates all the units which were registered. - The contents which are different depending unit except RUN lamp are not indicated during indicating unit No. "AA". (For example, Operation/Heat Storage Mode, Setting Temperature, Local, etc.) - Option setting is possible by selecting the following setting. (Refer to option setting procedure.) ON/OFF Differential Setting ••• Option 1
Multiple-unit Control	<ul style="list-style-type: none"> - "MULTI" is indicated at the display panel during this control. The unit which was set as group registration is automatically ON/OFF controlled by detecting the set temperature and sensing temperature. (If "UNIT SELECTION" switch is pressed during normal mode, "NO FUNC." is indicated.) - The control for the chillers up to 8 units are performed by sensing the minimum water temperature during cooling and the maximum water temperature during heating respectively. - In case of inlet (outlet) water temperature control, the chiller units are controlled by the minimum / maximum inlet (outlet) water temperature detected in the same group units. - Option setting is possible by selecting the following setting. (Refer to the option setting procedure on page 19) ON/OFF Differential Setting ••• Option 1 Selecting Inlet or Outlet Water Temperature Control ••• Option 2 Selecting Availability of Capacity Control for the Unit which is Stopped Finally ••• Option 3 Selecting Availability of Pump ON/OFF Control of the Unit which is Stopped by Thermostat ••• Option 4

NOTE:

- This control function is selected by setting No.1 pin of the DSW2 switch at ON or OFF side. This setting is necessary before the power is supplied. (This setting change is not available after supplying the power.)
- If this setting change is required, contact your local installer.

7. OPERATION PROCEDURE

7.1. GROUP REGISTRATION PROCEDURE

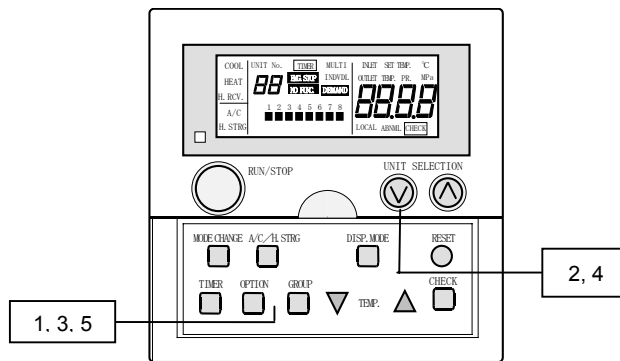

NOTE:

If the setting of group registration is changed, perform this procedure from the first step during unit stoppage.

<p>Supply power to the remote control switch. Switch ON the main power switch, and energize the oil heater to protect compressor for 12 hours before operation.</p>	
<p>1. Press the "GROUP" switch for more than 3 seconds. Third digit figure is flickered. (This digit indicates the minimum unit No. controlled by this controller.) In case of the address of the controller is not set "1" and group registration is not performed, the controller switch indicates nothing except third digit.</p>	
<p>2. By pressing the "UNIT SELECTION" switch, the unit confirmed to connect is indicated sequentially. (Set the minimum unit No.)</p>	

10 OPERATION PROCEDURE

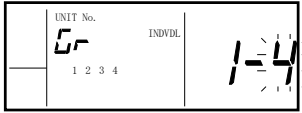
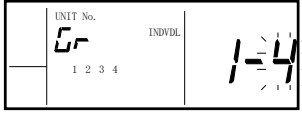
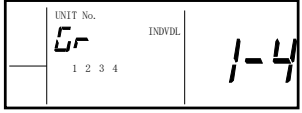
<p>3. Press the "GROUP" switch again. The first digit is flickered (the maximum unit No. is indicated at first).</p>	
<p>4. By pressing the "UNIT SELECTION" switch, the unit confirmed to connect No. bigger than minimum unit No. is indicated sequentially. (Set the maximum unit No.)</p>	
<p>5. By pressing the "GROUP" switch for more than 3 seconds again, the group setting is registered.</p>	

NOTE:

- If "RESET" switch is pressed or any switch is not pressed for more than 30 seconds, group registration mode is changed to the normal mode automatically. (During this time, group registration is not set.)
- Group registration is not available during unit operation. If this procedure is performed, "NO FUNC." is indicated.
- Check to ensure that the same unit No. setting was not performed in case of connecting two or more controllers. In this case, alarm code "E002" may occur at the controller having bigger address. At that time, set correct address No. to the controller having "E002" alarm code.

7.2. SELECTION FOR OPERATED UNIT AND UNIT STATE MONITORING

The controller controls the maximum 8 chiller units for individual or simultaneous. It is possible to operate the unit and check operating state of the units.

NOTE:

At the time to select the unit, unit No. is changed by pressing "UNIT SELECTION" switch. However, the unit not performed for group registration is not indicated.

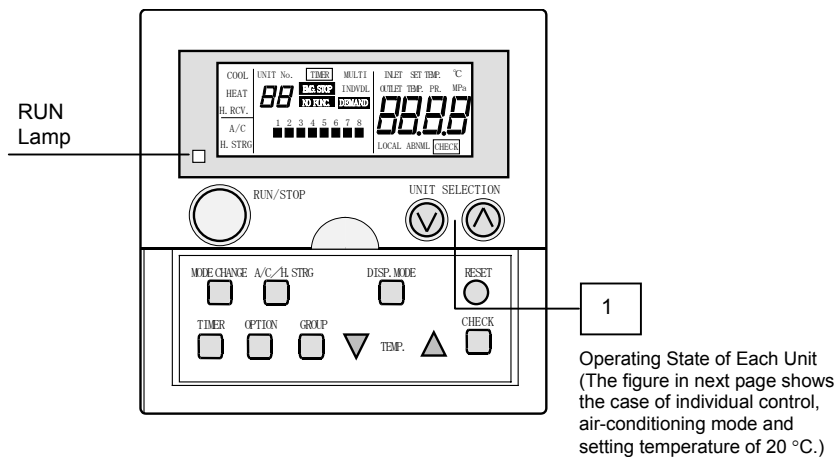

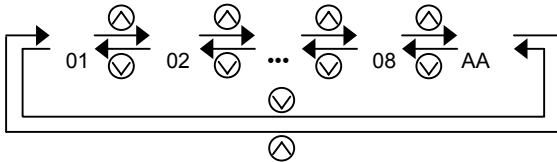
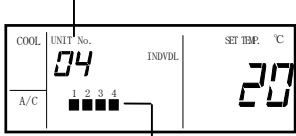
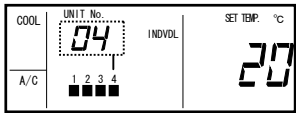

<p>1. Press "UNIT SELECTION" switch. By pressing, the target units are changed as follows. In case of indicating "AA", all units are operated simultaneously.</p>  <p>NOTE: This procedure is not performed in multiple unit control.</p>	<p>Unit No. is changed. The figure below shows the case of selecting unit No.4.</p>  <p>The registered unit No. is indicated.</p>
<p>2. If the unit is selected, current operating state of each unit is indicated.</p> <p>Symbol "■" shows the state of unit as follows. OFF Stoppage ON Operation Flicker Alarm</p> <p>Indication of RUN lamp shows as follows. OFF Stoppage for All Units ON Operation for More Than 1 Unit Flicker Alarm for More Than 1 Unit</p>	<p>Operating State of Each Unit (The figure below shows the case of individual control, air-conditioning mode and setting temperature of 20 °C)</p>  <p>Operating State of Each Unit (The above figure shows the case of operation for No.1 to No.4 units.)</p> <p>In case of unit No. AA, indication of operation mode, setting temperature, air condition/heat storage and local are displayed only when they are the same in the group.</p>

NOTE:
In case of multiple-unit control is selected and "UNIT SELECTION" switch is pressed, "NO FUNC." is indicated. (Unit No. is always indicated "AA" when all the units are operated simultaneously in normal mode.)

12 OPERATION PROCEDURE

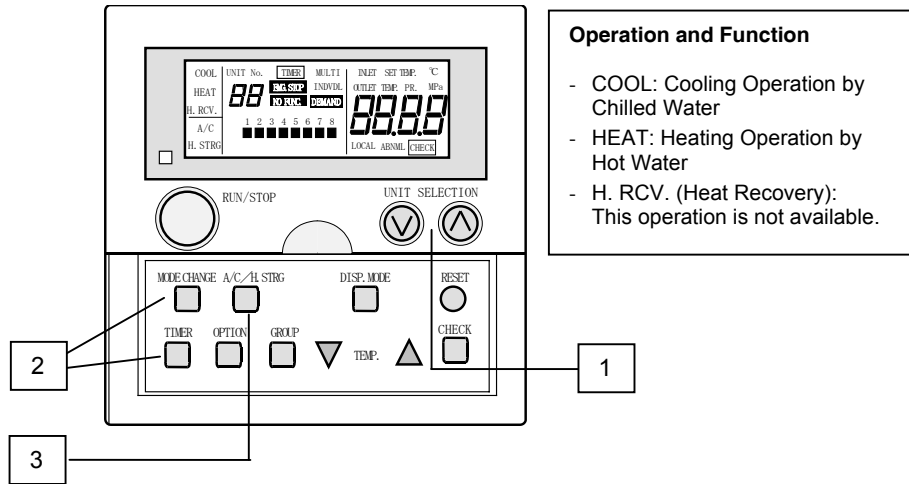
7.3. OPERATION MODE SETTING PROCEDURE

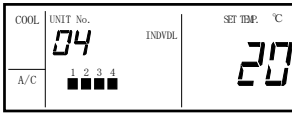

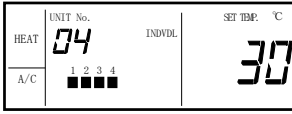
<p>1. Select the unit by pressing "UNIT SELECTION" switch. (Refer to item 1 of page 11.)</p> <p>NOTE: <i>This procedure is not performed during multiple-unit control.</i></p>	 <p>The above figure shows the case of selecting unit No.4.</p>
<p>2. Press "MODE CHANGE" switch. The operation mode is changed according to the following order.</p> <div style="text-align: center; margin: 10px 0;">  </div>	 <p>The above figure shows the case when "HEAT" operation is selected.</p>
<p>3. "A/C / H. STRG" switch. NOT AVAILABLE FUNCTION</p>	

NOTE:

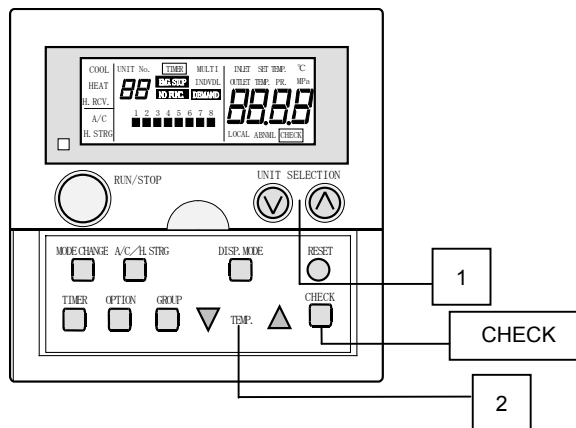

- The above instruction shows the case of operating No.4 unit. Operate another unit based on the same procedure. In case of selecting all the units, select "AA".
- Some functions are not available depending on models. Contact installer for details.
- Operation mode setting is not available during operation.
- In case of multiple-unit control is selected and "UNIT SELECTION" switch is pressed, "NO FUNC." is indicated. Unit No. is always indicated as "AA" when all the units are operated simultaneously, in normal mode.)

7.4. TEMPERATURE SETTING PROCEDURE



CAUTION:

- Do not touch "CHECK" switch.
- "CHECK" switch is for servicing only.
- If the mode is changed to checking mode by incorrect operation, the mode is changed to previous mode by pressing "RESET" switch.

<p>1. Select the unit by pressing "UNIT SELECTION" switch. (Refer to item 1 of page. 11)</p> <p>NOTE: <i>This procedure is not performed during multiple-unit control.</i></p>	 <p>The above figure shows the case of selecting unit No.4.</p>
<p>2. Press "TEMP" switch and set required temperature. Press Δ switch at once, setting temperature is increased by 1 °C. Press ∇ switch at once, setting temperature is decreased by 1 °C. Temperature setting range is different according to the unit.</p>	 <p>The above figure shows the case of setting temperature at 12°C.</p>

NOTE:

*Setting temperature is changed continuously if pressing the switch is maintained.
In case of the multiple-unit control is selected and "UNIT SELECTION" switch is pressed, "NO FUNC." is indicated. Unit No. is always indicated "AA" when all the units are operated simultaneously, in normal mode.*

14 OPERATION PROCEDURE

7.5. CHANGING DISPLAY MODE PROCEDURE

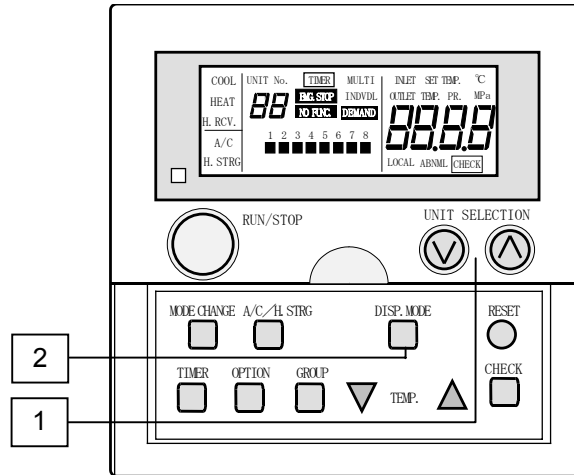

Select the unit by pressing "UNIT SELECTION" switch.
(Refer to item 1 of page. 11.)

NOTE:

This procedure is not performed during the multiple-unit control.

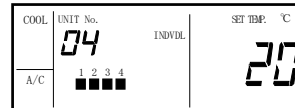

The above figure shows the case of selecting unit No.4.

Press "DISP. MODE" switch.

Indication of setting temperature is automatically changed as follows.

The display is changed according to the following order;
Inlet Water → Light Off → Outlet Temperature → Light Off



The above figure shows the case of indicating inlet temperature.

NOTE:

In case of the multiple-unit control is selected and "UNIT SELECTION" switch is pressed, "NO FUNC." is indicated. Unit No. is always indicated "AA" when all the units are operated simultaneously, in normal mode.

7.6. OPERATION PROCEDURE

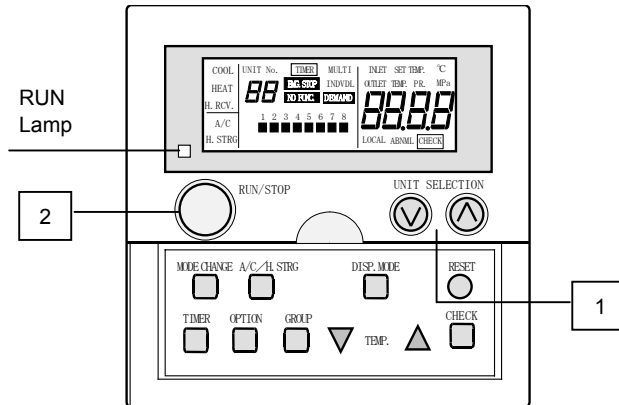

<p>1. Select the unit by pressing "UNIT SELECTION" switch. (Refer to the item 1 of page 11.)</p> <p>NOTE: This procedure is not performed during the multiple-unit control.</p>	<p>The above figure shows the case of selecting unit No.4.</p>
<p>2. Press "RUN/STOP" switch. If the selected unit is operating, the unit is stopped after pressing. If the unit has been stopped, the unit starts to operate after pressing. If "AA" is selected, the unit is operated as follows by pressing "RUN/STOP" switch.</p> <p>In Case of Operation more than 1 Unit (RUN lamp is ON.) → All the units are stopped. In Case of Stoppage of All The Unit (RUN lamp is OFF.) → All the units are started operation.</p>	<p>Turned ON</p> <p>The above figure shows the case of operating unit No.4.</p>

NOTE:

- Above instruction indicates the case of operating No.4 unit. Operate another unit based on the same procedure. In case of selecting all the units, select "AA".
- In case of multiple-unit control is selected and "UNIT SELECTION" switch is pressed, "NO FUNC." is indicated. Unit No. is always indicated "AA" when all the units are operated simultaneously, in normal mode.)
- In the case that power is supplied to only CSC-5S after power failure, the chiller unit is stopped for safety. Therefore, perform the operation once again after power supply.
- In the case that the chiller unit is restarted by the CSC-5S after power supply, restart the chiller unit more than 30 sec. after power supply.
In the case that it is starting operation within 30 sec, the display of CSC-5S becomes starting but the chiller unit is stopping still. In this case, restart the chiller unit more than 2 sec. after stop operation.
- Connection check is automatically performed by CSC-5S after power supply. (Unit Nos. from 1 to 10 are indicated on the liquid crystal.) During this connection check, wait for a while since operation by CSC-5S is not available.

16 OPERATION PROCEDURE

7.7. TIMER OPERATION PROCEDURE

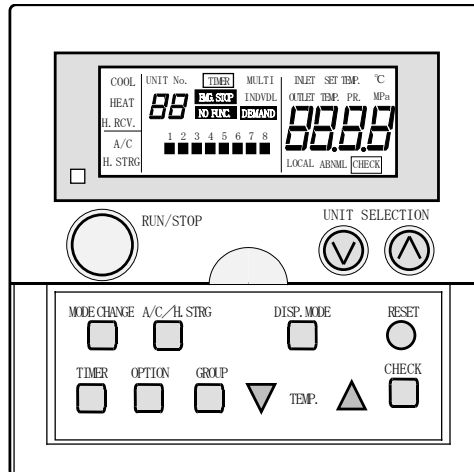

Operation and Function:

This is the function to set ON/OFF operation by sensing the signal from connected optional control timer (PSC-5T).

1. Select the unit by pressing "UNIT SELECTION" switch.
(Refer to chapter 1 of page. 7.)

NOTE:

This procedure is not performed during multiple control.

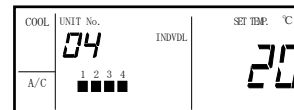

The above figure shows the case of selecting unit No.4.

2. Press "TIMER" switch.
 - Indication of "TIMER" appears or disappears alternatively.
 - The timer controlled unit is operated according to the set schedule.

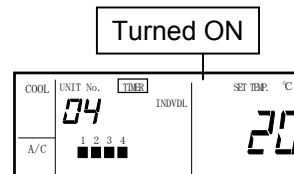

The above figure shows the case of operating unit No.4.

NOTE:

- The above instruction shows the case of operating No.4 unit. Operate another unit based on the same procedure. In case of selecting all the units, select "AA".
- In case of multiple-unit control is selected and "UNIT SELECTION" switch is pressed, "NO FUNC." is indicated. Unit No. is always indicated "AA" when all the units are operated simultaneously, in normal mode.)
- Set the same address No. for remote controller and control timer.

7.8. OTHER INDICATIONS

■ Normal Indications

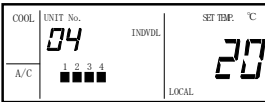
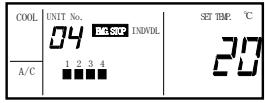
<p>LOCAL: "LOCAL" is indicated when setting local at the chiller unit. Setting is not available to change from controller during this indication. Contact to installer for details.</p>	
<p>DEMAND: This function is not available.</p>	
<p>EMG.(Emergency) STOP: "EMG. STOP" is indicated when the signal is input at external input 2 port on this controller. Contact to installer for details.</p>	

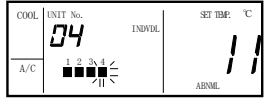

■ Alarm Indications

<p>Abnormal Condition:</p> <ul style="list-style-type: none"> - If any unit occurs under an abnormal condition, operation lamp is flickered. - "ABNML" is indicated on the liquid crystal display. - Indication "■" of the unit having an alarm code is flickered. - Unit No., alarm code and nominal indication is indicated alternatively. - If alarm code occurs in multiple-control units, unit No. and alarm code are indicated from the unit having smaller No. sequentially. - Check the alarm code, and contact your installer. 	
<p>Power Failure:</p> <ul style="list-style-type: none"> - All the indications are disappeared. - If the unit is stopped by power failure, the unit does not start automatically even if the power is supplied. Operate the unit again. - If the unit is stopped by an instantaneous power failure within 2 seconds, the unit is restarted automatically. 	
<p>Noise:</p> <ul style="list-style-type: none"> - All the indication is disappeared, and the unit is stopped in some cases. This means the micro-processor is activated to protect equipment from the effect of noise. Operate the unit again. 	

18 OPERATION PROCEDURE

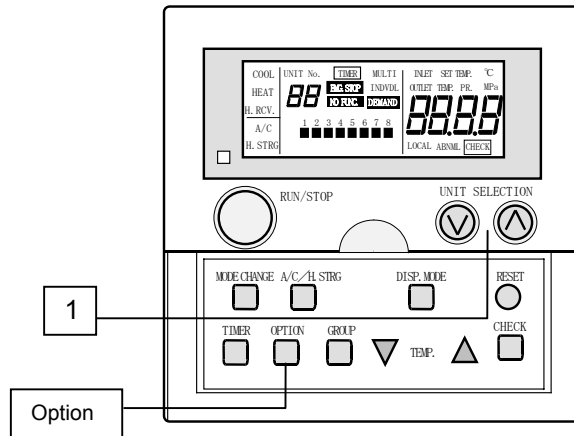
7.9. OPTION SETTING PROCEDURE

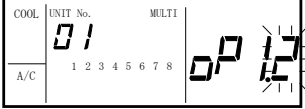
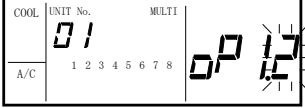

<p>1. Select the unit by pressing the "UNIT SELECTION" switch. (Refer to chapter 1 of page. 7.)</p> <p>NOTE: This procedure is not performed during multiple-unit control.</p>	 <p>The above figure shows the case of selecting unit No.1.</p>
<p>2. Press the "OPTION" switch for more than 3 seconds. Indication of option setting is flickered.</p>	
<p>3. By pressing the "OPTION" switch, the option No. is changed sequentially respectively. Option No. is shown in Table 1 of page 19.</p>	 <p>Option No.</p>
<p>4. Press the "TEMP." switch and select the option setting. (In case of option No.2, select Inlet or Outlet.)</p>	 <p>Option Setting</p>
<p>5. Option setting is registered by pressing the "OPTION" switch for more than 3 seconds.</p>	

NOTE:

- In case of individual control, option No.1 only is available.
- If "RESET" switch is pressed or any switch is not pressed for more than 30 seconds during option setting procedure, option setting mode is changed to the normal mode without option setting. (A setting is not registered in this case.)
- Option setting is not available during operation. If "OPTION" switch is pressed during operation, "NO FUNC." is indicated.
- If "UNIT SELECTION" switch is pressed in multiple-unit control, "NO FUNC." is indicated.
- Unit No. is always indicated as "AA" when all the units are operated simultaneously, in normal mode.

■ Table 1. Option Setting

Option No.	Setting	Content of setting	Setting at shipping	Individual Control	Multiple-unit Control
Option 1	2	Set Differential 2 Degree		○	○
	3	Set Differential 3 Degree	—		
	4	Set Differential 4 Degree	—		
Option 2	Inlet	Inlet Temperature Control	○	—	○
	Outlet	Outlet Temperature Control	—		
Option 3	0	Available for Capacity Control to the Unit Stopped Finally	○	—	○
	1	Not Available for Capacity Control to the Unit Stopped Finally	—		
Option 4	0	The pump is started after Thermo-OFF.	○	—	○
	1	The pump is stopped after Thermo-OFF.*	—		

* The water pump at the final stop still runs even under thermo-off.

8. EXTERNAL OUTPUT AND INPUT FUNCTION

This controller (CSC-5S) has a function of 2 channel External Input and Output respectively. Connection is shown below.

- 1 and 2 pin of CN2 ... External Input 1 Simultaneous Operation and Stoppage Input (Level Signal)
- 2 and 3 pin of CN2 ... External Input 2 Emergency Stoppage Input (Level Signal)
- 1 and 2 pin of CN3 ... External Output 1 Simultaneous Operation Output (Level Signal)
- 1 and 3 pin of CN3 ... External Output 2 Simultaneous Alarm Output (Level Signal)

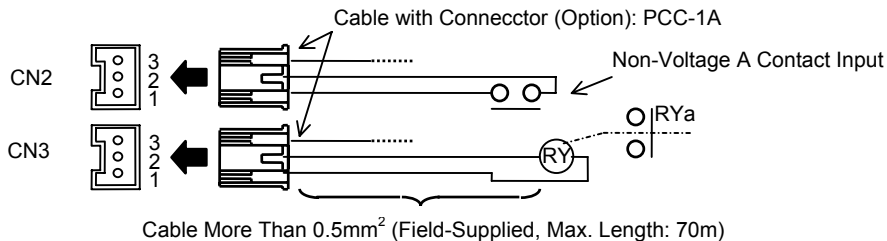

Use optional wiring assembly with the connector (PCC-1A) to connect external input and output. The suitable relay for the external output is of Omron MY type.

20 CHILLER CONTROLLER CHECKING PROCEDURE

9. CHILLER CONTROLLER CHECKING PROCEDURE

Checking mode indicates 3 kinds of contents as follows.

- Operating condition data, Chiller unit ROM No. and controller ROM No. etc. are indicated. Refer to the table below in detail.
- The content of abnormal stoppage including activation of safety devices is indicated up to max. 10 data.
- Capacity control state is indicated.

■ Changing to Checking Mode Procedure

1. Press the "CHECK" switch for more than 3 seconds. The mode is changed to checking mode. (Indicate various data)
2. By pressing the "CHECK" switch, indication is changed according to the following order.

various data → alarm history → capacity control state

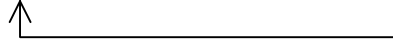

■ Indication of Various Data

1. By pressing the "TEMP." switch, the following contents are indicated.

Indication code	Indication Content	Unit	Remark
C1Pd ~ C6Pd	Discharge Pressure	MPa	Indicate Max. 6 Refrigerant Circuit Data
C1Ps ~ C6Ps	Suction Pressure	MPa	
C1td ~ C6td	Discharge Gas Temperature	°C	
C1ts ~ C6ts	Suction Gas Temperature	°C	
C1tr ~ C6tr	Liquid Refrigerant Temperature	°C	
CEL	Inlet Water Temperature	°C	
CoL	Outlet Water Temperature	°C	
CcoL	Individual Water Piping Outlet Temperature	°C	The display contents depend on chiller unit.
tSC	Setting Temperature of Chilled Water	°C	
tSH	Setting Temperature of Hot Water	°C	
tSCd	Setting Analog Temperature of Chilled Water	°C	
tSHd	Setting Analog Temperature of Hot Water	°C	
dF	Differential Setting	°C	
tA	Ambient Temperature	°C	
Crno	ROM No. of Chiller Unit		
CvEr	Version No. of Chiller Unit		
rno	ROM No. of Controller		

NOTE:

By pressing the "TEMP. ^" switch once, indication code is indicated, and by pressing the "TEMP. ^" switch again, indication content is indicated. If the "TEMP. v" switch is pressed, indication is changed in the opposite order.

2. By pressing the "UNIT SELECTION" switch, the unit No. is changed and each unit data is indicated. (In case of changing the indicated unit, indication is started from C1Pd.)

■ **Alarm History Indication**

Previous alarm occurrence data is indicated. The data is indicated up to 10 data by pressing the "UNIT SELECTION" switch.

■ **Capacity Control State Indication**

Capacity control state is indicated.

Individual Control: Capacity of each unit is indicated by each pressing the "UNIT SELECTION" switch.

Multiple-unit Control: Total Capacity of group is indicated.

NOTE:

If "RESET" switch is pressed, or any switch is not pressed for more than 30 seconds, Indication is changed to the normal mode.

10. CONTROLLER RESET PROCEDURE

■ **Reset Procedure**

In the case that group registration or option setting data is required to clear or checking of connection between the controller and the chiller units is required again, the setting of controller can be cleared by the following procedure. (It is impossible to clear some part of setting in this case.)

1. Changing to Self-Checking Mode

By pressing the "UNIT SELECTION ^" "UNIT SELECTION v" and "MODE CHANGE" switches simultaneously when all the groups of units are stopped, the mode is changed to self-checking mode. If one unit is operated, "NO FUNC." is indicated and mode is not changed to self-checking mode.

After changing to the self-checking mode, self-checking is started. By pressing the "UNIT SELECTION ^" "UNIT SELECTION v" and "MODE CHANGE" switches simultaneously again until "02" test start (Checking for Switch and DSW), the mode is changed to EEPROM checking mode.

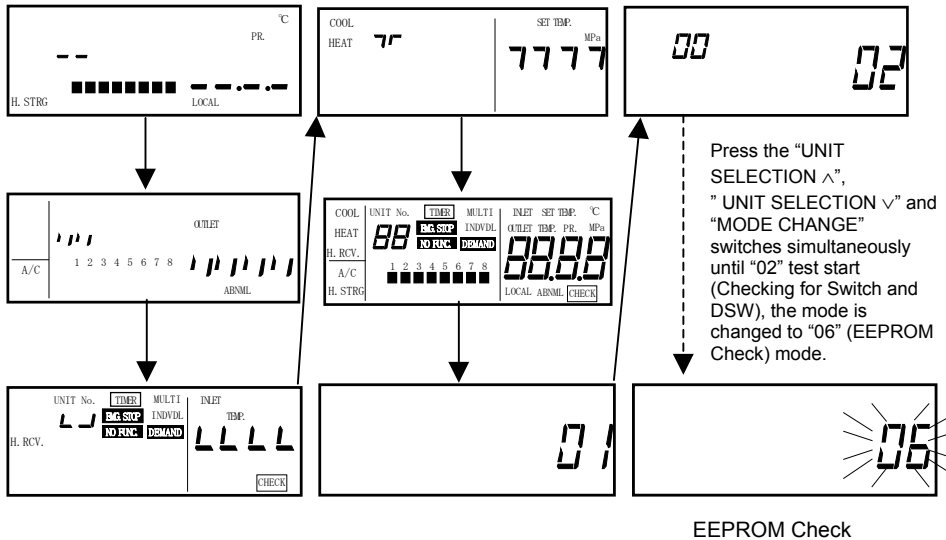

22 SELF-CHECKING MODE

NOTE:

In case of the "UNIT SELECTION ^", "UNIT SELECTION v" and "MODE CHANGE" switches are not simultaneously pressed again, self-checking continues. If the self-checking mode is required, refer to the self-checking procedure of page 23.

2. EEPROM Initialization

If the EEPROM initializing mode is started, the indication is changed as follows.

By press the "RESET" switch at this moment, indication "06" is changed from flickering to light ON and EEPROM is cleared. (If EEPROM is not cleared, press the "CHECK" switch.) After pressing the switch, indication is changed automatically as follows, and the mode is changed to connection checking mode.

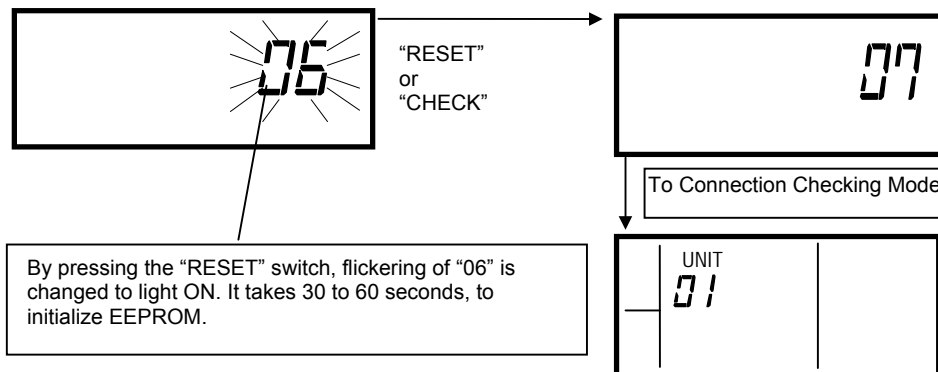

NOTE:

If it is not cleared, when connection check is not set, the mode is changed to the normal mode.

11. SELF-CHECKING MODE

1. Changing to Self-Checking Mode

By pressing the "UNIT SELECTION ^", "UNIT SELECTION v" and "MODE CHANGE" switches simultaneously when all the groups of units are stopped, the mode is changed to self-checking mode. If one unit is operated, "NO FUNC." is indicated and mode is not changed to self-checking mode.

Indication on the liquid crystal display is changed as follows.

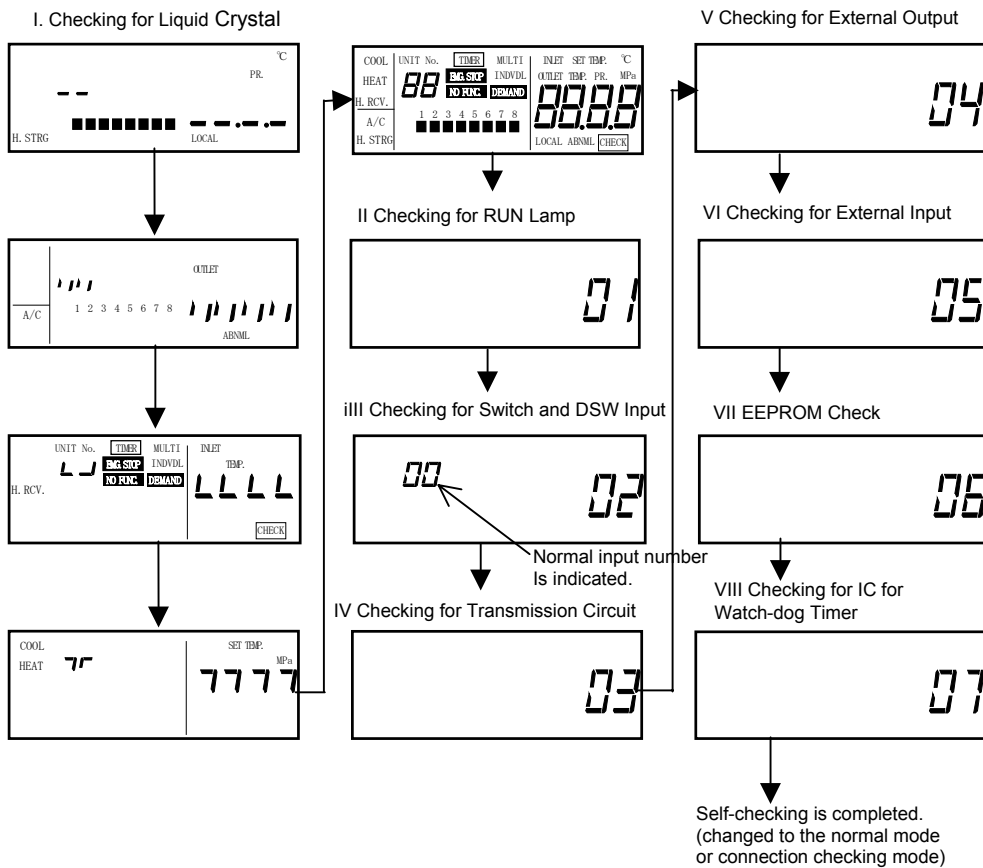

2. Checking Content

- I. Checking for Liquid Crystal Display. Checking is performed automatically.
- II. Checking for RUN Lamp RUN lamp is flickered twice.
- III. Checking for Switch and DSW Input. Press all the switch and turn DSW ON or OFF alternatively, check that the indicated number is "29" as a normal input number.
- IV. Checking for Transmission Circuit. Checking is performed automatically.
- V. Checking for External Output. Prepare a cable assembly as shown in the right figure and connect this cable to CN3. Checking proceeding is as follows.
 Turning ON LED1 for 2 seconds → Turning ON LED2 for 2 seconds
 Turning OFF LED1 and LED2 for 2 seconds
 Turning ON LED1 and LED2
 (LED is maintained to light ON until pressing the "CHECK" switch.)

24 SELF-CHECKING MODE

VI. Checking for External Input

Prepare the cable assembly as shown in the right figure and connect this cable to CN2. Checking proceeding is as follows.

By turning switch 1 ON, LED1 is turning ON → By turning switch 1 OFF and switch 2 ON, LED2 is turned ON

→ By turning switch 1 and 2 ON, LED1 and LED2 are turned ON
(LED is maintained to light ON until pressing the "CHECK" switch.)

VII. Checking for EEPROM

Refer to EEPROM clearing procedure of page 22.

VIII. Checking for IC for watch-dog timer

Checking is performed automatically.

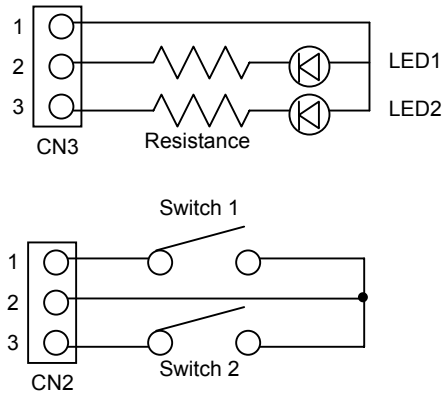

NOTE:

- By pressing the "UNIT SELECTION ^", "UNIT SELECTION v" and "MODE CHANGE" switches simultaneously until starting 02 test (Checking for Switch and DSW), the mode is changed to EEPROM checking mode.
- "04" External Output and "05" External Input checks are changed to the next procedure by pressing the "CHECK" switch.





HITACHI is participating in the EUROVENT Certification Programme.
Products are as specified in the EUROVENT Directory of Certified Products.

Certification No.
JOA-1084



Hitachi Air Conditioning Products Europe, S.A.
Ronda Shimizu, 1 - Políg. Ind. Can Torrella
08233 Vacarisses (Barcelona) España
ISO 9002 certified by AENOR, Spain



Hitachi Air Conditioning Products (M) Sdn. Bnd.
Lot No. 10, Jalan Kemajuan Bangi Industrial Estate
43650 Bandar Baru Bangi
Selangor Darul Ehsan, Malaysia
Certification ISO 9001, Malaysia

HITACHI