



VS Omni

Pool Automation Control

Installation Manual

Contents

Before you Begin.....	3
Mounting.....	7
Plumbing.....	9
Wiring.....	10
Startup.....	22
Configuration.....	22

HL32950VSP HL32900VSP
HL26720VSP HL23520VSP
HL23510VSP

Hayward Pool Products
620 Division Street, Elizabeth NJ 07207
Phone (908)-355-7995
www.hayward.com



HAYWARD®

FCC Statement

This device complies with part 15 of the FCC rules. Operation is subject to the following two conditions: (1) This device may not cause harmful interference, and (2) this device must accept any interference received, including interference that may cause undesired operation.

Changes or modifications not expressly approved by Hayward could void the user's authority to operate this equipment.

NOTE: This equipment has been tested and found to comply with the limits for a Class B digital device, pursuant to Part 15 of the FCC Rules. These limits are designed to provide reasonable protection against harmful interference in a residential installation. This equipment generates, uses and can radiate radio frequency energy and, if not installed and used in accordance with the instructions, may cause harmful interference to radio communications. However, there is no guarantee that interference will not occur in a particular installation. If this equipment does cause harmful interference to radio or television reception, which can be determined by turning the equipment off and on, the user is encouraged to try to correct the interference by one or more of the following measures:

- Reorient or relocate the receiving antenna.
- Increase the separation between the equipment and receiver.
- Connect the equipment into an outlet on a circuit different from that to which the receiver is connected.
- Consult the dealer or an experienced radio / TV technician for help.

Industry Canada Statement

This Class B digital apparatus complies with Canadian ICES-003.

Cet appareil numérique de la classe B est conforme à la norme NMB-003 du Canada.

The term "IC" before the certification / registration number only signifies that the Industry Canada technical specifications were met.



Table of Contents

Before you Begin.....	3
Overview.....	4
Mounting	
VS Hub.....	7
Control Pad.....	7
Smart Relay.....	8
Temperature Sensors.....	9
Plumbing.....	9
Electrical Wiring	
High Voltage.....	11
Low Voltage.....	13
System Startup.....	22
Configuration	
Pre Programmed Configuration.....	25
Typical Configuration.....	25
Advanced Configuration.....	27
Quick Edit.....	42
Control Pad Mounting Template.....	50



HAYWARD®

Before you Begin

What's Included

Check that the following components have been included in your package:

- VS Omni Hub
- Control Pad
- Smart Relay
- 2 Temperature Sensors
- Variable Speed Pump (VSP)
- 15 ft, 3 conductor (red, black and bare wire) communication cable to connect Hub to VSP
- 2 Wiring Whips - 6 ft flexible conduit containing three 12AWG conductors (red, black and green) for wiring VSP to VS Omni Hub and for Smart Relay installation). A length of white 12 AWG conductor is included to replace red for 115V Smart Relay applications
- Input Power Wiring harness and miscellaneous installation hardware

What's NOT Included

Some of the additional items that you may need to complete an installation include:

Wire

Wire/conduit for incoming power

Wire for remote heater control and other low voltage devices

Ethernet cable (if not using wifi)

Miscellaneous

Valve actuator to automate pool functions (see page 9)

Flow switch for pump protection/flow monitoring

Mounting hardware for mounting Hub, Control Pad and Smart Relay

Cable/cord connectors to provide knockout strain relief

Wire nut connectors

USB thumbstick (to update firmware)

Tools Needed

Philips and flat screwdrivers

Wire cutters and strippers

Knife to cut conduit

Drill and drill bits (including 3/8")

Pliers

Level

Accessory Products - Order Separately

HLH485RELAY Smart Relay used for controlling additional pool equipment

FLO Flow Switch used to detect water flow

GVA-24 Valve Actuator

2PC Temperature Sensor for 3rd input



HAYWARD®

Overview

The Hayward VS Omni is a web enabled pool automation control with a convenient touchscreen interface. Because it's packaged with a high efficiency variable speed pool filter pump, the VS Omni is ideal for both retrofit and new pool/spa installations. Automatically and remotely control pumps, a heater, a valve actuator, pool and yard lighting, and more. The VS Omni offers the next generation of technology to manage pool/spa equipment, allowing communication to web connected computers and mobile devices. You can now conveniently monitor your pool/spa and change settings anytime, and from anywhere.

Please read through this manual thoroughly before attempting to install, configure or operate this unit. A Quick Start guide is also included to offer concise information to experienced installers.

Features

The standard Hayward VS Omni offers the following functionality:

- controls up to 2 variable speed pumps for pool/spa filtration and water features
- controls up to 2 Smart Relays to turn on/off single speed pumps, pool lights, yard lights, water features, chemical dispensers and more
- controls up to two valve actuators allowing you to manage two bodies of water (both pool and spa) or can be used for water features, cleaners, solar heating, etc. (currently requires Hub to be powered by 230 VAC)
- controls one conventional heater (electric heatpump or gas) and optional solar heater (for single body of water applications only)
- inputs for up to 3 temperature sensors or external input devices
- built-in wireless to connect to the home's router/access point (ethernet port provided for optional wired connection)
- optional flow switch used to protect pool equipment by detecting water flow

Optional accessories (page 3) can expand the functionality of the VS Omni. Determine your needs and select the necessary accessories before you begin the installation.

Equipment

VS Omni Hub

All incoming/outgoing wiring will be connected to the Hub. The VS Omni Hub can be powered by either 115 VAC or 230 VAC. Input power should be constant, not from a timer. If a timer must be used, set the timer to power the Hub continuously. For convenience, a 6ft Wiring Whip is included with the VS Omni. This whip is intended to connect the Hub's input power to the variable speed pump if using 230 VAC. This connection should be made inside of the Hub and will ensure that both the Hub and pump are powered continuously.

The remaining connections, including the Control Pad, are all low voltage. Depending on your installation, these connections could be to a heater, Smart Relays, temperature sensors, actuator and a flow switch.



HAYWARD®

Installation

Installation Steps

DANGER of Death, Injury or Property Damage if procedure not followed. Power wiring must be shut off before attempting to install the VS Omni.

The VS Omni is designed to be mounted outdoors at the pool pad. Both the Hub and the Control Pad are water resistant and can be left out for the winter. Details on each installation step are shown below:

1. Mounting the equipment (page 7)
 - VS Omni Hub
 - Control Pad
 - Smart Relay
 - Temperature sensors
 - Valve actuators (if applicable)
2. Plumbing (page 9)
 - General Pool Equipment
 - Flow Switch
3. Electrical Wiring (page 10)
 - Hub power
 - Grounding
 - Low voltage wiring (Pool Pump Communication, Heater, Smart Relays, Temperature Sensors, Flow Switch, etc.)
5. System Startup and Firmware Upgrade (page 22)

The most common installation technique is described in the included Quick Start Guide. Use this guide if possible. If the Guide can not be applied to your particular installation, refer to the additional information in this manual.



HAYWARD®

Mounting the Equipment

VS Omni Hub

The Hub is contained in a raintight enclosure that is suitable for outdoor mounting. It must be mounted a minimum of 6 ft (2 meters) horizontal distance from the pool/spa (or more, if local codes require). The Hub is designed to mount vertically with the knockouts facing downward. Do not mount the Hub inside a panel or tightly enclosed area.

When selecting a location, note that the standard cables supplied with the optional flow switch, temperature sensors, and actuators are all 15 ft (5m) long. Additional low voltage connections will have to be made to the pump and/or heater. 115 VAC or 230 VAC input power must also be run to the Hub. Try to mount the Hub in a location where incoming/outgoing wiring will be easily accessible.

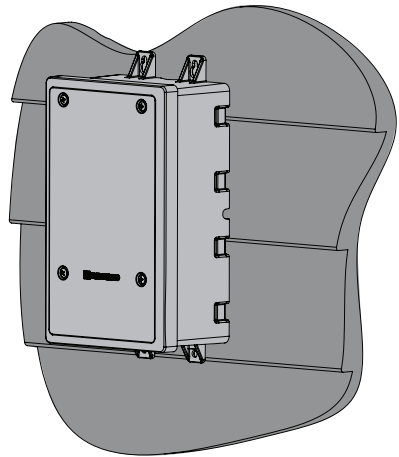

Mount the Hub on a wall or flat surface. Select mounting hardware that is appropriate for the mounting surface and material. The Hub has two keyhole type mounting tabs on the top and bottom of the enclosure requiring a total of 4 fasteners.

Control Pad

The Control Pad comes with a 15 ft cord and plugs into the Hub. It should be mounted in a location that is convenient for the user to view and change pool/spa settings. When considering the mounting location, make sure there is enough clearance above the enclosure so that the flip door will be able to be opened fully. Also be sure to allow enough clearance below the Control Pad to access the USB and Ethernet connectors. For best viewing results, position the Control Pad where it won't be subjected to direct sunlight.

The Control Pad has two keyhole cutouts on the back of its enclosure. To mount, screw the two provided fasteners into the mounting surface at the desired location using the template found on page 54. Tighten until the bottom of the screw heads are 1/8" off the mounting surface. Position the Control Pad cutouts over the screw and slide the unit downward. You may have to tighten or loosen the screws slightly to fully engage the screw heads to get a snug fit.



HAYWARD®

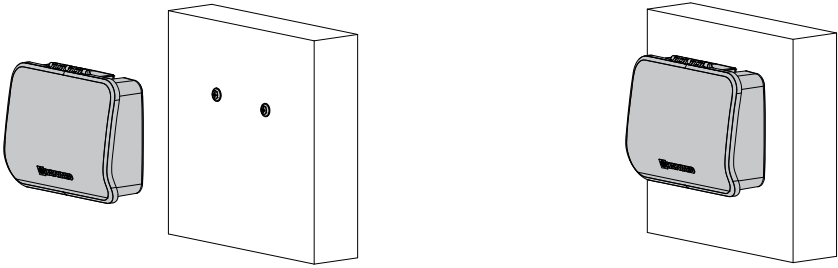

Smart Relay

The Smart Relay is packaged with a single gang electrical box but can also be used with any existing comparable standard electrical box with a minimum volume of 16.2 in³. If using 115 VAC, make sure that there is a Neutral line inside the box before installation. If not, you must run a separate Neutral wire to power the Smart Relay. This is not a concern if using 230 VAC. Note that conduit and connections to the included plastic box must be non-metallic.

Find a location within 15 ft of the Hub with convenient access to the pool equipment that you intend to control with the Smart Relay. Three threaded 1/2" NPT knockouts are provided for high voltage power coming into the relay and for power out to the pool equipment. A Wiring Whip is included to aid installation.

The Smart Relay has a manual On/Off button that can be used if communication is lost with the Hub. Although this button is not functional during normal operation, mount the Smart Relay in an accessible location to use this feature in case of communication loss.

Mount the Smart Relay to a wall or other flat surface using the mounting holes which are designed to accommodate #8 screws.

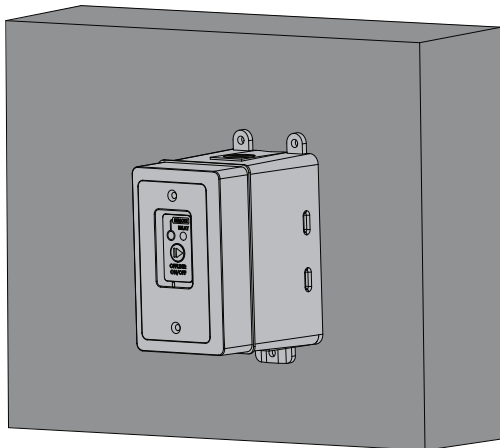



HAYWARD®

Temperature Sensors

Water Sensor

This sensor is used to measure the pool/spa temperature and is installed in the filtration plumbing after the filter but before either the solar or conventionally fueled heaters.

1. Drill a 3/8" (10mm) diameter hole in the PVC piping and remove all chips and burrs.
2. Insert sensor until O-ring collar sits flush on the hole.
3. Position hose clamp over the sensor and gently tighten until O-ring makes an adequate seal. Do not overtighten.

Air Sensor

Mount the air sensor outdoors. **IMPORTANT:** The air sensor must not be mounted in direct sunlight.

Solar Sensor

For solar applications, mount the sensor near the solar collector array so that it is exposed to the same sunlight as the collectors. Use additional cable (20 AWG) if necessary.

Optional Valve Actuators

Currently, using an Hayward GVA-24 actuator or equivalent requires that the Hub be powered with 230 VAC. If powering the VS Omni Hub with 115 VAC, an actuator can't be used. For installation, refer to the mounting instructions included with the unit. After configuring and first operating the valve, note that the internal cams in the actuator may have to be adjusted depending on the way the actuator is mounted on the valve and the desired valve action.

Plumbing

Optional Flow Switch

Only applicable if leak/clog detection is desired. The flow switch should be plumbed on the return side at the very end of the pool pad plumbing. This will ensure that if a leak occurs anywhere at the pool pad, the VS Omni will be able to detect it. Understand that if a leak occurs after the flow switch (downstream), the VS Omni will not sense a no flow condition.

IMPORTANT: There must be at least a 12" (30cm) straight pipe run before (upstream) the flow switch.

IMPORTANT: To ensure proper operation, verify that the arrow on the flow switch points in the direction of water flow.

Variable Speed Pump

Refer to the included VS Omni Pump manual for plumbing information.



Electrical Wiring

The Hub requires both high and low voltage connections. Always:

- Ensure that Power is disconnected prior to performing any wiring
- Follow all local and NEC (CEC if applicable) codes
- Use copper conductors only

A dedicated channel on the right side of the Hub has been provided for all low voltage wiring. All low voltage wires should run through this channel to exit the Hub. A weather resistant gasket is provided (see page 21) to seal this exit.

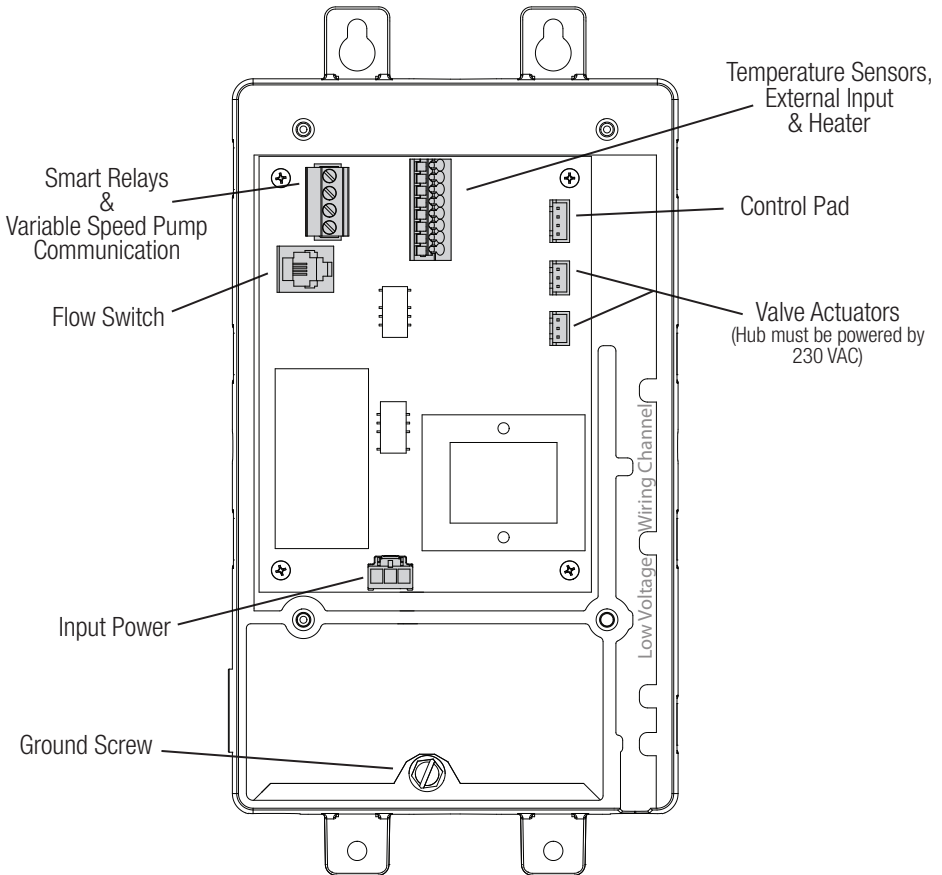



High Voltage Wiring

Hub Input Power

The Hub requires a constant 115 VAC or 230 VAC input power to operate. A wiring harness is included and will plug into the input power connector shown on page 10. Wire the harness according to the diagram below.

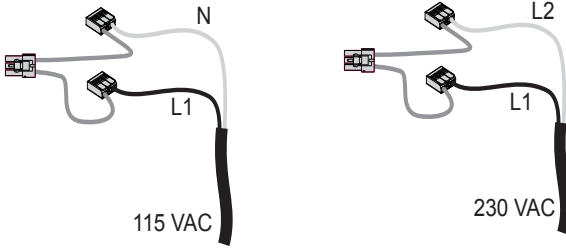

For easy installation, if replacing an existing 230 VAC pump, disconnect power at the pump and use that connection to provide power to both the Hub and the new variable speed pump (VSP). Use the included Wiring Whip to aid in this connection. The diagram below shows an existing timeclock used to power the old pump. This configuration can be easily modified to power the VS Omni and the new VSP. Refer to the diagrams below.

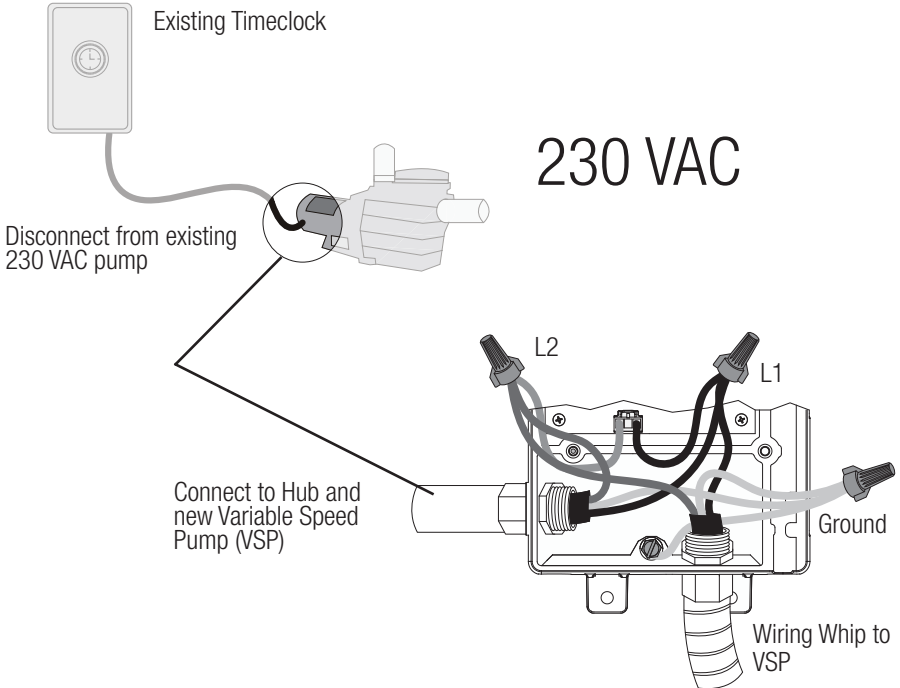



If replacing a 115 VAC pump, you can disconnect power at the pump and use it to power the Hub only. The new variable speed pump however, requires 230 VAC which will have to be run separately. Refer to the included pump manual for input power wiring.

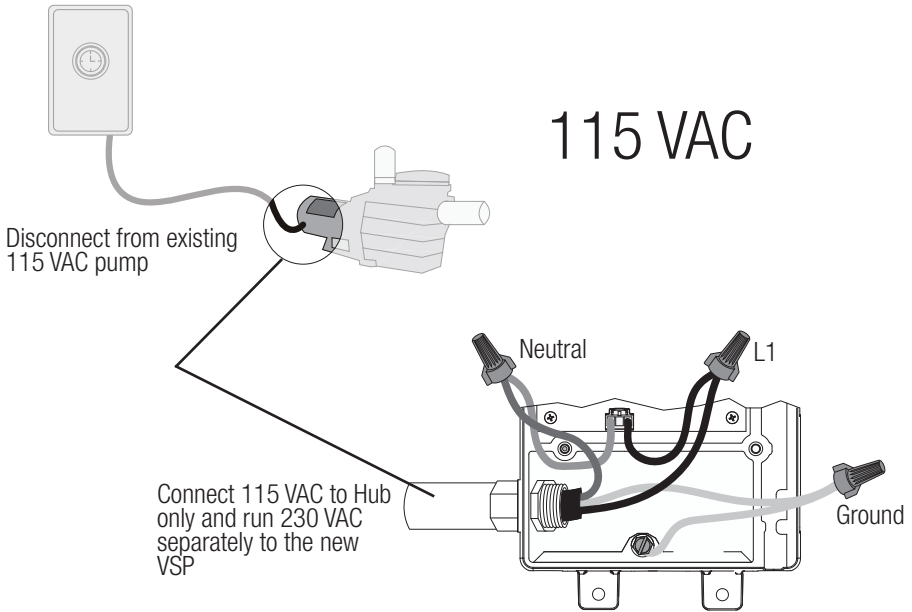

If using an existing timeclock to power the Omni VS Hub, set it to run constantly. If the VS Omni Hub will be connected to a panel or switch, the power will have to be left on continuously.

Grounding

Connect a ground wire from the primary electrical panel to the Hub's ground connection as shown in the previous diagrams. Also ground each piece of high voltage equipment that is connected through the Hub or Smart Relay.

Variable Speed Pump Input Power

The VS Omni pump requires a constant 230 VAC, 60Hz input power whether from the VS Omni Hub using the Wiring Whip or directly from a service panel/switch. Refer to the VS Omni Pump manual for the location of the wiring terminals as well as other related high voltage wiring information.



Smart Relay Load Wiring

A Smart Relay can be used to control either 115 or 230 VAC pool equipment. The relay is double pole (makes/breaks both "legs" of 230V circuits or one "leg" of 115V circuits). Refer to the diagram below for wire connections. Use the included Wiring Whip if the supplied electrical box will be mounted within 6 ft of the power source. Red, black and green conductors are included for 230 VAC and a white conductor is supplied if using 115 VAC input power. Use the included wire nuts for wiring connections. Use proper threaded strain relief fittings for conduit attached to knockouts. After wiring is complete, carefully insert the cover with connections into the box and secure.

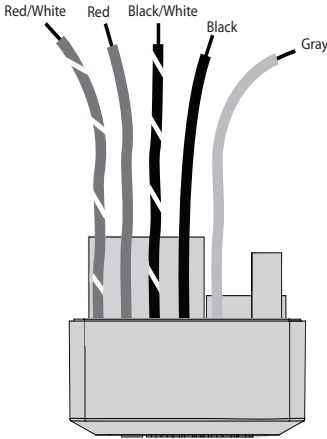

	Smart Relay Wire Colors	
115 VAC		230 VAC
Line in	Black	Line 1 in
Load out	Black/White	Load 1 out
Neutral	Gray	Connect Gray & Red to Line 2 in
No Connection	Red	
No Connection	Red/White	Load 2 out

Low Voltage Wiring

Note: There is a low voltage channel on the right side of the Hub's enclosure labeled on page 10 and shown on page 21. All low voltage wiring that exits the Hub must run through this channel. The included foam gasket (page 21) should be used to seal the channels's exit after wiring is complete. Do not run low voltage wiring through a knockout or with any high voltage wiring.

Hayward Variable Speed Pump (VSP) Wiring

A separate VSP pump manual has been included with the VS Omni. For low voltage communication wiring information, refer to the pump manual.



HAYWARD®

Smart Relays

Like VSPs, Smart Relays rely on communication from the Hub. Their 4 conductor cable is wired to the same connector as a VSP. Wire the cable as shown below. Up to two Smart Relays can be controlled by the VS Omni. In addition to communication wiring, the Smart Relay will be wired to high voltage pool equipment shown on page 13.

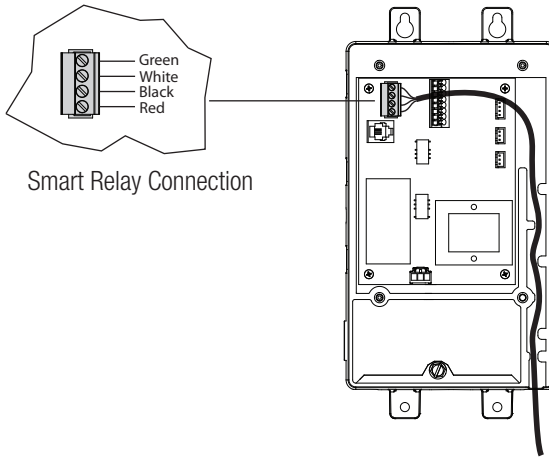

Valve Actuators

When wired for 230 VAC, the VS Omni can control up to two valve actuators which allow automated control of pool/spa, water features, cleaners or solar heating. The VS Omni is compatible with standard valve actuators manufactured by Hayward, Pentair/Compool, and Jandy. Actuators have 15 ft cables that are terminated with connectors that plug directly into the Hub as shown on page 10.

Temperature Sensors

The Hub utilizes 10K ohm thermistor type sensors with 15 ft cable. If a longer cable is required, contact the Hayward service dept. (908-355-7995) for information on suitable cable types and splices.

Temperature sensors are wired to the 8 position connector shown on page 10 and on the following page. To unlock, push on the corresponding lever with a small tool as shown. When pushed, the connector will be open and able to receive the wire lead. For best results, strip back leads 1/8" before inserting. After the wire is fully inserted, release the lever and the wire will lock in place.



HAYWARD®

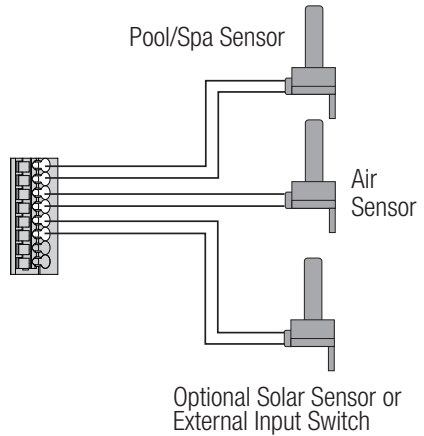
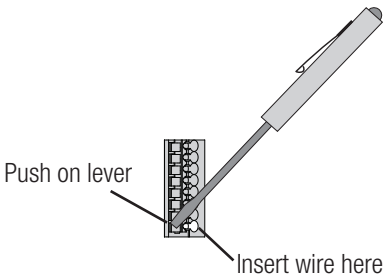

External Input Switch

If solar heating won't be used, a SPST external switch/device can be connected to this input. This normally open or normally closed on/off external device provides a means to turn the filter pump or other pool equipment on or off when certain conditions exist. Connect the external switch as shown below. After properly configuring the VS Omni (see Configuration Wizard), the filter pump and/or desired pool equipment will be forced on or off when the external device is activated.

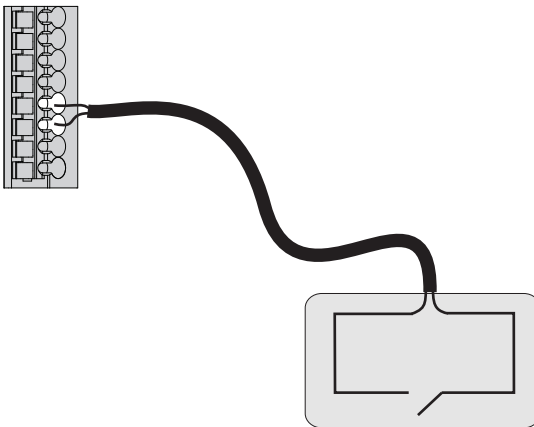

SPST External Switch
Either Normally Open or Normally Closed



Control Pad

The Control Pad has a 15 ft cable with a connector that plugs directly into the Hub as shown on page 10.

Note that there are rubber plugs covering USB port and Ethernet port on the bottom of the Control Pad. The ethernet port is available for those that desire a wired connection to their access point, rather than using the VS Omni's built-in wifi (see page 21). The USB port is only used for firmware upgrades.

Optional Flow Switch

The 15 ft flow switch cable plugs into the flow switch connector shown on page 10. Ensure that the connector catch "snaps" in order to provide a reliable connection.

Heaters

The manuals supplied with most heaters also include specific wiring instructions for connecting the heater to an external control (usually identified as "2-wire" remote control). For millivolt or line voltage heaters, contact Hayward Tech support, 908-355-7995. Refer to the information on the following pages for more details on the connection to several popular heaters. Refer to the diagram below for the location of heater connections at the Hub.

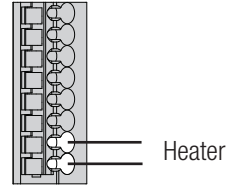

Generic Heaters

1. Wire heater to 115/230V power source per the instructions in the heater manual. The Hub does NOT control the power going to the heater.
2. Wire the Hub dry contact heater output per the diagram below. Many internal parts of the heater can get very hot--see the heater manufacturer's recommendations on the minimum temperature rating for wires. If no guidance is given, use 105°C rated wire.
3. Set any ON/OFF switch on the heater to ON.
4. Set the thermostat(s) on the heater to the maximum (hottest) setting.

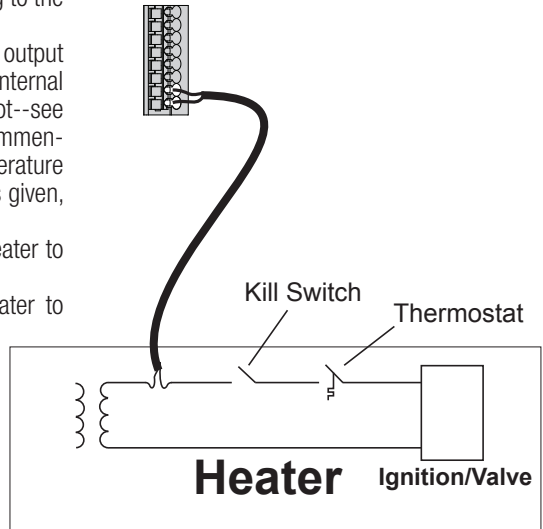

Laars Heaters

1. Turn power off to heater.
2. Remove factory jumper from terminal block.
3. Wire Hub to the heater as shown.
4. Ensure toggle switch is in the ON position.
5. Set heater thermostats to maximum position.

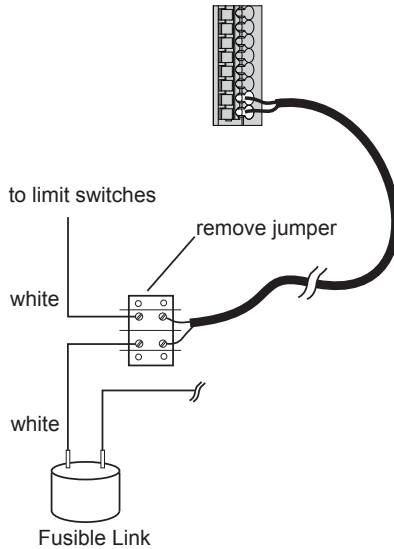

Hayward Pre-2007 Heaters

Refer to the instructions inside of the heater manual for “2-wire Remote Thermostat” operation under “Remote Control Connections” and the diagram on the following page:

1. Turn off power to heater.
2. Wire Hub to terminals 1 & 2 (see diagram).
3. Leave jumper attached to terminals 4 & 5.
4. Move “BYPASS” dipswitch on heater circuit board to “ON” position (up).
5. Turn heater power back on.
6. Switch heater to either “Pool” or “Spa” (it doesn’t make any difference which is selected, the Hub will take control).
7. Heater display should be “bO” (for “bypass On).
8. Heater will start whenever Hub requests (when Hub “Heater” LED is illuminated).



HAYWARD®

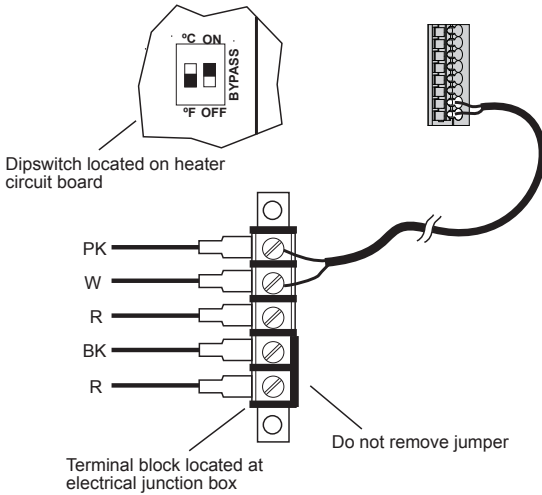

Hayward 2007-Current Heaters

Refer to the instructions in the heater manual for “2-wire Remote Thermostat” operation under “Remote Control Connections” and the diagram below:

1. Turn off power to heater.
2. Wire Hub to the heater terminals that have the Orange & White connections (see diagram).
3. Turn heater power back on.
4. Use the “MODE” key on the heater keypad to put the control into “STANDBY” mode.
5. Press and hold both the “DOWN” and “MODE” keys for 3 seconds until the display shows the code “bo”.
6. Be sure to put the heater’s control in either “POOL” or “SPA” mode.
7. The Hub will now control the heater.

To configure the heater for 2-wire remote thermostat control, use the “MODE” key on the heater keypad to put the control into “STANDBY” mode. Then press and hold both the “DOWN” and “MODE” keys for 3 seconds until the display shows the code “bo”.

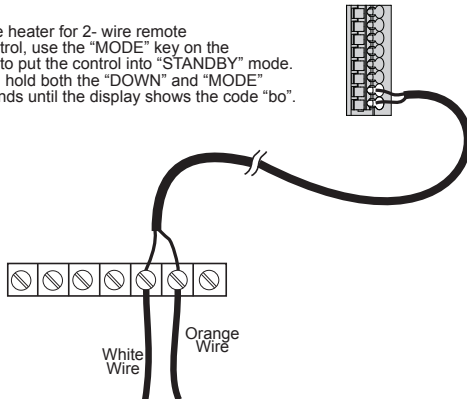



HAYWARD®

Pentair/Purex/MiniMax

1. Turn power off to heater.
2. Remove factory installed jumper from the “Ext Switch” connector.
3. Wire Hub to the “Ext Switch” connector as shown below.
4. The wires to the Hub must be separated from any line voltage wires. Failure to follow these instructions may cause erratic operation of the heater.
5. Set the Power (Thermostat Select) switch to either “Pool” or “Spa”.
6. Set the “Pool” and “Spa” thermostats to their maximum settings.

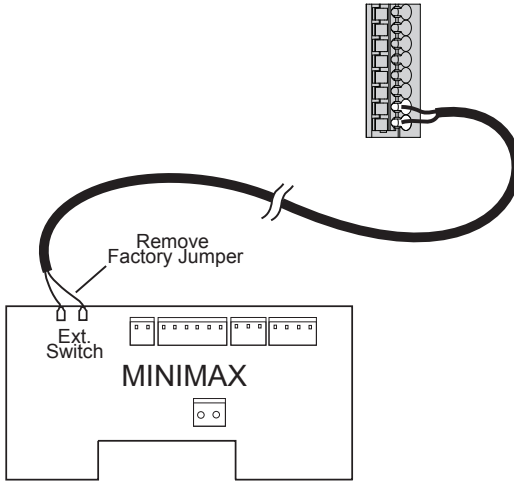

Raypak RP2100 Pool/Spa Heater

1. Turn power off to heater.
2. Push the mode button to “spa” mode.
3. Set the temperature to the maximum.
4. Push the mode button to “OFF”.
5. Lastly, plug the prewired connector in the P7 position on the board.

IMPORTANT: The heater will display “OFF” when it is being remotely controlled by the Hub. Some homeowners see the “OFF” display and, thinking this is a mistake, change the mode to “POOL” or “SPA” which then disables the remote control by the Hub. To prevent this: Remove the heater Touchpad connector (P5) which will disable the touchpad.



HAYWARD®

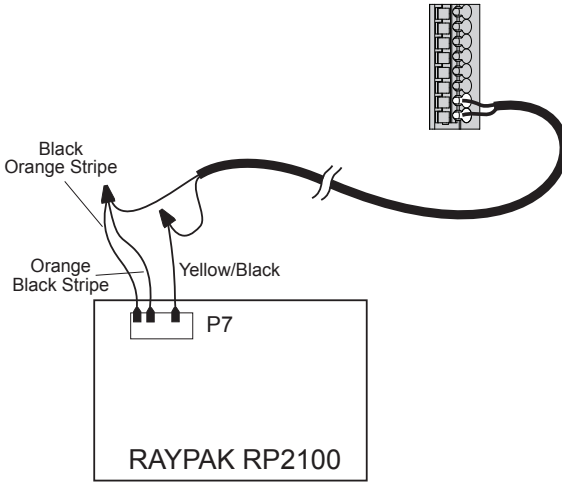

STA-RITE Heater

1. Turn power off to heater.
2. Remove upper jacket and open the control box.
3. Remove the jumper for the "fireman's switch".
4. Wire to the Hub using wire rated for 105°C minimum.

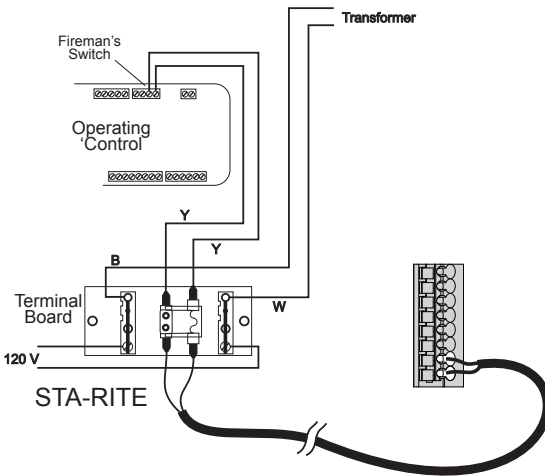

Home Router

Connection to the web is optional. If web enabled devices such as PCs, laptops, tablets or phones will be used to access the VS Omni, an ethernet or wireless connection must be made to the home router. For wireless connections, refer to the Configuration section of this manual. For ethernet connections, use outdoor rated Cat5e or Cat6 ethernet cable. Connect one end to the Control Pad and the other to an available LAN port (not WAN) on the home router. Refer to diagram below.

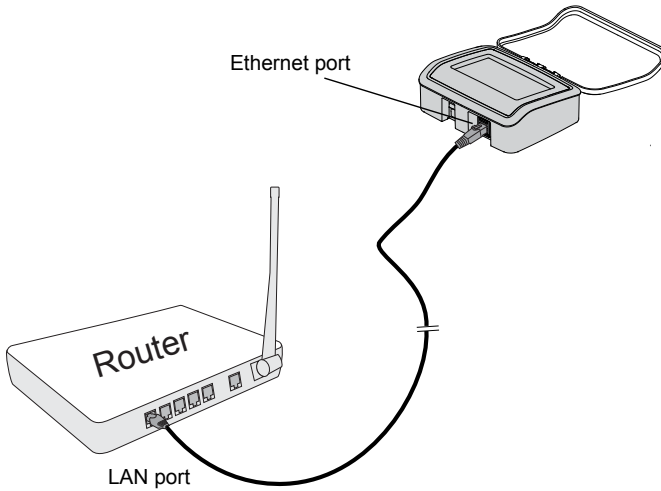

Final Steps

With the wiring complete, find the Hub's cover. The inside of the cover is made of foam and contains precut removable gaskets (shown below) that can be used to seal the low voltage exit. Remove a gasket and wrap it around the low voltage wiring at the exit of the Hub. Work the gasket into the exit slot until it is fully sealed then fasten the cover to the Hub.

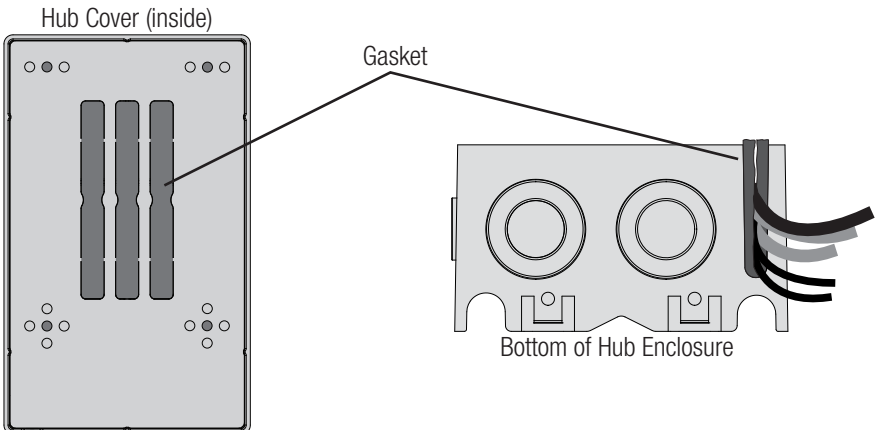



System Startup

After confirming that all wiring has been performed according to NEC and local codes and that the Hub is properly grounded, apply power to the VS Omni. The VS Omni will take about 30 seconds to fully start.

Firmware Upgrade

The VS Omni's firmware is the basic operating system that runs the unit. The VS Omni was shipped with the version of firmware that was available at the time of release. There may be a newer version available and if so, we encourage you to upgrade. Also, if you have experienced problems, Hayward Technical Support may advise you to upgrade your VS Omni's firmware. To upgrade the VS Omni firmware, refer to the procedure shown in the VS Omni Operation Manual. Upgrading firmware can be performed before or after Configuration but should be done before the VS Omni begins operation.

Configuration

Initial Configuration

Because this is the first time that the VS Omni has been powered on, it will bring you directly to the initial configuration screen shown below. Note that the VS Omni Control Pad uses a resistive touch screen that is appropriate for a pool environment. It requires a deliberate push when selecting a button. At the initial configuration screen, touch the "en" button to select a language (the default language is English) and then touch "OK" to begin configuration. After pressing "OK" you will be prompted to select the type of configuration wizard that you would like to use as shown below. See the descriptions in the "About the Configuration Wizard" section for information about each type of configuration wizard so that you can choose the right one to fit your needs and make configuration as simple as possible.

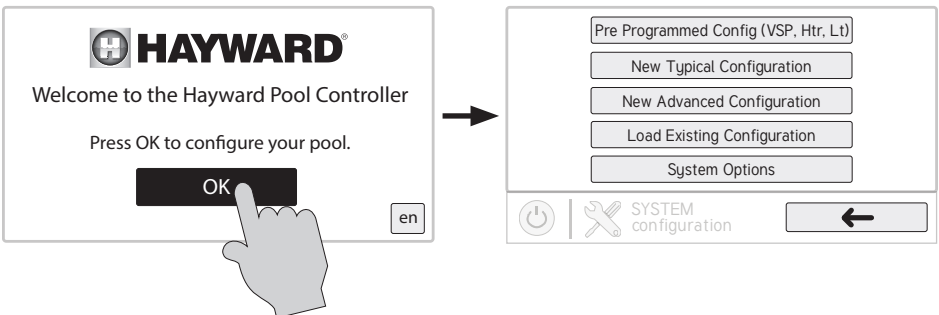



HAYWARD®

About the Configuration Wizard

The VS Omni Configuration Wizard will ask you general questions relating to your pool or spa and specific questions about connected pool equipment. Because this process may take some time, do not begin to configure the VS Omni unless you can dedicate at least 15 minutes or more. Configuring the VS Omni requires knowledge of all of the connected pool equipment.

If you are asked a question and don't know the answer, in many cases you'll be able to skip the question and proceed. In some cases the Configuration Wizard will require an answer. Answer the question to the best of your ability and take note as you'll be able to go back into the Configuration Wizard at a later time to make changes.

There are four different options for configuring the VS Omni: Pre-Programmed configuration, Typical configuration, Advanced configuration, and Load Existing configuration. The differences between these Configuration Wizards are described below.

Pre Programmed Configuration

This Configuration Wizard is the most basic and takes the least amount of time to complete. This option should be used if your system has only one variable speed pump, one heater (gas/heat pump), and one Smart Relay for a light, an air sensor, and a water sensor.

The Pre-Programmed Configuration option also comes with the following pre-programmed schedules:

1. Filter Pump - 8:00 AM to 8:00 PM / All Week / Medium Speed
2. Light - 7:00 PM to 11:00 PM / All Week

See page 25 for a full Pre-Programmed Configuration guide.

Typical Configuration

Use this Configuration Wizard if you have at least one variable speed pump and up to 2 Smart Relays in your system. See page 25 for a full Typical Configuration guide.

Advanced Configuration

This Configuration Wizard is the most detailed and takes the most amount of time to complete. This option can be used regardless of the number of variable speed pumps and Smart Relays in your system. Use this option if you are managing two bodies of water, using valves, multiple heaters (gas/heat pump + solar), and/or interlocks. See page 27 for a full Advanced Configuration guide.

Load Existing Configuration







This option should be used if you already have a pre-made configuration loaded onto a thumb drive that is ready to be uploaded to the VS Omni.

Navigation

The Configuration Wizard has been designed to be intuitive allowing most users the ability to navigate with little instruction. Here are a list of commonly used buttons are explained:



HAYWARD®

-  **Done** - Touch this button to complete your selection.
-  **Cancel** - Touch this button to cancel your selection.
-  **Advance** - Touch this button to advance to the next screen.
-  **Back** - Touch this button to return to the previous screen.
-  **Add** - Touch this button to add an item
-  **Delete** - Touch this button to delete a highlighted item.

After being prompted to make a selection or answer a question, touch the Done button (if available) and then the Advance button to go to the next screen. To go back to a previous screen, touch the Back button. Many selections will require you to touch the Done button before allowing you to advance. If a wrong selection has been made, touch the Delete button or Cancel. Some settings can be made by sliding a bar left or right to decrease or increase a value. You may be required to assign names to equipment. In this case, a keyboard will be displayed and you'll be able to type the desired name. After naming the equipment, save then advance. This method is repeated throughout the Configuration Wizard.

Begin the Configuration Wizard

In the initial configuration screen, select the Configuration Wizard that you would like to use (Pre-Programmed, Typical, Advanced, Load Existing). Once selected, follow the guide on the subsequent pages until you have completed the Wizard. At the end of the Wizard, you'll have the opportunity to save your settings or make a change.

NOTE: If additional pool or backyard equipment is added after initial configuration, or you'd like to make a change to an existing saved configuration, re-enter the Configuration Wizard and select "Edit Current Configuration". The initial configuration settings will be retained and you'll have an opportunity to make changes or additions. Be sure to save your configuration when exiting. See page 43 for the Quick Edit Guide.

Connect to Home Network

You will be prompted to connect to your home network after selecting the Configuration Wizard. You can connect either wirelessly or through a wired connection.

Set Up a Wireless Connection

Select "Yes" to the question "Would you like to set up a wireless connection?" From the Network Connections screen that follows, select the desired access point. You will then be prompted to input the password for that access point. Once you input the password and press the check mark to continue, a Network Diagnostic screen will appear and the VS Omni will run through a series of checks to verify connection to the access point. Once the system is done running through the diagnostics, press the check mark to continue to the next section of the Configuration Wizard.



HAYWARD®

Pre-Programmed Configuration Wizard Guide

As you progress through the Configuration Wizard, refer to the following information to help answer questions and make selections.

Connect to Home Network - The first thing you will do in the Configuration Wizard is connect to your home network. Refer to the “Connect to Home Network” section on page 24 for more information on this part of the Configuration Wizard.

Configuration Summary - Since you chose the “Pre-Programmed” configuration, you will be brought immediately to the Configuration Summary screen after connecting to your home network. This screen details all of the equipment that you have connected and configured to your VS Omni. Verify that the information on this screen is correct and then press the check mark to continue.

Finished with Configuration - After verifying the configuration summary, you are now finished with configuration and can choose to either save the configuration by pressing “Save and Restart” or make an additional change to the configuration by pressing “Customize / Add Components”. If you choose to edit the configuration, you will be brought to “Quick Edit” interface that allows you to quickly select the equipment that you want to add or modify. See page 43 for information on Quick Edit. Once you finish making your changes, save the configuration by pressing the save button on the bottom of the screen.

Typical Configuration Wizard Guide

As you progress through the Configuration Wizard, refer to the following information to help answer questions and make selections.

Connect to Home Network - The first thing you will do in the Configuration Wizard is connect to your home network. Refer to the “Connect to Home Network” section on page 24 for more information on this part of the Configuration Wizard.

Time and Date - Set the current date and time using a 12hr clock (AM/PM) or 24hr clock (military time). Save by touching the Done button when finished. NOTE: When registering the VS Omni and creating a web account, you'll be prompted to enter a Time Zone. Be sure to enter the same time zone as the physical location of the VS Omni, otherwise schedules and timers will be inaccurate.

Select Desired Units of Measure (Standard or Metric) - If Standard is selected, temperatures will be displayed in Fahrenheit and chemistry readings will be in ppm. If Metric is selected, temperatures will be displayed in Celsius and chemistry readings will be in g/L.

Select Desired Units of Measure (Speed in % or Speed in RPM) - If Speed in % is selected, then pump speeds will be displayed in %. If Speed in RPM is selected, then pump speeds will be displayed in RPM.

Which Hayward Unique Address? Select the HUA of the filter pump. NOTE: this option only appears if more than one variable speed pump is discovered.

Do you want to control a heater? Select whether or not you have a heater connected to the VS Omni.



HAYWARD®

If Yes is selected:

What type of heater? Select the type of heater that is connected to the VS Omni. Solar heating is not an option for a Typical configuration -- only Heat Pump and Gas are available.

Would you like to add a relay controlled accessory? Select whether or not you would like to configure a relay controlled accessory. This can be configured as a water feature, a light (incandescent or ColorLogic), a cleaner, or an accessory.

If Yes is selected:

Select the type of relay controlled accessory (water feature, light (incandescent or ColorLogic), cleaner, accessory).

If Water Feature, Cleaner, or Accessory is selected:

Select Relay: Choose the Smart Relay that the water feature is wired to. NOTE: this option only appears if more than one Smart Relay is discovered. With only one Smart Relay discovered, the VS Omni will automatically select the relay for you.

If Light is selected:

Type of Light: Choose the type of light that you want to configure. The options are UCL (14V), CL4.0 (115V), CL2.5 (14V), Incandescent, and Other.

Select Relay: Choose the Smart Relay that the light is wired to. NOTE: this option only appears if more than one Smart Relay is discovered. With only one Smart Relay discovered, the VS Omni will automatically select the relay for you.

Would you like to add a pump driven accessory? Select whether or not you would like to configure a pump driven accessory. NOTE: this option only appears if more than one variable speed pump is discovered.

If Yes is selected:

Select the type of pump driven accessory (water feature, cleaner, accessory)

If Water Feature, Cleaner, or Accessory is selected:

Which Hayward Unique Address? Select the HUA of the water feature, cleaner, or accessory's variable speed pump. NOTE: this option only appears if more than two variable speed pumps are discovered. With only two variable speed pumps discovered, the VS Omni will automatically select the HUA for you.

Configuration Summary - The Configuration Summary screen appears once you reach the end of the Configuration Wizard. This screen details all of the equipment that you have connected and configured to your VS Omni. Verify that the information on this screen is correct and then press the check mark to continue.

Finished with Configuration - After verifying the configuration summary, you are now finished with configuration and can choose to either save the configuration by pressing "Save and Restart" or make an additional change to the configuration by pressing "Customize / Add Components". If you choose to edit the configuration, you will be brought to "Quick Edit" interface that allows you to quickly select the equipment that you want to add or modify. See page 43 for information on Quick Edit. Once you finish making your changes, save the configuration by pressing the save button on the bottom of the screen.



HAYWARD®

Advanced Configuration Wizard Guide

As you progress through the Configuration Wizard, refer to the following information to help answer questions and make selections. Be aware that you may be asked to configure options/features that the VS Omni does not support. If unclear, refer to the "Features" section on page 4 to determine the type of operation that the VS Omni supports. Configuring equipment or functions that are not supported will prevent the VS Omni from working properly.

Connect to Home Network - The first thing you will do in the Configuration Wizard is connect to your home network. Refer to the "Connect to Home Network" section on page 24 for more information on this part of the Configuration Wizard.

Enable Screen Color Changes for System Alerts? To alert the user of warning conditions (no flow, failed sensor, etc.), the VS Omni can change its screen color. The screen can display yellow or red depending on the severity of the condition.

Time and Date - Set the current date and time using a 12hr clock (AM/PM) or 24hr clock (military time). Save by touching the Done button when finished. NOTE: When registering the VS Omni and creating a web account, you'll be prompted to enter a Time Zone. Be sure to enter the same time zone as the physical location of the VS Omni, otherwise schedules and timers will be inaccurate.

Select Desired Units of Measure (Standard or Metric) - If Standard is selected, temperatures will be displayed in Fahrenheit and chemistry readings will be in ppm. If Metric is selected, temperatures will be displayed in Celsius and chemistry readings will be in g/L.

Select Desired Units of Measure (Speed in % or Speed in RPM) - If Speed in % is selected, then pump speeds will be displayed in %. If Speed in RPM is selected, then pump speeds will be displayed in RPM.

MSP ID - The VS Omni MSP ID number will be displayed. This unique number is used to identify your VS Omni when setting up a web account. A web account is needed to access the VS Omni over the web by mobile devices. **IMPORTANT:** write down the MSP ID number for future use. The MSP ID number will be needed when entering the configuration wizard after initial configuration as well as entering and exiting Simple Mode. Simple Mode is a customizable screen that can be set up for quick access to pool/spa functions and features.

How many Bodies of Water? The VS Omni can support one or two bodies of water, typically a pool and spa. Select the number and advance. You'll be brought to a screen where you can add, delete or edit a Body of Water. When initially configuring the VS Omni, a "?" will appear in the Body of Water button. You will have to configure this body of water by selecting it and then touching the Advance button. When finished configuring bodies of water, you'll be returned to this same screen. Touch the Done button and advance to the next section of configuration.

IMPORTANT: If selecting two bodies of water, note that the filter pump and heater must be shared for both. The VS Omni does not support more than one filter pump and heater for both the pool and spa. Do not make selections that allow more than one set of equipment.

IMPORTANT: The following instructions are for Body of Water 1 (Pool) configuration. When finished



HAYWARD®

with the first Body of Water, you'll follow the same instructions for the second Body of Water, if previously selected. Configured equipment like a VSP and heater will be shared among both.

What is the Body of Water type? Select the type of Body of Water that you would like to configure. The choices are Pool and Spa.

Name of Body of Water - Selecting the box will allow you to edit the name. During initial configuration, the box will be blank. Select the box and then use the keyboard to enter the desired name of the body of water.

Name Filter Pump - Touch the box and use the keyboard to name the filter pump.

What Type of Pump? - Depending on your answer, the VS Omni will use one Smart Relay (single speed pumps), two Smart Relays (two speed pumps) or the low speed communication bus (VSP pumps) for pump control. Select the type of pump and advance.

If one speed or two speed pump is selected:

Which Relay is it Wired to? If using a single speed or two speed pump, you'll be asked which relay(s) is wired to the pump. If a value is already shown in the box(es), advance to the next screen. If no value is shown, selecting the box will bring you to a table showing all detected relays. Select the proper relay(s) from the table and touch the Done button to proceed. The relay(s) should now be shown in the box(es) and you can advance to the next screen to continue the pump configuration.

Filter Pump Off for Valve Change? When Yes is selected, the pump will shut off for 35 seconds whenever a valve changes position.

Flow Monitoring Enabled? *Requires use of a Hayward flow switch.* This feature will help protect the filter pump from damage due to no flow. When Yes is selected, the VS Omni will monitor the state of water flow when the filter pump is on. If no flow is detected for more than 15 minutes, the VS Omni will shut down the pool pump and will indicate an error. The error will be cleared the next time the pump is turned on.

Would You Like to Enable Priming? Select whether you want the filter pump to prime when turned on. This will turn the pump on at high speed for a set duration to establish normal water flow every time the pump is activated after being off for at least 30 seconds. NOTE: this option only appears if the filter pump is configured as a two speed pump.

If Yes is selected:

Enter Priming Duration: This is the number of minutes that the pump will prime before returning to the scheduled speed. Select 0-15 minutes.

Freeze Protection Enabled? Freeze protection is used to protect the pool and plumbed equipment against freeze damage during cold temperatures. If freeze protection is enabled AND the air temperature falls below the freeze threshold, the VS Omni will turn on the filter pump to circulate the water.

If Yes is selected:



HAYWARD®

Freeze Protect Temperature? Select the temperature to be used for freeze protection. Temperature is adjustable from 33°F-42°F (1°C-6°C). 38°F (3°C) is default. This threshold will be used for all outputs that have freeze protection enabled.

Freeze Protect Speed? For two speed pumps only, select 50% or 100%.

If VSP is selected:

Which Hayward Unique Address? If using a VSP, you'll be asked what is the Hayward Unique Address (HUA). If a value is already shown in the box, advance to the next screen. If no value is shown, selecting the box will bring you to a table showing all detected devices. Select the proper HUA from the table and touch the Done button. If unsure of the HUA, refer to the pump's manual for instructions on how to determine the pump's HUA. Once selected, the address should now be shown in the box and you can advance to the next screen to continue the VSP configuration.

Pump Capacity - Set the minimum and maximum RPM of the pump. Refer to your pump manual for more information.

Permitted User Setting - The VS Omni will automatically calculate these values based on the minimum and maximum RPM that were previously entered. They can be changed as desired.

Speed Presets - Set the Low Pump Speed %, Medium Pump Speed %, and High Pump Speed %, presets. These presets will be used when setting schedules for your pump.

Filter Pump Off for Valve Change? When Yes is selected, the pump will shut off for 35 seconds whenever the valve(s) change position.

Flow Monitoring Enabled? *Requires use of a Hayward flow switch.* This feature will help protect the filter pump from damage due to no flow. When Yes is selected, the VS Omni will monitor the state of water flow when the filter pump is on. If no flow is detected for more than 15 minutes, the VS Omni will shut down the pool pump and will indicate an error. The error will be cleared the next time the pump is turned on.

Would You Like to Enable Priming? Select whether you want the filter pump to prime when turned on. This will turn the pump on at high speed for a set duration to establish normal water flow every time the pump is activated after being off for at least 30 seconds. NOTE: this option only appears if the pump is a two speed pump or a variable speed pump.

If Yes is selected:

Enter Priming Duration: This is the number of minutes that the pump will prime before returning to the scheduled speed. Select 0-15 minutes.

Freeze Protection Enabled? Freeze protection is used to protect the pool and plumbed equipment against freeze damage during cold temperatures. If freeze protection is enabled AND the air temperature falls below the freeze threshold, the VS Omni will turn on the filter pump to circulate the water.

If Yes is selected:



HAYWARD®

Freeze Protect Temperature? Select the temperature to be used for freeze protection. Temperature is adjustable from 33°F-42°F (1°C-6°C). 38°F (3°C) is default. This threshold will be used for all outputs that have freeze protection enabled.

Freeze Protect Speed? This is the speed of the pump while freeze protection is active. Select the desired pump speed %. NOTE: this option only appears if the pump is a two speed pump or a variable speed pump.

How Many Heaters? - Answer "0", "1" or "2" to this question. The VS Omni supports up to two heaters for one body of water (conventional and solar only) and only one heater for two bodies of water.

If "1" or more is selected:

Heater Cooldown Enabled? This feature ensures that the heater cools down before water circulation is stopped. When enabled, the VS Omni will continue to run the filter pump for 5 minutes after the heater turns off.

Heater Extend Enabled? If "Enabled", the filter extend logic keeps the filter pump running beyond the normal turn-off time until the pool (or spa) is heated up to the desired temperature setting. Heater extend will NOT cause the filter pump to turn on, it will only delay the turn off time when the heater is operating.

Maximum Settable Temperature? This is the maximum allowed setting for the heater regardless of its default range. There may be circumstances where you will want to limit the high temperature of your heater to a temperature that is lower than the factory high setting.

Select and Configure a Heater At this screen, you can add, delete and configure your heater(s). Select the desired heater, then touch the Advance button. When finished configuring heater(s), you'll be returned to this same screen. Touch the Done button and advance to the next section of configuration. Refer to the following information when configuring heater(s):

What Type? Heater choices are Solar, Heat Pump and Gas. Make your selection and advance.

If Gas Heater is selected:

Name Heater: Select the box, then type the desired name for your heater. This name will be used when referring to this particular heater.

Which Relay is it Wired to? Selecting the box will bring you to a table showing all detected relays. Select the low voltage relay that is wired to the heater (refer to the Connection Table for this information), then advance. The relay should now be shown in the box. Advance to the next screen to continue gas heater configuration.

If more than one heater has been configured:

Heater Priority Duration? Set the amount of time that you will allow the priority heater ("1") to heat before allowing the next heater to



HAYWARD®

start. If the priority heater meets the demand within this time frame, the next heater will not be used. Note that a time interval setting of “0” will eliminate priority and always run both heaters at the same time.

Minimum Operation Speed? For variable speed pumps, select the lowest pump speed that is allowed while heating. Set a speed that will ensure that there will be sufficient flow for the heater to operate properly.

If Heat Pump is selected:

Name Heater: Select the box, then type the desired name for your heater. This name will be used when referring to this particular heater.

Which Relay is it Wired to? Selecting the box will bring you to a table showing all detected relays. Select the low voltage relay that is wired to the heater (refer to the Connection Table for this information), then advance. The relay should now be shown in the box. Advance to the next screen to continue heat pump configuration.

If more than one heater has been configured:

Heater Priority Duration? Set the amount of time that you will allow the priority heater (“1”) to heat before allowing the next heater to start. If the priority heater meets the demand within this time frame, the next heater will not be used. Note that a time interval setting of “0” will eliminate priority and always run both heaters at the same time.

Minimum Allowed Air Temperature for Heater? If the air temperature falls below this setting, the heater will be prevented from running, regardless of conditions. This feature is especially useful for heat pumps which become less efficient as the outdoor ambient temperature falls.

Minimum Operation Speed? For variable speed pumps, select the lowest pump speed that is allowed while heating. Set a speed that will ensure that there will be sufficient flow for the heater to operate properly.

If Solar is selected:

Name Heater Select the box, then type the desired name for your heater. This name will be used when referring to this particular heater.

Does the Solar Heater Have a Pump? Select whether the solar heating system has a dedicated recirculation pump. If so, the VS Omni will turn this pump on when the pool temperature is below the heater setting and there is solar heat available.

If Yes is selected:

Which Relay is it Wired to? Selecting the box will bring you to a table showing all detected relays. Select the high voltage relay that is wired to the pump (refer to the Connection Table in for this infor-



mation), then advance. The relay should now be shown in the box. Advance to the next screen to continue solar heater configuration.

Does the Solar Heater Have a Valve? Select whether the solar heating system has a diverter valve to route pool/spa water through the solar collectors. If so, the VS Omni will rotate this valve when the pool temperature is below the heater setting and there is solar heat available.

If Yes is selected:

Where is the valve wired? The VS Omni has two actuator outputs. Select the output that controls the solar heating diverter valve. Advance to the next screen to continue solar heater configuration.

Where is the Solar Temperature Sensor Located? Selecting the box will bring you to a table showing all detected sensors. Select the solar sensor (usually SENS3), then advance. The sensor should now be shown in the box. Advance to the next screen to continue solar heater configuration.

If more than one heater has been configured:

Heater Priority Level? Because more than one heater is configured to heat this Body of Water, you can set the Priority for which heater you'd like to use first (selection "1"). If the priority heater can't meet the demand, the next heater will start (selection "2").

Heater Priority Duration? Set the amount of time that you will allow the priority heater ("1") to heat before allowing the next heater to start. If the priority heater meets the demand within this time frame, the next heater will not be used. Note that a time interval setting of "0" will eliminate priority and always run both heaters at the same time.

Minimum Operation Speed? Select the lowest pump speed that is allowed while solar heating. Set a speed that will ensure that there will be sufficient flow for the solar heating system to operate properly.

How many cleaners? The VS Omni has two actuator outputs. If controlling a pool and spa (two bodies of water), you cannot add a cleaner that requires a valve.

If "1" or more is selected:

Select and Configure a Cleaner At this screen you can add, delete and configure your cleaner(s). Select the desired cleaner, then touch the Advance button. When finished configuring cleaner(s), you'll be returned to this same screen. Touch the Done button to advance to the next section of configuration. Refer to the following information when configuring cleaner(s):

Type of Cleaner? Touch the box and select the type of cleaner used. Choices are Pressure, Suction, Robotic and In-Floor.

Name of Cleaner - Touch the box and use the keyboard to name the cleaner.



HAYWARD®

Does Cleaner Have a Pump? Select whether the cleaner has a dedicated pump. If so, the VS Omni will turn this pump on when the cleaner is scheduled to run.

If Yes is selected:

What Type? Select the type of pump used. The choices are Single Speed, Two Speed and VSP.

If single speed or two speed pump is selected:

Which Relay is it Wired to? If using a single speed or two speed pump, you'll be asked which relay(s) is wired to the pump. If a value is already shown in the box(es), advance to the next screen. If no value is shown, selecting the box will bring you to a table showing all detected relays. Select the proper relay(s) from the table and touch the Done button. The relay should now be shown in the box(es) and you can advance to the next screen to continue the pump configuration.

If VSP is selected:

Which Hayward Unique Address? If using a VSP for your cleaner pump, you'll be asked what is the Hayward Unique Address (HUA). If a value is already shown in the box, advance to the next screen. If no value is shown, selecting the box will bring you to a table showing all detected devices. Select the proper HUA from the table and touch the Done button. The address should now be shown in the box and you can advance to the next screen to continue the VSP configuration.

Pump Capacity - Set the minimum and maximum RPM of the pump. Refer to your pump manual for more information.

Permitted User Setting - The VS Omni will automatically calculate these values based on the minimum and maximum RPM that were previously entered. They can be changed as desired.

Speed Presets - Set the Low Pump Speed %, Medium Pump Speed %, and High Pump Speed %, presets. These presets will be used when setting schedules for your pump.

Does Cleaner have a Valve? Select whether the cleaner requires a valve to change position when in use.

If Yes is selected:

How Many? Select how many valves are used for the cleaner.

Where is the Valve(s) Wired? Selecting the box will bring you to a table showing all detected low voltage relays. Select the relay(s) that is wired to the cleaner valve(s), then advance. The valve(s) should now be shown in the box(es). Advance to the next screen to continue.



HAYWARD®

Would you like your valve(s) to cycle On and Off at a set interval? If you would like the cleaner valve(s) to cycle to a set interval while cleaning, select Yes. Set the interval on the next screen.

Would You Like to Enable Priming? Select whether you want the pump to prime when turned on. This will turn the pump on at high speed for a set duration to establish normal water flow every time the pump is activated after being off for at least 30 seconds. This option is only available for two speed and variable speed pumps.

If Yes is selected:

Enter Priming Duration: Input the number of minutes that you want the pump to prime for. This setting is configurable from 0-15 minutes. Once priming has finished, the pump will run in the speed that it was chosen to run at.

Freeze Protection Enabled? Freeze protection is used to protect the pool and plumbed equipment against freeze damage during cold temperatures. If freeze protection is enabled AND the air temperature falls below the freeze threshold (refer to pump configuration), the VS Omni will turn on the cleaner pump to circulate the water.

If Yes is selected:

Freeze Protect Speed? This is the speed of the pump while freeze protection is active. Select the desired pump speed %. NOTE: this option only appears if the pump is a two speed pump or a variable speed pump.

How Many Water Features? Enter the number of water features that you have connected to the VS Omni.

If "1" or more is selected:

Type of Water Feature? Touch the box and select the type of water feature used. Choices are Water Feature, Water Slide, Waterfall, and Fountain.

Name of Water Feature - Touch the box and use the keyboard to name the water feature.

Does Water feature Have a Pump? Select whether the water feature has a dedicated pump. If so, the VS Omni will turn this pump on when the water feature is scheduled to run.

If Yes is selected:

What Type? Select the type of pump used. The choices are Single Speed, Two Speed and VSP.

If single speed or two speed pump is selected:

Which Relay is it Wired to? If using a single speed or two speed pump, you'll be asked which relay(s) is wired to the pump. If a value is already shown in the box(es), advance to the next screen. If no value is shown, selecting the box will bring you to a table showing all detected relays. Select the proper relay(s) from the table and touch the Done. The relay(s) should now be shown in the box(es) and you can advance to the next screen to continue the pump configuration.

If VSP is selected:

Which Hayward Unique Address? If using a VSP for your water



HAYWARD®

feature pump, you'll be asked what is the Hayward Unique Address (HUA). If a value is already shown in the box, advance to the next screen. If no value is shown, selecting the box will bring you to a table showing all detected devices. Select the proper HUA from the table and touch the Done button. If unsure of the HUA, refer to the pump's manual for instructions on how to determine the pump's HUA. Once selected, the address should now be shown in the box and you can advance to the next screen to continue the VSP configuration.

Pump Capacity - Set the minimum and maximum RPM of the pump. Refer to your pump manual for more information.

Permitted User Setting - The VS Omni will automatically calculate these values based on the minimum and maximum RPM that were previously entered. They can be changed as desired.

Speed Presets - Set the Low Pump Speed %, Medium Pump Speed %, and High Pump Speed %, presets. These presets will be used when setting schedules for your pump.

Does Water Feature have a Valve? Select whether the water feature requires a valve to change position when in use.

If Yes is selected:

How Many? Select how many valves are used for the water feature.

Where is the Valve(s) Wired? Selecting the box will bring you to a table showing all detected low voltage relays. Select the relay(s) that is wired to the water feature valve(s), then advance. The valve(s) should now be shown in the box. Advance to the next screen to continue.

Would You Like to Enable Priming? Select whether you want the pump to prime when turned on. This will turn the pump on at high speed for 3 minutes to establish normal water flow every time the pump is activated after being off for at least 30 seconds.

If Yes is selected:

Enter Priming Duration: Input the number of minutes that you want the pump to prime for. This setting is configurable from 0-15 minutes. Once priming has finished, the pump will run in the speed that it was chosen to run at.

Freeze Protection Enabled? Freeze protection is used to protect the pool and plumbed equipment against freeze damage during cold temperatures. If freeze protection is enabled AND the air temperature falls below the freeze threshold (refer to pump configuration), the VS Omni will turn on the water feature pump to circulate the water.

If YES is selected:

Freeze Protect Speed? This is the speed of the pump while freeze protection is active. Select the desired pump speed %. NOTE: this option only appears if the pump is a two speed pump or a variable speed pump.



HAYWARD®

Do You Want to Configure Any Lights? Select yes if you are using any type of lights. The options are UCL (14V), CL4.0 (115V), CL2.5 (14V), Incandescent, and Other. Note that the VS Omni can only support ColorLogic lights in Standalone mode using its high voltage relays.

If Yes is selected:

What Kind of Lights? Touch the box to select the type of lights that will be used. The options are UCL (14V), CL4.0 (115V), CL2.5 (14V), Incandescent, and Other.

Name the Group of Lights - Touch the box and use the keyboard to name the lights.

How Many Relays are Lights Wired to? Select the number of relays used by the lights.

Which Relay is it Wired to? Touching the box(es) will bring you to a table showing all detected relays. Select the relay(s) that are connected to the lights and touch the Done button. The relay(s) should now be shown in the box(es) and you can advance to the next screen to continue configuration.

How Many Pool Accessories? Select the number of accessories that will be used for this Body of Water only. You'll have an opportunity to configure accessories for the spa and also the backyard at a later point.

If "1" or more is selected:

Select and Configure Accessories At this screen you can add, delete and configure your accessories. Select the desired accessory, then touch the Advance button. When finished configuring accessories, you'll be returned to this same screen. Touch the Done button and advance to the next section of configuration. Refer to the following information when configuring accessories:

Type of Accessory? Touch the box and select the type of accessory used. Choices are Laminars, Jets, Blower and Other.

Name of Accessory - Touch the box and use the keyboard to name the accessory.

Does Accessory Have a Pump? Select whether the accessory has a dedicated pump. If so, the VS Omni will turn this pump on when the accessory is scheduled to run.

If Yes is selected:

What Type? Select the type of pump used. The choices are Single Speed, Two Speed and VSP.

If single speed or two speed pump is selected:

Which Relay is it Wired to? If using a single speed or two speed pump, you'll be asked which relay(s) is wired to the pump. If a value is already shown in the box(es), advance to the next screen. If no value is shown, selecting the box will bring you to a table showing all detected relays. Select the proper relay(s) from the table and touch the Done button. The relay(s) should now be shown in the box(es) and you can advance to the next screen to continue the pump configuration.



HAYWARD®

If VSP is selected:

Which Hayward Unique Address? If using a VSP for your accessory pump, you'll be asked what is the Hayward Unique Address (HUA). If a value is already shown in the box, advance to the next screen. If no value is shown, selecting the box will bring you to a table showing all detected devices. Select the proper HUA from the table and touch the Done button. The address should now be shown in the box and you can advance to the next screen to continue the VSP configuration.

Pump Capacity - Set the minimum and maximum RPM of the pump. Refer to your pump manual for more information.

Permitted User Setting - The VS Omni will automatically calculate these values based on the minimum and maximum RPM that were previously entered. They can be changed as desired.

Speed Presets - Set the Low Pump Speed %, Medium Pump Speed %, and High Pump Speed %, presets. These presets will be used when setting schedules for your pump.

Does Accessory have a Valve? Select whether the accessory requires a valve to change position when in use.

If Yes is selected:

How Many? Select how many valves are used for the accessory.

Where is the Valve(s) Wired? Selecting the box will bring you to a table showing all detected low voltage relays. Select the relay(s) that is wired to the accessory valve(s), then advance. The valve(s) should now be shown in the box. Advance to the next screen to continue accessory configuration.

Would You Like to Enable Priming? Select whether you want the pump to prime when turned on. This will turn the pump on at high speed for 3 minutes to establish normal water flow every time the pump is activated after being off for at least 30 seconds.

If Yes is selected:

Enter Priming Duration: Input the number of minutes that you want the pump to prime for. This setting is configurable from 0-15 minutes. Once priming has finished, the pump will run in the speed that it was chosen to run at.

Freeze Protection Enabled? Freeze protection is used to protect the pool and plumbed equipment against freeze damage during cold temperatures. If freeze protection is enabled AND the air temperature falls below the freeze threshold (refer to pump configuration), the VS Omni will turn on the accessory pump to circulate the water.

If Yes is selected:

Freeze Protect Speed? This is the speed of the pump while freeze protection is active. Select the desired pump speed %. NOTE: this option only appears if the pump is a two speed pump or a variable speed pump.



HAYWARD®

Do You Have an Air Temperature Sensor? Select whether there is an air temperature sensor wired to the VS Omni.

If Yes is selected:

Where is the Sensor Wired? Touching the box will bring you to a table showing all detected sensors connections. Select the sensor connection used for the air sensor (typically SENS2) and touch the Done button. The sensor connection should now be shown in the box and you can advance to the next screen to continue configuration.

Do You Have a Water Temperature Sensor? Select whether there is a water temperature sensor wired to the VS Omni.

If Yes is selected:

Where is the Sensor Wired? Touching the box will bring you to a table showing all detected sensors connections. Select the sensor connection used for the water sensor (typically SENS1) and touch the Done button. The sensor connection should now be shown in the box and you can advance to the next screen to continue configuration.

Do You Have a Flow Switch? Select whether there is a flow switch wired to the VS Omni.

If Yes is selected:

Where is the Sensor Wired? Touching the box will bring you to a table showing all detected sensors connections. Select the sensor connection used for the flow switch (typically FLOW SWITCH 1) and touch the Done button. The sensor connection should now be shown in the box and you can advance to the next screen to continue configuration.

Select and Configure Sensors At this screen you can add, delete and configure your sensors. Select the desired sensor, then touch the Advance button. When finished configuring sensors, you'll be returned to this same screen. Touch the Done button and advance to the next section of configuration. Refer to the following information when configuring sensors:

Where is the Sensor Located? Touch the box and go to the table showing the Bodies of Water and the Backyard. Select the location where the sensor is installed.

What Type of Sensor? Select the type of sensor. Choices are Air, Water, Flow or Solar.

Name Sensor - Touch the box and use the keyboard to name the sensor.

Where is the Sensor Wired? Touching the box will bring you to a table showing all detected sensors connections. Select the sensor connection used for the sensor and touch the Done button. The sensor connection should now be shown in the box and you can advance to the next screen to continue configuration.

Do You Want to Configure Any Backyard Lights? Select yes if you are using any type of lights in the backyard. The options are UCL (14V), CL4.0 (115V), CL2.5 (14V), Incandescent, and Other. Note that the VS Omni can only support lights in Standalone mode using its high voltage relays.

If Yes is selected:

What Kind of Lights? Touch the box to select the type of lights that will be used. The options are UCL (14V), CL4.0 (115V), CL2.5 (14V), Incandescent, and Other.



HAYWARD®

Name the Group of Lights - Touch the box and use the keyboard to name the lights.

How Many Relays are Lights Wired to? Select the number of relays used by the lights.

Which Relay is it Wired to? Touching the box(es) will bring you to a table showing all detected relays. Select the relay(s) that are connected to the lights and touch the Done button. The relay(s) should now be shown in the box(es) and you can advance to the next screen to continue configuration.

How Many Accessories are in the Backyard? Select the number of accessories that will be used for the backyard.

If "1" or more is selected:

Select and Configure Accessories At this screen you can add, delete and configure your accessories. Select the desired accessory, then touch the Advance button. When finished configuring accessories, you'll be returned to this same screen. Touch the Done button and advance to the next section of configuration. Refer to the following information when configuring accessories:

Name of Accessory - Touch the box and use the keyboard to name the accessory.

Which Relay is it Wired to? Touching the box will bring you to a table showing all detected relays. Select the relay that is connected to the accessory and touch the Done button. The relay should now be shown in the box and you can advance to the next screen to continue the accessory configuration.

NOTE: Do not use the VS Omni to control fire pits or any other fire related equipment.

Would You Like to Add an Interlock? An interlock will allow the VS Omni to turn on or to turn off a piece of pool equipment (slave) based on the state of other pool equipment (master). An example of this is would be the desire to turn on walkway lighting (slave) every time the pool deck lights (master) are turned on. This equipment could have been wired together to accomplish the same function, but by interlocking the walkway lights to the deck lights, you'll maintain the ability to turn on the walkway lights independently.

An interlock can also control pool equipment based on the state of a temperature sensor or normally on/off switch. An example of this would be to turn on a cabana fan (slave) whenever the outside temperature sensor (master) reads above 90°F.

If Yes is selected:

Select an Interlock Type - From this screen, select the type of interlock that you would like to configure. The choices are: Equipment to Equipment, Equipment to Flow Switch, Equipment to External Input, and Equipment to Temp. Sensor.

If Equipment to Equipment is selected:

Select Interlock Statement - Use the right and left arrows to choose the desired behavior of the interlock. The behavior for each interlock statement is described below.



HAYWARD®

If Equipment A is off, Equipment B can not be on - Equipment B will not turn on unless Equipment A is on. If both are running and Equipment A is turned off, Equipment B will turn off as well. Equipment B can be controlled independently as long as Equipment A is on.

If Equipment A is on, Equipment B can not be on - Equipment B will not turn on unless Equipment A is off. If Equipment B is running and Equipment A is turned on, Equipment B will turn off. Equipment B can be controlled independently as long as Equipment A is off.

If Equipment A is on, Equipment B is forced on - Equipment B is always off until Equipment A is turned on, at which point Equipment B will remain on until Equipment A is turned off. Equipment B cannot be controlled independently of Equipment A.

If Equipment A is on, Equipment B is forced off - Equipment B is always on until Equipment A is turned on, at which point Equipment B will remain off until Equipment A is turned off. Equipment B cannot be controlled independently of Equipment A.

Select Equipment - After selecting the desired interlock statement, use the buttons labeled "Equipment A" and "Equipment B" located below the interlock statement to choose the equipment that you would like to interlock. Pressing either button will bring you to another screen with all of the possible equipment that can be interlocked. Choose the desired equipment and then press save to lock in those values.

After saving the equipment, the interlock statement will change to include your selected equipment. Verify that the interlock statement correctly states the interlock that you would like to create and then press save to create the interlock.

If Equipment to Flow Switch is selected:

Select Interlock Statement - Use the right and left arrows to choose the desired behavior of the interlock. The behavior for each interlock statement is described:

If the Flow Switch detects no flow, the Equipment can not be on - The Equipment can only turn on if the Flow Switch detects flow. Once the Flow Switch detects no flow, the Equipment is turned off and cannot be turned on again until the Flow Switch detects flow.

If the Flow Switch detects flow, the Equipment can not be on - The Equipment can only turn on if the Flow Switch detects no flow. Once the Flow Switch detects flow again, the Equipment is turned off and cannot be turned on again until the Flow Switch detects no flow.



If the Flow Switch detects flow, the Equipment is forced on - The Equipment is always on as long as the Flow Switch detects flow. Once the Flow Switch detects no flow, the Equipment will turn off. The Equipment cannot be controlled independently.

If the Flow Switch detects flow, the Equipment is forced off - The Equipment is always off as long as the Flow Switch detects flow. Once the Flow Switch detects no flow, the Equipment will turn on. The Equipment cannot be controlled independently.

Select Equipment - After selecting the desired interlock statement, use the buttons labeled "Flow Switch" and "Equipment" located below the interlock statement to choose the flow switch and equipment that you would like to interlock. Pressing either button will bring you to another screen with all of the possible equipment that can be interlocked. Choose the desired flow switch and equipment then press save to lock in those values.

After saving the equipment, the interlock statement will change to include your selected equipment. Verify that the interlock statement correctly states the interlock that you would like to create and then press save to create the interlock.

If Equipment to External Input is selected (requires that you have an external input configured):

Select Interlock Statement - Use the right and left arrows to choose the desired behavior of the interlock. The behavior for each interlock statement is described below.

If the External Input is closed, the Equipment can not be on - The Equipment can only turn on if the External Input is open. If the Equipment is running and then the External Input becomes closed, the Equipment will turn off. The Equipment can be controlled independently as long as the External Input is open.

If the External Input is open, the Equipment can not be on - The Equipment can only turn on if the External Input is closed. If the Equipment is running and then the External Input becomes open, the Equipment will turn off. The Equipment can be controlled independently as long as the External Input is closed.

If the External Input is closed, the Equipment is forced on - The Equipment is always off until the External Input becomes closed, at which time the Equipment will remain on until the External Input becomes open again. The Equipment cannot be controlled independently.

If the External Input is closed, the Equipment is forced off - The Equipment is always on until the External Input becomes closed, at which time the Equip-



ment will remain off until the External Input becomes open again. The Equipment cannot be controlled independently.

Select Equipment - After selecting the desired interlock statement, use the buttons labeled “External Input” and “Equipment” located below the interlock statement to choose the external input and equipment that you would like to interlock. Pressing either button will bring you to another screen with all of the possible equipment that can be interlocked. Choose the desired external input and equipment then press save to lock in those values.

After saving the equipment, the interlock statement will change to include your selected equipment. Verify that the interlock statement correctly states the interlock that you would like to create and then press save to create the interlock.

NOTE: Freeze Protection will override External Interlocks for Filter Pumps but not for any other equipment.

If Equipment to Temp. Sensor is selected:

Select Interlock Statement - Use the right and left arrows to choose the desired behavior of the interlock. The behavior for each interlock statement is described below.

If the Temp. Sensor reads greater than Temperature degrees F, the Equipment can not be on - The Equipment can only be turned on if the Temp. Sensor reads less than the selected Temperature set-point. If the Equipment is running and then the Temp. Sensor reaches the selected Temperature set-point, the Equipment will turn off. The Equipment can be controlled independently as long as the Temp. Sensor reads less than the selected Temperature set-point.

If the Temp. Sensor reads less than Temperature degrees F, the Equipment can not be on - The Equipment can only be turned on if the Temp. Sensor reads greater than the selected Temperature set-point. If the Equipment is running and then the Temperature goes below the selected Temperature set-point, the Equipment will turn off. The Equipment can be controlled independently as long as the Temp. Sensor reads greater than the selected Temperature set-point.

If the Temp. Sensor reads greater than Temperature degrees F, the Equipment is forced on - The Equipment is always off until the Temp. Sensor reads greater than the selected Temperature set-point, at which time the Equipment will remain on until the Temperature falls back below the set-point. The Equipment cannot be controlled independently.

If the Temp. Sensor reads greater than Temperature degrees F, the Equipment is forced off - The Equipment is always on until the Temp. Sensor reads greater than the selected Temperature set-point, at which time the Equipment



HAYWARD®

will remain off until the Temperature falls back below the set-point. The Equipment cannot be controlled independently.

Select Equipment - After selecting the desired interlock statement, use the buttons labeled “Temp. Sensor”, “Temperature” and “Equipment” located below the interlock statement to choose the temperature sensor, temperature and equipment that you would like to interlock. Pressing any of these buttons will bring you to another screen with all of the possible equipment that can be interlocked. Choose the desired temperature sensor, temperature and equipment then press save to lock in those values.

After saving the equipment, the interlock statement will change to include your selected equipment. Verify that the interlock statement correctly states the interlock that you would like to create and then press save to create the interlock.

Configuration Summary The VS Omni displays all configured equipment in a table for you to view. Scroll through all configured devices and make sure they've been properly assigned.

Finished with Configuration Now that all equipment has been configured, select the following:

Customizing / Add Components - use this selection to go back into Configuration and make changes.

Save and Restart - this selection will save your configuration settings and restart the VS Omni.

Quick Edit Guide

If additional pool or backyard equipment is added after initial configuration, or you'd like to make a change to an existing configuration setting, re-enter the Configuration Wizard and select “Edit”. After selecting “Edit”, you will be brought to the Quick Edit Main Menu screen as shown below. Quick Edit allows you to go directly to the equipment that you'd like to add/remove/configure. When you have finished editing the configuration, you will return to this screen to save your changes.

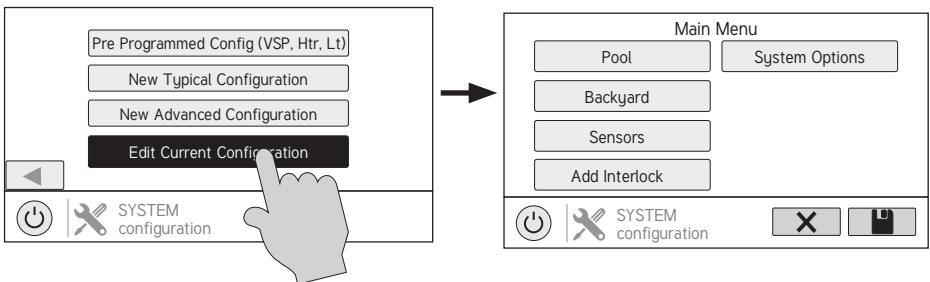

Navigation

There are a number of additional buttons that appear in Quick Edit that either have functions unique to Quick Edit or do not appear anywhere else in the system. These buttons are as follows:



HAYWARD®



Save - Touch this button to save the configuration edit. This button only appears on the Quick Edit Home screen.



Cancel - Touch this button to cancel any changes made to the configuration and exit Quick Edit. This button only appears on the Quick Edit Home Screen.



Home - Touch this button to quickly jump back to the Quick Edit Main Menu Screen to save your changes. This button appears at the end of every configuration pathway.



Back - Touch this button to go back to the previous set of configurable items.

As you are using Quick Edit, you will notice that at the end of each pathway, a Home button and a Back button will appear. If you are finished making changes, press the Home button and then press the Save button to save your configuration. If you would like to make more changes to the same device, press the Back button. This will take you back to the last screen of configurable items for that device. If you would like to continue to make changes, but to a different device, press the Home button and then follow the pathway to the new device. The following pages will explain each configuration pathway.

Begin Using Quick Edit

From the Quick Main Menu Screen, select one of the following buttons and follow the directions on the next page to configure your equipment.

- Pool (or the name given to the body of water)
- Backyard
- Sensors
- Interlocks/Add Interlock
- System Options

If Pool (body of water name) is selected:

Select the Equipment that you would like to configure - The options are as follows: Filter Pumps, Heaters, Cleaners, Water Features, Standalone Lights, Accessories, and Other Options. If the equipment is not already configured, then the buttons will appear as Add Heater, Add Cleaner, etc. When the button is pressed with the word "Add" before it, then you will be taken through the full configuration for that equipment as appears in the Advanced Configuration Guide section of this manual. Otherwise:

If Filter Pumps is selected:

Select the Filter Pump setting that you would like to add/modify - the options are described below.

Name - Create a custom name if desired.

Type - Change the type of Filter Pump that is configured (Single Speed, 2-Speed, or VSP)

HUA - Match the HUA (Hayward Unique Address) to the configured Filter Pump. This option only appears if the Filter Pump is configured as a variable speed pump.



HAYWARD®

Speed - Change the minimum and maximum allowed speeds of the Filter Pump as well as the Low, Medium and High speed settings. This option only appears if the Filter Pump is configured as a variable speed pump.

Relay - Select the relay(s) that is wired to the Filter Pump. This option only appears if the Filter Pump is configured as a single speed or 2-speed pump.

Off for Valve Change - Select whether you want the Filter Pump to shut off while valves are turning.

Flow Monitoring - Select whether you want flow to be monitored.

Priming - Select whether you want the Filter Pump to prime. This option only appears if the Filter Pump is configured as a 2-speed or variable speed pump.

Freeze Protect - Select whether you want the Filter Pump to turn on for freeze protection. Also set the freeze protect air temperature threshold from this menu. Freeze protect operation can be overridden for a 60 minute period. (See Operation manual for more information).

If Heaters is selected:

Add a Heater - Pressing “Add a Heater” from this screen will take you through the full configuration for adding a new heater. These steps are described in the Advanced Configuration Guide section of this manual.

General Heater Options - Pressing this button will take you to a screen with the following general options for heater operation:

Extend - If “Enabled”, the filter extend logic keeps the filter pump running beyond the normal turn-off time until the water is heated up to the desired temperature setting. Heater extend will NOT cause the filter pump to turn on, it will only delay the turn off time when the heater is operating.

Cooldown - This feature ensures that the heater cools down before water circulation is stopped. When enabled, the VS Omni will continue to run the filter pump for 5 minutes after the heater turns off.

Max Temperature - Select the maximum allowed heater setpoint temperature.

Select a Heater - Once you select a heater, all of the options for that heater will appear on the next screen. These options are as follows:

Name - Create a custom name if desired.

Type - Select the type of heater that is configured (Solar, Heat Pump, Gas).



HAYWARD®

Relay - Select the relay that is wired to the heater. This option is only available if the heater is configured as a heat pump or a gas heater.

Min Filter Speed - Select the minimum speed that the Filter Pump will run while the heater is active. This option is only available for 2-speed and VSP pumps.

Min Air Temperature - Select the minimum air temperature that the heater will be allowed to run. This option is only available if the heater is configured as a Heat Pump.

Priority Duration - Select the number of hours that this heater will run before the secondary heater turns on.

Pump - Configure the boost pump for the heater. This option is only available if the heater is configured as a Solar heater.

Valve - Configure the heating valve, if used. This option is only available if the heater is configured as a Solar heater.

Solar Sensor - Configure the solar sensor. This option is only available if the heater is configured as a Solar heater.

Delete a Heater - From this screen, if you wish to delete a heater that is currently configured, select the Delete button can on the right of the name of the heater that you wish to delete.

If Cleaners is selected:

Add Cleaner - Pressing “Add Cleaner” from this screen will take you through the full configuration for adding a new cleaner. These steps are described in the Advanced Configuration Guide section of this manual.

Select a Cleaner - Once you select a cleaner, all of the options for that cleaner will appear on the next screen. These options are as follows:

Name - Create a custom name if desired.

Type - Select the type of cleaner that is configured (Pressure, Suction, Robotic, In Floor).

Pump - Configure the cleaner pump, if used.

Relay - Select the relay that is wired to the cleaner. This option only appears if the cleaner does not have an associated pump configured.

Valve - Configure the cleaner valve, if used.



Freeze Protect - Select whether you want the cleaner to turn on for Freeze Protection. Also set the Freeze Protect air temperature threshold from this menu.

Valve Cycle - Configure the valve cycling time period for the cleaner. This option is only available if the cleaner has an assigned valve.

Speed - Change the minimum and maximum allowed speeds of the cleaner as well as the Low, Medium and High speed settings. This option only appears if the cleaner pump is configured as a variable speed pump.

Priming - Select whether you want the cleaner pump to prime. This option only appears if the cleaner pump is configured as a 2-Speed or VSP.

Delete a Cleaner - From this screen, if you wish to delete a cleaner that is currently configured, select the Delete button on the right of the name of the cleaner that you wish to delete.

If Water Features is selected:

Add Water Feature - Pressing “Add Water Feature” from this screen will take you through the full configuration for adding a new water feature. These steps are described in the Advanced Configuration Guide section of this manual.

Select a Water Feature - Once you select a water feature, all of the options for that water feature will appear on the next screen. These options are as follows:

Name - Create a custom name if desired.

Type - Change the type of water feature that is configured (Waterfall, Waterslide, etc.).

Pump - Configure the water feature pump, if used.

Relay - Select the relay that is wired to the water feature. This option appears only if the water feature does not have an associated pump configured.

Valve - Configure the water feature valve, if used.

Speed - Change the minimum and maximum allowed speeds of the water feature pump as well as the Low, Medium and High speed settings. This option only appears if the water feature pump is configured as a VSP.

Priming - Select whether you want the water feature pump to prime. This option is only available if the water feature pump is configured as a 2-Speed or VSP.

Freeze Protect - Select whether you want the water feature to turn on for Freeze Protection. Also set the Freeze Protect air temperature threshold from this menu.



Delete a Water Feature - From this screen, if you wish to delete a water feature that is currently configured, select the Delete button on the right of the name of the water feature that you wish to delete.

If Standalone Lights is selected:

Add Standalone Light - Pressing "Add Standalone Light" from this screen will take you through the full configuration for adding new ColorLogic Standalone lights (UCL, CL 4.0 or CL 2.5). These steps are described in the Advanced Configuration Guide section of this manual.

Select Group of Lights - Once you select a group of ColorLogic Standalone Lights, all of the options for those lights will appear on the next screen. These options are as follows:

Name - Create a custom name if desired.

Type - Select the type of lights configured (UCL, CL4.0 or CL 2.5).

Relay - Select the relay(s) that is wired to the group of lights.

Set Mode - Set the mode of the lights configured (UCL, CL4.0 or CL 2.5).

Delete Group of Lights - From this screen, if you wish to delete a group of lights that is currently configured, select the Delete button on the right of the name of the lights group that you wish to delete.

If Accessories is selected:

Add Accessory - Pressing "Add Accessory" from this screen will take you through the full configuration for adding a new accessory. These steps are described in the Advanced Configuration Guide section of this manual.

Select an Accessory - Once you select an accessory, all of the options for that accessory will appear on the next screen. These options are as follows:

Name - Create a custom name if desired.

Type - Select the type of accessory configured (Laminar, Dimmer, etc.).

Pump - Configure the accessory pump, if used.

Valve - Configure the accessory valve, if used.

Speed - Change the minimum and maximum allowed speeds of the accessory pump as well as the Low, Medium and High speed settings. This option only appears if the accessory pump is configured as a VSP.



HAYWARD®

Priming - Select whether you want the accessory pump to prime. This option is only available if the accessory pump is configured as a 2-Speed or VSP.

Freeze Protect - Select whether you want the accessory to turn on for Freeze Protection. Also set the Freeze Protect air temperature threshold from this menu.

Relay - Select the relay that is wired to the accessory. This option only appears if the accessory does not have an associated pump configured.

Delete an Accessory - From this screen, if you wish to delete an accessory that is currently configured, select the Delete button on the right of the name of the accessory that you wish to delete.

If Other Options is selected:

Name - Create a custom name if desired.

If Backyard is selected:

Add Standalone Light - Pressing "Add Standalone Light" from this screen will take you through the full configuration for adding new ColorLogic Standalone Lights (UCL, CL 4.0 or CL 2.5). These steps are described in the Advanced Configuration Guide section of this manual.

Select Group of Lights - Once you select a group of ColorLogic Standalone Lights, all of the options for those lights will appear on the next screen. These options are as follows:

Name - Create a custom name if desired.

Type - Select the type of lights configured (UCL, CL 4.0 or CL 2.5).

Relay - Select the relay(s) that is wired to the group of lights.

Set Mode - Set the mode of the lights configured (UCL, CL 4.0 or CL 2.5).

Delete Group of Lights - From this screen, if you wish to delete a group of lights that is currently configured, select the Delete button on the right of the name of the lights group that you wish to delete.

If Accessories is selected:

Add Accessory - Pressing "Add Accessory" from this screen will take you through the full configuration for adding a new accessory to the Backyard. These steps are described in the Advanced Configuration Guide section of this manual.

Select an Accessory - Once you select an accessory, all of the options for that Backyard accessory will appear on the next screen. These options are as follows:

Name - Create a custom name if desired.



HAYWARD®

Relay - Select the relay that the accessory is wired to.

Delete an Accessory - From this screen, if you wish to delete an accessory that is currently configured, select the Delete button on the right of the name of the accessory that you wish to delete.

NOTE: The system does not allow you to configure a pump or a valve to accessory equipment in the Backyard.

If Sensors is selected:

Add Sensor - Pressing “Add Sensor” from this screen will take you through the full configuration for adding a new sensor. These steps are described in the Advanced Configuration Guide section of this manual.

Select a Sensor - Once you select a sensor, all of the options for that sensor will appear on the next screen. These options are as follows:

Name - Create a custom name if desired.

Location - Select the location that the sensor is wired to.

Delete a sensor - From this screen, if you wish to delete a sensor that is currently configured, select the Delete button on the right of the name of the sensor that you wish to delete.

If Interlocks is selected:

Add Interlock - Pressing “Add Interlock” from this screen will take you through the full configuration for adding a new interlock. These steps are described in the Configuration Guide portion of this manual.

Select an Interlock - Selecting an interlock from this screen will allow you to view that interlock’s configuration. However, you cannot edit a pre-existing interlock. In order to change an interlock’s configuration, you have to delete the obsolete interlock and create a new one.

Delete an Interlock - From this screen, if you wish to delete an interlock that is currently configured, select the Delete button on the right of the name of the interlock that you wish to delete.

NOTE: If there are currently no interlocks configured on your system, then the button will appear as “Add Interlock” instead of “Interlocks”. In this case, pressing “Add Interlock” will take you through the full configuration for adding a new interlock. These steps are described in the Advanced Configuration Guide section of this manual. Once an interlock has been created, the button will say “Interlocks”.





HAYWARD®





HAYWARD®

Control Pad Mounting Template

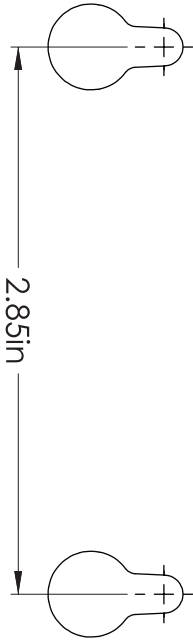

For further information or consumer
technical support, visit our website at
www.hayward.com



Hayward is a registered trademark and Hub is
a trademark of Hayward Industries, Inc. © 2017 Hayward Industries, Inc.

All other trademarks not owned by Hayward are the property of their respective owners.
Hayward is not in any way affiliated with or endorsed by those third parties.

USE ONLY HAYWARD GENUINE REPLACEMENT PARTS