



SCALA2



<http://qr.grundfos.com/i/scala2install>

be
think
innovate

GRUNDFOS 



PN10:
Max. 10 bar/1.0 MPa



- Voltage
- Ambient temperatur



Min./Max.
0 °C - + 45 °C/
32 °F - + 113 °F

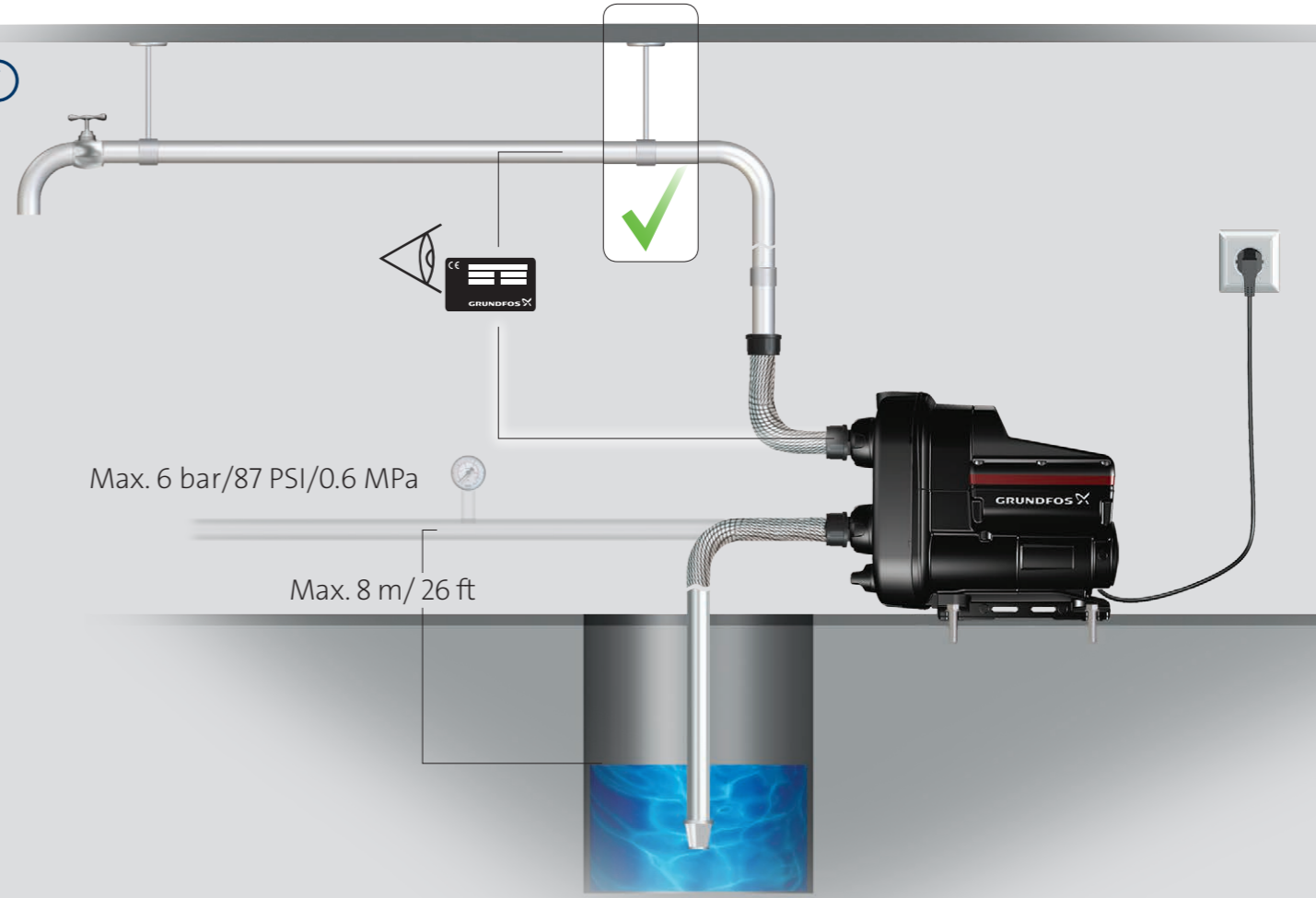
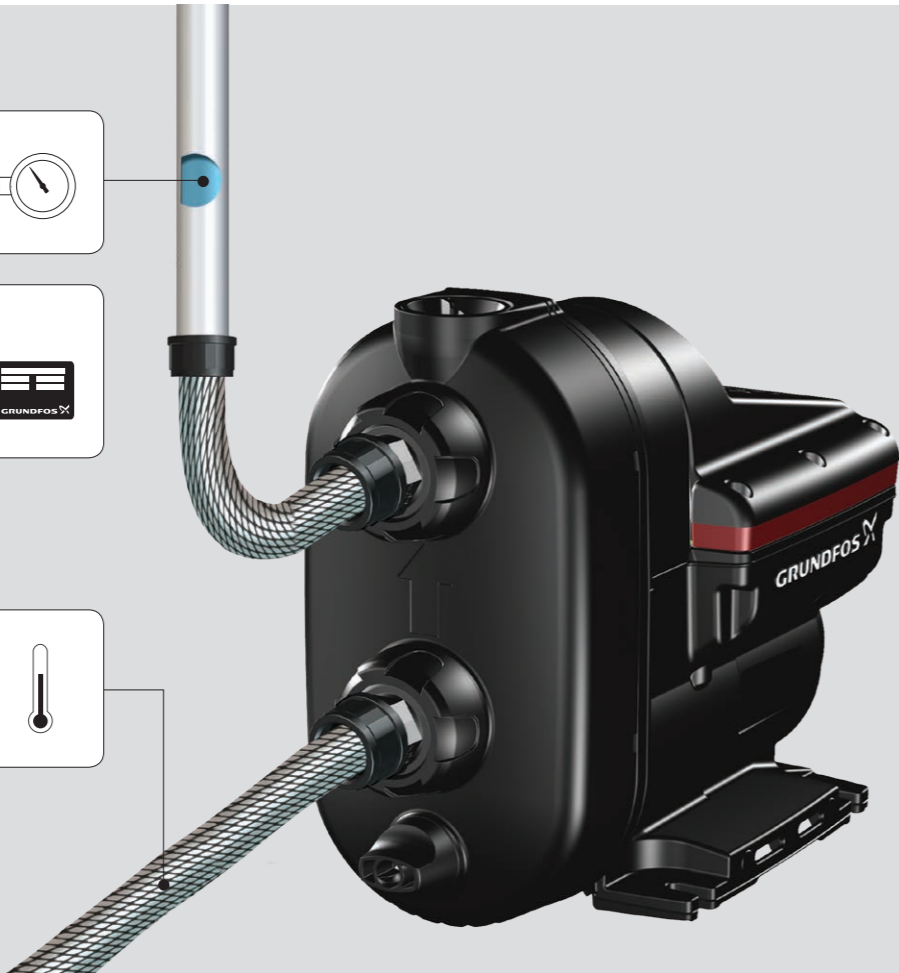

Max. 6 bar/87 PSI/0.6 MPa

Max. 8 m/ 26 ft

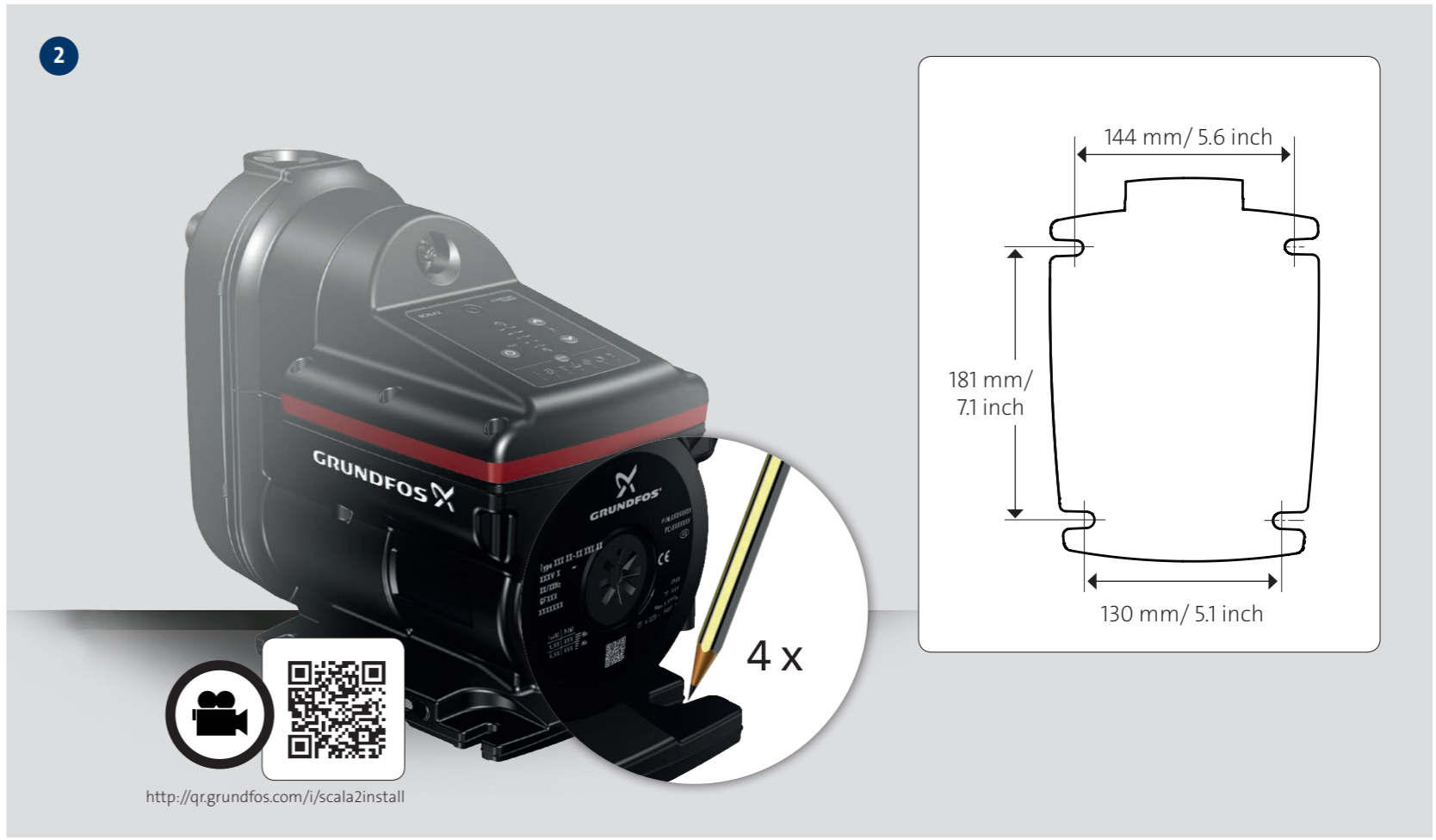
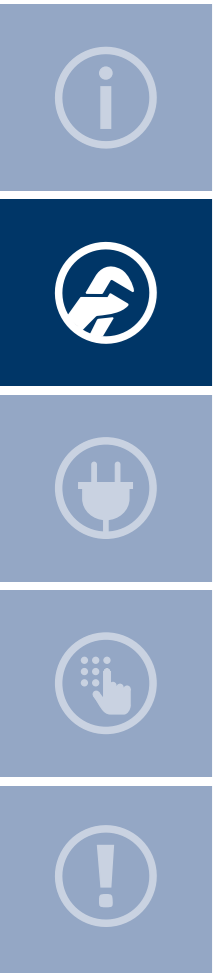

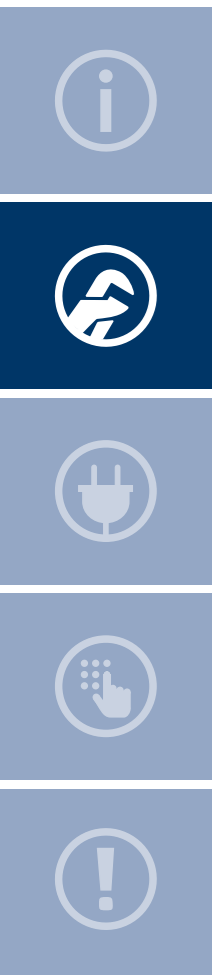

3

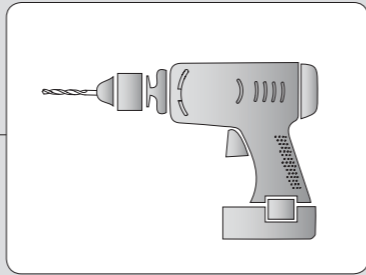

4 x

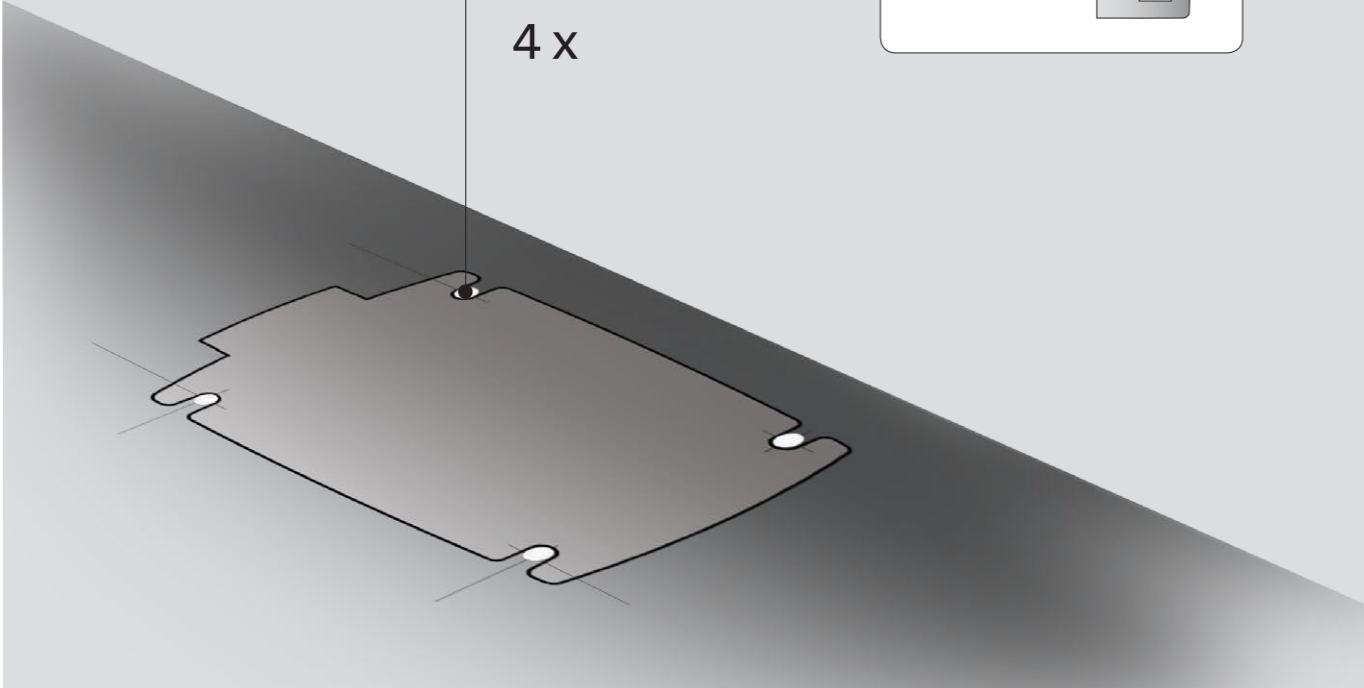

4

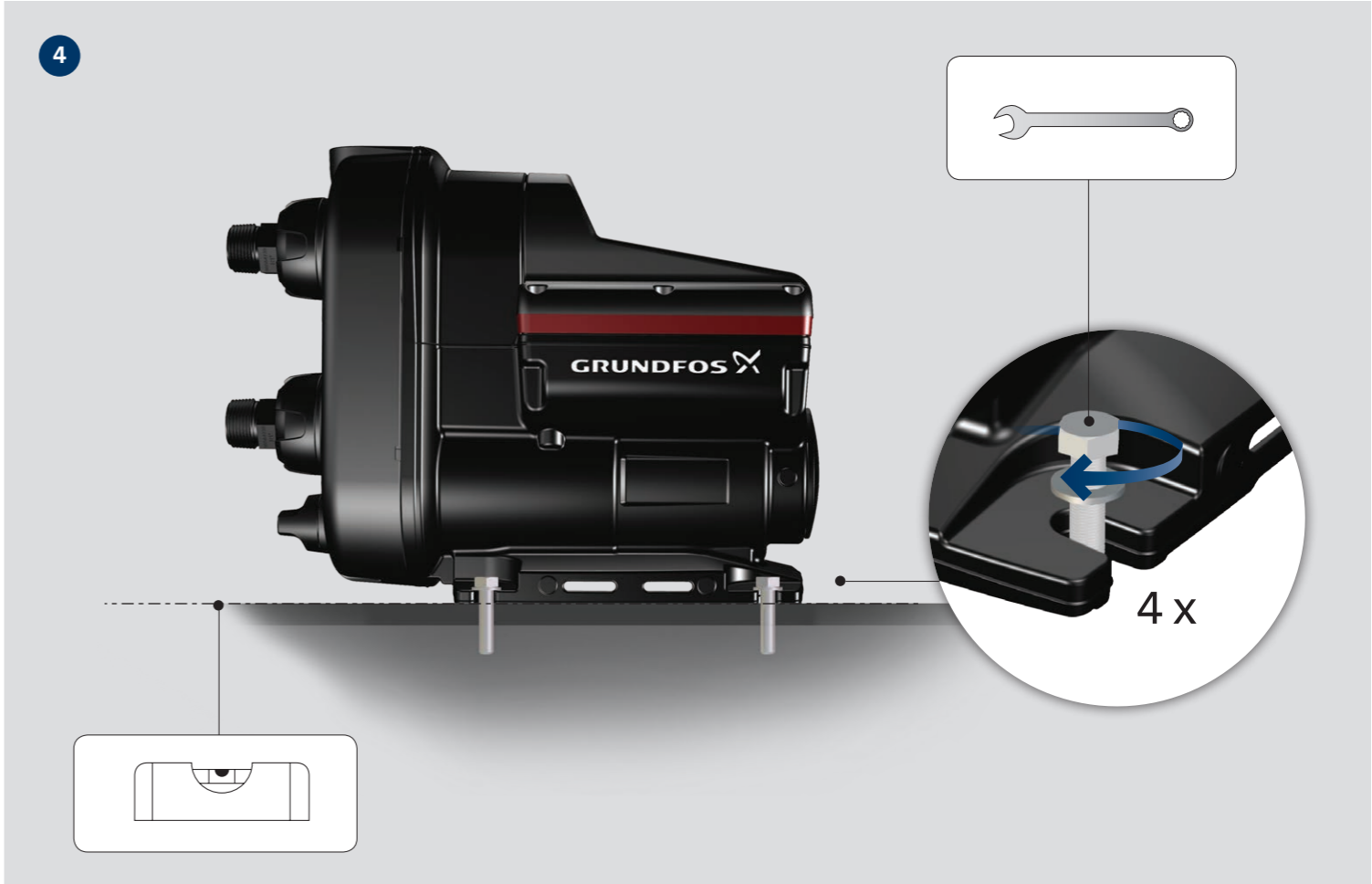
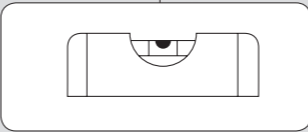
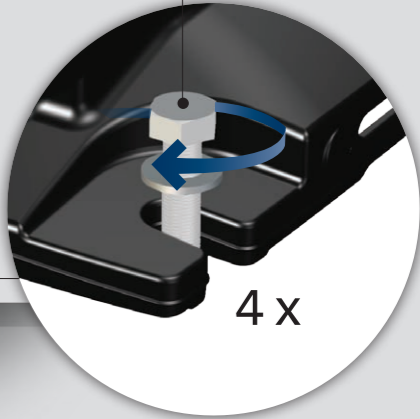
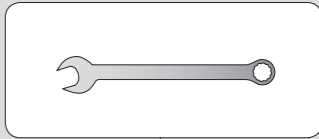

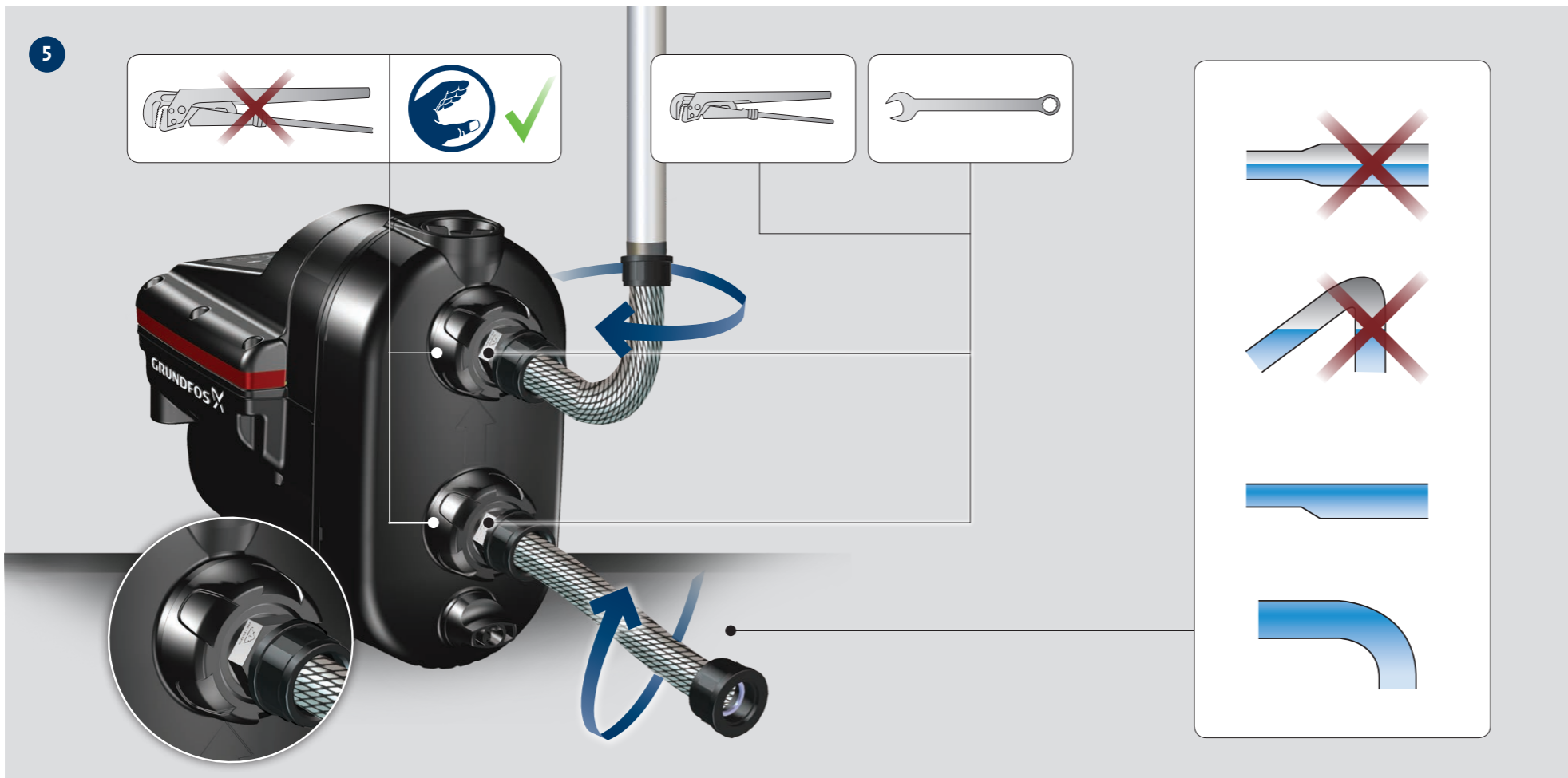
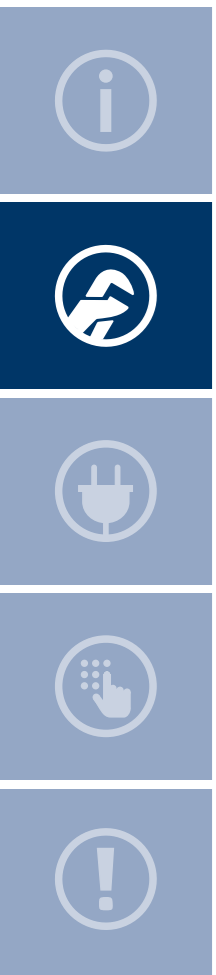

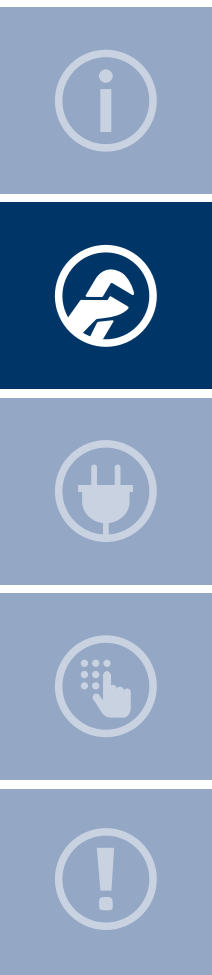

6

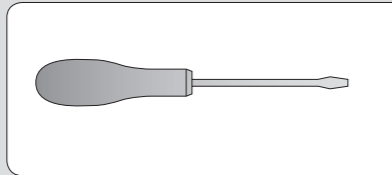

<http://qr.grundfos.com/i/scala2install>

7



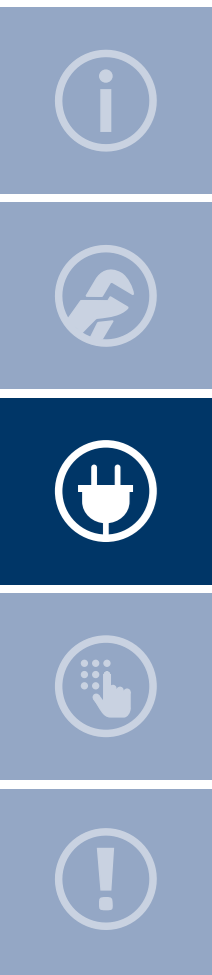

8

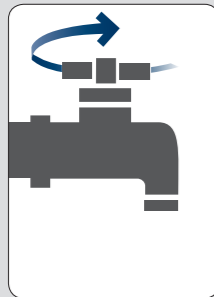

9

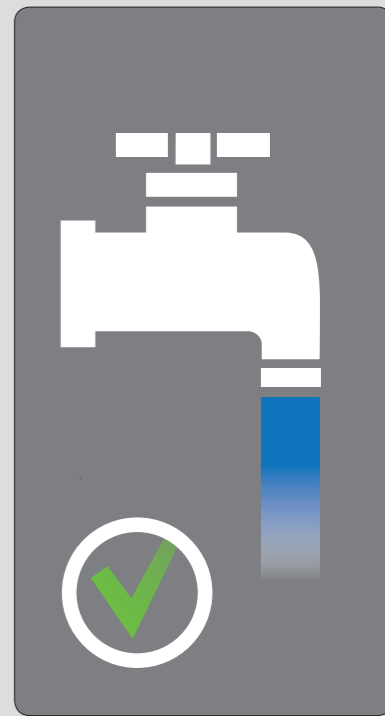

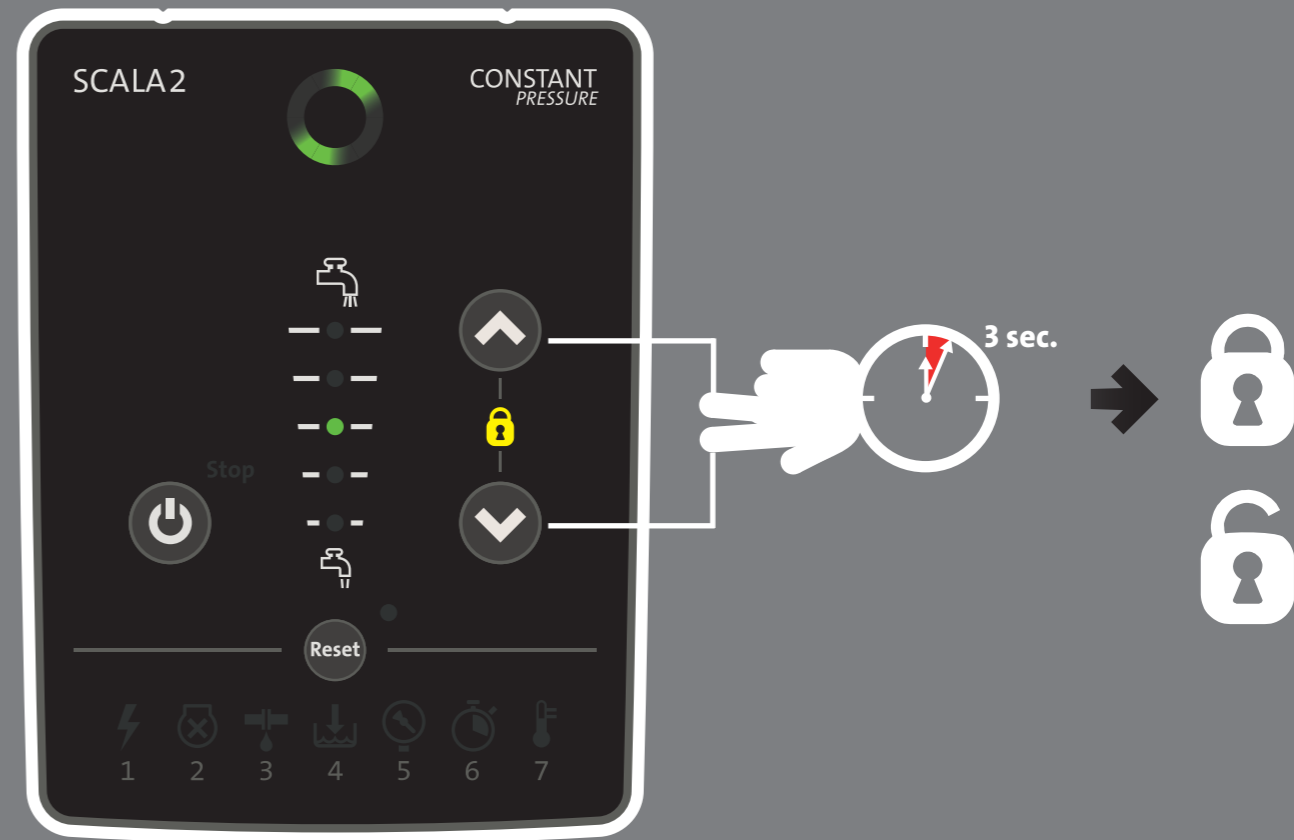
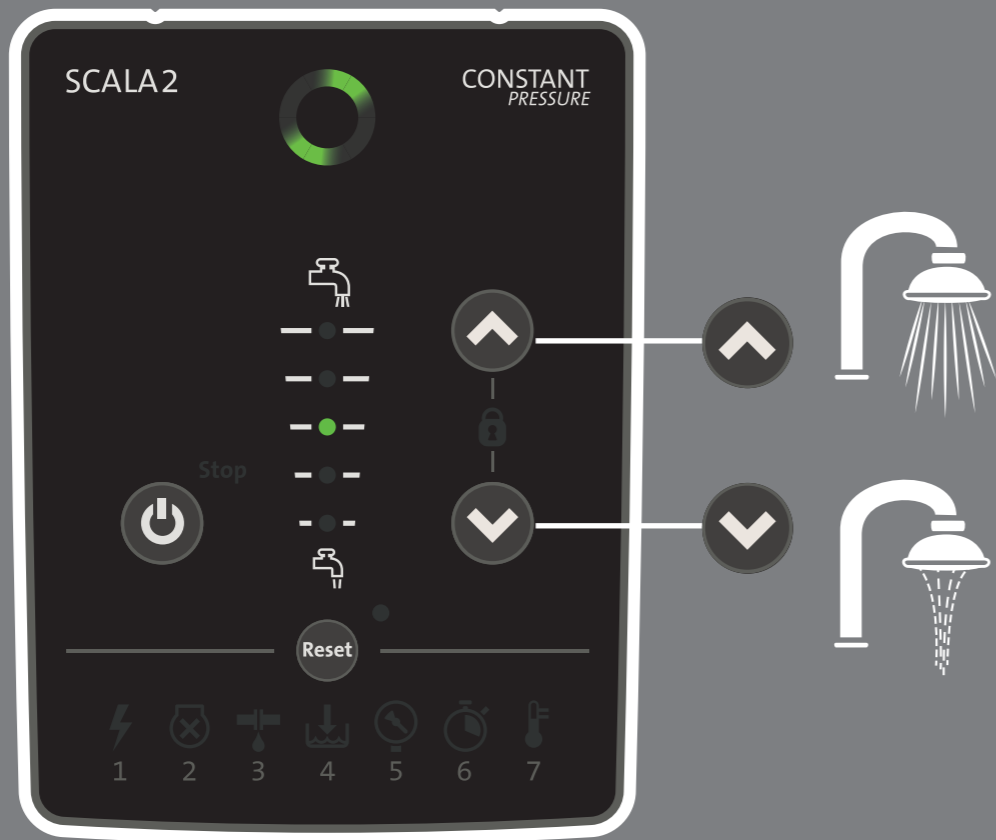
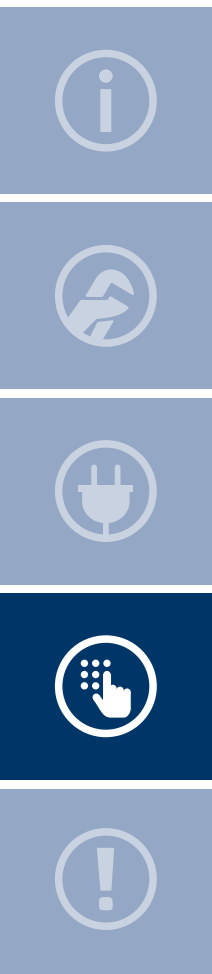

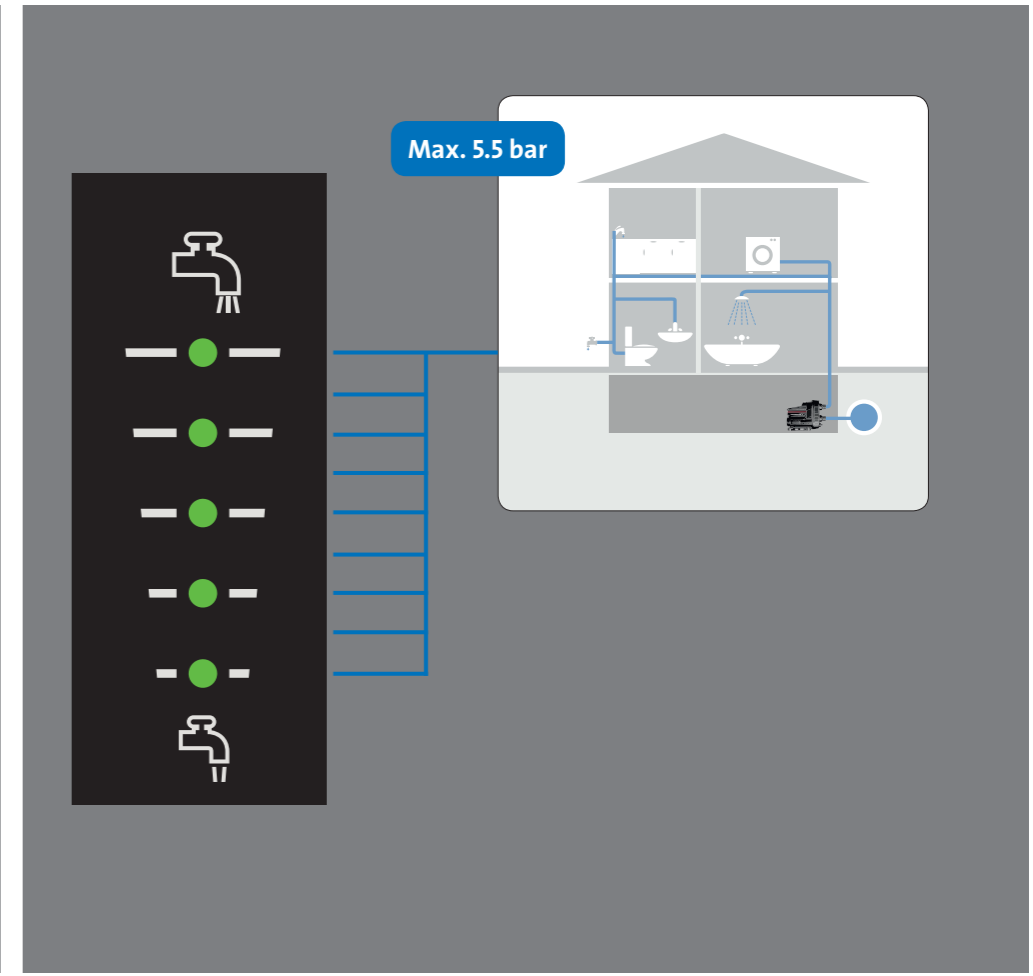
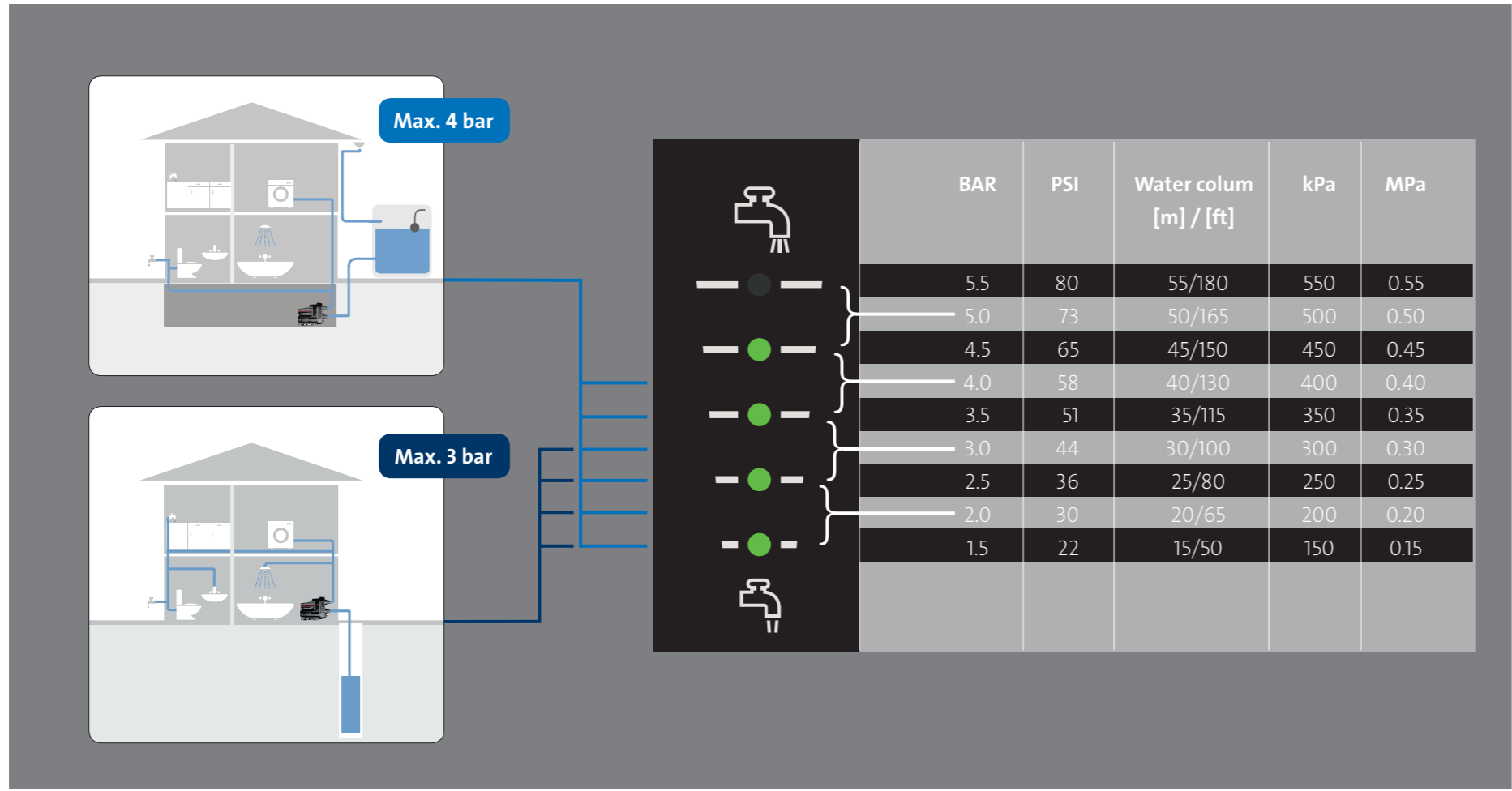
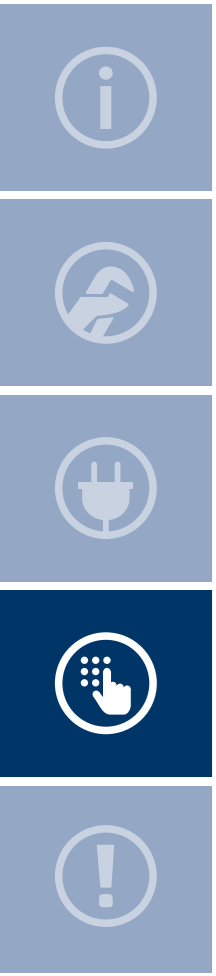

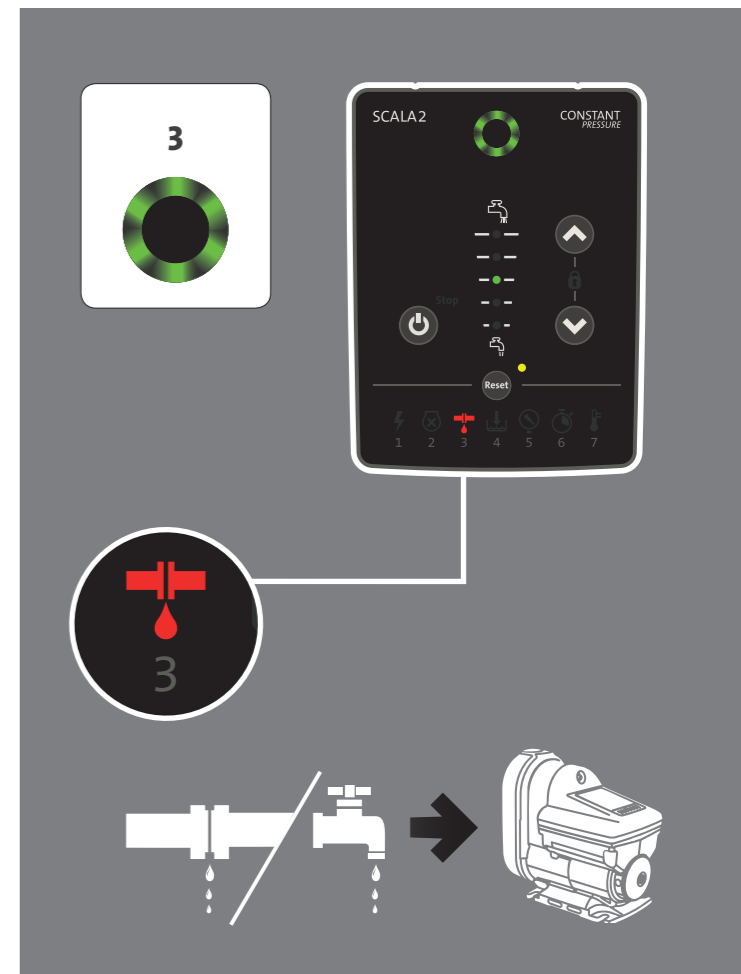
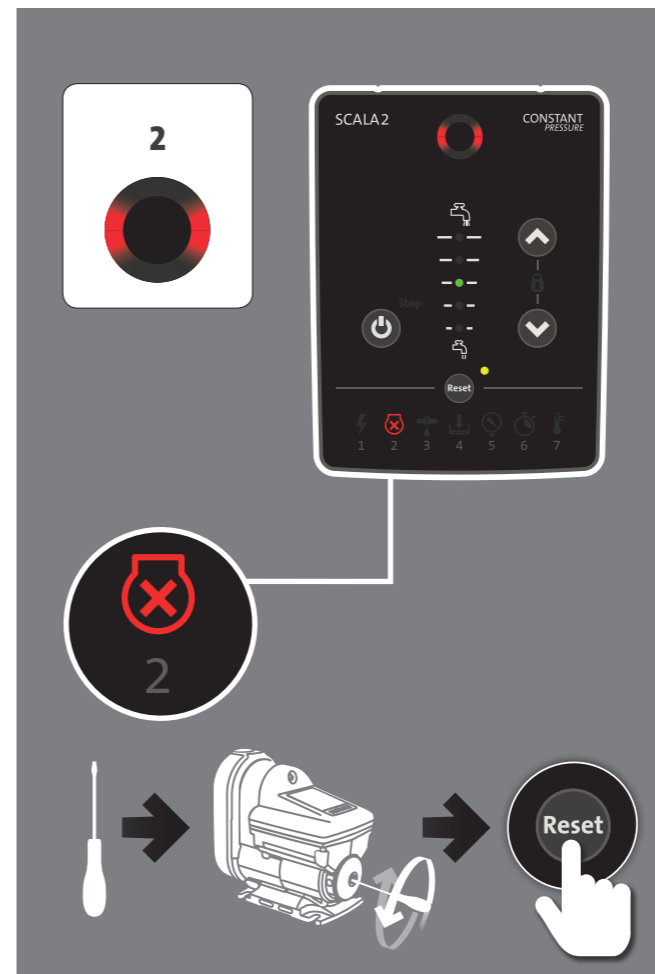
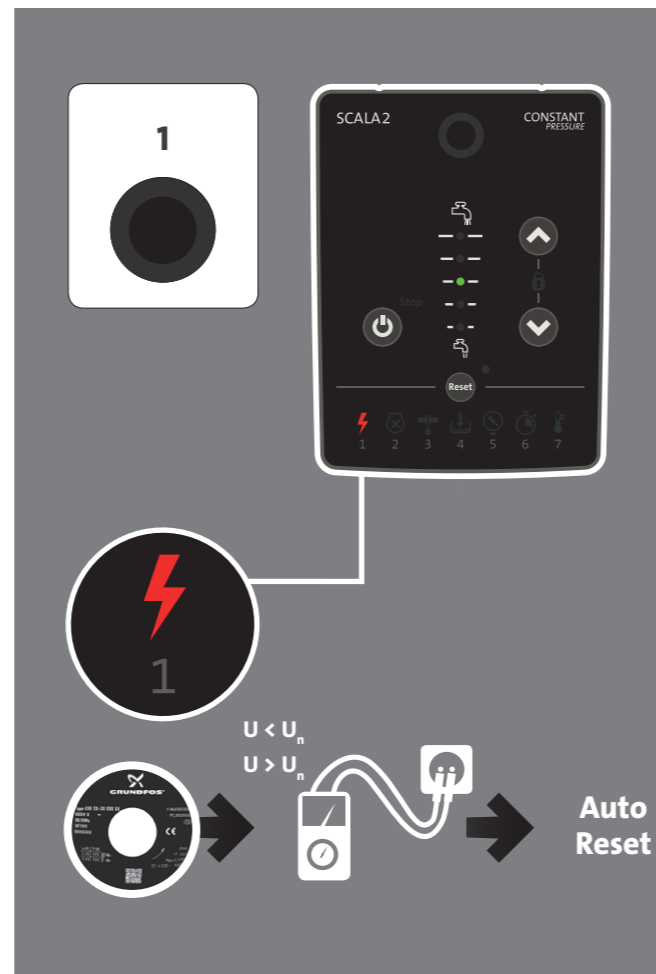
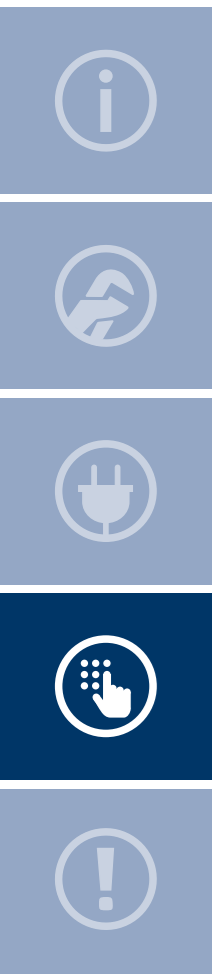

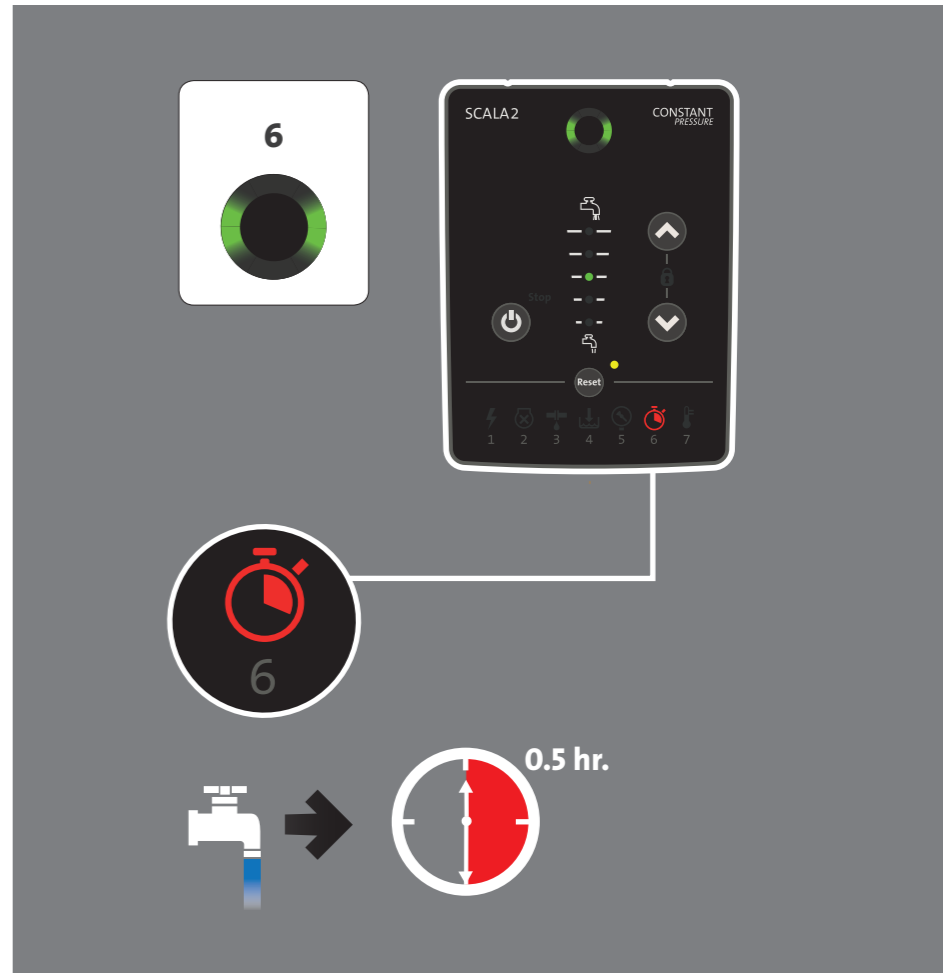
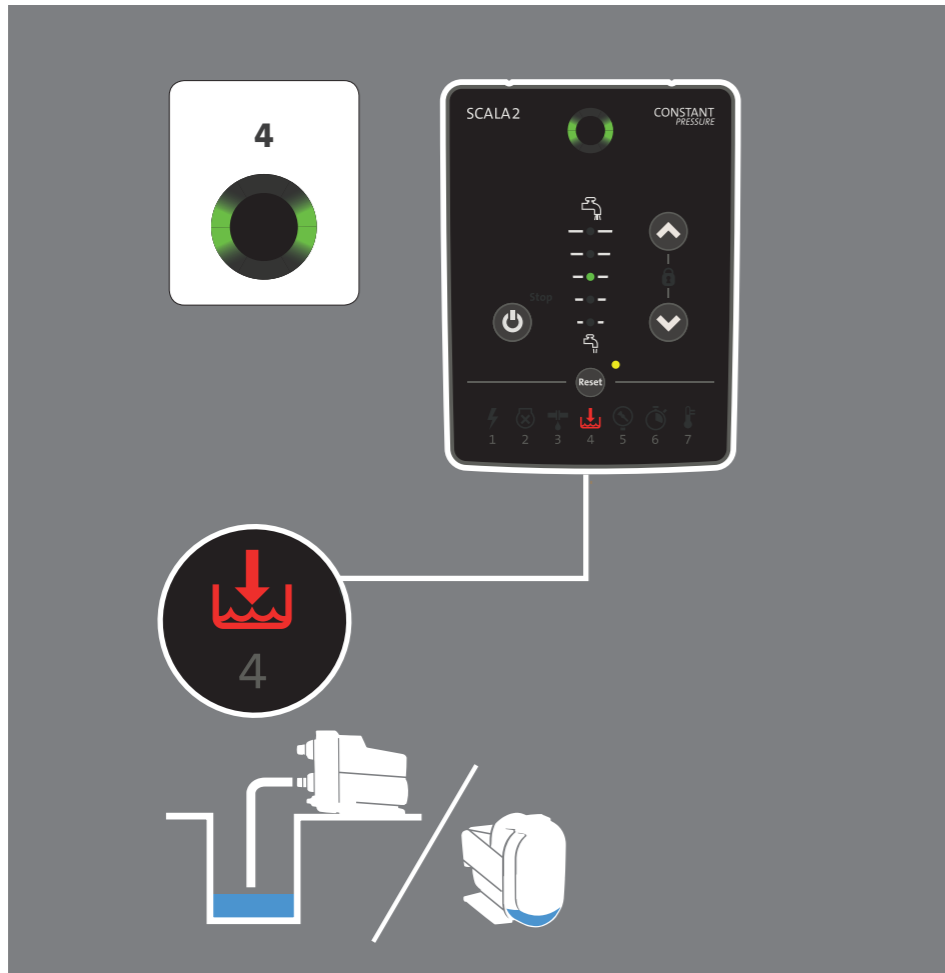
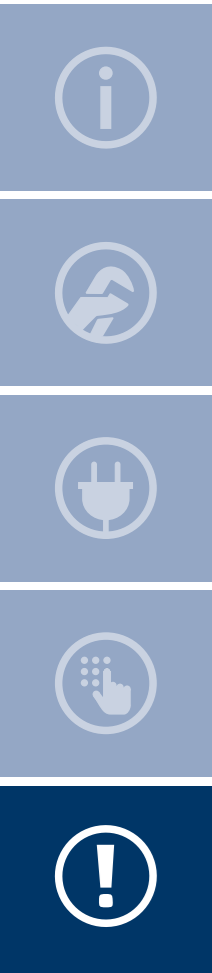

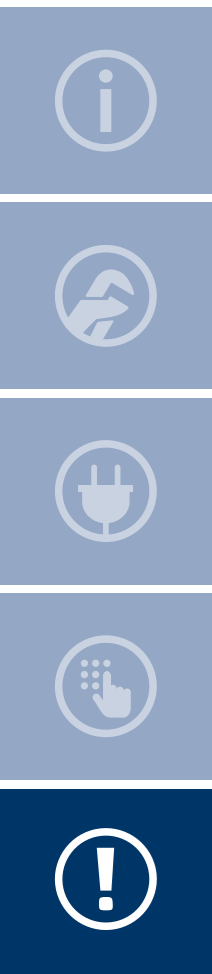

7

7

22

1 2 3 4 5 6 7

net.grundfos.com/qr/i/98880508

23

be think innovate

98501666 0517

ECM: 1203706

GRUNDFOS Holding A/S
Poul Due Jensens Vej 7
DK-8850 Bjerringbro
Tel: +45 87 50 14 00
www.grundfos.com

GRUNDFOS 

The name Grundfos, the Grundfos logo, and be think innovate are registered trademarks owned by Grundfos Holding A/S or Grundfos A/S, Denmark. All rights reserved worldwide.