



# INSTALLATION MANUAL

## Notice for safety installation

- Please ask professional sales shop to install this unit.  
Do not attempt to install this unit by yourself to avoid the accidents such as electric shock, fire and leakage of water.
- Before install this unit, please read this notice for safety installation carefully and install properly and safely.
- Be sure to follow the safety articles mention important details on safety.

 <b>WARNING</b>	Improper use may cause the risk of death or serious injury of the user.
 <b>CAUTION</b>	Improper use may cause injury of the user or damages to the property.

- Meaning of the mark.

	Prohibited		Strict enforcement		Connect the earthing cable
---	------------	---	--------------------	---	----------------------------

- After finishing the installation, please check no defective points in the testing operation. Then, kindly explain to the user about the directions and maintenance according to the operation manual.
- For product modification, the product and its specification may show slight differences from the description of this manual.

### **WARNING**

- For the air to water heat pump to operate satisfactorily, install it as outlined in this installation manual.
- Connect the unit with the air to water heat pump piping and cords available standards parts. This installation manual describes the correct connections using the installation set available from our standard parts.
- Installation work must be performed in accordance with national wiring standards by authorized personnel only.
- Also, do not use an extension cord.
- Do not turn on the power until all installation work is complete.
- Use designated parts or accessories to avoid accidents such as electric shock, fire and leakage of water.

- |  |   |
|--|---|
| <ul style="list-style-type: none"> <li>• If leakage of refrigerant occurs in the installation, ventilate a room immediately.</li> <li>• If the leaked refrigerant is exposed to fire, poisonous gas may be generated.</li> </ul> |  |
|--|---|

- Be sure to install the unit in steady place to hold the heavy weight. Lack of stability or imperfect installation may cause injury due to the fall of the unit.
- At the time of installation of the unit or relocation, use only the designated refrigerant (R-410A) into refrigerant circulating system (Refrigeration circuit).  
Other gas such as air come in the refrigeration circuit may cause an explosion and injury.
- Follow the local standards in electric works. Be sure to use an exclusive power source.  
Any shortage of electric circuit's capacity or imperfect works may cause an electric shock and a fire.

### **WARNING**

- Never touch electrical components immediately after the power supply has been turned off. Electrical shock may occur. After turning off the power, always wait 5 minutes or more before touching electrical components.
- Be sure to fix the power supply cord in connecting points of the terminal block correctly, Imperfection of the connecting may cause overheating and a fire.
- Be sure to install the wiring lid in a straight line. Imperfect wiring works may cause overheating, a fire or electric shock at the connecting point in the terminal block.

### **CAUTION**

- Put the unit to earthing works.  
Never conduct the earthing cable to gas tube, water supply pipes, lightning rod and earthing cable of telephone. Imperfect earthing may cause electric shock.
- Install a circuit breaker. Lack of circuit breaker may cause electric shock.
- Do not install to a place where there is any possibility of inflammable gas leakage such from LP gas cylinder around the unit. A leaked inflammable gas filled around the unit may cause a fire.
- Be sure to take a drainage works according to this manual.
- Do not open the water supply tank cap during operation or immediately after stopping. If you do, the circulating water can jump out and cause burns.

#### **Directive 2002/96/EC (WEEE): Information for users**

This product complies with EU Directive 2002/96/EC.

The barred bin symbol on the appliance indicates that the product, requiring separate treatment to household waste after its normal working life, must be taken to a waste-sorting centre for electrical and electronic appliances or returned to the retailer at the time of purchasing a new equivalent appliance.

The user is responsible for taking the appliance to the appropriate waste collection centre at the end of its working life.

 Correct waste sorting, with the discarded appliance being sent for recycling, treatment and compatible environmental disposal helps prevent any negative effects on the environment and health, and encourages the recycling of product materials.

 For further detailed information regarding available collection systems, please contact your local waste disposal service or the shop where you made your purchase.

## Power supply

- Before inserting the power supply cable to the outlet, be sure to check a proper voltage.
- Be sure to use an exclusive power source with a circuit breaker.
- Install the outlet within the length of power supply cord.
- Do not use power supply cord extended or connected halfway.

## Floor fixing dimension of the unit

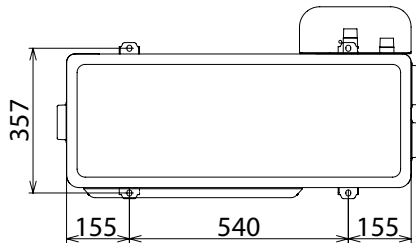

## Drawing for the installation of the unit

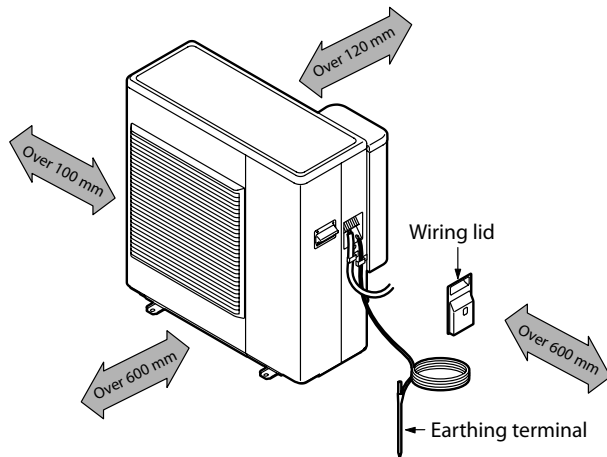

- Anchor the unit to the concrete or the block with bolts (ø10 mm) and nuts firmly and horizontally.
- In case the vibration may affect the house, use an anti-vibration gum and fix the Unit.

## Selecting the mounting position

### ⚠ WARNING

Select installation locations that can properly support the weight of the units. Install the units securely so that they do not topple or fall.

### ⚠ CAUTION

- Do not install where there is the danger of combustible gas leakage.
- If children may approach the unit, take preventive measures so that they cannot reach the unit.

### ⚠ WARNING

When installing the outdoor unit where it may be exposed to strong wind, fasten it securely.

Decide the mounting position with the customer as follows:

- (1) Install the unit in a location which can withstand the weight of the unit and vibration, and which can install horizontally.
- (2) Provide the indicated space to ensure good airflow.
- (3) If possible, do not install the unit where it will be exposed to direct sunlight.  
(If necessary, install a blind that does not interfere with the airflow.)
- (4) Do not install the unit near a source of heat, steam, or flammable gas.
- (5) During heating operation, drain water flows from the outdoor unit. Therefore, install the outdoor unit in a place where the drain water flow will not be obstructed. (Reverse cycle model only)
- (6) Do not install the unit where strong wind blows or where it is very dusty.
- (7) Do not install the unit where people pass.
- (8) Install the unit in a place where it will be free from being dirty or getting wet by rain as much as possible.

## Installation procedure

### ⚠ WARNING

- Install the unit where it will not be tilted by more than 5°.
- When installing the unit where it may be exposed to strong wind, fasten it securely.

### ⚠ CAUTION

- When the outdoor temperature is 0 °C or less, do not use drain pipe and drain cap. If the drain pipe and drain cap are used, the drain water in the pipe may freeze in extremely cold weather.
- In the area with heavy snowfall, if the intake and outlet of unit is blocked with snow, it might become difficult to get warm and it is likely to cause of the breakdown. Please construct a canopy and a pedestal or place the unit on a high stand (local configured).

## Accessories

- Specification sheet
- Installation manual

# 1 Wiring

## ⚠ WARNING

- The rated voltage of this product is 230 V a.c. 50 Hz.
- Before turning on, verify that the voltage is within the 198 V to 264 V range.
- Always use a special branch circuit and install a special receptacle to supply power to the air to water heat pump.
- Use a special branch circuit breaker and receptacle matched to the capacity of the air to water heat pump. (Install in accordance with standard.)
- Perform wiring work in accordance with standards so that the air to water heat pump can be operated safely and positively.
- Install a leakage special branch circuit breaker in accordance with the related laws and regulations and electric company standards.
- The circuit breaker is installed in the permanent wiring. Always use a circuit that can trip all the poles of the wiring and has an isolation distance of at least 3 mm between the contacts of each pole.

## ⚠ CAUTION

- The power source capacity must be the sum of the air to water heat pump current and the current of other electrical appliances. When the current contracted capacity is insufficient, change the contracted capacity.
- When the voltage is low and the air to water heat pump is difficult to start, contact the power company the voltage raised.

Be sure to use an exclusive power source with a circuit breaker.  
Respecting the following designation, use cables whose wires size are more than the designated one in the table below.  
Power cord shall be approved according to IEC standard.

Power supply cord(mm <sup>2</sup> )		Connection cord(mm <sup>2</sup> )		Breaker capacity(A)
MAX.	MIN.	MAX.	MIN.	
4.0	3.5	2.5	1.5	20

Peel ends of connecting cables in accordance with dimension in the drawing on the right.

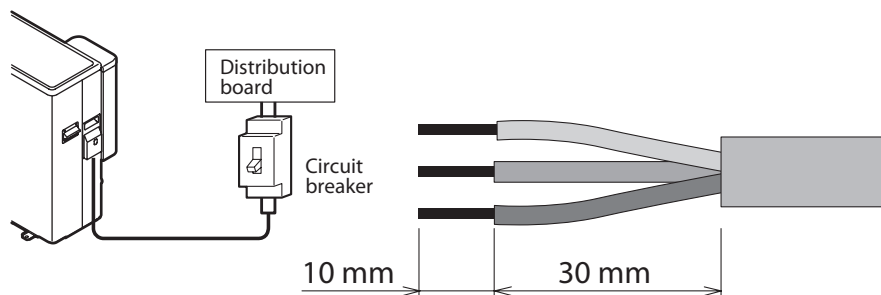

- Use a circuit breaker with a 3 mm clearance of air gap between the contacts.

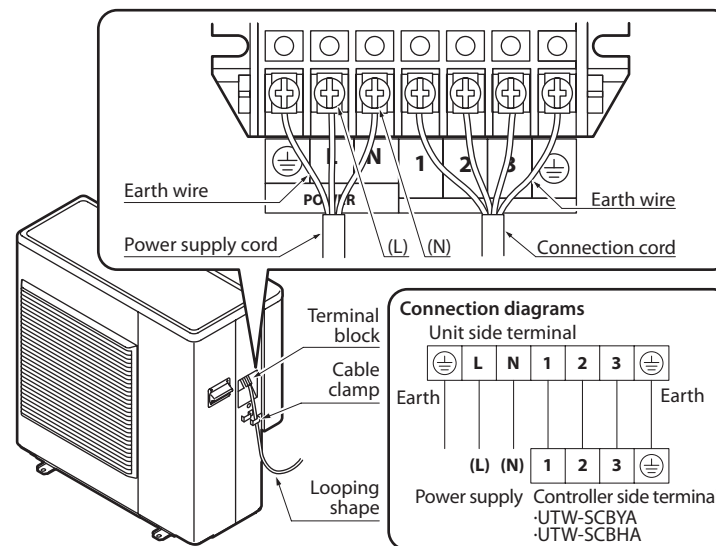

- Be sure to insert the cable cores into the proper position of the terminal block completely.
- Faulty wiring may cause not only abnormal operation but also damages to pc board.
- Fasten each screw sufficiently.
- For the checking of the complete insertion, pull the cable slightly.

## ⚠ CAUTION

Peeling of the connecting cable's covering must be 10 mm. If shorter, a defective contacting may occur. If longer, a short circuit may occur.

## ⚠ WARNING

- Before starting work, check that power is not being supplied to the controller and outdoor unit.
- Match the terminal board numbers and connection cord colors with those of the outdoor unit. Erroneous wiring may cause burning of the electric parts.
- Connect the connection cords firmly to the terminal board. Imperfect installation may cause a fire.
- Always fasten the outside covering of the connection cord with the cord clamp. (If the insulator is chafed, electric leakage may occur.)
- Always connect the ground wire.

## ⚠ CAUTION

- Match the terminal block numbers and connection cord colors with those of the controller. Erroneous wiring may cause burning of the electric parts.
- Connect the connection cords firmly to the terminal block. Imperfect installation may cause a fire.
- Always fasten the outside covering of the connection cord with the cord clamp. (If the insulator is chafed, electric leakage may occur.)
- Securely earth the power cord plug.

Tightening torque	
M4 screw	1.2 to 1.8 N·m (12 to 18 kgf·cm)
M5 screw	2.0 to 3.0 N·m (20 to 30 kgf·cm)

## ⚠ WARNING

Use crimp-type terminals and tighten the terminal screws to the specified torques, otherwise, abnormal overheating may be produced and possibly cause heavy damage inside the unit.

## ⚠ CAUTION

When connecting the power supply cord, make sure that the phase of the power supply matches with the phase of the terminal board. If the phases do not match, the compressor will rotate in reverse and will not be able to compress.

## 1 Wiring

### ⚠ WARNING

- A main switch or other means for disconnection, having a contact separation in all poles, must be incorporated in the fixed wiring in accordance with relevant local and national legislation.
- Switch off the power supply before making any connections.
- All field wiring and components must be installed by a licensed electrician and must comply with relevant European and national regulations.
- The field wiring must be carried out in accordance with the wiring diagram supplied with the unit and the instructions given below.
- Be sure to use a dedicated power supply. Never use a power supply shared by another appliance.
- Be sure to establish an earth. Do not earth the unit to a utility pipe, surge absorber, or telephone earth. Incomplete earth may cause electrical shock.
- Be sure to install an earth leakage protector (30 mA). Failure to do so may cause electrical shock.

### ⚠ CAUTION

- Service current capacity must be  $\geq 100\text{A}$  per phase.
  - a) In practice the service current capacity is the rating of main service fuse or over current protection setting of circuit breaker at the interface point where point between a public supply network and user's installation.
  - b) Service current capacity  $\geq 100\text{A}$  is equivalent to system impedance  $Z_{sys} 0.25\text{ohm} + j0.25\text{ohm}$  or less for single phase.

## 2 Floor heater panel installation example

- The installation method depends on the number of circuits and the installation parts. Install using the installation example below for reference. Install the floor heater panel according to the user's manual that comes with the equipment and parts.

For one circuit only

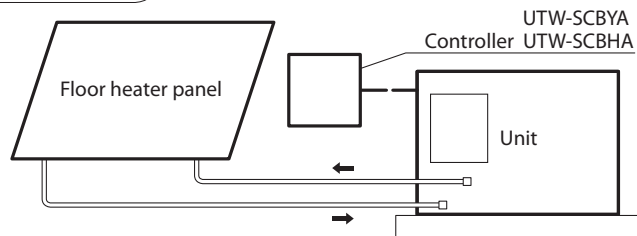

## 3 Water pipework

### Checking the water circuit

The units are equipped with a water inlet and water outlet for connection to a water circuit. This circuit must be provided by a licensed technician and must comply with all relevant European and national regulations.

## 3 Water pipework

### ⚠ CAUTION

The unit is only to be used in a closed system. Application in an open water circuit can lead to excessive corrosion of the water piping.

Before continuing the installation of the unit, check the following points:

- The maximum water pressure is 3 bar.
- Make sure to provide a proper drain for the pressure relief valve to avoid any water coming into contact with electrical parts.
- Air vents must be provided at all high points of the system. The vents should be located at points which are easily accessible for servicing. An automatic air purge is provided inside the unit. Check that this air purge valves is not tightened too much so that automatic release of air in the water circuit remains possible.
- Take care that the components installed in the field piping can withstand the water pressure.

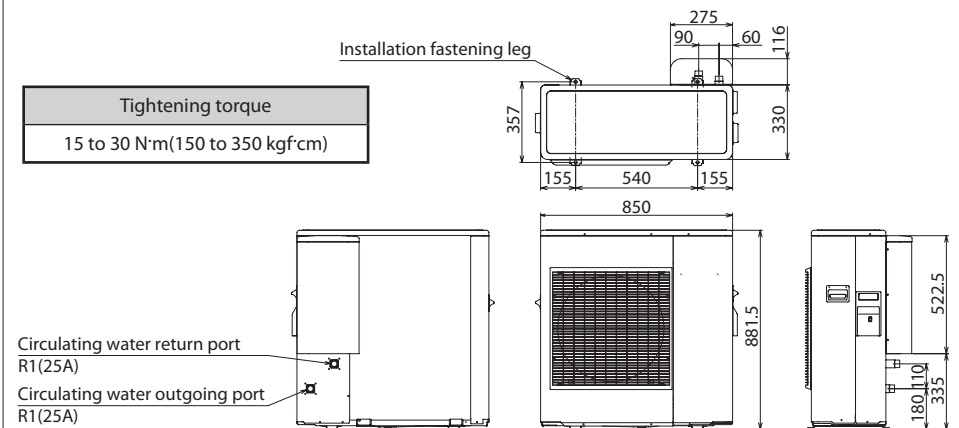

### Main components

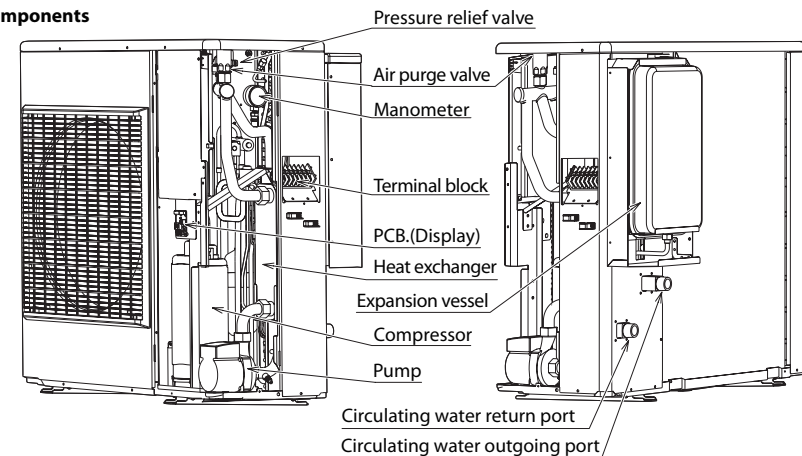

## 4 Connecting the water circuit

Water connections must be made in accordance with the outlook diagram delivered with the unit, respecting the water in-and outlet.

### ⚠ CAUTION

Be careful not to deform the unit piping by using excessive force when connecting. Deformation of the piping can cause the unit to malfunction.

- If air, moisture or dust gets in the water circuit, problems may occur. Therefore, always take into account the following when connecting the water circuit:
- Use clean pipes only.
- Hold the pipe end downwards when removing burrs.
- Cover the pipe end when inserting it through a wall so that no dust and dirt enter.
- Use a good thread sealant for the sealing of the connections. The sealing must be able to withstand the pressures and temperatures of the system.
- When using non-brass metallic piping, make sure to insulate both materials from each other to prevent galvanic corrosion.
- Because brass is a soft material, use appropriate tooling for connecting the water circuit. Inappropriate tooling will cause damage to the pipes.

### ⚠ CAUTION

- The unit is the only to be used in a closed water system. Application in an open water circuit can lead to excessive corrosion of the water piping.
- Never use Zn-coated parts in the water circuit. Excessive corrosion of these parts may occur as copper piping is used in unit's internal water circuit.

### NOTICE

- When using a 3-way valve in the water circuit. Preferably choose a ball type 3-way valve to guarantee full separation between domestic hot water and floor heating water circuit.
- When using a 3-way valve or a 2-way valve in the water circuit. The recommended maximum changeover time of the valve should be less than 60 seconds.

## 5 Charging water

- 1 Connect the water supply to a drain and fill valve.
- 2 Fill with water until the manometer indicates a pressure of approximately 2.0 bar. Remove air in the circuit as much as possible using the air purge valves.

### NOTICE

- During filling, it might not be possible to remove all air in the system. Remaining air will be removed through the automatic air purge valves during first operating hours of the system. Additional filling with water afterwards might be required.
- The water pressure indicated on the manometer will vary depending on the water temperatures (higher pressure at higher water temperature). However, at all times water pressure should remain above 0.3 bar to avoid air entering the circuit.
- The unit might dispose some excessive water through the pressure relief valve.
- Water quality must be according to EN directive 98/83 EC.

## 6 Piping insulation

The complete water circuit, inclusive all piping, must be insulated to prevent condensation during cooling operation and reduction of the cooling and heating capacity.

If the temperature is higher than 30°C and the humidity is higher than RH 80%, then the thickness of the sealing materials should be at least 20 mm in order to avoid condensation on the surface of the sealing. Be sure to insulate the pipes in order to prevent the water being frozen.

## 7 Freeze prevention setting

- As the anti-freeze is used for the circulation water, freeze prevention operation is not necessary. Set MODE SW. "No freeze prevention operation" by turning off No.1 of MODE SW.
- The factory setting is that the freeze prevention operation No.1 of MODE SW. is on.

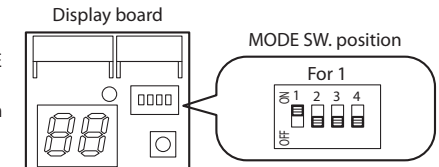

## 8 Wiring lid

- 1 Fasten wiring lid with the screw.

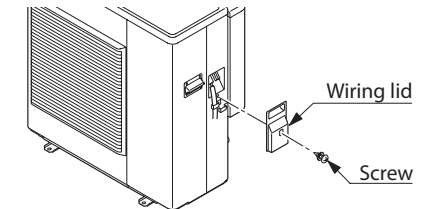

## 9 Hydraulic pressures and flow rates available

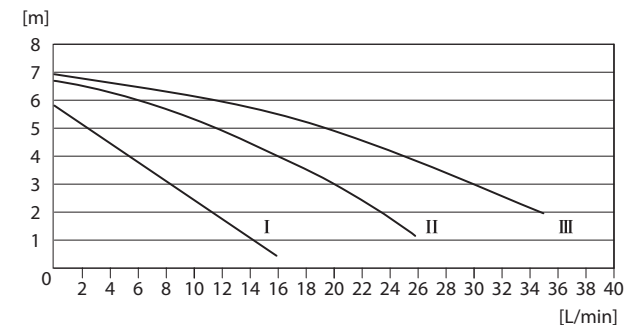

## 10 Installation check and test operation

- Carefully explain the operation method to the customer using the operation manual.

### Installation check items

As each item is checked, put a tick mark in the .

- Are the selection conditions for the installation location met?
- Is the power supply voltage as specified?
- Are the connecting cables connected securely?
- Are pipe connection sections thermally insulated?
- Are the earthing lines connected securely?
- Is there no hot water socket above the regular socket?
- Are the equipment and main pipe connection sections free of circulating water leaks?

### Test operation

(1) Test operate the system according to the operation manual.

(2) Check if the system operates normally.

- Does the circulating water go to the stipulated range?
- Are temperature adjustment and timer operation possible?
- Is the system free of abnormal noises?