



SHIFTING THE LIMITS



Fronius Ohmpilot

- EN Operating Instructions
- Accessories



Dear Reader,

Introduction

We would like to thank you for the trust you have placed in us and congratulate you on purchasing this high-quality Fronius product. These instructions will help you to familiarise yourself with the product. By reading the instructions carefully, you will learn about the diverse possibilities offered by your Fronius product. Only by doing so will you be able to make the best possible use of its benefits.

Please also observe the safety rules and thereby ensure a higher level of safety at the location where the product is being used. Careful handling of your product will support its quality and reliability over its long service life. These are key prerequisites for outstanding results.

Explanation of Safety Symbols



DANGER! Indicates an imminent danger. If not avoided, death or serious injury will result.



WARNING! Indicates a possibly dangerous situation. If not avoided, death or serious injury may result.



CAUTION! Indicates a possibly harmful situation. If not avoided, minor injury and/or damage to property may result.



NOTE! Indicates a risk of flawed results and possible damage to the equipment.

IMPORTANT! Indicates usage tips and other particularly useful information. It is not a signal word for a harmful or dangerous situation.

If you see any of the symbols depicted in the "Safety Rules" section, special care is required.

Contents

Safety Rules	7
General Remarks	7
Environmental Conditions	7
Choice of Location.....	8
Explanation of Symbols - Installation Position.....	9
Choice of Location - General Remarks	10
Qualified Personnel.....	11
EMC Measures.....	11
Final Disposal.....	11
Data Back-Up.....	11
Copyright.....	11
General Remarks	12
Utilisation in Accordance with "Intended Purpose".....	12
Warning Notices on the Device	14
Wall Mounting.....	15
Safety	15
Selecting Wall Plugs and Screws.....	15
Recommended Screws	15
Installation Instructions.....	15
Fronius Smart Meter.....	16
Integrating the Fronius Smart Meter.....	16
Indications/Controls on the Device.....	17
Selection of Heater	18
1-Phase Heater	18
3-Phase Heater	18
Example for Calculation of Charging Time.....	18
Wiring Diagram.....	19
Stripping Lengths	20
Electrical Connection.....	20
Opening the Ohmpilot	20
Application Example 1: 1-Phase Heating Element up to 3 kW.....	21
Application Example 2: 3-Phase Heating Element 900 W up to 9 kW	23
Application Example 3: 1-Phase Heating Element up to 3 kW with Heat Pump Control.....	25
Application Example 4: 1-Phase Heating Element up to 3 kW and External Source (e.g. gas-fired heating).....	28
Application Example 5: Two Heating Elements - 3-Phase and 1-Phase.....	31
Application Example 6: Two 3-Phase Heating Elements up to 9 kW	34
Establishing the Data Connection	37
Possible Communication Channels.....	37
Establishing a Connection via Modbus RTU.....	38
Establishing a Connection via LAN	39
Establishing a Connection via WLAN.....	40
Status Indication on Web Interface	42
Optional Settings.....	43
Manual Setting HEATER 1	43
Activating Legionella Prevention	43
Adapting the Day Curve	44
Temperature Limitation.....	44
Error List.....	45
Technical Data.....	30
Input Data.....	47
Interfaces.....	47
Output Data	47
General Data	47
Warranty Terms and Conditions, Disposal	48
Fronius Manufacturer's Warranty	48
Final Disposal.....	48
Applicable Standards and Guidelines	48
Fronius Worldwide	

Safety Rules

General Remarks



The device has been manufactured in accordance with the state of the art and the recognised safety rules. However, incorrect operation or misuse may result in:

- Injury or death to the operator or third parties
- Damage to the device and other property of the operator
- Inefficient operation of the device

All persons involved in commissioning, maintaining and servicing the device must:

- Be suitably qualified
- Have knowledge of and experience in dealing with electrical installations
- Read and follow these operating instructions carefully

The operating instructions must be kept at the location where the device is being used at all times. In addition to the operating instructions, the generally applicable and local regulations on accident prevention and environmental protection must be observed.

All safety and danger notices on the device:

- Must be in a legible state
- Must not be damaged
- Must not be removed
- Must not be covered, pasted or painted over

The heatsink can reach high temperatures.



Only operate the device when all protection devices are fully functional. If the protection devices are not fully functional, this may result in:

- Injury or death to the operator or third parties
- Damage to the device and other property of the operator
- Inefficient operation of the device

Any safety devices that are not functioning properly must be repaired by a suitably qualified technician before the device is switched on.

Never bypass or disable protection devices.

For the location of the safety and danger notices on the device, refer to the "General Remarks" section in the operating instructions for the device.

Before switching on the device, rectify any faults that could compromise safety.

This is for your personal safety!

Environmental Conditions



Operating or storing the device outside the specified area is regarded as not complying with the intended purpose. The manufacturer shall not be liable for any damage or loss resulting from this.

For exact information on permitted environmental conditions, please refer to the "Technical Data" in the operating instructions.

Choice of Location

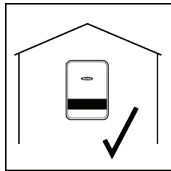

The Ohmpilot is suitable for installation indoors.



Do not install the Ohmpilot outdoors.

The Ohmpilot corresponds to protection class IP 54 and is protected against spray water from all sides.

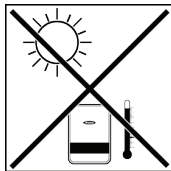

In order to keep warming of the Ohmpilot to a minimum, do not expose it to direct sunlight. Install the Ohmpilot in a protected position. The Ohmpilot must only be installed and operated at an ambient temperature of 0-40°C.

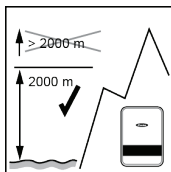
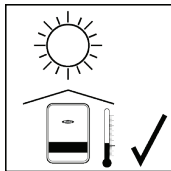

IMPORTANT!The Ohmpilot must not be installed or used at altitudes above 2000 m.



Do not install the Ohmpilot in:

- Areas where ammonia, corrosive vapours, acids or salts are present (e.g. fertiliser stores, ventilation openings from cattle sheds, chemical plants, tanneries, etc.)



Do not install the Ohmpilot in:

- Places where there is an increased risk of damage from farm animals (horses, cattle, sheep, pigs, etc.)
- Stables or adjoining areas
- Storage areas for hay, straw, chaff, animal feed, fertilisers, etc.

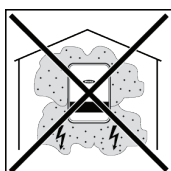

In principle, the Ohmpilot is designed to be dust-tight. However, in areas with high dust accumulation, the cooling surfaces may collect dust and this may impair the thermal performance. In such cases, regular cleaning is required. Consequently, we do not recommend installing the Ohmpilot in places and environments with strong dust formation.



Do not install the Ohmpilot in:

- Greenhouses
- Storage or processing areas for fruit, vegetables or winegrowing products
- Places used to prepare grain, green fodder or animal feeds

Explanation of Symbols - Installation Position



The Ohmpilot is designed to be installed vertically on a vertical wall.

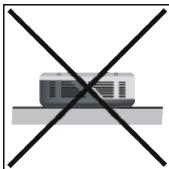
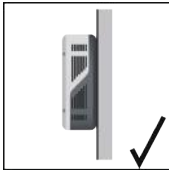

Do not install the Ohmpilot horizontally.



Do not install the Ohmpilot on a sloping surface.

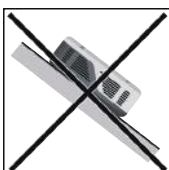

Do not install the Ohmpilot on a sloping surface with its connection sockets facing upwards.

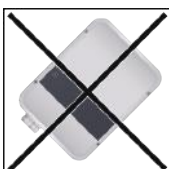

Do not install the Ohmpilot at an angle on a vertical wall.



Do not install the Ohmpilot horizontally on a vertical wall.



Do not install the Ohmpilot such its connection sockets are facing upwards.

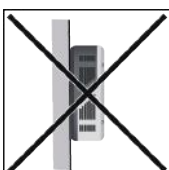



Do not install the Ohmpilot such that it overhangs with its connection sockets facing upwards.



Do not install the Ohmpilot such that it overhangs with its connection sockets facing downwards.



Do not install the Ohmpilot on the ceiling.

Choice of Location - General Remarks

The following criteria should be taken into account when choosing a location for the Ohmpilot:

Install only on a solid surface.

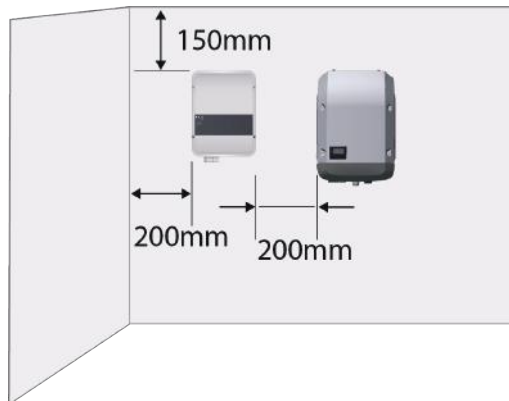

Max. ambient temperatures:
0 °C / +40 °C

Relative humidity:
0 - 99%

The direction of air flow within the Ohmpilot is from the bottom to the top

If the Ohmpilot is installed in an enclosed space, then forced-air ventilation must be provided to ensure adequate heat dissipation.

IMPORTANT! The maximum cable length from the output of the Ohmpilot to the load (heating element) must not exceed 5 m.

Qualified Personnel

The information on servicing contained in these operating instructions is only intended for qualified personnel. An electric shock can be fatal. Do not carry out any activities other than those listed in the documentation. This also applies even if you are qualified to do so.



All cables and leads must be secure, undamaged, insulated and adequately dimensioned. Arrange for loose connections, burnt, damaged or undersized cables and leads to be repaired by an authorised specialist company immediately.



Maintenance and repair work must only be carried out by an authorised specialist company.

With parts sourced from third parties, it is not guaranteed that they have been constructed and manufactured in accordance with the specifications and so as to comply with the safety requirements. Only use original spare parts (also applies to standard parts).

Do not carry out any modifications, alterations, etc. to the device without the manufacturer's consent.

Components that are not in perfect condition must be replaced immediately.

EMC Measures

In certain cases, even though a device complies with the standard limit values for emissions, it may affect the application area for which it was designed (e.g. when there is sensitive equipment at the same location, or if the site where the device is installed is close to either radio or television receivers). If this is the case, then the operator is obliged to take appropriate action to rectify the situation.

Disposal

In accordance with European Directive 2002/96/EC on waste electrical and electronic equipment and its implementation in national law, used electrical devices must be collected separately and recycled in an environmentally responsible manner. Ensure that you return your used device to your dealer or obtain information regarding a local, authorised collection and disposal system. Failure to comply with this EU Directive may result in a negative impact on the environment and your health!

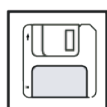
Data Back-Up

The user is responsible for the data back-up of any changes made from the factory settings. The manufacturer shall not be liable in the event that personal settings are deleted.

Copyright

Copyright of these operating instructions remains with the manufacturer.

Text and images correspond to the technical level at the time of going to press. We reserve the right to make changes. The content of the operating instructions shall not give rise to any claims on the part of the purchaser. We are grateful for any suggestions for improvement and notices of errors in the operating instructions.

General Remarks

Proper Use / Intended Purpose

With its "24 hours of sun" vision, Fronius is aiming to offer its customers solutions for generating, storing, distributing and using energy in an intelligent and cost efficient manner. The use of surplus energy for hot water preparation constitutes a simple option, with low investment costs, for storing electricity in the form of heat and using it at a time of the customer's choosing.

The Fronius Ohmpilot, which carries out precisely this task, is therefore an ideal addition to the Fronius product portfolio in the area of energy management and a further step towards "24 hours of sun".

The solution as a whole consists of the following components:

- **Fronius Symo / Galvo / Eco or Primo inverter (from Fronius Datamanager 2.0 software version 3.8.1-x onwards)**
- **Fronius Smart Meter**
- **Fronius Ohmpilot**
- **Resistive loads (e.g. boiler with heating element)**



NOTE! With the Fronius Datamanager Box 2.0, it is also possible to use any other generation source (CHP unit, non-Fronius inverter, etc.). However, as the figures for power produced and consumption are not available for these options, they cannot be displayed in Solarweb.

The Ohmpilot is a separate device that can control the surplus power from the photovoltaic system in a continuously variable manner, using pulse width modulation, for a phase between 0 and 100% (or 0 and 3 kW). Moreover, the Ohmpilot has two additional outputs for switching further phases. As a result, heating elements with an output of between 300 W and 9 kW can be controlled in a continuously variable manner:

A heating element with up to 3 kW output can be controlled in a continuously variable manner using one phase.

In the case of a heating element with 9 kW output, the surplus power of 0 - 3 kW is controlled in a continuously variable manner in phase 1. If more power is available, the Ohmpilot activates phase 2 in addition and phase 1 can again control the surplus in a continuously variable manner between 3 - 6 kW. If the available power is greater than 6 kW, the Ohmpilot adds phase 3 and phase 1 again controls the surplus between 6 and 9 kW in a continuously variable manner.

Power range	Phase 1	Phase 2	Phase 3
0 - 3 kW	0 - 3 kW continuously variable	-	-
3 - 6 kW	0 - 3 kW continuously variable	3 kW fixed	-
6 - 9 kW	0 - 3 kW continuously variable	3 kW fixed	3 kW fixed

Other resistive loads such as infrared heaters, towel dryers, etc. can also be controlled.



WARNING! Only purely resistive loads may be connected. Connecting an incorrect load (e.g. fan heater) will lead to destruction of the load.



WARNING! No electronic thermostats may be used in the loads. The use of electronic thermostats will lead to destruction of the Ohmpilot and/or the load. Mechanical temperature switches must be used.

IMPORTANT! In hard water areas, calcification of the heating element may occur, particularly if the target temperatures are set to over 60 °C. We recommend a yearly inspection. To execute this, dismantle the heating element from the storage tank and remove the limescale. Do not scratch the surface of the heating element (formation of corrosion).

Warning Notices on the Device

Warning notices and safety symbols are located on the left-hand side of the Ohmpilot. These warning notices and safety symbols must not be removed or painted over. The notices and symbols warn of incorrect operation that could result in serious injury and damage to property.

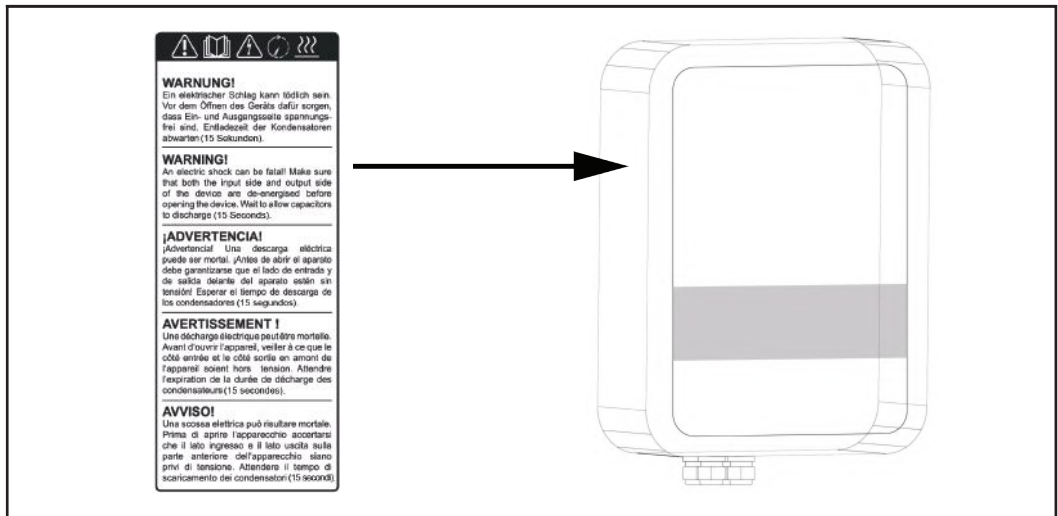

Safety symbols:



Risk of serious injury and property damage from incorrect operation



Do not use the functions described here until you have fully read and understood the following documents:

- These operating instructions
- All the operating instructions for the system components of the photovoltaic system, especially the safety rules



Dangerous electrical voltage



Wait for the capacitors to discharge.



Hot surface

Text on the warning notices:

WARNING!

An electric shock can be fatal. Before opening the device, ensure that the input and output sides are de-energised. Wait for the capacitors to discharge (15 seconds).

WARNING!

The device must not be covered and nothing may be hung over the device or the cables.

Wall Mounting

Safety



NOTE! The IP 54 protection class only applies if the cover is firmly screwed to the back.

Selecting Wall Plugs and Screws

IMPORTANT! Depending on the surface, different types of fixings are required for mounting the Ohmpilot. The fixings are therefore not included in the scope of supply for the Ohmpilot. The fitter is personally responsible for selecting the correct fixings. The Ohmpilot must be mounted with four screws. Ensure that the screws are tight and that the wall is stable. .

Recommended Screws

To install the Ohmpilot, the manufacturer recommends the use of steel screws with a diameter of 4 - 6 mm.



CAUTION! Risk of damage to the Ohmpilot due to dirt or water on the terminals and in the electronics. When drilling, ensure that the terminals and electronics do not become dirty or wet.

Installation Instructions

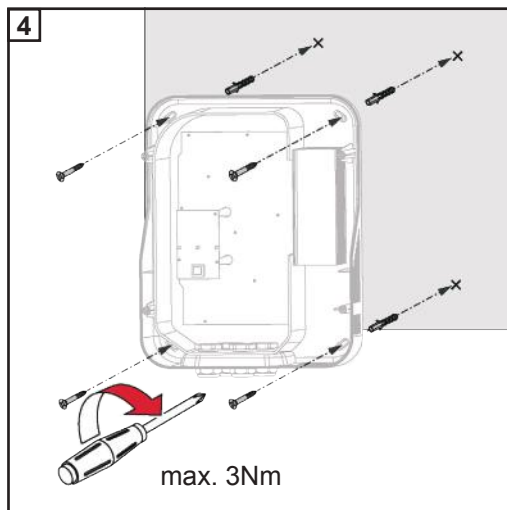
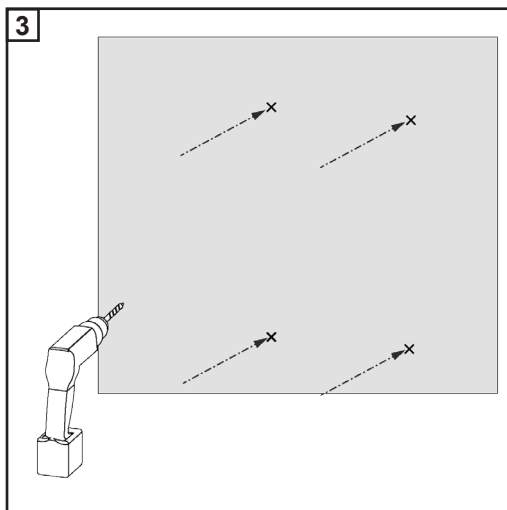
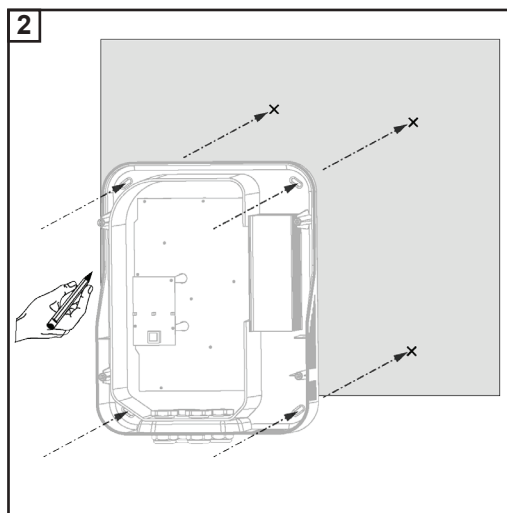
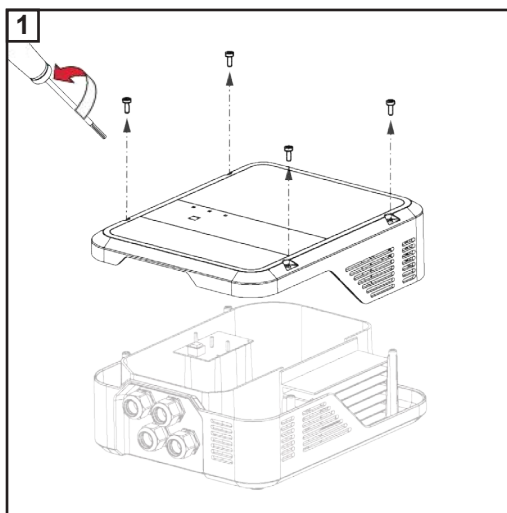

Fronius Smart Meter

Integrating the Fronius Smart Meter

A Fronius Smart Meter is required for operation of the Ohmpilot, so that the surplus energy can be measured. For integration of the Fronius Smart Meter, an inverter with Datamanager 2.0 and software version V3.8.1-x or higher and/or a Datamanager Box (from software version 3.8.1-x) is necessary. It must be configured on the Datamanager whether the Fronius Smart Meter is installed at the feed-in point or in the consumption branch. The setting must be implemented on the webpage under the "Meter" tab for the Datamanager.

Further information on the Datamanager can be found in the "Fronius Datamanager 2.0" Operating Instructions

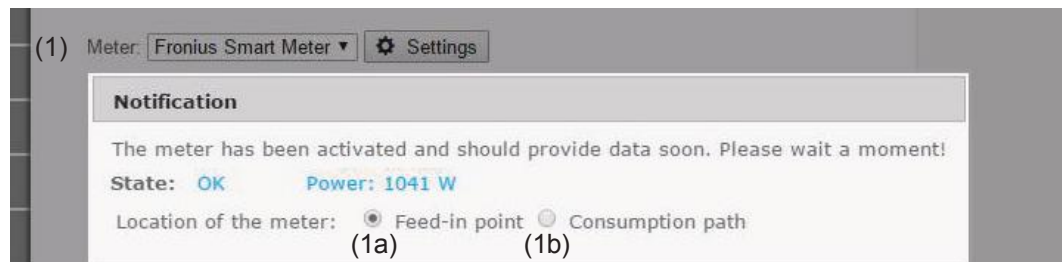

- (1a) Meter position at feed-in point
The power and energy fed in are measured. Consumption is determined based on these values and the system data.
- (1b) Meter position in consumption branch
The power and energy consumed are measured directly. The power and energy fed in are determined based on these values and the system data.

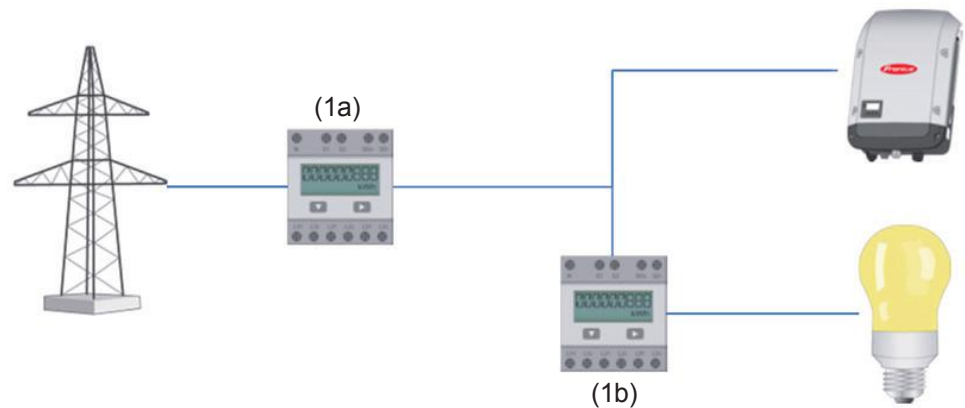

How to connect the Fronius Smart Meter to the Fronius Datamanager 2.0:

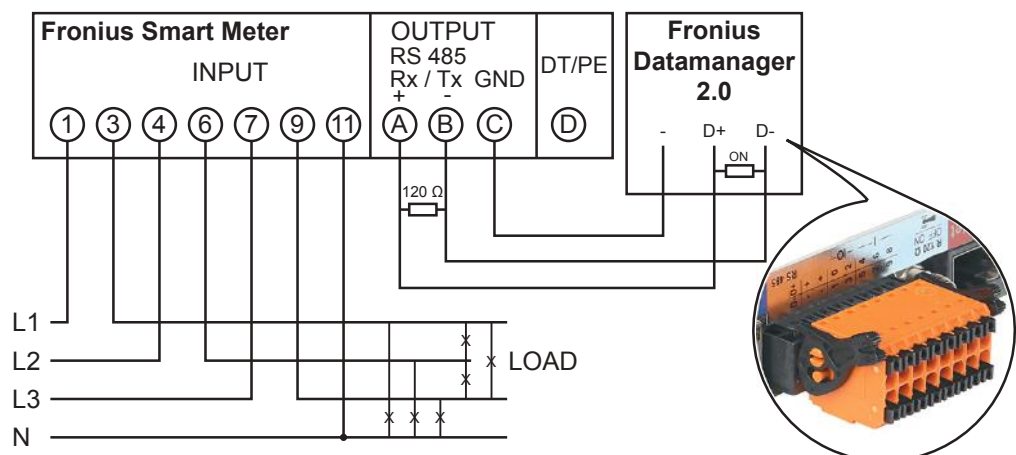

Indications/Controls on the Device

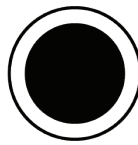

- 1x WPS
- 2x ACCESS POINT
- 3x BOOST

Press 1x

WPS (Wi-Fi Protected Setup) is opened for 2 minutes or until successful pairing with the router. By pressing the WPS button the router, the WLAN password is transmitted to the Ohmpilot.

Press 2x

WLAN access point is activated for 30 minutes so that settings can be implemented on the Ohmpilot via the Fronius Solar web app.

Press 3x

Boost mode - dimmer level is activated for 4 hours at 100%, L2 and L3 are switched through. This may result in electricity being sourced from the grid.

Press again

Ohmpilot is returned to standard operating mode, boost mode, access point or WPS are deactivated.



Green LED

Heater indication

Unlit

No power supply to the Ohmpilot

Flashing green

The faster the flashing frequency, the greater the heat output. At 0 W heat output the LED flashes slowly, at full output it flashes quickly.

Flashing green 2x

The output from the heating element is measured and it is detected whether a 1-phase or 3-phase heating element is connected.

Steady green

Target temperature undercut or legionella prevention system active (full heat output).



Blue LED

Connection indication LAN / WLAN

Unlit

No connection

Flashing blue 1x

WPS (Wi-Fi Protected Setup) open

Flashing blue 2x

WLAN access point open

Steady blue

Connection with network



Red LED

Error indication

Unlit

No error

Flashing red 1x

No connection to the inverter

Flashing red 2x

Temperature measurement faulty

Flashing red 3x

Heating element faulty

Flashing red 4x

Ohmpilot faulty

Flashing red 5x

Target temperature not reached

A detailed description of the error is provided in Solar Web.

Selection of Heater

- 1-Phase Heater:**
- 0.3 to 3 kW
 - Purely resistive load (no electronic temperature limiters, fans, etc.)

- 3-Phase Heater:**
- 0.9 to 9 kW
 - Equal load distribution on all 3 phases (e.g. 3 x 3 kW)
 - If a mechanical temperature switch is being used, it must switch all 3 phases simultaneously.
 - Purely resistive load (no electronic temperature limiters, fans, etc.)
 - Neutral conductor must be implemented (this can generally also be retrofitted)

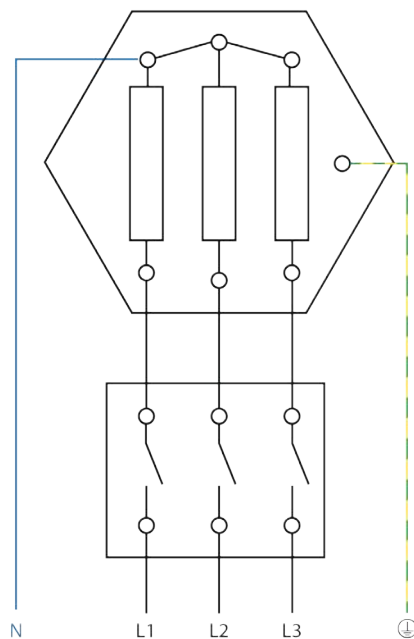

NOTE! A mechanical temperature switch simplifies commissioning and use. If no mechanical temperature switch is available, a temperature sensor can also be connected to the Ohmpilot in order to limit the maximum temperature. (See "Temperature limitation")

Example for Calculation of Charging Time:

500-litre boiler, heater can be fitted at the very bottom of the boiler, temperature spread 45 - 60 °C = 15 °C; 4.5 kW heater

Possible stored energy = $0.5 \text{ m}^3 \times 1.16 \text{ kWh} \times 15 \text{ °C} = 8.7 \text{ kWh}$

If the heater is fully activated, heating up takes approximately 2 hours (8.7 kWh / 4.5 kW)

NOTE! So that optimal use can be made of the surplus power and the hot water is reheated quickly, the heater output should be adapted to the output of the photovoltaic system, e.g. 5 kWp => 4.5 kW heater.

Wiring Diagram

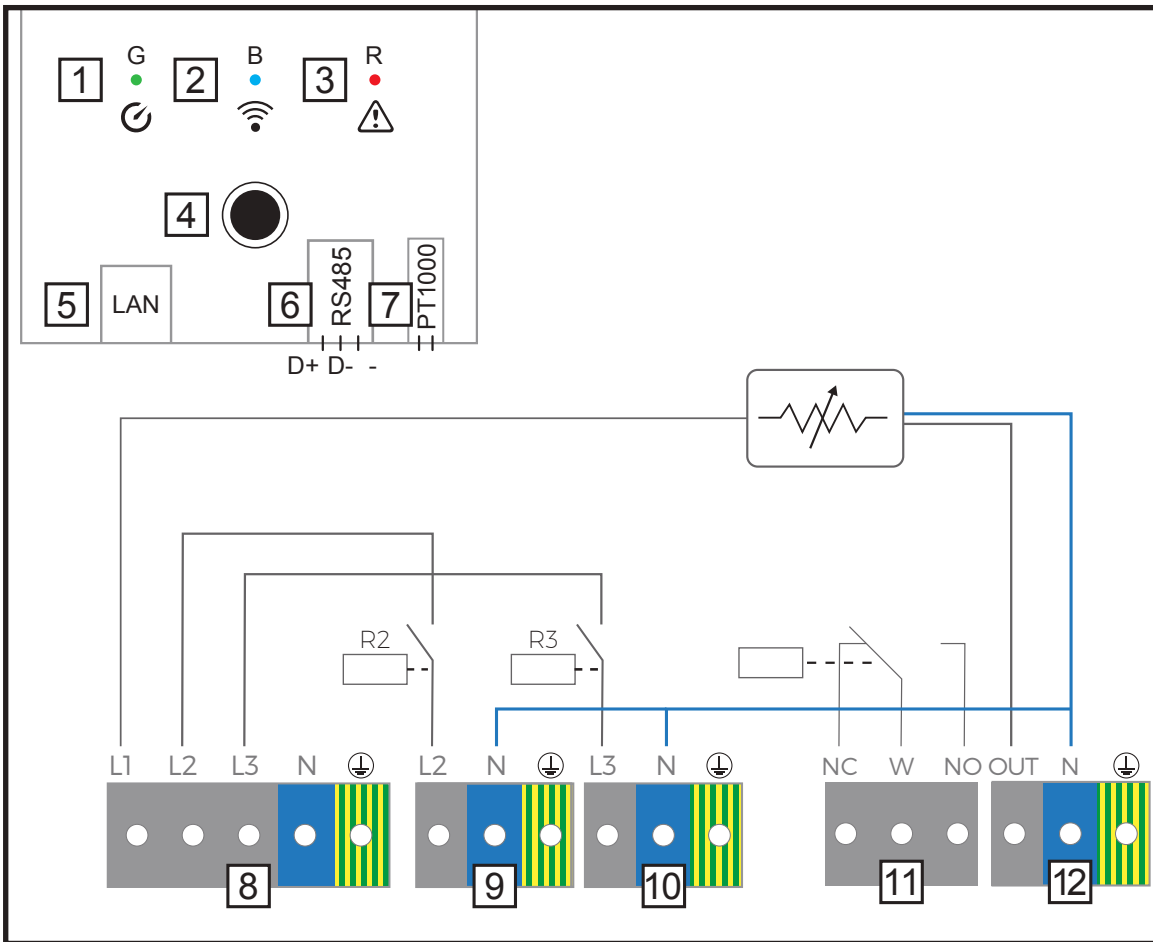

1 Green LED

2 Blue LED

3 Red LED

4 Button

5 Ethernet RJ45, at least CAT5, screened

6 Modbus RTU (default address 40)
Spring balancer 0.2 - 1.5 mm²
max. 1000 m, screened and twisted

7 Connection terminal for PT1000
Temperature sensor
Spring balancer 0.2 - 1.5 mm²

8 INPUT - grid supply 1x 230 V or 3x 230 V
Spring balancer 1.5 - 1.5 mm²

NOTE! Phase and neutral conductors must not be mixed up. Residual current-operated circuit breaker is triggered.

9 OUTPUT - L2 heating element
Spring balancer 1.5 - 2.5 mm²

10 OUTPUT - L3 heating element
Spring balancer 1.5 - 2.5 mm²

11 Multifunctional relay output
(see application examples)
variable max. 13 A resistive load
Spring balancer 1.5 - 2.5 mm²

WARNING! If signal cables are connected, the individual wires must be bound together with a cable tie directly upstream of the terminal. This prevents any wire making contact with dangerous voltages if it works loose.

12 OUTPUT - heating element continuously adjustable up to 3 kW

Stripping Lengths

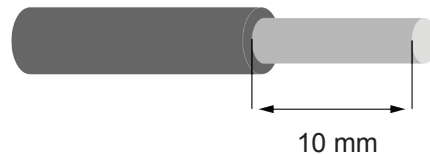

Stripping length of terminals on power stage set (L1, L2, etc.)

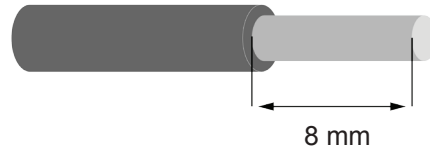

Stripping length of terminals on control board (D+, D-, - and PT1000)

Electrical Connection

IMPORTANT! Electrical connection work may only be carried out by a specialist.

IMPORTANT! The ground conductor connection must be perfectly installed and reliably connected.

IMPORTANT! The Ohmpilot must be equipped with an overvoltage protection device of maximum B16 A and a residual-current circuit breaker on the grid side.

IMPORTANT! On the output side, it must be ensured that only purely resistive loads are connected.

IMPORTANT! The maximum cable length from the output of the Ohmpilot to the load (heating element) must not exceed 5 m on EMC grounds.

IMPORTANT! The Ohmpilot must be protected against overvoltage from the grid.

IMPORTANT! When connecting a heating element, check the grounding of the boiler/ buffer and/or the heating system and, when setting the temperature on the heating element, observe the maximum permitted inlet water and hot water temperature.

IMPORTANT! The RS485 conductor should be designed as a data cable in order to prevent any mix-up with the grid conductor when connecting.

Opening the Ohmpilot



WARNING! An inadequate ground conductor connection can cause serious injury or property damage.



WARNING! An electric shock can be fatal. Danger from residual voltage in capacitors. Wait for the capacitors to discharge. The discharge time is 15 seconds.



WARNING! Risk of burns from the heatsink when open.

1-Phase Heating Element up to 3 kW

Application Example 1

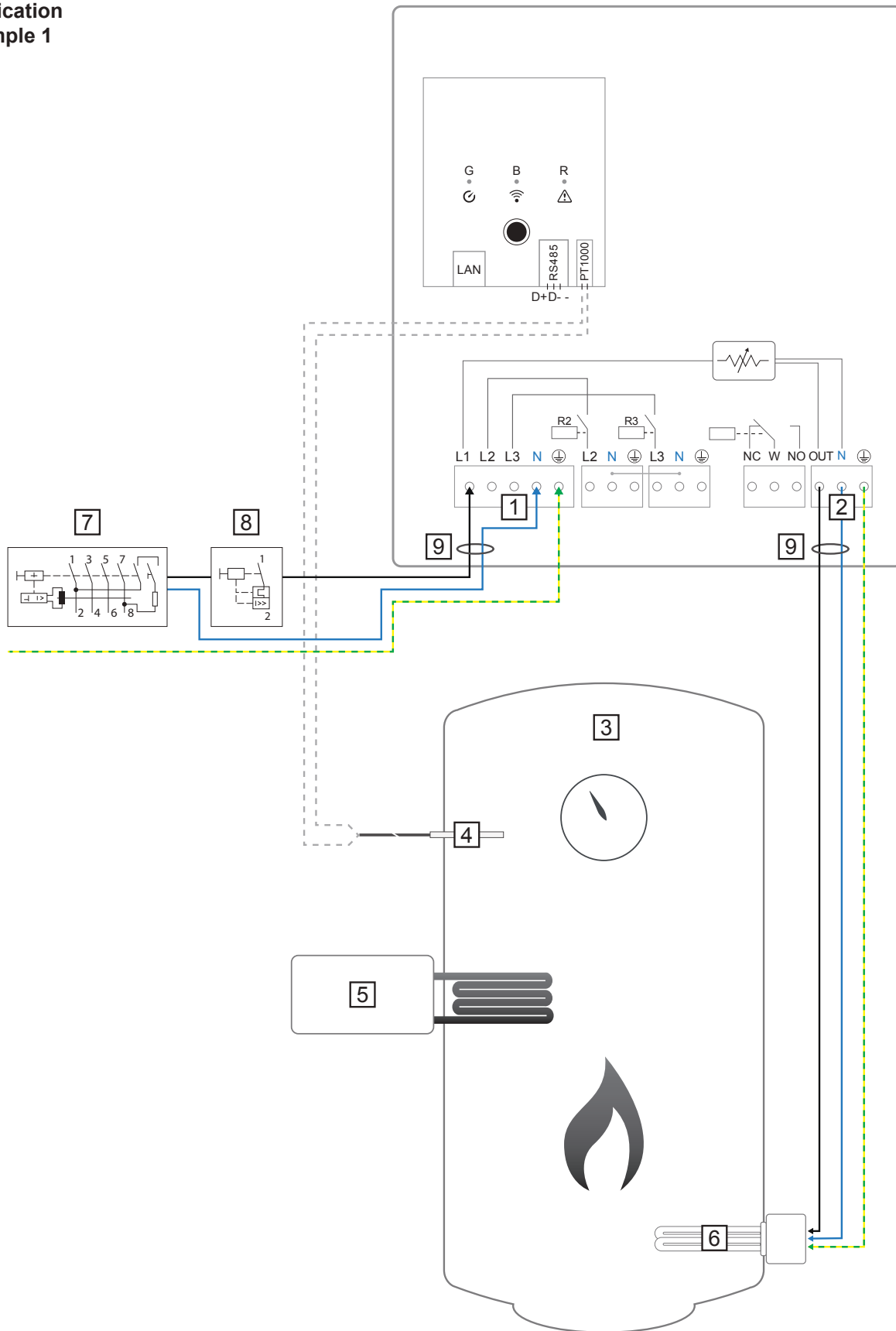

IMPORTANT! Plug & Play - With this application, no further settings are necessary following successful connection to the inverter.

-
- | | |
|--|--|
| <p>1 INPUT - grid supply 1x 230 V
Spring balancer 1.5 - 2.5 mm²</p> | <p>5 External source (e.g. gas-fired heating)</p> |
| <p> NOTE! Phase and neutral conductors must not be mixed up. Residual current-operated circuit breaker is triggered.</p> | <p>6 Heating element (max. 3 kW)</p> |
| <p>2 OUTPUT up to 3 kW variable, max. 13 A resistive load
Spring balancer 1.5 - 2.5 mm²</p> | <p>7 Residual-current circuit breaker</p> |
| <p>3 Hot water boiler</p> | <p>8 Circuit breaker max. B16A</p> |
| <p>4 PT1000 temperature sensor</p> | <p>9 Ferrite (included in delivery)</p> |
-

Functional Description

The Fronius Smart Meter records the current power at the feed-in point and transfers the data to the Datamanager. By controlling the Ohmpilot, the Datamanager adjusts any surplus energy that is available to zero. In detail, this takes place by continuously adjusting the heating element connected to the Ohmpilot.

This means that the surplus energy is used up by the heating element in a continuously variable manner.

If no temperature sensor is fitted, an external source (e.g. gas-fired heating) must be used to ensure the minimum temperature is met.

As an alternative, the Ohmpilot can also ensure the minimum temperature. For this, a temperature sensor must be connected so that the Ohmpilot can measure the temperature. This may result in electricity being sourced from the grid.

The maximum temperature must be set on the heating element thermostat.

If the heating element does not have a thermostat, the Ohmpilot can also carry out this task as an alternative (see "Optional Settings" section).

3-Phase Heating Element 900 W up to 9 kW

Application Example 2

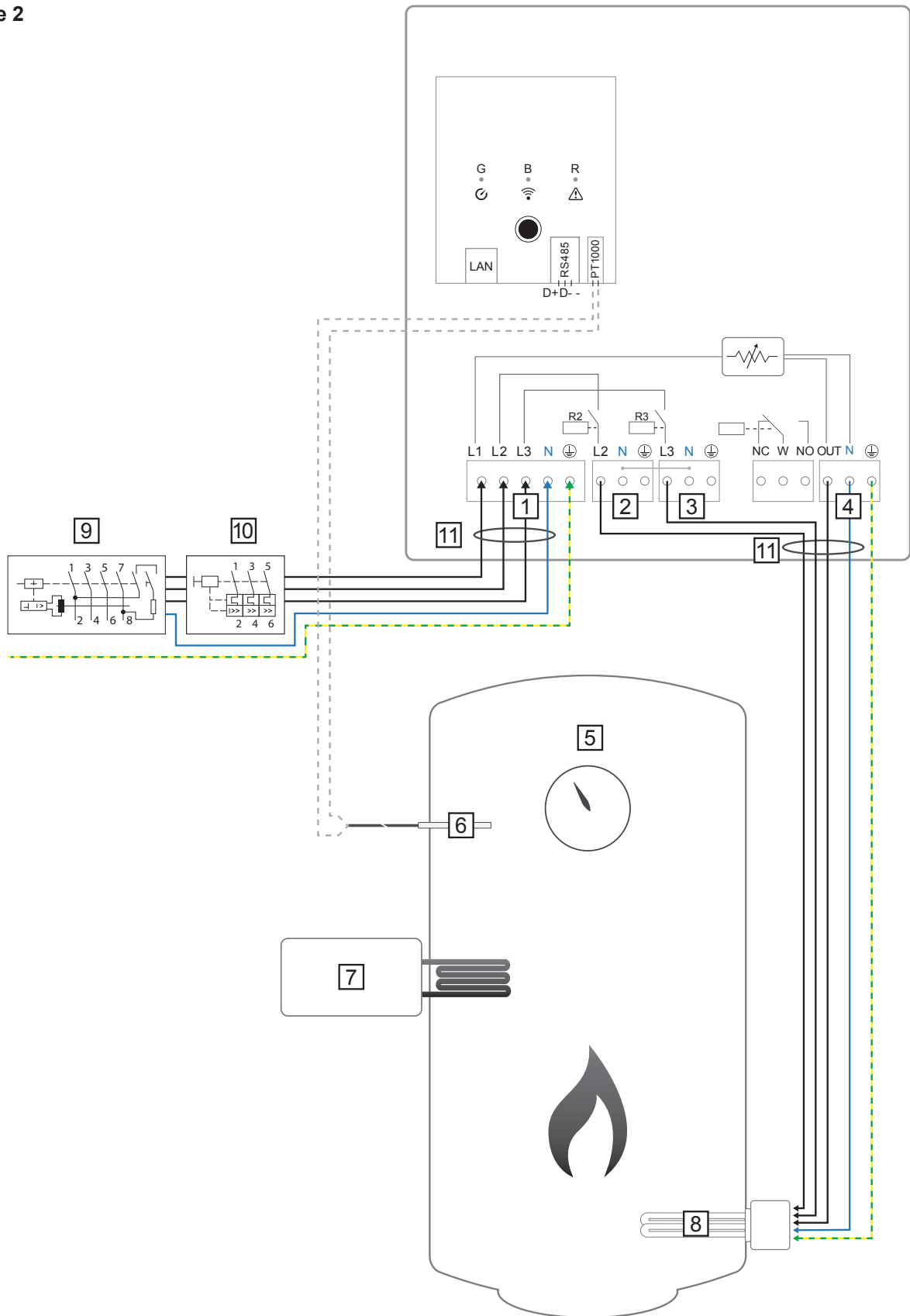

IMPORTANT! Plug & Play - With this application, no further settings are necessary following successful connection to the inverter.

-
- | | |
|---|--|
| <p>1 INPUT - grid supply 3x 230 V
Spring balancer 1.5 - 2.5 mm²</p> <p> NOTE! Phase and neutral conductors must not be mixed up. Residual current-operated circuit breaker is triggered.</p> <p>2 OUTPUT - L2 heating element</p> <p>3 OUTPUT - L3 heating element</p> <p>4 OUTPUT up to 3 kW variable, max. 13 A resistive load
Spring balancer 1.5 - 2.5 mm²</p> <p>5 Hot water boiler</p> | <p>6 PT1000 temperature sensor</p> <p>7 External source (e.g. gas-fired heating)</p> <p>8 Heating element (max. 9 kW)</p> <p>9 Residual-current circuit breaker</p> <p>10 Circuit breaker max. B16A</p> <p>11 Ferrite (included in delivery)</p> |
|---|--|
-

Functional Description

The Fronius Smart Meter records the current power at the feed-in point and transfers the data to the Datamanager. By controlling the Ohmpilot, the Datamanager adjusts any surplus energy that is available to zero. In detail, this takes place by continuously adjusting the heating element connected to the Ohmpilot.

This means that the surplus energy is consumed in a continuously variable manner with the heating element. Depending on the surplus power, the individual phases are switched on or off and the remaining power is consumed at L1. As a result, the heating element output is divided by three.

If no temperature sensor is fitted, an external source (e.g. gas-fired heating) must be used to ensure the minimum temperature is met.

As an alternative, the Ohmpilot can also ensure the minimum temperature. For this, a temperature sensor must be connected so that the Ohmpilot can measure the temperature. This may result in electricity being sourced from the grid.

The maximum temperature must be set on the heating element thermostat.



If the heating element does not have a thermostat, the Ohmpilot can also carry out this task as an alternative (see "Optional Settings" section).

 **NOTE!** A heating element with realisation of a neutral conductor is required.

1-Phase Heating Element up to 3kW with Heat Pump Control

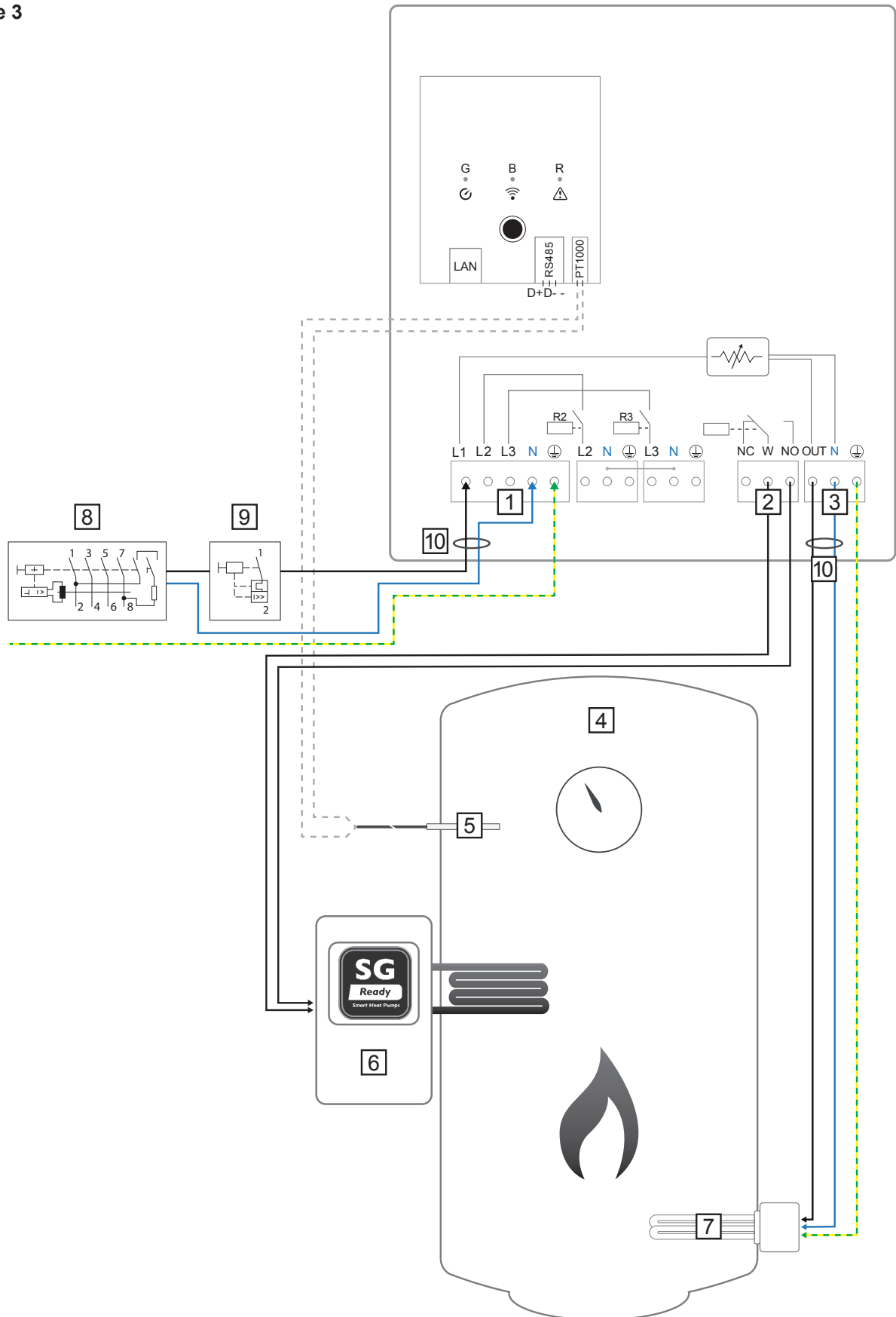
Application
Example 3



- | | |
|---|---|
| <p>1 INPUT - grid supply 1x 230 V
Spring balancer 1.5 - 2.5 mm²</p> <p> NOTE! Phase and neutral conductors must not be mixed up. Residual current-operated circuit breaker is triggered.</p> <p>2 Multifunctional relay output</p> <div style="background-color: #ff9900; padding: 5px; border: 1px solid #ff9900;"> <p> WARNING! If signal cables are connected, the individual wires must be bound together with a cable tie directly upstream of the terminal. This prevents any wire making contact with dangerous voltages if it works loose.</p> </div> <p>3 OUTPUT up to 3 kW variable, max. 13 A resistive load
Spring balancer 1.5 - 2.5 mm²</p> <p>4 Hot water boiler</p> | <p>5 PT1000 temperature sensor</p> <p>6 Heat pump with SG Ready control input</p> <p> NOTE! The voltage must be at least 15 V and the current at least 2 mA, so that the relay contacts do not oxidise.</p> <p>7 Heating element (max. 3 kW)</p> <p>8 Residual-current circuit breaker</p> <p>9 Circuit breaker max. B16A</p> <p>10 Ferrite (included in delivery)</p> |
|---|---|

Functional Description

The Fronius Smart Meter records the current power at the feed-in point and transfers the data to the Datamanager. By controlling the Ohmpilot, the Datamanager adjusts any surplus energy that is available to zero. In detail, this takes place by continuously adjusting the heating element connected to the Ohmpilot and by targeted switching on of the heat pump.

For activation, the heat pump must have a control input (e.g. SG Ready or DSO release). The heat pump can, for example, be switched from operating status 2 (normal operation) to operating status 3 (increased operation) as a result of activation of heat pump input 2 by the relay. However, the heat pump can also be switched from operating status 1 (DSO block) to operating status 2 (normal operation) as a result of activation of heat pump input 1 by the relay.

A description and list of SG Ready heat pumps can be found at:

<http://www.waermepumpe.de/waermepumpe/qualitaetssicherung/sg-ready-label/>

Relatively small surpluses are consumed with the heating element in a continuously variable manner. From a certain surplus power, it makes sense to activate the heat pump, as it is more efficient (e.g. COP for hot water preparation up to 53 °C = 2.5).

The optimal switching thresholds depend on:

- COP of the heat pump. The higher the temperature to which the hot water is heated, the lower the COP
- Electrical output of the heat pump
- Feed-in tariff and the costs for purchasing electricity
- Reduction of the heat pump's start-up cycles = increase in service life of the heat pump
- Thermal losses from the heat pump and the pipes

If no temperature sensor is installed, the heat pump must ensure the minimum temperature is maintained. Alternatively, the Ohmpilot can also ensure the minimum temperature through activation of the heat pump. This may result in electricity being sourced from the grid.

The maximum temperature must be set on the heating element thermostat and on the

heat pump. If the heating element does not have a thermostat, the Ohmpilot can also carry out this task as an alternative (see "Optional Settings" section).



NOTE! This function can also be combined with a 3-phase heating element.

OHMPILOT
GENERAL
NETWORK
EN

GENERAL SETTINGS

Designation

HEATER 1

Automatic
 Manual

Consumer Power (W)

Temperature sensor present

HEATER 2

Consumer

Starting threshold Power (W)

Switch off threshold Power (W)

Save

1. The section "Establishing the Data Connection" describes how you can access the Ohmpilot website.
2. Under HEATER 2, select "SG Ready heat pump" as the load
3. Under the switch-on threshold, select "Feed-in" and enter the required power in Watts from which the heat pump should be switched on.
4. Under the switch-off threshold, select "Purchase" and "Feed-in" and enter the required power in Watts from which the heat pump should be switched off.

Example 1:

If you have selected "Purchase" under the switch-off threshold and entered a power of 500 W, the heat pump will be switched off as soon as the power being drawn from the grid exceeds 500 W.

Example 2:

If you have selected "Feed-in" under the switch-off threshold and entered a power of 500 W, the heat pump will be switched off as soon as the power being fed in is less than 500 W.



NOTE! The heat pump must be connected to the same DSO meter.

Between the switch-on and switch-off thresholds, the self-consumption of the heat pump must also be taken into consideration. For example, if the heat pump consumes 3000 Watts of electricity and a hysteresis of 500 Watt must be taken into account, the switch-on threshold can be set to feed-in 3000 Watts and the switch-off threshold to purchase 500 Watts.

1-Phase Heating Element up to 3 kW and External source

Application
Example 4

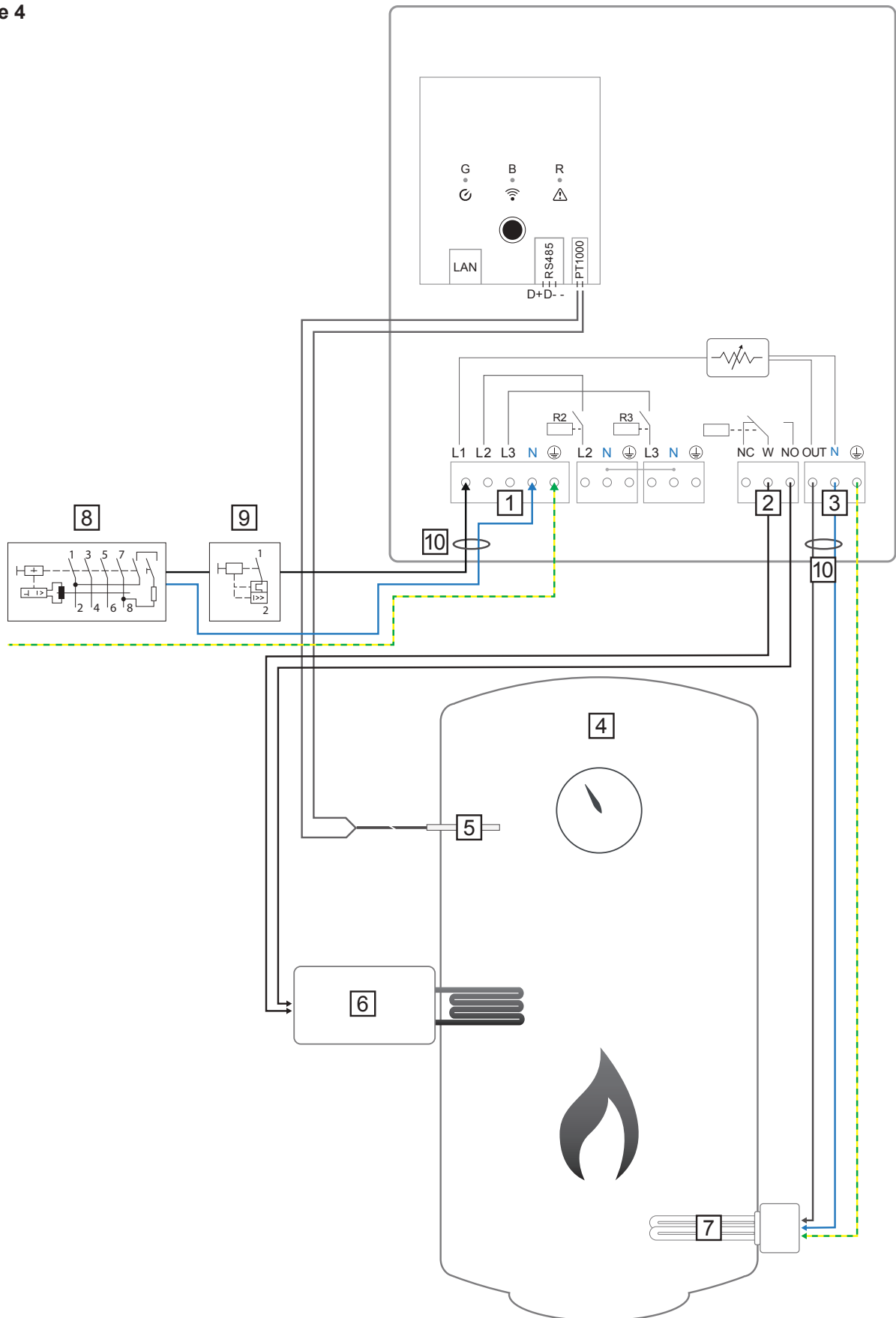

- 1 INPUT - grid supply 1x 230 V
Spring balancer 1.5 - 2.5 mm²
- 2 Multifunctional relay output
- 3 OUTPUT up to 3 kW variable, max.
13 A resistive load
Spring balancer 1.5 - 2.5 mm²
- 4 Hot water boiler
- 5 PT1000 temperature sensor
- 6 External source (e.g. gas-fired heating)
- 7 Heating element (max. 9 kW)
- 8 Residual-current circuit breaker
- 9 Circuit breaker max. B16A
- 10 Ferrite (included in delivery)

 **NOTE!** Phase and neutral conductors must not be mixed up. Residual current-operated circuit breaker is triggered.

 **WARNING!** If signal cables are connected, the individual wires must be bound together with a cable tie directly upstream of the terminal. This prevents any wire making contact with dangerous voltages if it works loose.

 **NOTE!** The voltage must be at least 15 V and the current at least 2 mA, so that the relay contacts do not oxidise.

Functional Description

The Fronius Smart Meter records the current power at the feed-in point and transfers the data to the Datamanager. By controlling the Ohmpilot, the Datamanager adjusts any surplus energy that is available to zero. In detail, this takes place by continuously adjusting the heating element connected to the Ohmpilot.

This means that the surplus energy is used up by the heating element in a continuously variable manner.

The temperature is measured by the Ohmpilot. If the temperature falls below the minimum, then an external source (e.g. gas-fired heating) will be activated until the minimum temperature is reached again, so that the Ohmpilot only uses surplus energy and does not draw any energy from the grid.

The maximum temperature must be set on the heating element thermostat.

If the heating element does not have a thermostat, the Ohmpilot can also carry out this task as an alternative (see "Optional Settings" section).

 **NOTE!** The heating element is used for switching on and off the legionella prevention.

 **NOTE!** This function can also be combined with a 3-phase heating element.

GENERAL SETTINGS

Designation

HEATER 1

Automatic Manual

Consumer Power (W)

Temperature sensor present Legionella prevention (h)

Adapt day curve Maximum temperature

Time from:

<input checked="" type="checkbox"/>	06:00	<input type="checkbox"/>
<input checked="" type="checkbox"/>	11:00	<input type="checkbox"/>
<input checked="" type="checkbox"/>	13:00	<input type="checkbox"/>
<input checked="" type="checkbox"/>	21:00	<input type="checkbox"/>

Target temperature:

45	<input type="text"/>	°C
50	<input type="text"/>	°C
45	<input type="text"/>	°C
40	<input type="text"/>	°C

HEATER 2

Consumer

Save

1. The section "Establishing the Data Connection" describes how you can access the Ohmpilot website.
2. Highlight the field "Temperature sensor present"
3. Highlight the field "Adapt day curve"
4. Under "Time from", enter the time from which the minimum temperature should be adjusted, and the specific minimum temperature.
5. Under "Target temperature", enter the required temperature.
6. Under HEATER 2, select "Activate external source"

Example 1:

If you enter 6.00 am under "Time from" and select 45 °C as the temperature, the heating will operate from 6.00 am until such time as a temperature of 45 °C is reached. The external source (e.g. gas-fired heating) will only be activated if the temperature is below the set value.

Two Heating Elements - 3-Phase and 1-Phase

Application
Example 5

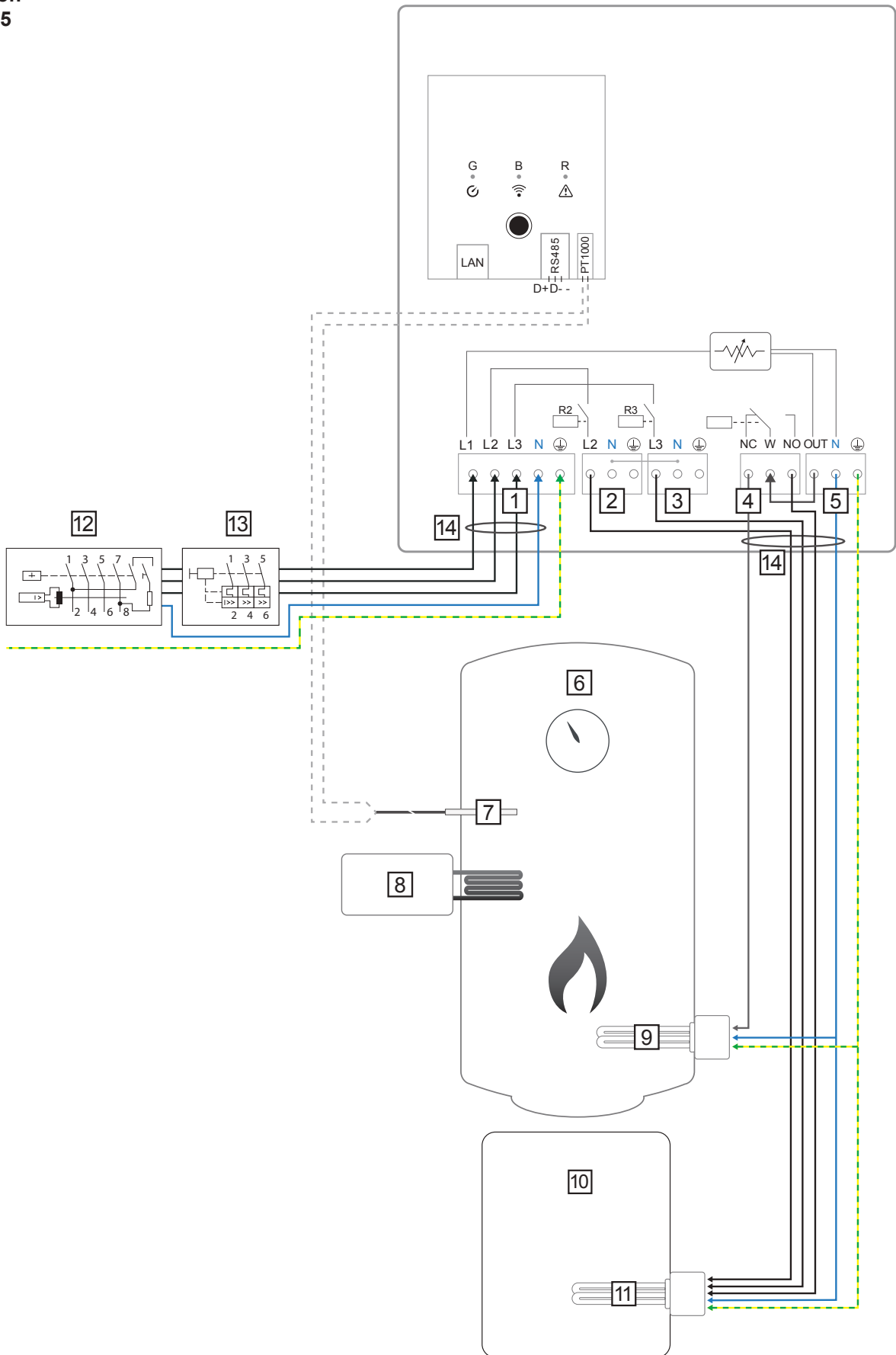

-
- | | |
|--|--|
| <p>1 INPUT - grid supply 3x 230 V
Spring balancer 1.5 - 2.5 mm²</p> <p> NOTE! Phase and neutral conductors must not be mixed up. Residual current-operated circuit breaker is triggered.</p> <p>2 OUTPUT - L2 heating element</p> <p>3 OUTPUT - L3 heating element</p> <p>4 Multifunctional relay output</p> <p>5 OUTPUT up to 3 kW variable, max. 13 A resistive load
Spring balancer 1.5 - 2.5 mm²</p> <p>6 Hot water boiler</p> <p>7 PT1000 temperature sensor</p> | <p>8 External source (e.g. gas-fired heating)</p> <p>9 Heating element 1 (max. 3 kW)</p> <p>10 Buffer</p> <p>11 Heating element 2 (max. 9 kW)</p> <p>12 Residual-current circuit breaker</p> <p>13 Circuit breaker max. B16A</p> <p>14 Ferrite (included in delivery)</p> |
|--|--|
-

Functional Description

Many heating systems consist of a boiler and a buffer, with the central heating supplying the buffer and a control system charging the hot water boiler via a pump. As with thermal photovoltaic systems, the Ohmpilot is also capable of heating the hot water boiler first and then the buffer, so that the maximum amount of photovoltaic surplus energy can be stored.

The Fronius Smart Meter records the current power at the feed-in point and transfers the data to the Datamanager. By controlling the Ohmpilot, the Datamanager adjusts any surplus energy that is available to zero. In detail, this takes place by continuously adjusting the heating element connected to the Ohmpilot.

For this application, two heating elements are installed, with preference being given to activation of the first heating element (9). Only once the maximum temperature in the boiler (6) has been reached is the second heating element activated in a continuously variable manner, so that the remaining energy can, for example, be stored in a buffer.

If no temperature sensor is connected to the Ohmpilot, after 30 minutes the Ohmpilot attempts to output energy via the first heating element once again. If a temperature sensor is present, the device switches back to the first heating element as soon as a temperature difference of 8 °C is reached (compared to the temperature measured prior to switch-over).

This switching can also be used for layering in a boiler/buffer, so that the maximum temperature is reached in the top part of the boiler using minimal energy and the remaining energy is stored in the lower part of the boiler. By using layering in a storage tank, it is also possible to store significantly more energy, as a minimum temperature is normally maintained in the top part of the boiler. This means that the temperature difference and therefore the amount of energy is rather small. In the lower part of the boiler, a high temperature difference of, for example, 50 °C can be used.

Both the first and the second heating element can be 1-phase or 3-phase. For two 3-phase heating elements please refer to application example 6. If no temperature

sensor is installed, an external source (e.g. gas-fired heating) must ensure the minimum temperature.

As an alternative, the Ohmpilot can also ensure the minimum temperature. This may result in electricity being sourced from the grid. The maximum temperature must be set on the heating element thermostat. If heating element 1 (9) does not have a thermostat, the Ohmpilot can also carry out this task as an alternative (see "Optional settings" section). However, it is imperative that heating element 2 (11) has a thermostat.



NOTE! At no point can both heating elements be heated simultaneously.

OHMPILOT
GENERAL
NETWORK
EN

GENERAL SETTINGS

Designation

HEATER 1

Automatic
 Manual

Consumer
 Power (W)

Temperature sensor present

HEATER 2

Consumer
 Power (W)

1. The section "Establishing the Data Connection" describes how you can access the Ohmpilot website.
2. Under heater 1, select "manual" and "1 or 3-phase", as well as the power of the load.
3. Under HEATER 2, select "1 or 3-phase" as the load and the power of the load.

Two 3-Phase Heating Elements up to 9 kW

Application
Example 6

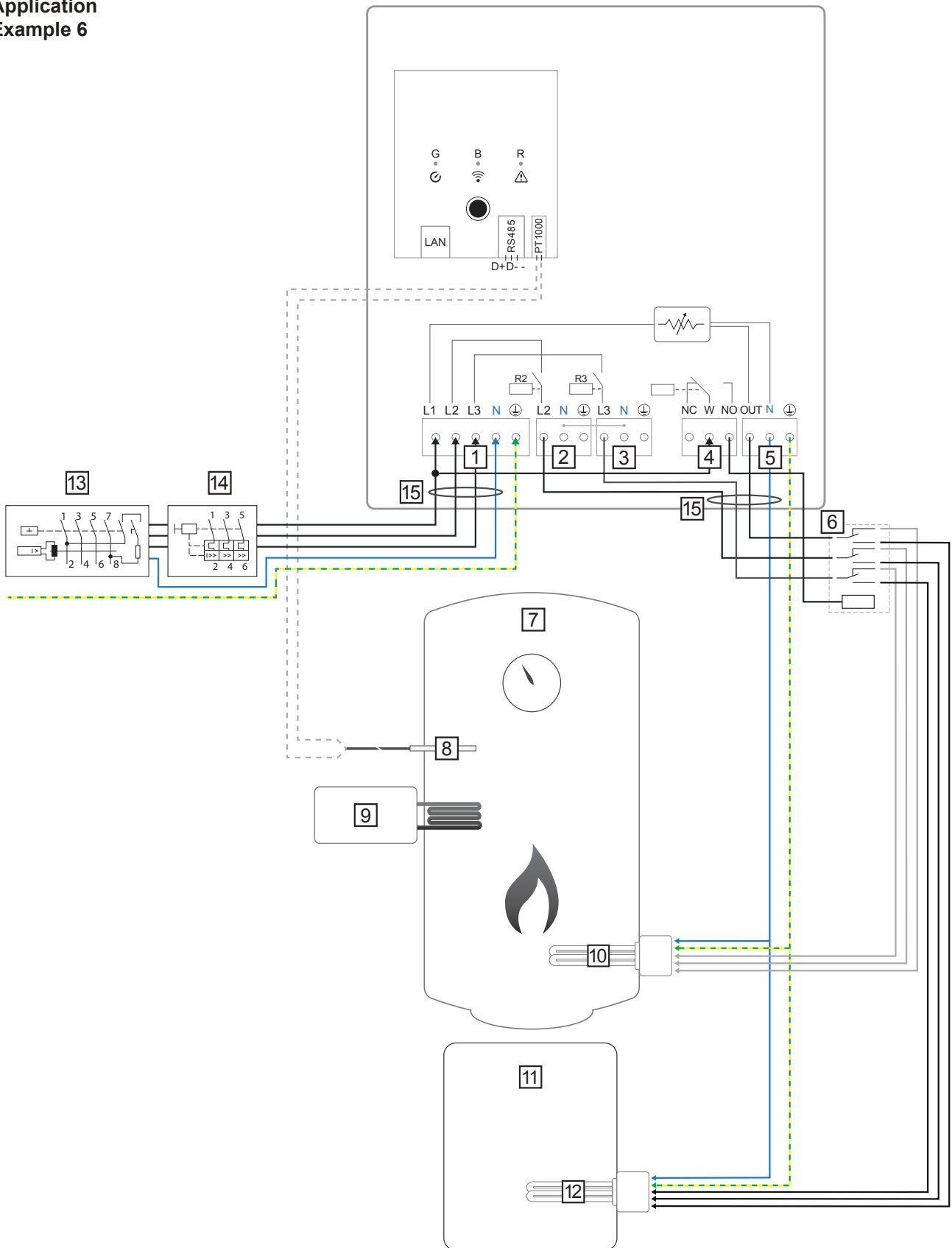

- | | |
|---|---|
| 1 INPUT - grid supply 3x 230 V
Spring balancer 1.5 - 2.5 mm ² | 8 PT1000 temperature sensor |
|  NOTE! Phase and neutral conductors must not be mixed up. Residual current-operated circuit breaker is triggered. | 9 External source (e.g. gas-fired heating) |
| 2 OUTPUT - L2 heating element | 10 Heating element 1 (max. 9 kW) |
| 3 OUTPUT - L3 heating element | 11 Buffer |
| 4 Multifunctional relay output | 12 Heating element 2 (max. 9 kW) |
| 5 OUTPUT up to 3 kW variable, max. 13 A resistive load
Spring balancer 1.5 - 2.5 mm ² | 13 Residual-current circuit breaker |
| 6 Contactor switching | 14 Circuit breaker max. B16A |
| 7 Hot water boiler | 15 Ferrite (included in delivery) |

Functional Description

Many heating systems consist of a boiler and a buffer, with the central heating supplying the buffer and a control system charging the hot water boiler via a pump. As with thermal photovoltaic systems, the Ohmpilot is also capable of heating the hot water boiler first and then the buffer, so that the maximum amount of photovoltaic surplus energy can be stored.

The Fronius Smart Meter records the current power at the feed-in point and transfers the data to the Datamanager. By controlling the Ohmpilot, the Datamanager adjusts any surplus energy that is available to zero. In detail, this takes place by continuously adjusting the heating element connected to the Ohmpilot.

For this application, two heating elements are installed, with preference being given to activation of the first heating element (10). Only once the maximum temperature in the boiler (7) has been reached is the second heating element (12) activated in a continuously variable manner, so that the remaining energy can, for example, be stored in a buffer.

If no temperature sensor is connected to the Ohmpilot, after 30 minutes the Ohmpilot attempts to output energy via the first heating element once again. If a temperature sensor is present, the device switches back to the first heating element as soon as a temperature difference of 8 °C is reached (compared to the temperature measured prior to switch-over).

This switching can also be used for layering in a boiler/buffer, so that the maximum temperature is reached in the top part of the boiler using minimal energy and the remaining energy is stored in the lower part of the boiler. By using layering in a storage tank, it is also possible to store significantly more energy, as a minimum temperature is normally maintained in the top part of the boiler. This means that the temperature difference and therefore the amount of energy is rather small. In the lower part of the boiler, a high temperature difference of, for example, 50 °C can be used.

The switching must be realised by an external contactor. If no temperature sensor is

installed, an external source (e.g. gas-fired heating) must ensure the minimum temperature.

As an alternative, the Ohmpilot can also ensure the minimum temperature. This may result in electricity being sourced from the grid.

The maximum temperature must be set on the heating element thermostat. If heating element 1 (10) does not have a thermostat, the Ohmpilot can also carry out this task as an alternative (see "Optional settings" section). However, it is imperative that heating element 2 (12) has a thermostat.



NOTE! At no point can both heating elements be heated simultaneously.

Fronius OHMPILOT GENERAL NETWORK EN

GENERAL SETTINGS

Designation

HEATER 1

Automatic Manual

Consumer Power (W)

Temperature sensor present

HEATER 2

Consumer Power (W)

Save

1. The section "Establishing the Data Connection" describes how you can access the Ohmpilot website.
2. Under HEATER 2, select "3-phase" as the load and the power of the load.

Establishing the Data Connection

Possible Communication Channels

The data connection is primarily required so that the inverter or Datamanager can share default values with the Ohmpilot. For some applications, however, it is also necessary to implement settings via the Ohmpilot website.

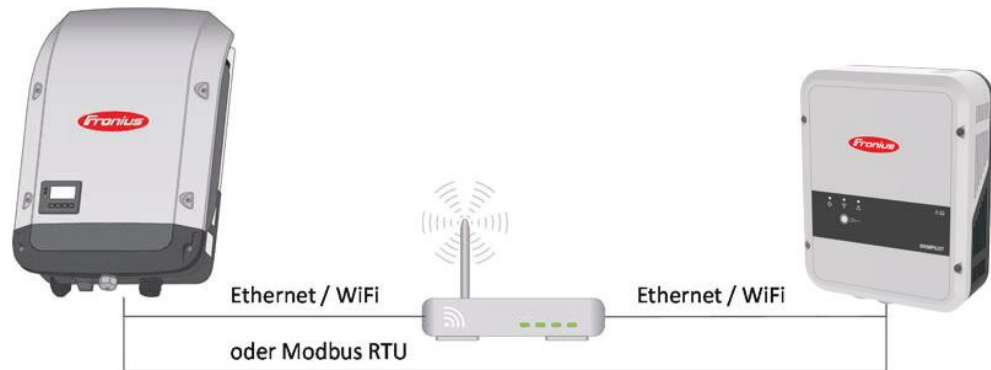

There are 3 possible communication channels:

- **Modbus RTU (via RS 485)**
- **LAN (Ethernet)**
- **WLAN**

 **NOTE!** The Datamanager 2.0 must have software version 3.8.1-x or a later version installed.

Establishing a Connection via Modbus RTU

1. Connect the bus cabling (B) to the Ohmpilot. (The bus cabling is carried out in parallel via the TX+, TX- and GND cables with the Fronius Smart Meter and the Fronius inverter or Datamanager 2.0).
2. Terminate the RS485 bus with a resistance at the first and last device. The resistance can be activated on the Ohmpilot using DIP switch number 5. See (A).
3. The Modbus address can be set using numbers 1-3.
Default address: 40
(For future applications, the Modbus address can be changed using the DIP switches on the Ohmpilot.)

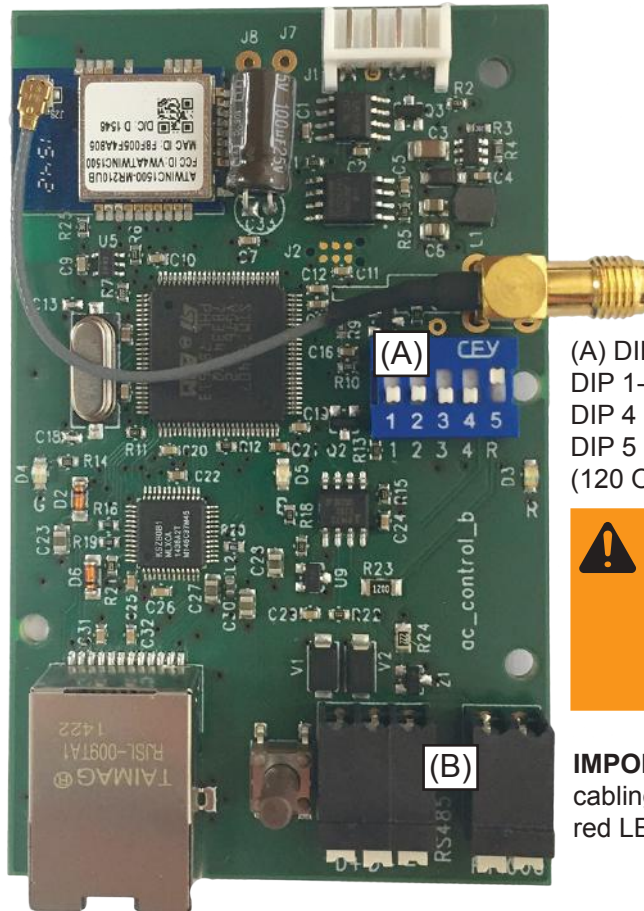

(A) DIP switches
 DIP 1-3 = Modbus address BCD
 DIP 4 = Reserve
 DIP 5 = Terminating resistance (120 Ohm)

WARNING! Use a data cable that is clearly distinguishable from the mains cable, so that there is no confusion and injury and damage to property are avoided.

IMPORTANT! In the case of incorrect cabling, this will be displayed by the red LED flashing 1x.

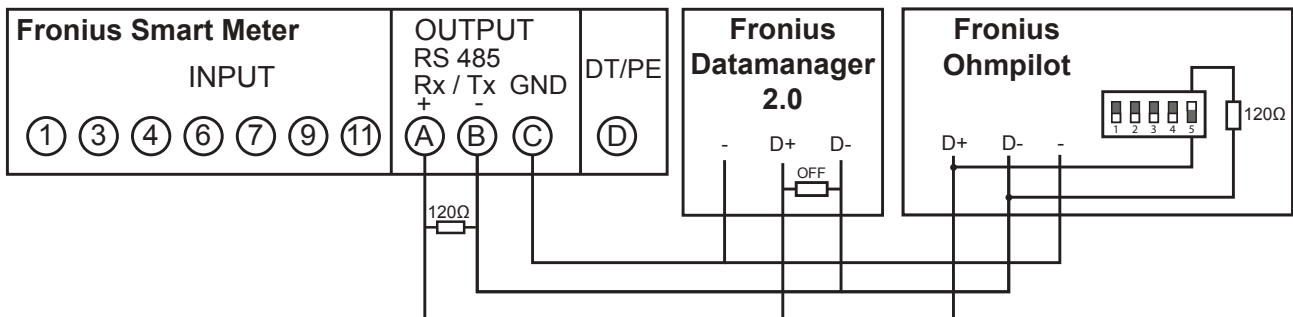

In order to implement various settings, the WLAN connection must briefly be opened as follows

1. Press the button on the Ohmpilot 2x. The blue LED flashes (twice) for as long as the WLAN access point is active (30 minutes). Before the access point is opened, a search for available WLAN networks is carried out.
2. Activate the "Ohmpilot" WLAN network on your smart device or PC.
3. Enter the website <http://192.168.250.181> or <http://ohmpilotW.local> in the browser. Alternatively, the Fronius Solar.web app can also be used to search for the Ohmpilot in the network.



NOTE! In networks with a DNS suffix, the Ohmpilot can be reached at <http://ohmpilotW.<DNS-Suffix>>. E.g. <http://ohmpilotW.fronius.com>

4. Implement the settings.

Establishing a Connection via LAN

As standard, the Ohmpilot obtains its IP address automatically from the DHCP server, meaning that no settings are generally necessary.

The inverter automatically searches for the Ohmpilot, with the search process taking up to 5 minutes. If the red LED is unlit and the green LED is flashing, the Ohmpilot is working correctly.

A static IP address can be assigned to the Ohmpilot via the web interface.

The screenshot shows the 'SET UP NETWORK' page in the Ohmpilot web interface. At the top, there is a navigation bar with the Fronius logo, 'OHMPILOT', 'GENERAL', 'NETWORK', and 'EN'. The 'NETWORK' tab is active. Below the navigation bar, there are two radio buttons: 'LAN' (selected) and 'WLAN'. Under the 'LAN' section, there are four fields: 'Get address' (with 'Static' selected and 'Dynamic' unselected), 'IP address' (192.168.1.16), 'Subnet mask' (255.255.255.0), and 'Gateway' (192.168.1.1). A red 'Save' button is located at the bottom left. A large, faint Wi-Fi symbol is visible in the background on the right side of the page.

1. Open the website <http://ohmpilotL.local>. Alternatively, the IP address assigned by the DHCP server can also be read off. Almost every router displays the devices connected to it (its clients) on its web interface. Apps such as Fing can also help to find the IP address that has been assigned automatically. Alternatively, the Fronius Solar.web app can also be used to search for the Ohmpilot in the network.



NOTE! In networks with a DNS suffix, the Ohmpilot can be reached at <http://ohmpilotL.<DNS suffix>>. E.g. <http://ohmpilotL.fronius.com>

In order to configure the IP address manually, the "static" option must be selected. Then enter the IP address required.

The Ohmpilot can then be reached at <http://ohmpilotL.local> or at the fixed IP address assigned.

Establishing a Connection via WLAN

There are two options for connecting the Ohmpilot to an existing WLAN network:

Connecting via WPS (WiFi Protected Setup)

1. Press the button on the Ohmpilot 1x. The blue LED flashes (once) for as long as the WPS is active.
2. Press the WPS button on the router within 2 minutes.
3. If the blue LED on the Ohmpilot is now lit steadily, the connection to the network was successful.
4. The inverter automatically searches for the Ohmpilot, with the search process taking up to 5 minutes. If the red LED is unlit and the green LED is flashing, the Ohmpilot is working correctly.

The screenshot shows the 'SET UP NETWORK' interface. The 'WLAN' tab is active. A search box displays 'WLAN_01==> Signal: -50, sec:wpa'. The 'Dynamic' radio button is selected. The IP address field is set to '0.0.0.0'. A red 'Save & Connect' button is visible at the bottom.

Connecting via access point and manual configuration of the WLAN Settings

1. Press the button on the Ohmpilot 2x. The blue LED flashes (twice) for as long as the WLAN access point is active (30 minutes). Before the access point is opened, a search for available WLAN networks is carried out.
2. Activate the "Ohmpilot" WLAN network on your smart device or PC.
3. Enter the website <http://192.168.250.181> or <http://ohmpilotW.local> in the browser. Alternatively, the Fronius Solar.web app can also be used to search for the Ohmpilot in the network.
4. Select the required network in the WLAN network tab.



NOTE! If the required WLAN network is not listed, end access point mode by pressing the button again and repeat the process.

5. Click "Save & Connect", and enter the WLAN password.
6. If the blue LED on the Ohmpilot is now lit steadily, the connection to the network was successful.
7. The inverter automatically searches for the Ohmpilot, with the search process taking up to 5 minutes. If the red LED is unlit and the green LED is flashing, the Ohmpilot is working correctly.

IMPORTANT! When the access point is opened, it is not possible to scan the WLAN networks.

A static IP address can be assigned to the Ohmpilot via the web interface.

The Ohmpilot can then be reached at <http://ohmpilotW.local> or at the fixed IP address assigned. Alternatively, the Fronius Solar.web app can also be used to search for the Ohmpilot in the network.



NOTE! Only one device can connect to the Ohmpilot.



NOTE! In networks with a DNS suffix, the Ohmpilot can be reached at [http://ohmpilotW.<DNS- Suffix>](http://ohmpilotW.<DNS-Suffix>). E.g. <http://ohmpilotW.fronius.com>

Status Indication on Web Interface

The screenshot shows the Fronius Ohmpilot web interface. At the top, there are navigation tabs: OHMPILOT, GENERAL, NETWORK, and EN. Below the navigation, there are three main status indicators: 'OK' for STATUS, '26.7 °C' for TEMPERATURE, and '0 W' for HEATING OUTPUT. Below these, there are three error indicators: 'HEATER 2' with a red 'X' icon, 'HEATING ELEMENT L2' with a red 'X' icon, and 'HEATING ELEMENT L3' with a red 'X' icon. On the left side, there is a list of system details including MODEL, SERIAL NUMBER, SOFTWARE VERSION, PCB VERSION CONTR., PCB VERSION CHOP, BOOTLOADER, COPROCESSOR BOOTLDR, COPROCESSOR, WIFI VERSION, LAN IP ADDRESS, LAN SUBNET MASK, LAN MAC ADDRESS, WLAN IP ADDRESS, WLAN MAC ADDRESS, RS485 ADDRESS, PAIRING, TIME, and CONTROLLER OUTPUT. On the right side, there is an image of the Ohmpilot device.

Status

OK	Ohmpilot is operating in normal mode.
TARGET TEMPERATURE	Temperature has fallen below the minimum. Heater 1 is heating at 100%.
LEGIONELLA PREVENTION	Legionella heating is active. Heater 1 is heating at 100%.
BOOST	The Ohmpilot has been switched to boost mode manually. Heater 1 is heating at 100%.
ERROR	An error has been detected. More information should be read off from Solar Web.

Temperature Current measured temperature. A valid value is only displayed when a temperature sensor is connected.

Heat output Current power being used by the Ohmpilot.

Heater 2 Heater 2 is active. Heater 2 may be a second heating element, a heat pump or an external source (e.g. gas-fired heating).

L2 heating element Phase 2 of 3-phase heating element is active.

L3 heating element Phase 3 of 3-phase heating element is active.

Optional Settings

IMPORTANT! The settings described here can be implemented for all of the application examples detailed above. If they are not described for the relevant example, they are not vital.

The screenshot shows the 'GENERAL SETTINGS' page for the 'Ohmpilot' device. The 'HEATER 1' section is active, showing the following settings:

- Designation: Ohmpilot
- HEATER 1 Mode: Manual
- Measure heating element: [Refresh]
- Consumer: Three-phase
- Power (W): 3000
- Temperature sensor present:
- Adapt day curve:
- Legionella prevention (h): 168
- Maximum temperature: 60 °C
- Time from: 05:00, 16:00, 18:00, 03:00 (all checked)
- Target temperature: 10 °C, 45 °C, 10 °C, 45 °C

Manual Settings HEATER 1

You can also set the power of HEATER 1 manually.

1. To do this, select the "manual" field.
2. Select whether it is a 1-phase or 3-phase load.
3. Enter the power of the load in Watts.



NOTE! In the case of applications with a 1-phase and a 3-phase heating element, it is not possible for the Ohmpilot to measure heating element 1 automatically due to the cabling. In this case, the configuration must be carried out manually.

Activating Legionella Prevention

When the legionella prevention system is activated, the hot water is heated to 60 °C at a set interval.

1. Highlight the field "Temperature sensor present"
2. Highlight the field "Legionella prevention (h)"
3. Enter the cycle for the legionella prevention.



NOTE! If the boiler is operated at a temperature <60 °C for a relatively long period of time and no hygienic storage tank is being used, measures must be taken to kill the legionella bacteria. For private use, it is recommended to implement legionella prevention at least once a week (168 hours). In the case of a large hot water storage tank and/or a comparatively low consumption of hot water, legionella prevention should be carried out regularly. A PT1000 temperature sensor is required for this function and can be sourced from Fronius under item number 43,0001,1188.



WARNING! No guaranteed legionella prevention.

Adapting the Day Curve

This function ensures that a required temperature is not undercut. If there is not sufficient surplus power available, the external source will be started up, if activated, or otherwise electricity will be drawn from the grid in order to ensure a minimum temperature.

Up to four time periods can be defined so that, for example, higher hot water temperatures are only certain to be available at night, but more potential is possible for the surplus during the day due to the fact that a lower target temperature is selected.

1. Highlight the field "Temperature sensor present"
2. Highlight the field "Adapt day curve"
3. Under "Time from", enter the time from which the Ohmpilot should start to heat to the new target temperature. This target temperature is valid until the next entry.



NOTE! One entry is valid for the whole day.

4. Under "Target temperature", enter the required final temperature.



NOTE! If heater 1 is the primary heat source, the day curve must in all cases be adapted to ensure the required minimum temperature. A PT1000 temperature sensor is required for this function and can be sourced from Fronius under item number 43,0001,1188. The position of the temperature sensor in the boiler should be chosen so that sufficient hot water is available. However, it must in all cases be installed above the heating element/external source.

Example:

05:00 10°C=> After showers, the hot water will only be produced with surplus energy

16:00 45°C=> If there was not sufficient excess energy, the water will be heated

18:00 10°C=> After showers, no more heating should occur, thus minimizing heating losses

03:00 45°C=> Water will be warmed so that it is ready for showers at 6am

Temperature Limitation

If heater 1 does not have a configurable thermostat, this function can be used to limit the temperature.

1. Highlight the field "Temperature sensor present"
2. Highlight the field "Temperature limitation"
3. Enter the maximum temperature (e.g. 60 °C).



NOTE! This function is only possible for heater 1. If a second heating element is in use as heater 2, this must have a thermostat. A PT1000 temperature sensor is required for this function and can be sourced from Fronius under item number 43,0001,1188. The temperature sensor should be installed just above the heating element, so that the cold water flowing in is immediately heated up again and the maximum storage amount is therefore used.

Error List:

Sending of Errors

- Errors are saved in the Datamanager 2.0 and can be sent via Solar Web.
- Possible error outputs (as of 07/12/2015):

Code	Description	Cause	Solution
906	Heating element 1 faulty - short circuit L1	The load on L1 is higher than 3 kW. Short circuit on L1.	Check heating element 1. Check wiring.
907	HE 1 - overload on L2	Current on L2 is greater than 16 A.	Check HE 1 and replace if necessary.
908	HE 1 - overload on L3	Current on L3 is greater than 16 A.	
909	HE 1 faulty - L1 highly resistive	No current flowing through L1/L2/L3. L1/L2/L3 of HE 1 faulty. Phase L1/L2/L3 interrupted.	Check L1/L2/L3. Check L1/L2/L3 connections.
910	HE 1 faulty - L2 highly resistive		
911	HE 1 faulty - L3 highly resistive		
912	HE 2 faulty - short circuit L1	The load on L1 is higher than 3 kW. Short circuit on L1.	Check HE 2. Check wiring.
913	HE 2 - overload on L2	Current on L2 greater than 16 A.	Check HE2 and replace if necessary.
914	HE 2 - overload on L3	Current on L3 greater than 16 A.	
915	HE 2 faulty - L1 highly resistive	No current flowing through L1/L2/L3. L1/L2/L3 of HE 2 faulty. Phase L1/L2/L3 interrupted.	Check L1/L2/L3. Check L1/L2/L3 connections.
916	HE 2 faulty - L2 highly resistive		
917	HE 2 faulty - L3 highly resistive		
918	Relay 2 faulty	Relay R2/R3 sticking.	Replace Ohmpilot.
919	Relay 3 faulty		
920	TS short circuit	TS input resistance less than 200 Ohm. No PT1000 TS connected. TS faulty.	Check cable and connections on TS cable. Replace TS.
921	TS not connected or faulty	No TS connected (Input resistance greater than 2000 Ohm). TS is activated (should be deactivated). TS cable faulty. TS faulty. No PT1000 TS connected.	Connect TS to device. Deactivate TS via the website (if no sensor is required). Check TS cable. Replace TS.
922	60 °C for legionella prevention could not be achieved within 24 hours.	ES is switched off/faulty. (922 only). TS was incorrectly installed. Heating system is incorrectly dimensioned (excessive hot water consumption, etc.) HE/TS faulty.	Switch on ES (922 only). Install TS above the HE (in protective tube). Deactivate legionella prevention via the website. Replace HE/TS.
923	Target temperature could not be achieved within 5 hours		
924	ES could not achieve target temperature within 5 hours.	ES switched off/faulty. ES not connected to Ohmpilot. TS incorrectly installed. Heating system incorrectly dimensioned (excessive hot water consumption, etc.) TS faulty.	Switch on ES. Connect ES to relay 1. Install TS above the heat battery of the ES. Check the target temperature setting. Replace TS.

HE=Heating element TS=Temperature sensor I=Inverter ES=External source (e.g. gas-fired heating)

Code	Description	Cause	Solution
925	Time not synchronised	Time not synchronised in the last 24 hours. Router has been switched off/reconfigured.	Check connection between Ohmpilot and inverter. Switch on router. Check network settings.
926	No connection to inverter	No connection between inverter and Ohmpilot. Inverter switched off. Even at night, the Ohmpilot needs a connection to the inverter. Router switched off/faulty/reconfigured. Night switch-off function on the inverter activated. Poor WLAN connection from the inverter or Ohmpilot to the router.	Check connection. Switch on inverter. Update software. Switch Ohmpilot and inverter off and on again. The night switch-off function of the inverter must be disabled. On the display of the inverter, open the "SETUP/Display settings/Night mode" menu, set the night mode to ON. Switch on the router. Position the WLAN antenna better. Check the network settings.
927	Ohmpilot overtemperature	Ambient temperature too high (>40 °C). Heating element has too much power. Ventilation slots covered.	Install Ohmpilot in a cooler location. Use heating element with more reliable power. Uncover ventilation slots.
928	Ohmpilot undertemperature	Ambient temperature too low (<0 °C).	Install Ohmpilot in a warmer location. Installation outdoors is not permitted!
	Residual current-operated circuit breaker is triggered	N and L mixed up.	Connect N and L correctly.
	Ohmpilot is not using any surplus	Thermostat on the heating element has switched off. Safety thermostat (STC) on the heating element has been triggered.	Wait until the thermostat switches on again. Reset the safety thermostat.
	Ohmpilot is using only part of the surplus power	Heating element power is lower than surplus power.	Select a larger heating element where necessary.
	Power at the feed-in point is not always adjusted to 0	Load and generation fluctuations require a few seconds to settle down.	
	After switch-on, the green LED makes 2 long flashes	Thermostat on heating element has switched off. Heating element is not connected	Briefly turn up the thermostat for the power measurement. Connect the heating element.

HE=Heating element TS=Temperature sensor I=Inverter ES=External source (e.g. gas-fired heating)

Warranty Terms and Conditions, and Disposal

Fronius Manufacturer's Warranty

Detailed, country-specific warranty terms are available on the internet:
www.fronius.com/solar/warranty

Disposal

If you decide in the future to replace your Ohmpilot, Fronius will take back the old device and arrange for it to be recycled in an appropriate manner.

Applicable Standards and Guidelines

CE mark

The devices comply with all the requisite and relevant standards and guidelines that form part of the relevant EU Directive, and are therefore permitted to display the CE mark.

Technical Data

Input Data	Frequency	50 Hz
	Nominal voltage	230 V / 400 V
	Max. input current	1 X 16 A / 3 x 16 A

Interfaces	Modbus RTU	RS 485, max. 1000 m, screened and twisted
	LAN	Ethernet at least CAT5, screened
	WLAN	IEEE 802.11 b/g/n
	Temperature sensor	PT1000 (max. 30 m)

Output Data	Analogue out 1-phase/3-phase	Continuously variable 0 - 3 / 0 - 9 kW
	Analogue nominal voltage per phase	13 A
	Analogue out short circuit current	16 A (max. 5 seconds)
	Relay out max. current	L2 / L3 16 A (max. 5 seconds)
	Multifunctional relay out	min. 15 V / 2 mA; max. 16 A (max. 5 seconds)
	Efficiency during rated operation	at least 98%
	Consumption during standby	typically 1.8 W

General Data	Dimensions (height x width x depth)	340 mm x 270 mm x 123 mm
	Weight	3.9 kg
	Degree of protection	IP54
	Mounting	Wall
	Ambient temperature range	0 to 40 °C
	Permitted humidity	0%-99% (non-condensing)
	Cooling	Convection
	Storage temperature	-40 to 70 °C
	EMC device class	B
	Overvoltage category	3
Pollution level	3	

Inspection / Specifications

Inspection / Specifications according to EN60730 Section 1 Table 7.2

6a	Construction	Electronic RS 2.5.5 independently mounted RS
19	Screwless Terminal	2.10.6.1 mounting method type Y
24	RS Classification, to Protect Against Electric Shock Section 6.8	Protection class I 6.8.3
29	Type of Disconnection or Interruption for Each Circuit	Micro interruption according to 2.4.4.
30	PTI-Value of the Insulation Material Used for Insulation	PTI 175 according 6.13.2
31a	Protective Earth Connection Type	N according to 7.4.3, earth connection according to 9.1.1 
39	Mode of Operation	Mode of operation TYPE 1 according to 2.6.1
40	Additional Features of Mode of Operation	C according to 6.4.3.3
51	Heat Filament Test Temperatures (Sections 21.2.1, 21.2.2, 21.2.3 and 21.2.4)	Casing 550°C, the cable bushing / strain relief 650°C; Category B according to EN 60730-1:2000/A1:2004;
75	Rated Impulse Voltage (Section 2.1.12, 20.1)	According to EN 61000-6-2:2005, EN 60730-1:2011, EN 301 489-1 (V1.9.2) Wire to wire Cable(s) to earth Signal and control wires: --- ± 1 kV DC power inputs: ± 0.5 kV ± 0.5 kV AC power inputs: ± 1 kV ± 2 kV
77	Ball Pressure Test Temperature	According to 21.2.1, 21.2.2, 21.2.3 and 21.2.4, Casing: Ball pressure test 1: 102 °C Cable bushing: Ball pressure test 2: 125 °C
78	Maximum Specified Torque for Single-Bush Mounting with a Thermoplastic Material (Table 20, Note 1)	max. 3Nm
80	Rated Impulse Voltage for Creepage and Clearance Distances	According to EN 61000-6-2:2005, EN 60730-1:2011, EN 301 489-1 (V1.9.2) Wire to wire cable(s) to earth Signal and control wires: --- ± 1 kV DC power inputs: ± 0.5 kV ± 0.5 kV AC power inputs: ± 1 kV ± 2 kV

Fronius Worldwide - www.fronius.com/addresses

Fronius International GmbH
4600 Wels, Froniusplatz 1, Austria
E-mail: pv-sales@fronius.com
<http://www.fronius.com>

Fronius USA LLC Solar Electronics Division
6797 Fronius Drive, Portage, IN 46368
E-mail: pv-us@fronius.com
<http://www.fronius-usa.com>

The addresses of all our sales branches and partner companies can be found at <http://www.fronius.com/addresses>.