

Presence detector for 230 VAC - PDK65 (kit with power supply)

Installation instructions

WARNING!



The installation of this product requires working with high-voltage and may only be carried out by a qualified electrician. The power must be isolated prior to installation and opening of the product.

- This product may only be installed using phase circuit breakers of the following types:
 - Automatic circuit breaker 10B.
 - Automatic circuit breaker 10C.
 - Safety fuse 10A gG.
- Contactors may not be connected to the power supply without the jumper "Direct/Ext.Cont" being set to "Ext. Cont".
- See detailed description in the manual prior to installation.
- Only use this product for its intended purpose (see manual).
- The product should be checked for any damage immediately after unpacking.
- Should any damage to the product be discovered, do not proceed with installation under any circumstances whatsoever.
- Cabling may not be laid under the circuit board under any circumstances.

If for any reason there is suspicion that safe use of the product cannot be guaranteed, power to the product must immediately be switched off. It must be ensured that switching on power to the product cannot be activated unintentionally.

The **PDK65** has shared mounting, which means that the detector can easily be connected with a low voltage cable and positioned for optimum detection.

The **detector** is a passive infrared detector with high sensitivity (passive IR sensor) for presence detection. It has interchangeable lenses which allows you to adapt the detection range.

The **power supply** is specially adapted for shared mounting and intended to power the presence detector. The system is intended for the control of lighting fixtures on the output side in communal laundries, offices, corridors, waste rooms and bicycle storage rooms. See technical specifications for switching power.

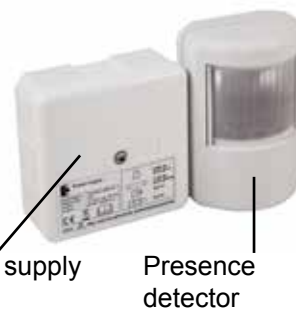

The **power supply** can generally replace the terminal box housed in the existing junction point between phase in/out and the power switch in which case it is not necessary to install an extra power cable. This functions as power supply, output relay and simple logic module all in one. An external switch for manual on/off can be connected. The power supply also has a connection for earth protection.

Introduction

PDK65 is a complete system with easy installation to control presence detection in smaller premises.

PDK65 consists of:

- Power supply
- Presence detector
- 3 m cable between module and detector.

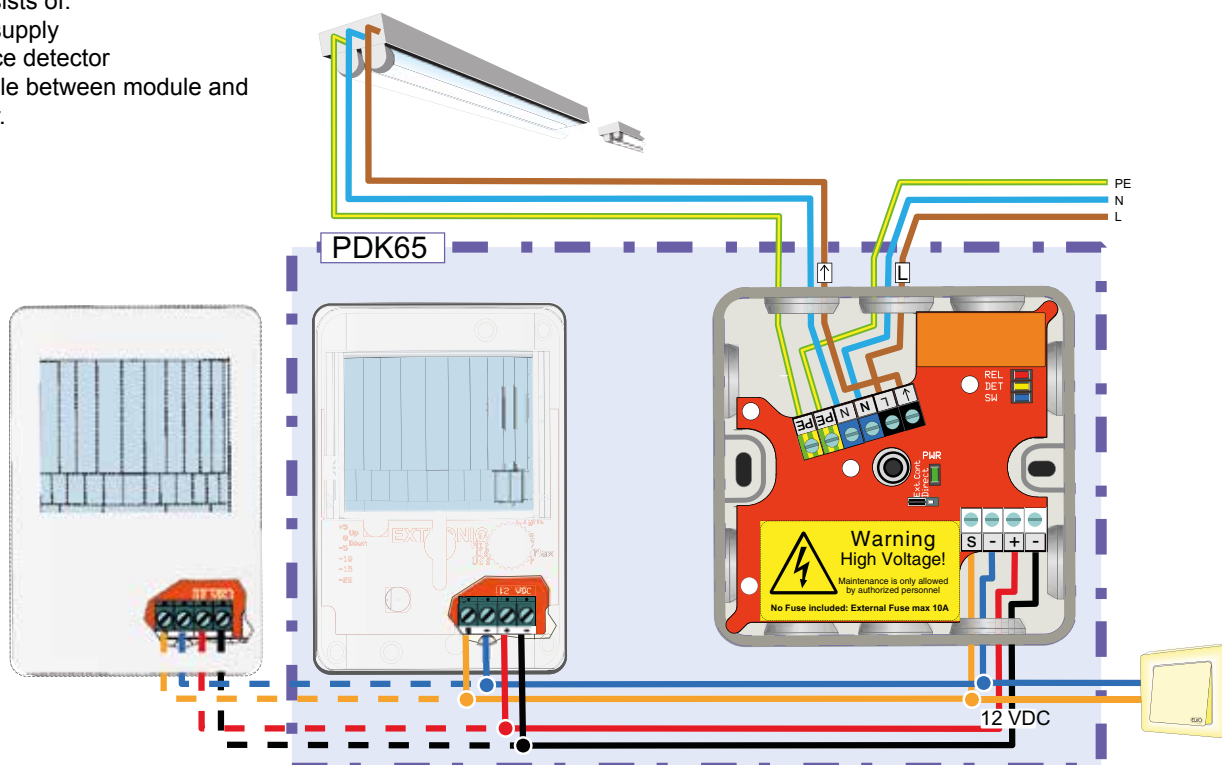

IR detector

The **detector** is a passive infrared detector (passive IR sensor) intended for presence detection. Several IR sensors can be connected to the same power supply. The detector has a highly sensitive pyroelectric sensor which determines changes in heat radiation. The electronics and software in the detector microprocessor are specially designed for presence detection.



The detector is intended for shared mounting together with the **power supply**.

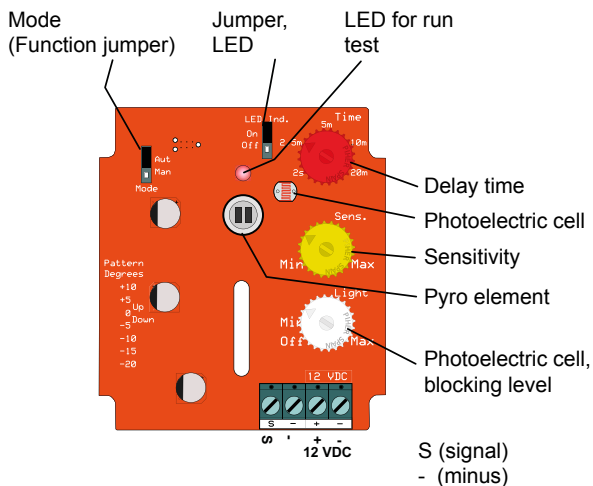

Circuit board in presence detector

Function "Mode" jumper

The Aut/Man jumper to be in Aut mode.
 "Man" mode: Manual switching on at all times.
 Auto mode: Automatic switching on at all times.

Photoelectric cell automation

The potentiometer for the photoelectric cell's blocking level is to be in min/off mode.

Note! If using an external switch, the presence detector can also be controlled manually.

Power supply

Up to five detectors can be connected to the power supply and operate simultaneously. External switches can be connected for switching on and off.

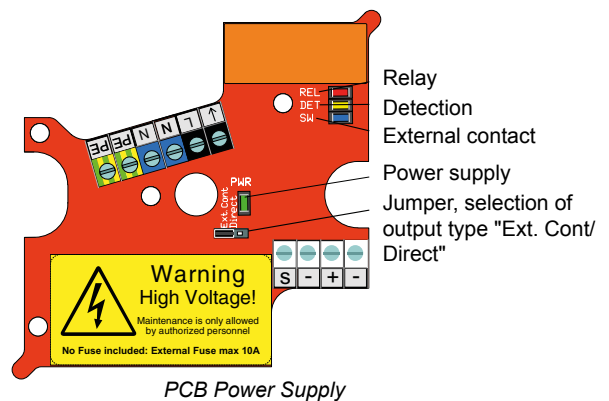

PCB Power Supply

LED indicators (in the power supply)

PWR (green) Power supply

Steady glow = Full output (= 12 V).
 Rapid flashing = Output under 9 V (under-voltage).
 Double flash = Short-circuit 12 V output.
 Slow flashing = Relay control without zero throughput detection (see technical specifications).
 Off = No 230 VAC feed.

DET (yellow) Detection

Steady glow = Detection with automatic power on (Detect).
 Flashing = Check automation settings for photoelectric cell.

SW (Blue) External switch

Steady glow = External connection, connection block S and -.
 Double flash = Brief connection, connection block S and -; operation 3 minutes.

RELAY (Red)

Steady glow = Relay connected.
 Double flash = Check settings for jumper functions.

Jumper

Direct/Ext.Cont

Jumper for selecting output type. For delivery, this is always set to Direct mode, which means that the load to be controlled should be connected directly to the power supply. If one or more contactors should be connected to the power supply to control the load, the jumper must be moved to Ext. Cont.

Note!

Output type "Direct": The load turns on and off the zero-voltage alternating voltage to reduce wear on the built-in relay and the devices controlled.

Output type Ext.Cont: If a control device such as a contactor is connected after the power supply, an unknown component will be introduced and the product will not function as intended. In the worst case scenario reoccurrence at peak voltage after each activation can lead to abnormal wear on both contactors and devices.

Therefore "Ext.Cont" mode should be used when connecting external contactors. The synchronization of the switches to the neutral voltage of the switching voltage is then deactivated and occurs randomly.

Functional and function diagram

Function diagrams apply.

Green = input signal or internal signal

Red = output signal active.

Automatic power on

When the jumper on the detector is in "Auto", the detector sends the signal "Detect" (2.7 V). The output relay in the power supply then follows the input physical function.

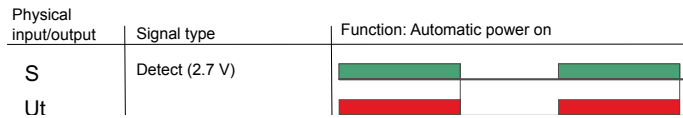

Internal timer function

The unit can be briefly activated or deactivated (3 mins) with an externally connected toggle switch.

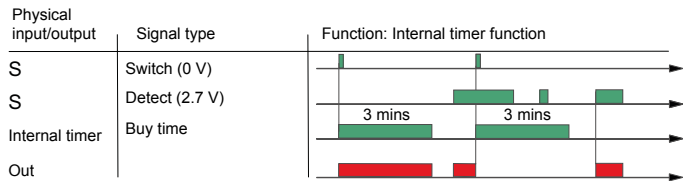

Toggle

If the "Detect" signal is constantly active at the input (can also be obtained by connecting a 1.5k resistance Ω), the output will change the status of each "Switch pulse" (externally connected toggle switch).

Note that in that case there will be no automatic power down.

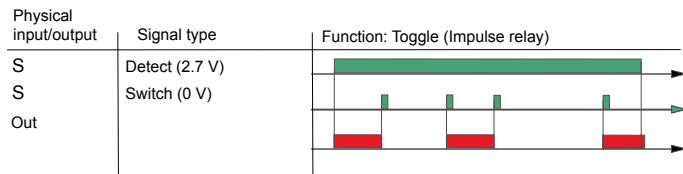

S-input

The **S-input** detects four different voltage levels (signal types):

- **A. Open = No detection.**

Voltage **over 7 V**.

-
-
-
-
-

- **B. Detect =**
 - Detection that results in direct power up.
- Voltage = **2.7 V**
(detector in Aut mode).

- **C. Switch = Closed**
 - input, generated by an external switch.
- Voltage = **0 V**.

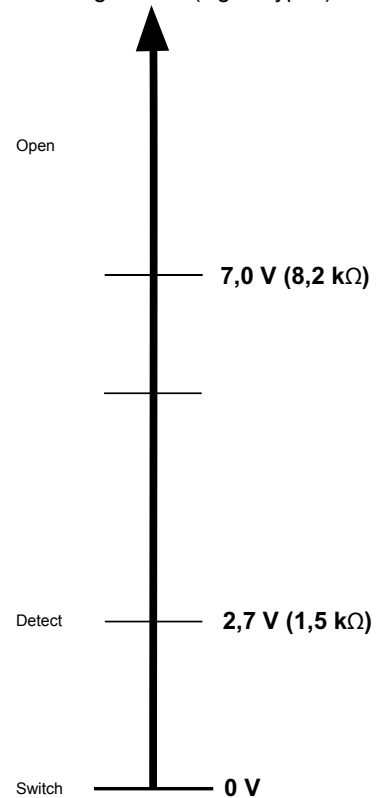

Internal timer function: The detector must detect presence within three minutes for the unit to remain active after being activated. The function is always active.

Technical specifications for Power supply

Voltage:	230 VAC.
Frequency:	50/60 Hz.
Units power consumption:	Nominal: 1 W. Max. 5 W.
Load:	10 A at 230 VAC, $\cos \varphi = 1$. 5 A at 230 VAC, $\cos \varphi = 0.5$.
Error indication:	The PWR LED flashes slowly as the output type: Ext.Cont (External contactor) is selected or the sinusoidal curve is not detected correctly with power up or down of the relay.
Reset:	Reset to the correct power up or down or at feed reset.
Ambient temperature:	- 25 to + 45 °C.
Protection class:	Protection class 1. The product complies with protection class 1 as it connects to protective earth for earthing of the units it controls. Protection class 2. Should protective earth not be required for the connected units, the product will then comply with protection class 2 and therefore there will be no requirement to connect protective earth to the product. However, protective earth may be connected even if it is not diverted.
Housing:	IP65.
Dimensions (W x H x D):	88 x 88 x 39 mm.

Main office

Frico AB
Box 102
SE-433 22 Partille
Sweden

Tel: +46 31 336 86 00
mailto:mailbox@frico.se
www.frico.se

For latest updated information and information about your local contact: www.frico.se

