



## ECONCEPT TECH

Wall-hung gas-fired condensing boiler for central heating and instant hot water production ready for solar panel systems





**ECONCEPT TECH** is the product that FERROLI has developed with the aim of satisfying the latest and strictest limits on energy consumption laid down by recent standards.

The heat generator has been designed to ensure maximum efficiency energy and performance both in central heating mode and in the delivery of domestic hot water, putting it at the top of its category.

Despite being a technologically advanced heat generator, **ECONCEPT TECH** maintains all the characteristics of simplicity and rational construction that distinguish Ferrolì products.

**ECONCEPT TECH** is a room-sealed and forced draught boiler for central heating and the instant production of domestic hot water.

By using a premix air/gas supply system and a ceramic burner with reverse micro-flame, the appliance comes into class 5 as regards NOx emissions.

The **ECONCEPT TECH** features the maximum efficiency in its category. It in fact has a 4 star rating according to Directive 92/42 EEC on energy classification.



## The range

is made up of 4 models, both operating on either natural gas or LPG:

- 25A** Heat input 25,2 kW
- 25C** Heat input 25,2 kW  
15,2 l/min domestic hot water at  $\Delta t$  25°C
- 35A** Heat input 34,8 kW
- 35C** Heat input 34,8 kW  
19,6 l/min domestic hot water at  $\Delta t$  25°C

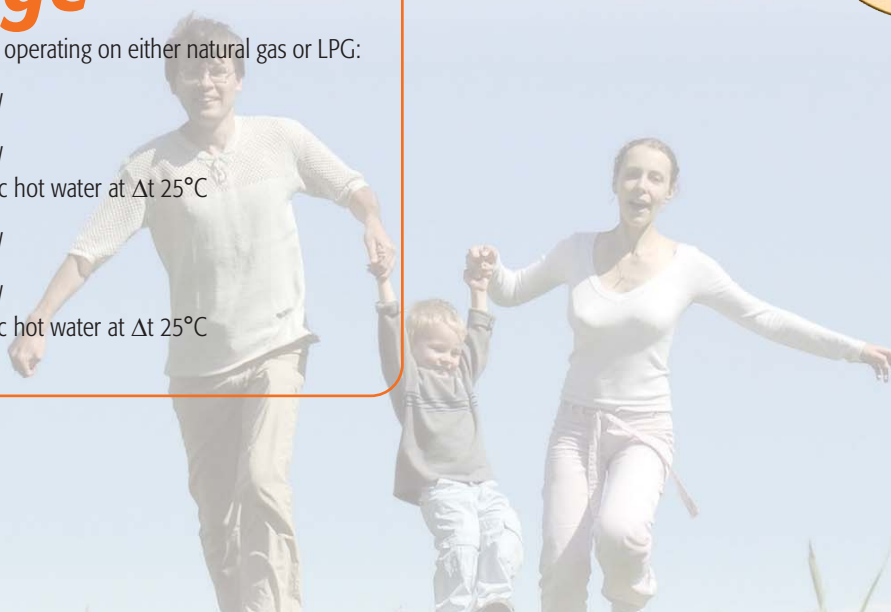

Designed using advanced technology and exploiting the FERROLI history and tradition in the heating sector, the appliances are built in ultra-modern facilities that apply a certified quality management system in compliance with the UNI EN ISO 9001:2000 standards. The **ECONCEPT TECH** boilers are CE approved, which for the user is a synonym of safety and reliability.

# Components

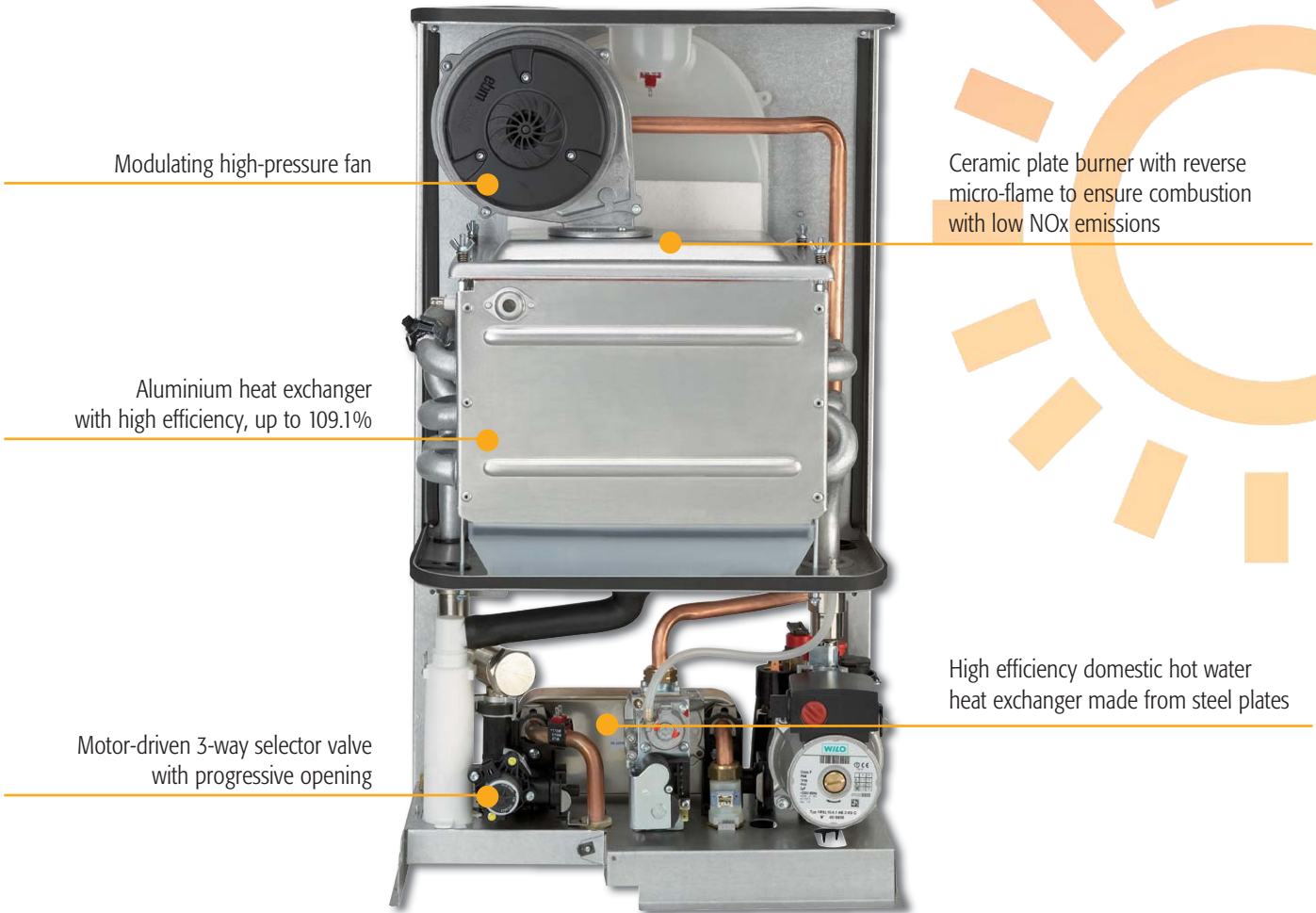
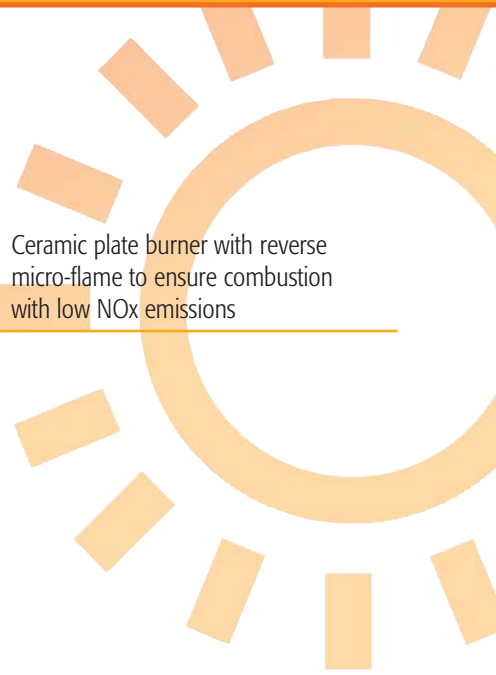

## REMOTE TIMER CONTROL

The "ROMEO" REMOTE TIMER CONTROL available as an accessory can be used to start and control the boiler from a distance, with the convenience of not having to go outside and open the door on the cabinet. ROMEO can be used to set the room temperature and the weekly program for both the ambient comfort conditions and domestic hot water delivery.

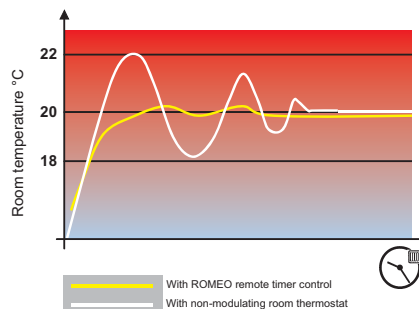
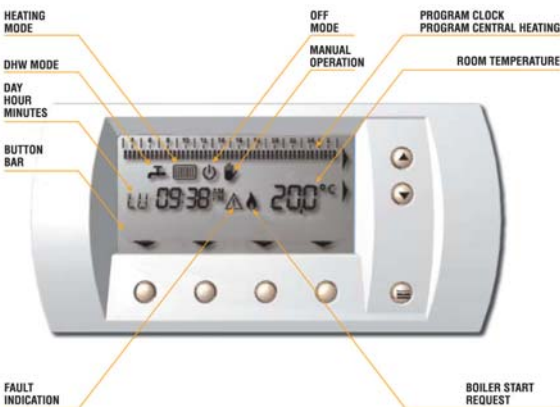

- Weekly CENTRAL HEATING timer with: 3 daily room temperature levels; minimum programming interval 30 minutes; 5 predefined programs; possibility of MANUAL operation; ambient frost protection always active.
- Weekly DOMESTIC HOT WATER timer with 2 types of operation: ECO/COMFORT; minimum programming interval 30 minutes; 2 predefined programs.



# With solar heating systems...

**ECONCEPT TECH** has been designed to be easily integrated into systems developed using the latest technology. The boiler in fact features electronics that simplify the combined use with solar panels, with both natural and forced circulation. A sensor installed in the domestic hot water circuit continuously monitors the temperature of the water coming from the solar panels, igniting the burner only when the water temperature falls below the level required to guarantee optimum comfort for the user.

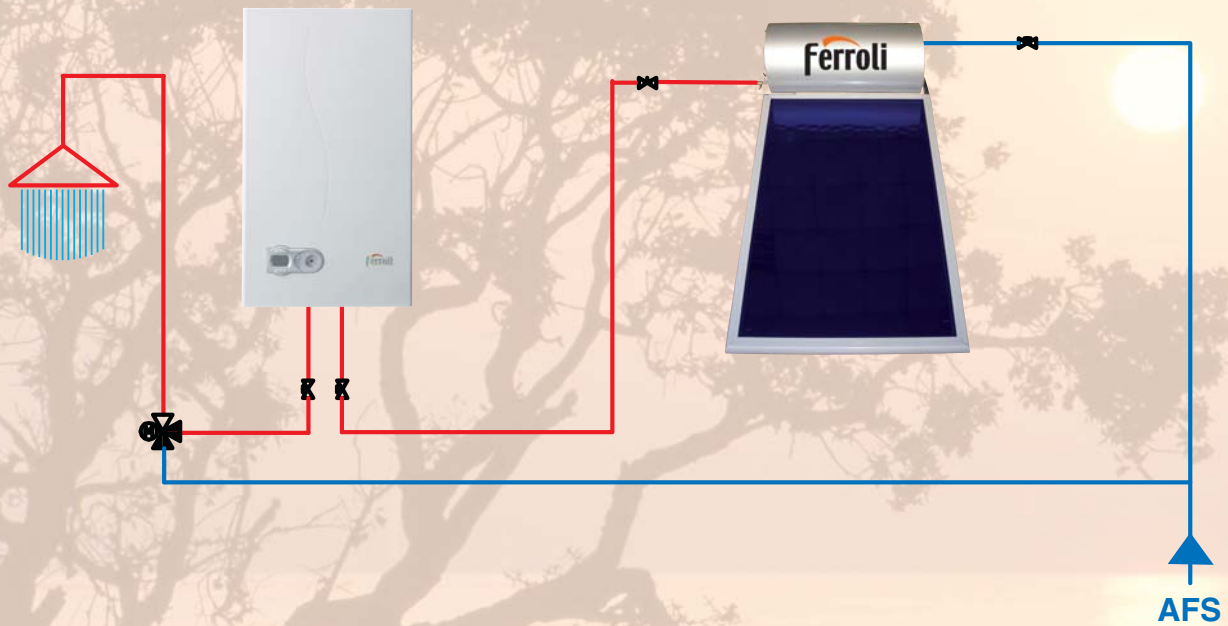

## Functions...



### **ECO-COMFORT function**

Activating the comfort function ensures the temperature is maintained in the domestic hot water exchanger and consequently significantly decreases the waiting time for domestic hot water.

### **Operation with TEMPERATURE COMPENSATION**

The "Outside probe" kit can be installed to operate the boiler with temperature compensation. This means that without using the buttons on the system's temperature controller, the boiler automatically adapts to the variations in the outside temperature.

As a result this brings energy savings while still guaranteeing maximum comfort for the user.

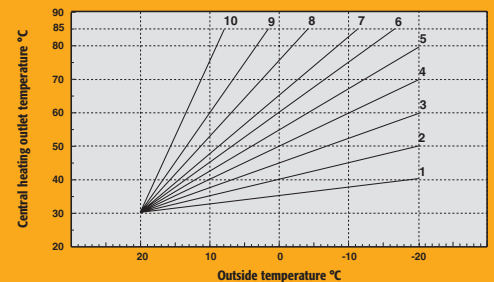

### **FROST PROTECTION function**

If the temperature in the boiler falls to 5°C, the burner automatically ignites, the three-way valve moves to half-way between the domestic hot water and central heating positions and the pump is started, so as to protect the appliance against any damage caused by frost. This function is active when the boiler is supplied by the gas mains and powered.







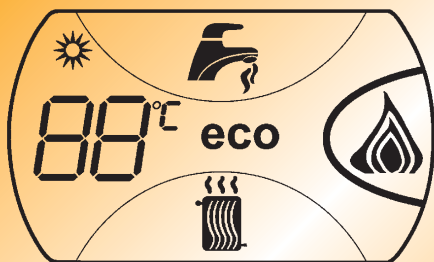

# Comfort my way...

The control electronics on the **ECONCEPT TECH** allow users to customise the operation of the appliance and **manage ambient comfort based on their own needs.**



LCD DISPLAY



-  Domestic hot water request
-  Central heating request
-   $88^{\circ}\text{C}$  Operating temperature - Fault codes
-  **eco** Economy mode activated (Comfort deactivated)
-  Burner on - Output modulation indication
-  Summer mode activated (Winter deactivated)

The **control panel** on the unit has been designed with an easy-to-read and straightforward display, with control buttons for setting the central heating outlet temperature, the domestic hot water temperature, to start the appliance and to activate the Economy function. The “dashboard” is completed by the hydrometer that controls the pressure in the boiler.

- 1 LCD display
- 2 Buttons for setting the DHW temperature
- 3 ON-OFF and comfort mode button
- 4 Hydrometer
- 5 Buttons for setting the CH temperature
- 6 Reset, summer/winter selection, fill system and climate mode button



## VIEW OF THE COMPONENTS

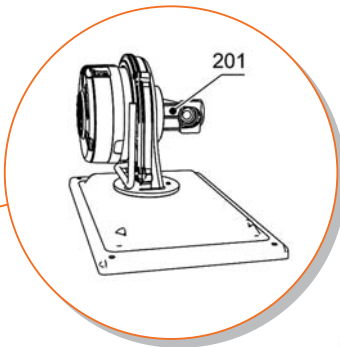
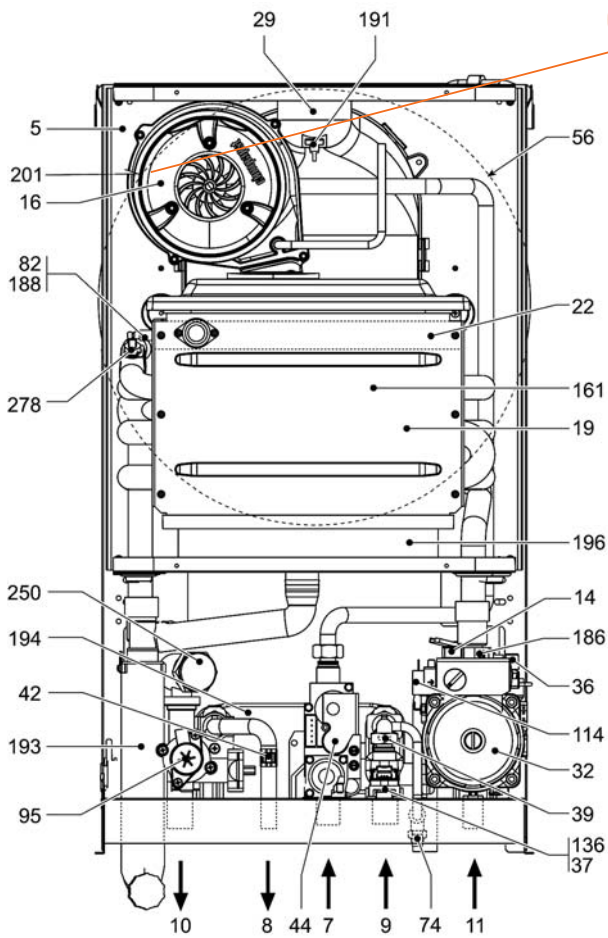

## WATER CIRCUIT

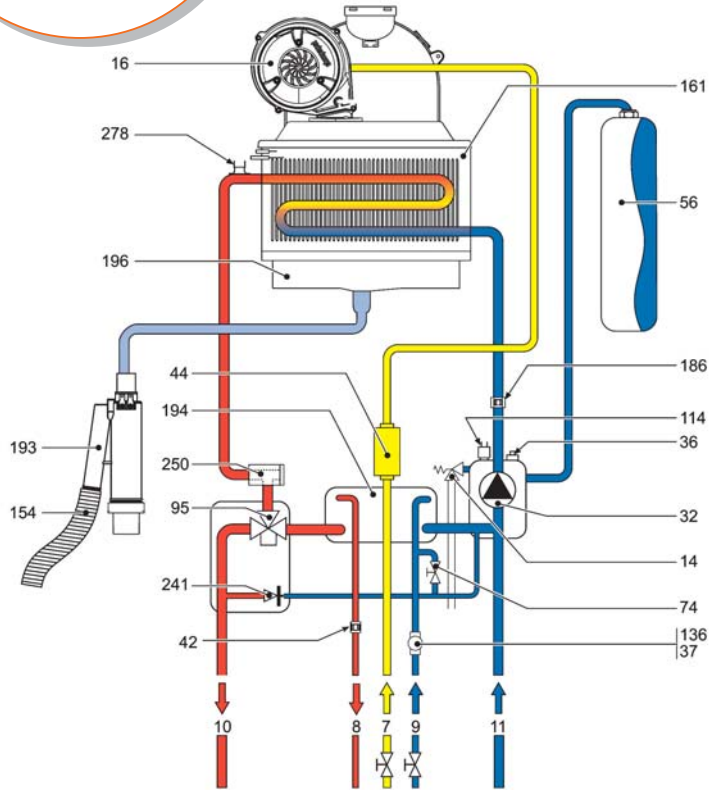

### KEY

- |                                 |                            |  |
|---------------------------------|----------------------------|--|
| 5 Room-sealed chamber           | 32 Central heating pump    | 136 Flow meter                             |
| 7 Gas inlet                     | 36 Automatic air vent      | 161 Condensing heat exchanger              |
| 8 Domestic hot water outlet     | 37 Cold water inlet filter | 186 Return sensor                          |
| 9 Domestic hot water inlet      | 39 Flow regulator          | 188 Ignition electrode                     |
| 10 Central heating flow outlet  | 42 DHW temperature probe   | 191 Flue gas temperature sensor            |
| 11 Central heating return inlet | 44 Gas valve               | 193 Drain trap                             |
| 14 Safety valve                 | 56 Expansion vessel        | 194 DHW heat exchanger                     |
| 16 Fan                          | 74 Filling cock            | 196 Condensate basin                       |
| 19 Combustion chamber           | 82 Detection electrode     | 250 Central heating flow outlet filter     |
| 22 Main burner                  | 95 Selector valve          | 278 Dual sensor (Safety + Central heating) |
| 29 Flue gas outlet manifold     | 114 Water pressure switch  |  |

## PRESSURE DROP - PUMP DISCHARGE HEAD

### ECONCEPT TECH 25C

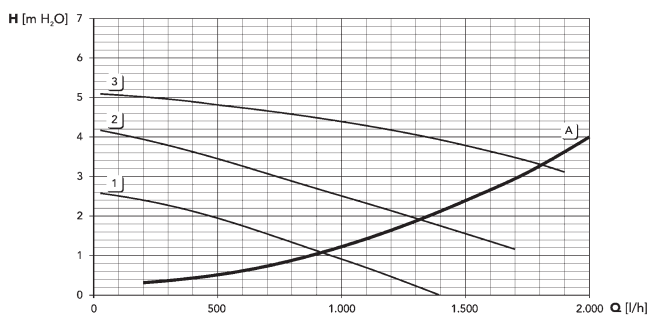

### ECONCEPT TECH 35C

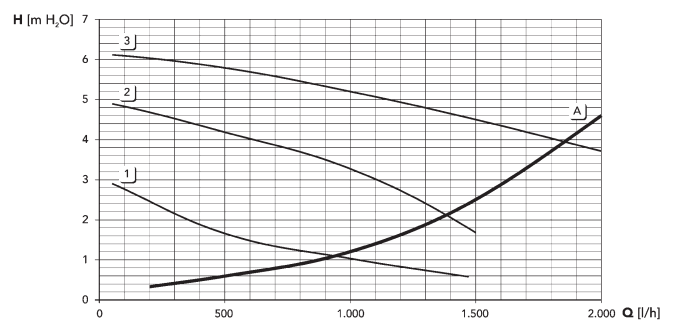

1 - 2 - 3 = Pump speed  
A = Boiler pressure drop

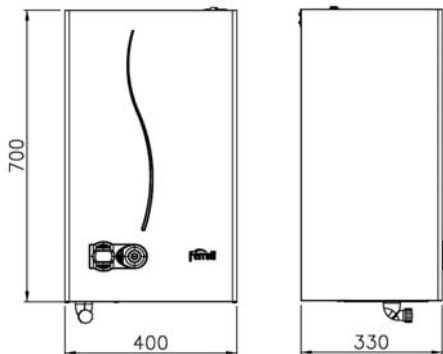
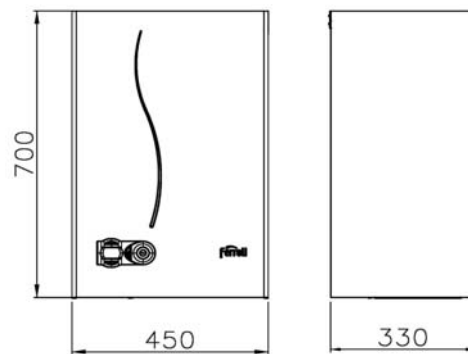
**ECONCEPT TECH 25A / 25C**

**ECONCEPT TECH 35A / 35C**

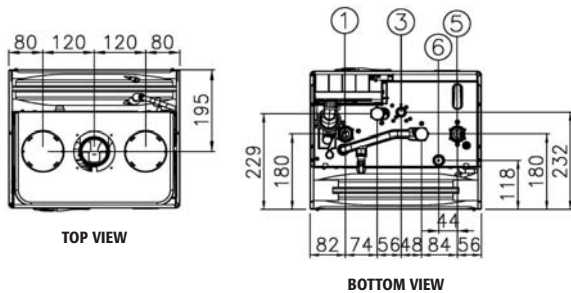
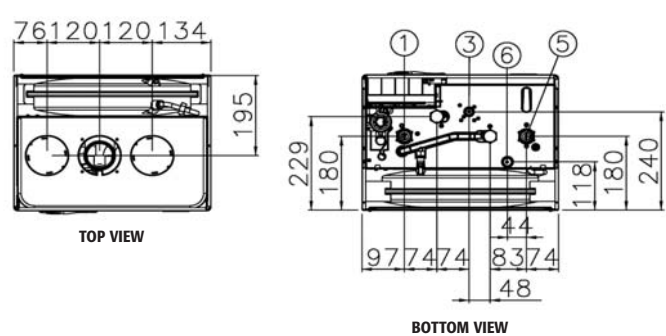
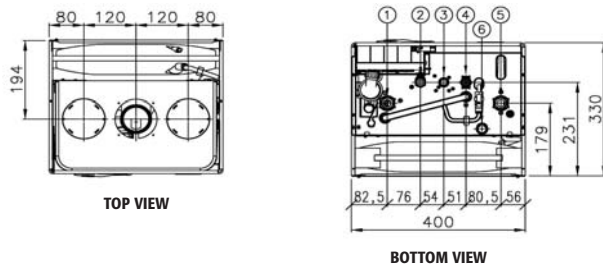
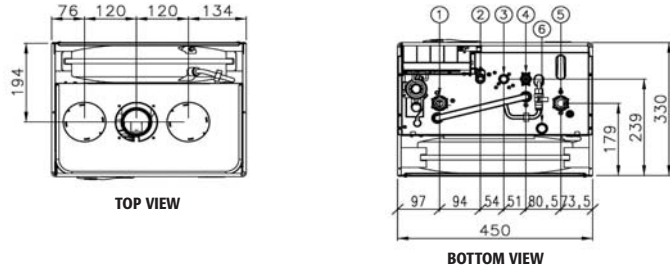
**KEY**

- 1 central heating flow outlet
- 2 DHW water outlet
- 3 gas inlet
- 4 DHW water inlet
- 5 central heating return inlet
- 6 safety valve discharge

**ECONCEPT TECH 25A**

**ECONCEPT TECH 35A**

**ECONCEPT TECH 25C**

**ECONCEPT TECH 35C**

<b>ECONCEPT TECH</b>			<b>25A</b>	<b>25C</b>	<b>35A</b>	<b>35C</b>
Heat input (Hi)	P max	kW	25,2	25,2	34,8	34,8
	P min	kW	5,3	5,3	6,5	6,5
Useful heat output 80°C - 60°C	P max	kW	24,6	24,6	34,2	34,2
	P min	kW	5,2	5,2	6,3	6,3
Useful heat output 50°C - 30°C	P max	kW	26,6	26,6	36,7	36,7
	P min	kW	5,7	5,7	6,9	6,9
Useful efficiency 80°C - 60°C	P max	%	98,3	98,3	98,5	98,5
	P min	%	97,3	97,3	97,0	97,0
Useful efficiency 50°C - 30°C	P max	%	105,4	105,4	105,5	105,5
	P min	%	107,2	107,2	106,9	106,9
Useful efficiency at reduced load	30% P max	%	109,1	109,1	109,1	109,1
Energy marking (EC directive 92/42)			★★★★	★★★★	★★★★	★★★★
NOx emission class (UNI EN 297)			5	5	5	5
Maximum central heating temperature		°C	95	95	95	95
Operating pressure min-max		bar	0,8-3	0,8-3	0,8-3	0,8-3
Total boiler water content		litres	1,5	1,5	2	2
Expansion vessel capacity		litres	8	8	10	10
Expansion vessel pre-charge pressure		bar	1,0	1,0	1,0	1,0
DHW circuit operating pressure min-max		bar	–	0,25-9	–	0,25-9
Delivery domestic hot water	Δt 25°C	litres/min	–	15,2	–	19,6
	Δt 30°C	litres/min	–	12,7	–	16,3
Max DHW power input		W	120	120	140	140
Power supply /Frequency		V / Hz	230/50	230/50	230/50	230/50
Boiler empty weight		kg	36	37	41	42
Gas fitting		inches	1/2"	1/2"	1/2"	1/2"
Central heating system fittings		inches	3/4"	3/4"	3/4"	3/4"
Domestic hot water circuit fittings		inches	–	1/2"	–	1/2"

# ferroli

## FERROLI *around the World*

ITALY [www.ferroli.it](http://www.ferroli.it)

SPAIN [www.ferroli.es](http://www.ferroli.es)

FRANCE [www.ferroli.fr](http://www.ferroli.fr)

UNITED KINGDOM [www.ferroli.co.uk](http://www.ferroli.co.uk)

NETHERLANDS [www.agpo.nl](http://www.agpo.nl)

GERMANY [www.ferroli.de](http://www.ferroli.de)

TURKEY [www.ferroli.com.tr](http://www.ferroli.com.tr)

ROMANIA [www.ferroli.ro](http://www.ferroli.ro)

POLAND [www.ferroli.com.pl](http://www.ferroli.com.pl)

RUSSIA [www.ferroli.msk.ru](http://www.ferroli.msk.ru)

UKRAINE [www.ferroli.ua](http://www.ferroli.ua)

BELARUS [www.ferroli.by](http://www.ferroli.by)

CHINA [www.ferroli.com.cn](http://www.ferroli.com.cn)

BALKANS [www.ferroli.hr](http://www.ferroli.hr)

IRAN [www.ferroli.ir](http://www.ferroli.ir)



Ferroli spa - 37047 San Bonifacio (Verona) Italy - Via Ritonda 78/A  
tel. +39.045.6139411 - fax +39.045.6100233  
[www.gruppoferroli.com](http://www.gruppoferroli.com) - e-mail: [export@ferroli.it](mailto:export@ferroli.it)

WARNING FOR TRADERS: As part of its efforts to constantly improve its range of products, with the aim of increasing the level of Customer satisfaction, the Company stresses that the appearance, dimensions, technical data and accessories may be subject to variation. Consequently, ensure that the Customer is provided with updated documents. The products described in this document are covered by warranty if purchased and installed in Italy.