



www.esbe.se



SERIES VRG330



NO.1 IN HYDROMIC SYSTEM CONTROL.



Series VRG331
Series VRG332
Series VRG333
Series VRG338

CE
Pressure Equipment Directive 97/23/EC

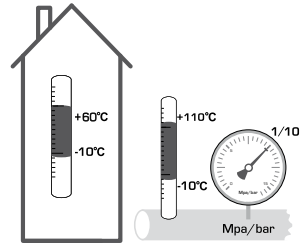

1

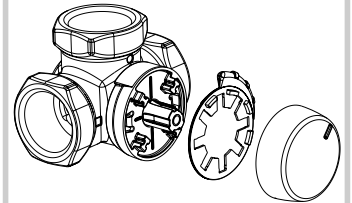

i

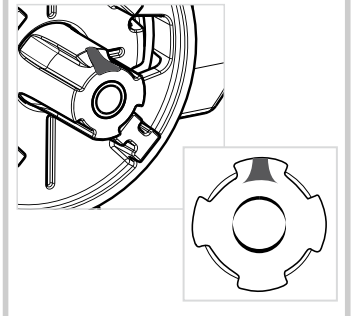

2

a

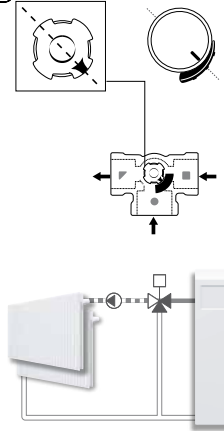

b

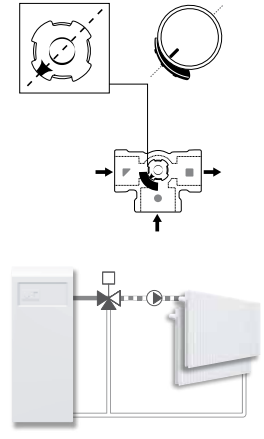

Piping Schematics are General Representations

3

a

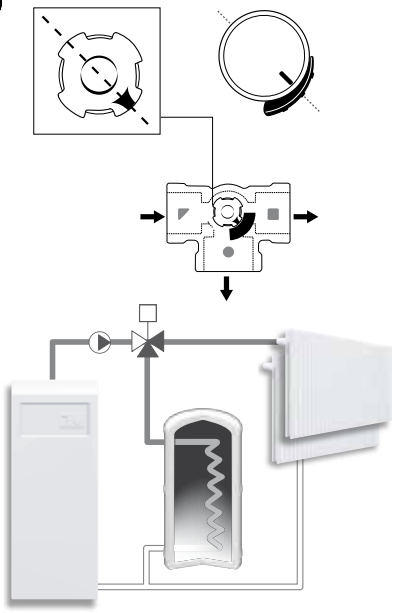

b

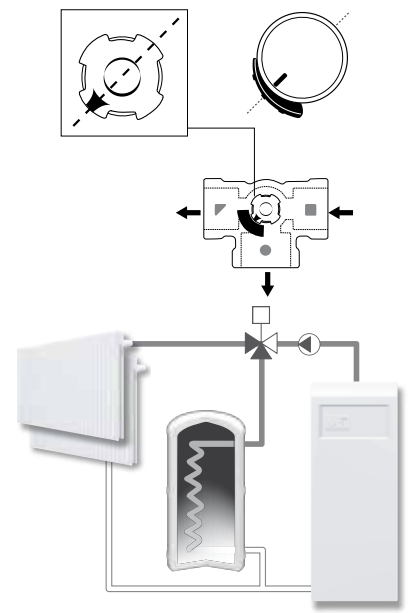

"Denna produkt är anpassad till Branschregler och Säker Vatteninstallation. Leverantören garanterar produktens funktion om branschreglerna och monteringsanvisningen följs."