

# technical data



ventilation

VKM-GMV1  
VKM-GV1

3

# technical data



ventilation

VKM-GMV1  
VKM-GV1

# TABLE OF CONTENTS

## VKM-GA(M)V1

1	External Appearance .....	3
2	Model Series .....	3
3	Nomenclature .....	4
4	Structures .....	4
5	Features.....	5
	General .....	5
	Design Flexibility .....	6
	Energy Saving .....	7
	Unique Control System .....	10
	Quiet Operation .....	10
	Easy Installation .....	10
	Other Features .....	11
6	Selection Procedures (in Japan).....	15
7	Product Specification.....	17
	VKM-GAMV1 .....	17
	VKM-GAV1 .....	37
8	Operation .....	56
	Safety Cautions .....	59
	What to do before Operation .....	62
	Operation Procedure .....	68
	Optimum Operation .....	73
	Maintenance (for a Qualified Service Person only) .....	74
	Trouble Shooting .....	77
	After-sales Service and Warranty .....	80
9	Installation .....	82
	Before Installation .....	82
	Selecting Installation Site .....	84
	Preparations before Installation .....	85
	The Method of Installation .....	86
	Drain Piping and Water Supply Work .....	87
	Refrigerant Piping Work .....	90
	Duct Connection .....	92
	Electric Wiring Work .....	93
	Wiring Example and how to set the Remote Controller .....	94
	Field Setting and Test Run .....	102

# TABLE OF CONTENTS

## VKM-GA(M)V1

10	Outdoor Air Processing of Ceiling Mounted Duct Connection Type.....	106
	Stand-alone Operation is Possible as an Independent System ....	106
	Ability to Calculate Connectable Capacity .....	106
	Central Control System .....	108
	Restrictions to Control System .....	109
	About the basic control of VKM .....	111
11	Appendix.....	112
	Purpose of Ventilation .....	112
	Kinds of Ventilation .....	117
	Calculation of Duct Pressure Loss .....	126
	Notes for Ducted Systems .....	131
	How to use Psychrometric Chart .....	133

# 1 External Appearance

VKM50GAMV1

VKM50GAV1



VKM80GAMV1

VKM100GAMV1

VKM80GAV1

VKM100GAV1



# 2 Model Series

Type	500	800	1000
DX-Coil and Humidifier	VKM50GAMV1	VKM80GAMV1	VKM100GAMV1
DX-Coil	VKM50GAV1	VKM80GAV1	VKM100GAV1

These units are applied only for CE regulation.

### 3 Nomenclature

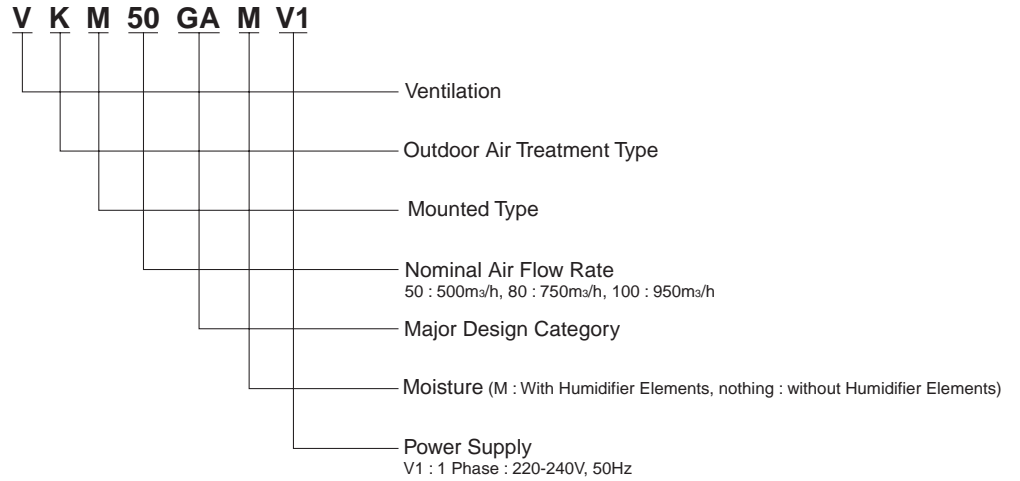

### 4 Structures

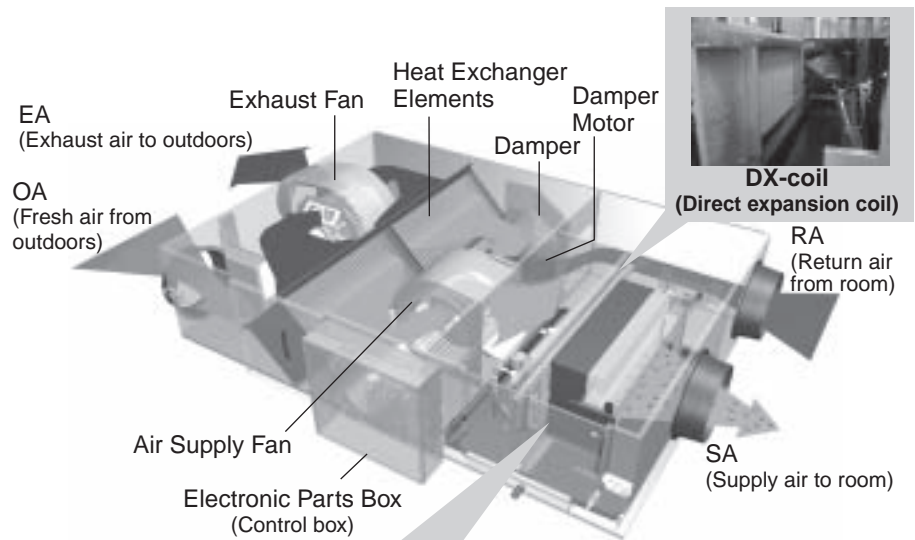

#### Humidifier element

Utilizing the principle of capillary action, water is permeated throughout the humidifier element. The heated air from the DX-coil goes through the humidifier and absorbs the moisture.

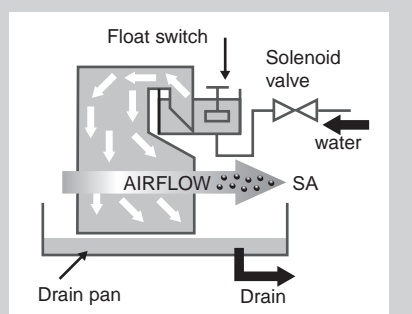

## 5 Features

### 5-1 General

- Interlocked operation with VRV  
(Controls of interlocked operation for energy saving : The remote controller for air conditioner can be used, so special remote controller for HRV is unnecessary.)
- Mounted for direct expansion coil unit for outdoor air treatment
- Changeover function for ventilation mode to Auto/Manual
- Fresh-up operation (Selectable : Supply air rich mode or exhaust air rich mode ; initial setting)
- Mounted for water flow type natural evaporating humidifier
- Possible to attach the high efficiency filter
- Attaching the power supply terminal for easy connection
- Quiet operation
- Changeover function for air flow rate to High/Low (Ultra-high setting is possible.)
- The power supply of HRV is commonly used with the air-conditioner (Single-phase 220-240V, 50Hz)
- Filter sign display and reset
- Timer setting
- Features of direct expansion coil
  - Draftless ventilation in heating
  - High humidifying function
- How to use this unit
  - This unit should be used with air conditioners.  
Air conditioning is impossible only by this unit, because this unit does not have temperature control function. (Its capacity is too small in order to control the room temperature to the whole.)  
And should be operated in combination with standard indoor units. (Interlocked operation)
  - Independent operation without taking an interlock with indoor units is possible, however, temperature setting by remote controller is impossible.  
In this ON/OFF operation by thermostat depends on factory setting, however, this value is changeable by setting mode on site.
  - Model selection should be done not by cooling capacity but by ventilating air flow rate.

## 5 Features

### 5-2 Design Flexibility

#### 5-2-1 Efficient Fan Performance Produces a High Static Pressure

Improvements to the fan, including the use of multi-arc blades, a thinner scroll and optimized fan scroll angle, help to boost efficiency.

Dramatically higher static pressure is achieved due to improved fan performance. This reduces limitations on unit placement and allows more flexibility in duct design.

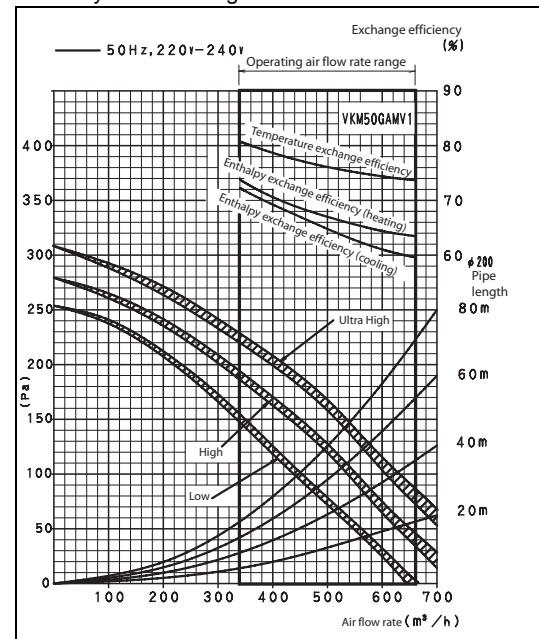
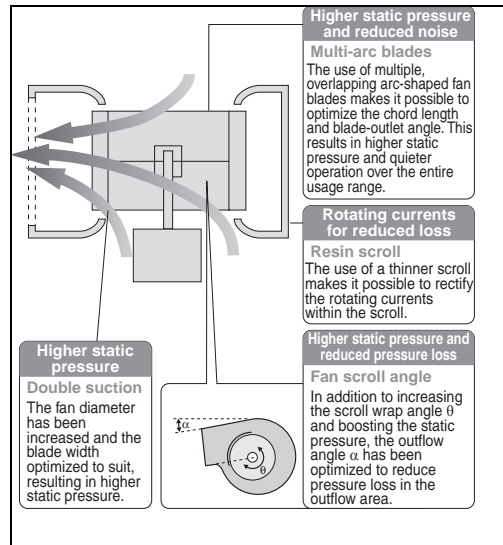

#### 5-2-2 Operable Outdoor Temperature Down to -15°C

If the outdoor air temperature falls below -10° C, the unit changes to intermittent operation to prevent freezing of the heat exchanger element and dew condensation within the unit.

##### Intermittent operation

A thermistor (standard equipment) within the unit detects the outdoor air temperature. Unit operation varies according to the detected temperature. Indoor Unit Connectable to up to 130% of the Capacity

#### 5-2-3 Slim Design

The slim design of only 387 mm in height enables installation inside ceilings with less than 400 mm of clearance.





## 5 Features

### 5-3 Energy Saving

#### 5-3-1 Automatic Heat Purge Function at Night

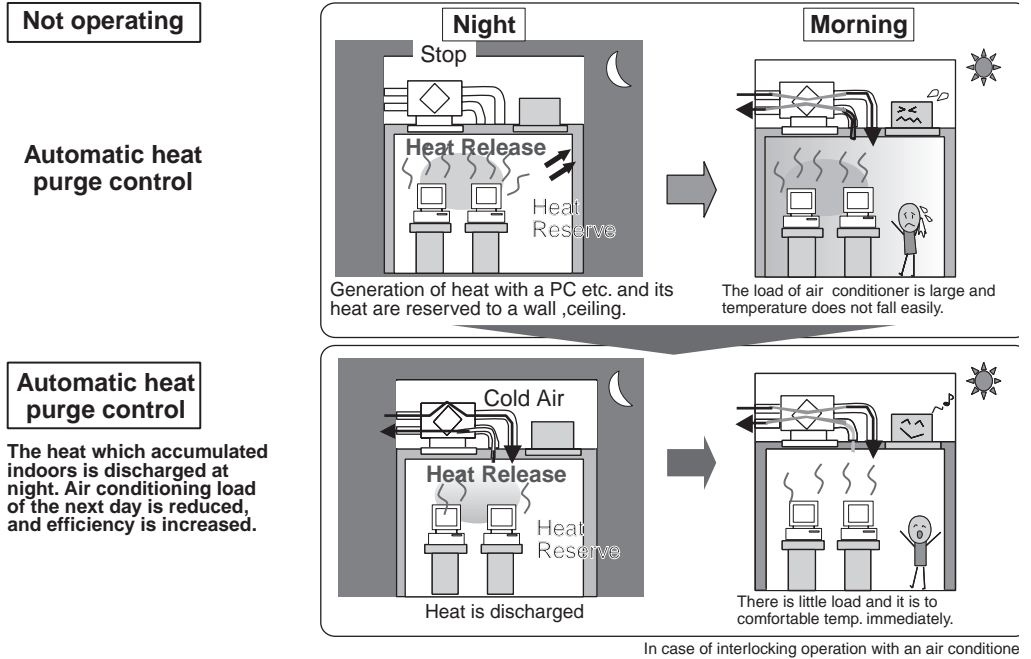

#### ■ Mechanism

##### <Operation>

1. Interlocking operation is carried out with the air-conditioning machine, and the time of 2 hours passing after an operation stop is judged to be night. (The same judgment as the present preparatory operation)
2. After 2-hour progress, when indoor temperature is higher than the preset temperature of an air-conditioning machine and higher than outdoor temperature, operation is started.
3. Operation will be stopped if indoor temperature falls to air-conditioning machine preset temperature.

#### ■ Effect (Field Setting by remote controller)

**It is reduction of about 5% of air-conditioning load at the time of cooling operation.**

Air conditioning operation carries out to to April to October, and air-conditioning load is calculated only with sensible heat load.

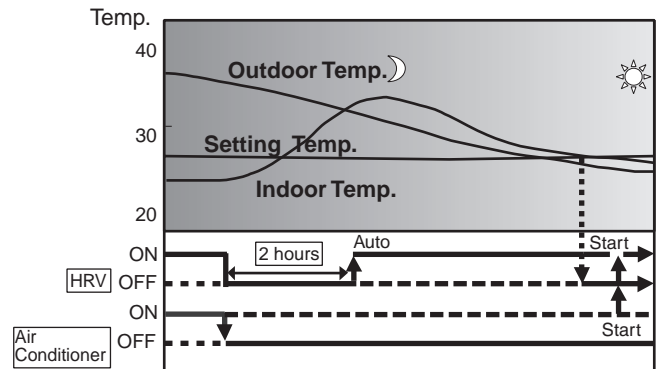

# 5 Features

## 5-3 Energy Saving

### 5-3-1 Automatic Heat Purge Function at Night

#### Nighttime Free Cooling Operation <Flow Chart>

#### Nighttime Free Cooling Operating Condition

#### Nighttime Free Cooling Precedent Condition

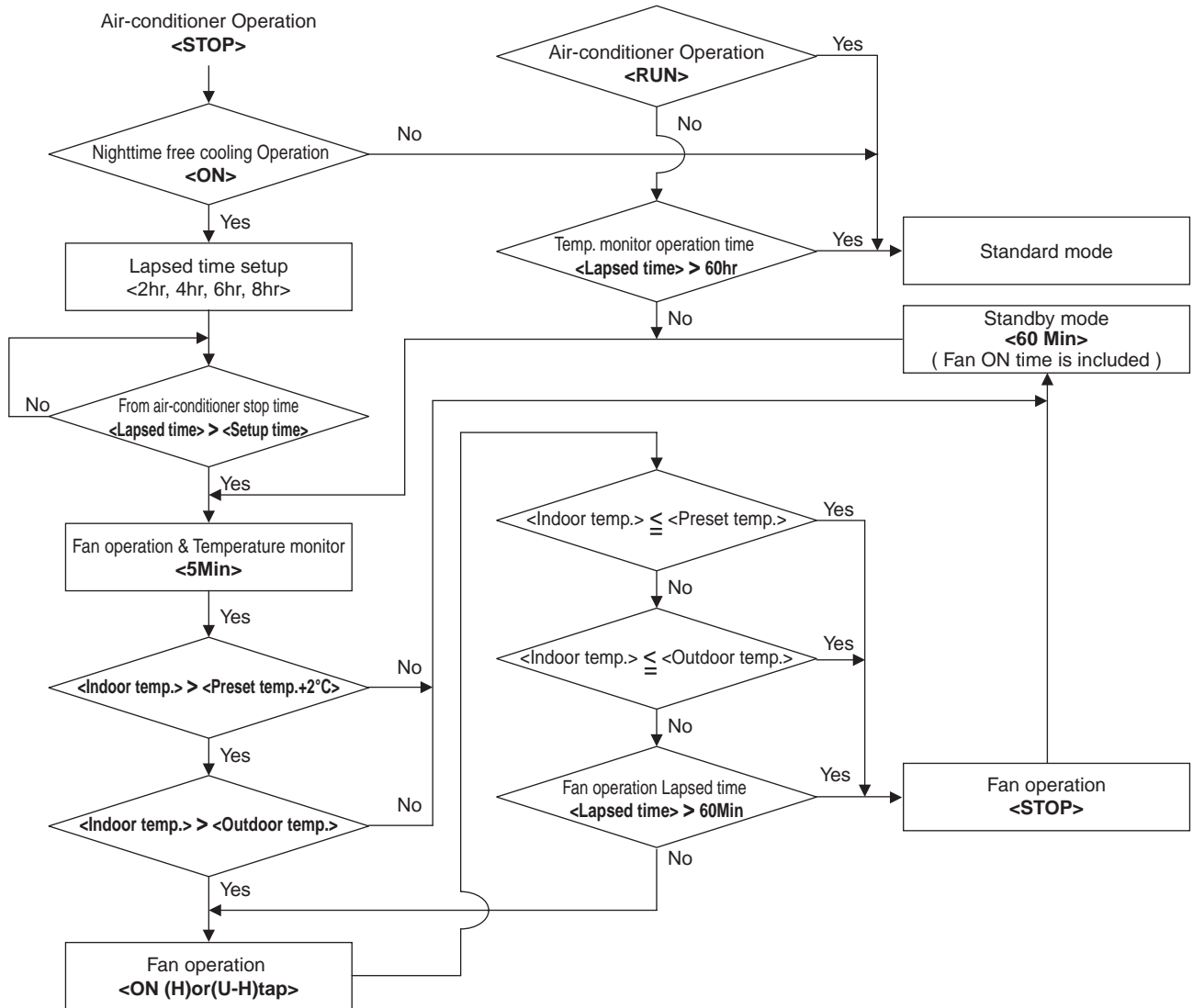

## 5 Features

### 5-3 Energy Saving

#### 5-3-2 Automatic Changeover to Efficient Operation Patterns

Operation automatically changes to the optimum pattern to suit conditions.

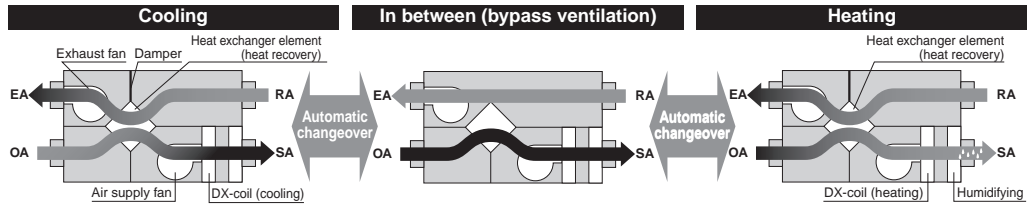

#### 5-3-3 Efficient Outdoor Air Introduction with Heat Exchanger and Cooling / Heating Operation

##### Indoor unit with outdoor air treatment

Using outdoor air, the temperature can be brought near room temperature with minimal cooling capacity through the use of outdoor air.

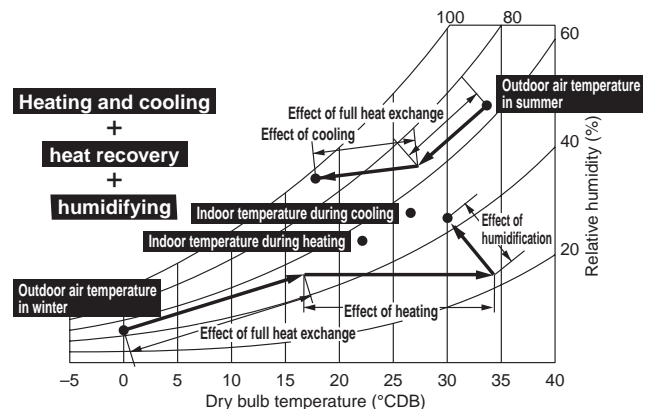

#### 5-3-4 Operations, Such as Cleaning, Ventilation, Cooling / Heating and Humidifying, are Possible with One Remote Controller.

Four air conditioner functions can be managed using a single remote control. This makes it easy to obtain high-quality and energy-efficient outdoor air treatment.

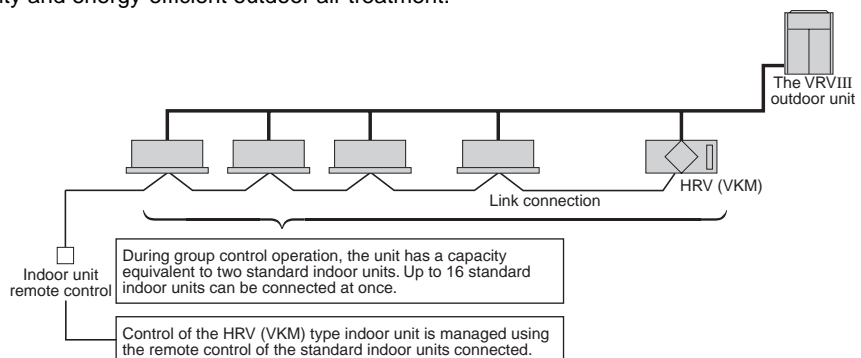

## 5 Features

### 5-4 Unique Control System

#### 5-4-1 Independent Control Possible

Individual outdoor air treatment operation is possible by connecting an optional remote controller.

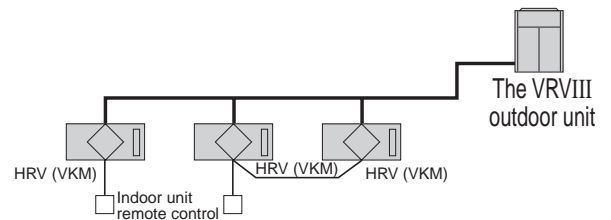

### 5-5 Quiet Operation

Reduced pressure loss and quieter operation internally lowers the noise output of the 1,000m<sup>3</sup>/h type system to 38dB (VKM100GAMV1 at 50Hz 240V, High mode)

### 5-6 Easy Installation

#### 5-6-1 Integrated System Includes Ventilation, Air Conditioning and Humidifying Operations

Rather than using separate ventilation, air conditioning, and humidifying components, the system incorporating HRV (VKM) integrates all functions, reducing the total number of indoor units and facilitating a far simpler system. The installation space becomes smaller and the labor required for installation and maintenance is reduced significantly.

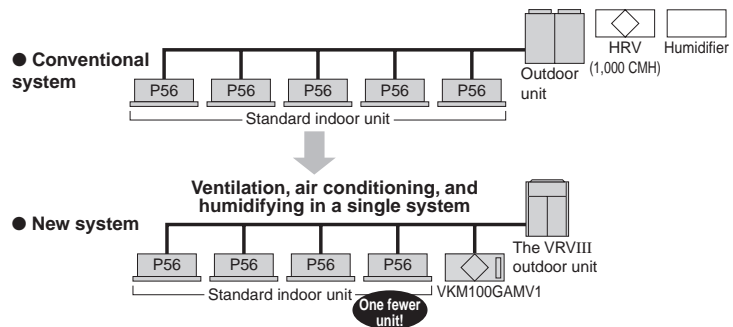

## 5 Features

### 5-7 Other Features

#### 5-7-1 Interlocked Operation with VRV

1. Simultaneous ON / OFF with the indoor unit by the indoor unit remote controller.
2. HRV independent operation during air conditioning off season by the indoor unit remote controller.
3. Automatic ventilation mode changeover : Auto / Heat Recovery / Bypass
4. Fan speed changeover by the indoor unit remote controller : High / Low, Ultra-high / High
5. Fresh-up operation setting
6. Filter sign display notifies the time for cleaning the filter.
7. No need to purchase or install the HRV exclusive remote controller
8. Advantage to IAQ (Internal Air Quality)

**Note**

4-6 can be set at the initial setting only. (When using the remote controller BRC1A62)

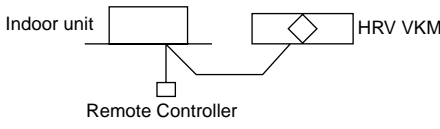
Type	Interlocked operation with air conditioner
Structure	 <p style="text-align: right;">(HC0228)</p>
Features	<ul style="list-style-type: none"> <li>• Simultaneous operation by air conditioner's remote controller is available.</li> <li>• Fan speed can be set at the initial setting.</li> </ul>
Connectable Indoor unit	VRV (all indoor unit)

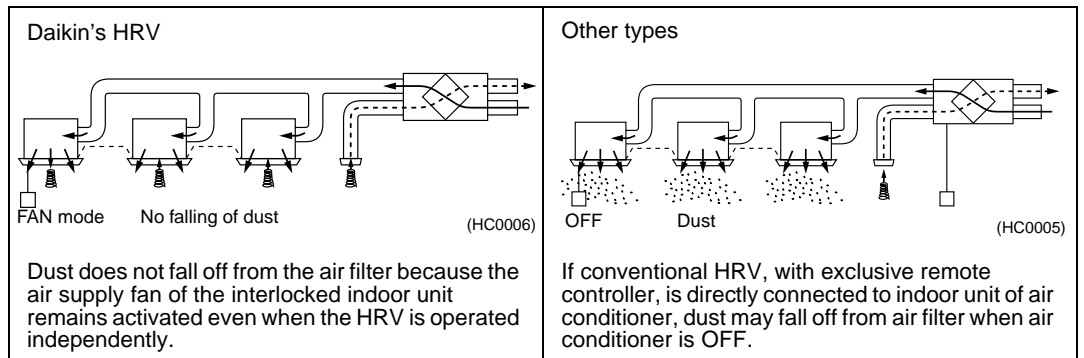

**Note**

- 1) In case of the direct duct connection system, operate interlocking with indoor units.
- 2) Do not connect the duct with discharge air side of indoor units.

**Installation Examples**

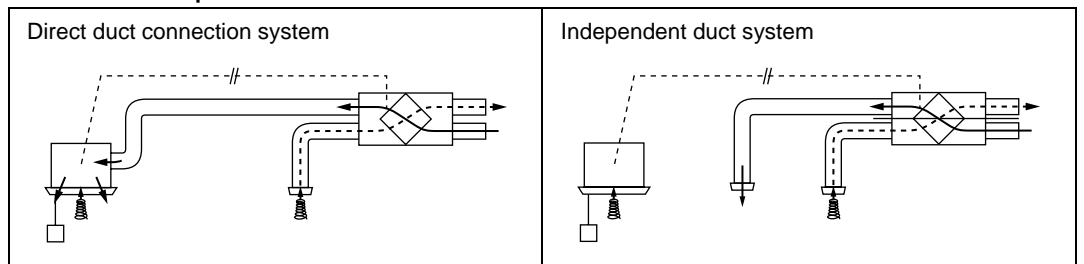

# 5 Features

## 5-7 Other Features

### 5-7-2 Mechanism of Energy Saving

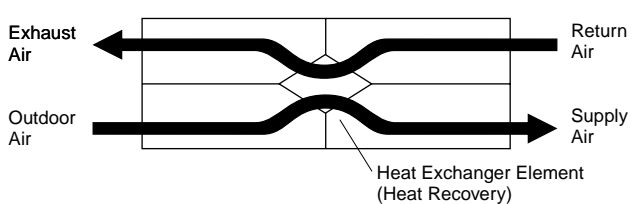
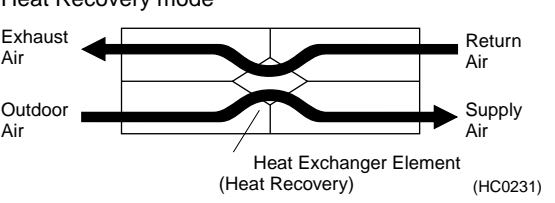
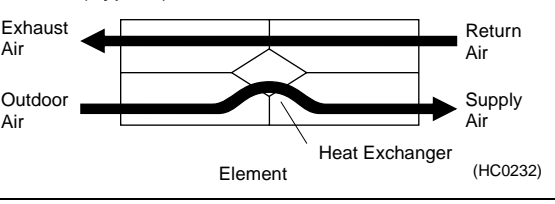
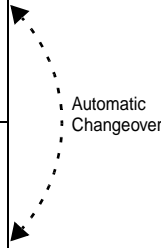
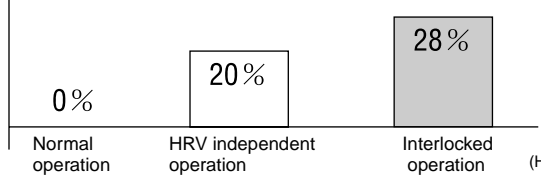
<div style="border: 1px solid black; padding: 5px; text-align: center;">By heat recovery operation</div> <div style="text-align: center; margin: 10px 0;"> <div style="border: 1px solid black; border-radius: 50%; padding: 10px; display: inline-block;">Approx. <b>20%</b> reduction of heating / cooling load</div>   <div style="font-size: 2em; font-weight: bold;">+</div> </div>	<p>HRV unit recovers the thermal energy during cooling / heating operation of air conditioner. HRV reduces the cooling / heating load drastically and enhances the heating / cooling efficiency.</p>  <p style="text-align: right; font-size: small;">(HC0230)</p>												
<div style="border: 1px solid black; padding: 5px; text-align: center;">By setting to automatic ventilation mode</div> <div style="text-align: center; margin: 10px 0;"> <div style="border: 1px solid black; border-radius: 50%; padding: 10px; display: inline-block;">Approx. <b>6%</b> reduction of heating / cooling load</div>   <div style="font-size: 2em; font-weight: bold;">+</div> </div>	<p>Proper use of Heat recovery ventilation and normal ventilation saves energy.</p> <p>When the cooling operation is required in winter, use of heat recovery ventilation is not efficient because the outdoor air temperature is normally lower than that of the indoor.</p> <p>Thus, the proper use of ventilation mode enhances the heating / cooling efficiency.</p> <p>Automatic Ventilation mode changeover</p> <table border="1" style="width: 100%; border-collapse: collapse; font-size: small;"> <thead> <tr> <th style="width: 15%;">Operation</th> <th style="width: 45%;">Sensor of ventilation</th> <th style="width: 40%;">Decision of mode (Which is more energy efficient?)</th> </tr> </thead> <tbody> <tr> <td></td> <td>Difference between indoor / outdoor temp.</td> <td></td> </tr> <tr> <td>Cooling</td> <td>Indoor temp. &gt; Outdoor temp. Indoor temp. &lt; Outdoor temp.</td> <td>Normal ventilation (Bypass) Heat recovery ventilation</td> </tr> <tr> <td>Heating</td> <td>Indoor temp. &gt; Outdoor temp. Indoor temp. &lt; Outdoor temp.</td> <td>Heat recovery ventilation Normal ventilation (Bypass)</td> </tr> </tbody> </table> <p>Refer to the CONTROL for the mode changeover.</p> <div style="display: flex; justify-content: space-between;"> <div style="width: 60%;"> <div style="border: 1px solid black; padding: 5px; margin-bottom: 5px;"> <p style="text-align: center; font-weight: bold;">Heat Recovery mode</p>  <p style="text-align: right; font-size: small;">(HC0231)</p> </div> <div style="border: 1px solid black; padding: 5px;"> <p style="text-align: center; font-weight: bold;">Normal (Bypass) mode</p>  <p style="text-align: right; font-size: small;">(HC0232)</p> </div> </div> <div style="width: 35%; text-align: center; font-size: small;"> <p>Automatic Changeover</p>  </div> </div>	Operation	Sensor of ventilation	Decision of mode (Which is more energy efficient?)		Difference between indoor / outdoor temp.		Cooling	Indoor temp. > Outdoor temp. Indoor temp. < Outdoor temp.	Normal ventilation (Bypass) Heat recovery ventilation	Heating	Indoor temp. > Outdoor temp. Indoor temp. < Outdoor temp.	Heat recovery ventilation Normal ventilation (Bypass)
Operation	Sensor of ventilation	Decision of mode (Which is more energy efficient?)											
	Difference between indoor / outdoor temp.												
Cooling	Indoor temp. > Outdoor temp. Indoor temp. < Outdoor temp.	Normal ventilation (Bypass) Heat recovery ventilation											
Heating	Indoor temp. > Outdoor temp. Indoor temp. < Outdoor temp.	Heat recovery ventilation Normal ventilation (Bypass)											
<div style="border: 1px solid black; padding: 5px; text-align: center;">By Precooling / heating operation</div> <div style="text-align: center; margin: 10px 0;"> <div style="border: 1px solid black; border-radius: 50%; padding: 10px; display: inline-block;">Approx. <b>2%</b> reduction of heating / cooling load</div>   <div style="font-size: 2em; font-weight: bold;">  </div> </div>	<div style="border: 1px solid black; border-radius: 50%; padding: 10px; text-align: center; margin: 10px 0;"> <b>Total 26%</b> reduction of heating / cooling load         </div> <div style="margin-top: 20px;"> <p>Reduction of heating / cooling load (%)</p>  <p style="text-align: right; font-size: small;">(HC0233)</p> </div>												

**Note :**

The total heating / cooling load may vary depending on the climate or the other environmental conditions.

## 5 Features

### 5-7 Other Features

#### 5-7-3 Fresh-up Operation

Both the excessive supply mode and the excessive exhaust mode are selectable. This function creates a more comfortable air environment.

	Supply Fresh-up (Excessive outdoor air supply)	Exhaust Fresh-up (Excessive exhaust air supply)
Detail	Supply air volume can be set at a higher level than the exhaust air by the remote controller.	Exhaust air volume can be set at a higher level than the supply air by the remote controller.
Major effects	<ul style="list-style-type: none"> <li>Prevents inflow of toilet odor</li> <li>Prevents inflow of outdoor air in winter</li> </ul>	<ul style="list-style-type: none"> <li>Prevents outflow of airborne bacteria from rooms in a hospital</li> <li>Prevents outflow of odors from rooms in a nursing home</li> </ul>
Application	Offices, etc.	Hospitals, Nursing homes, etc.
Example		

#### 5-7-4 Proprietary Developed HEP Element

The heat exchanger element uses a High Efficiency Paper (HEP) that has superior moisture-absorption and humidifying properties and doubles the current efficiency of moisture absorption. The heat exchanger unit speedily recovers heat contained as latent heat (vapor). The element is made of a material with superior flame-resistant properties and is treated with an anti-molding agent.

##### Operation of the heat exchanger element

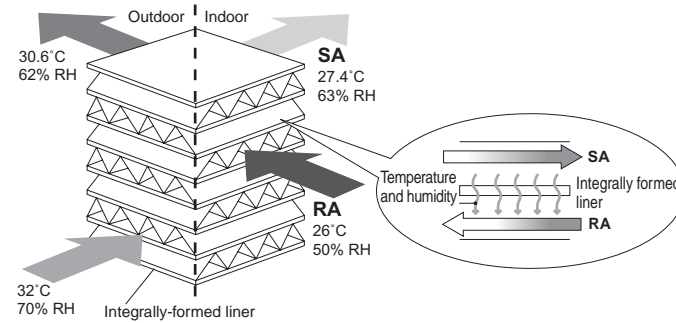

(HC0013)  
HEP anti-molding

##### Features

- High air shielding

Even in the conventional less humidity conditions, maintaining the features of the material that can get excellent moisture permeability, we have achieved high air shielding, by special processing in the step of milling paper.

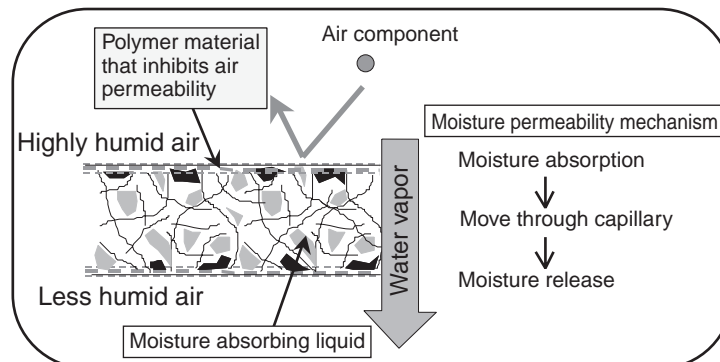

- Polymer material that inhibits air permeability that treated on the surface of the heat exchanger element restrains air permeability.

## 5 Features

### 5-7 Other Features

#### 5-7-5 Easy Installation and Service Maintenance

##### Downsized

Model name	Height (mm)
VKM50GAMV1	387
VKM50GAV1	
VKM80GAMV1	
VKM80GAV1	
VKM100GAMV1	
VKM100GAV1	

##### Parallel air flow system (Daikin)

This system prevents misconnection and simplifies the installation work

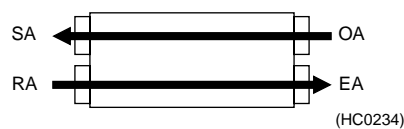

##### Cross air flow system (Others)

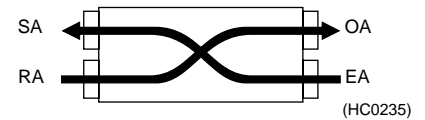

#### 5-7-6 The Operation is Available When the Outdoor Air Temperature is Down to -15°C

(Operation when the outdoor air temperature becomes lower than -10°C)

When the outdoor air suction temperature becomes lower than -10°C, the unit is changed to intermittent operation to prevent freezing of the heat exchanger element and dew condensation within the unit.

##### Intermittent operation

The outdoor air thermistor (standard equipment) within the unit detects the temperature. According to the detected temperature, the following operation determines.

<Step 1>

- The air supply fan is changed to intermittent operation, when the temperature is lower than -10°C.
- The intermittent operation of the air supply fan is changed to an operation of each cycle for 45 minutes' operation after stopping operation for 15 minutes.
- The exhaust fan operates continuously according to setup.

<Step 2>

- When the temperature becomes lower than -15°C, the unit stops operation to prevent any defect, such as dew condensation and freezing. The unit does not ventilate. But, to detect the elevation of the outdoor air temperature, the unit operates for 5 minutes per hour.

#### 5-7-7 The High Efficiency Filter (that has 65% of Average Dust Collecting Efficiency) is Suitable

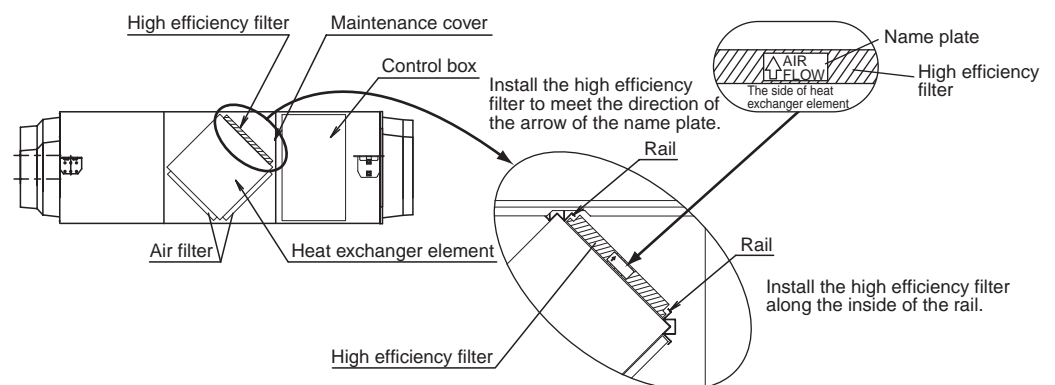

#### 5.7.8 Additional Optional Accessories

##### Built-in optional high efficiency filter

It greatly reduces the installation space.

The installation of access doors and the unit can be reduced.



## 6 Selection Procedures (in Japan)

Various methods are used to calculate the required ventilating air flow rate according to CO<sub>2</sub> generated by inhabitants in a room, waste gas generated by use of fire, and other conditions of a room.

Here are 2 patterns of calculating methods.

### Based on inhabitants

$$\text{Required ventilating air flow rate (m}^3/\text{h)} = \frac{20 \times A}{B}$$

A : 20 × Living room floor space (m<sup>2</sup>)

B : Area occupied per person (m<sup>2</sup>)

The above equation conforms to article 20, 2 No.2 of the Building Standards Act in Japan.

### Note :

- 20 (in the above equation) means “20(m<sup>3</sup> / h / person)”, which is the required ventilating air flow rate based on the CO<sub>2</sub> exhausted by an adult sitting still in a room. If smoking is allowed, other calculation method should be used.
- Use 10 (m<sup>2</sup>) if the area occupied per person exceeds 10 (m<sup>2</sup>).

<Table 1>

Type of building	Area occupied per person (N)	Remarks
Dining houses, restaurants, coffee-shops	3 m <sup>2</sup>	Floor space of a part used for business purposes
Cabarets, beer halls	2 m <sup>2</sup>	Floor space of a part used for business purposes
Japanese-style restaurants, hall for hire	3 m <sup>2</sup>	Floor space of a part used for business purposes
Store market	3 m <sup>2</sup>	Floor space of a part used for business purposes
Pool rooms, Ping-pong rooms, dance halls, bowling alleys	2 m <sup>2</sup>	Floor space of a part used for business purposes
Pin-ball parlors, Go club houses, mahjong parlors	2 m <sup>2</sup>	Floor space of a part used for business purposes
Inns, hotels, and motels	10 m <sup>2</sup>	Floor space of a part used for business purposes
Massage parlors	5 m <sup>2</sup>	Floor space of a part used for business purposes
Meeting places, public halls	0.5 – 1 m <sup>2</sup>	Persons accommodated simultaneously with the number of persons calculated per unit
Offices	5 m <sup>2</sup>	Floor space of an office

\* : Values set by the Metropolitan Maintenance Bureau in Japan.

### Note :

- Table indicates the required ventilating air flow rate calculated as 20 m<sup>3</sup> / h.
- The area occupied per person by type of business is calculated in reference to Application Standards for building administration in compliance with Building Standards Act in Japan.

### Based on Room size

$$\text{Required ventilating air flow rate (m}^3/\text{h)} = C \times D \times E$$

C : Number of ventilation required per hour (ventilation / h)

D : Area of room (m<sup>2</sup>)

E : Height of Ceiling (m)

Calculation is based on the experiences of hygienic laboratory, etc. to find out the number of hourly ventilation of the room air.

(Selection example)

Place : Living room of common household

Required ventilation : 6 times / h (See Table 2)

Area of room : Approx. 30 (m<sup>2</sup>)

Height of ceiling : 2.4 m

Required ventilating air flow rate = 6 × 30 × 2.4 ≒ 432 (m<sup>3</sup> / h)

Required ventilating air flow rate 500 is almost equivalent to the unit type 50.

So select the close size of the unit.

In this case, select VKM50GAMV1.

## 6 Selection Procedures (in Japan)

<Table 2>

Groups	Type of room	Ventilation required	Groups	Type of room	Ventilation required
Common household	Living room	6	Playhouses and movie theaters	Audience room	6
	Bathroom	6		Corridor	6
	Drawing room	6		Smoking room	12
	Toilet	10		Toilet	12
	Kitchen	15		Projector room	20
Dining places	Restaurant	6	Plants	Office room	6
	Sushi restaurant	6		General work room	6
	Banquet hall	10		Telephone room	6
	Tempura restaurant	20		Spinning plant,	10
	Cooking room	20		Printing plant	10
Inns and hotels	Guest room	5		Battery room	10
	Corridor	5		Machinery plant	10
	Dance hall	8		Generator room	15
	Large dining hall	8		Substation room,	15
	Washroom, Toilet	10		Painting shop,	15
	Cooking room	15		Welding plant	15
	Laundry room	15		Chemical plant	15
	Engine room	20		Food plant	20
	Boiler room	20	Wood working plant	20	
Hospitals	Consultation office	6	Casting plant	50	
	Sick room	6	General buildings	Office room	6
	Office room	6		Waiting room	10
	Corridor	10		Show room, Toilet	10
	Waiting room	10		Conference room	12
	Bathroom	10	Comfort stations		20
	Dining room, Toilet	10	Dark rooms	Dark rooms for photo	16
	Respiratory disease room	10	Guest rooms of ship		6
	Laundry room	15	Room of potential noxious gas or combustible gas		20 or more
	Cooking room	15			
	Surgery room	15			
	Sterilizing room	15			
	Engine room	20			
	Boiler room	20			
	Schools	Class room, library	6		
Auditorium		6			
Experimental chemistry room		6			
Gymnasium		8			
Toilet		12			
Cooking room		15			

# 7 Product Specification

## 7 - 1 VKM-GAMV1

### 7 - 1 - 1 Specifications

TECHNICAL SPECIFICATIONS				VKM50GAMV1	VKM80GAMV1	VKM100GAMV1
Fresh air conditioning load	Cooling		kW	4.71	7.46	9.12
	Heating		kW	5.58	8.79	10.69
Power input (nominal)	Heat exchange mode	Ultra-high	kW	0.560	0.620	0.670
		High	kW	0.490	0.560	0.570
		Low	kW	0.420	0.470	0.480
	Bypass mode	Ultra-high	kW	0.560	0.620	0.670
		High	kW	0.490	0.560	0.570
		Low	kW	0.420	0.470	0.480
Casing	Material	Galvanised steel plate				
Dimensions	Height		mm	387	387	387
	Width		mm	1764	1764	1764
	Depth		mm	832	1214	1214
Weight			kg	102	120	125
Heat exchanger	Type	Cross fin coil				
	Rows			2	2	2
	Stages			12	12	12
	Fin pitch		mm	2.2	2.2	2.2
	Face area		m <sup>2</sup>	0.078	0.118	0.165
Fan	Type	Sirocco fan				
Air Flow Rate	Heat exchange mode	Ultra-high	m	500	750	950
		High	m	500	750	950
		Low	m	440	640	820
	Bypass mode	Ultra-high	m	500	750	950
		High	m	500	750	950
		Low	m	440	640	820
Fan	External static pressure	Ultra-high	Pa	160	140	110
		High	Pa	120	90	70
		Low	Pa	100	70	60
	Motor	Quantity		2	2	2
		Output	W	280	280	280
Temperature exchange efficiency	Ultra-high		%	76	78	74
	High		%	76	78	74
	Low		%	77.5	79	76.5
Enthalpy exchange efficiency	Cooling	Ultra-high	%	64	66	62
		High	%	64	66	62
		Low	%	67	68	66
	Heating	Ultra-high	%	67	71	65
		High	%	67	71	65
		Low	%	69	73	69
Humidifier	System	Natural evaporating type				
	Amount		kg/h	2.7	4.0	5.4
	Feed water pressure		MPa	0.02~0.49		
	N			1	1	2
Operation Range	Outdoor air			-15	-15	-15
Heat exchange mode	Sound Pressure	Ultra-high	dBA	37/37.5/38	38.5/39/40	39/39.5/40
		High	dBA	35.5/35.5/36	36/37/37.5	37/37.5/38
		Low	dBA	32/33/34	33/34/35.5	34/34.5/35.5
Bypass mode	Sound Pressure	Ultra-high	dBA	37/37.5/38	38.5/39/40	39/39.5/40
		High	dBA	35.5/35.5/36	36/37/37.5	37/37.5/38
		Low	dBA	32/33/34	33/34/35.5	34/34.5/35.5

TECHNICAL SPECIFICATIONS				VKM50GAMV1	VKM80GAMV1	VKM100GAMV1
Piping connection	Liquid	Type		flare connection		
		Diameter	mm	6.4	6.4	6.4
	Gas	Type		flare connection		
		Diameter	mm	12.7	12.7	12.7
	Water supply	mm		6.4	6.4	6.4
Drain			PT3/4 external thread			
Refrigerant control			electronic expansion valve			
Insulation material			Self-extinguishable urethane foam			
Heat exchange system			Air to air cross flow total heat (sensible + latent heat) exchange			
Heat exchange element			Specially processed non-flammable paper			
Air Filter			Multidirectional fibrous fleeces			
Connection duct diameter	mm		200	250	250	
Operation mode			Heat exchange mode, bypass mode, fresh-up mode			
Standard			Installation and operation manual			
Accessories			Duct connection flange			
			M4 tapping screw to connect duct			
			water supply piping with strainer			
			half union joint (copper piping joint)			
			flare nut (copper piping joint)			
			refrigerant piping insulation cover			
			water supply piping insulation cover			
			sealing material			
			clamp			
Notes			<p>Cooling and heating capacities are based on the following conditions: Fan is based on High and Ultra High. The figures in parenthesis indicate the heat reclaimed from the heat recovery ventilator. When calculating the capacity as indoor units, use 5.6kW.</p> <p>Cooling capacities are based on: indoor temperature: 27</p> <p>Heating capacities are based on: indoor temperature: 20</p> <p>Humidifying capacity is based on</p> <p>Operation sound measured at 1.5m below the center of the unit is converted to that measured in an anechoic chamber, built in accordance with JIS C1502 condition. The actual operation sound varies depending on the surrounding conditions (near running unit)</p> <p>The sound level at the air discharge port is about 8-11dB higher than the unit's operating sound. For operation in a quiet room, it is required to take measures to lower the sound, for example install more than 2m soft duct near the air discharge grille</p> <p>Air flow rate can be changed over to Low mode or High mode.</p> <p>Normal amplitude, input, efficiency depend on the other above conditions</p> <p>In case of holding full water in humidifier</p> <p>OA: fresh air from outdoor, RA: return air from the room</p> <p>The specifications, designs and information here are subject to change without notice</p> <p>Temperature Exchange Efficiency is a mean value in cooling and heating</p> <p>Efficiency is measured under following condition: ratio of rated external static pressure has been kept as follows: outdoor side to indoor side = 7 to 1</p> <p>Feed clean water. If the supply water is hard water, use a water softener because of short life. Life of humidifying element is about 3 years (4,000 hours, under the supply water conditions of hardness: 150mg/l). Life of humidifying element is about 1 y</p> <p>During the heating operation the freezing of the outdoor unit coil increases, heating capacity decreases and the system goes into defrost operation. During defrost operation the fans of the units continue driving (factory settings), the purpose of this is to maintain the amount of ventilation and humidification.</p> <p>When connecting with a VRV Heat Recovery outdoor unit, bring the RA (exhaust gas intake) of this unit directly in from the ceiling. Connect to a BS unit identical to the VRV outdoor unit (master unit), and use group-linked operation.</p> <p>When connecting the indoor unit directly to the duct, always take the same system on the indoor unit as with the outdoor unit. Perform group-linked operation and make the direct duct connection settings from the remote controller. (Mode No. '17 (27)' -first code n° '5' - Second Code n° '6') Do not connect to the outlet side of the indoor unit, depending on the fan strength and static pressure the unit might back up.</p>			

ELECTRICAL SPECIFICATIONS			VKM50GAMV1	VKM80GAMV1	VKM100GAMV1	
Power Supply	Name		V1			
	Phase		1	1	1	
	Frequency	Hz	50	50	50	
	Voltage		V	220-240		
Nominal running current (RLA)	Heat exchange mode	Ultra-high	A	3.00	3.00	3.00
		High	A	2.50	2.60	2.50
		Low	A	2.10	2.10	2.10
	Bypass mode	Ultra-high	A	3.00	3.00	3.00
		High	A	2.50	2.60	2.50
		Low	A	2.10	2.10	2.10
Current	Minimum circuit amps (MCA)		A	4.30	4.30	4.30
	Maximum fuse amps (MFA)		A	15	15	15
	Fan motor rated output		kW	0.028 x 2		
	Full load amps (FLA)		A	1.9 x 2		
Voltage range	Minimum		V	198	198	198
	Maximum		V	264	264	264
Notes			Voltage range : Units are suitable for use on the electrical systems where the voltage supplied to the unit terminals is not below or above the listed range limits.			
			Maximum allowable voltage range variation between phases is 2%			
			MCA/MFA : $MCA = 1.25 \times FLA (FM1) + FLA (FM2)$ ; $MFA \leq 4 \times FLA$ ; (Next lower standard fuse rating. Min. 15A			
			Select wire size based on the value of MCA.			
			Instead of the fuse, use the circuit breaker.			

## 7 Product Specification

### 7 - 1 VKM-GAMV1

HUMIDIFIER	VKM50GAMV1	VKM80GAMV1	VKM100GAMV1
	VKM50GAMV1	VKM80GAMV1	VKM100GAMV1
Humidifier type	Natural evaporating type humidifier		
Wetted element	Porosity plate 60 pcs.	Porosity plate 90 pcs.	Porosity plate 120 pcs. (60×2 pcs.)
Water inlet port	φ6.4 C1220T (Flare Connection)		
Water outlet port	PT3/4		
Supply water pressure	kg/cm <sup>2</sup>	0.2 (Min.) ~ 5.0 (Max.)	

#### NOTES

- 1 Feed clean water (city water, tap water or equivalent). Dirty water may clog the valve or cause dirt deposits in the water container, resulting in poor humidifier performance. (Never use any cooling tower water and heating - purpose water. Also, if the supply water is hard water, use a water softener because of short life.  
\*Life of humidifying element is about 3 years (4,000 hours), under the supply water conditions of hardness: 150 mg/l. (Life of humidifying element is about 1 year (1,500 hours) under the supply water conditions of hardness: 400 mg/l.)  
Annual operating hours: 10 hours / day × 26 days / month × 5 month = 1,300 hours
- 2 Maintain the supply water temperature at 5 ~ 50°C and its pressure at 20 ~ 490 kPa (0.2 ~ 5.0 kg/cm<sup>2</sup>). If the water pressure is above 490 kPa (5.0 kg/cm<sup>2</sup>), add pressure reducing valve in between the kit and the supply water shut - off valve.
- 3 The supply water line cannot be directly connected with a utility water tap. To unavoidably take water from such line, employ a CISTERN (gotten configuration authorization).
- 4 Be sure to provide thermal insulation around the indoor piping as well as the shut - off valves.
- 5 In order to prevent harmful bacteria from generating, do maintenance on humidifying unit portion at the beginning and the end of the heating season according to the operation manual.

# 7 Product Specification

## 7 - 1 VKM-GAMV1

### 7 - 1 - 2 Options

#### VKM-GA(M)V1

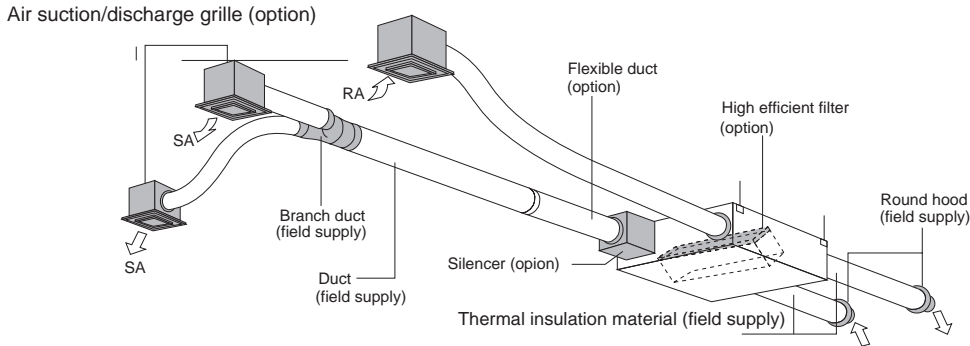

		VKM-GAV1											
Controlling device	Remote control	BRC1A62 (General market) BRC1D527 (EC market) (*#1)											
	Centralized controlling device	Central remote control	DCS302C51										
		Unified ON/OFF control	DCS301B61 (General market) DCS301B51 (EC market)										
		Schedule timer	DST301B51										
	PC board adapter	Wiring adapter for electrical appendices	KRP2A61 (General market) KRP2A51 (EC market)										
		For ON signal output	KRP50-2										
		For heater control kit	BRP4A50										
		For wiring	Type (indoor unit of VRV)	FXCQ-M	FXFQ-P	FXKQ-M	FXSQ-M	FXMQ-M	FXHQ-M	FXAQ-M	FXDQ-N	FXKQ-M FXNQ-M	FXZQ-M
			KRP1B61★	-		KRP1B61		KRPB3	-	KRP1B56	KRP1B61	KRP1B57	
		Installation box for adapter PCB ☆	KRP1B96 Notes 2, 3	KRP1D98 Notes 2, 3	-	KRP4A91 Notes 5	-	KRP1C93 Notes 3	KRP4A93 Notes 2, 3	KRP1B101 Notes 4, 6	-	KRP1B101 Notes 4, 6	

#### NOTES

- 1 Installation box ☆ is necessary for each adapter marked★.
- 2 Up to 2 adapters can be fixed for each installation box.
- 3 Only one installation box can be installed for each indoor unit.
- 4 Up to 2 installation boxes can be installed for each indoor unit.
- 5 Installation box ☆ is necessary for second adapter.
- 6 Installation box ☆ is necessary for each adapter.
- 7 \*#1 Necessary when operating HRV (VKM) independently. When operating interlocked with other air conditioners, use the remote control of the air conditioners.

		VKM-GA(M)V1			
		50	80	100	
Additional function	Silencer				
		Nominal pipe diameter (mm)		ø250	
	Air suction/Discharge grille	White	K-DGL200B		K-DGL250B
		Nominal pipe diameter (mm)	ø200		ø250
	High efficiency filter		KAF241G80M		KAF241G100M
Air filter for replacement		KAF242G80M		KAF242G100M	
	Flexible duct (1m)		K-FDS201C	K-FDS251C	
	Flexible duct (2m)		K-FDS202C	K-FDS252C	



Remote Control



Centralised remote control



Unified ON/OFF controller



Schedule timer



Silencer



Air suction/discharge grille  
(Noise suppression type)



Flexible duct  
(Noise suppression type)

# 7 Product Specification

## 7 - 1 VKM-GAMV1

### 7 - 1 - 3 Capacity tables

#### 7 - 1 - 3 - 1 Cooling capacity tables

##### VKM-GA(M)

TC: Total capacity : kW; SHC : Sensible heat capacity : kW

Class	Capacity DX-Coil Only	Outdoor °CDB	Coil Inlet air temp. °CDB													
			14.0WB		16.0WB		18.0WB		19.0WB		20.0WB		22.0WB		24.0WB	
			20.0DB		23.0DB		26.0DB		27.0DB		28.0DB		30.0DB		32.0DB	
			TC	SHC	TC	SHC	TC	SHC	TC	SHC	TC	SHC	TC	SHC	TC	SHC
50	2.8kW index 25	10.0	1.9	1.5	2.3	1.8	2.6	2.0	2.8	2.0	—	—	—	—	—	—
		12.0	1.9	1.5	2.3	1.8	2.6	2.0	2.8	2.0	—	—	—	—	—	—
		14.0	1.9	1.5	2.3	1.8	2.6	2.0	2.8	2.0	3.0	2.0	—	—	—	—
		16.0	1.9	1.5	2.3	1.8	2.6	2.0	2.8	2.0	3.0	2.0	—	—	—	—
		18.0	1.9	1.5	2.3	1.8	2.6	2.0	2.8	2.0	3.0	2.0	—	—	—	—
		20.0	1.9	1.5	2.3	1.8	2.6	2.0	2.8	2.0	3.0	2.0	—	—	—	—
		21.0	—	—	2.3	1.8	2.6	2.0	2.8	2.0	3.0	2.0	—	—	—	—
		23.0	—	—	2.3	1.8	2.6	2.0	2.8	2.0	3.0	2.0	3.3	2.1	—	—
		25.0	—	—	2.3	1.8	2.6	2.0	2.8	2.0	3.0	2.0	3.3	2.0	—	—
		27.0	—	—	2.3	1.8	2.6	2.0	2.8	2.0	3.0	2.0	3.2	2.0	—	—
		29.0	—	—	2.3	1.8	2.6	2.0	2.8	2.0	3.0	2.0	3.2	2.0	—	—
		31.0	—	—	2.3	1.8	2.6	2.0	2.8	2.0	3.0	2.0	3.1	2.0	—	—
		33.0	—	—	2.3	1.8	2.6	2.0	2.8	2.0	3.0	2.0	3.1	2.0	3.1	1.8
		35.0	—	—	—	—	2.6	2.0	2.8	2.0	3.0	2.0	3.0	1.9	3.1	1.8
37.0	—	—	—	—	2.6	2.0	2.8	2.0	2.9	2.0	3.0	1.9	3.0	1.8		
39.0	—	—	—	—	2.6	2.0	2.8	2.0	2.9	2.0	2.9	1.9	3.0	1.8		
80	4.5kW index 40	10.0	3.0	2.1	3.6	2.4	4.2	2.7	4.5	2.7	—	—	—	—	—	—
		12.0	3.0	2.1	3.6	2.4	4.2	2.7	4.5	2.7	—	—	—	—	—	—
		14.0	3.0	2.1	3.6	2.4	4.2	2.7	4.5	2.7	4.8	3.3	—	—	—	—
		16.0	3.0	2.1	3.6	2.4	4.2	2.7	4.5	2.7	4.8	2.8	—	—	—	—
		18.0	3.0	2.1	3.6	2.4	4.2	2.7	4.5	2.7	4.8	2.8	—	—	—	—
		20.0	3.0	2.1	3.6	2.4	4.2	2.7	4.5	2.7	4.8	2.8	—	—	—	—
		21.0	—	—	3.6	2.4	4.2	2.7	4.5	2.7	4.8	2.8	—	—	—	—
		23.0	—	—	3.6	2.4	4.2	2.7	4.5	2.7	4.8	2.8	5.3	2.9	—	—
		25.0	—	—	3.6	2.4	4.2	2.7	4.5	2.7	4.8	2.8	5.2	2.9	—	—
		27.0	—	—	3.6	2.4	4.2	2.7	4.5	2.7	4.8	2.8	5.1	2.8	—	—
		29.0	—	—	3.6	2.4	4.2	2.7	4.5	2.7	4.8	2.8	5.1	2.8	—	—
		31.0	—	—	3.6	2.4	4.2	2.7	4.5	2.7	4.8	2.8	5.0	2.8	—	—
		33.0	—	—	3.6	2.4	4.2	2.7	4.5	2.7	4.8	2.8	4.9	2.7	5.0	2.6
		35.0	—	—	—	—	4.2	2.7	4.5	2.7	4.7	2.8	4.8	2.7	4.9	2.6
37.0	—	—	—	—	4.2	2.7	4.5	2.7	4.6	2.8	4.8	2.7	4.9	2.6		
39.0	—	—	—	—	4.2	2.7	4.5	2.7	4.6	2.7	4.7	2.6	4.8	2.5		
100	5.6kW index 50	10.0	3.8	2.5	4.5	2.9	5.2	3.3	—	—	—	—	—	—	—	—
		12.0	3.8	2.5	4.5	2.9	5.2	3.3	5.6	3.3	—	—	—	—	—	—
		14.0	3.8	2.5	4.5	2.9	5.2	3.3	5.6	3.3	—	—	—	—	—	—
		16.0	3.8	2.5	4.5	2.9	5.2	3.3	5.6	3.3	6.0	3.4	—	—	—	—
		18.0	3.8	2.5	4.5	2.9	5.2	3.3	5.6	3.3	6.0	3.4	—	—	—	—
		20.0	3.8	2.5	4.5	2.9	5.2	3.3	5.6	3.3	6.0	3.4	—	—	—	—
		21.0	—	—	4.5	2.9	5.2	3.3	5.6	3.3	6.0	3.4	—	—	—	—
		23.0	—	—	4.5	2.9	5.2	3.3	5.6	3.3	6.0	3.4	—	—	—	—
		25.0	—	—	4.5	2.9	5.2	3.3	5.6	3.3	6.0	3.4	6.5	3.5	—	—
		27.0	—	—	4.5	2.9	5.2	3.3	5.6	3.3	6.0	3.4	6.4	3.5	—	—
		29.0	—	—	4.5	2.9	5.2	3.3	5.6	3.3	6.0	3.4	6.3	3.4	—	—
		31.0	—	—	4.5	2.9	5.2	3.3	5.6	3.3	6.0	3.4	6.2	3.4	—	—
		33.0	—	—	—	—	5.2	3.3	5.6	3.3	6.0	3.4	6.1	3.3	6.3	3.2
		35.0	—	—	—	—	5.2	3.3	5.6	3.3	5.9	3.3	6.0	3.3	6.2	3.2
37.0	—	—	—	—	5.2	3.3	5.6	3.3	5.8	3.3	5.9	3.2	6.1	3.1		
39.0	—	—	—	—	5.2	3.3	5.6	3.3	5.7	3.3	5.8	3.2	6.0	3.1		

NOTES

1 Cooling and heating capacities are based on the following conditons. Fan is based on High and Ultra-high? The figures in the parenthesis indicate the heat reclaimed from the heat recovery ventilator. When calculating the capacity as indoor units, use the following figures:

- VKM50GAMV1 : 3.5kW
- VKM80GAMV1 : 5.6kW
- VKM100GAMV1 : 7.0kW



# 7 Product Specification

## 7 - 1 VKM-GAMV1

### 7 - 1 - 3 Capacity tables

#### 7 - 1 - 3 - 2 Heating capacity tables

##### VKM-GA(M)

Class	Capacity DX-Coil Only	Outdoor		Coil Inlet air temp. °CDB					
		°CDB	°CWB	16.0kW	18.0kW	20.0kW	21.0kW	22.0kW	24.0kW
50	2.8kW index 25	-14.7	-15.0	2.2	2.2	—	—	—	—
		-12.6	-13.0	2.3	2.3	—	—	—	—
		-10.5	-11.0	2.4	2.4	—	—	—	—
		-9.5	-10.0	2.5	2.4	—	—	—	—
		-8.5	-9.1	2.5	2.5	—	—	—	—
		-7.0	-7.6	2.6	2.6	2.7	—	—	—
		-5.0	-5.6	2.7	2.7	2.7	—	—	—
		-3.0	-3.7	2.8	2.8	3.0	3.0	—	—
		0.0	-0.7	3.0	3.0	3.1	3.1	—	—
		3.0	2.2	3.1	3.1	3.2	3.1	3.0	—
		5.0	4.1	3.3	3.2	3.2	3.1	3.0	—
		7.0	6.0	3.4	3.4	3.2	3.1	3.0	—
		9.0	7.9	3.5	3.4	3.2	3.1	3.0	—
		11.0	9.8	3.6	3.4	3.2	3.1	3.0	2.8
		13.0	11.8	3.6	3.4	3.2	3.1	3.0	2.8
15.0	13.7	3.6	3.4	3.2	3.1	3.0	2.8		
80	4.5kW index 40	-14.7	-15.0	3.4	3.4	—	—	—	—
		-12.6	-13.0	3.6	3.6	—	—	—	—
		-10.5	-11.0	3.7	3.7	—	—	—	—
		-9.5	-10.0	3.9	3.7	—	—	—	—
		-8.5	-9.1	3.9	3.9	—	—	—	—
		-7.0	-7.6	4.1	4.1	4.2	—	—	—
		-5.0	-5.6	4.2	4.2	4.2	—	—	—
		-3.0	-3.7	4.4	4.4	4.7	4.6	—	—
		0.0	-0.7	4.7	4.7	4.9	4.9	—	—
		3.0	2.2	4.9	4.9	5.0	4.9	4.7	—
		5.0	4.1	5.2	5.0	5.0	4.9	4.7	—
		7.0	6.0	5.3	5.3	5.0	4.9	4.7	—
		9.0	7.9	5.5	5.3	5.0	4.9	4.7	—
		11.0	9.8	5.7	5.3	5.0	4.9	4.7	4.4
		13.0	11.8	5.7	5.3	5.0	4.9	4.7	4.4
15.0	13.7	5.7	5.3	5.0	4.9	4.7	4.4		
100	5.6kW index 50	-14.7	-15.0	4.4	4.4	—	—	—	—
		-12.6	-13.0	4.6	4.6	—	—	—	—
		-10.5	-11.0	4.8	4.8	—	—	—	—
		-9.5	-10.0	5.0	4.8	—	—	—	—
		-8.5	-9.1	5.0	5.0	—	—	—	—
		-7.0	-7.6	5.2	5.3	—	—	—	—
		-5.0	-5.6	5.4	5.4	5.4	—	—	—
		-3.0	-3.7	5.6	5.6	6.0	—	—	—
		0.0	-0.7	6.0	6.0	6.2	6.2	—	—
		3.0	2.2	6.2	6.2	6.4	6.2	6.0	—
		5.0	4.1	6.6	6.4	6.4	6.2	6.0	—
		7.0	6.0	6.8	6.8	6.4	6.2	6.0	—
		9.0	7.9	7.0	6.8	6.4	6.2	6.0	—
		11.0	9.8	7.2	6.8	6.4	6.2	6.0	5.6
		13.0	11.8	7.2	6.8	6.4	6.2	6.0	5.6
15.0	13.7	7.2	6.8	6.4	6.2	6.0	5.6		

#### NOTES

- 1 Cooling and heating capacities are based on the following conditions. Fan is based on High and Ultra-high. The figures in the parenthesis indicate the heat reclaimed from the heat recovery ventilator. When calculating the capacity as indoor units, use the following figures :  
 VKM50GAMV1 : 3.5kW  
 VKM80GAMV1 : 5.6kW  
 VKM100GAMV1 : 7.0kW

## 7 Product Specification

### 7 - 1 VKM-GAMV1

#### 7 - 1 - 3 Capacity tables

##### 7 - 1 - 3 - 3 Capacity correction factor

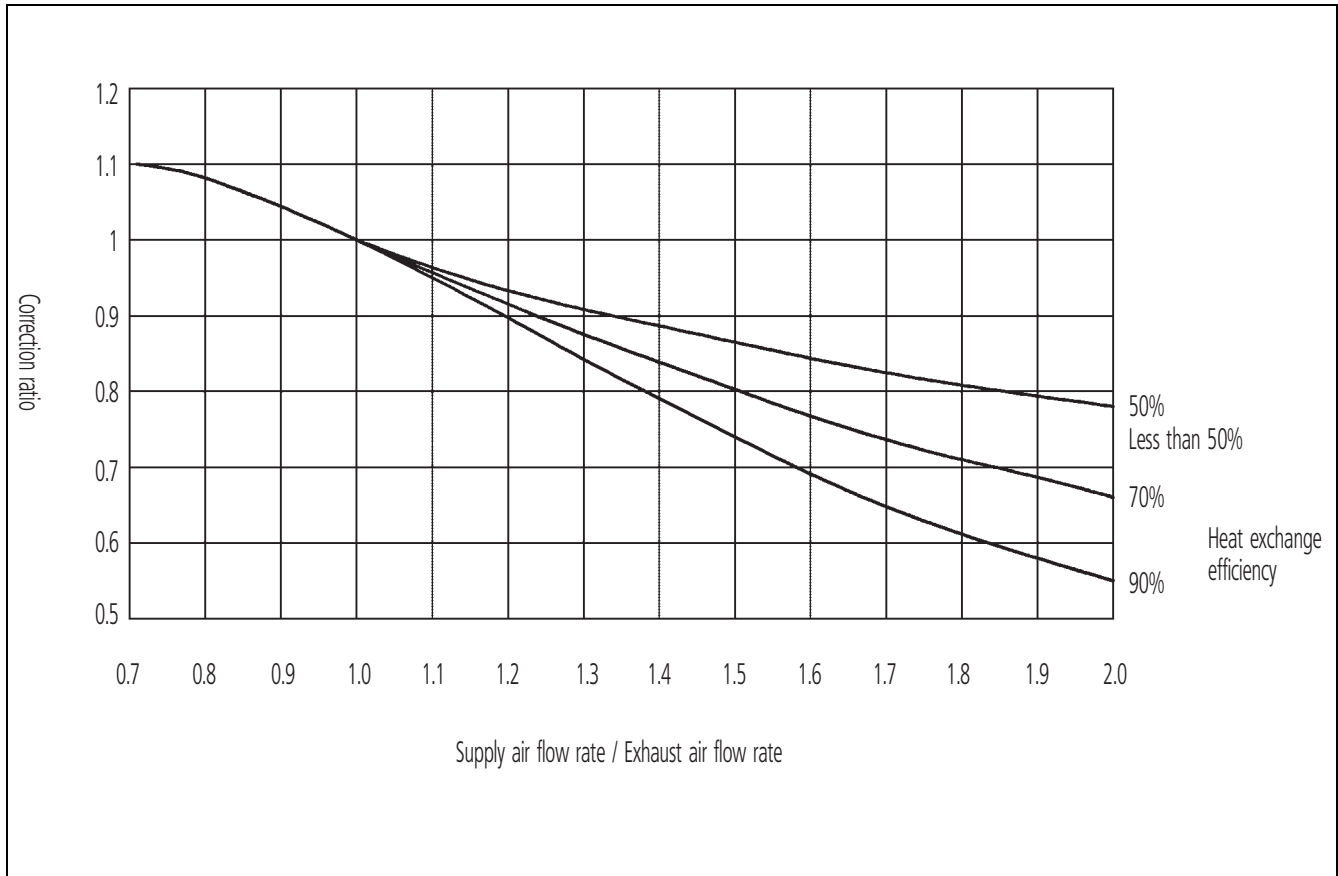

# 7 Product Specification

## 7 - 1 VKM-GAMV1

### 7 - 1 - 4 Dimensional drawing & centre of gravity

#### 7 - 1 - 4 - 1 Dimensional drawing

**VKM50GAMV1**

**NOTES**

- Specifications are subject to change without notice.
- Be sure to provide two inspection hatches (□450 or □600) at the service side of filters and elements.
- The high efficiency filter (option) can be attached to the SA surface of the heat exchanger elements.

3D051285

**VKM80GAMV1**

**NOTES**

- Specifications are subject to change without notice.
- Be sure to provide two inspection hatches (□450 or □600) at the service side of filters and elements.
- The high efficiency filter (option) can be attached to the SA surface of the heat exchanger elements.

3D051286

# 7 Product Specification

## 7 - 1 VKM-GAMV1

### 7 - 1 - 4 Dimensional drawing & centre of gravity

#### 7 - 1 - 4 - 1 Dimensional drawing

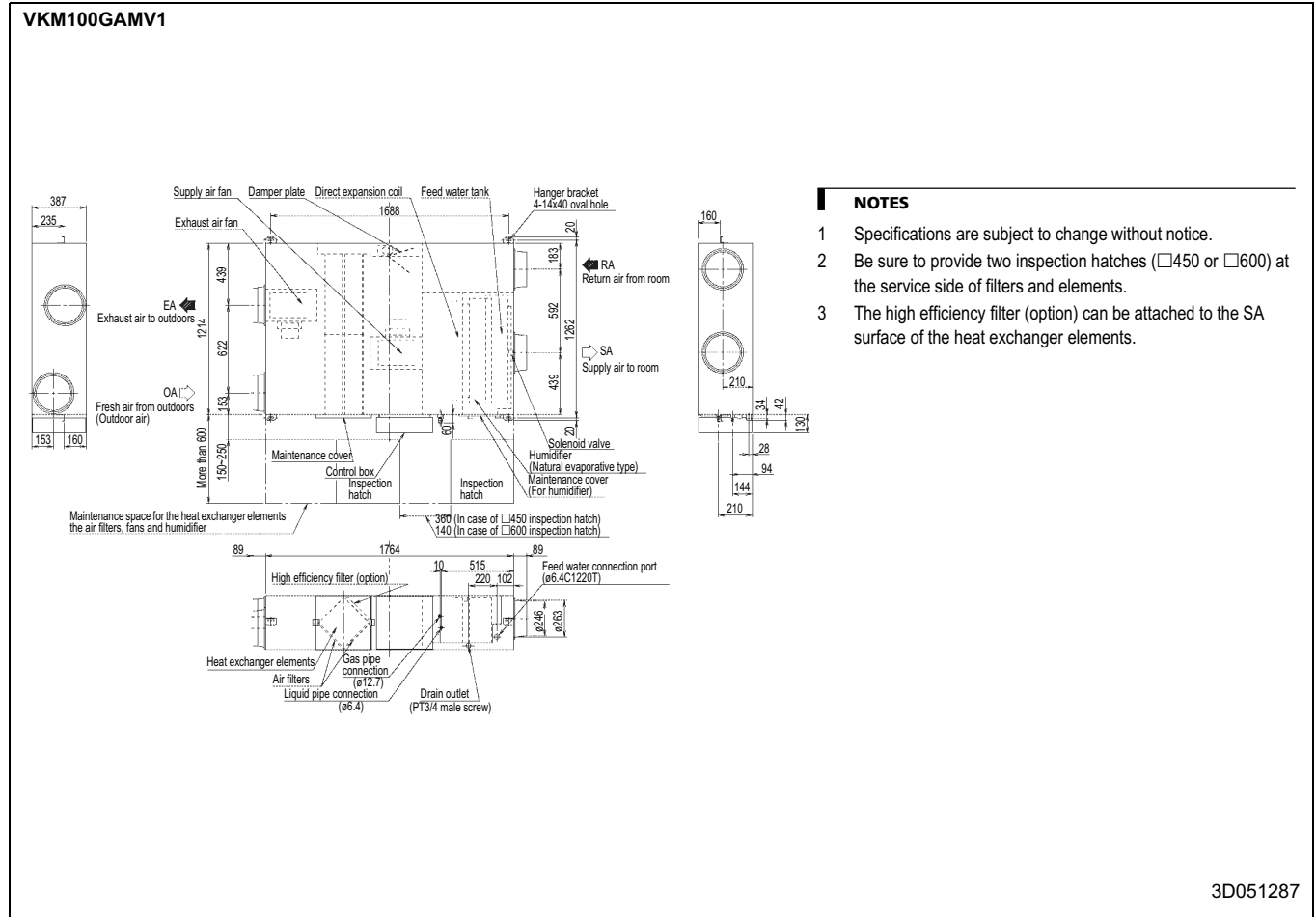

3D051287

# 7 Product Specification

## 7 - 1 VKM-GAMV1

### 7 - 1 - 5 Wiring diagram

VKM50,80,100GAMV1

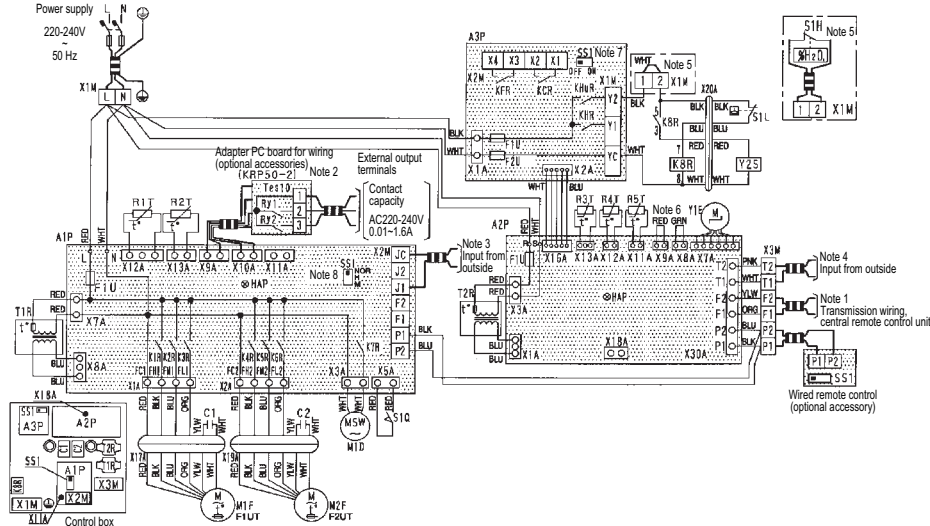

A1P	Indoor unit	KHR, KHuR	Magnetic relay (A3P)	X20A	Connector (relaying wire)
A2P	Printed circuit board	KSR	Magnetic relay (Y1S)	Y1E	Electronic expansion valve
A3P	Printed circuit board (adapter for wiring)	M1D	Motor (damper motor)	Y2S	Feed water solenoid valve
C1, C2	Capacitor (M1F)	M1F	Motor (supply air fan)		Optional accessories
F1U	Fuse (⊙, 10A, 250V) (A1P)	R1T	Thermistor (indoor air)		Wired remote control
F1U	Fuse (⊙, 5A, 250V) (A2P)	R2T	Thermistor (outdoor air)		SS1
F1U, F2U	Fuse (⊙, 5A, 250V) (A3P)	R3T	Thermistor (inlet air into coil)		Select switch (main/sub)
F1UT, F2UT	Fuse (⊙, 5A, 250V) (A3P)	R4T, R5Y	Thermistor (liquid/gas pipe of coil)		Adaptor PC board for wiring (KRP50-2)
HAP	Thermo switch (152°C) (M1F, M2F built-in)	S1L	Float switch (humidifier)		Ry1
HAP	Light emitting diode (service monitor-green) (A1P)	S1Q	Limit switch (damper motor)		Magnetic relay (operation/stop)
HAP	Light emitting diode (service monitor-green) (A2P)	SS1	Selector switch (for especially use) (A1P)		Ry2
K1R-K3R	Light emitting diode (service monitor-green) (A2P)	SS1	Selector switch (humidistat input) (A3P)		Magnetic relay (for humidifier operation)
K4R-K6R	Magnetic relay (M1F) (A1P)	T1R	Transformer (220-240V/22V)		Tes10
K7R	Magnetic relay (M2F) (A1P)	T2R	Transformer (220-240V/22V)		Terminal block (for external output)
K8R	Magnetic relay (M1D) (A1P)	X1M	Terminal block (power supply)		Connector for optional parts
KCR, KFR	Magnetic relay (S1L)	X1M, X2M	Terminal block (control) (A3P)		X11A
		X2M	Terminal block (control) (A1P)		Connector (adapter power supply) (A1P)
		X3M	Terminal block (control)		X18A
		X17A, X19A	Connector (relaying wire)		Connector (wiring adapter for electrical appendices) (A2P)
					Local supplied parts
				S1H	Humidistat

- : Terminal block
- ⊙, D- : Connector
- ⊙ : Short circuit connector
- : Terminal
- |—|— : Field wiring

- Colors:
- BLK: Black
  - BLU: Blue
  - GRN: Green
  - ORG: Orange
  - PNK: Pink
  - RED: Red
  - WHT: White
  - YLW: Yellow

3D051310

#### NOTES

- In case of using central remote control, connect it to the unit in accordance with the attached instruction manual.
- In case using wiring adapter, connect it to the unit in accordance with the attached installation manual.
- When connecting the input wires from outside, fresh up control operation can be selected by remot control, in details, refer to the installation manual attached the unit.
- When connecting the input wires from outside, forced off or on/off control operation can be selected by remot control, in details, refer to the In case of installation manual attached the unit.
- In case installing a humidistat S1H (locally procured), remove the short circuit wiring between (1) and (2) as shown in the figure right.
- Do not remove the short circuit connectors of X8A and X9A. The unit will not run if they are removed.
- SS1 (A3P) has already been set to off at factory set. Humidifying becomes impossible, if the setting are changed.
- SS1 (A1P) has already been set to 'nor', at factory set. The unit will not run if the setting are changed.
- Use copper conductors only.

# 7 Product Specification

## 7 - 1 VKM-GAMV1

### 7 - 1 - 6 Sound data

#### 7 - 1 - 6 - 1 Sound pressure spectrum

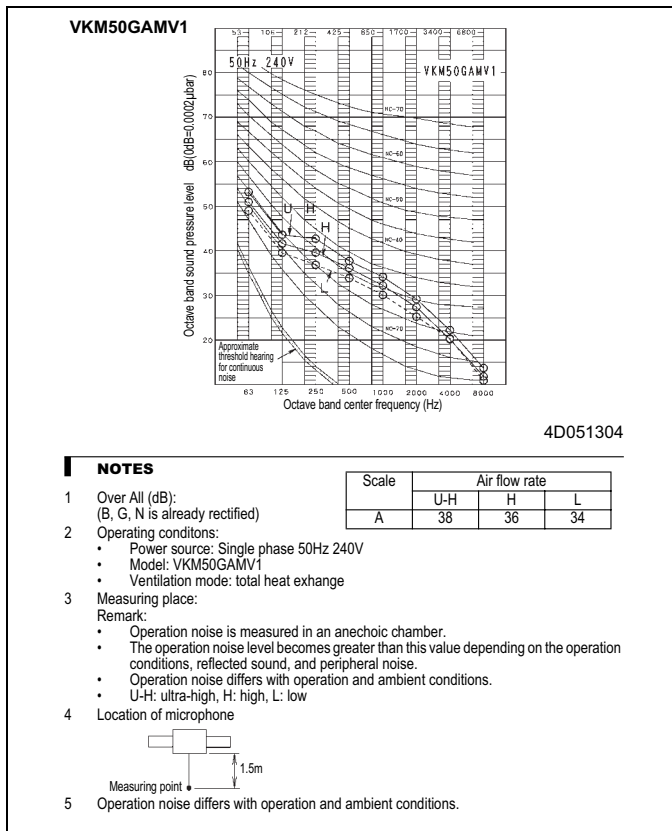
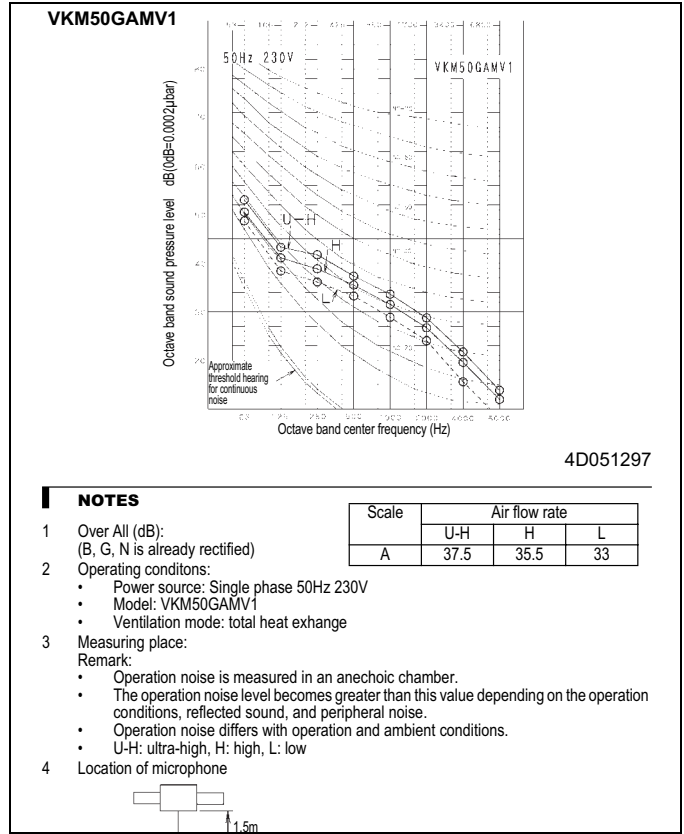
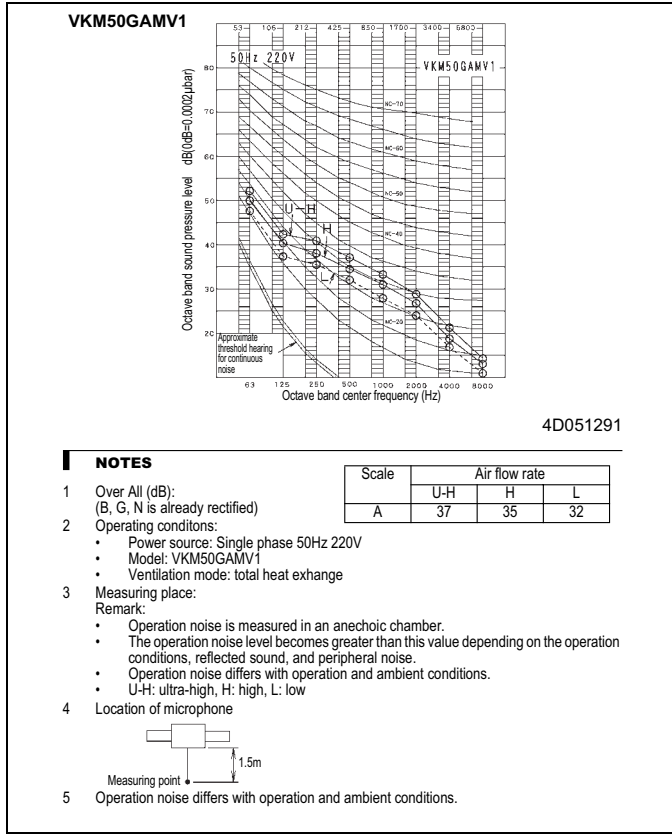

# 7 Product Specification

## 7 - 1 VKM-GAMV1

### 7 - 1 - 6 Sound data

#### 7 - 1 - 6 - 1 Sound pressure spectrum

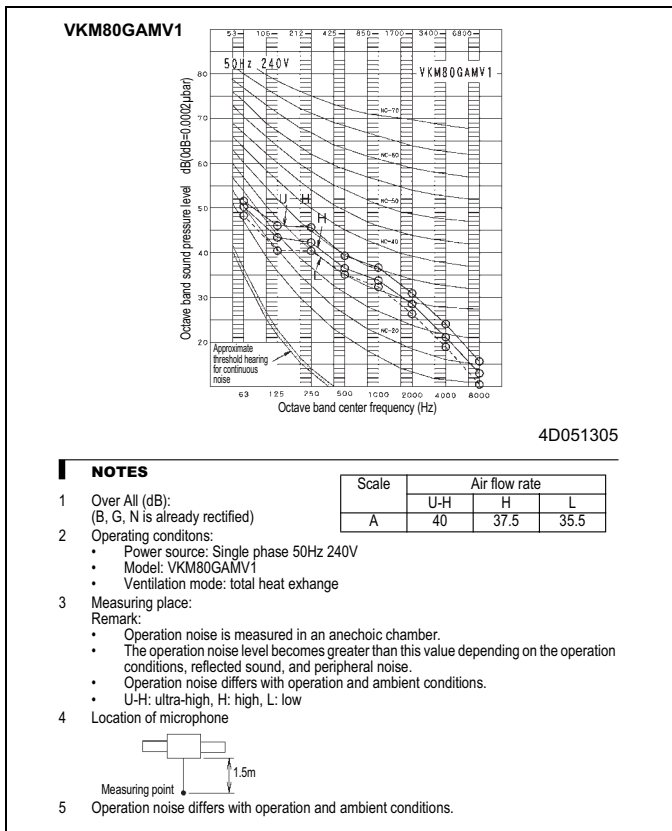
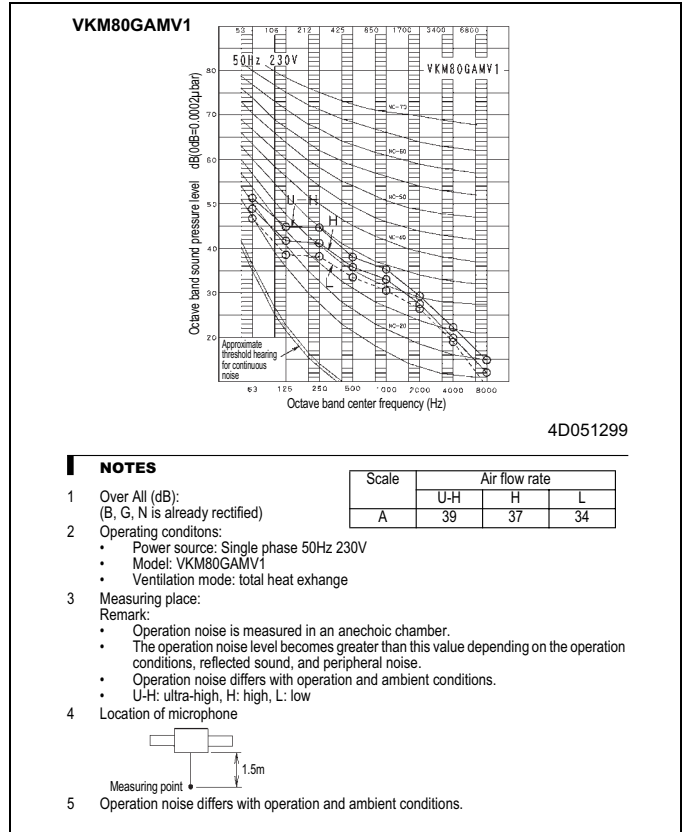
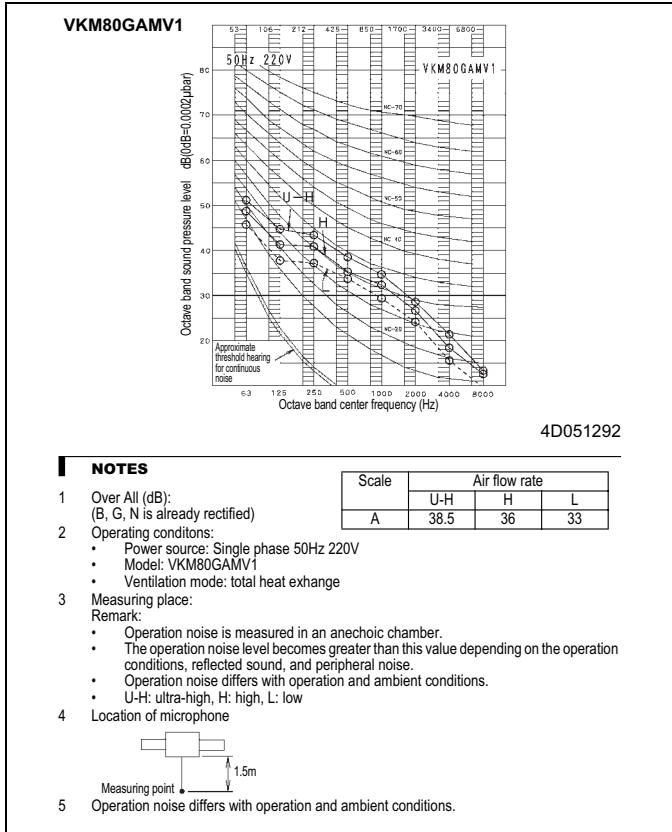

# 7 Product Specification

## 7 - 1 VKM-GAMV1

### 7 - 1 - 6 Sound data

#### 7 - 1 - 6 - 1 Sound pressure spectrum

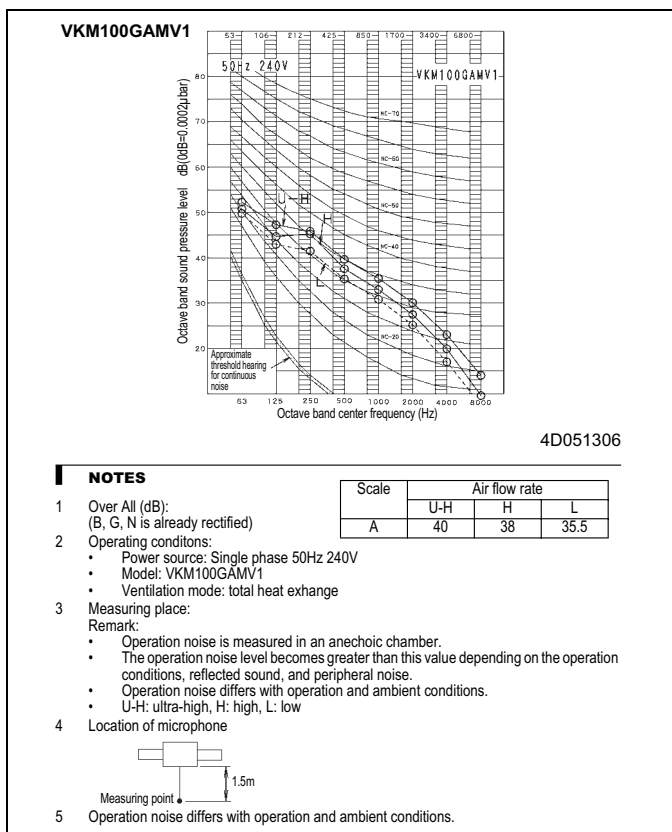
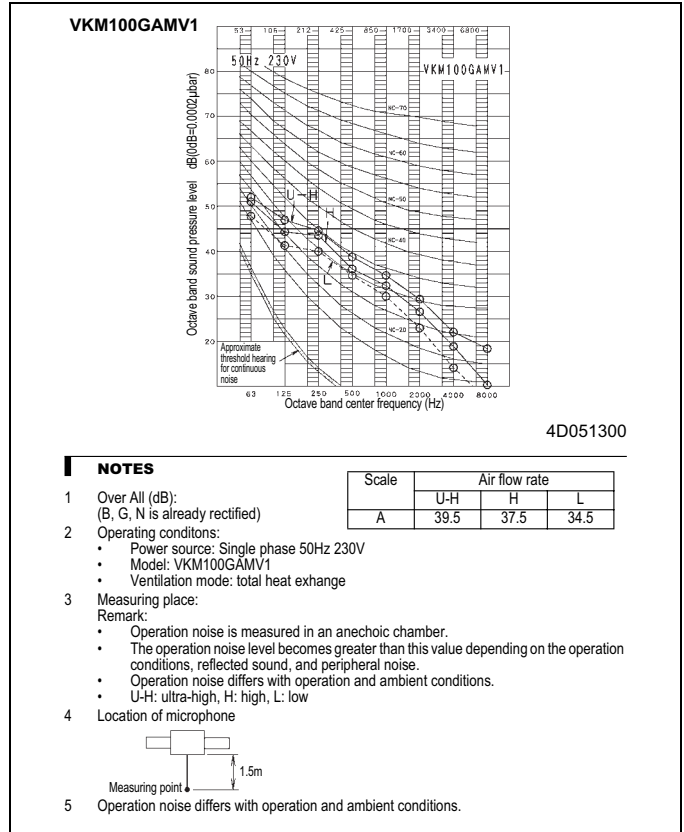
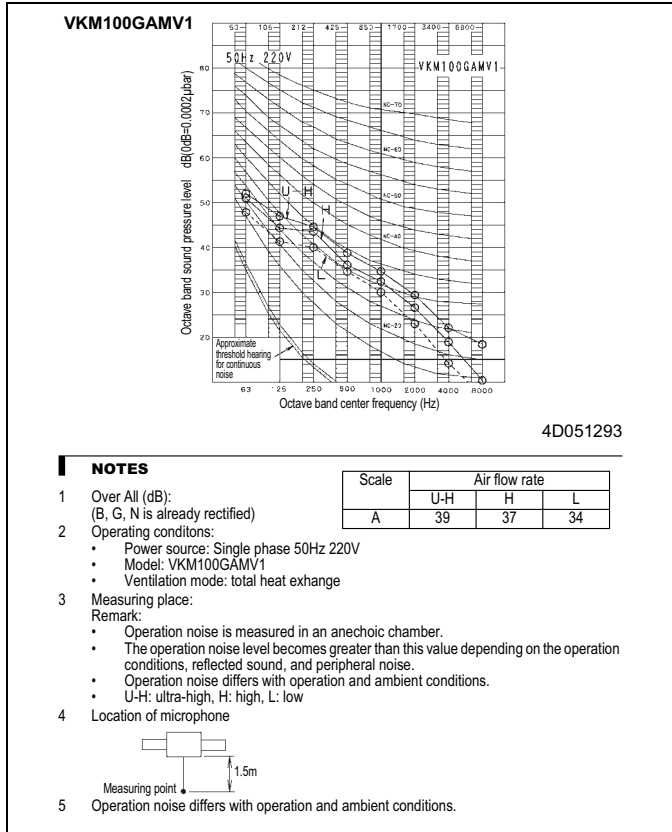



## 7 Product Specification

### 7 - 1 VKM-GAMV1

#### 7 - 1 - 7 Reducing Operating Sound

The air suction and discharge grille may give out operating sound higher by 8 to 11 phons than of the HRV units body. When installing this unit in a quiet place, take measures to reduce operating sound.

##### 7 - 1 - 7 - 1 Points for Reducing Operating Sound

1. Operating sound heard from the air discharge outlet can be reduced just by applying sound-insulating material to the SA (indoor air supply) duct.

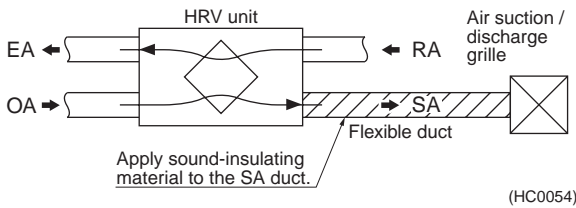

2. Operating sound can be reduced more effectively by applying sound-insulating material to a portion of the SA duct near the unit body than that near the air suction / discharge grille.

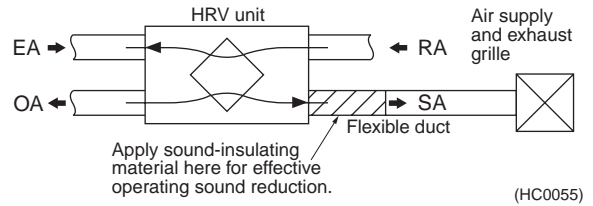

##### 7 - 1 - 7 - 2 Taking Measures to Reduce Operating Sound Heard from Attic-installed Equipment and Air Ducts.

1. When installing large air volume models (650 m<sup>3</sup> / h or more), avoid the following wherever possible if it is expected to be necessary to apply sound-insulating material to them. (Fig.1)

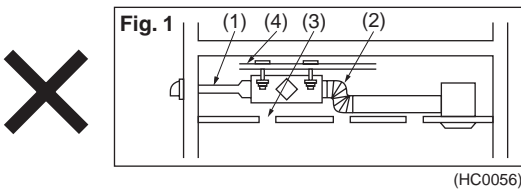

- (1) Making the duct diameter extremely small (Example:  $\phi$  250 →  $\phi$  150,  $\phi$  200 →  $\phi$  100)
- (2) Making the duct extremely bent using bellows (in particular, connecting bellows to the air discharge outlet of the unit body)
- (3) Making opening holes on the ceiling
- (4) Hanging the unit on a material which does not have enough hanging strength

2. Take the following sound reduction measures. (Fig.2)

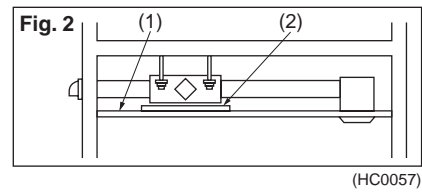

- (1) Use a sound-insulating (low-permeability-to-sound) ceiling.

**Note :**

Some sound-insulating ceilings are not very effective in reducing low-frequency element of the operating sound.

- (2) Place a sound-reducing material under the source of the operating sound.

**Note :**

When using a sound-insulating sheet, it is necessary to have the entire body of the unit covered with it. Note, however, that some models do not allow the use of a sound-insulating sheet because it may badly affect the ventilation of their radiation heat.

## 7 Product Specification

### 7 - 1 VKM-GAMV1

#### 7 - 1 - 7 Reducing Operating Sound

##### 7 - 1 - 7 - 3 Reducing Operating Sound Heard from the Air Discharge Outlet (Suction Inlet)

1. Use the following recommended optional accessories to reduce operating sound heard from attic-installed duct type models. (Fig.3)

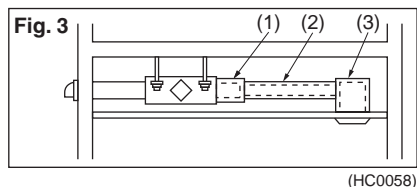

- (1) Sound-eliminating box (Silencer)
- (2) Flexible duct
- (3) Sound-eliminating air suction / discharge grille

2. If the above accessories do not give satisfactory effect or when an attic-installed cassette type model is used, take the following measure.

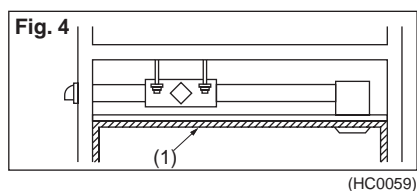

- (1) Apply a sound-absorbing material to the interior of the room.

##### 7 - 1 - 7 - 4 Effect of Remedy for Sound

###### Caution

1. Be sure to connect a flexible duct (2 m) to an outlet of the main body in the indoor air supply side.

3. To reduce the air flow sound heard from the air discharge outlet (suction inlet) of an attic-installed duct type model, use a small diameter flexible duct, which excels in sound absorptivity, for greater sound reduction effect.

- (1) Branched duct (for letting air flow through two ducts to slow down its speed before it reaches the air discharge outlets (suction inlets))

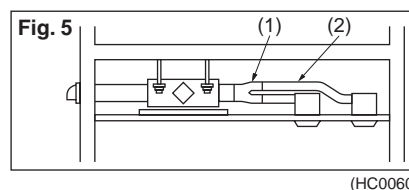

- (2) Flexible duct

4. Installation of the unit with the source of its operating sound located at a corner of a room will be a partially effective sound reduction measure; it will keep persons in the center of the room free from the annoying operating sound, with those in the corner of the room kept annoyed by the operating sound. To avoid this, try to find the best installation place from which the operating sound is least heard by everyone in the room.

2. Do not connect a spiral duct and an aluminium bellows directly to the outlet of the main body.

\*A silencer is effective especially when using the flexible duct at the same time.

# 7 Product Specification

## 7 - 1 VKM-GAMV1

### 7 - 1 - 7 Reducing Operating Sound

#### 7 - 1 - 7 - 5 General Comparison of the Effect ((1) → (6) in more Effective Order)

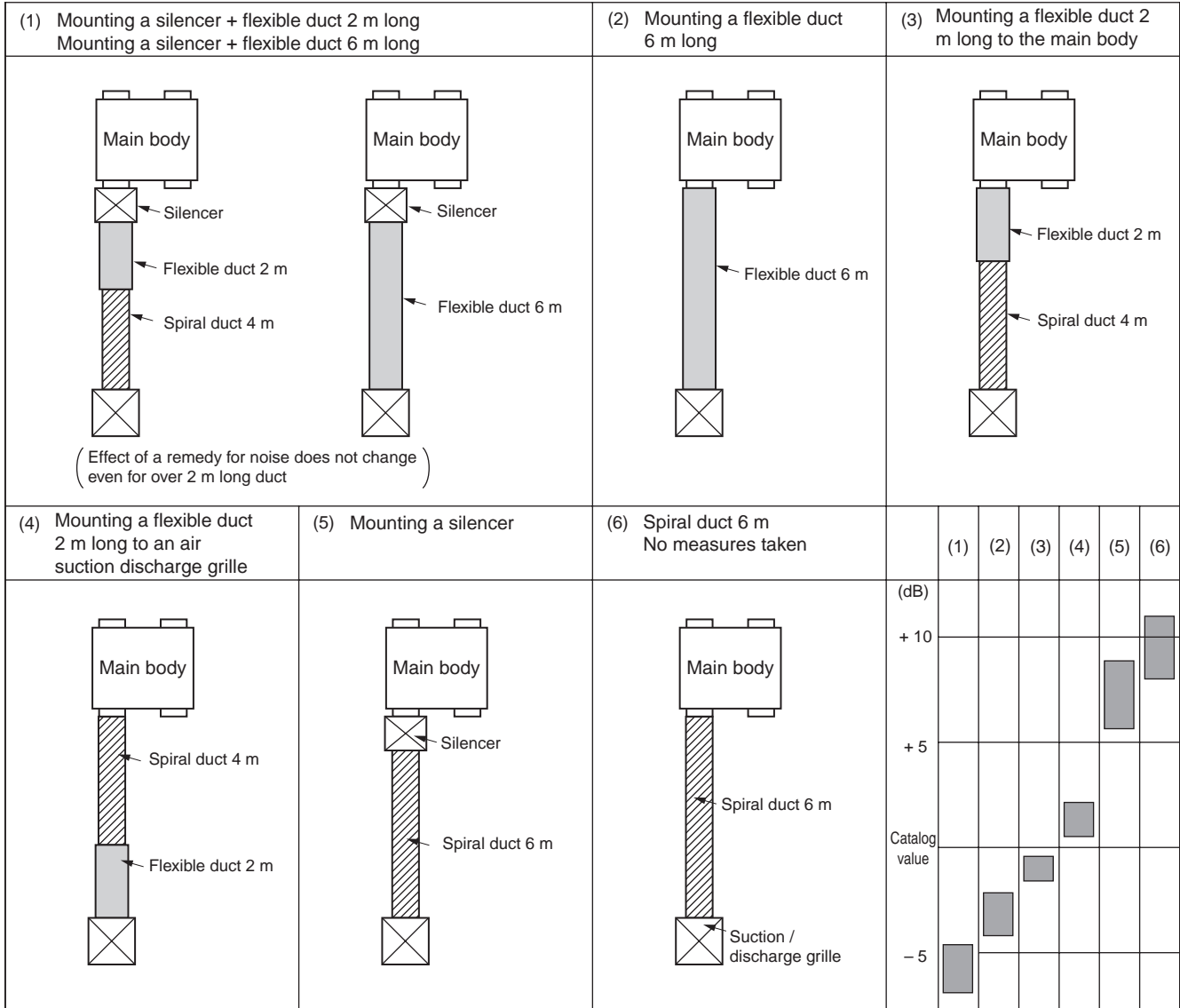

(HC0061)

**Note :**

Measure the noise at 1.5 m below the air supply grille. Operating noise conforms to JIS standard and the value is converted in terms of the anechoic chamber.

**7 - 1 - 7 - 6 Nameplate for Note**

"Notes for duct work" is written on the HRV units as indicated below.

<sup>2</sup> When connecting a spiral duct or an aluminum bellows, sound at the air discharge outlet is higher by 8~11 phon than the main body operating sound.

- When using this unit in a quiet place, take a remedy for sound by connecting an optional flexible duct at the outlet of the indoor air suction side of the main body.

# 7 Product Specification

## 7 - 1 VKM-GAMV1

### 7 - 1 - 8 Fan characteristics

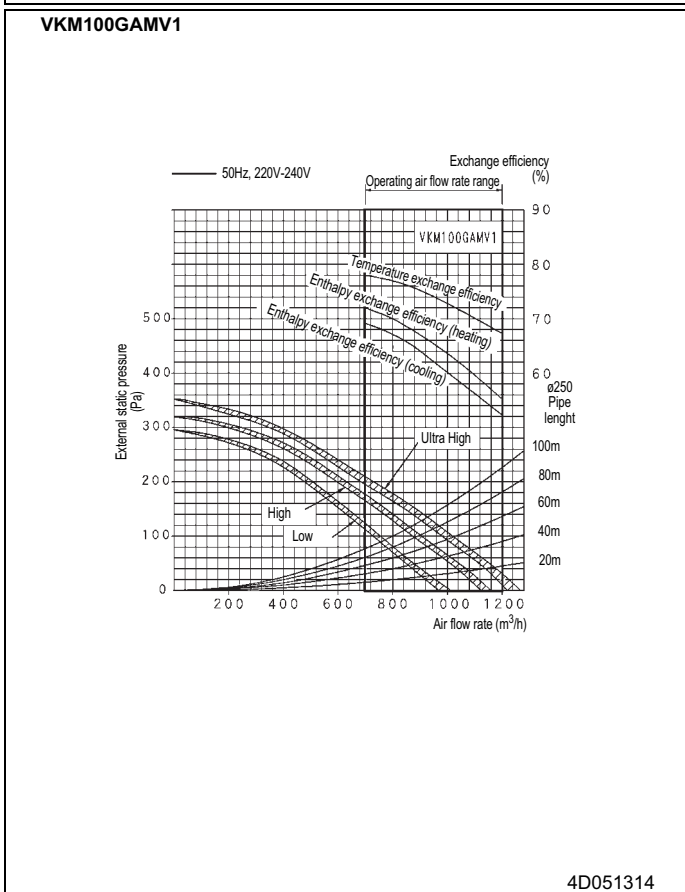
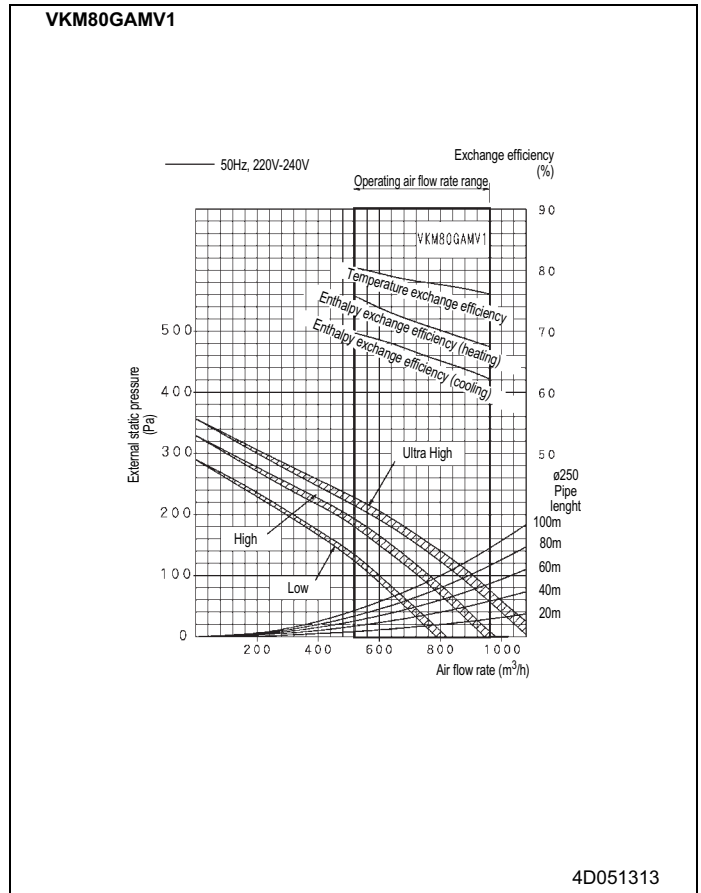
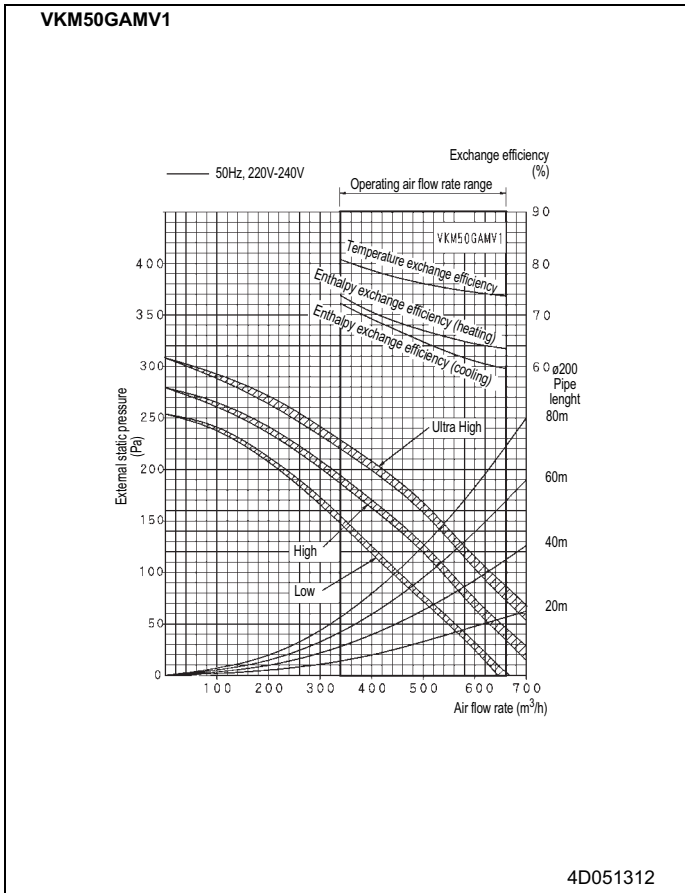

# 7 Product Specification

## 7 - 1 VKM-GAMV1

### 7 - 1 - 9 Installation

#### 7 - 1 - 9 - 1 Installation method

VKM50GAMV1

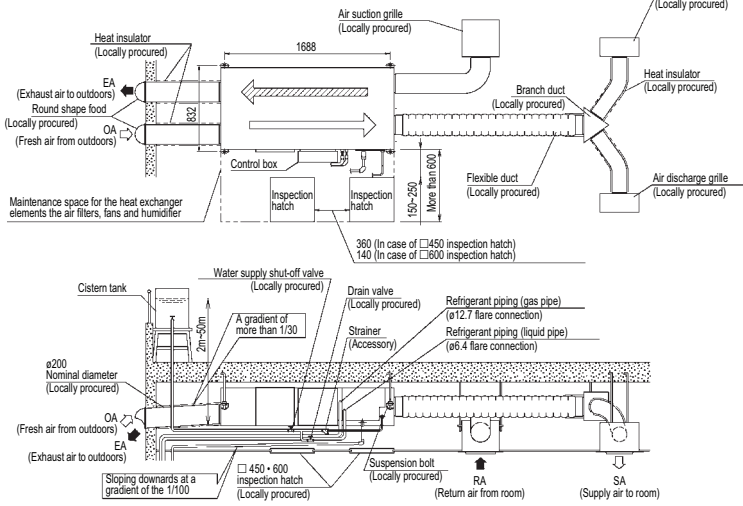

**NOTES**

- 1 Leave space for servicing the unit and include inspection hatch. (Always open a hole on the side of the control box so that the air filters, heat exchange elements, fans, and humidifier elements can easily be inspected and serviced.)
- 2 Install the two outdoor ducts with down slope (slope of 1/30 or more) to prevent entry of rain water, also, provide insulation for three ducts (outdoor ducts and indoor supply air duct) to prevent dew condensation (material: glass wool of 25mm thick).
- 3 Do not turn the unit upside down.
- 4 Use city water of clean water. Include water supply piping with strainer, a water supply shut-off valve, and a drain valve (both locally procured) somewhere along the water supply piping that can be reached from the inspection.
- 5 It is impossible to connect the water supply piping directly to public piping, use a cistern tank (of the approved type), if you need to get your water supply from public piping.
- 6 Make sure the supply water 0.02MPa to 0.49MPa (0.2kg/cm<sup>2</sup> to 5kg/cm<sup>2</sup>)
- 7 Make sure the supply water is between 5°C and 40°C in temperature.
- 8 Insulate the water supply piping to prevent condensation from forming.
- 9 Make sure install drain piping, and insulate drain piping to prevent dew condensation.
- 10 Keep the drain pipe short and sloping downwards at a gradient of at least 1/100 to prevent air from forming.
- 11 Install in a location where the air around the unit or taken into the humidifier will not drop below 0°C.
- 12 Do not use a bent cap or a round hood as the outdoor hood if they might get rained on directly (we recommend using a deep hood) (optional accessory).
- 13 In areas where freezing may occur, always take steps to prevent the pipes from freezing.
- 14 Do not place something which shouldn't be get wet at the below of this unit. The dew would fall at following case, where humidity is 80% more, or the exit of drain socket is choked up, or the air filter is very dirty.
- 15 Feed clean water, the supply water is hard water. Use water softener because of short life. Life of humidifying element is about 3 years 4,000 hours), under the supply water conditions of hardness: 150mg/L. (Life of humidifying element is about 1 year (1500 hours), under the supply water conditions of hardness: 400mg/L.)

3D051319

VKM80GAMV1

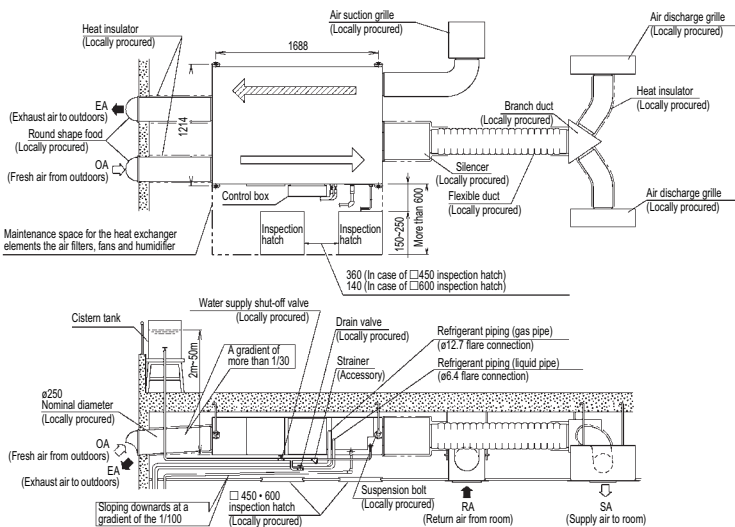

**NOTES**

- 1 Leave space for servicing the unit and include inspection hatch. (Always open a hole on the side of the control box so that the air filters, heat exchange elements, fans, and humidifier elements can easily be inspected and serviced.)
- 2 Install the two outdoor ducts with down slope (slope of 1/30 or more) to prevent entry of rain water, also, provide insulation for three ducts (outdoor ducts and indoor supply air duct) to prevent dew condensation (material: glass wool of 25mm thick).
- 3 Do not turn the unit upside down.
- 4 Use city water of clean water. Include water supply piping with strainer, a water supply shut-off valve, and a drain valve (both locally procured) somewhere along the water supply piping that can be reached from the inspection.
- 5 It is impossible to connect the water supply piping directly to public piping, use a cistern tank (of the approved type), if you need to get your water supply from public piping.
- 6 Make sure the supply water 0.02MPa to 0.49MPa (0.2kg/cm<sup>2</sup> to 5kg/cm<sup>2</sup>)
- 7 Make sure the supply water is between 5°C and 40°C in temperature.
- 8 Insulate the water supply piping to prevent condensation from forming.
- 9 Make sure install drain piping, and insulate drain piping to prevent dew condensation.
- 10 Keep the drain pipe short and sloping downwards at a gradient of at least 1/100 to prevent air from forming.
- 11 Install in a location where the air around the unit or taken into the humidifier will not drop below 0°C.
- 12 Do not use a bent cap or a round hood as the outdoor hood if they might get rained on directly (we recommend using a deep hood) (optional accessory).
- 13 In areas where freezing may occur, always take steps to prevent the pipes from freezing.
- 14 Do not place something which shouldn't be get wet at the below of this unit. The dew would fall at following case, where humidity is 80% more, or the exit of drain socket is choked up, or the air filter is very dirty.
- 15 Feed clean water, the supply water is hard water. Use water softener because of short life. Life of humidifying element is about 3 years 4,000 hours), under the supply water conditions of hardness: 150mg/L. (Life of humidifying element is about 1 year (1500 hours), under the supply water conditions of hardness: 400mg/L.)

3D051320

# 7 Product Specification

## 7 - 1 VKM-GAMV1

### 7 - 1 - 9 Installation

#### 7 - 1 - 9 - 1 Installation method

VKM100GAMV1

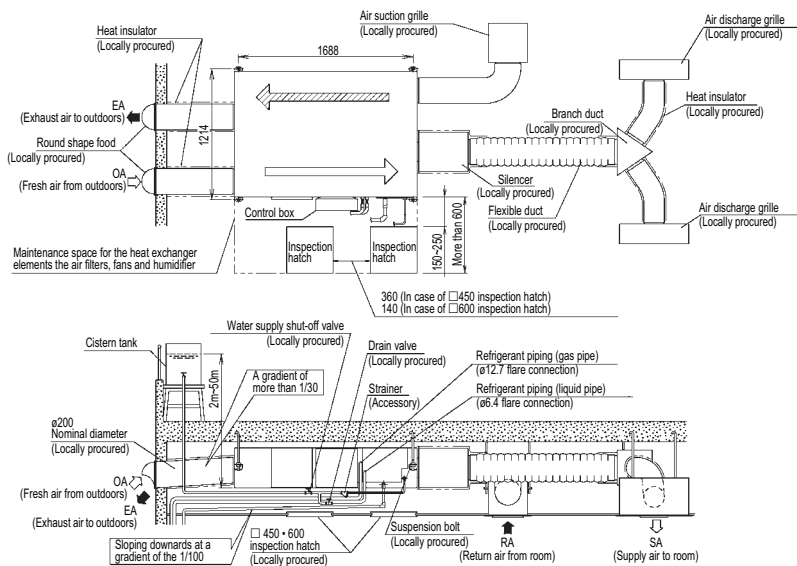

#### NOTES

- 1 Leave space for servicing the unit and include inspection hatch. (Always open a hole on the side of the control box so that the air filters, heat exchange elements, fans, and humidifier elements can easily be inspected and serviced.)
- 2 Install the two outdoor ducts with down slope (slope of 1/30 or more) to prevent entry of rain water, also, provide insulation for three ducts (outdoor ducts and indoor supply air duct) to prevent dew condensation) (material: glass wool of 25mm thick).
- 3 Do not turn the unit upside down.
- 4 Use city water of clean water. Include water supply piping with strainer, a water supply shut-off valve, and a drain valve (both locally procured) somewhere along the water supply piping that can be reached from the inspection.
- 5 It is impossible to connect the water supply piping directly to public piping, use a cistern tank (of the approved type), if you need to get your water supply from public piping.
- 6 Make sure the supply water 0.02MPa to 0.49MPa (0.2kg/cm<sup>2</sup> to 5kg/cm<sup>2</sup>)
- 7 Make sure the supply water is between 5°C and 40°C in temperature.
- 8 Insulate the water supply piping to prevent condensation from forming.
- 9 Make sure install drain piping, and insulate drain piping to prevent dew condensation.
- 10 Keep the drain pipe short and sloping downwards at a gradient of at least 1/100 to prevent air from forming.
- 11 Install in a location where the air around the unit or taken into the humidifier will not drop below 0°C.
- 12 Do not use a bent cap or a round hood as the outdoor hood if they might get rained on directly (we recommend using a deep hood) (optional accessory).
- 13 In areas where freezing may occur, always take steps to prevent the pipes from freezing.
- 14 Do not place something which shouldn't be get wet at the below of this unit. The dew would fall at following case, where humidity is 80% more, or the exit of drain socket is choked up, or the air filter is very dirty.
- 15 Feed clean water, the supply water is hard water. Use water softener because of short life. Life of humidifying element is about 3 years 4,000 hours, under the supply water conditions of hardness: 150mg/L. (Life of humidifying element is about 1 year (1500 hours), under the supply water conditions of hardness: 400mg/L.)

3D051321

# 7 Product Specification

## 7 - 2 VKM-GAV1

### 7 - 2 - 1 Specifications

TECHNICAL SPECIFICATIONS				VKM50GAV1	VKM80GAV1	VKM100GAV1	
Fresh air conditioning load	Cooling		kW	4.71	7.46	9.12	
	Heating		kW	5.58	8.79	10.69	
Power input (nominal)	Heat exchange mode	Ultra-high	kW	0.560	0.620	0.670	
		High	kW	0.490	0.560	0.570	
		Low	kW	0.420	0.470	0.480	
	Bypass mode	Ultra-high	kW	0.560	0.620	0.670	
		High	kW	0.490	0.560	0.570	
		Low	kW	0.420	0.470	0.480	
Casing	Material	Galvanised steel plate					
Dimensions	Height		mm	387	387	387	
	Width		mm	1764	1764	1764	
	Depth		mm	832	1214	1214	
Weight			kg	96	109	114	
Heat exchanger	Rows			2	2	2	
	Stages			12	12	12	
	Fin pitch		mm	2.2	2.2	2.2	
	Face area		m <sup>2</sup>	0.078	0.118	0.165	
Fan	Type	Sirocco fan					
Air Flow Rate	Heat exchange mode	Ultra-high	m	500	750	950	
		High	m	500	750	950	
		Low	m	440	640	820	
	Bypass mode	Ultra-high	m	500	750	950	
		High	m	500	750	950	
		Low	m	440	640	820	
Fan	External static pressure	Ultra-high	Pa	180	170	150	
		High	Pa	150	120	100	
		Low	Pa	110	80	70	
	Motor	Quantity			2	2	2
		Output	W		280	280	280
Temperature exchange efficiency	Ultra-high			%	76	78	74
	High			%	76	78	74
	Low			%	77.5	79	76.5
Enthalpy exchange efficiency	Cooling	Ultra-high	%	64	66	62	
		High	%	64	66	62	
		Low	%	67	68	66	
	Heating	Ultra-high	%	67	71	65	
		High	%	67	71	65	
		Low	%	69	73	69	
Operation Range	Outdoor air			-15	-15	-15	
Heat exchange mode	Sound Pressure	Ultra-high	dBA	38/38.5/39	40/41/41.5	40/40.5/41	
		High	dBA	36/36.5/37	37.5/38/39	38/38.5/39	
		Low	dBA	33.5/34.5/35.5	34.5/36/37	35/36/36.5	
Bypass mode	Sound Pressure	Ultra-high	dBA	38/38.5/39	40/41/41.5	40/40.5/41	
		High	dBA	36/36.5/37	37.5/38/39	38/38.5/39	
		Low	dBA	33.5/34.5/35.5	34.5/36/37	35/36/36.5	
Piping connection	Liquid	Type	flare connection				
		Diameter	mm	6.4	6.4	6.4	
	Gas	Type	flare connection				
		Diameter	mm	12.7	12.7	12.7	
Drain	PT3/4 external thread						
Refrigerant control	electronic expansion valve						
Insulation material	Self-extinguishable urethane foam						
Heat exchange system	Air to air cross flow total heat (sensible + latent heat) exchange						
Heat exchange element	Specially processed non-flammable paper						
Air Filter	Multidirectional fibrous fleeces						

TECHNICAL SPECIFICATIONS		VKM50GAV1	VKM80GAV1	VKM100GAV1
Connection duct diameter	mm	200	250	250
Operation mode		Heat exchange mode, bypass mode, fresh-up mode		
Standard Accessories	Item	Installation and operation manual		
		Duct connection flange		
		M4 tapping screw to connect duct		
		refrigerant piping insulation cover		
		clamp		
Notes		<p>Cooling and heating capacities are based on the following conditions: Fan is based on High and Ultra High. The figures in parenthesis indicate the heat reclaimed from the heat recovery ventilator. When calculating the capacity as indoor units, use 3.5kW.</p>	<p>Cooling and heating capacities are based on the following conditions: Fan is based on High and Ultra High. The figures in parenthesis indicate the heat reclaimed from the heat recovery ventilator. When calculating the capacity as indoor units, use 5.6kW.</p>	<p>Cooling and heating capacities are based on the following conditions: Fan is based on High and Ultra High. The figures in parenthesis indicate the heat reclaimed from the heat recovery ventilator. When calculating the capacity as indoor units, use 7.0kW.</p>
		Cooling capacities are based on: indoor temperature: 27		
		Heating capacities are based on: indoor temperature: 20		
		Operation sound measured at 1.5m below the center of the unit is converted to that measured in an anechoic chamber, built in accordance with JIS C1502 condition. The actual operation sound varies depending on the surrounding conditions (near running unit)		
		The sound level at the air discharge port is about 8-11dB higher than the unit's operating sound. For operation in a quiet room, it is required to take measures to lower the sound, for example install more than 2m soft duct near the air discharge grille		
		Air flow rate can be changed over to Low mode or High mode.		
		Normal amplitude, input, efficiency depend on the other above conditions		
		OA: fresh air from outdoor, RA: return air from the room		
		The specifications, designs and information here are subject to change without notice		
		Temperature Exchange Efficiency is a mean value in cooling and heating		
		Efficiency is measured under following condition: ratio of rated external static pressure has been kept as follows: outdoor side to indoor side = 7 to 1		
		During the heating operation the freezing of the outdoor unit coil increases, heating capacity decreases and the system goes into defrost operation. During defrost operation the fans of the units continue driving (factory settings), the purpose of this is to maintain the amount of ventilation and humidification.		
		When connecting with a VRV Heat Recovery outdoor unit, bring the RA (exhaust gas intake) of this unit directly in from the ceiling. Connect to a BS unit identical to the VRV outdoor unit (master unit), and use group-linked operation.		
		When connecting the indoor unit directly to the duct, always take the same system on the indoor unit as with the outdoor unit. Perform group-linked operation and make the direct duct connection settings from the remote controller. (Mode No. '17 (27)' -first code n° '5' - Second Code n° '6') Do not connect to the outlet side of the indoor unit, depending on the fan strength and static pressure the unit might back up.		



ELECTRICAL SPECIFICATIONS				VKM50GAV1	VKM80GAV1	VKM100GAV1
Power Supply	Name			V1		
	Phase			1	1	1
	Frequency	Hz		50	50	50
	Voltage		V	220-240		
Nominal running current (RLA)	Heat exchange mode	Ultra-high	A	3.00	3.00	3.00
		High	A	2.50	2.60	2.50
		Low	A	2.10	2.10	2.10
	Bypass mode	Ultra-high	A	3.00	3.00	3.00
		High	A	2.50	2.60	2.50
		Low	A	2.10	2.10	2.10
Current	Minimum circuit amps (MCA)		A	4.30	4.30	4.30
	Maximum fuse amps (MFA)		A	15	15	15
	Fan motor rated output		kW	0.28 x 2		
	Full load amps (FLA)		A	1.9 x 2		
Voltage range	Minimum		V	198	198	198
	Maximum		V	264	264	264
Notes				Voltage range : Units are suitable for use on the electrical systems where the voltage supplied to the unit terminals is not below or above the listed range limits.		
				Maximum allowable voltage range variation between phases is 2%		
				MCA/MFA : MCA = 1.25 x FLA (FM1) + FLA (FM2) ; MFA <= 4 x FLA ; (Next lower standard fuse rating. Min. 15A		
				Select wire size based on the value of MCA.		
				Instead of the fuse, use the circuit breaker.		

# 7 Product Specification

## 7 - 2 VKM-GAV1

### 7 - 2 - 2 Options

#### VKM-GA(M)V1

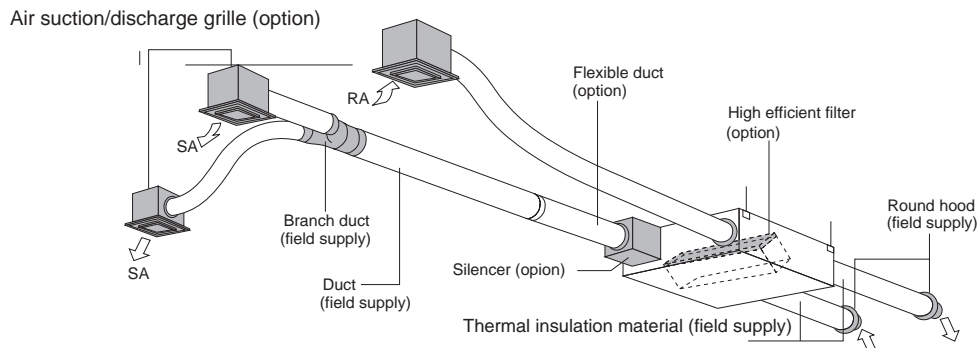

		VKM-GAV1										
Controlling device	Remote control	BRC1A62 (General market) BRC1D527 (EC market) (*#1)										
	Centralized controlling device	Central remote control	DCS302C51									
		Unified ON/OFF control	DCS301B61 (General market) DCS301B51 (EC market)									
		Schedule timer	DST301B51									
		Wiring adapter for electrical appendices	KRP2A61 (General market) KRP2A51 (EC market)									
	For ON signal output	KRP50-2										
	For heater control kit	BRP4A50										
	For wiring	Type (indoor unit of VRV)	FXCQ-M	FXFQ-P	FXKQ-M	FXSQ-M	FXMQ-M	FXHQ-M	FXAQ-M	FXDQ-N	FXKQ-M FXNQ-M	FXZQ-M
			KRP1B61★	-		KRP1B61		KRPB3	-	KRP1B56	KRP1B61	KRP1B57
			Installation box for adapter PCB ☆	KRP1B96 Notes 2, 3	KRP1D98 Notes 2, 3	-	KRP4A91 Notes 5	-	KRP1C93 Notes 3	KRP4A93 Notes 2, 3	KRP1B101 Notes 4, 6	-

#### NOTES

- 1 Installation box ☆ is necessary for each adapter marked★.
- 2 Up to 2 adapters can be fixed for each installation box.
- 3 Only one installation box can be installed for each indoor unit.
- 4 Up to 2 installation boxes can be installed for each indoor unit.
- 5 Installation box ☆ is necessary for second adapter.
- 6 Installation box ☆ is necessary for each adapter.
- 7 \*#1 Necessary when operating HRV (VKM) independently. When operating interlocked with other air conditioners, use the remote control of the air conditioners.

		VKM-GA(M)V1			
		50	80	100	
Additional function	Silencer				
		Nominal pipe diameter (mm)		ø250	
	Air suction/Discharge grill	White	K-DGL200B		K-DGL250B
		Nominal pipe diameter (mm)	ø200		ø250
	High efficiency filter	KAF241G80M		KAF241G100M	
Air filter for replacement	KAF242G80M		KAF242G100M		
Flexible duct (1m)		K-FDS201C		K-FDS251C	
Flexible duct (2m)		K-FDS202C		K-FDS252C	



Remote Control



Centralised remote control



Unified ON/OFF controller



Schedule timer



Silencer



Air suction/discharge grille  
(Noise suppression type)



Flexible duct  
(Noise suppression type)

# 7 Product Specification

## 7 - 2 VKM-GAV1

### 7 - 2 - 3 Capacity tables

#### 7 - 2 - 3 - 1 Cooling capacity tables

##### VKM-GA(M)

TC: Total capacity : kW; SHC : Sensible heat capacity : kW

Class	Capacity DX-Coil Only	Outdoor °CDB	Coil Inlet air temp. °CDB													
			14.0WB		16.0WB		18.0WB		19.0WB		20.0WB		22.0WB		24.0WB	
			20.0DB		23.0DB		26.0DB		27.0DB		28.0DB		30.0DB		32.0DB	
			TC	SHC	TC	SHC	TC	SHC	TC	SHC	TC	SHC	TC	SHC	TC	SHC
50	2.8kW index 25	10.0	1.9	1.5	2.3	1.8	2.6	2.0	2.8	2.0	—	—	—	—	—	—
		12.0	1.9	1.5	2.3	1.8	2.6	2.0	2.8	2.0	—	—	—	—	—	—
		14.0	1.9	1.5	2.3	1.8	2.6	2.0	2.8	2.0	3.0	2.0	—	—	—	—
		16.0	1.9	1.5	2.3	1.8	2.6	2.0	2.8	2.0	3.0	2.0	—	—	—	—
		18.0	1.9	1.5	2.3	1.8	2.6	2.0	2.8	2.0	3.0	2.0	—	—	—	—
		20.0	1.9	1.5	2.3	1.8	2.6	2.0	2.8	2.0	3.0	2.0	—	—	—	—
		21.0	—	—	2.3	1.8	2.6	2.0	2.8	2.0	3.0	2.0	—	—	—	—
		23.0	—	—	2.3	1.8	2.6	2.0	2.8	2.0	3.0	2.0	3.3	2.1	—	—
		25.0	—	—	2.3	1.8	2.6	2.0	2.8	2.0	3.0	2.0	3.3	2.0	—	—
		27.0	—	—	2.3	1.8	2.6	2.0	2.8	2.0	3.0	2.0	3.2	2.0	—	—
		29.0	—	—	2.3	1.8	2.6	2.0	2.8	2.0	3.0	2.0	3.2	2.0	—	—
		31.0	—	—	2.3	1.8	2.6	2.0	2.8	2.0	3.0	2.0	3.1	2.0	—	—
		33.0	—	—	2.3	1.8	2.6	2.0	2.8	2.0	3.0	2.0	3.1	2.0	3.1	1.8
		35.0	—	—	—	—	2.6	2.0	2.8	2.0	3.0	2.0	3.0	1.9	3.1	1.8
37.0	—	—	—	—	2.6	2.0	2.8	2.0	2.9	2.0	3.0	1.9	3.0	1.8		
39.0	—	—	—	—	2.6	2.0	2.8	2.0	2.9	2.0	2.9	1.9	3.0	1.8		
80	4.5kW index 40	10.0	3.0	2.1	3.6	2.4	4.2	2.7	4.5	2.7	—	—	—	—	—	—
		12.0	3.0	2.1	3.6	2.4	4.2	2.7	4.5	2.7	—	—	—	—	—	—
		14.0	3.0	2.1	3.6	2.4	4.2	2.7	4.5	2.7	4.8	3.3	—	—	—	—
		16.0	3.0	2.1	3.6	2.4	4.2	2.7	4.5	2.7	4.8	2.8	—	—	—	—
		18.0	3.0	2.1	3.6	2.4	4.2	2.7	4.5	2.7	4.8	2.8	—	—	—	—
		20.0	3.0	2.1	3.6	2.4	4.2	2.7	4.5	2.7	4.8	2.8	—	—	—	—
		21.0	—	—	3.6	2.4	4.2	2.7	4.5	2.7	4.8	2.8	—	—	—	—
		23.0	—	—	3.6	2.4	4.2	2.7	4.5	2.7	4.8	2.8	5.3	2.9	—	—
		25.0	—	—	3.6	2.4	4.2	2.7	4.5	2.7	4.8	2.8	5.2	2.9	—	—
		27.0	—	—	3.6	2.4	4.2	2.7	4.5	2.7	4.8	2.8	5.1	2.8	—	—
		29.0	—	—	3.6	2.4	4.2	2.7	4.5	2.7	4.8	2.8	5.1	2.8	—	—
		31.0	—	—	3.6	2.4	4.2	2.7	4.5	2.7	4.8	2.8	5.0	2.8	—	—
		33.0	—	—	3.6	2.4	4.2	2.7	4.5	2.7	4.8	2.8	4.9	2.7	5.0	2.6
		35.0	—	—	—	—	4.2	2.7	4.5	2.7	4.7	2.8	4.8	2.7	4.9	2.6
37.0	—	—	—	—	4.2	2.7	4.5	2.7	4.6	2.8	4.8	2.7	4.9	2.6		
39.0	—	—	—	—	4.2	2.7	4.5	2.7	4.6	2.7	4.7	2.6	4.8	2.5		
100	5.6kW index 50	10.0	3.8	2.5	4.5	2.9	5.2	3.3	—	—	—	—	—	—	—	—
		12.0	3.8	2.5	4.5	2.9	5.2	3.3	5.6	3.3	—	—	—	—	—	—
		14.0	3.8	2.5	4.5	2.9	5.2	3.3	5.6	3.3	—	—	—	—	—	—
		16.0	3.8	2.5	4.5	2.9	5.2	3.3	5.6	3.3	6.0	3.4	—	—	—	—
		18.0	3.8	2.5	4.5	2.9	5.2	3.3	5.6	3.3	6.0	3.4	—	—	—	—
		20.0	3.8	2.5	4.5	2.9	5.2	3.3	5.6	3.3	6.0	3.4	—	—	—	—
		21.0	—	—	4.5	2.9	5.2	3.3	5.6	3.3	6.0	3.4	—	—	—	—
		23.0	—	—	4.5	2.9	5.2	3.3	5.6	3.3	6.0	3.4	—	—	—	—
		25.0	—	—	4.5	2.9	5.2	3.3	5.6	3.3	6.0	3.4	6.5	3.5	—	—
		27.0	—	—	4.5	2.9	5.2	3.3	5.6	3.3	6.0	3.4	6.4	3.5	—	—
		29.0	—	—	4.5	2.9	5.2	3.3	5.6	3.3	6.0	3.4	6.3	3.4	—	—
		31.0	—	—	4.5	2.9	5.2	3.3	5.6	3.3	6.0	3.4	6.2	3.4	—	—
		33.0	—	—	—	—	5.2	3.3	5.6	3.3	6.0	3.4	6.1	3.3	6.3	3.2
		35.0	—	—	—	—	5.2	3.3	5.6	3.3	5.9	3.3	6.0	3.3	6.2	3.2
37.0	—	—	—	—	5.2	3.3	5.6	3.3	5.8	3.3	5.9	3.2	6.1	3.1		
39.0	—	—	—	—	5.2	3.3	5.6	3.3	5.7	3.3	5.8	3.2	6.0	3.1		

NOTES

1 Cooling and heating capacities are based on the following conditons. Fan is based on High and Ultra-high? The figures in the parenthesis indicate the heat reclaimed from the heat recovery ventilator. When calculating the capacity as indoor units, use the following figures:

- VKM50GAV1 : 3.5kW
- VKM80GAV1: 5,6kW
- VKM100GAV1 : 7.0kW

# 7 Product Specification

## 7 - 2 VKM-GAV1

### 7 - 2 - 3 Capacity tables

#### 7 - 2 - 3 - 2 Heating capacity tables

##### VKM-GA(M)

Class	Capacity DX-Coil Only	Outdoor		Coil Inlet air temp. °CDB					
		°CDB	°CWB	16.0kW	18.0kW	20.0kW	21.0kW	22.0kW	24.0kW
50	2.8kW index 25	-14.7	-15.0	2.2	2.2	—	—	—	—
		-12.6	-13.0	2.3	2.3	—	—	—	—
		-10.5	-11.0	2.4	2.4	—	—	—	—
		-9.5	-10.0	2.5	2.4	—	—	—	—
		-8.5	-9.1	2.5	2.5	—	—	—	—
		-7.0	-7.6	2.6	2.6	2.7	—	—	—
		-5.0	-5.6	2.7	2.7	2.7	—	—	—
		-3.0	-3.7	2.8	2.8	3.0	3.0	—	—
		0.0	-0.7	3.0	3.0	3.1	3.1	—	—
		3.0	2.2	3.1	3.1	3.2	3.1	3.0	—
		5.0	4.1	3.3	3.2	3.2	3.1	3.0	—
		7.0	6.0	3.4	3.4	3.2	3.1	3.0	—
		9.0	7.9	3.5	3.4	3.2	3.1	3.0	—
		11.0	9.8	3.6	3.4	3.2	3.1	3.0	2.8
13.0	11.8	3.6	3.4	3.2	3.1	3.0	2.8		
15.0	13.7	3.6	3.4	3.2	3.1	3.0	2.8		
80	4.5kW index 40	-14.7	-15.0	3.4	3.4	—	—	—	—
		-12.6	-13.0	3.6	3.6	—	—	—	—
		-10.5	-11.0	3.7	3.7	—	—	—	—
		-9.5	-10.0	3.9	3.7	—	—	—	—
		-8.5	-9.1	3.9	3.9	—	—	—	—
		-7.0	-7.6	4.1	4.1	4.2	—	—	—
		-5.0	-5.6	4.2	4.2	4.2	—	—	—
		-3.0	-3.7	4.4	4.4	4.7	4.6	—	—
		0.0	-0.7	4.7	4.7	4.9	4.9	—	—
		3.0	2.2	4.9	4.9	5.0	4.9	4.7	—
		5.0	4.1	5.2	5.0	5.0	4.9	4.7	—
		7.0	6.0	5.3	5.3	5.0	4.9	4.7	—
		9.0	7.9	5.5	5.3	5.0	4.9	4.7	—
		11.0	9.8	5.7	5.3	5.0	4.9	4.7	4.4
13.0	11.8	5.7	5.3	5.0	4.9	4.7	4.4		
15.0	13.7	5.7	5.3	5.0	4.9	4.7	4.4		
100	5.6kW index 50	-14.7	-15.0	4.4	4.4	—	—	—	—
		-12.6	-13.0	4.6	4.6	—	—	—	—
		-10.5	-11.0	4.8	4.8	—	—	—	—
		-9.5	-10.0	5.0	4.8	—	—	—	—
		-8.5	-9.1	5.0	5.0	—	—	—	—
		-7.0	-7.6	5.2	5.3	—	—	—	—
		-5.0	-5.6	5.4	5.4	5.4	—	—	—
		-3.0	-3.7	5.6	5.6	6.0	—	—	—
		0.0	-0.7	6.0	6.0	6.2	6.2	—	—
		3.0	2.2	6.2	6.2	6.4	6.2	6.0	—
		5.0	4.1	6.6	6.4	6.4	6.2	6.0	—
		7.0	6.0	6.8	6.8	6.4	6.2	6.0	—
		9.0	7.9	7.0	6.8	6.4	6.2	6.0	—
		11.0	9.8	7.2	6.8	6.4	6.2	6.0	5.6
13.0	11.8	7.2	6.8	6.4	6.2	6.0	5.6		
15.0	13.7	7.2	6.8	6.4	6.2	6.0	5.6		

#### NOTES

Cooling and heating capacities are based on the following conditions. Fan is based on High and Ultra-high. The figures in the parenthesis indicate the heat reclaimed from the heat recovery ventilator. When calculating the capacity as indoor units, use the following figures :

- VKM50GAV1 : 3.5kW
- VKM80GAV1 : 5.6kW
- VKM100GAV1 : 7.0kW

## 7 Product Specification

### 7 - 2 VKM-GAV1

#### 7 - 2 - 3 Capacity tables

##### 7 - 2 - 3 - 3 Capacity correction factor

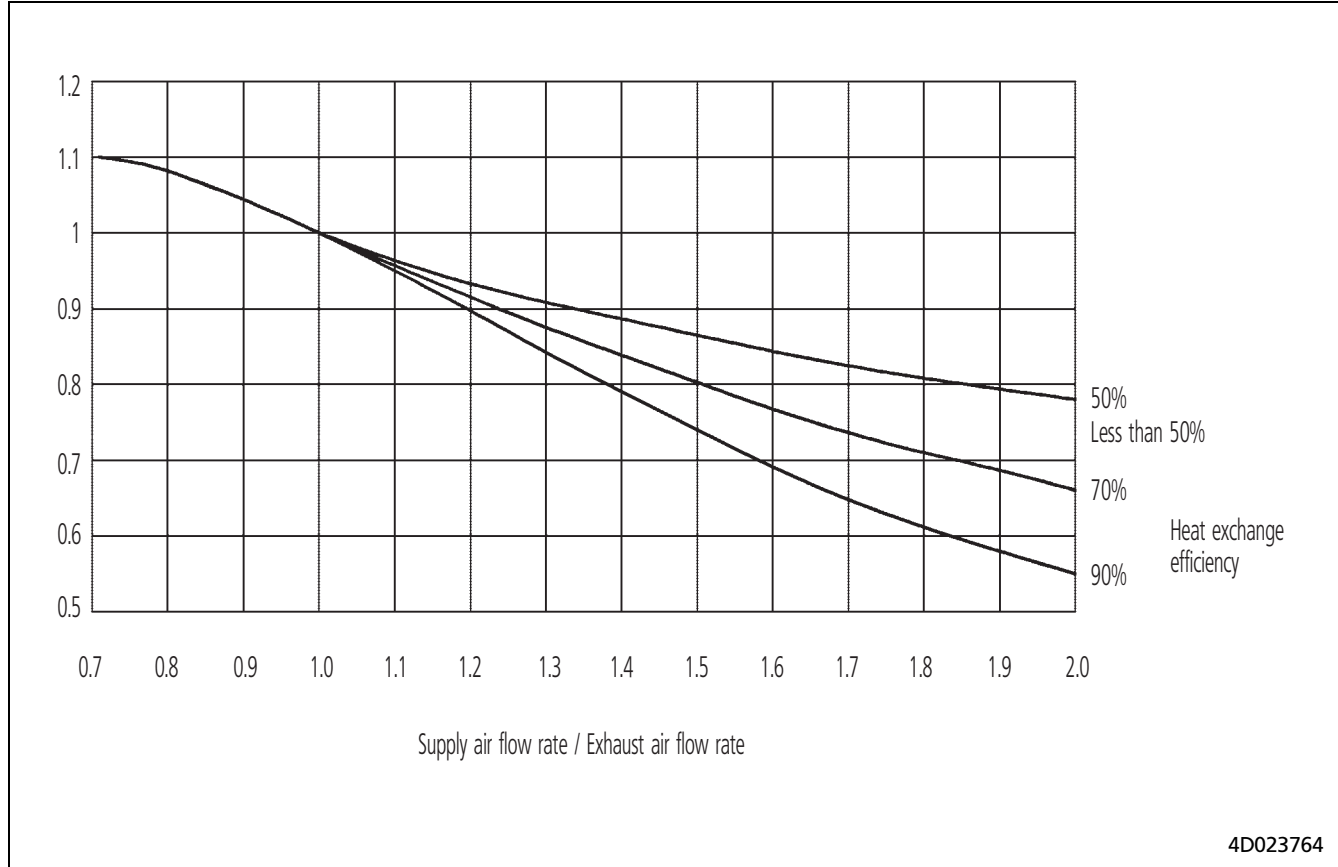

# 7 Product Specification

## 7 - 2 VKM-GAV1

### 7 - 2 - 4 Dimensional drawing & centre of gravity

#### 7 - 2 - 4 - 1 Dimensional drawing

VKM50GAV1

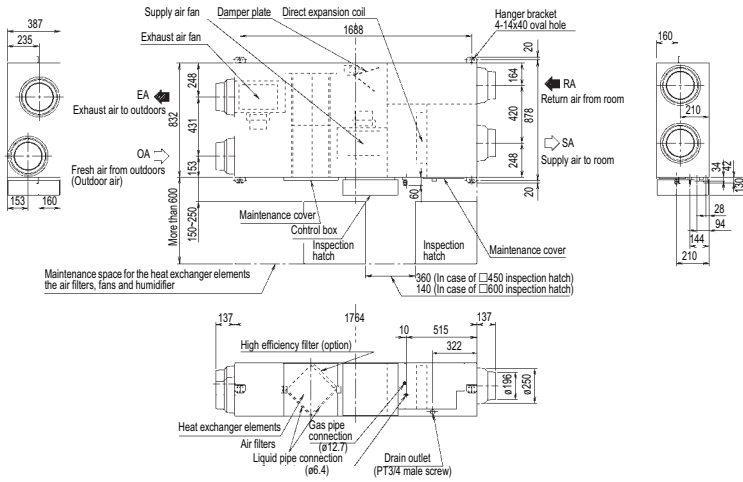

**NOTES**

- 1 Specifications are subject to change without notice.
- 2 Be sure to provide two inspection hatches (□450 or □600) at the service side of filters and elements.
- 3 The high efficiency filter (option) can be attached to the SA surface of the heat exchanger elements.

3D051288

VKM80GAV1

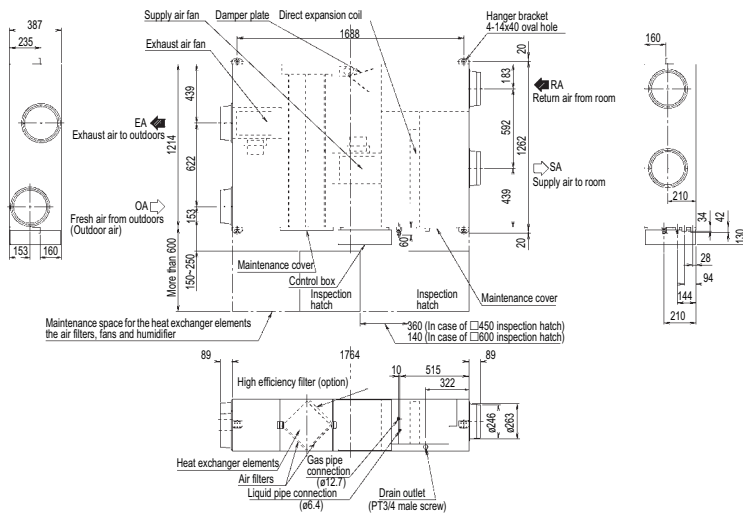

**NOTES**

- 1 Specifications are subject to change without notice.
- 2 Be sure to provide two inspection hatches (□450 or □600) at the service side of filters and elements.
- 3 The high efficiency filter (option) can be attached to the SA surface of the heat exchanger elements.

3D051289

# 7 Product Specification

## 7 - 2 VKM-GAV1

### 7 - 2 - 4 Dimensional drawing & centre of gravity

#### 7 - 2 - 4 - 1 Dimensional drawing

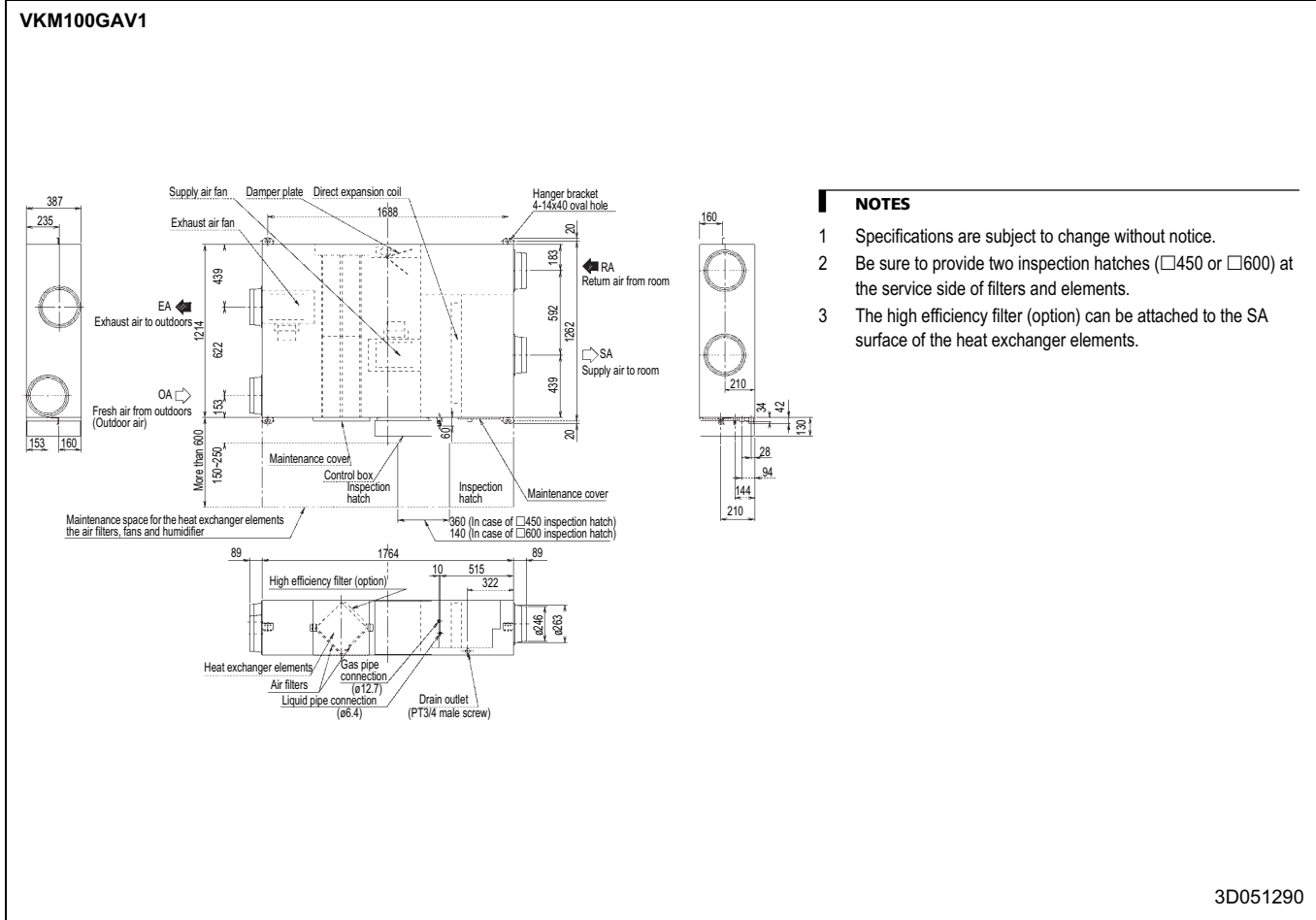

# 7 Product Specification

## 7 - 2 VKM-GAV1

### 7 - 2 - 5 Wiring diagram

VKM50,80,100GAV1

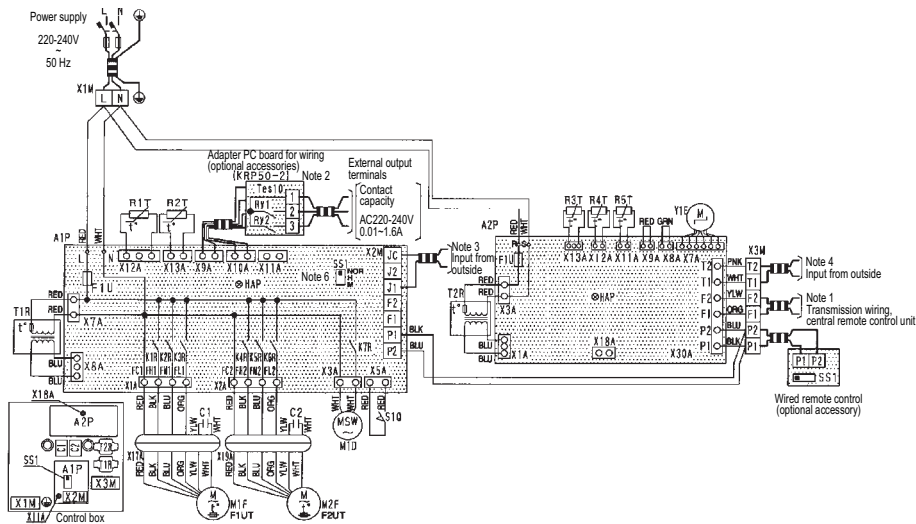

Indoor unit		M1F	Motor (supply air fan)	Optional accessories	
A1P	Printed circuit board	M2F	Motor (exhaust air fan)	Wired remote control	
A2P	Printed circuit board	R1T	Thermistor (indoor air)	SS1	Select switch (main/sub)
C1-C2	Capacitor (M1F)	R2T	Thermistor (outdoor air)		
F1U	Fuse (⊙, 10A, 250V) (A1P)	R3T	Thermistor (inlet air into coil)		
F1U	Fuse (⊙, 5A, 250V) (A2P)	R4T, R5T	Thermistor (liquid/gas pipe of coil)	Adaptor PC board for wiring (KRP50-2)	
F1UT-F2UT	Thermo switch (152°C) (M1F, M2F built-in)	S1Q	Limit switch (damper motor)	Ry1	Magnetic relay (operation/stop)
HAP	Light emitting diode (service monitor-green) (A1P)	SS1	Select switch (for especially use) (A1P)	Ry2	Magnetic relay (for humidifier operation)
HAP	Light emitting diode (service monitor-green) (A2P)	T1R	Transformer (220-240V/22V)	Tes10	Terminal block (for external output)
K1R-K3R	Magnetic relay (M1F) (A1P)	T2R	Transformer (220-240V/22V)		
K4R-K6R	Magnetic relay (M2F) (A1P)	X1M	Terminal block (power supply)	Connector for optional parts	
K7R	Magnetic relay (M1D) (A1P)	X2M	Terminal block (control) (A1P)	X11A	Connector (adapter power supply) (A1P)
M1D	Motor (damper motor)	X3M	Terminal block (control)	X18A	Connector (wiring adapter for electrical appendices) (A2P)
		X17A, X19A	Connector (relaying wire)		
		X20A	Connector (relaying wire)		
		Y1E	Electronic expansion valve		

- : Terminal block  
 : Connector  
  : Short circuit connector  
 : Terminal  
 : Field wiring
- Colors: BLK: Black      PNK: Pink  
           BLU: Blue         RED: Red  
           GRN: Green       WHT: White  
           ORG: Orange      YLW: Yellow

3D051311

#### NOTES

- In case of using central remote control, connect it to the unit in accordance with the attached instruction manual.
- In case using wiring adapter, connect it to the unit in accordance with the attached installation manual.
- When connecting the input wires from outside, fresh up control operation can be selected by remot control, in details, refer to the installation manual attached the unit.
- When connecting the input wires from outside, forced off or on/off control operation can be selected by remot control, in details, refer to the In case of installation manual attached the unit.
- Do not remove the short circuit connectors of X8A and X9A. The unit will not run if they are removed.
- SS1 (A1P) has already been set to 'nor', at factory set. The unit will not run if the setting are changed.
- Use copper conductors only.



# 7 Product Specification

## 7 - 2 VKM-GAV1

### 7 - 2 - 6 Sound data

#### 7 - 2 - 6 - 1 Sound pressure spectrum

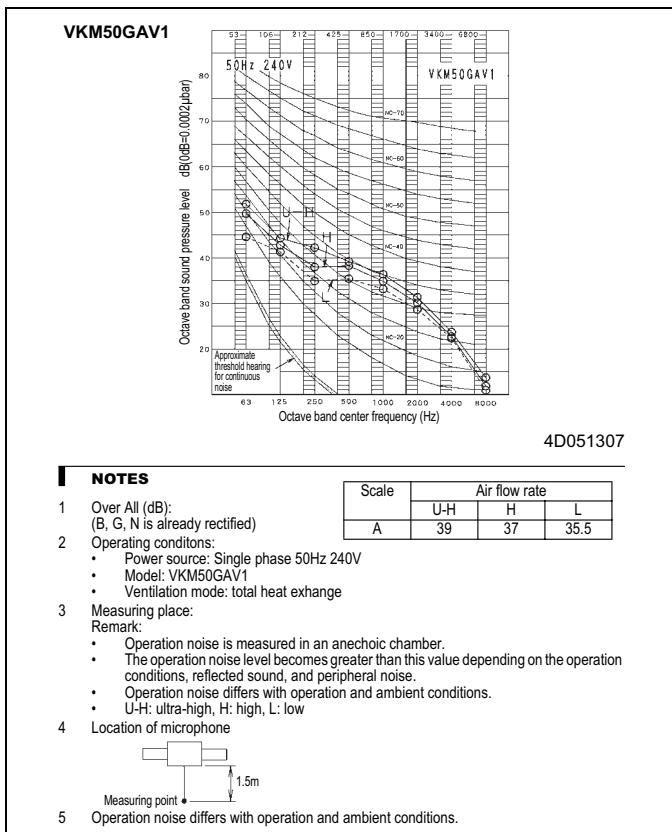
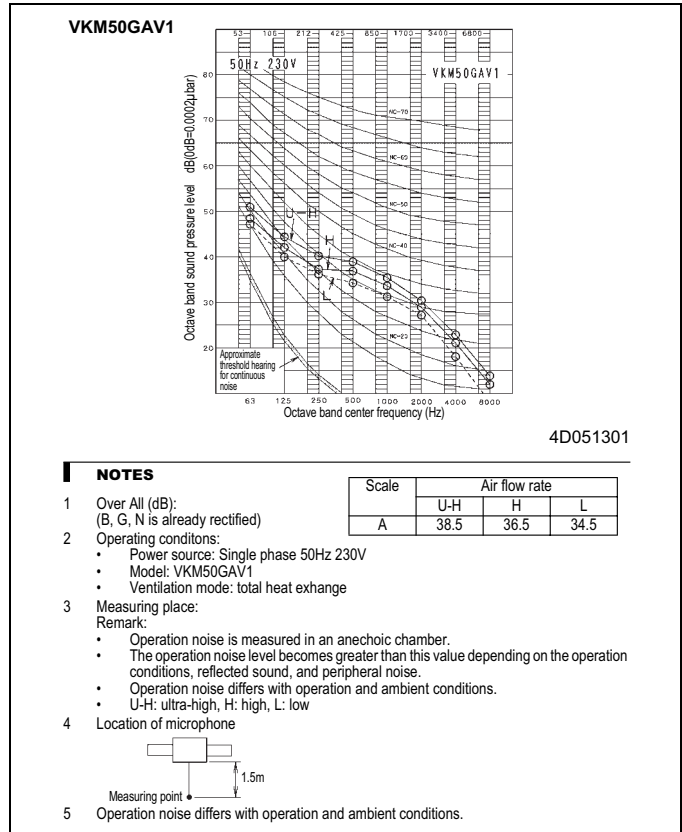
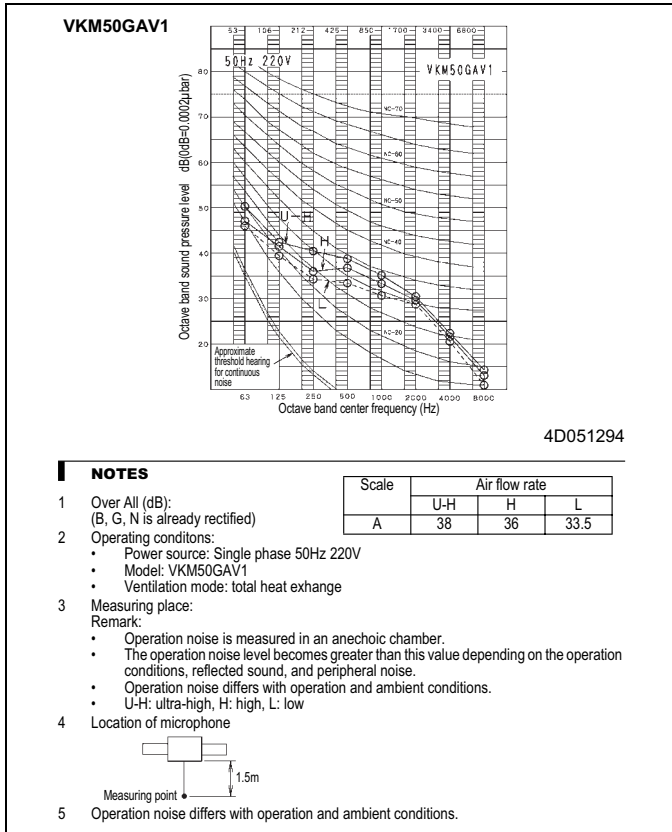

# 7 Product Specification

## 7 - 2 VKM-GAV1

### 7 - 2 - 6 Sound data

#### 7 - 2 - 6 - 1 Sound pressure spectrum

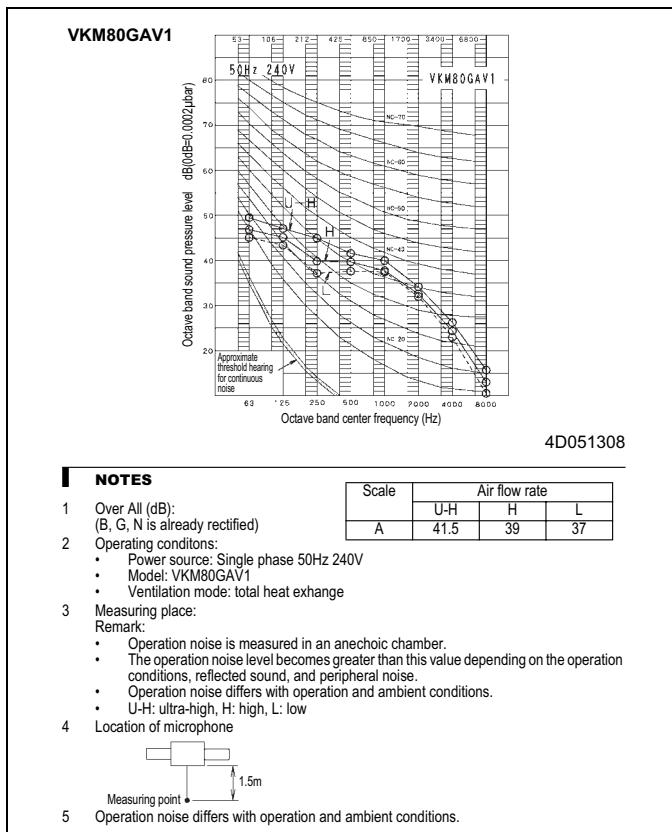
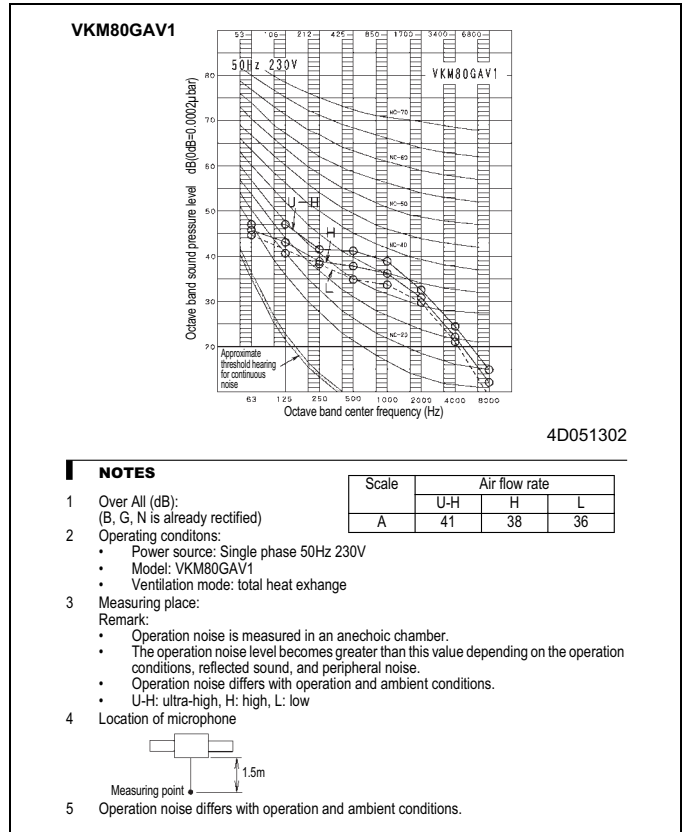
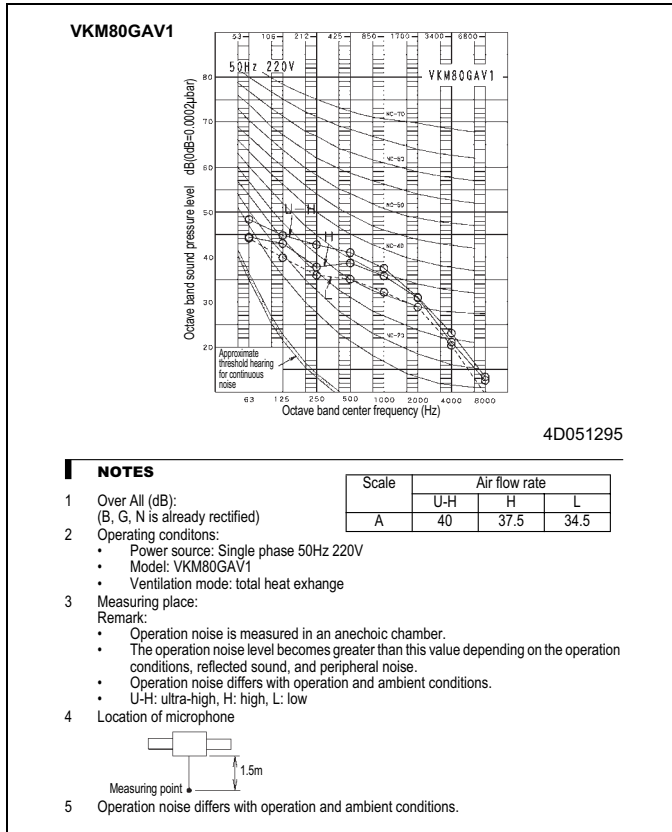

# 7 Product Specification

## 7 - 2 VKM-GAV1

### 7 - 2 - 6 Sound data

#### 7 - 2 - 6 - 1 Sound pressure spectrum

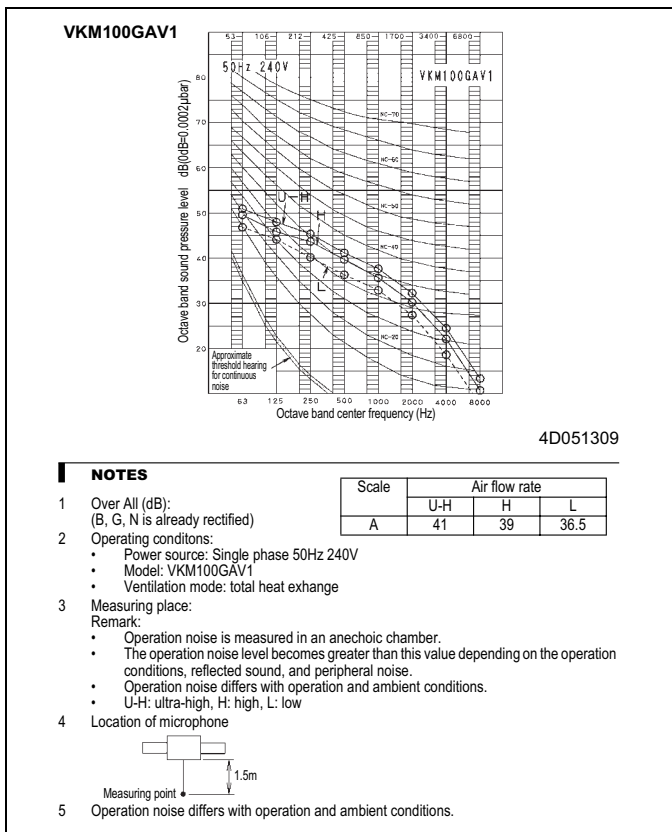
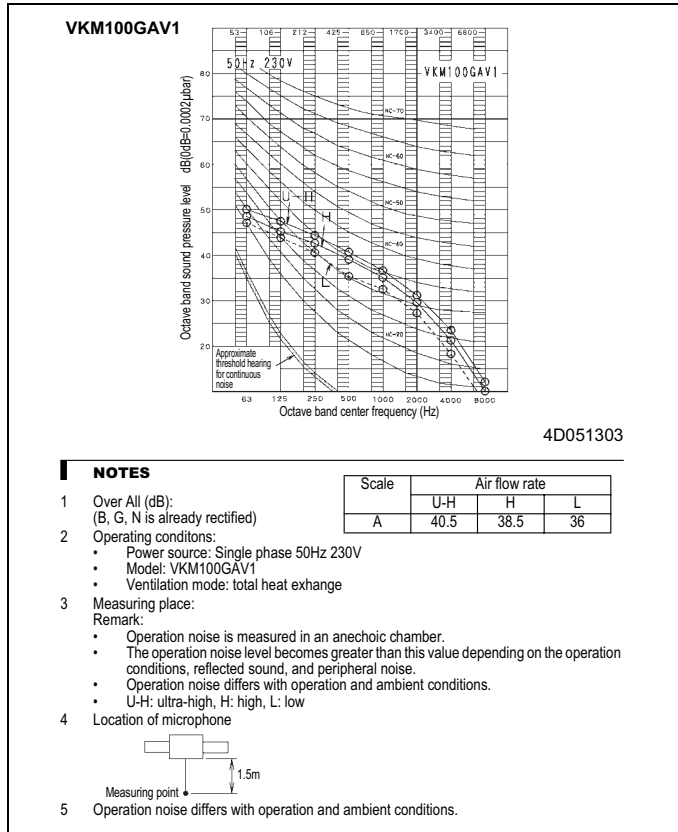
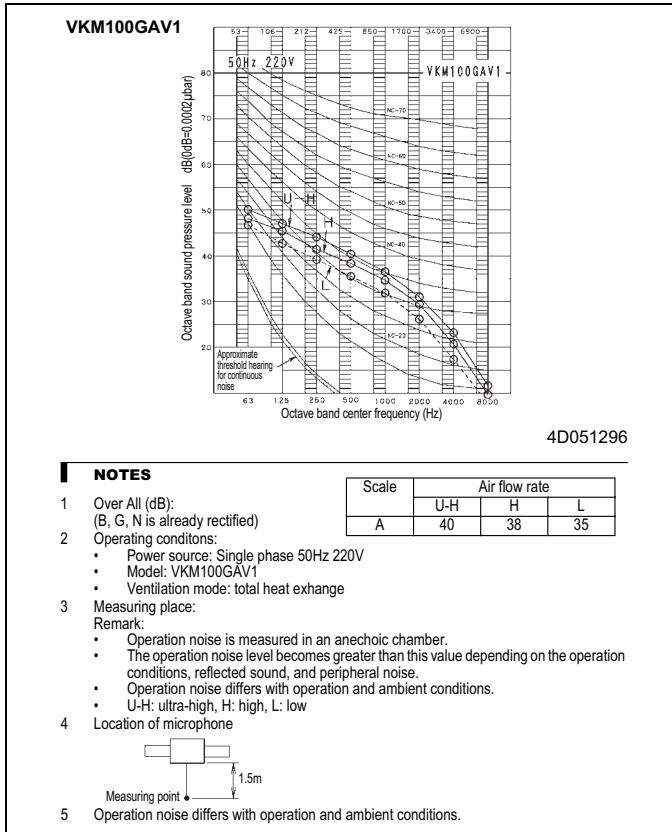

## 7 Product Specification

### 7 - 2 VKM-GAV1

#### 7 - 2 - 7 Reducing Operating Sound

The air suction and discharge grille may give out operating sound higher by 8 to 11 phons than of the HRV units body. When installing this unit in a quiet place, take measures to reduce operating sound.

1. Operating sound heard from the air discharge outlet can be reduced just by applying sound-insulating material to the SA (indoor air supply) duct.

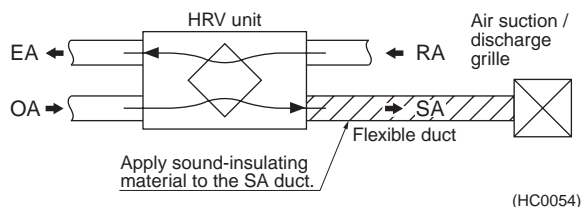

2. Operating sound can be reduced more effectively by applying sound-insulating material to a portion of the SA duct near the unit body than that near the air suction / discharge grille.

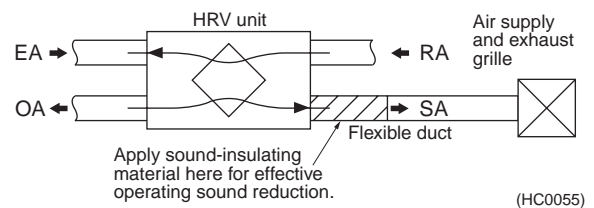

#### 7 - 2 - 7 - 1 Taking Measures to Reduce Operating Sound Heard from Attic-installed Equipment and Air Ducts.

1. When installing large air volume models (650 m<sup>3</sup> / h or more), avoid the following wherever possible if it is expected to be necessary to apply sound-insulating material to them. (Fig.1)

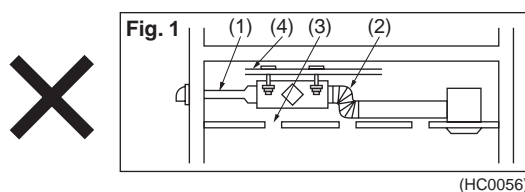

- (1) Making the duct diameter extremely small (Example:  $\phi$  250  $\rightarrow$   $\phi$  150,  $\phi$  200  $\rightarrow$   $\phi$  100)
- (2) Making the duct extremely bent using bellows (in particular, connecting bellows to the air discharge outlet of the unit body)
- (3) Making opening holes on the ceiling
- (4) Hanging the unit on a material which does not have enough hanging strength

1. When using a sound-insulating sheet, it is necessary to have the entire body of the unit covered with it. Note, however, that some models do not allow the use of a sound-insulating sheet because it may badly affect the ventilation of their radiation heat.

2. Take the following sound reduction measures. (Fig.2)

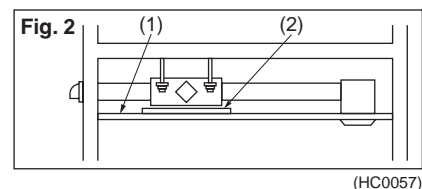

- (1) Use a sound-insulating (low-permeability-to-sound) ceiling.
- Note :**  
Some sound-insulating ceilings are not very effective in reducing low-frequency element of the operating sound.

- (2) Place a sound-reducing material under the source of the operating sound.

**Note :**

## 7 Product Specification

### 7 - 2 VKM-GAV1

#### 7 - 2 - 7 - 2 Reducing Operating Sound Heard from the Air Discharge Outlet (Suction Inlet)

1. Use the following recommended optional accessories to reduce operating sound heard from attic-installed duct type models. (Fig.3)

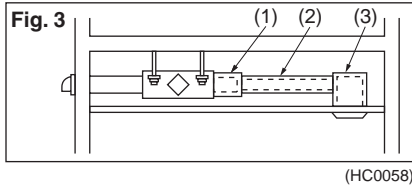

- (1) Sound-eliminating box (Silencer)
- (2) Flexible duct
- (3) Sound-eliminating air suction / discharge grille

2. If the above accessories do not give satisfactory effect or when an attic-installed cassette type model is used, take the following measure.

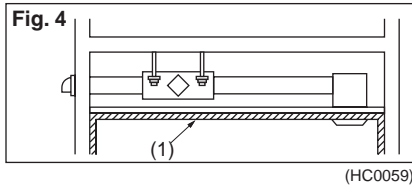

- (1) Apply a sound-absorbing material to the interior of the room.

#### 7 - 2 - 7 - 3 Effect of Remedy for Sound

##### Caution

1. Be sure to connect a flexible duct (2 m) to an outlet of the main body in the indoor air supply side.

\* A silencer is effective especially when using the flexible duct at the same time.

3. To reduce the air flow sound heard from the air discharge outlet (suction inlet) of an attic-installed duct type model, use a small diameter flexible duct, which excels in sound absorptivity, for greater sound reduction effect.

(1) Branched duct (for letting air flow through two ducts to slow down its speed before it reaches the air discharge outlets (suction inlets))

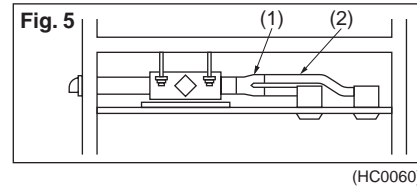

- (2) Flexible duct

4. Installation of the unit with the source of its operating sound located at a corner of a room will be a partially effective sound reduction measure; it will keep persons in the center of the room free from the annoying operating sound, with those in the corner of the room kept annoyed by the operating sound. To avoid this, try to find the best installation place from which the operating sound is least heard by everyone in the room.

## 7 Product Specification

### 7 - 2 VKM-GAV1

#### 7 - 2 - 7 Reducing Operating Sound

#### 7 - 2 - 7 - 4 General Comparison of the Effect ((1) → (6) in more Effective Order)

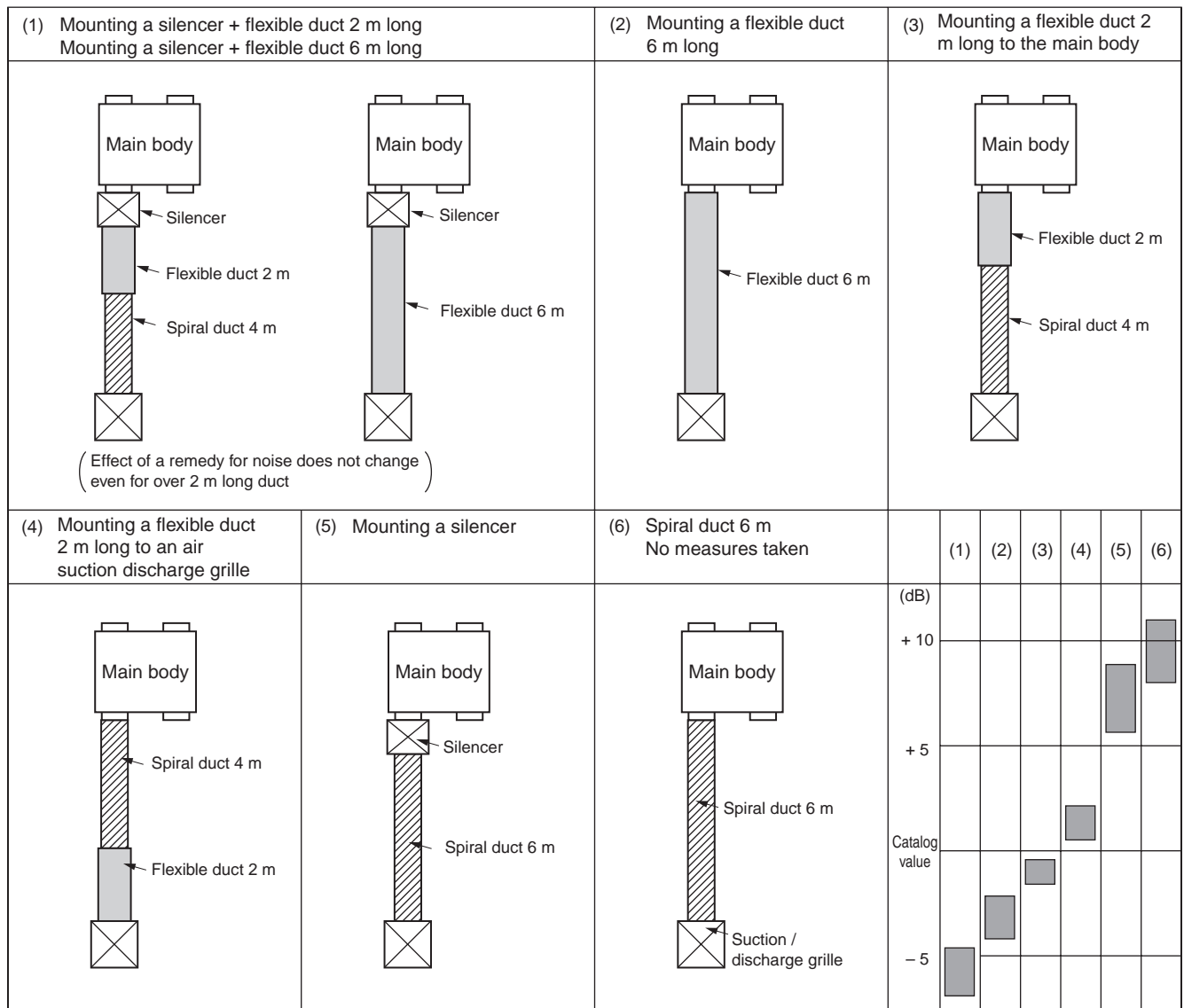

(HC0061)

**Note :**

Measure the noise at 1.5 m below the air supply grille. Operating noise conforms to JIS standard and the value is converted in terms of the anechoic chamber.

#### 7 - 2 - 7 - 5 Nameplate for Note

"Notes for duct work" is written on the HRV units as indicated below.

<sup>2</sup> When connecting a spiral duct or an aluminum bellows, sound at the air discharge outlet is higher by 8~11 phon than the main body operating sound.

- When using this unit in a quiet place, take a remedy for sound by connecting an optional flexible duct at the outlet of the indoor air suction side of the main body.

# 7 Product Specification

## 7 - 2 VKM-GAV1

### 7 - 2 - 8 Fan characteristics

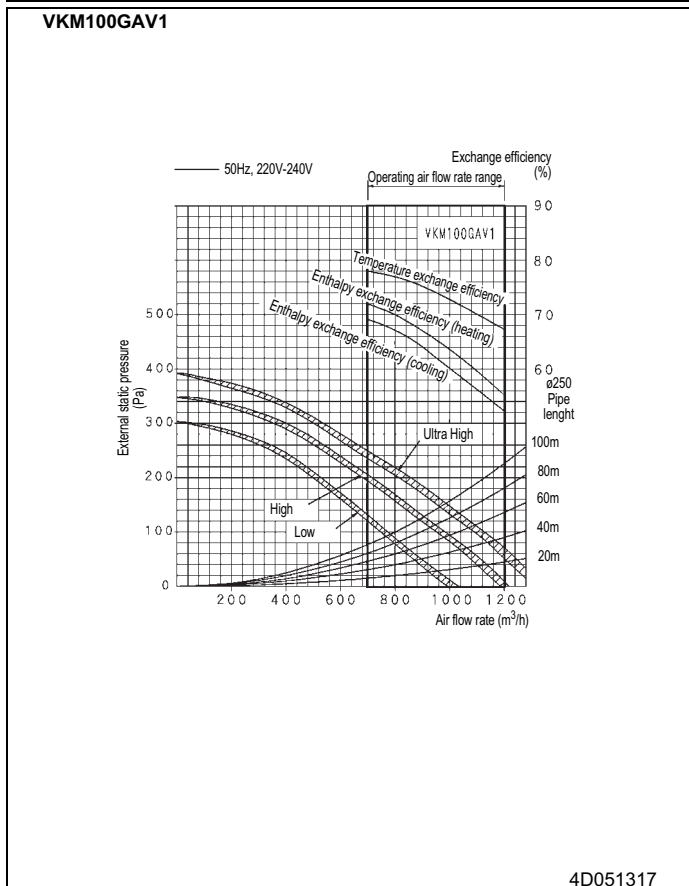
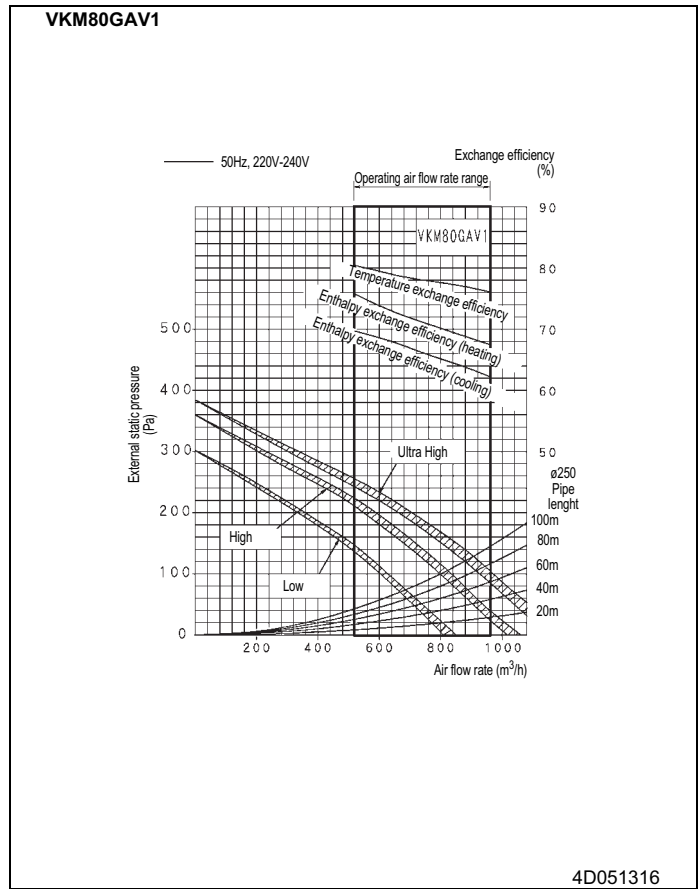
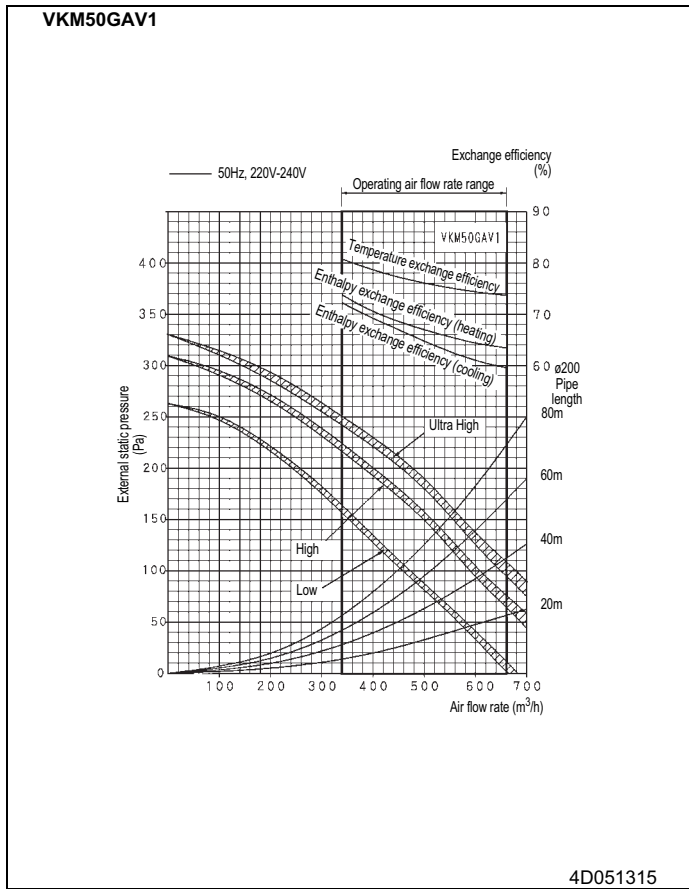

# 7 Product Specification

## 7 - 2 VKM-GAV1

### 7 - 2 - 9 Installation

#### 7 - 2 - 9 - 1 Installation method

VKM50GAV1

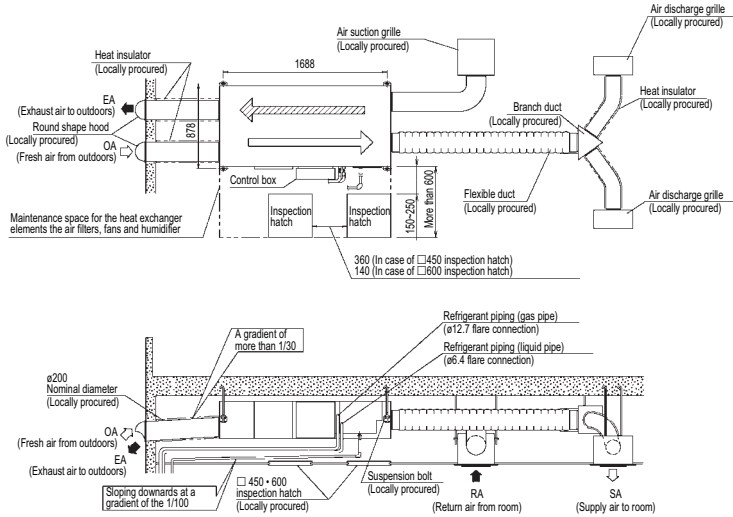

**NOTES**

- 1 Leave space for servicing the unit and include inspection hatch. (Always open a hole on the side of the control box so that the air filters, heat exchange elements, and fans can easily be inspected and serviced.)
- 2 Install the two outdoor ducts with down slope (slope of 1/30 or more) to prevent entry of rain water, also, provide insulation for three ducts (outdoor ducts and indoor supply air duct) to prevent dew condensation) (material: glass wool of 25mm thick).
- 3 Do not turn the unit upside down.
- 4 Make sure install drain piping, and insulate drain piping to prevent dew condensation.
- 5 Keep the drain pipe short and sloping downwards at a gradient of at least 1/100 to prevent air from forming.
- 6 Do not use a bent cap or a round hood as the outdoor hood if they might get rained on directly (we recommend using a deep hood) (optional accessory).
- 7 In areas where freezing may occur, always take steps to prevent the pipes from freezing.
- 8 Do not place something which shouldn't be get wet at the below of this unit. The dew would fall at following case, where humidity is 80% more, or the exit of drain socket is choked up, or the air filter is very dirty.

3D051322

VKM80GAV1

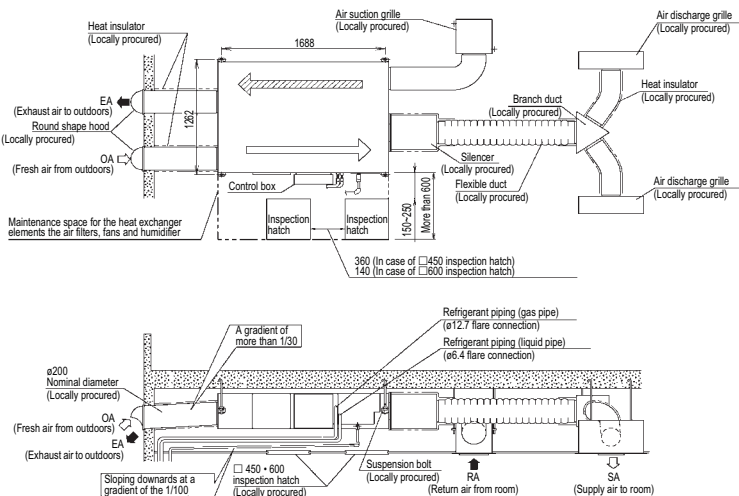

**NOTES**

- 1 Leave space for servicing the unit and include inspection hatch. (Always open a hole on the side of the control box so that the air filters, heat exchange elements, and fans can easily be inspected and serviced.)
- 2 Install the two outdoor ducts with down slope (slope of 1/30 or more) to prevent entry of rain water, also, provide insulation for three ducts (outdoor ducts and indoor supply air duct) to prevent dew condensation) (material: glass wool of 25mm thick).
- 3 Do not turn the unit upside down.
- 4 Make sure install drain piping, and insulate drain piping to prevent dew condensation.
- 5 Keep the drain pipe short and sloping downwards at a gradient of at least 1/100 to prevent air from forming.
- 6 Do not use a bent cap or a round hood as the outdoor hood if they might get rained on directly (we recommend using a deep hood) (optional accessory).
- 7 In areas where freezing may occur, always take steps to prevent the pipes from freezing.
- 8 Do not place something which shouldn't be get wet at the below of this unit. The dew would fall at following case, where humidity is 80% more, or the exit of drain socket is choked up, or the air filter is very dirty.

3D051323



# 7 Product Specification

## 7 - 2 VKM-GAV1

### 7 - 2 - 9 Installation

#### 7 - 2 - 9 - 1 Installation method

##### VKM100GAV1

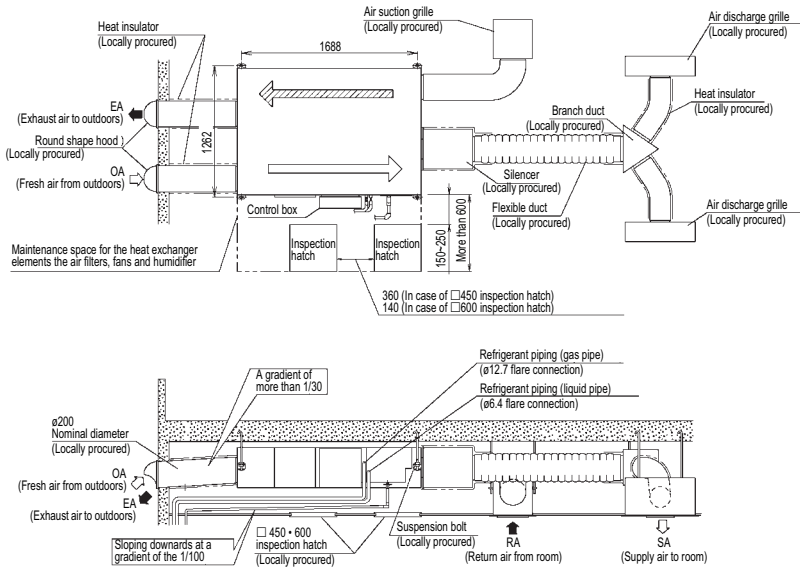

#### NOTES

- 1 Leave space for servicing the unit and include inspection hatch. (Always open a hole on the side of the control box so that the air filters, heat exchange elements, and fans can easily be inspected and serviced.)
- 2 Install the two outdoor ducts with down slope (slope of 1/30 or more) to prevent entry of rain water, also, provide insulation for three ducts (outdoor ducts and indoor supply air duct) to prevent dew condensation) (material: glass wool of 25mm thick).
- 3 Do not turn the unit upside down.
- 4 Make sure install drain piping, and insulate drain piping to prevent dew condensation.
- 5 Keep the drain pipe short and sloping downwards at a gradient of at least 1/100 to prevent air from forming.
- 6 Do not use a bent cap or a round hood as the outdoor hood if they might get rained on directly (we recommend using a deep hood) (optional accessory).
- 7 In areas where freezing may occur, always take steps to prevent the pipes from freezing.
- 8 Do not place something which shouldn't get wet at the below of this unit. The dew would fall at following case, where humidity is 80% more, or the exit of drain socket is choked up, or the air filter is very dirty.

3D051324

## 8 Operation

### HRV; Heat Reclaim Ventilation

- Carefully read this operation manual before using the total heat exchanger. It will tell you how to use the unit properly and help you if any trouble occurs. This manual explains about the indoor unit only. Use it along with the operation manual for the outdoor unit. After reading the manual, file it away for future reference.
- This unit is an option type for the VRVIII system air conditioner. It should normally be used in combination with the P-type VRVIII system indoor air conditioner. (RXYQ, REYQ, RXQ)  
It is also possible to use this unit as an independent system.
- This unit cannot control room temperature. If this is needed, do not install the HRV unit alone, but rather install another indoor unit.
- Use the remote controller of the VRVIII-system indoor air conditioner to control the unit.

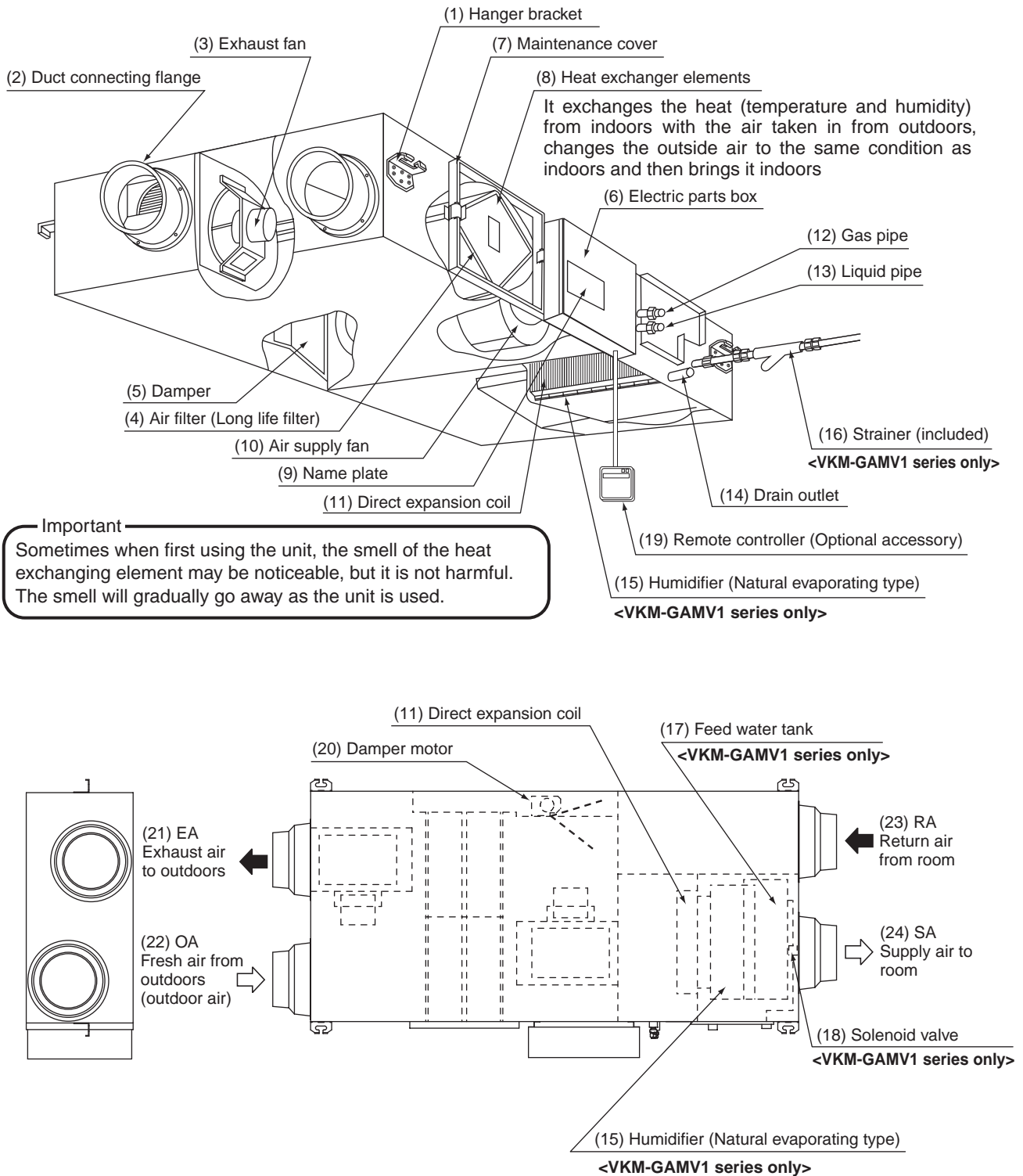
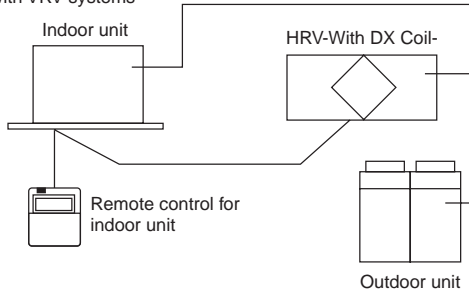

Figure 1

# 8 Operation

• Combined operation system with VRV systems



• Independent system

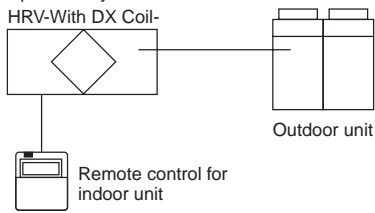
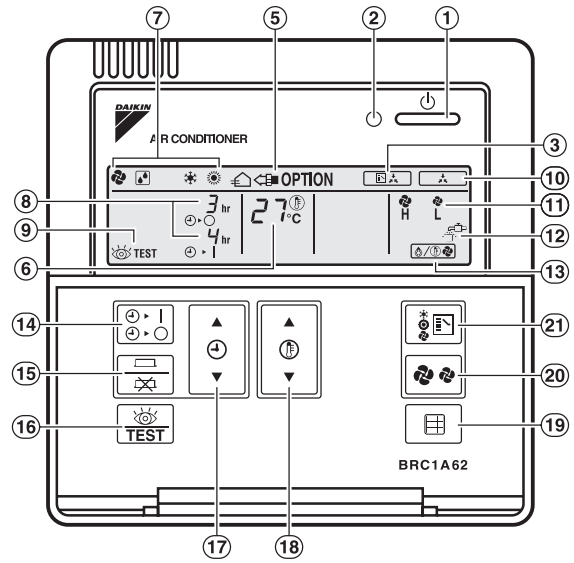

Figure 2



Remote control for VRV BRC1A62

Figure 3

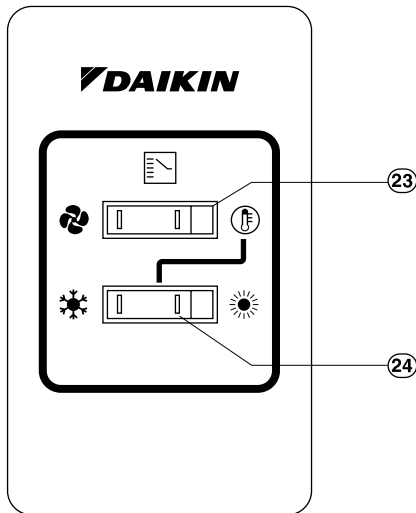
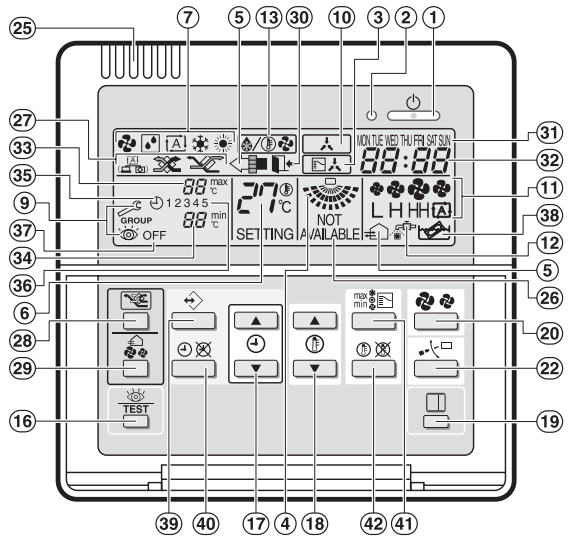
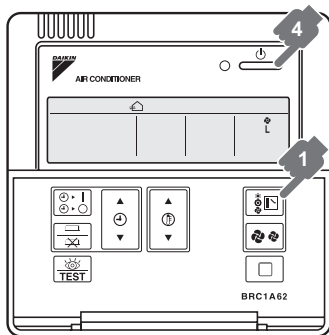

Figure 4



Remote control for VKM BRC1D527 (EU only)

Figure 3



Remote control for VRV BRC1A62

Figure 5

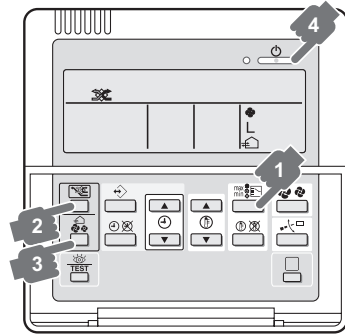

Remote control for VKM BRC1D527 (EU only)

Figure 5

# 8 Operation

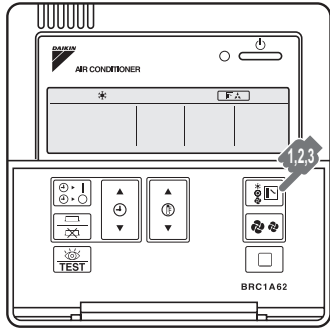

Remote control for VRV BRC1A62

Figure 6

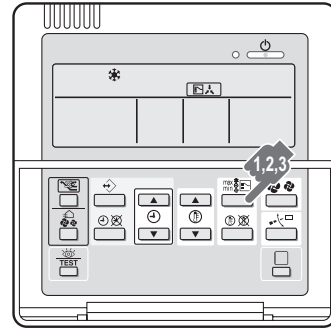

Remote control for VKM BRC1D527 (EU only)

Figure 6

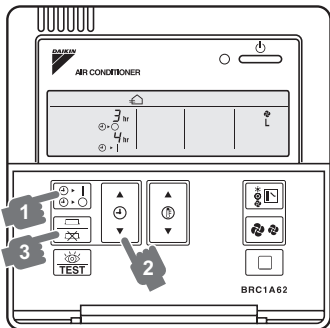

Remote control for VRV BRC1A62

Figure 7

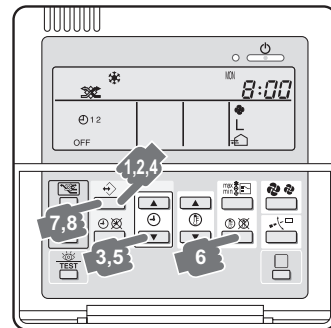

Remote control for VKM BRC1D527 (EU only)

Figure 7

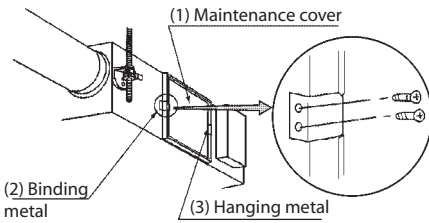

Figure 8-1

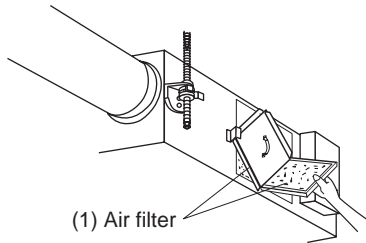

Figure 8-2

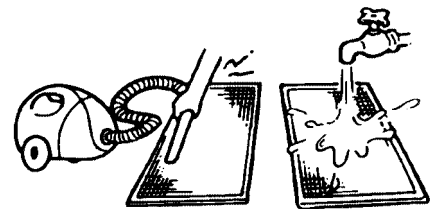

Figure 9

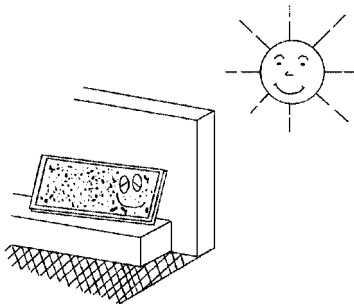

Figure 10

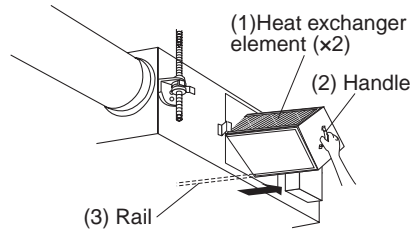

Figure 11

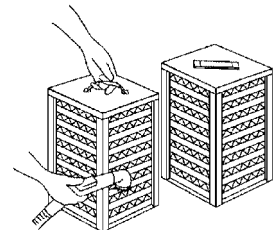



Figure 12

## 8 Operation

### 8 - 1 Safety Cautions

Read the following cautions carefully and use your equipment properly.  
This unit comes under the term “appliances not accessible to the genetic public.”  
There are two kinds of safety cautions and tips listed here as follows:

 **WARNING**..... Improper handling can lead to such serious consequences as death or severe injury.

 **CAUTION**..... Improper handling can lead to injury or damage. It could also have serious consequences under certain conditions.

#### Note

- These instructions will ensure proper use of the equipment.

Be sure to follow these important safety cautions.

**Keep these warning sheets handy so that you can refer to them if needed.**

Also, if this equipment is transferred to a new user, make sure to hand over this user's manual to the new user.

---

#### **WARNING (During Operation)**

- **When the unit is in abnormal conditions (smell of something burning, etc.), cut off the power, and contact your dealer.**

Continued operation under such circumstances may result in a failure, electric shock, and fire.

- **It is not good for your health to expose your body to the air flow for a long time.**
- **Do not operate the unit with a wet hand.**  
An electric shock may result.
- **Open the windows and ventilate the room if flammable gas is leaked.**  
Insufficient ventilation when the unit is turned on or off may cause an explosion from sparks at the electrical connection.
- **Do not wash the HRV unit with water.**  
Electric shock or fire may result. (Not including air filters, etc.)
- **Be sure to stop the unit and turn off the power when cleaning or inspecting it.**  
As the fan is rotating at high speed, it will cause injury.
- **Never inspect or service the unit by yourself.**  
Ask a qualified service person to perform this work. (The qualified service person)
- **Keep all flames away if the refrigerant leaks.**  
The refrigerant in the air conditioner is safe and normally does not leak. If the refrigerant leaks inside the room, the contact with a fire of a burner, a heater or a cooker may result in a harmful gas. Extinguish all flames from burning appliances (such as stoves, heaters, etc.) ventilate the room, and contact your dealer. Do not use the air conditioner until when a service person confirms to finish repairing the portion where the refrigerant leaks.

---

#### **CAUTION (During Operation)**

- **Do not use the HRV unit for other purposes.**  
In order to avoid any quality deterioration, do not use the unit for cooling precision instruments, food, plants, animals or works of art.
  - **Do not use burning appliances directly in the path of the air from the unit.**  
Incomplete combustion of the burning appliances may occur.
  - **Never expose little children, plants or animals directly to the air flow.**  
Adverse influence to little children, animals and plants may result.
  - **Neither place a flammable spray bottle near the HRV unit or indoor intake and outlet grills nor perform spraying.**  
Doing so may result in a fire.
  - **Turn off the power when the unit is not to be used for long periods of time.**  
Otherwise, the unit may get hot or catch on fire due to dust accumulation.
  - **Do not block the intake or outlet grills.**  
If the fan does not blow air throughout the entire room, it may cause oxygen deficiency leading to bad health condition or long-term health problems.
  - **Use gloves when cleaning.**  
Cleaning without gloves may cause injury.
  - **Do not operate the remote controller with wet hands.**  
This may cause electric shock.
  - **Never touch the internal parts of the controller.**  
An electric shock or a machine trouble may happen. For checking and adjusting the internal parts, contact your dealer.
  - **Do not place objects in direct proximity of the outdoor unit and do not let leaves and other debris accumulate around the unit.**  
Leaves are a hotbed for small animals which can enter the unit. Once in the unit, such animals can cause malfunctions, smoke or fire when making contact with electrical parts.
-

## 8 Operation

### 8 - 1 Safety Cautions

---

 **WARNING (For installation)**

- **Do not attempt to install the unit yourself.**  
Ask your dealer for installation of the unit.  
Incomplete installation performed by yourself may result in a water leakage, electric shock, and fire.
- **Installation should be done following the installation manual.**  
Incorrect installation may cause leaking, electric shock, or fire. Injuries may result if the unit falls.
- **Do not install the unit in locations where the temperature in the areas around the unit or indoor intake and outlet grills may fall below freezing. <VKM-GAMV1 series only>**  
The water of the water pipes, humidifier element, solenoid valves, and other components may freeze, causing breakage and leaks.
- **Do not allow exhaust air to enter the outside air intake vent.**  
This may cause the interior of the room to become contaminated and harming the health
- **Locate the outside air intake vent so that it does not take in exhaust air which contains combustion air, etc.**  
Incorrect installation may cause a loss of oxygen in the room, leading to serious accidents.
- **All wiring must be performed by an authorized electrician.**  
To do wiring, ask your dealer. Never do it yourself.
- **Make sure that a separate power supply circuit is provided for this unit and that all electrical work is carried out by qualified personnel according to local laws and regulations.**  
Insufficient power circuit capacity or incorrect work may cause electric shock or fires.
- **Be sure to establish an earth.**  
**Do not earth the unit to a utility pipe, arrester, or telephone earth.**  
Incomplete earth may cause electrical shock, or fire.  
A high surge current from lightning or other sources may cause damage to the air conditioner.
- **Install the unit on a foundation strong enough to withstand the weight of the unit.**  
A foundation of insufficient strength may result in the unit falling and causing injuries.
- **Connect the remote controller to the correct model.**  
This may cause electric shock or fire.
- **Do not connect additional electric wirings.**  
This may cause fire.
- **For refrigerant leakage, consult your dealer.**  
When the HRV unit is to be installed in a small room, it is necessary to take proper measures so that the amount of any leaked refrigerant does not exceed the limiting concentration even when it leaks. If the refrigerant leaks exceeding the level of limiting concentration, an oxygen deficiency accident may happen.
- **Do not install the HRV unit at any place where flammable gas may leak out.**  
If the gas leaks out and stays around the unit, a fire may break out.
- **Be sure to install an earth leakage breaker.**  
Failure to install an earth leakage breaker may result in electric shocks, or fire.

---

 **CAUTION (For installation)**

- **Do not use the HRV unit or an air suction/discharge grille in the following places.**
  - a. **Place subjected to high temperature or direct flame.**  
Avoid a place where the temperature near the HRV unit and the air suction/discharge air grille exceeds 40°C. If the unit is used at high temperature, deformed air filter and heat exchange element or burned motor result.
  - b. **Place such as kitchens or other places where oil fumes are present.**  
This may cause fire.
  - c. **Place such as machinery plant and chemical plant where gas, which contains noxious gas or corrosive components of materials such as acid, alkali, organic solvent and paint, is generated. Place where combustible gas leakage is likely.**  
This may cause gas poisoning or fires.
  - d. **Place such as bathroom subjected to moisture.**  
Electric leak or electric shock and other failure can be caused.
  - e. **Locations below freezing point. <VKM-GAMV1 series only>**  
Using the unit at temperatures below 0°C may cause the drain pan the supply and discharge piping, the humidifying element, the solenoid valves, and other parts to freeze, which can cause accidents.
  - f. **Near machinery emitting electromagnetic waves.**  
Electromagnetic waves may disturb the operation of the control system and result in a malfunction of the equipment.
  - g. **Place subjected to much carbon black.**  
Carbon black attaches to air filter and heat exchange element, marking them unable to use.
- **Is a snow protection measure taken?**  
For detail, consult your dealer.
- **Make sure the temperature and the humidity of the installation location is within the usage range, not exceed the limit.**  
Do not install in cold storage or other locations with low temperatures or near heated pools. This may cause electrical shock and fire.

## 8 Operation

### 8 - 1 Safety Cautions

- **Install the two outdoor ducts with down slope to prevent rainwater from entering the unit.**  
If this is not done completely, water may enter the building, damaging furniture, and cause electric shock and fire.
- **Insulate the two outdoor ducts to prevent dew condensation (and the indoor duct as well if needed).**  
If this is not done completely, water may enter the building, damaging furniture, etc.
- **Use electric insulation between the duct and the wall when using metal ducts to pass metal or wire laths or metal plating into wooden buildings.**  
This may cause electric shock and fire.
- **Arrange the drain hose to ensure smooth drainage.**  
Incomplete drainage may cause wetting of the building, furniture etc.
- **Avoid placing the controller in a spot splashed with water.**  
Water coming inside the controller may cause an electric leak or may damage the internal electronic parts.

---

—  **WARNING (For moving and reinstalling/repairing)** —

- **Do not modify the unit.**  
This may cause electric shock or fire.
- **Ask your dealer to move and reinstall the unit.**  
Incomplete installation may result in a water leakage, electric shock, and fire.
- **Do not disassemble or repair the unit yourself.**  
This may cause electric shock or fire.  
Contact your dealer to have such work done.
- **When removing the unit, be sure not to tip it.**  
The water inside the unit may drip or leak out, and get on furniture, etc.
- **Do not move or attempt to reinstall the remote controller yourself.**  
Incorrect installation, may cause electric shock or fire. Contact your dealer to have such work done.

---

#### CHECK LIST EXCEPT SAFETY CAUTION

The items described below should be checked and ask your dealer when you feel uncertain or you can't check by yourself.

##### ■ CHECK LIST ABOUT SELECTING INSTALLATION SITE

- **Is the outdoor unit installed in a well-ventilated location with no obstructions in its vicinity?**
- **Do not use in the locations described below.**
  - a. Locations with mineral oil such as cutting oil in the atmosphere.
  - b. Locations with salt in the air, such as coastal areas.
  - c. Locations with sulfide gas in the air, such as hot springs.
  - d. Locations where voltage fluctuates, such as factory.
  - e. In automobiles or marine vessels.
  - f. Locations containing steam in the atmosphere or splattered oil, such as kitchen.
  - g. Locations with mechanical equipment generating electromagnetic wave.
  - h. Locations enveloped in acidic or alkaline steam.
- **Has any action for snow protection been taken?**  
Contact your Daikin dealer for details.

##### ■ CHECK LIST ABOUT ELECTRIC WIRING WORK

- **All wiring must be performed by an authorized electrician.**  
Do not conduct the work yourself. Contact your dealer.
- **Electrical wiring must be done according to the local standards.**
- **Is the circuit specific to air conditioner?**

##### ■ CHECK LIST CORRESPONDING TO OPERATING NOISE

- **Is the unit installed at the following locations?**
  - a. Location strong enough to support the weight of the unit, and which will not amplify noise or vibration.
  - b. Location where the warm air and the noise from the outlet vent of the outdoor unit will not bother neighbors.
- **Are any obstructions near the outlet vent of the outdoor unit?**  
They may reduce the function and increase the operating noise.
- **If any abnormal noise is heard during the operation, contact your dealer.**

##### ■ CHECK LIST ABOUT DRAIN PIPING AND WATER SUPPLY WORK

- **Make sure the drain works properly.**  
During cooling operation, no drainage from the outdoor drain piping may clog the drain piping with dirt or dust, causing water leakage from the indoor unit.  
Stop the unit operation, and contact your dealer.

## 8 Operation

### 8 - 2 What to do before Operation

This operation manual is for the following systems with standard control. Before initiating operation, contact your Daikin dealer for the operation that corresponds to your system type and mark.

If your installation has a customized control system, ask your dealer for the operation that corresponds to your system.

#### 8 - 2 - 1 Name of Parts (Refer to Figure 1)

#### 8 - 2 - 2 Remote Controller and Changeover Switch : Name and Function of Each Switch and Display (Refer to Figure 3 and 4)

- Only the items marked with an asterisk (\* mark) are explanation relating to the functions and display of the unit. Unmarked items are functions of the combined air conditioners. When using buttons for functions which are not available (buttons which are not described in the text) will cause "NOT AVAILABLE" to be displayed.

Contact your dealer for more detailed descriptions of those functions (buttons).

##### 1. \*On/off button

Press the button and the system will start. Press the button again and the system will stop.

##### 2. \*Operation lamp (red)

The lamp lights up during operation or blinks if a malfunction occurs.

##### 3. \*Display " " (changeover under control)

May be displayed when combined with a VRV-system air conditioner.

It is impossible to changeover heat/cool with the remote controller when this icon is displayed.

##### 4. Display " " (air flow flap)

This displays the direction and mode of the air flow flap of the combined air conditioner.

##### 5. Display " OPTION " (ventilation/air cleaning)

This display shows that the total heat exchange and the air cleaning unit are in operation. (these are optional accessories)

##### 6. Display " " (set temperature)

This displays the set temperature of the combined air conditioner.

It is not displayed when the unit is used as an independent system.

##### 7. Display " " " " " " " " " " (operation mode: "FAN, DRY, AUTOMATIC, COOLING, HEATING")

This displays the operating status of the combined air conditioner.

- There is no "heating" for the VRV III system (Cooling only type).

- "  " is only available for systems operating in cooling and heating at the same time.

##### 8. \*Display " " (programmed time)

This display shows the programmed time of the system start or stop.

##### 9. Display " TEST " (inspection/test operation)

When the inspection/test operation button is pressed, the display shows the mode in which the system actually is.

- Do not use under usual use (service person/installer only).

##### 10. Display " " (under centralized control)

When this display shows, the system is under centralized control. (This is not a standard specification.)

##### 11. \*Display " " (fan speed)

This display shows the fan speed you have selected.

- \* This is only displayed when the fan speed selection button is pressed. It normally displays the set fan strength of the combined air conditioner.

##### 12. \*Display " " (time to clean air filter)

Refer to "8 - 5 - 1 How to clean the Air Filter".

##### 13. \*Display " " (defrost/hot start)

It may be displayed when freezing of outdoor unit's coil increases in heating mode.

##### 14. \*Timer mode start/stop button

Refer to the chapter "Operation procedure - Programming start and stop of the system with timer."

(Refer to 8 - 3 - 3)

##### 15. \*Timer on/off button

Refer to the chapter "Operation procedure - Programming start and stop of the system with timer."

(Refer to 8 - 3 - 3)

##### 16. \*Inspection/test operation button

Pressed during inspection or "test run."

- Do not use under usual use. (service person/installer only)

##### 17. \*Programming time button

Use this button for programming start and/or stop time.



## 8 Operation

### 8 - 2 Safety Cautions

#### 8 - 2 - 2 Remote controller and Changeover Switch: Name and Function of Each Switch and Display (Refer to figure 3 and 4)

**18. Temperature setting button**

Use this button for setting the desired temperature of air conditioner combined with this unit.  
This button can't use for this unit.  
This unit can't change temperature setting.

**19. \*Filter sign reset button**

Refer to "8 - 5 - 1 How to clean the Air Filter".

**20. Fan speed control button**

Press this button to select the fan speed of air conditioner combined with this unit.



**21. \*Operation mode selector button**

Press this button to select the operation mode of air conditioner combined with this unit.



**22. Air flow direction adjust button**

Press this button to select the air flow direction of air conditioner combined with this unit.

**23. Fan only/air conditioning selector switch**

Set the switch to "  " for fan only operation or to "  " for heating or cooling operation.

**24. Cool/heat changeover switch**

Set the switch to "  " for cooling or to "  " for heating operation.

**25. Remote controller thermo**

This detects the temperature around the remote controller. This is not the same as the temperature of return air from room (RA) by heat exchanger unit.

**26. \*Display "NOT AVAILABLE"**

- "NOT AVAILABLE" may be displayed for a few seconds if the function for the button pressed is not available for the unit or the air conditioner.
- "NOT AVAILABLE" is only displayed when none of the indoor units is equipped with the function in question when running several units simultaneously. It is not displayed if the function is available on even one of the units.

**27. \*Display "  " "  " "  "**

This displays the ventilation mode. (BRC1D527 and so on.) (This is not displayed on the controller BRC1A62)

**28. \*Ventilation mode selector button (available only connecting the HRV unit)**

This is pressed to switch the ventilation mode of the HRV unit.

**29. \*Ventilation fan speed control button (available only connecting the HRV unit)**

This is pressed to control the fan speed of the HRV unit.

(Refer to item 11)

**30. LEAVE HOME ICON "  "**

The leave home icon shows the status of the leave home function.

ON	Leave home is enabled
FLASHING	Leave home is active
OFF	Leave home is disabled

**31. \*DAY OF THE WEEK INDICATOR "MON TUE WED THU FRI SAT SUN"**

The day of the week indicator shows the current week day (or the set day when reading or programming the schedule timer).

**32. \*CLOCK DISPLAY "  "**

The clock display indicates the current time (or the action time when reading or programming the schedule timer).

**33. MAXIMUM SET TEMPERATURE "  max "**

The maximum set temperature indicates the maximum set temperature when in limit operation.

**34. MINIMUM SET TEMPERATURE "  min "**

The minimum set temperature indicates the minimum set temperature when in limit operation.

**35. \*SCHEDULE TIMER ICON "  "**

This icon indicates that the schedule timer is enabled.

**36. \*ACTION ICONS " 1 2 3 4 5 "**

These icons indicate the actions for each day of the schedule timer.

**37. \*OFF ICON " OFF "**

This icon indicates that the OFF action is selected when programming the schedule timer.

**38. \*ELEMENT CLEANING TIME ICON "  "**

This icon indicates the element must be cleaned ( "HRV" only).

**39. \*PROGRAMMING BUTTON "  "**

This button is a multi-purpose button.

Depending on the previous manipulations of the user, the programming button can have various functions.

**40. \*SCHEDULE TIMER BUTTON "  "**

This button enables or disables the schedule timer.

## 8 Operation

### 8 - 2 Safety Cautions

#### 8 - 2 - 2 Remote controller and Changeover Switch: Name and Function of Each Switch and Display (Refer to figure 3 and 4)

##### 41. OPERATION CHANGE/MIN-MAX BUTTON “”

This button is a multi-purpose button. Depending on the previous manipulations of the user, it can have following functions:

1. select the operation mode of the installation (FAN, DRY, AUTOMATIC, COOLING, HEATING)
2. toggle between minimum temperature and maximum temperature when in limit operation

##### 42. SETPOINT/LIMIT BUTTON “”

This button toggles between setpoint, limit operation or OFF (programming mode only).

##### Note

- In contradistinction to actual operating situations, the display on figure 3 shows all possible indications.
- If the filter sign lamp lights up, clean the air filter as explained in the chapter “MAINTENANCE”. After cleaning and reinstalling the air filter: press the filter sign reset button on the remote controller. The filter sign lamp on the display will go out.
- Item 27~ Item 42 can be used with BRC1D527.  
In detail, refer to operation manual of the remote controller.
- Only the items marked with an asterisk (\* mark) are explanation relating to the functions and display of the unit.  
Unmarked items are functions of the combined air conditioners.

#### 8 - 2 - 3 Explanation for Systems

**This unit can be made a part of two different systems: as part of the combined operation system used together with VRVIII SYSTEM Air Conditioners and as the independent system using only the HRV. An operating remote controller is required when using the unit as an independent system. Ask your dealer what kind of system your system is set up for before operation.**

**For the operation of the remote controller for indoor unit and centralized controller, refer to the instruction manual provided with each unit.**

**See the included operating manuals for details on how to operate each remote control.**

##### ■ OPERATION for EACH SYSTEM

##### Sample system (Refer to figure 2)

##### Combined operation system with VRVIII systems

[Operation]

The air conditioner remote controller starts and stops the air conditioner and the HRV unit.

You can also select the ventilation amount and the ventilation mode (**Refer to “8 - 3 Operation Procedure”**)

During intermediate periods when only the HRV unit is used without the air conditioner, select “ventilation” with the operation selection button. (**Refer to 8 - 2 - 4**)

##### Sample system (Refer to Figure 2)

##### Independent system

[Operation]

The HRV unit can be started and stopped using the remote controller.

You can also select the ventilation amount and the ventilation mode.

**(Refer to “8 - 3 Operation Procedure”)**

##### Note

- This unit cannot control room temperature. If this is needed, do not install the HRV unit alone, but rather install another indoor unit.

# 8 Operation

## 8 - 2 Safety Cautions

### 8 - 2 - 4 About Direct Duct Connection System

#### Installation Examples

Direct duct connection system

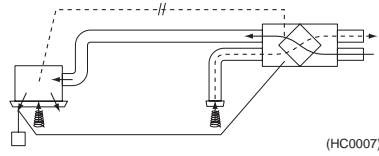

#### Note

- The system must be operated interlocking with the air conditioner.
- Do not connect to the outlet side of the indoor unit.

Independent duct system

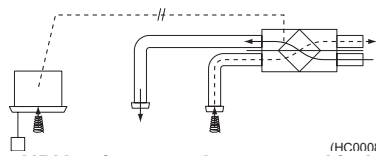

The HRV unit cannot be operated independently when the air conditioner is connected to the HRV unit via a duct. When using the HRV unit, set the air conditioner to “fan” mode on weak fan strength.

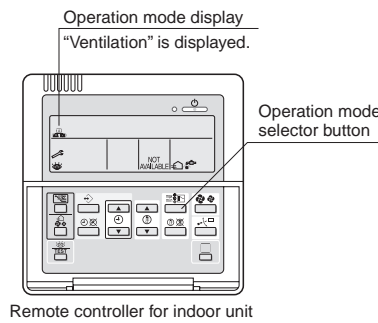

- Each time you press the operation selection button, the operation mode display will change as shown in the figure below.

#### Example 1 :

In case of the remote controller “BRC1D527” and as equivalent. Display changes as below.

When air conditioner and HRV unit are not connected via duct

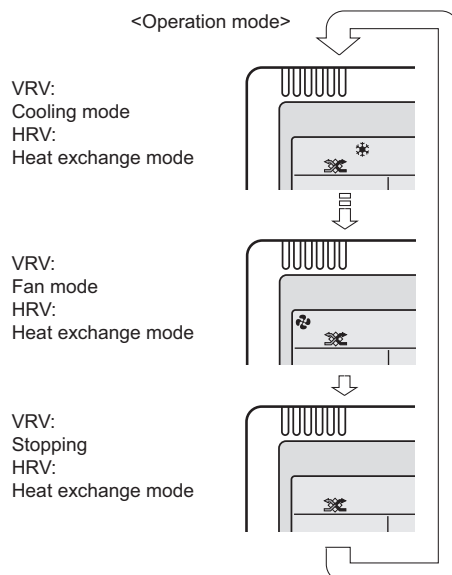

When air conditioner and HRV unit are connected via duct

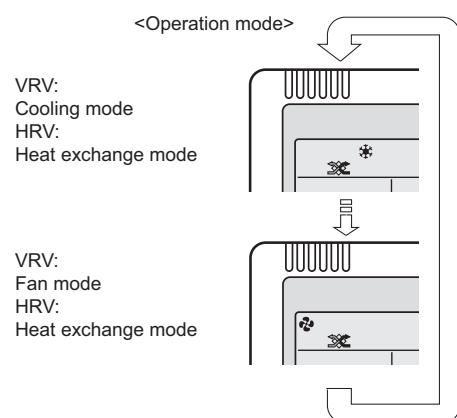

#### Note

Current Ventilation mode can be visible and selected on the remote controller.

## 8 Operation

### 8 - 2 Safety Cautions

#### 8 - 2 - 4 About Direct Duct Connection System

**Example 2 :**  
**In case of the remote controller "BRC1A62"**  
**Display changes as below.**

When air conditioner and HRV unit are not connected via duct

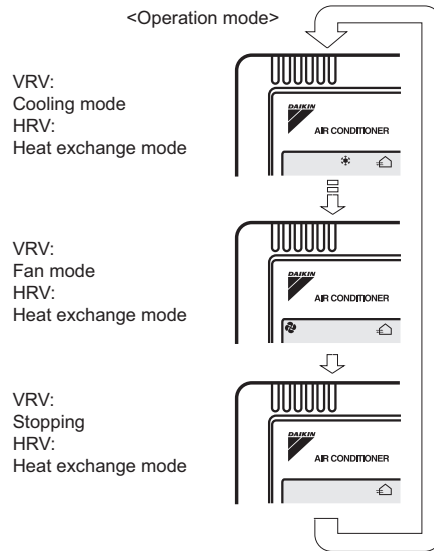

When air conditioner and HRV unit are connected via duct

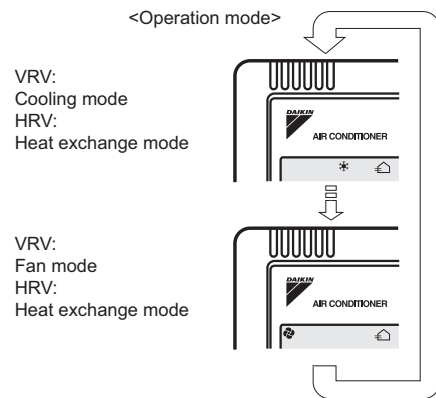

**Note**

**Current Ventilation mode doesn't be displayed.**

- When the display shows " " (time to clean air filter), ask a qualified service person to clean the filters (Refer to the chapter "MAINTENANCE").

## 8 Operation

### 8 - 2 Safety Cautions

#### 8 - 2 - 5 Nighttime Free Cooling Operation <Automatic Heat Purge Function at Night>

The nighttime free cooling is an energy-conserving function which works at night when the air conditioners is off, reducing the cooling load in the morning when the air conditioner is turned on by ventilating rooms which contain office equipment which raises the room temperature.

- Nighttime free cooling only works during cooling and when connected to Building Multi or VRV systems.
- Nighttime free cooling is set to "off" in the factory settings; so request your dealer to turn it on if you intend to use it.

##### Operation image

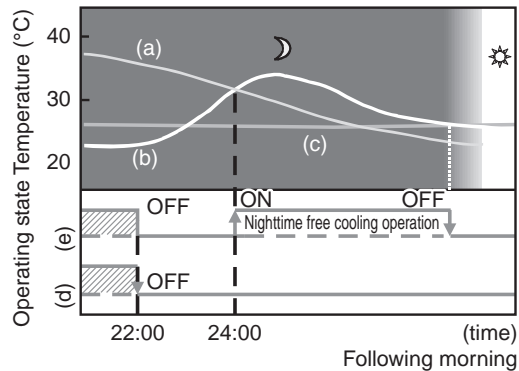

- (a) Outside temperature
- (b) Indoor temperature
- (c) Set temperature
- (d) Operating state of Air conditioner
- (e) Operating state of Total heat exchanger

##### ■ EXPLANATION OF NIGHTTIME FREE COOLING OPERATION IMAGE

The unit compares the indoor and outdoor temperatures after the air conditioning operation stops for the night. If the following conditions are satisfied, the operation starts, and when the indoor temperature reaches the air conditioning setting, the operation stops.

##### <Conditions>

[1] the indoor temperature is higher than the air conditioning setting and

[2] the outdoor temperature is lower than the indoor temperature,

If the above conditions are not satisfied, reevaluation is made every 60 minutes.

## 8 Operation



### 8 - 3 Operation Procedure

#### 8 - 3 - 1 Cooling, Heating and Fan Only Operation (Refer to Figure 5)









##### [PREPARATIONS]

- To protect the unit, turn on the main power switch 6 hours before operation.  
Do not turn off the power during the heating or cooling season. This is to ensure smooth start-up.

Press the operation mode selector button several times and select the operation mode of your choice;

- “” Cooling operation
- “” Heating operation
- “” Fan only operation

##### Note

- “” can only be set for systems operating in cooling and heating at the same time.  
“” is displayed on all remote controllers when using the VRV system cooling only type, but only “” and “” can be set.
- Select the operating mode on a remote controller on which “” is not displayed.  
“” “” and “” (only for simultaneous cooling/heating systems) cannot be selected on remote controllers on which it is displayed.  
See 8 - 3 - 2 if “” is displayed.

Press ventilation mode selector button if you wish to change the mode.

The display rotates through the following selections every time the button is pressed.

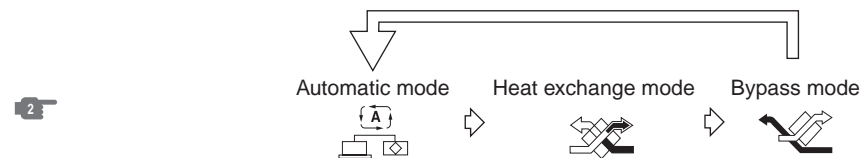

##### Note

- Above is available only if the remote controller BRC1D527 is connected with this unit.  
It is unnecessary to change ventilation mode because the mode is already set to “automatic mode”.
- If you change this mode with BRC1A62, consult your dealer.

Press ventilation fan speed button if you wish to change the fan speed.

The display rotates through the following selections every time the button is pressed.



- After the selection, the ventilation fan speed display disappears.  
And the fan speed of the combined air conditioner regularly displays.

##### Note

- Above is available only if the remote controller BRC1D527 is connected with this unit.
- It is unnecessary to change four speed mode because the mode is already set to “Low” or “High” mode by the installer.
- If you want to know or change this mode with BRC1A62 consult your dealer.

- Press the on/off button.  
The operation lamp lights up and the system starts operation.

#### Stopping the system

Press start/stop one more time. The operation lamp will go off. The unit will stop.

- After stopping operation, the fan may continue operating for up to a minute.
- The fan may stop, but this is not a malfunction.

##### Note







- Do not turn off the power immediately after operation stops. Wait at least 5 minutes.  
Not waiting may cause leaking or malfunction.
- Do not change operations suddenly.  
It can result not only in malfunction but also failure of switches or relays in the remote controller.
- Never press the button of the remote controller with a hard, pointed object.  
The remote controller may be damaged.

## 8 Operation

### 8 - 3 Operation Procedure

#### 8 - 3 - 1 Cooling, Heating and Fan Only Operation (Refer to Figure 5)

##### ■ EXPLANATION OF OPERATION MODE

Cooling mode 	Heating mode 	Automatic mode 
While operating in ventilation mode, the unit adjusts the outside air to the indoor temperature and then brings it into the room.		It automatically selects “  ” or “  .
		<b>Fan mode </b> It only operates in ventilation mode. The unit processes outside air using the heat exchanger element, but not the DX expansion coil.





##### Note

- This unit cannot control room temperature. If this is needed, do not install the HRV unit alone, but rather install another indoor unit.

##### ■ EXPLANATION OF VENTILATION MODE

##### Note

- These icons below are displayed on the remote controller BRC1D527.

Automatic mode : When combined with a VRVIII-system air conditioner  
 The unit automatically switches between “” and “” based on information from the VRVIII system air conditioner (heating, cooling, fan, and set temperature) and information from the HRV unit (indoor and outdoor temperatures).  
 The unit automatically switches between “” and “” when it is combined with an air conditioner (Not produced by Daikin) and based on only the information from the HRV unit (indoor and outdoor temperatures) when the HRV unit is operating alone.

Total heat exchange mode : Outdoor air passes through the heat exchange element and heat exchanged air is sent into the room.

Bypass mode : In this mode outdoor air does not through the heat exchange element, but rather sent into the room as is.

##### ■ EXPLANATION OF HEATING OPERATION

##### Defrost operation

- In heating operation, freezing of the outdoor unit's coil increases. Heating capability decreases and the system goes into defrost operation.
- The remote controller will read “” until the hot air starts blowing.
- It returns to the heating operation again after 6 to 8 minutes (10 at the longest).
- During defrost operation, the fans of the unit continues driving (factory setting). The purpose of this is to maintain the amount of ventilation and humidifying.
- The change of the layout in the room should be examined when the cold draft from air supplying opening is feared.
- Though the fan can be stopped by the setting of remote controller.  
 Do not stop the fan in the place where no ventilation by stopping the fan may cause the influence of diffusion of air which is dirty and moisture into another room, or the inflow from outside the room. (outflow such as viruses from the sickroom, or smell leakage from the rest room, etc.)  
 Contact your dealer for details.

##### Hot start

- The remote controller will read “” until the hot air starts blowing, e.g. at the start of heating operation.

## 8 Operation

### 8 - 3 Operation Procedure

#### 8 - 3 - 2 Setting the Master Remote Controller (Refer to Figure 6)

- When the system is installed as shown below it is necessary to designate one of the remote controllers as the master remote controller.
- Only the master remote controller can select cooling, heating, or automatic operation (the last only on simultaneous cooling/heating systems).
- The displays of slave remote controllers show “” (changeover under control) and they automatically follow the operation mode directed by the master remote controller.

However, it is possible to changeover to program dry with slave remote controllers if the system is in cooling operation set by the master remote controller.

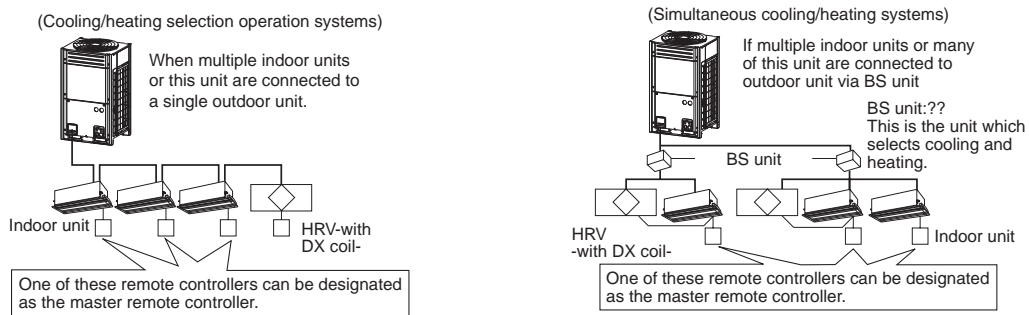

#### ■ HOW TO DESIGNATE THE MASTER REMOTE CONTROLLER

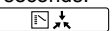
Press the operation mode selector button of the current master remote controller for 4 seconds. The display showing “” (changeover under control) of all slave remote controllers connected to the same outdoor unit or BS unit flashes on.



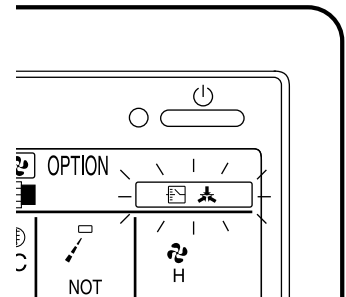

- “” flashes when the power is first turned on.
- The ventilation mode can be changed regardless of the setting (main or slave).

#### Note

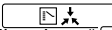
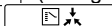
- This unit cannot control room temperature. If the unit is connected to the same system with other indoor units, set the master remote controller on the other indoor units.



- Press the operation mode selector button of the controller that you wish to designate as the master remote controller. Then designation is completed. This remote controller is designated as the master remote controller and the display showing “” (changeover under control) vanishes. The displays of other remote controller show “” (changeover under control).

- Press the operation mode selector button on the master remote controller (i.e. a remote controller which does not display “”) to scroll through the modes. The display will scroll through “” – “” (only for simultaneous cooling/heating systems) – “” – “”. The display on slave remote controllers will also change automatically.

#### ■ Details and activity of operation

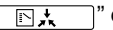
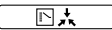
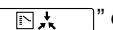
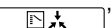
- Setting the master remote controller (without the “” display) to cooling/heating mode will make slave remote controllers (with the “” display) to follow to the mode of the master remote controller. Selection of fan mode is possible, however.
- Setting the master remote controller (without the “” display) to fan mode will make slave remote controllers (with the “” display) any setting other than fan mode impossible.



## 8 Operation

### 8 - 3 Operation Procedure

#### 8 - 3 - 3 Programming Start and Stop of the System with Timer

##### How to Program and Set the Timer with the Remote Controller "BRC1A62" (Refer to Figure 7)

- The timer is operated in the following two ways.  
Programming the stop time "⏸▶○". The system stops operating after the set time has elapsed.  
Programming the start time "⏸▶|". The system starts operating after the set time has elapsed.
- The start and the stop time can be simultaneously programmed.

Press the timer mode start/stop button "⏸" several times and select the mode on the display.

- For setting the timer stop "⏸▶○"
- For setting the timer start "⏸▶|"

Each time the button is pushed, the indication changes as shown below.

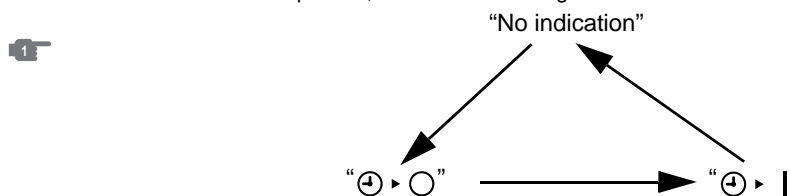

- Press the programming time button and set the time for stopping or starting the system.

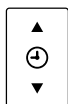

Each time this button is pressed, the time advances or goes backward by 1 hour.

- The timer can be programmed for a maximum of 72 hours.
- Each time when "▲" is pushed, the time advances one hour.  
Each time when "▼" is pushed, the time goes back one hour.

Press the timer on/off button.

The timer setting procedure ends. The display "⏸▶○" or "⏸▶|" changes from flashing light to constant light.

- After the timer is programmed, the display shows the remaining time.

- For cancelling the timer operation, push the timer on/off button "⏸" once again.  
The indication disappears.

##### Note

- When setting the timer off and on at the same time, repeat the above procedure (from "1" to "3") once again.

##### ■DETAIL EXPLANATION

##### When you want to stop operation after a desired time,

##### Example :

Set the time to "8".



8hr  
"⏸▶○" will display.

Stops operation 8 hours after the reservation is complete.

The program will be cleared after the operation stops.

- Set the stop time during operation.

##### When you want to start operation after a desired time has elapsed

##### Example :

Set the time to "8".



8hr  
"⏸▶|" will display.

Starts operation 8 hours after the reservation is complete.

The reservation is cancelled after operation starts.

- Set the start time while the unit is stopped.
- The remaining time will count at the same time after reservation is complete.

See the example below if you want to reserve "off after time" and "on after time" at the same time.

## 8 Operation

### 8 - 3 Operation Procedure

#### 8 - 3 - 3 Programming Start and Stop of the System with Timer

**For example : (Refer to Fig. below)**

When the timer is programmed to stop the system after 3 hours and start the system after 4 hours, the system will stop after 3 hours and start 1 hour later.

**Example :**

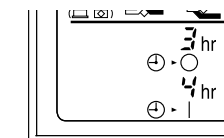

- Setting “off after 3 hours” and “on after 4 hours” will  
↓
- Operation will stop after 3 hours.  
Operation will then start in 1 hour from the time it stopped.

#### How to Program and Set the Timer with the Remote Controller “BRC1D527” (Refer to Figure 7)

- The controller is equipped with a schedule timer that enables the user to operate the installation automatically; setting the clock and day of the week is required to be able to use the schedule timer.
- To set up clock, refer to the operation manual of the remote controller.

Browse to Monday by pressing the “↔” button.

- 1 The “⊖” icon appears, “MON” will blink and one of the “🔄”, “📅”, “🌞”, “🌙”, “🌧️”, “☀️” icons, one of the “🏠”, “🚗”, “🚶”, “🚲” icons might be displayed but all other fields remain blank, indicating that no actions are programmed for Monday.

- 2 Enter the program mode by holding down the “↔” button for 5 seconds, the “⊖” icon will now blink too.

- 3 Press the “↔” button to activate the first programmed action.  
A blinking “1” is displayed indicating that the first programmed action for Monday is being programmed; The set temperature and clock display are blinking.

- 4 Enter the time when the action must start using the “⬇️” & “⬆️” buttons (min. step = 10 minutes).

- 5 Press the “↔” button to display the next programmed action. If a second action is programmed for Monday, “MON” will still be blinking and “1 2” will appear.

- 6 Assuming that 5 actions were programmed for Monday, a total of 5 presses will be required to display all programmed actions.

- 7 Enter the time when the action must stop using the “⬆️” & “⬇️” buttons (min. step = 10 minutes).

Press the “🛑” button. “OFF” icon displays.

This icon means the unit will stop at the set time.

- 7 When all data for the schedule timer actions for Monday are entered, you must confirm the programmed actions.  
Make sure the last schedule timer action you want to keep is selected (schedule timer actions with a higher number will be deleted).

#### Now you must choose between 2 options:

##### 1. CONFIRM AND COPY TO NEXT DAY

- 8 The schedule timer action programmed for the current day are also valid for the next day: use the “confirm last action and copy actions to next day” function by pressing the “↔” and “🛑” buttons simultaneously for 5 seconds. “DAY OF THE WEEK INDICATOR” will change blinking from “MON” to “SUN”.

##### 2.CONFIRM ONLY

- 9 The schedule timer action programmed for the current day are only valid for the selected day: use the “confirm last action and go to next day” function by pressing the “↔” button for 5 seconds.  
Program mode is quit and depending on the choice made, the programmed actions are saved for Monday (and possibly Tuesday).

#### PROGRAMMING THE OTHER DAYS OF THE WEEK

Programming the other days of the week is identical to programming the first day of the week. “TUE” is blinking to indicate the selected day, “⊖” and “1” are steady if actions were copied from Monday to Tuesday, only “⊖” is displayed if no actions were copied from Monday to Tuesday.

## 8 Operation

### 8 - 3 Operation Procedure

#### 8 - 3 - 3 Programming Start and Stop of the System with Timer

**Note**

The schedule timer will not:

- control fan speed,
- control air flow direction,
- control ventilation mode,
- control ventilation amount,
- change the operation mode for a scheduled setpoint.

The parameters listed above can be set manually, without interfering with the schedule timer.

### 8 - 4 Optimum Operation

Observe the following precautions to ensure the system operates.

- **When the display shows “”, ask a qualified service person to clean the filters (Refer to MAINTENANCE).**
- **Do not operate the HRV unit in Bypass mode when the room air is under heating in winter or when the outside temperature is 30°C or higher.**  
This may cause condensation to form on the main unit or on discharge grill, or around air supply opening.
- **Keep the indoor unit and the remote controller at least 1 m away from televisions, radios, stereos, and other similar equipments.**  
This may cause distorted picture or noise.
- **Turn off the main power supply switch when it is not used for long periods of time. When the main power switch is turned on, some watts of electricity is being used even if the system is not operating.**  
Turn off the main power supply switch for saving energy. When reoperating, turn on the main power supply switch 6 hours before operation for smooth running.
- **Use city water or clean water and take steps to prevent condensation from forming. (VKM-GAMV1 series only)**
- **The life of humidifier become shorter when the supply water is hard water. (VKM-GAMV1 series only)**  
Use a water softener.
- **Do not install the remote controller where the indoor temperature and humidity, respectively, are out of the range of 0-35°C and RH 40-80%.**  
This may cause malfunction.
- **Do not install the remote controller where direct sunlight may fall on it.**  
This may cause discoloration or deformation.

**Note**

- When the fan motor fails, the remote controller does not display any error code.  
Usage under that status will lead to insufficient ventilation.  
The air supply and exhaust fans should be checked once every one or two months.  
You can make a simple check such as below way.  
To check the wind flow, hold a bar of which the end has a string or other similar lightweight item over the supply grille and exhaust grille.
- When the solenoid valve fails, the remote controller does not display any error code.  
Usage under that status will lead to insufficient humidification and increased tap water consumption.  
The solenoid valve should be checked at the beginning of the heating season.  
<VKM-GAMV1 series only>

## 8 Operation

### 8 - 5 Maintenance (for a Qualified Service Person only)

**ONLY A QUALIFIED SERVICE PERSON IS ALLOWED TO PERFORM MAINTENANCE**

DO NOT CHECK OPENING INSIDE THE UNIT BY YOURSELF.

---

**⚠ WARNING**

- **BEFORE OBTAINING ACCESS TO TERMINAL DEVICES, ALL POWER SUPPLY CIRCUITS MUST BE INTERRUPTED.**
- To clean the HRV, or maintenance be sure to stop operation, and turn the power switch off. It may cause electrical shock and it is very dangerous to touch the rotating part.
- Do not wash the HRV with water. Doing so may result in an electric shock.

---

**⚠ CAUTION**

- Use gloves when cleaning. Cleaning without gloves may cause injury.
  - Watch your step. Use caution, as this requires working in high places.
  - Do not use benzene or thinner to clean the outside surfaces of the air conditioner. This may cause cracks, discoloration, or machine trouble.
- 

#### 8 - 5 - 1 How to clean the Air Filter

Clean the air filter when the display shows “” (TIME TO CLEAN AIR FILTER).

It will display that it will operate for a set amount of time.

**AT LEAST ONCE EVERY YEARS (FOR GENERAL OFFICE USE)  
(CLEAN THE MORE FREQUENTLY IF NECESSARY.)**

- Increase the frequency of cleaning if the unit is installed in a room where the air is eternely contaminated.
- If the dirt becomes impossible to clean, change the air filter (Air filter for exchange is optional).

(1) Detach the maintenance cover.  
Go into ceiling through the inspection hatch, remove binding metal of maintenance cover and take it off.  
**(Refer to figure 8-1)**

(2) Detach the air filter.  
Take out from the heat exchange elements.  
**(Refer to figure 8-2)**

(3) Clean the air filter. **(Refer to figure 9)**  
Use vacuum cleaner A) or wash the air filter with water B).  
A) Using a vacuum cleaner  
B) Washing with water  
When the air filter is very dirty, use soft brush and neutral detergent.  
After cleaning, remove water and dry in the shade.

**Note**

- Do not wash the air filter with hot water of more than 50°C, as doing so may result in discoloration and/or deformation.
- Do not expose the air filter to fire, as doing so may result in burning.
- Do not use gasoline, thinner, or other organic solvents. This may cause discoloration or deformation.

(4) Fix the air filter.  
If the air filter is washed, remove water completely and allow to dry for 20 to 30 minutes in the shade. When dried completely, install the air filter back in place. **(Refer to figure 10)**

**Note**

- Be sure to install the air filter after servicing.  
(Missing air filter causes clogged heat exchange element.)  
The air filter is an optional item and the replacement is available.

(5) Install the maintenance cover. **(Refer to 8 - 5 - 1, (1)).**

For remote controllers which display the filter sign, turn on the power after maintenance, and press the filter sign reset button.

\* Consult your dealer if you want to change the time setting for when the filter sign goes on.

---

**⚠ CAUTION**

- **Always use the air filter.**  
If the air filter is not used, heat exchange elements will be clogged, possibly causing poor performance and subsequent failure.
-

## 8 Operation

### 8 - 5 Maintenance (for a Qualified Service Person only)

#### 8 - 5 - 2 How to clean the Heat Exchange Element

**AT LEAST ONCE EVERY TWO YEARS (FOR GENERAL OFFICE USE)  
(CLEAN THE ELEMENT MORE FREQUENTLY IF NECESSARY.)**

**⚠ WARNING**

- **Please exchange the heat exchange element if you find that the knob of the heat exchange element is damaged or is deteriorated when cleaning it.**  
There is falling danger.

- (1) Detach the maintenance cover. (Refer to 8 - 5 - 1, (1)).
- (2) Detach the air filter. (Refer to 8 - 5 - 1, (2)).
- (3) Take out the heat exchange elements.  
Pull out the air filter and then pull out the two heat exchanger elements. (Refer to figure 11)
- (4) Use a vacuum cleaner to remove dust and foreign objects on the surface of the heat exchange element. (Refer to figure 12)
  - Use the vacuum cleaner equipped with a brush on the tip of the suction nozzle.
  - Lightly contact the brush on the surface of the heat exchange element when cleaning. (Do not crush the heat exchange element while cleaning.)

**⚠ CAUTION**

- Do not clean touching strongly with a vacuum cleaner. This may crush the mesh of the heat exchange elements.
- Never wash the heat exchange element with water.
- Have your dealer professionally clean the filter if it is very dirty.

- (5) Put the heat exchange element on the rail and insert it securely in place.
- (6) Install the air filter securely in place. (Refer to 8 - 5 - 1, (4))
- (7) Install the maintenance cover securely in place. (Refer to 8 - 5 - 1 (5))

#### 8 - 5 - 3 Seasonal Maintenance <VKM-GAMV1 series only>

##### At the Beginning of the Season

- (1) **Check below**
  - Are the indoor and outdoor unit intake and outlet vents blocked?  
Remove anything that might be blocking them.
- (2) **Turn the power on**
  - When the power comes on, the characters in the remote controller display appear.  
(To protect the unit, turn the power on at least 6 hours before operating it. This makes operation smoother.)
- (3) **Supply water** (Start of heating season)

##### At the end of the Season

- (1) **On a clear day, use fan only operation for around half a day to thoroughly dry out the interior of the unit.**
  - Refer to 8 - 3 - 1 for details on fan operation.
- (2) **Turn off the power**
  - When the power is shut off, the characters in the remote controller display disappear.
  - When the power is on, the unit consumes up to several dozen Watts of power.  
Turn off the power to conserve energy.
- (3) **Stop water supply** (End of heating season)

#### 8 - 5 - 4 Inspection and Maintenance of the Humidifier <VKM-GAMV1 series only>

- **Have your dealer do the following inspections in order to get the longest use.**
- In order to prevent harmful bacteria from generating, ask your dealer to do maintenance on humidifying unit portion at the beginning or the end of the heating season.

**Note**

- When the solenoid valve fails, the remote controller does not display any error code.  
Usage under that status will lead to insufficient humidification and increased tap water consumption.  
The solenoid valve should be checked at the beginning of the heating season.

## 8 Operation

### 8 - 5 Maintenance (for a ualified Service Person Only)

#### 8 - 5 - 4 Inspection and Maintenance of the Humidifier <VKM-GAMV1 series only>

For dealers

Inspected part	Content of maintenance		Problems if maintenance is not carried out
	Items to be inspected	Solution	
Strainer (80-mesh)	Check for clogging	Clean if clogged.	Insufficient humidifying.
	Check o-ring for cracks	Replace if cracked.	Leaking.
Feed water tank	Check for operation of float switch	Clean if it does not work properly due to build-up.	Insufficient humidifying. Overflowed feed water tank.
	Check for dirt	Clean if very dirty.	Weak fan strength. Reduced humidifying capacity.
Solenoid valve	Check for shutting and opening. Check in a similar fashion when checking the float switch operation.	Replace if it doesn't work.	Insufficient humidifying. Overflowed feed water tank. (Increased tap water consumption)

#### 8 - 5 - 5 Inspection of the Fan Motor

**Note**

- When the fan motor fails, the remote controller does not display any error code. Usage under that status will lead to insufficient ventilation. The air supply and exhaust fans should be checked once every one or two months. You can make a simple check such as below way. To check the wind flow, hold a bar of which the end has a string or other similar lightweight item over the supply grille and exhaust grille.

#### 8 - 5 - 6 Replacing the Humidifier Element <VKM-GAMV1 series only>

- The humidifier element needs to be replaced regularly. The humidifier element should in general be replaced once every three years when supply water is soft water, but outside factors (If the water quality is hard water, etc.) as well as operating conditions (24-hour-a-day air conditioning, etc.) may shorten its productive life.
- Contact your dealer if you have any questions.

## 8 Operation

### 8 - 6 Trouble Shooting

#### 8 - 6 - 1 The Following Situations are not Malfunctions.

- **Operation does not start.**

**<Symptom>**

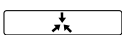
The icon "  " (under centralized control) is displayed on the remote controller and pressing the on/off button causes the display to blink for a few seconds.

**<Cause>**

This indicates that the central device is controlling the unit.  
The blinking display indicates that the remote controller cannot be used.

**<Symptom>**

The fans rotate after 1 minute when pressing on on/off button.

**<Cause>**

This indicates that the operation is in preparation.  
Wait for about 1 minute.

- **Operation stops sometimes.**

**<Symptom>**

"U5" is displayed on the remote controller and the operation stops but then restarts after a few minutes.

**<Cause>**

This indicates that the remote controller is intercepting noise from electrical appliances other than the HRV unit, and this prevents communication between the units, causing them to stop.  
Operation automatically restarts when the noise goes away.

- **"88" is displayed on the remote controller.**

**<Symptom>**

It displays immediately after the power is turned on, and disappears after several seconds.

**<Cause>**

This indicates that the unit is checking whether or not the remote controller is normal.  
It is only displayed temporarily.

#### 8 - 6 - 2 If One of the Following Malfunctions Occurs, take the Measures Shown below and Contact Your Daikin Dealer.

The system must be repaired by a qualified service person.  
DO NOT CHECK AND REPAIR OPENING INSIDE THE UNIT BY YOURSELF.

—  **WARNING** —

**When the HRV is in abnormal conditions (smell of something burning, etc), cut off the power, and contact your dealer.**

Continued operation under such circumstances may result in a failure, electric shock, and fire.

- **The unit does not operate at all.**

a. Check if there is a power failure.

**Measure:** After power has been restored, start operation again.

b. Check if the fuse has blown.

**Measure:** Turn the power off.

c. Check if breaker has worked.

**Measure:** Turn the power on with the breaker switch in the off position.  
Do not turn the power on with the breaker switch in the trip position. (Contact your dealer.)

- **If a safety device such as a fuse, a breaker, or an earth leakage breaker frequency actuates, or ON/OFF switch does not properly work.**

**Measure:** Do not turn the power on.

- **The remote control buttons do not work well.**

**Measure:** Turn off the main power switch.

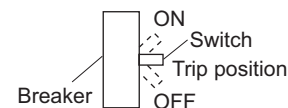

## 8 Operation

### 8 - 6 Trouble Shooting

#### 8 - 6 - 2 If One of the Following Malfunctions Occurs, take the Measures Shown below and Contact Your Daikin Dealer.

- If the display “” (INSPECTION), “UNIT No.” and the OPERATION lamp flash and the “MALFUNCTION CODE” appears.  
**Measure:** Notify and inform the model name and what the malfunction code indicates to your Daikin dealer.

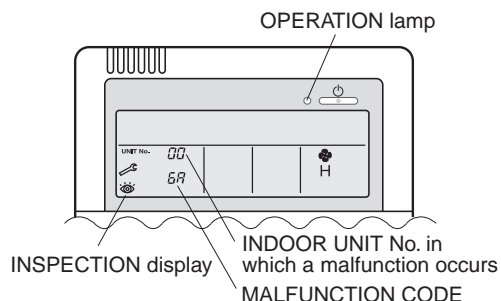

- There are other malfunctions.  
**Measure:** Stop the unit.

List of malfunction codes of Remote controller of the HRV-system

Operation lamp	Inspection indicator	Unit No.	Malfunction code	Description
On	Off	Blinking	64	Indoor air thermistor malfunction
On	Off	Blinking	65	Outdoor air thermistor malfunction
On	Off	Blinking	6A	Dumper-related malfunction
Blinking	Blinking	Blinking	6A	Dumper-related malfunction + thermistor malfunction
Blinking	Blinking	Blinking	A1	Printed circuit board fault
On	Off	Blinking	A1	Printed circuit board fault
Blinking	Blinking	Blinking	A9	Electric expansion valve drive error
Blinking	Blinking	Blinking	C4	Liquid piping thermistor error (faulty connection, disconnection short circuit, fault)
Blinking	Blinking	Blinking	C5	Gas piping thermistor error (faulty connection, cut wire, short circuit, fault)
Blinking	Blinking	Blinking	C9	Intake air into coil thermistor error (faulty connection, disconnection, short circuit, fault)
Blinking	Blinking	Blinking	U3	Test run not performed
Blinking	Blinking	Blinking	U5	Transmission error between the unit and remote controller
Off	Blinking	Off	U5	Setting error of remote controller
Off	Blinking	Off	U8	Transmission error between main remote controller and sub remote controller
Off	Blinking	Blinking	UA	Incorrect combination with indoor unit and remote controller.
On	Blinking	On	UC	Central control address over lapping
Blinking	Blinking	Blinking	UE	Transmission error between the unit and centralized controller

In case of the malfunction with the code in white letters on the black background in the unit still operates. However, be sure to have it inspected and repaired and as soon as possible.

If other than the above error codes are displayed, there is a possibility that the problem in question has occurred with a combined air conditioner or outdoor unit. See the operation manuals included with the air conditioners or outdoor units for details.



## 8 Operation

### 8 - 6 Trouble Shooting

#### 8 - 6 - 3 If the System does Not Properly Operate Except for the Above Mentioned Case, and None of the Above Mentioned Malfunctions is Evident, Contact your Dealer, and Request for Investigation the System According to the Following Procedures by a Qualified Service Person.

The following malfunctions must be checked by a qualified service person. Do not check by yourself.

- **The unit does not operate at all.**
  - a. Check if there is a power failure.  
After power has been restored, start operation again.
  - b. Check if the fuse has blown.  
Change the fuse.
  - c. Check if breaker has worked.  
Contact your dealer.
  - d. Are there any problems with the power or wiring?  
Inspect the power and wiring.
  - e. Are there any problems with the fan unit?  
Inspect the fan motor and fan.
- **Amount of discharged air is small and the discharging sound is high.**
  - a. Check if the air filter and heat exchange element are clogged.  
(Check both SA and RA air filter. Check both sides of elements.)  
Clean the air filter and heat exchange element.
- **Amount of discharged air is large and so is the sound.**
  - a. Check if the air filter and heat exchange element are not installed.  
Install the air filter and heat exchange element.
- **It dries usually in winter. <VKM-GAMV1 series only>**
  - a. Is the water supply service valve open?  
Open the water supply service valve.
  - b. Have you lowered setting on the humidistat (locally procured) too far?  
Correct the setting.
- **Humidifies very little or not at all. <VKM-GAMV1 series only>**
  - a. Is there water in the water supply tank?
  - b. Is water being supplied?  
Inspect the water supply pipes and supply the water.
  - c. Is the strainer clogged?  
Clean the strainer.
  - d. Is the solenoid valve broken (i.e. won't open)?  
Replace the solenoid valve.
  - e. Is the humidifier element torn?  
Replace.
  - f. Has the water resistance of the humidifier element dropped?  
Replace the humidifier element.
  - g. Are the control circuits broken?  
Replace the printed circuit board and other electric parts.
  - h. Is the float switch broken?  
Replace the float switch.
  - i. Is the water supply pressure sufficient?  
Re-set it so that there is sufficient pressure.
  - j. Is there foreign matter in the feed water tank?  
Clean the feed water tank.

## 8 Operation

### 8 - 7 After-sales Service and Warranty

**After-sales service:**

**⚠ WARNING**

- **Do not modify the unit.**  
This may cause electric shock or fire.
- **Do not disassemble or repair the unit.**  
This may cause electric shock or fire.  
Contact your dealer.
- **If the refrigerant leaks, keep out of fire.**  
The refrigerant used in this unit is safe.  
Although the refrigerant does not usually leak, if the refrigerant leaks out into a room and comes in contact with the combustible air in the equipment such as fan heater, stove, oil (gas) cooker, etc., it will cause toxic gas to be generated.  
When a refrigerant leakage failure has been repaired, confirm a service person that the leakage point has been corrected surely before restarting operation.
- **Do not remove or reinstall the unit by yourself.**  
Incomplete installation may cause a water leakage electric shock and fire.  
Contact your dealer.

■ **When asking your dealer to repair, inform related staff of the details as follows:**

- Shipping date and installation date:
- Malfunction:  
Inform the staff of the defective details.  
(Malfunction code being displayed on the remote controller.)
- Name, address, telephone number

■ **Repair where the warranty term is expired**

Contact your dealer. If necessary to repair, pay service is available.

■ **Minimum storage period of important parts**

Even after a certain type of air conditioner is discontinued, we have the related important parts in stock for 6 years at least.

The important parts indicate parts essential to operate the air conditioner.

■ **Recommendations for maintenance and inspection**

Since dust collects after using the unit for several years, the performance will be deteriorated to some extent.

Taking apart and cleaning inside require technical expertise, so we recommend entering a maintenance and inspection contract (at a cost) separate from normal maintenance.

■ **Recommended inspection and maintenance cycles**

**[Note: The maintenance cycle is not the same as the warranty period.]**

Table 1 assumes the following usage conditions.

- Normal use without frequent starting and stopping of the machine.  
(Although it varies with the model, we recommend not starting and stopping the machine more than 6 times/hour for normal use.)
- Operation of the product is assumed to be 10 hours/day, 2500 hours/year.
- Table 1 “Inspection Cycle” and “Maintenance Cycle” Lists

Name of Main Part	Inspection Cycle	Maintenance Cycle [replacements and/or repairs]
Electric motor (fan, damper, etc.)	1~2 months recommended *1	20,000 hours
PC boards	1 year	25,000 hours
Heat exchanger element		10 years
Heat exchanger		5 years
Sensor (thermistor)		5 years
Remote controller and switches		25,000 hours
Drain pan		8 years
Expansion valve	1 year *2	20,000 hours
Electromagnetic valve	1 year	20,000 hours

\*1 :

- When the fan motor fails, the remote controller does not display any error code.  
Usage under that status will lead to insufficient ventilation.  
The air supply and exhaust fans should be checked once every one or two months.
- You can make a simple check such as below way.  
To check the wind flow, hold a bar of which the end has a string or other similar lightweight item over the supply grille and exhaust grille.

\*2 :

- When the solenoid valve fails, the remote controller does not display any error code.  
Usage under that status will lead to insufficient humidification and increased tap water consumption.  
The solenoid valve should be checked at the beginning of the heating season.

## 8 Operation

### 8 - 7 After-sales Service and Warranty

**Note 1**

This table indicates main parts.  
See the maintenance and inspection contract for details.

**Note 2**

This maintenance cycle indicates recommended lengths of time until the need arises for maintenance work, in order to ensure the product is operational as long as possible.

Use for appropriate maintenance design (budgeting maintenance and inspection fees, etc.).  
Depending on the content of the maintenance and inspection contract, the inspection and maintenance cycles may in reality be shorter than those listed here.

**Shortening of “maintenance cycle” and “replacement cycle” needs to be considered in the following cases.**

- When used in hot, humid locations or locations where temperature and humidity fluctuate greatly.
- When used in locations where power fluctuation (voltage, frequency, wave distortion, etc.) is high.  
(Cannot be used if it is outside the allowable range.)
- When installed and used in locations where bumps and vibrations are frequent.
- When used in bad locations where dust, salt, harmful gas or oil mist such as sulfurous acid and hydrogen sulfide may be present in the air.
- When used in locations where the machine is started and stopped frequently or operation time is long.  
(Example: 24 hour air-conditioning)
- When the supply water is hard water the humidifier's life become shorter.

■ **Recommended replacement cycle of wear-out parts**

**[The cycle is not the same as the warranty period.]**

- Table 2 “Replacement Cycle” Lists

Name of Main Part	Inspection Cycle	Replacement Cycle
Air filter	1 year	3 years
High efficiency filter (Optional accessory)		1 year
Heat exchanger element	2 years	10 years
Humidifier element	1 year	3 years (Note 3)

**Note 1**

This table indicates main parts.  
See the maintenance and inspection contract for details.

**Note 2**

This maintenance cycle indicates recommended lengths of time until the need arises for maintenance work, in order to ensure the product is operational as long as possible.

Use for appropriate maintenance design (budgeting maintenance and inspection fees, etc.).

**Note 3**

Life of humidifying element is about 3 years (4,000 hours), under the supply water conditions of hardness: 150mg/l.  
(Life of humidifying element is about 1 year (1,500 hours), under the supply water conditions of hardness: 400mg/l.)  
Annual operating hours: 10 hours/day × 26 days / month × 5 month = 1,300 hours.

Contact your dealer for details.

Note: Breakage due to taking apart or cleaning inside by anyone other than our authorized dealers may not be included in the warranty.

■ **Moving and discarding the unit**

- Contact your dealer for removing and reinstalling the total enthalpy heat exchanger when moving house since they require technical expertise.
- This unit contains chlorofluorocarbon in the refrigerant.  
When discarding, removing installing and maintaining the unit, collect the refrigerant in accordance with the local law for the global environmental destruction prevention.  
In detail contact your dealer.

■ **Where to call**

For after-sales service, etc., consult with your dealer.

■ **Warranty period:**

**Warranty period: Within one year after installation.**

- If it is necessary to repair the air conditioner within the warranty period, contact your dealer.

## 9 Installation

### HRV;Heat Reclaim Ventilation

Please read this installation manual carefully and install the unit properly to keep it at full capacity for a long time.

Please provide some necessary parts, for example round hoods, air suction/discharge grilles etc., before the installation of the unit.

### 9 - 1 Before Installation

**The accessories needed for installation must be retained in your custody until the installation work is completed. Do not discard them!**

After carrying in the unit, protect it with packing materials to prevent it from scratching until installation work is done.

[1] Decide upon a line of transport.

[2] Leave the unit inside its packaging while moving, until reaching the installation site. Where unpacking is unavoidable, use a sling of soft material or protective plates together with a rope when lifting, to avoid damage or scratches to the unit.

**Hold the unit by the hanger brackets (4) when opening the crate and moving it, and do not lift it holding on to any other part (especially the refrigerant piping, the drain piping, the water supply piping, and the duct connecting flange).**





- Be sure to check the type of R-410A refrigerant to be used before installing the unit. (Using an incorrect refrigerant will prevent normal operation of the unit.)
- For the installation of an outdoor unit, refer to the installation manual attached to the outdoor unit.



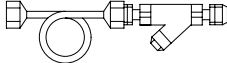

#### 9 - 1 - 1 Precautions

- Be sure to instruct customers how to properly operate the unit (especially maintenance of air filter, and operation procedure) by having them carry out operations themselves while looking at the manual.
- Where the air contains high levels of salt such as that near the ocean and where voltage fluctuates greatly such as that in factories. Also in vehicles or vessels.

#### 9 - 1 - 2 Accessories

Check the following accessories are included with your unit.

Name	Duct connecting flange	M4 tapping screw (For connecting duct)	Water supply piping with strainer	Half-union joint (Copper piping joint)	Flare nut (Copper piping joint)
Quantity	4 pcs.	24 pcs.	VKM-GAMV1: 1 pc. VKM-GAV1: 0 pc.	VKM-GAMV1: 1 pc. VKM-GAV1: 0 pc.	VKM-GAMV1: 1 pc. VKM-GAV1: 0 pc.
Shape		 50 type M4x12 80, 100 type M4x16			

Name	Refrigerant piping insulation cover	Water supply piping insulation cover	Sealing material	Clamp	(Other) • Installation manual • Operation manual
Quantity	1 set	VKM-GAMV1: 1 pc. VKM-GAV1: 0 pc.	1 pc.	VKM-GAMV1: 8 pcs. VKM-GAV1: 6 pcs.	
Shape	 I.D.: φ35 I.D.: φ26	 I.D.: φ15			

## 9 Installation

### 9 - 1 Before Installation

#### 9 - 1 - 3 Optional Accessories

- This unit can be made a part of two different systems: as part of the combined operation system used together with VRVIII SYSTEM Air Conditioners, and as the independent system using only the HRV. An operating remote controller is required for this unit when using the unit as an independent system. Select a suitable remote controller from below table according to customer request and technical materials.

Table

Remote controller type	BRC1A62, BRC1D527
------------------------	-------------------

#### NOTE) 1

If you use the remote controller which is not listed in above table, please consult your dealer.

#### NOTE) 2

We recommend the remote controller “BRC1D527” especially when the unit is used as independent system. Because it displays the ventilation mode and can be selected ventilation fan mode with the button.

- When installing the unit, have ready the round shape hood, the air discharge grille and the air suction grille, and other parts needed for the installation. Consult your Daikin dealer when selecting optional accessories.

### FOR THE FOLLOWING ITEMS, TAKE SPECIAL CARE DURING CONSTRUCTION AND CHECK AFTER INSTALLATION IS FINISHED.

#### a. Items to be checked after completion of work

Items to be checked	If not properly done, what is likely to occur	Check
Are the indoor and outdoor unit fixed firmly?	The units may drop, vibrate or make noise.	
Is the outdoor duct installed to outside with down slope? <b>(Refer to Fig. 16)</b>	Condensate water may drip.	
Is the gas leak test finished?	It may result in insufficient cooling.	
Is the unit fully insulated?	Condensate water may drip.	
Does drainage flow smoothly?	Condensate water may drip.	
Does the power supply voltage correspond to that shown on the name plate?	The unit may malfunction or the components burn out.	
Are wiring and piping correct?	The unit may malfunction or the components burn out.	
Is the unit safely grounded?	Dangerous at electric leakage.	
Is wiring size according to specifications?	The unit may malfunction or the components burn out.	
Is something blocking the air outlet or inlet of either the indoor or outdoor units?	It may result in insufficient cooling.	
Are refrigerant piping length and additional refrigerant charge noted down?	The refrigerant charge in the system is not clear.	
Is water supplied with the water supply piping connected?	Not humidified.	

Please check all items listed in the “SAFETY CONSIDERATIONS” above once again.

#### b. Items to be checked at time of delivery

Items to be checked	Check
Did you explain about operations while showing the operation manual to your customer?	
Did you hand the operation manual and warranty over to your customer?	

#### C. Points for explanation about operations

The items with ⚠ **WARNING** and ⚠ **CAUTION** marks in the operation manual are the items pertaining to possibilities for bodily injury and material damage in addition to the general usage of the product. Accordingly, it is necessary that you make a full explanation about the described contents and also ask your customers to read the operation manual.

## 9 Installation

### 9 - 2 Selecting Installation Site

—  **CAUTION** —

- When moving the unit during or after unpacking, make sure to lift it by holding its hanger brackets. Do not exert any pressure on other parts, especially the refrigerant piping, drain piping, water supply piping and duct connecting flange.
- If you think the humidity inside the ceiling might exceed 30°C and RH80%, reinforce the insulation on the inter-unit piping.  
Use glass wool or polyethylene foam as insulation so that it is no thicker than 10mm and fits inside the ceiling opening.
- Use glass wool or polyethylene form of 10mm or more thick which fit into ceiling opening as insulation material.

**1. Select an installation site where the following conditions are fulfilled and that meets with your customer's approval.**

- Install in a place which has sufficient strength and stability.  
(Beams, ceiling, and other locations capable of fully supporting the weight of the unit.)  
Insufficient strength is dangerous. It may also cause vibration and unusual operating noise.
- Where piping between indoor and outdoor units is possible within the allowable limit.  
(Refer to the installation manual for the outdoor unit.)
- Where nothing blocks air passage.
- Where condensate can be properly drained.
- Install in a location where the air around the unit or taken into the humidifier will not drop below 0°C.
- Do not install the unit directly against a ceiling or wall.  
(If the unit is in contact with the ceiling or wall, it can cause vibration.)
- Where sufficient clearance for maintenance and service can be ensured. (Refer to Fig. 1)

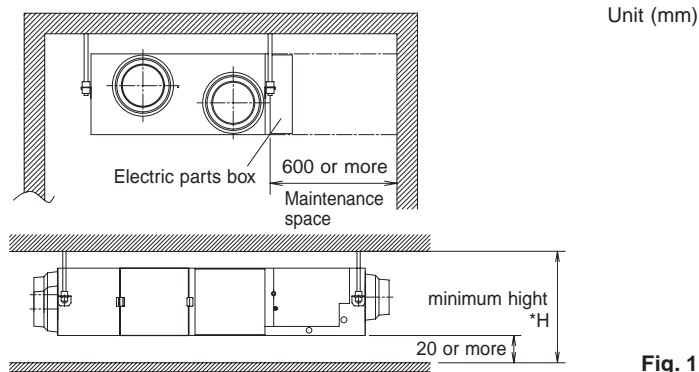

Fig. 1

- Select the \*H dimension such that a downward slope of at least 1/100 is ensured as indicated in “9 Installation”.

**[PRECAUTION]**

- Install the indoor and outdoor units, power supply wiring and connecting wires at least 1 meter away from televisions or radios in order to prevent image interference or noise. Depending on the radio waves, a distance of 1 meter may not be sufficient enough to eliminate the electric noise.
  - The bellows may not be able to be used in some districts, so exercise caution.  
(Contact your local government office or fire department for details.)
  - When discharging exhaust air to a common duct, the Building Standard Law requires the use of fire-proof materials, so attach a 2 m copper plate standing duct or smoke back flow prevention damper.
- 2. Use suspension bolts for installation. Check whether the ceiling is strong enough to support the weight of the unit or not. If there is a risk, reinforce the ceiling before installing the unit.**  
(Installation pitch is mentioned as follow. Refer to it to check for points requiring reinforcing.)

## 9 Installation

### 9 - 3 Preparations before Installation

**1. Confirm the positional relationship between the unit and suspension bolts. (Refer to Fig. 2)**

Leave space for servicing the unit and include inspection hatches. (Always open a hole on the side of the electric parts box so that the air filters, heat exchange elements, fans, and humidifier elements can easily be inspected and serviced.)

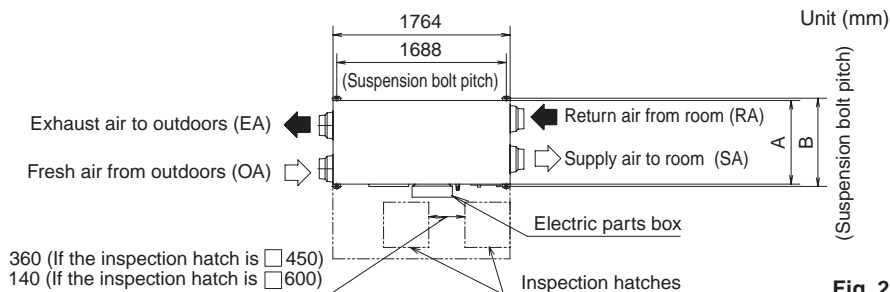

**Fig. 2**

(mm)

Model	A	B
VKM50GAMV1, VKM50GAV1	832	878
VKM80GAMV1, VKM80GAV1 VKM100GAMV1, VKM100GAV1	1214	1262

**2. Make sure the range of the unit's external static pressure is not exceeded.**

(See the fan-strength and static performance characteristic drawings as well as the general catalog for the range of the external static pressure setting.)

**3. Open the installation hole. (Pre-set ceilings)**

- Once the installation hole is opened in the ceiling where the unit is to be installed, pass refrigerant, drain piping, transmission wiring, and remote controller wiring to the unit's piping and wiring holes. See "9 Installation", "9 - 6 Refrigerant Piping Work", and "9 - 9 Wiring Example and how to set the Remote Controller".
- After opening the ceiling hole, make sure ceiling is level if needed. It might be necessary to reinforce the ceiling frame to prevent shaking. Consult an architect or carpenter for details.

**4. Install the suspension bolts.**

(Use M10 to M12 suspension bolts.)  
Use a hole-in-anchor, sunken insert, sunken anchor for existing ceilings, or other part to be procured in the field to reinforce the ceiling to bearing the weight of the unit. (Refer to Fig. 3)

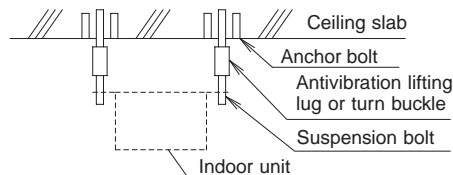

Note: All the above parts are locally procured.

**Fig. 3**

## 9 Installation

### 9 - 4 The Method of Installation

**CAUTION**

«Hold underside of the unit or hanger bracket without putting force on other parts when unpacking or moving the unit.»

«As for the parts to be used for installation work, be sure to use the provided accessories and specified parts designated by our company.»

**(1) Install the unit temporarily.**

- Attach the hanger bracket to the suspension bolt. Be sure to fix it securely by using nuts (M10, M12) and washers (M10 with external dia. 30 to 34 mm, M12 with external dia. 36 to 38 mm) (locally procured) from the upper and lower sides of the hanger bracket. **(Refer to Fig. 4)**

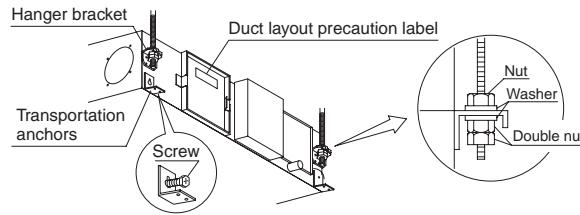

Fig. 4

**(2) If unnecessary, remove the four transportation anchors.**

- Loosen the screws.
- Slide upward and remove the transportation anchors.
- Securely tighten the screws as before.

**CAUTION**

- The screws shouldn't be removed from the unit and should be tightened in order to prevent air from escaping.
- Check that foreign objects such as plastic or paper are not contained in the unit when installing.

- Install the unit after checking the indoor (SA/RA) and outdoor (EA/OA) in accordance with the figure duct layout precaution label.
- Do not turn the unit upside down.

**(3) Adjust the height of the unit. (Tighten the double nuts securely.)**

**(4) Check the unit is horizontally level.**

**CAUTION**

Use a level to make sure that the unit is level and that the tilt (downward slope) to the drain piping connection is within 1°. (Refer to Fig. 5)

(One thing to watch out for in particular is if it is installed so that the slope is not in the direction of the drain piping, as this might cause leaking.)

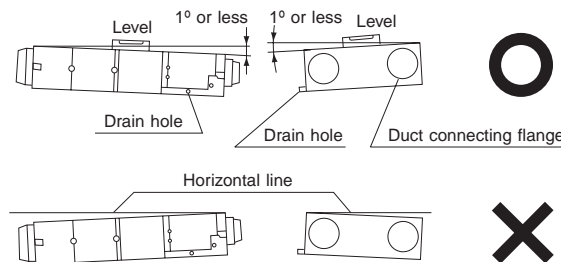

Fig. 5

**(5) Tighten the upper nut.**

**(6) Attach the accessory duct connecting flanges using the included screws to the outlet and intake holes (a total of four).**

When attaching, make sure the alignment markings on the unit match up with the triangle on the each duct connecting flange. **(Refer to Fig. 6)**

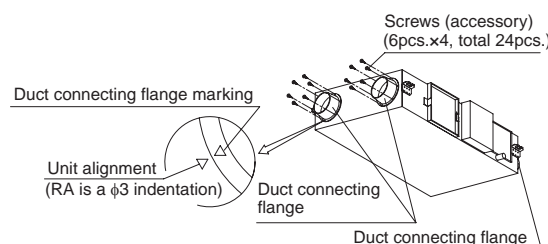

Fig. 6



## 9 Installation

### 9 - 5 Drain Piping and Water Supply Work

#### (1) Install the drain piping.

- Make sure the drain works properly.
- In case of the direct duct connection system, there is negative pressure inside the unit relative to atmospheric pressure when the unit is running, so be sure to provide drain trap on the drain outlet. (See Fig. 7-1)

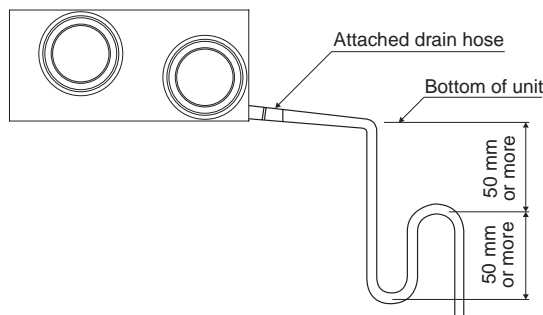

Fig. 7-1

#### CAUTION

Do not connect the drain piping directly to sewage pipes that smell of ammonia. The ammonia in the sewage might enter the indoor unit through the drain pipes and corrode the heat exchanger (Direct expansion coil).

- Keep the drain pipe short and sloping downwards at a gradient of at least 1/100 to prevent air pockets from forming. (Refer to Fig. 7-2)
- If converging multiple drain pipes, install according to the procedure shown below. (Install a drain trap for each indoor unit.)

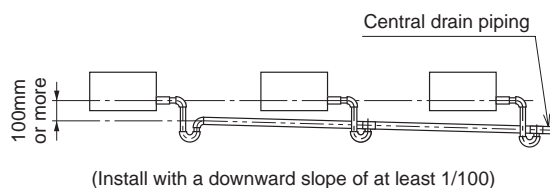

Fig. 7-2

#### CAUTION

Water accumulating in the drain piping can cause the drain to clog.

- The diameter of the drain pipe should be greater than or equal to the diameter of the connecting pipe. (pipe size: PT3/4B)
- When piping passes indoors, always insulate it all the way to the base of the drain socket.
- In areas where freezing may occur, always take steps to prevent the pipes from freezing.
- Make sure water doesn't leak from the drain pipes.
- Avoid bends and curves in the pipes to prevent them getting clogged.
- If you are using central drain piping, follow the procedure outlined in the figure 7-2.
- Select central drain pipes of proper size according to the capacity of the connected unit.
- Make sure the tip of the drain pipes opens out into a location where the drainage can be safely processed.

#### (2) After piping work is finished, check drainage flows smoothly.

- Test the drainage by pouring around 1000cc of water into the drain pan through the inspection hole by removing the maintenance cover (10 screws) or through the outlet duct joint of supply air to room (SA). (Refer to Fig. 8)

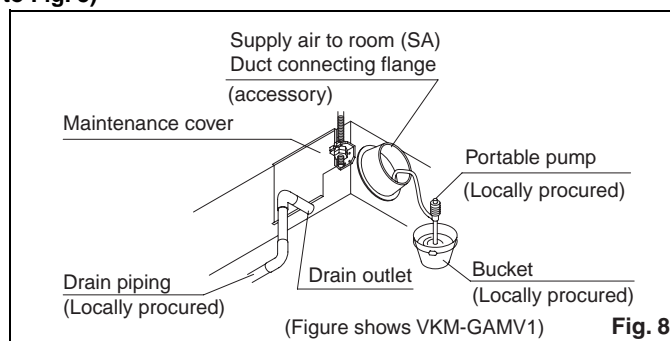

## 9 Installation

### 9 - 5 Drain Piping and Water Supply Work

**(3) Make sure that heat insulation work is executed on the following 2 spots to prevent any possibility water leakage due to dew condensation.**

- Indoor drain piping
- Drain outlet

**(4) Install the water supply piping. (VKM-GAMV1 series only)**

**CAUTION**

When installing the water supply piping, wash the pipes with tap water so that all dirt is removed from them or install a drain valve somewhere along the piping and drain the pipes thoroughly until the water flowing through them is clear. Make sure no cutting oils or detergents get into the pipes.

- Connect the water supply piping with strainer (accessory), other pipings and valves (locally procured) to the indoor unit as shown in the figure at below.

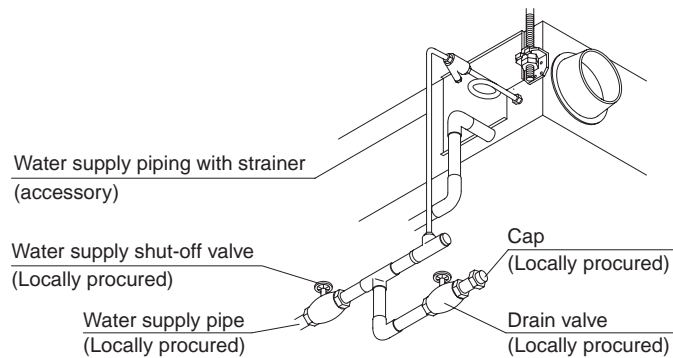

**[PRECAUTION]**

- When installing the water supply piping, do not pass piping in front of the maintenance cover, as this will make it impossible to remove the humidifier element.
- Include the water supply piping with strainer (included), a water supply shut-off valve, and a drain valve (both locally procured) somewhere along the water supply piping that can be reached from the inspection hole.
- It is impossible to connect the water supply piping directly to public piping. Use a cistern tank (of the approved type) if you need to get your water supply from public piping.
- When using copper piping for the water supply connections, replace the included half-union joints. (Refer to Fig. 9)

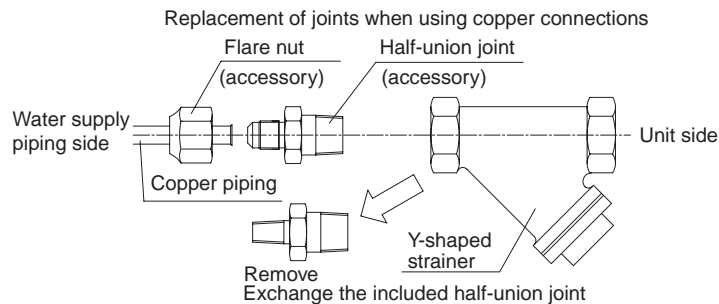

**Fig. 9**

- Use two spanners when attaching or removing pipes to the half-union joints.
- Secure the water supply piping without applying pressure.

**[PRECAUTIONS]**

- Use pure water (city water, tap water or equivalent) that satisfies the standard regulated by the law of each country for water supply to the humidifier when performing anti-sweat work.
- Dirty water may cause valves to clog, dirt to accumulate in water tanks, and resulting in poor humidifier performance. (Never use water from a cooling tower or warm water for heating.)
- Make sure the supply water is between 5°C and 40°C in temperature and 0.02MPa to 0.49MPa (0.2kg/cm<sup>2</sup> to 5kg/cm<sup>2</sup>) in pressure. Include a pressure release valve between the humidifier and the strainer if the water pressure will be higher than this range.
- Use city water or clean water and take steps to prevent condensation from forming.
- Also, if the supply water is hard water, use a water softener because of short life.

\* Life of humidifying element is about 3 years (4,000 hours), under the supply water conditions of hardness: 150mg/l. (Life of humidifying element is about 1 year (1,500 hours), under the supply water conditions of hardness: 400mg/l.)  
 Annual operating hours: 10 hours / day × 26 days / month × 5 month = 1,300 hours

## 9 Installation

### 9 - 5 Drain Piping and Water Supply Work

**(5) Insulate all piping that passes indoors.**

After checking that the water supply piping connections do no leak, insulate them using the included insulation as shown in Fig. 10. (Tighten both edges with clamping material.) **(Refer to Fig. 10)**

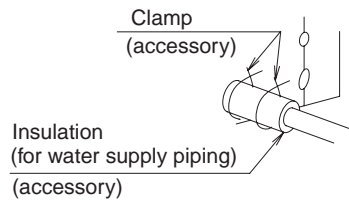

**Fig. 10**

- Wrap the water supply piping with insulation to prevent condensation from forming.
- In areas where freezing may occur, always take steps to prevent the pipes from freezing.

## 9 Installation

### 9 - 6 Refrigerant Piping Work

⟨For refrigerant piping of outdoor units, see the installation manual attached to the outdoor unit.⟩

⟨Execute heat insulation work completely on both sides of the gas piping and the liquid piping.⟩

Otherwise, a water leakage can result sometimes.

Use insulation that can withstand temperatures of at least 120°C. Improve insulation of refrigerant piping according to the installation environment.

Refer to the following information as a guide.

- The ambient temperature is 30°C and humidity is 75% to 80%: 15 mm min. in thickness.
- The ambient temperature exceeds 30°C and the humidity exceeds 80%: 20 mm min. in thickness. Without reinforcement, condensation may form on the surface of the insulation.⟩

⟨Before refrigerant piping work, check the type of R-410A refrigerant is used. (Proper operation is not possible if the types of refrigerant are not the same.⟩

#### ⚠ CAUTION

This product must use a new refrigerant (R-410A). Obey the following items.

- Use a pipe cutter and flare suitable for the type of refrigerant (R-410A).
  - Apply ester oil or ether oil around the flare portions before connecting.
  - Only use the flare nuts included with the unit. Using different flare nuts may cause the refrigerant to leak.
  - To prevent dust, moisture or other foreign matter from infiltrating the tube, either pinch the end or cover it with tape.
  - Do not allow anything other than the designated refrigerant to get mixed into the refrigerant circuit, such as air, etc. If any refrigerant gas leaks while working on the unit, ventilate the room thoroughly right away.
- 
- The outdoor unit is charged with refrigerant.
  - Be sure to use both a spanner and torque wrench together, as shown in the drawing, when connecting or disconnecting pipes to the unit. (Refer to Fig. 11)
  - Refer to the "Table 1" for the dimensions of flare nut spaces.

Table 1

Pipe gauge	Tightening torque	Flare dimension A (mm)	Flare shape
φ 6.4	14.2–17.2N·m	8.7 – 9.1	
φ12.7	49.5–60.3N·m	16.2 – 16.6	

- When connecting the flare nut, coat the flare section (both inside and outside) with ester oil or ether oil, rotate three or four times first, then screw in. (Refer to Fig. 12)

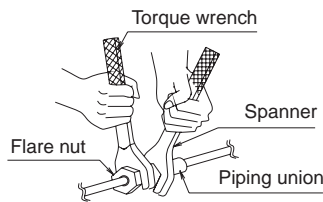

Fig. 11

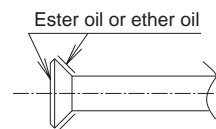

Fig. 12

- Refer to the "Table 1" for tightening torque.

#### ⚠ CAUTION

Over-tightening may damage the flare and cause a refrigerant leakage.

- If a torque wrench is not available, tighten the nut in the following manner. Once work is complete, make sure there is no gas leaking. As the flare nut is tightened with the wrench, the torque will suddenly increase. From that position, tighten the nut to the angle shown on "Table 2".

Table 2

Pipe size	Further tightening angle	Recommended arm length of tool
φ 6.4 (1/4")	60 to 90 degrees	Approx. 150mm
φ 12.7 (1/2")	30 to 60 degrees	Approx. 250mm

- After the work is finished, make sure to check that there is no gas leak.

## 9 Installation

### 9 - 6 Refrigerant Piping Work

- After checking the pipe-connection for gas leakage, be sure to insulate the liquid and gas piping. (Refer to Fig. 13)

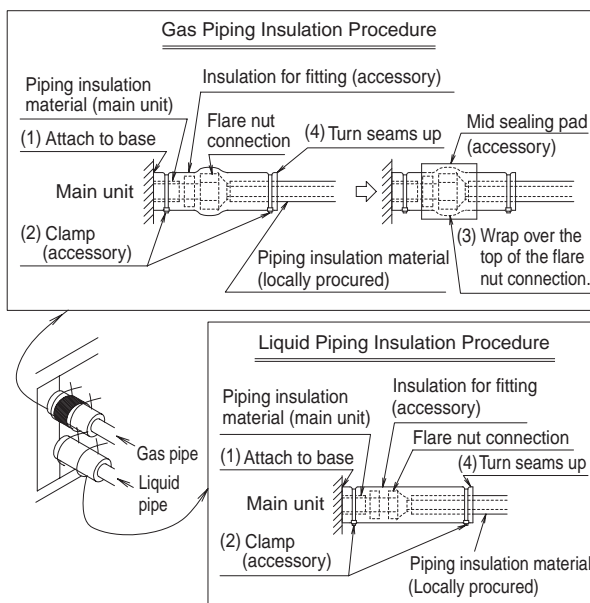
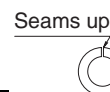

Fig. 13

#### Precautions for insulation material installation on flare nut connection

- (1) Make sure that the piping insulation material comes in close contact with the base so that there will be no air passage at the edges of the piping insulation material.
- (2) Do not tighten the clamp excessively so as to maintain the appropriate thickness of the insulator.
- (3) Wrap the sealing material around the upper part of the flare nut connection.
- (4) Turn the seams up (see the figure on the right-hand side).



#### CAUTION

Be sure to insulate any field piping all the way to the piping connection inside the unit. Any exposed piping may cause condensation or burns if touched.

- Connect refrigerant piping and branching according to the attached installation manuals that come with the outdoor unit.

Model	Gas piping diameter	Liquid piping diameter
VKM50GAMV1, VKM50GAV1 VKM80GAMV1, VKM80GAV1 VKM100GAMV1, VKM100GAV1	φ 12.7	φ 6.4

- When brazing the refrigerant piping, perform nitrogen replacement first, or perform the brazing (note 2) while feeding nitrogen into the refrigerant piping (note 1), and finally connect the indoor unit using the flare connections. (Refer to Fig. 14)

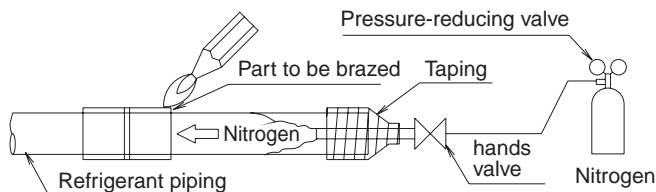

Fig. 14

#### CAUTION

- When brazing a pipe while feeding nitrogen inside the pipe, make sure to set the nitrogen pressure to 0.02MPa (0.2kg/cm<sup>2</sup>) or less using the pressure reducing valve. (This pressure is such that breeze is blown to your cheek.)
- Do not use a flux when brazing the refrigerant pipe joints. Use phosphor copper brazer (BCuP-2: JIS Z 3264/B-Cu93P-710/795: ISO 3677) which does not require flux. (Using a flux containing chlorine may cause the piping to corrode. Using a welding flux containing fluorine may cause the refrigerant lubricant to deteriorate, and affect adversely the refrigerant piping system.)
- Do not use anti-oxidants or other similar agent when brazing the pipe joints. Residue can clog the pipes and may cause breakdown of parts.

## 9 Installation

### 9 - 7 Duct Connection

**(Perform duct work keeping the following things in mind)**

- Do not connect the ducts as shown in Fig. 15.

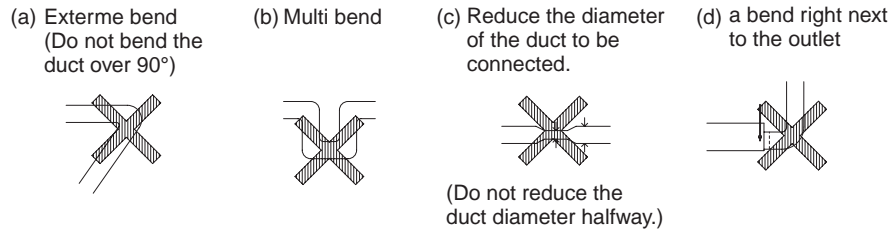

Fig. 15

- The minimal radius of bends for flexible ducts are as follows.  
200-mm duct : 300mm diameter  
250-mm duct : 375mm diameter
- To prevent air leakage, wind aluminum tape round the section after the duct connecting flange and the duct are connected. **(Refer to Fig. 16)**
- To prevent short circuit, install the opening of the indoor air intake as far as from the opening of the exhaust suction.
- Use the duct applicable to the model of unit used. (Refer to the installation drawing.)
- Install the two outdoor ducts with down slope (slope of 1/30 or more) to prevent entry of rain water. Also, provide insulation for three ducts (Outdoor ducts and Indoor supply air duct) to prevent dew condensation. (Material : Glass wool of 25mm thick) **(Refer to Fig. 16)**
- If the level of temperature and humidity inside the ceiling is always high, install a ventilation equipment inside the ceiling.
- Insulate the duct and the wall electrically when a metal duct is to be penetrated through the metal lattice and wire lattice or metal lining of a wooden structure wall.
- Using flexible or silent ducts can be effective in reducing the air discharge sound of the supply air to room (SA). Select materials keeping in mind the fan strength and operating sound of the unit. Consult your Daikin dealer for selection.
- Set the pitch between the exhaust air outlet (EA) and the outside air intake (OA) to 3 times the duct diameter.
- Do not use a bent cap or a round hood as the outdoor hood if they might get rained on directly. (We recommend using a deep hood (optional accessory).)
- When using a deep hood, make sure the duct from the deep hood (outer wall) to the unit is at least 1m long.

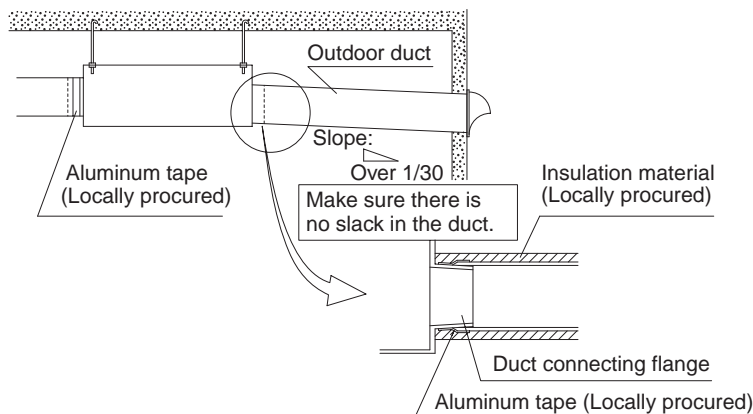

Fig. 16

- The change of air discharge grill's location should be examined when the cold draft from air discharge grill is feared.  
The fan is driving while defrost operation, and the cold air is often blowing.
- When connecting the indoor unit directly to the duct, always use the same system on the indoor unit as with the outdoor unit, perform group-linked operation, and make the direct duct connection settings from the remote controller (Mode No. "17 (27)" – FIRST CODE NO. "5" – SECOND CODE NO. "06") Also, do not connect to the outlet side of the indoor unit. Depending on the fan strength and static pressure, the unit might back up.
- In the case of suburban buildings where windows and road lighting equipment are close to the air supply opening and insects tends to swarm around the light, minute insects may intrude indoors through the air supply opening and air filter. In such cases, the use of a high-performance filter (sold separately) is recommended. However, it may be still difficult to prevent the intrusion of very minute insects. In that case, consider ultimate countermeasures, such as a filter box (arranged on site).

## 9 Installation

### 9 - 8 Electric Wiring Work

- Shut off the power before doing any work.
- All field supplied parts and materials, electric works must conform to local codes.
- Use copper wire only.
- All wiring must be performed by an authorized electrician.
- See also the “Electrical Wiring Diagram label” attached to the electric parts box lid when laying electrical wiring.
- Wire the outdoor unit and remote controller as shown in the electric wiring diagram label. See the “Remote Controller Installation Manual” for details on how to install and lay the wiring for the remote controller.
- This system consists of multiple indoor units. Mark each indoor unit as unit A, unit B..., and be sure the terminal board wiring to the outdoor unit and BS unit are properly matched. If wiring and piping between the outdoor unit and an indoor unit are mismatched, the system may cause a malfunction.
- Install a wiring interrupter or ground-fault circuit interrupter for the power wiring.
- Make sure the ground resistance is no greater than 100Ω . This value can be as high as 500Ω when using a ground fault circuit interrupter since the protective ground resistance can be applied.
- Do not let the ground wire should come in contact with gas pipes, water pipes, lighting rods, or telephone ground wires.
  - Gas pipes: gas leaks can cause explosions and fire.
  - Water pipes: cannot be grounded if hard vinyl pipes are used.
  - Telephone ground and lightning rods: the ground potential when struck by lightning gets extremely high.
- Do not turn on the power supply (switch, wiring interrupter or ground fault circuit interrupter) until all other works are done.

#### SPECIFICATIONS FOR FIELD SUPPLIED FUSES AND WIRE

Model	Power supply wiring			Remote controller wiring Transmission wiring	
	Field fuses 	Wire	Size	Wire	Size
VKM50GAMV1, VKM50GAV1	15A	H05VV-U3G	Follow local standards	Sheathed wire (2 wire)	0.75-1.25 mm <sup>2</sup>
VKM80GAMV1, VKM80GAV1					
VKM100GAMV1, VKM100GAV1					

#### Note

- If the wiring is in a place where people it can be easily touched by people, install a leak interrupter to prevent electric shock.
- When using a ground-fault circuit interrupter, make sure to select one useful also to protection against overcurrent and short-circuit.  
If you use a leak interrupter which is designed for protecting again ground faults, be sure to combine it with a wiring interrupter or an load switch that has a fuse.
- The length of the transmission wiring and remote controller wiring are as follows.

Length of outdoor-indoor transmission wiring ... max 1000m (total wiring length 2000m)
Length of remote controller wiring between indoor unit and remote controller ... max 500m

#### ELECTRICAL CHARACTERISTICS

Model	Units			Power supply		Fan motor	
	Hz	Volts	Voltage range	MCA	MFA	kW	FLA
VKM50GAMV1, VKM50GAV1	50	220-240V	Max. 264V Min. 198V	4.3	15	0.28x2	1.9x2
VKM80GAMV1, VKM80GAV1				4.3	15	0.28x2	1.9x2
VKM100GAMV1, VKM100GAV1				4.3	15	0.28x2	1.9x2

MCA: Min. Circuit Amps (A); MFA: Max. Fuse Amps (A)  
 kW: Fan Motor Rated Output (kW); FLA: Full Load Amps (A)

## 9 Installation

### 9 - 9 Wiring Example and how to set the Remote Controller

#### 9 - 9 - 1 Opening and Shutting the Electric Parts Box and Connecting the Wiring

**CAUTION**  
Be sure to power off before opening the electric parts box.

- Remove the electric parts box lid and wire as shown in the figure below.

SS1 is the switch for setting the remote controller.  
The unit will not run if the settings are changed.

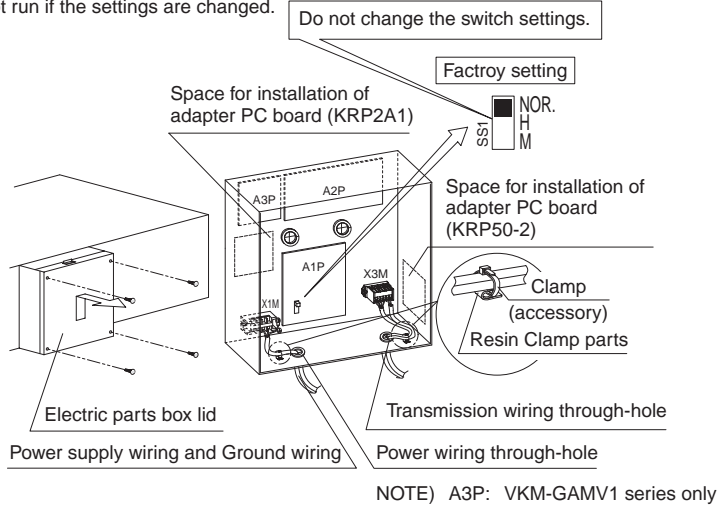

- CAUTION**
- See "Electrical Wiring Diagram label" on the backside of the lid of the electric parts box for electric wiring work.
  - Be sure to attach the sealing material or putty (locally procured) to hole of wiring to prevent the infiltration of water as well as any insects and other small creatures from outside. Otherwise a short-circuit may occur inside the electric parts box.
  - When clamping the wires, be sure no pressure is applied to the wire connections by using the included clamping material to make appropriate clamps. Also, when wiring, make sure the lid on the electric parts box fits snugly by arranging the wires neatly and attaching the electric parts box lid firmly. When attaching the electric parts box lid, make sure no wires get caught in the edges. Pass wiring through the wiring through holes to prevent damage to them.
  - Make sure the remote controller wiring, the wiring between the units, and other electrical wiring do not pass through the same locations outside of the unit, separating them by at least 50mm, otherwise electrical noise (external static) could cause mistaken operation or breakage.



## 9 Installation

### 9 - 9 Wiring example and how to set the Remote Controller

#### 9 - 9 - 2 Connecting Power Supply Wiring and Ground Wiring

- Pass the power supply wiring and the ground wiring through the wiring through-hole into the electrical parts box and secure with the included clamping material after connecting the wires to terminal blocks. (Refer to Fig. 17-1, 17-2)

**[VKM-GAMV1 series]**

Terminal block (X1M) details

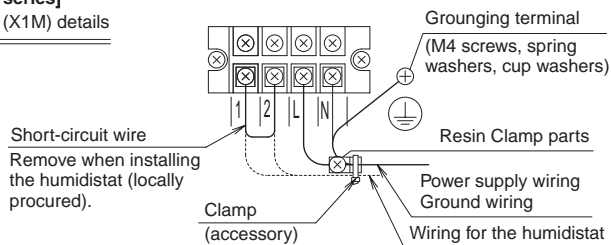

Fig. 17-1

**[VKM-GAV1 series]**

Terminal block (X1M) details

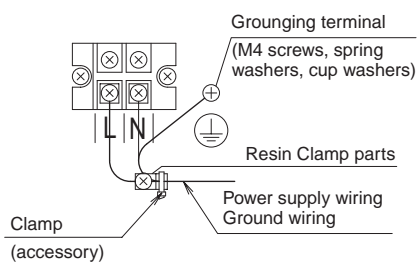

Fig. 17-2

**<Precautions when laying power supply wiring>**

**[PRECAUTIONS]**

- [1] A circuit breaker capable of shutting down power supply to the entire system must be installed.
- [2] A single switch can be used to supply power to units on the same system.  
However branch switches, branch overload circuit interrupter must be selected carefully.
- [3] Fit the power supply wiring of each unit with a switch and fuse as shown in the drawing.

**COMPLETE SYSTEM EXAMPLE**

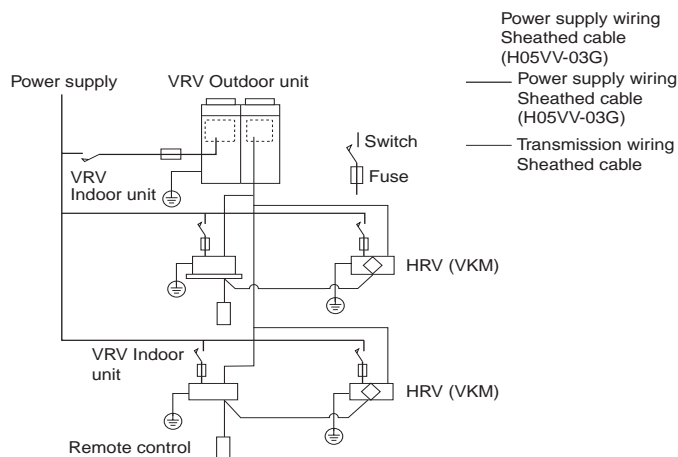

## 9 Installation

### 9 - 9 Wiring example and how to set the Remote Controller

#### 9 - 9 - 2 Connecting Power Supply Wiring and Ground Wiring

[4] Use round crimp-style terminals for connecting wires to the power supply terminal block. If unavailable, observe the following points when wiring.

- Do not connect wires of different gauge to the same power supply terminal. (Looseness in the connection may cause overheating.)
- Use the specified electric wire. Connect the wire securely to the terminal. Lock the wire down without applying excessive force to the terminal. (Tightening torque: 131N·cm ±10%)

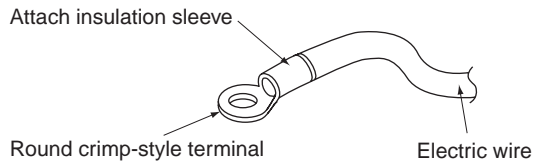

[5] Tightening torque for the terminal screws.

- Use the correct screwdriver for tightening the terminal screws. If the blade of screwdriver is too small, the head of the screw might be damaged, and the screw will not be properly tightened.
- If the terminal screws are tightened too hard, screws might be damaged.
- Refer to the table below for the tightening torque of the terminal screws.

	Tightening torque (N·m)
Terminal block for remote controller/Transmission wiring (X3M)	0.79 – 0.97
Power supply terminal block (X1M)	1.18 – 1.44
Ground terminal (M4)	1.44 – 1.94

#### ⚠Precautions when connecting the ground

When pulling the ground wire out, wire it so that it comes through the cut out section of the cup washer. (An improper ground connection may prevent a good ground from being achieved.)

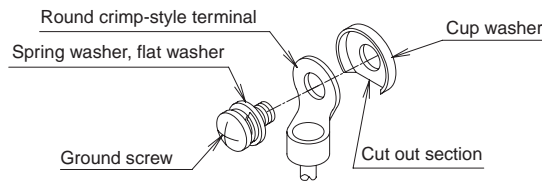

## 9 Installation

### 9 - 9 Wiring example and how to set the Remote Controller

#### 9 - 9 - 3 Remote Power Supply Wiring, Transmission Wiring, Computerised Control Wire

- Pass the remote control wiring, the transmission wiring, and the computerised control wire into the electric parts box through the through-hole and connect to the terminals on the X3M terminal block. After connection, secure with the included cramping material. (Refer to Fig. 18)

Detail of terminal block (X3M)

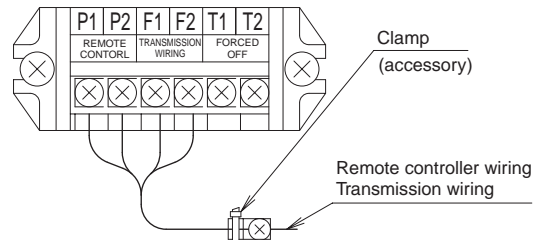

Fig. 18

#### [PRECAUTIONS]

- Refer to the “Remote Controller Installation Manual” on how to install and lay the wiring for the remote controller.
- Do not, under any circumstances, connect the power wiring to the remote controller or transmission wiring terminal block. Doing so can destroy the entire system.
- Connect the remote controller and transmission wiring their respective terminal blocks.

#### 9 - 9 - 4 Wiring for the Humidity Regulator (Locally Procured)

<VKM-GAMV1 series only>

- Pass into the electric parts box together with the power wire through the power wiring through-hole.
- Remove the short-circuit wires (1 and 2) on the X1M terminal block and connect the wiring for the humidity regulator.
- Secure with cramping material together with the power wire. (Refer to Fig. 17-1)

Wiring specifications	Sheathed wire (2 wire)
Size	0.75 - 1.25mm <sup>2</sup>
Length	MAX. 100m
External contact specifications	Normally closed contact (Current tolerance 10mA – 0.5A)

#### ⚠ CAUTION

<VKM-GAMV1 series only>

- If using humidistat, install one per HRV unit. Controlling more than one HRV unit with a single humidity controller may prevent normal humidity operation and cause water leakage, etc.

#### 9 - 9 - 5 Wiring Example

- This unit can be used as part of the combined operation system used together with indoor units (VRVIII system air conditioners), or as an independent system for processing outside air.
- When connecting with a cooling free building multi type and bringing the RA (exhaust gas intake) of this unit directly in from the ceiling, connect to a BS unit identical to the building multi indoor unit (master unit), and use group-linked operation. (See the Engineering Data for details.)

## 9 Installation

### 9 - 9 Wiring example and how to set the Remote Controller

#### 9 - 9 - 5 Wiring example

**(Combined operation system with VRVIII system (connected with HRV units and standard indoor units in a single refrigerant circuit))**

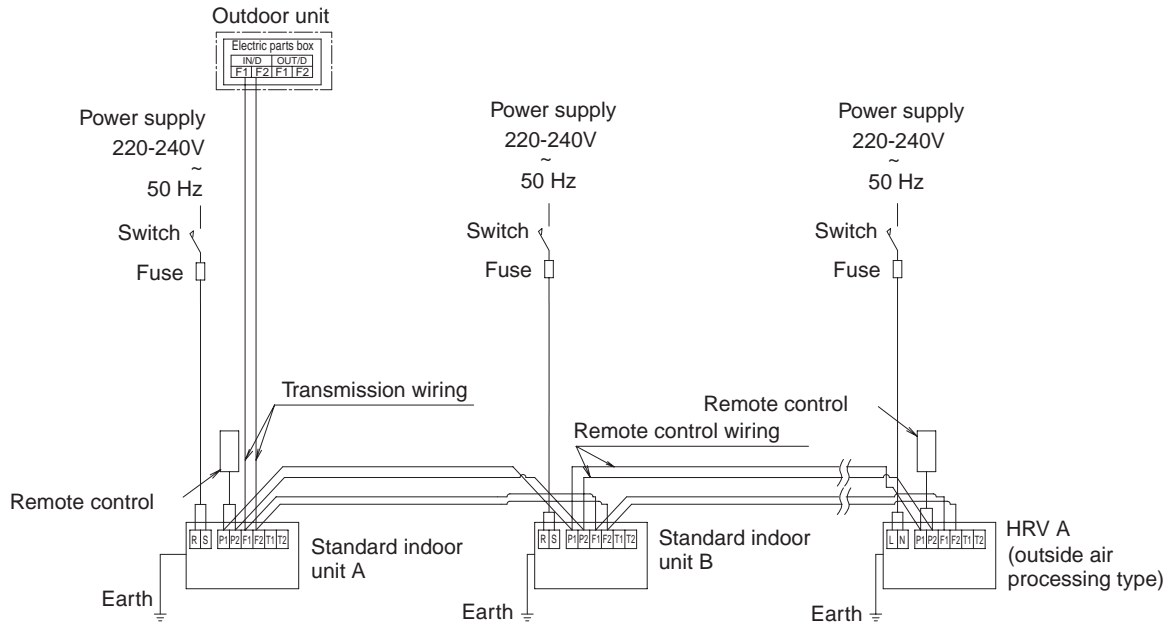

**(Independent system (connected only with a HRV unit in a single refrigerant circuit))**

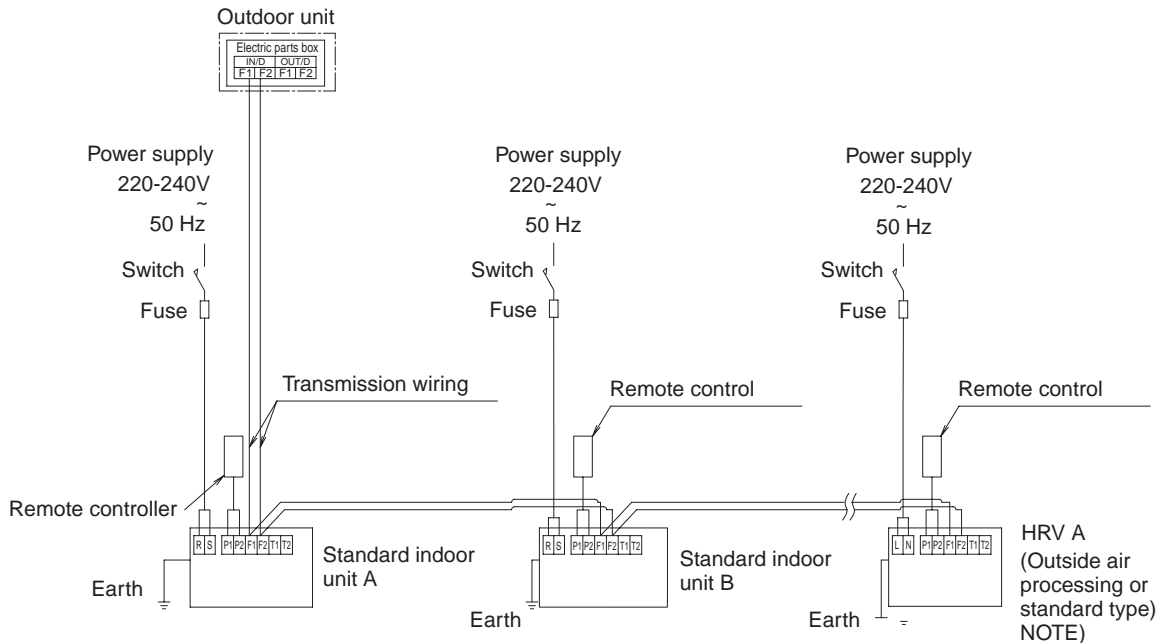

NOTE) Standard type ..... VAM series

## 9 Installation

### 9 - 9 Wiring example and how to set the Remote Controller

#### 9 - 9 - 5 Wiring example

(When including a BS unit)

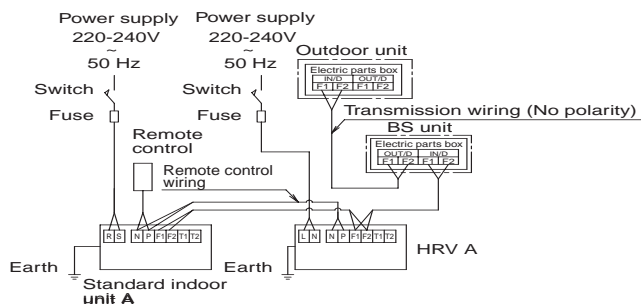

#### [PRECAUTIONS]

There is not need to set the indoor unit address when using group control. (It is automatically set when the power is turned on.) However, since the HRV (outside air processing type) uses two remote control addresses per unit, the number of units which can be group controlled is as follows.

No. of indoor air conditioner units	0	1	2	3	4	5	6	7	8	9	10	11	12	13	14
No. of HRV units	8	7	7	6	6	5	5	4	4	3	3	2	2	1	1

#### Note

If a simultaneous cooling system is used, a single BS unit should connect to HRV (outdoor air-processing type) and indoor units under group control. If a single BS unit connects to the HRV unit only, fix the operating mode of the HRV unit to cooling, heating, or ventilation.

#### 9 - 9 - 6 Control by 2 Remote Controllers (Controlling 1 Indoor Unit by 2 Remote Controllers)

- When using 2 remote controllers, one must be set to "MAIN" and the other to "SUB".

##### MAIN / SUB CHANGEOVER

1. Insert a screw driver into the recess between the upper and lower part of remote controller and, working from the 2 positions, pry off the upper part.

(The remote controller PC board is attached to the upper part of remote controller.)

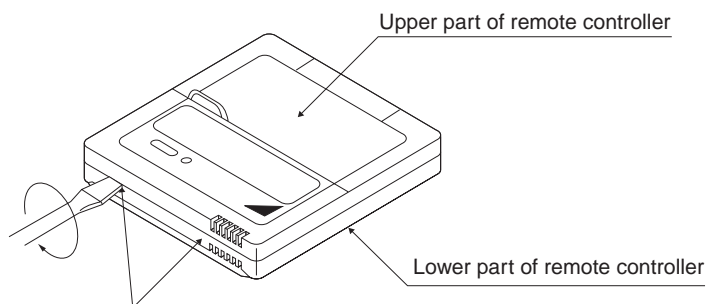

Insert the screwdriver here and gently work off the upper part of remote controller.

## 9 Installation

### 9 - 9 Wiring example and how to set the Remote Controller

#### 9 - 9 - 6 Control by 2 Remote Controllers (Controlling 1 indoor Unit by 2 Remote Controllers)

2. Turn the MAIN/SUB changeover switch on one of the two remote controller PC boards to "S".  
(Leave the switch of the other remote controller set to "M".)

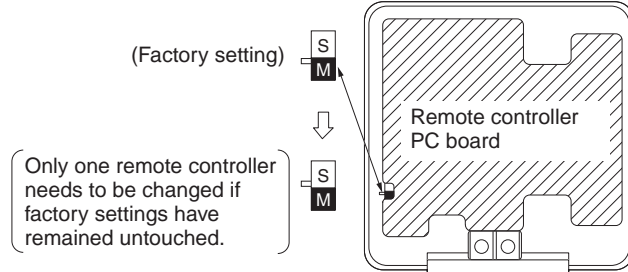

〈Wiring Method〉 (See "9 - 8 Electric Wiring Work".)

1. Remove the electric parts box lid.
2. Add remote controller 2 (slave) to the terminal block for remote controller (P<sub>1</sub>, P<sub>2</sub>) in the electric parts box. (There is no polarity.)

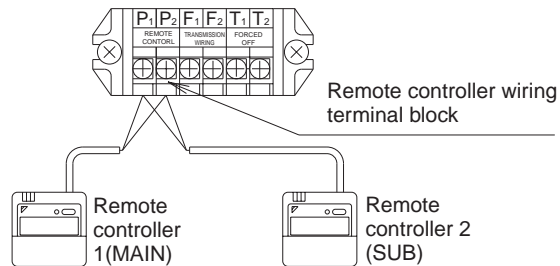

#### [PRECAUTIONS]

- Crossover wiring is needed when using group control and 2 remote controllers at the same time.
- Connect the indoor unit at the end of the crossover wire (P<sub>1</sub>, P<sub>2</sub>) to remote controller 2 (slave).

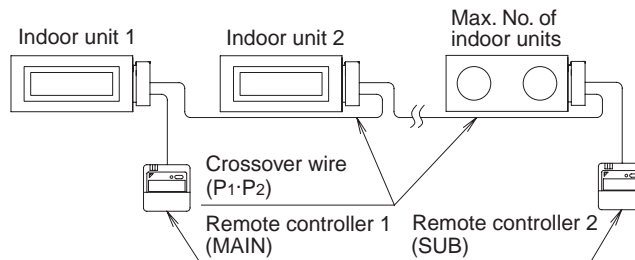

## 9 Installation

### 9 - 9 Wiring example and how to set the Remote Controller

#### 9 - 9 - 7 Computerised Control (Forced OFF and ON/OFF Operation)

- Wire specifications and how to perform wiring  
Connect the input from outside to terminals T1 and T2 of the terminal block for remote controller.

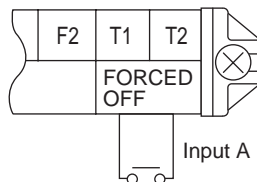

\* The equipment in Nighttime free cooling operation cannot be stopped forcibly with T1 or T2.

Wire specification	Sheathed wire (2 wire)
Gauge	0.75 - 1.25mm <sup>2</sup>
Length	Max. 100m
External terminal	Contact that can ensure the minimum applicable load of 15V DC, 1mA.

- Actuation  
The following table explains FORCED OFF and ON/OFF OPERATIONS in response to Input A.

FORCED OFF	ON/OFF OPERATION
Input "ON" stops operation (impossible by remote controllers.)	Input OFF → ON turns ON unit.
Input OFF enables control by remote controller.	Input ON → OFF turns OFF unit.

- How to select FORCED OFF and ON/OFF OPERATION  
Enter the FORCED OFF and ON/OFF OPERATION selection using the local "external start/stop input" settings based on "9 - 10 Field Setting and Test Run".

#### 9 - 9 - 8 Central Control

If control is performed with a central device (central management controller, etc.), group number needs to be set with the remote controller. See the manual of each central device for detail.

#### 9 - 9 - 9 Fresh-up Operation by External Input (HRV Unit)

##### PURPOSES AND FUNCTIONS

When the operation is interlocked with the local ventilating fan(such as the one for toilet or kitchen), the HRV unit performs the over-supply operation to prevent inflow of the odor from outside. The flow rate of supply air becomes higher than that of exhaust air.

Both the excessive supply mode (Supply Fresh-up) and the excessive exhaust mode (Exhaust Fresh-up) are selectable.

In details, contact your dealer.

##### EXAMPLE OF CONTROL WIRING

Connecting line can be extended up to 50m maximum.

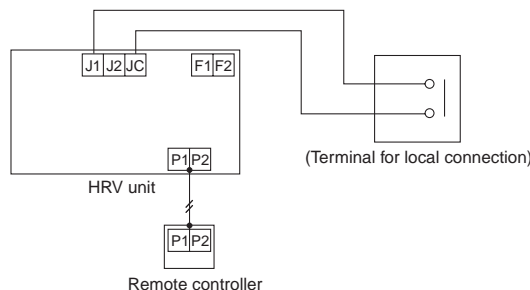

- Local wiring

Operation of HRV unit	Terminal for local connection	Capacity of connecting terminal
Fresh-up	Short-circuit	No-voltage normally open contact for micro-current 12V, 1mA
Normal	Open circuit	

##### Note

The connecting wiring between HRV unit and the terminal for local connection can be extended up to 50m maximum.

## 9 Installation

### 9 - 10 Field Setting and Test Run

#### 9 - 10 - 1 Perform Field Settings with the Remote Controller

- (1) Make sure the electric parts box lids are closed on the indoor and outdoor units.
- (2) Depending on the type of installation, make the field settings from the remote controller after the power is turned on, following the "Field Settings" manual which came with the remote controller.

Lastly, make sure the customer keeps the "Field Settings" manual, along with the operating manual, in a safe place.

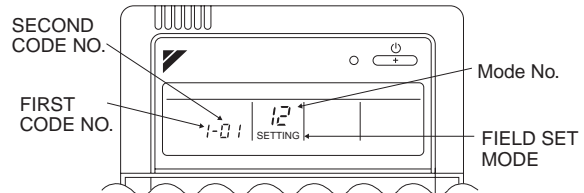

#### ■ Field setting

Using the remote controller of the VRV-system air conditioner to make HRV unit settings

##### 〈Initial setting〉

- "Mode No." 17, 18 and 19: Group control of HRV units.
- "Mode No." 27, 28 and 29: individual control

##### 〈Operating procedure〉

The following describes the operating procedure and settings.

- (1) Press the INSPECTION/TRIAL button for more than four seconds with the unit in the normal mode to enter the local setting mode.
- (2) Use the TEMPERATURE ADJUSTMENT button to select the desired "Mode No."  
(The code display will blink.)
- (3) To make settings for individual units under group control (when mode No. 27, 28 or 29 is selected), press the TIMER SETTING ON/OFF button to select the "unit No." for which the settings are to be made. (This process is not necessary when settings are made for the entire group.)
- (4) Press the top section of the TIMER button to select the "FIRST CODE NO."
- (5) Press the lower section of the TIMER button to select "SECOND CODE NO."
- (6) Press the PROGRAM/CANCEL button once to enter the settings.  
(The code display will stop blinking and light up.)



## 9 Installation

### 9 - 10 Field Setting and Test Run

#### 9 - 10 - 1 Perform Field Settings with the remote Controller

(7) Press the INSPECTION/TRIAL button to return to normal mode.

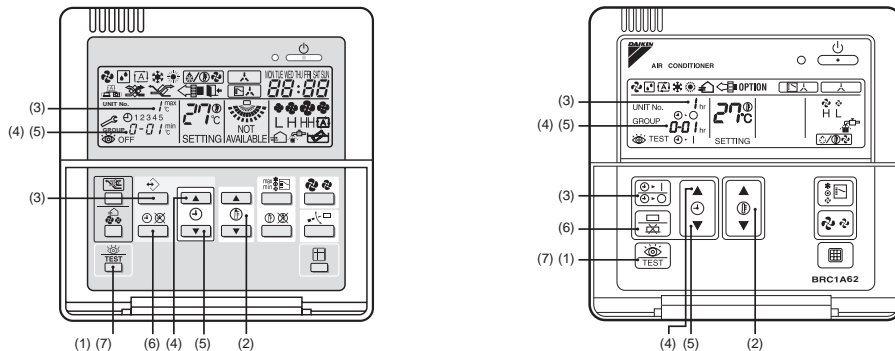

〈Example〉

When adjusting the ventilation air flow to low setting in the group setting mode, enter the Mode No., "19" FIRST CODE NO., "0" and SECOND CODE NO., "01".

#### ■ Settings and setting numbers

Description of setting	Mode No. *1	FIRST CODE NO.	SECOND CODE NO.						
			01	02	03	04	05	06	07
Filter cleaning time setting NOTE) 5	17 (27)	0	Approx. 2500 hours	Approx. 1250 hours	No counting	-	-	-	-
Nighttime free cooling operation setting (Time after air conditioning is stopped.) NOTE) 5		1	OFF	2 hours later	4 hours later	6 hours later	8 hours later	-	-
Fan speed initial setting		4	Normal	Ultra high	-	-	-	-	-
Direct duct connection with VRV setting		5	Not direct duct (Air flow setting)	With direct duct (fan off)	-	Not direct duct (Air flow setting)	-	With direct duct (fan off)	-
Setting for cold areas (Fan operation selection for heater thermo OFF) NOTE) 6		5	Air flow setting	Air flow setting	-	Fan L	-	Fan L	-
Ventilation air flow setting when Nighttime free cooling setting	17 (27)	6	High	Ultra-High	-	-	-	-	-
ON/OFF input from Outside (Set when ON/OFF is to be controlled from outside)	12 (22)	1	Forced off	ON/OFF control	-	-	-	-	-
Power failure automatic reset (Auto Restart)	12 (22)	5	No equipped	Equipped	-	-	-	-	-
Humidification on/off when heating thermo is off	15 (25)	1	No	Yes	-	-	-	-	-
Indication of ventilation mode/ Not indication	18 (28)	4	Indication	No Indication	-	-	-	-	-
Fresh up air supply/exhaust setting		7	No Indication		Indication		-	-	-
			Supply	Exhaust	Supply	Exhaust	-	-	-
External input terminal function selection (between J1 and JC) NOTE) 7		8	Fresh-up	Overall alarm	-	-	-	Air flow increase	-
KRP50-2 output switching selection (between 1 and 3)	9	Fan on/off	Abnormal	-	-	-	-	-	
Ventilation air flow setting	19 (29)	0	Low	Low	Low	Low	High	High	
Ventilation mode setting	2	Automatic	Exchange	Bypass	-	-	-	-	
Fresh-up operation	1A	Off	On	-	-	-	-	-	
Forced fan on	43	-	-	-	-	-	-	-	
Unit no. allocation	45	-	-	-	-	-	-	-	

#### NOTE

- The  inside the frame indicates the second code no. set when shipped from factory.
- The settings are applied to the entire group, but if the mode no. inside the parentheses is selected, the settings can be applied to individual indoor units. However, it is only possible to check any changes made to the settings inside the parentheses in individual mode. (For group batch operation, the changes are made but the display remains as it was when shipped from the factory.)
- Do not set anything not shown above. If the applicable functions are not available, they will not be displayed.
- When returning to normal mode, the remote controller is initialized, so the display might show "88."
- When "Filter cleaning time setting" or "Nighttime free cooling operation setting" is changed, explain set contents to the customer.

## 9 Installation

### 9 - 10 Field Setting and Test Run

#### 9 - 10 - 1 Perform Field Settings with the remote Controller

- See below for details on the settings for cold areas.  
 – : operate at the set fan strength

	Air conditioner fan	01	02	04	06
Heating thermo off	Operation	–	–	L	L
Defrost	Stop	–	Stop	Stop	Stop
Oil return	Stop	–	Stop	Stop	Stop

In case of Independent operation

	Air conditioner fan	01	02	04	06
Heating thermo off	Operation	–	–	L	L
Defrost	Stop	–	–	Stop	Stop
Oil return	Stop	–	–	Stop	Stop

– : operate at the set fan strength

L : operate at the weak fan strength

S : Stop

#### Defrost operation

- In heating operation, freezing of the outdoor unit's coil increases. Heating capability decreases and the system goes into defrost operation.
- The remote controller will read "❄️" until the hot air starts blowing.
- It returns to the heating operation again after 6 to 8 minutes (10 at the longest).
- During defrost operation, the fans of the unit continues driving (factory setting). The purpose of this is to maintain the amount of ventilation and humidifying.
- The change of air discharge grill's location should be examined when the cold draft from air discharge grill is feared.
- Though the fan can be stopped by the setting of remote controller. Do not stop the fan in the place where no ventilation by stopping the fan may cause the influence of diffusion of air which it is dirty and moisture into another room, or the inflow from outside the room. (outflow such as viruses from the sickroom, or smell leakage from the rest room, etc.)

- See below for details on the external input terminal function.

SECOND CODE NO.	Input contact	Fan operation	Operation lamp	
01	a	Operation	On	Fresh-up operation
02	a	Operation	On	Malfunction code "60" is displayed
06	a	Operation	On	Fan strength up (Low to High, High to Ultra-High)

\*SECOND CODE NO. "04" does not function when in air conditioner linked mode.

## 9 Installation

### 9 - 10 Field Setting and Test Run

#### 9 - 10 - 2 Perform a Test Run according to the Outdoor Unit's Installation Manual.

- (1) Make sure the electric parts box of the unit is closed before turning on power.
- (2) Make a test run following the operation manual of the outdoor unit.
  - The operation lamp of the remote controller will flash when an malfunction occurs. Check the malfunction code on the liquid crystal display to identify the point of trouble. An explanation of malfunction codes and the corresponding trouble is provided in "CAUTION FOR SERVICING" of the outdoor unit.

If the display shows any of the following, there is a possibility that the wiring was done incorrectly or that the power is not on, so check again.

Remote controller display	Content
"E4" is display	<ul style="list-style-type: none"> <li>• There is a short circuit at the FORCED OFF terminals (T1, T2)</li> </ul>
"E3" is display	<ul style="list-style-type: none"> <li>• The test-run has not be performed.</li> </ul>
"E4" is display "E4" is display	<ul style="list-style-type: none"> <li>• The power on the outdoor unit is off.</li> <li>• The outdoor unit has not been wired for power supply.</li> <li>• Incorrect wiring for the transmission wiring and the wiring (the remote controller wiring or FORCED OFF wiring.)</li> <li>• The transmission wiring is cut.</li> </ul>
"E8" is display	<ul style="list-style-type: none"> <li>• "MAIN/SUB" setting of the remote controller is wrong.</li> </ul>
No display	<ul style="list-style-type: none"> <li>• The power on the indoor unit and HRV is off.</li> <li>• The indoor unit and HRV has not been wired for power supply.</li> <li>• Incorrect wiring for the remote controller wiring and the wiring (the transmission wiring or the FORCED OFF wiring.)</li> <li>• The remote controller wiring is cut.</li> </ul>

#### 9 - 10 - 3 Next, run the Humidifier.

〈VKM-GAMV1 series only〉

- (1) Check that the water supply piping is connected securely.
- (2) Open the water supply shut-off valve. (No water will be supplied at this time.)
- (3) Run the HRV unit in heating mode.
 

(See the operating manual included with the indoor unit for details on how to run the unit in heating mode.)

The water supply will start and the humidifier will begin operation.
- (4) After starting heating (humidifying), the sound of the water supply solenoid valve will be heard every 3 or 4 minutes (a clicking sound), so listening for that clicking sound let the unit run for 30 minutes to make sure that humidifying operation is normal.

 **CAUTION**

- If carpentry work is not completed when a test run is finished, tell the customer not to run the humidifier for the protection of indoor unit and HRV until it is completed.
- If the humidifier is run, paint, particles generated from adhesive and other materials used for carpentry work may cause HRV to get dirty, causing splash or leakage of water.

C : 3P130768-2E

## 10 Outdoor Air Processing of Ceiling Mounted Duct Connection Type

The structure of VKM-GAMV1 model is different from other ventilation models. Points you need to note are summarized below, which please use for your reference when selecting the model.

### 10 - 1 Stand-alone Operation is Possible as an Independent System

Because no function to control the room temperature is equipped, only the operation mode (cooling, heating, automatic, ventilation) is displayed on the remote controller. Set temperature is not displayed. (Automatic mode is displayed only when connected with outdoor unit of cooling/heating free type.)

In addition, you cannot change the set temperature or set direction of air flow.

Even if you attempt to operate by changing the temperature or air flow direction, only [This function is not available] will be displayed.

You can select the ventilation mode, ventilation amount and operation switching (if a function to select either cooling or heating has been provided) only.

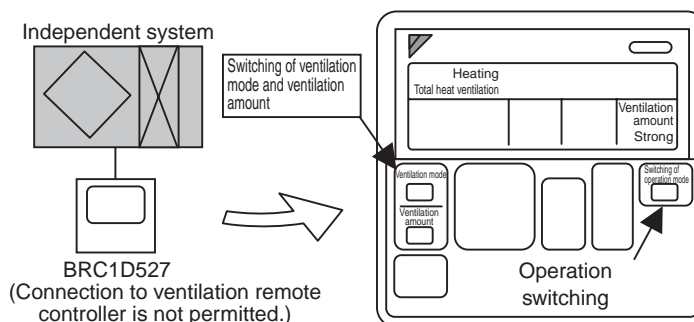

### 10 - 2 Ability to Calculate Connectable Capacity

Because of an outdoor air processor, the load may increase depending on the outdoor air condition. So, use the values in the table below when calculating the connectable capacity to an outdoor unit.

Ceiling mounted duct connection type	Corresponding HP	Ability to process outdoor air (kW)		Ability to calculate connectable capacity (kW)	Diameter of connection pipe
		Cooling	Heating		
VKM50GA(M)V1	1.0	4.71 (1.91)	5.58 (2.38)	3.5	φ6.4 for liquid φ12.7 for gas
VKM80GA(M)V1	1.6	7.46 (2.96)	8.79 (3.79)	5.6	
VKM100GA(M)V1	2.0	9.12 (3.52)	10.69 (4.39)	7.0	

( ) indicates a heat amount recovered by a total heat exchanger.

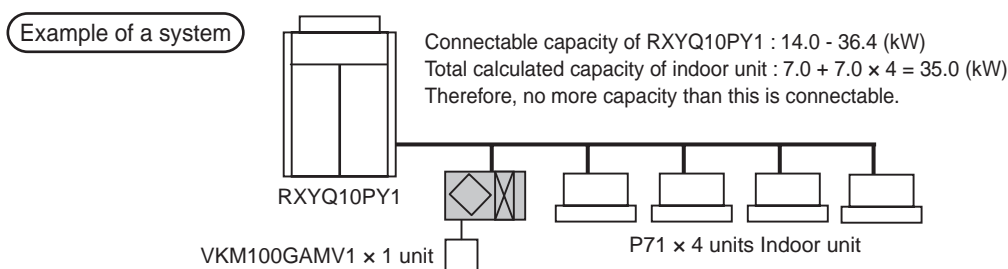

#### ■ Similar to R-407C Model, but following points are to be noted ; [Features of VKM-GA(M)]

Because VKM-GA(M) model is equipped with a heat exchanger unit, a PC-board (corresponding multiple type for building PC-board) for controlling the heat exchanger has been built-in in addition to a P-board for ventilation.

These two PC-boards are connected via remote controller line (P1 P2) to perform an interlocked control. Its control system provides the same condition when 1 ventilation and 1 multiple type for building have been remotely controlled. No air-conditioning (temperature controlling) function has been equipped. Therefore, it is necessary to prepare separately an indoor unit for air-conditioning purpose.

# 10 Outdoor Air Processing of Ceiling Mounted Duct Connection type

## 10 - 2 Stand-alone Operation is Possible as an Independent System

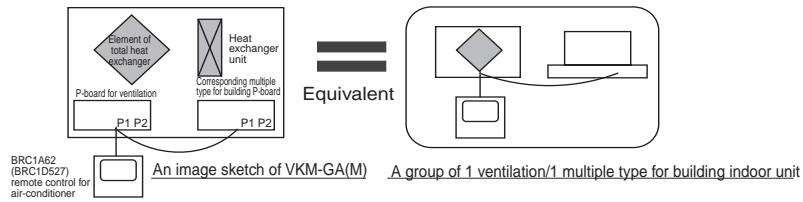

### [Points to be noted for VKM-GA(M)]

There are following restrictions with VKM-GA(M) model due to its own controlling structure.

1. Stand alone system: No address setting is required because of its automatic addressing function (corresponding multiple type for building P-board : Master).  
Because it is under a group control, it is always required to connect to a remote controller. The structure does not permit if no remote controller is connected. A direct connection to a duct is also prohibited.
2. Interlock system : No address setting is required because of its automatic addressing function (Indoor unit : Master).
  - Basically, the interlocking with an air-conditioner is only made via connection to a remote controller line (NP).

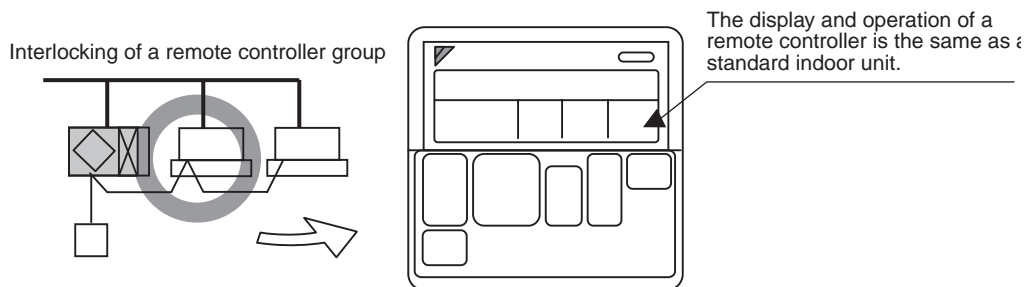

- Number of units connectable in case of a remote controller group  
Because 2 pieces of controlling P-board have been built in a VKM-GAM model, count the remote controller group as : 1 set = 2 units. The maximum number of units connectable to a remote controller group is 16.

<Example>  
 How many units of VKM-GAM model can be connected within a single group?  
 In case of a group composed of (10 × indoor units + VKM-GAM), the maximum number of VKM-GAM is 3.  
 $10 + 3 \times 2 = 16$  units      OK  
 In case of 4 units ;  
 $10 + 4 \times 2 = 18$  units      NG (2 units are in excess)

- External contact point  
 If you want to start/stop through an external contact point, use external input terminals (T1 and T2).  
 \* If you start/stop using T1 and T2 terminals, the entire remote controller group makes a start/stop.

Note 1) JC/J2 of ventilation P-board cannot be used. (Because only the ventilation P-board makes a start/stop, no synchronized movement with the corresponding multiple type for building P-board is assured.)

# 10 Outdoor Air Processing of Ceiling Mounted Duct Connection type

## 10 - 3 Central Control System

- When carrying out a central connection, connect the central line to F1 and F2 only on the corresponding multiple type for building P-board. Do not connect to F1 and F2 on the ventilation side. (= Connect to the terminal block X3M.)

An image sketch of internal wiring on the ventilation side

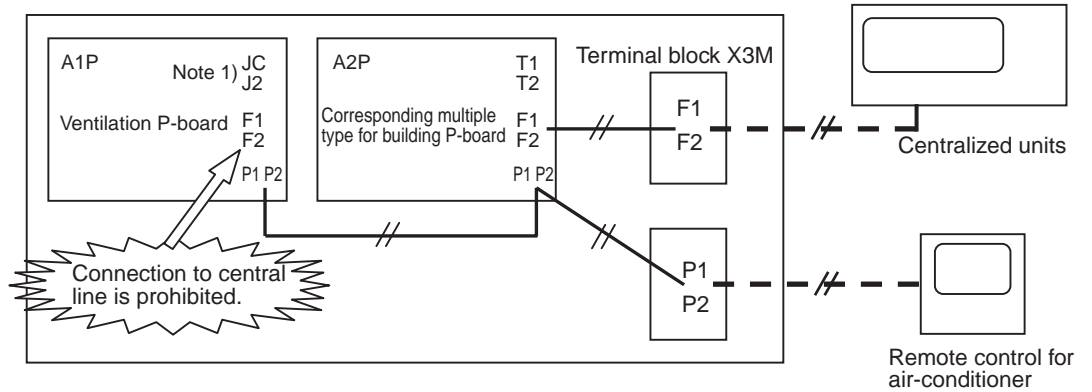

- In case of a central control, operation ON/OFF can be done separately by each zone. (In this case, zone interlocked setting must be kept as the factory setting (17. 08. 01).)
- Structure without a remote controller cannot be accepted because the remote controller group is controlled within a VKM-GA(M) model. (intelligent Touch Controller, central control controller)

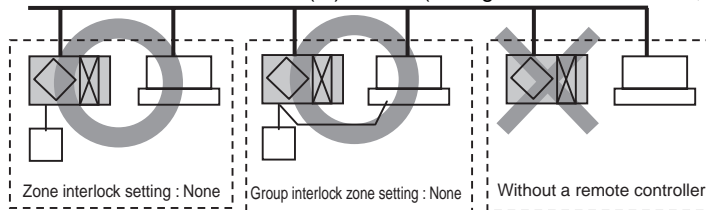

**\* Alteration of set temperature and independent ventilation operation cannot be performed from a central device.**

# 10 Outdoor Air Processing of Ceiling Mounted Duct Connection type

## 10 - 4 Restrictions to Control System

**10 - 4 - 1 Do not Give VKM-GA(M) Model a Function to Select Cooling/Heating.**  
 (This is because the operation mode switches automatically depending on the outdoor conditions regardless of the indoor temperature when set to "Automatic".)

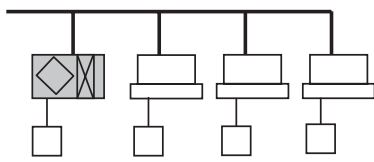

Give a function to select cooling/heating to either one of these.

### 10 - 4 - 2 Caution When Connecting with a VRVIII System, Heat Recovery Type

When bringing the RA (exhaust gas intake) of this unit directly in from the ceiling, connect to a BS unit identical to the VRV indoor unit (master unit), and use group-linked operation.

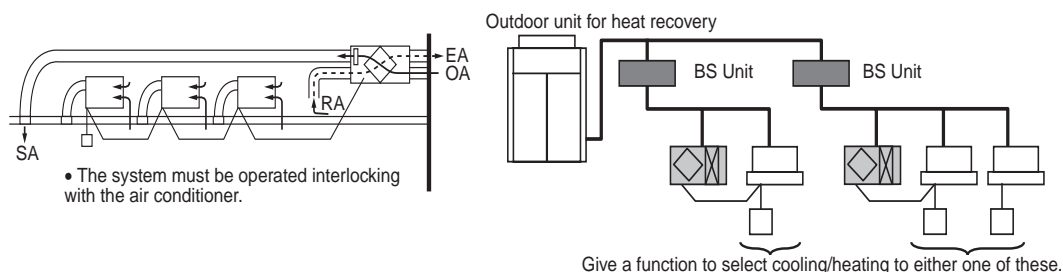

Give a function to select cooling/heating to either one of these.

#### CAUTION

If above setting is not made, the detection of correct temperature is not available and automatic judgment on proper cooling or heating cannot be made when the temperature in the ceiling gets higher than indoor temperature. Poor heating or shortage of the amount of humidification may result.

If the indoor unit and this unit are installed with different BS system inevitably, always take following remedies (1) and (2).

(1) RA (Exhaust and suction) of this unit is not taken directly from inside of the ceiling, connect the suction duct and suction grille to the fitting port of RA duct to suck the indoor air.

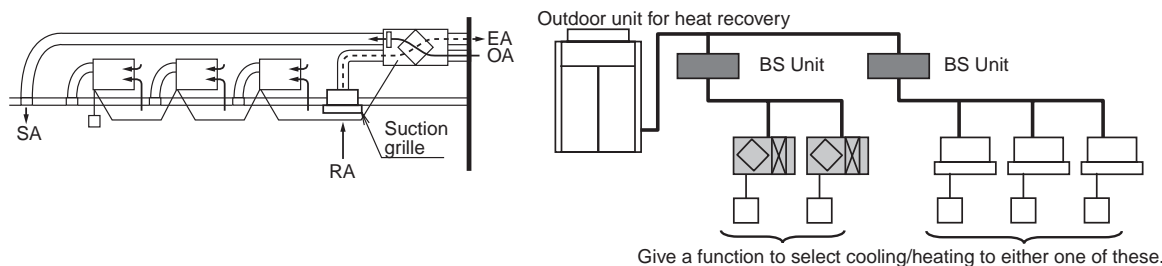

Give a function to select cooling/heating to either one of these.

(2) Do not make the selection of heating or cooling in automatic mode and it shall be made by manual selection from remote controller or centralized controller.

## 10 Outdoor Air Processing of Ceiling Mounted Duct Connection type

### 10 - 4 Restrictions to Control System

#### 10 - 4 - 3 Caution when Connecting the Indoor Unit Directly to the Duct

Follow the indications described below

- a) When connecting the indoor unit directly to the duct, always use the same system on the indoor unit as with the outdoor unit, perform group-linked operation, and make the direct duct connection settings from the remote controller. (Mode No. "17 (27)" – First code No. "5" – Second code No. "6".) Refer to 15.10.1 concerning setting method.

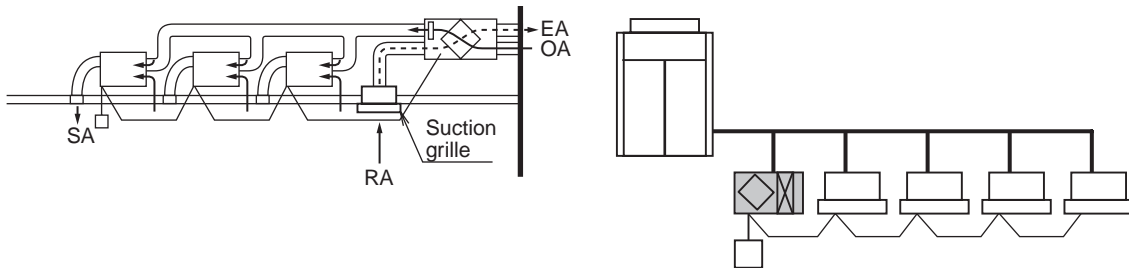

- b) Do not connect to the outlet side of the indoor unit. Depending on the fan strength and static pressure, the unit might back up.
- c) When it is connected to the suction side of indoor unit as a direct duct connection system, etc., since there is a possibility that the body thermo of the indoor unit detects erroneously SA discharge from this unit as indoor air, use the remote sensor (Optional).



# 10 Outdoor Air Processing of Ceiling Mounted Duct Connection type

## 10 - 5 About the basic control of VKM

### 10 - 5 - 1 Basic control of VKM

VKM sucks the air after OA has subjected to total heat exchange with RA, detects the air temperature by means of the thermistor for inlet air into DX-coil (R3T) to make a judgment on operation mode, cooling or heating and exercises the control on the capacity of air heat exchanger.

■ **Sensor position and its function**

VKM consists of indoor unit + total heat exchanger portion.

Dissimilarities with normal indoor unit are :

- Position of thermostat in the normal indoor unit : Position to detect RA temperature
- Position of thermostat in VKM : Position to detect the air subjected to total heat exchange between OA and RA.

Therefore, the temperature detected by VKM gets lower than that of the indoor unit thermostat.

Doing so allows VKM to perform treatment of outside air with stability even as the indoor unit stays thermo-OFF state because of big difference between the set temperature and suction temperature even though the set temperature of VKM and indoor unit are the same.

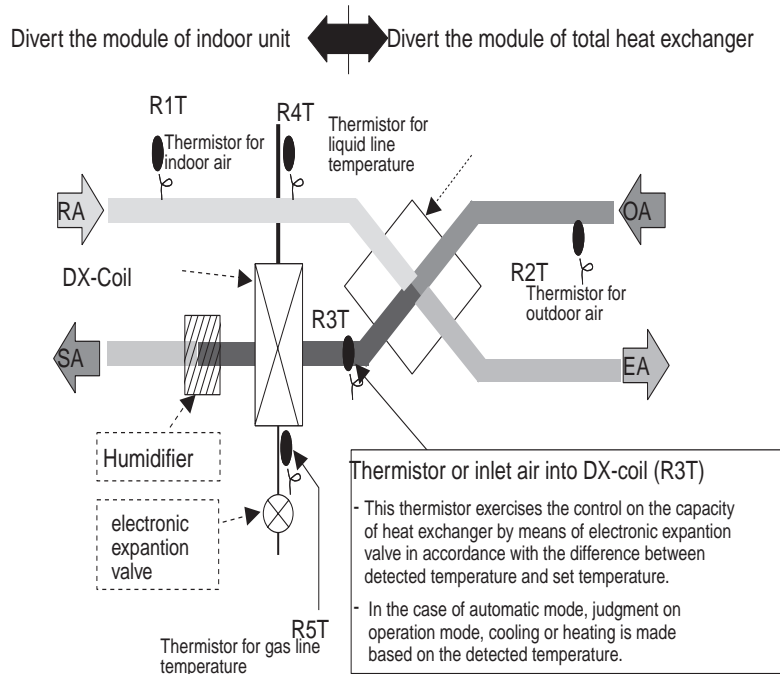

# 11 Appendix

## 11 - 1 Purpose of Ventilation

Living environment, and working environment as well, can be polluted for various reasons, which in turn will lead to hygienic problems and/or lower productivity. To avoid this, the polluted air must be replaced with fresh air. This operation is called ventilation.

To apply ventilation for removing pollution, it is necessary to identify the causes of air pollution before studying corrective measures.

### 11 - 1 - 1 Air Pollution

#### ■ Dust

There are about 7,500 ~ 22,000 dust particles in the air of one liter. However, if you feel dusty, the number may have reached as many as 100 ~ 200 thousand. We are unknowingly inhaling such polluted air, which enters into our trachea and lungs, leading to coughs and difficulty in breathing, some malignant disease and/or nausea, and in worse cases, other serious chronic diseases such as bronchitis and pneumoconiosis.

**Table 1 Suspended Dust in the Air**

Type of dust	Content (weight %)
Smoke, pollen, fly ash	0~20%
Ore chips, cinders	10~90%
Rotten plant	0~10%
Vegetable fiber	5~40%
Carbon, fume	0 ~ 40%

#### ■ Bacteria

Suspended particles of bacteria of 0.2~5μ in diameter are likely being adhered with dust in the air, not independently suspended. According to NASA (the National Aeronautics and Space Administration), the more number of dust particles may allow the more number of bacteria to exist, which may justify the abovementioned theory of bacteria's presence in the form of adherence to dust. Therefore, it is possible to remove bacteria using an electrostatic precipitator, though the result of cleaning cannot be easily measured. It takes time to demonstrate how effectively bacteria could be removed. According to our experiments that measured the number of bacteria using the settle plate microbe count method, the number of bacteria in the space above the dust collector electrode is smaller than that collected on a plate of the same area being left in the air. This indicates that electrostatic precipitators can, to some extent, kill bacteria collected on the electrode.

**Table 2 Particle diameter of dust**

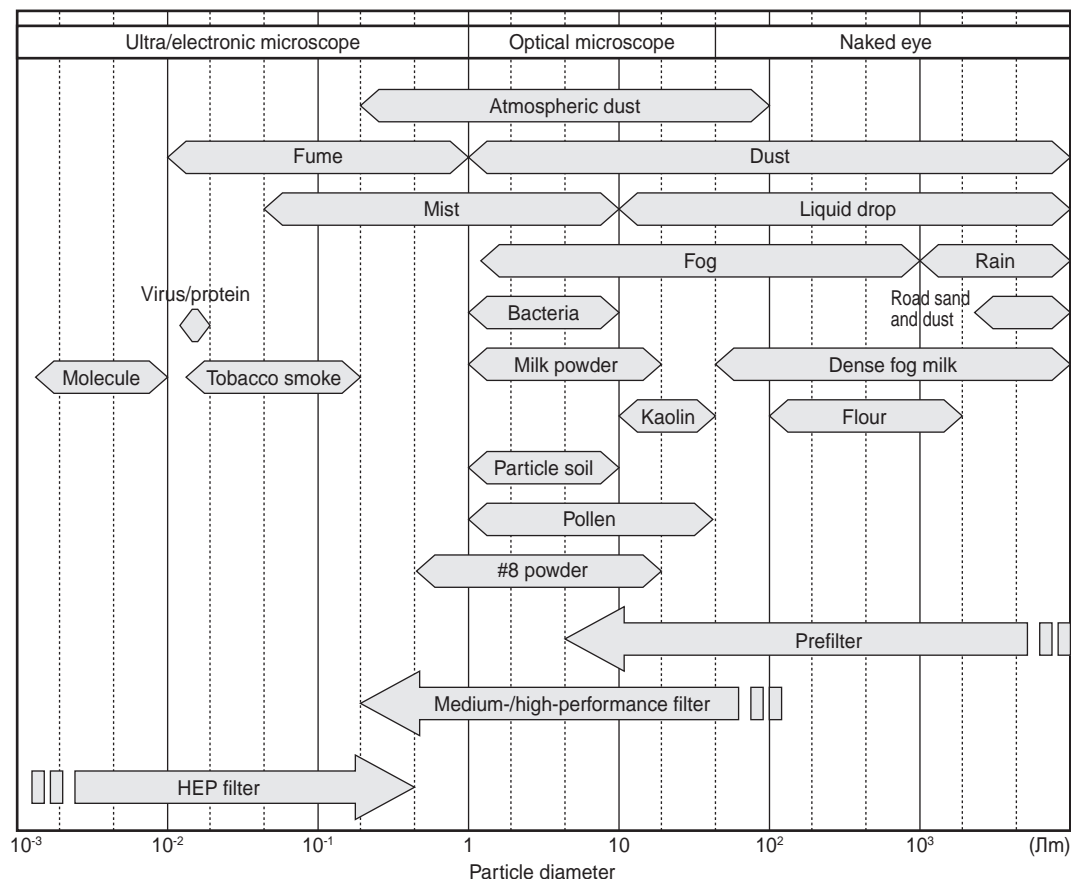

# 11 Appendix

## 11 - 1 Purpose of ventilation

### 11 - 1 - 1 Air Pollution

#### ■ Tobacco

Only one cigarette can soon pollute the air in the enclosed room. And both the smoker and other non-smokers staying here are affected. Especially the "secondhand" smoke from the tip of cigarette contains 2~3 times larger amount of harmful substances (nicotine and tar) than the "main smoke" exhaled by the smoker, so that the non-smokers around the smoker can be affected by tobacco smoke.

So, tobacco smoke is one of the serious causes of interior air pollution. Tobacco smoke consists mainly of mists such as tar and nicotine, gases such as carbon monoxide (CO), carbon dioxide (CO<sub>2</sub>), hydrogen and various hydrocarbons including methane, and traces of hydrogen cyanide, formaldehyde, acrolein, ammonia and nitrogen oxides (NO<sub>x</sub>), so that various human health problems including lung cancer, chronic CO toxication and bronchitis can occur.

New ceilings, walls, furniture and decorations in white will turn into yellow in one or two years. This is due to the nicotine and tar contained in tobacco smoke, and/or dust in the air.

To allow smoking, proper ventilation is inevitable. A ventilation system consisting of an air cleaner and ventilator that operates automatically detecting the level of pollution is recommendable. This system can be associated with an air conditioning system, so that power consumption for these systems can be reduced, and so that they can enjoy comfortable smoking without feeling hot or cold.

**Table 3 Sensation for Tobacco Smoke**

Smoke concentration (mg/m <sup>3</sup> )	Status of the air in the room	Sensation
0.15	Smoke diffuses in 6 to 30 seconds.	Slight odor
0.44	Slightly smoky	Odor
0.78	Slightly smoky	Feel strange in the nose and/or throat
0.95	Blurred sight	Strong odor
1.13	Blurred sight	Slight eye irritation
1.26	Heavily smoky	Nose and throat irritation
1.48	Heavily smoky	Slight pain of eyes
1.73	Heavily smoky	Pain of nose and throat
1.95	Heavily smoky	Slight tears

**Table 4 Air Pollutants per Cigarette (when smoking)**

Type	NO <sub>x</sub> (cc)	CO (cc)	DUST (mg)
Seven Stars	0.90	72	12.6
	0.57	38	7.7
	0.77	68	11.3

**Table 5 Air Pollutants per Cigarette (when a lit cigarette is left)**

Type	NO <sub>x</sub> (cc)	CO (cc)	DUST (mg)
Seven Stars	1.26	45	6.3

**Fig 1 Three-Year-Old Child Asthmatic Bronchitis Due to Passive Smoking**

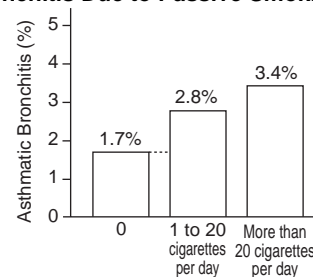

#### ■ Carbon monoxide (CO)

Carbon monoxide is colorless, odorless and very toxic gas. Imperfect combustion of briquette, charcoal or oil produces CO gases. Tobacco smoke and automobile exhaust gases also contain CO gases.

CO gases inhaled into the lung join together with hemoglobin in the blood, which result in preventing the bonding between oxygen and hemoglobin, leading to inability to convey oxygen to the tissues of the human body. The bonding force between CO and hemoglobin is 200 ~ 300 times larger than that between oxygen and hemoglobin.

A typical symptom is headache. The motor of their limbs is anaesthetized before losing consciousness, so that they cannot escape away from the place, which may, in the worst case, lead to fatal accident. Inhaling CO gases repeatedly may lead to chronic poisoning, with short memory, or in the worst case, he (she) is crippled for life.

The normal atmosphere contains about 21% of oxygen. Combusting the air will reduce the oxygen concentration. When it reduces to 19%, CO concentration starts to increase quickly. This quick increase in CO concentration occurs earlier with the lower combustion rate. This is a reason for larger number of CO poisoning accidents due to imperfect combustion. During combustion, using both exhaust ventilation and supply of fresh air is preferable.

# 11 Appendix

## 11 - 1 Purpose of ventilation

### 11 - 1 - 1 Air Pollution

**Table 6 Effect of Carbon Monoxide (CO)**

Concentration (ppm)	Effect of change in concentration	
0.01~0.2	Standard atmosphere	
5	Long-term based allowable value	About 5 ppm in annual average for urban roads; over 100 ppm possible for motor highways, tunnels and parking areas
10	Building Standard Act and Building Control Act use this value as the 24-hour average environmental standard.	
20	Short-term based allowable value: 8-hour average environmental standard	
50	Vocational environment allowable concentration (Japan Industrial Safety and Health Association)	
100	No effect up to 3 hours, effect after 5 hours, headache after 8 hours, malignant disease, long-term harmful, non-lethal	
200	Slight pain in the forehead within 2~3 hours	
400	Pain in the forehead within 1~2 hours, and occipital part within 2~3 hours	
800	Headache, giddiness, nausea and convulsion in 45 minutes, and swoon in 2 hours	
1,600	Headache and giddiness in 20 minutes, and death in 2 hours	
3,200	Headache and giddiness in 5~10 minutes, and death in 30 minutes	
6,400	Death in 10~15 minutes	
11,800	Death in 1~3 minutes	
Scores of thousands ppm (several %)	Possible for automobile exhaust emissions	

Source: Facility Check List published by Eikoku-Sha

**Fig 2 Relationship in Concentration between Oxygen and CO**

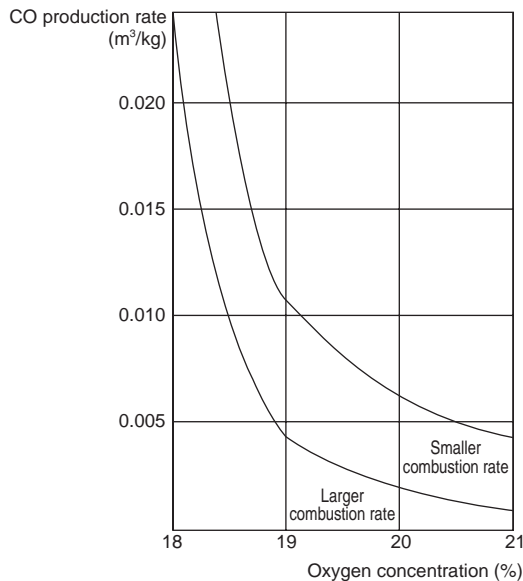

<CO safety limit is 10 ppm with max. 5 ppm recommended>

#### ■ Carbon Dioxide (CO<sub>2</sub>)

Carbon dioxide gas is a normal component of the air, normal concentration of about 0.04%. Physiologically, CO<sub>2</sub> gas is requisite for human life: the gas stimulates the respiratory center for unconscious, automatic breathing. CO<sub>2</sub> gases dissolve into blood to maintain the oxygen concentration at the proper level for the purpose of sustaining normal functions of human body. Hygienically, CO<sub>2</sub> gases are used as an indicator of the atmospheric condition in the room, not treated as a toxic gas.

Higher concentration of CO<sub>2</sub> gas will adversely affect the human body, though the effect closely depends on the oxygen concentration.

# 11 Appendix

## 11 - 1 Purpose of ventilation

### 11 - 1 - 1 Air Pollution

**Table 7 Effect of Carbon Dioxide (CO<sub>2</sub>)**

Concentration (%)	Effect of change in concentration	
0.03(0.04)	Standard atmosphere	
0.04~0.06	Urban atmosphere	
0.07	Allowable concentration for many persons staying in a room	These concentration limits are defined as a pollution indicator within a hypothesis that the physical and scientific properties of the air will become worse with the increase in the concentration of CO <sub>2</sub> , not based on its own harmfulness.
0.10	Allowable concentration for general cases: adopted by the Building Standard Act and Building Control Act	
0.15	Allowable concentration for ventilation calculation	
0.2~0.5	Worse result	
0.5 or larger	Worst result	
0.5	Long-term safety limit (US Labor Health) ACGIH, Labor Office Rule	
2	30% increase in breathing depth and air amount inhaled	
3	Lower working performance, change in physiological functions, and twice larger number of breaths	
4	Concentration for normal breathing	
4~5	Stimulates the respiratory center for taking a deeper breath and increasing the number of breaths ; longer breathing time is a sign of danger ; O <sub>2</sub> starvation will raise the possibility of physical disorder outbreak earlier than usual	
8	10-minute breathing will result in serious difficulty in breathing, hectic cheeks and headache ; O <sub>2</sub> starvation will enhance the possibility of this disorder	
18 and larger	Lethal	

■ **Sulfurous acid gas**

Volcano exhaust, automobile exhaust or oil fuel-combusted gas and mist contain sulfurous acid gases in the form of being adhered or absorbed onto suspended dust particles. These gases are a possible cause of chronic bronchitis or other respiratory diseases.

■ **Nitrogen oxides**

Nitrogen oxides (NO<sub>x</sub>) include NO, NO<sub>2</sub>, NO<sub>3</sub>, N<sub>2</sub>O, N<sub>2</sub>O<sub>3</sub> and N<sub>2</sub>O<sub>4</sub>. Of these, NO and NO<sub>2</sub> are harmful and account for large portions of NO<sub>x</sub> compounds. NO<sub>2</sub> (nitrogen dioxide) can easily reach the deepest part of the lung, and adversely affect it and other organs. In terms of long-term adverse effect, NO<sub>x</sub> is stronger than sulfurous acid gases. Dusts can enhance the adverse effect of NO<sub>x</sub> gases.

NO (nitrogen monoxide) is also harmful, though its chronic effect is yet to be clarified.

- NO<sub>2</sub> produced by other than combustion

Oil heaters and gas ovens for oxygen-based combustion produce a large amount of NO<sub>2</sub> gases. Electric ovens also produce NO<sub>2</sub> gases though their amount is smaller, and this is not well-known. That is, high temperatures, regardless of combustion, facilitate bonding between N and O atoms in the air, which results in the increase in the amount of NO<sub>2</sub>. Continual generation of high temperatures in an enclosed space thus requires ventilation.

<NO<sub>2</sub> safety limit = 0.04 ppm~0.06 ppm>

**Table 8 Effect of SO<sub>2</sub> on Human Body**

Concentration (%)	Effect of change in concentration
1	Feel of slight oppression in the chest
3~5	Feel odor
7~12	Stimulant odor
20~40	Significant stimulation, eye irritation and coughing
100~200	Bronchitis and significant stimulation in the chest; and lung disorder
300	Impossible to breath
400	Difficulty in breathing
500	Impossible to breath

■ **Oxygen starvation**

About 21% of O<sub>2</sub> concentration is normal for human body. Lower O<sub>2</sub> concentration will cause difficulty in breathing with other various symptoms. O<sub>2</sub> concentration of 8% or lower will have a fatal effect. Higher O<sub>2</sub> concentration will cause our pulse rate to increase, which leads to larger burdens on the heart. Abnormally higher O<sub>2</sub> concentrations invite another danger : higher ignition possibilities. Therefore, artificial oxygen supplies should be avoided. The most effective way for avoiding oxygen starvation is to supply natural air that contains oxygen concentrations appropriate for human life.

# 11 Appendix

## 11 - 1 Purpose of ventilation

### 11 - 1 - 1 Air Pollution

- Yawning is a sign of insufficient oxygen

You may think that persons who frequently yawn have no concentration. However, this is not the case depending on the situation. Yawning is a physiological phenomenon that can occur when the brain is suffering from the shortage of oxygen. Concentration can be reduced by the shortage of oxygen. Yawning is an action to try to keep himself (herself) concentrated. Fresh air required for human body is min. 30 mg per hour. This corresponds to the oxygen amount contained in a room of normal size (about 10 m<sup>2</sup>), which suggests that four persons of a family cannot stay for more than one hour in an enclosed, non-ventilated living room about four times larger than a normal size bed room or private room. Yawning should be considered a sign of oxygen shortage. In such cases, immediately take fresh air into the room.

**Table 9 Effect of Oxygen (O<sub>2</sub>) Concentration**

Concentration (%)	Standard, and effect of change in concentration
About 21	Standard air
20.5	Ventilation shall have a target of not decreasing the O <sub>2</sub> concentration by 0.5% or larger from the normal value (Building Standard Act)
20~19	In the normal atmospheric pressure, this small reduction in O <sub>2</sub> concentration unlikely affects our lives, though in the case of using a combustion apparatus, possible imperfect combustion may cause the CO concentration to increase quickly.
18	Standard of Labor Safety and Health Law (Oxygen Starvation Preventive Regulation)
16	Concentration during breathing in normal cases
16~12	Increase number of pulses and breaths, giddiness, and headache
15	Combustion apparatuses will be put off
12	Possibility of death within a short time
7	Death

#### ■ Humidity

Humidity has a close relationship with our living environment. Humidity is an additional parameter to be controlled by air conditioning systems. It may give persons a feel of mild air, if the temperature is relevant for the humidity. Imbalance between the temperature and humidity (especially higher humidity) leads to discomfort. A term that is frequently used in summer, "discomfort index," indicates this imbalance between temperature and humidity. Higher humidity causes buildings and furniture to rot. Lower humidity causes our skins to dry and buildings and furniture to crack or warp. Another point for controlling humidity is to avoid mold, ticks and termites. To satisfy all of these requirements, two types of ventilation must be used in a well controlled, combined manner. One is to maintain the humidity for our living comfort, and the other one is to remove humidity where dryness is required to prevent such mold and small animals.

<Relative humidity recommended = 30~70%>

# 11 Appendix

## 11 - 2 Kinds of Ventilation

### 11 - 2 - 1 Methods of Ventilation

Natural ventilation based on the natural conditions and mechanical ventilation using mechanical power

#### ■ Natural ventilation

Uses external wind pressures and/or buoyancy force produced by the difference in temperature between the inside and outside of the room: subject to natural conditions, so the benefits are unforeseeable, or smaller than expected.

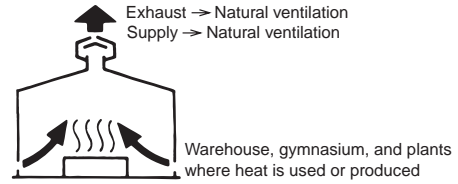

#### ■ Mechanical ventilation

Forced ventilation using a power-driven fan or blower produces larger flow in a more stable and timely manner than natural ventilation.

\* To ventilate a more heavily polluted room, it is necessary to keep the room air pressure lower than the surroundings to avoid the dirty air flowing into the adjacent rooms or passages; for clean rooms, it is necessary to keep the room air pressure higher than the surroundings to avoid the dirty air coming into the room.

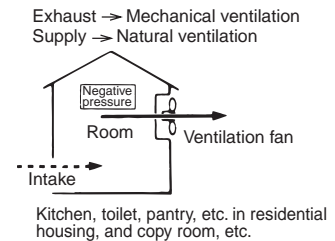
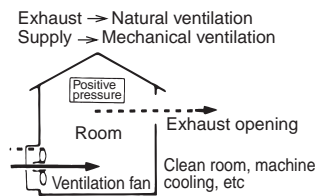
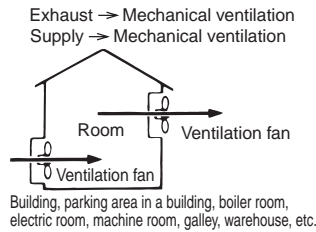

#### <Mechanical ventilation>

##### ■ Whole ventilation

This is to replace all air in the room with fresh air. This system is effective for rooms in which there is a source of smoke, steam or odor.

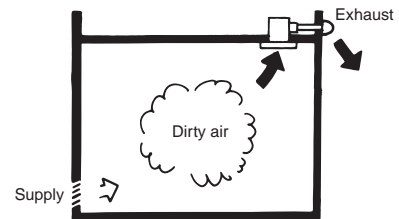

##### ■ Local ventilation

This is to replace air in a limited area where the air is polluted. This is effective for cases where the source of pollution is stationary and concentrated. Combined use with a hood is effective for removing highly contaminated air.

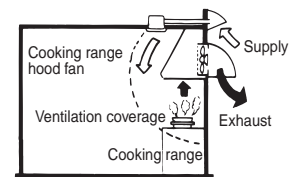

#### <Important supply flow>

To ensure effective ventilation, sufficient air intakes should be provided. To ensure stable ventilation, the same amount of fresh air as exhausted should be supplied.

##### ■ Size and location of air intakes

###### 1. Size

Mechanical ventilation fan rated capacities indicated on a catalogue can be used on condition that the same amount of air is fed into the room through the air intakes. Smaller air intakes will reduce the capability of the ventilation fan. Generally, the air intakes should be larger than the ventilation fan opening. Larger air intakes can reduce the air velocity from the intake, so that persons, when standing near the intake, do not feel discomfort.

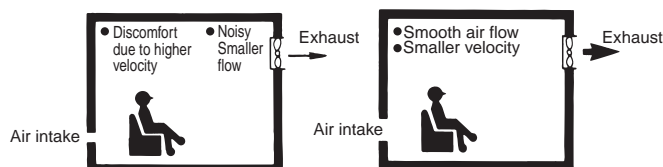

# 11 Appendix

## 11 - 2 Kinds of Ventilation

### 11 - 2 - 1 Methods of Ventilation

#### 1. Location of exhaust (fans) and intakes

For whole ventilation, air intakes should be located as far from the fans as possible. For local ventilation intended for narrower, limited space, air intake(s) should be located as close to the fan as possible so that the surrounding areas can be less affected.

For large rooms, multiple air intakes should be located dispersedly and as far from the exhaust as possible to ensure uniform ventilation throughout the room.

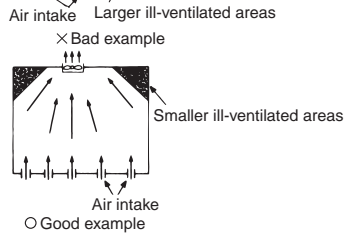
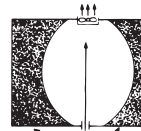
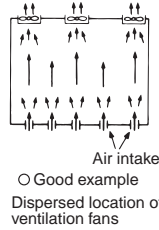

#### 2. For confined rooms

Ventilating a bathroom with the door tightly closed may cause the water trap of the drainage to break, which results in the backflow of odor into the bathroom. In cold weather areas, ventilating a confined room using a stove with a natural exhaust ventilation duct may invite backflow of air into the stove through the exhaust duct, leading to dangerous combustion condition.

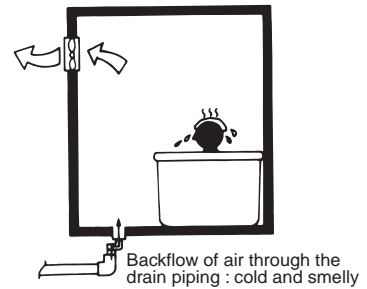



# 11 Appendix

## 11 - 2 Kinds of ventilation

### 11 - 2 - 2 Air Flow (Quantity), and Dynamic and Static Pressure

Ventilation fan performance parameters include air flow (quantity) and static pressure. These two parameters relate closely to each other. Ventilation cannot be designed without these two parameters. The first step of “designing a ventilation system” is to understand these two parameters.

■ **Quantity**

Air flow is the amount of air that a ventilation fan exhausts (or supplies) per unit time, generally expressed in m<sup>3</sup>/h or m<sup>3</sup>/min.

■ **Pressure**

This is a wind pressure expressed in the unit of Pa. Three types of wind pressure are used.

- **Dynamic pressure**  
This is a pressure produced by wind velocity, also called “velocity pressure.” Deflection of a window glass by strong wind during typhoon is due to this dynamic pressure.
- **Static pressure**  
When a balloon has been inflated, there is a pressure in the balloon that presses against the membrane of the balloon. Static pressure is produced also when the air is still.
- **Total pressure**  
This is the sum of wind’s dynamic pressure and static pressure.

■ **Relationship between pressure types**

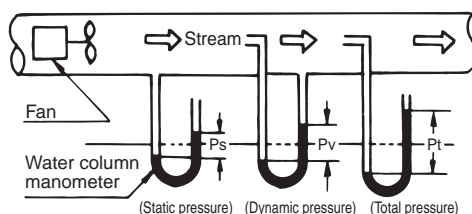

“Static pressure (Ps)” is a pressure needed for overcoming the resistance of the duct when conveying air.

“Dynamic pressure (Pv)”, on the contrary, is a pressure due to air stream. To determine air velocity, measure the dynamic pressure of the air.

The “total pressure (Pt)” is the sum of static pressure and dynamic pressure.

$$Pt = Ps + Pv = Ps + \frac{V^2}{2g} \gamma$$

- V : velocity (m/sec)
- g : Acceleration of gravity (m/sec<sup>2</sup>)
- γ : Air density (kg/m<sup>3</sup>)

■ **P-Q Curve (static pressure - flow characteristic curve)**

“P-Q Curve” shows the performance of a ventilation fan by indicating the relationship between air flow and static pressure.

Fig. a shows a case with a wall-mount supply opening that is so small that the internal pressure becomes slightly lower than the atmospheric pressure. The static pressure is B mm.

Fig. b shows a case with a wall-mount supply opening that is so large that the internal pressure becomes almost equal to the atmospheric pressure. The static pressure is 0 Pa.

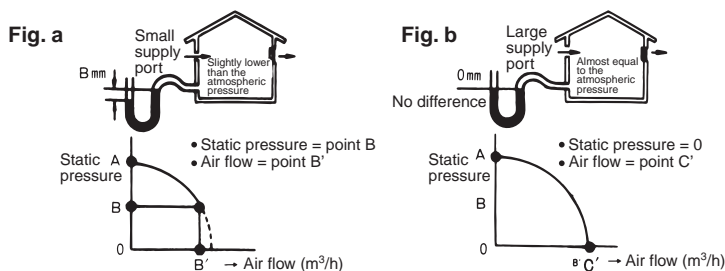

# 11 Appendix

## 11 - 2 Kinds of ventilation

### 11 - 2 - 3 Mechanical Fan Types and their Characteristics

#### ■ Axial fan and centrifugal fan

Ventilation fans are roughly classified into two types: axial fans and centrifugal fans. These two types of ventilation fans are selected depending on the operating conditions and/or application. Axial fans are normally propeller fans available for applications for larger flow but at smaller pressure ratings ranging between 0 and 30 Pa. Centrifugal fans are either sirocco or turbo fans available for applications that need large pressure, and available for ducted ventilation systems.

#### <Propeller fan>

- The simplest axial flow fan available for small capacity applications; larger air flow can be obtained but at small pressure up to about 30 Pa, so that large reduction in flow can occur due to resistance (e.g. frictional resistance) when flowing in a ducted system.

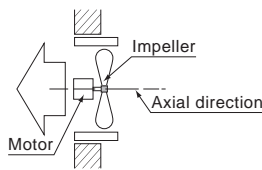

#### <Features>

- Air flow is larger than sirocco or turbo fans, but the static pressure is lower.

#### <Installation>

- Residential housing, external wall mount

#### <Applications>

- General ventilator
- Window-mount ventilator
- Living room ventilator

#### <Sirocco fan>

- Uses the same theory as water wheel; the impeller consists of many small fins facing forward as shown in the figure below; higher static pressure can be obtained; available for various applications.

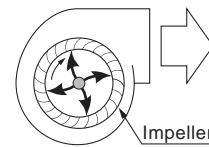

#### <Features>

- Static pressure is higher but the air flow is smaller than propeller fans.

#### <Installation>

- Housing complex
- Ducted ventilation system

#### <Applications>

- Air conditioning system ventilator
- Cooking range hood, deep
- Intermediate ventilator, ducted system
- Sirocco fan

#### ■ Impeller characteristics as an essential parameter for type selection

Propeller fans have a smaller pressure rating, which means that the air flow is reduced significantly by adverse wind. The next table shows the airflow vs. pressure characteristics that differ between propeller and sirocco fans. Depending on the topography, altitude and/or other conditions, as a general guide, propeller fans can be used at a height corresponding to the second floor of the building, and other types of fans having a higher pressure rating should be used at higher locations.

\* Even for independent houses, to ventilate a room that does not share any external walls, or if the house is located in a windy place, use a pressure type fan.

# 11 Appendix

## 11 - 2 Kinds of ventilation

### 11 - 2 - 3 Mechanical Fan Types and their Characteristics

**Wind velocity vs. wind pressure, and ventilator capacity reduction due to wind pressures (air flow : for 50 Hz only)**

External air velocity (Vm/sec)	Wind pressure (PPa)	Propeller fan	Sirocco fan
0	0	924m <sup>3</sup> /h	432m <sup>3</sup> /h
3	3.9	810	420
5	10.8	612	408
7	20.6	294 Reverse flow	390
10	43.1	Reverse flow	360
15	96.0	Reverse flow	264
20	171.5	Reverse flow	210

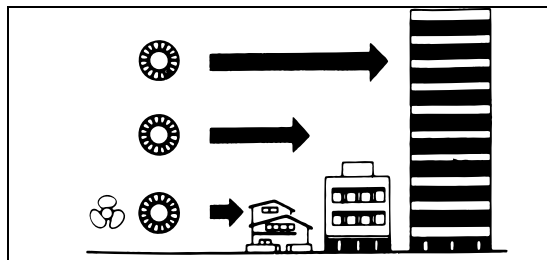
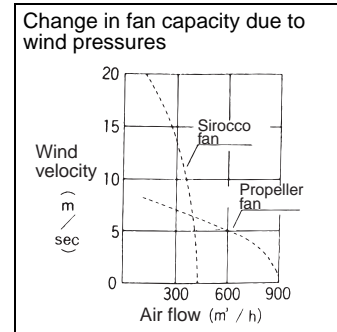

# 11 Appendix

## 11 - 2 Kinds of ventilation

### 11 - 2 - 4 Operating Sound

As well as the required airflow and static pressure, the operating sound (noise level) is an important factor for determining the type of ventilating fans. The noise level allowable limit may have been defined depending on the use of the room to be ventilated. Select an appropriate type of ventilating fans according to the noise requirements.

■ **Operating sound unit : dB**

A-weighted sound pressure level measured using a sound level meter is the measure of sound produced by an operating ventilator fan. There has been many units used : phon(A), phon, dB(A) and dB. This catalogue uses the internationally unified unit “dB.” Note that the sound pressure level in “phon” can be directly converted into “dB” without changing the numerical value. Use sound level meters in the A-weighted mode.

■ **Allowable noise level**

Building codes specify the allowable noise level for each type of room. See Table 1 for selecting.

**Table 1 Allowable noise level depending on the type of room**

Use of room	dB	Use of room	dB
Broadcasting studio	25	Cinema	40
Music hall	30	Hospital	35
Theater (about 500 seats)	35	Library	40
School room	40	Small office room	45
Meeting room	40	Restaurant	50
Apartment	40	Gymnasium	55
Hotel	40	Large office room	50
Residential housing (living room, etc.)	40	Factory	70

■ **Notes for noise level**

The noise ratings shown on the nameplate of a product are those measured in an anechoic room per the relevant JIS standard that specifies measuring procedures including the distance between the noise source under test and the sound level meter. To select types of ventilating fans, observe the following three notes.

1. The environment affects the noise level.  
The nameplate values are those measured in an anechoic room. Actual buildings have echoes from the walls, floors and ceilings, so that the noise level depends on the building materials used and how wide the room is. Use appropriate echo coefficients to determine the actual noise level and available fan types.
2. Vibration  
Motor driven fans, a type of rotating machine, inevitably produce vibration, though our largest efforts to reduce such vibration have been made. To minimize vibration (propagation and resonance), the product should be firmly mounted on the wall.
3. Synthesis of sounds  
When using two or more ventilating fans in a room, consider the synthesized effect of sounds.

■ **Other noise**

- Echoes  
Depending on the type or material of the wall and ceilings of the room, and in small room, echoes occur.
- Vibration  
Vibrating objects produce vibrating sound by moving their surrounding air. 20Hz or higher frequency sounds are audible.
- Noise due to duct’s resistance  
Higher static pressures acting on the fan will produce larger sounds.

# 11 Appendix

## 11 - 2 Kinds of ventilation

### 11 - 2 - 5 Required Air Flow

When calculating the required air flow (ventilating capacity), various factors, including CO<sub>2</sub> production by the persons staying therein and production of combustion gases, should be considered. Calculations should consider all of the requirements that the room should meet.

■ **Calculate air flow based on the occupied area per person**

$$\text{Required air flow (m}^3\text{/h)} = \frac{20 \times \text{room floor area (m}^2\text{)}}{\text{Occupied area per person (m}^2\text{)}}$$

Note 1) The number 20 contained in the above equation means 20 m<sup>3</sup>/h · person. This value (required fresh air) has been determined based on the CO<sub>2</sub> production of a male adult when he is sitting quietly. If he is smoking, additional air flow is required.

Note 2) In the case that the actual occupied area per person exceeds 10 m<sup>2</sup>, use 10 as the value of the denominator of the equation.

**Occupied area per person for ventilation requirements for commercial facilities**

Building type	Occupied area per person (N)	Remarks
Restaurant, coffee shop	3m <sup>2</sup>	Floor area for business use
Cabaret, beer hall	2m <sup>2</sup>	Floor area for business use
Japanese restaurant, assembly room on hire	3m <sup>2</sup>	Floor area for business use
Shop, supermarket	3m <sup>2</sup>	Floor area for business use
Billiard room, table tennis room, dance hall, bowling alley	2m <sup>2</sup>	Floor area for business use
Pachinko parlor, go club, mah-jongg saloon	2m <sup>2</sup>	Floor area for business use
Japanese style hotel, Hotel, motel	10m <sup>2</sup>	Floor area for business use
Special bath house	5m <sup>2</sup>	Floor area for business use
Meeting room, city hall	0.5~1m <sup>2</sup>	Per area number of person
Office	5m <sup>2</sup>	Floor area of the office room

**Calculate air flow based on the required number of air changes**

$$\begin{aligned} \text{Required air flow (m}^3\text{/h)} \\ = \text{Required number of air changes (times/h)} \times \text{Room volume (m}^3\text{)} \end{aligned}$$

- The required number of air changes shown below has been determined based on the prior knowledge and experiments by sanitary testing laboratories etc.  
 (Example) Place : ordinary living room  
 Required number of air changes : 6 (times/h) (see the table below)  
 Area of the room : about 9.9 m<sup>2</sup>  
 Ceiling height : 2.4 m  
 Required air flow = 6 × 9.9 × 2.4 = 143 (m<sup>3</sup>/h)  
 Select ventilating fans that can satisfy the above mentioned airflow requirement.

**Guideline for the number of air changes**

Room	Number of air changes (times/h)
Toilet, washroom	5~15
Locker room, changing room	5
Library, warehouse, store	5
Darkroom	10
Copy room, print room	10
Projection room	10
Pantry	8
Shower room	5
Bathroom	5
Changing room	5
Food locker	5
Garbage locker	15

# 11 Appendix

## 11 - 2 Kinds of ventilation

### 11 - 2 - 5 Required Air Flow

■ Calculate air flow based on the room capacity (number of persons to be admitted)

$$\text{Required air flow (m}^3/\text{h)} = \text{Required air flow per person (m}^3/\text{h)} \times \text{Number of persons}$$

#### Required Air Flow

##### Required air flow per person

Room	Required air flow	
	Recommendation	Minimum
Bar, cabaret	51m <sup>3</sup> /person · h	42.5m <sup>3</sup> /person · h
Office, restaurant	25.5m <sup>3</sup> /person · h	17~20m <sup>3</sup> /person · h
Shop, department store	25.5m <sup>3</sup> /person · h	17m <sup>3</sup> /person · h

■ Calculate air flow based on the required air flow per floor area

$$\begin{aligned} \text{Required air flow (m}^3/\text{h)} \\ = \text{Required air flow per floor area (m}^3/\text{m}^2 \cdot \text{h)} \times \text{Floor area (m}^2\text{)} \end{aligned}$$

##### Required air flow per floor area (1m<sup>2</sup>)

Room	Air flow rate		
Office	10m <sup>3</sup> /h	10m <sup>3</sup> /h	
Shop	15m <sup>3</sup> /h	15m <sup>3</sup> /h	
Beauty salon	12m <sup>3</sup> /h	12m <sup>3</sup> /h	
Amusement room	15m <sup>3</sup> /h	15m <sup>3</sup> /h	
Smoking room	20m <sup>3</sup> /h	20m <sup>3</sup> /h	
Small meeting room	25m <sup>3</sup> /h	25m <sup>3</sup> /h	
Dining room (commercial)	25m <sup>3</sup> /h	25m <sup>3</sup> /h	
Kinds of ventilation	<p>Exhaust → Mechanical ventilation Supply → Mechanical ventilation</p> <p>Room</p> <p>Ventilation fan</p> <p>Building, parking area in a building, boiler room, electric room, machine room, galley, warehouse, etc.</p>	<p>Exhaust → Natural ventilation Supply → Mechanical ventilation</p> <p>Room</p> <p>Exhaust opening</p> <p>Clean room, machine cooling, etc.</p>	<p>Exhaust → Mechanical ventilation Supply → Natural ventilation</p> <p>Room</p> <p>Ventilation fan</p> <p>Kitchen, toilet, pantry, etc. in residential housing, and copy room, etc.</p>

■ Required air flow based on CO<sub>2</sub> production

CO<sub>2</sub> is produced by human being's breathing, which means that the required air flow depends on the number of persons staying therein and/or labor loads. To calculate air flow based on CO<sub>2</sub> production, use the following equation.

$$Q = \frac{100M}{K - K_0}$$

Q : Required air flow [m<sup>3</sup>/h · person]

M : CO<sub>2</sub> production [m<sup>3</sup>/h · person] → see Table A

K : CO<sub>2</sub> concentration limit in normal status [%] see Table B

K<sub>0</sub> : CO<sub>2</sub> concentration in the atmosphere [%] (normally 0.03%)

**Table A CO<sub>2</sub> Production Depending on Labor Burdens**

Energy metabolic rate : RMR	Labor burden	CO <sub>2</sub> production (m <sup>3</sup> /h · person)	CO <sub>2</sub> production for calculation (m <sup>3</sup> /h · person)
0	Sitting quietly	0.0132	0.013
0~1	Very light work	0.0132~0.0242	0.022
1~2	Light work	0.0242~0.0352	0.030
2~4	Medium work	0.0352~0.0572	0.046
4~7	Heavy work	0.0572~0.0902	0.074

# 11 Appendix

## 11 - 2 Kinds of ventilation

### 11 - 2 - 5 Required Air Flow

**Table B Required Air Flow Based on Labor Burdens**

CO <sub>2</sub> production for calculation (m <sup>3</sup> /h · person)	Energy metabolic rate for calculation	Labor burden	Required air flow (m <sup>3</sup> /h · person)		
			CO <sub>2</sub> limit = 0.10%	CO <sub>2</sub> limit = 0.15%	CO <sub>2</sub> limit = 0.20%
0.013	0	Sitting quietly	18.6	10.8	7.6
0.022	0.8	Very light work	31.4	18.3	12.9
0.030	1.5	Light work	43.0	25.0	17.6
10.046	3.0	Medium work	65.7	38.3	27.1
0.076	0.8	Heavy work	106.0	61.7	43.7

**<Example>**

Assumptions : CO<sub>2</sub> production 0.03 m<sup>3</sup>/h · person (light work)  
 CO<sub>2</sub> concentration limit 0.15 vol%

$$Q = \frac{100 \times 0.030}{0.15 - 0.03} = 25 \text{ m}^3/\text{h} \cdot \text{person}$$

Therefore, air flow of 25 m<sup>3</sup>/h · person is required.

**■ Required air flow based on tobacco smoking and odor**

**6-class odor level presentation (this classification is linked with an approximate, intuitive estimation of gas concentration)**

Odor intensity	Description
0	Odorless
1	Manages to detect the presence of odor (threshold concentration)
2	Manages to detect what is producing the odor (threshold concentration)
3	Easily detects the odor
4	Strong odor
5	Very strong odor

For example, to keep the odor level not greater than 2, the contamination concentration (tobacco combustion amount (mg)/ventilation amount (m<sup>3</sup>)) should be reduced to 35.3 mg/m<sup>3</sup> or smaller. To keep the odor level not greater than 1, the contamination concentration should be reduced to 17.7 mg/m<sup>3</sup> or smaller. To calculate required air flow based on smoking concentration, use the following equation.

$$Q = \frac{\text{Tobacco combustion (mg/h} \cdot \text{person)}}{\text{Allowable contamination (mg/m}^3\text{)}} \text{ (m}^3\text{/h)}$$

**<Example>**

Assumptions : Combustion per cigarette 70%  
 Combustion rate 1,000 mg  
 Number of cigarettes per person 4/h · person  
 Odor intensity level 2 (=35.5 mg/m<sup>3</sup>)

$$Q = \frac{1,000 \times 0.7 \times 4}{35.3} \approx 79.3 \text{ m}^3/\text{h} \cdot \text{person}$$

Therefore, under the conditions given above, in the case of cleaning air using ventilation only, about 80 m<sup>3</sup>/h/ person of air flow is required. By using air cleaners and/or deodorizers in conjunction with the ventilation system, its capacity can be reduced significantly.

**Required air flow depending on the degree of smoking (estimated)**

Degree of smoking	Locations	Required air flow (m <sup>3</sup> /h/person), minimum to recommended value	Smoking amount (number of cigarettes/hour/person)
Very high	Dealer office, newspaper editing room, meeting room	51~85	3~5.1 (1.5~2.5)
High	Bar, office, hotel (guest room)	42~51	2.5~3 (1.3~1.5)
Medium (to high)	Restaurant, office	20~26	1.2~1.6 (0.6~0.8)
Low (sometimes)	Sales room in a bank, office, shop	13~17	0.8~1.0 (0.4~0.5)

# 11 Appendix

## 11 - 3 Calculation of Duct Pressure Loss

Some types of ventilating fans, including those (pressure types) installed in a cooking range hood, are installed in a ducted system. The air flow depends on the pressure losses determined according to the length of the ducted system and the number of bends, and other accessories contained in the system. Air flow calculations should consider these pressure drops to estimate the air flow as accurately as possible.

### 11 - 3 - 1 Procedure for Calculating Pressure Drops and Finally Determining the Type of Ventilators

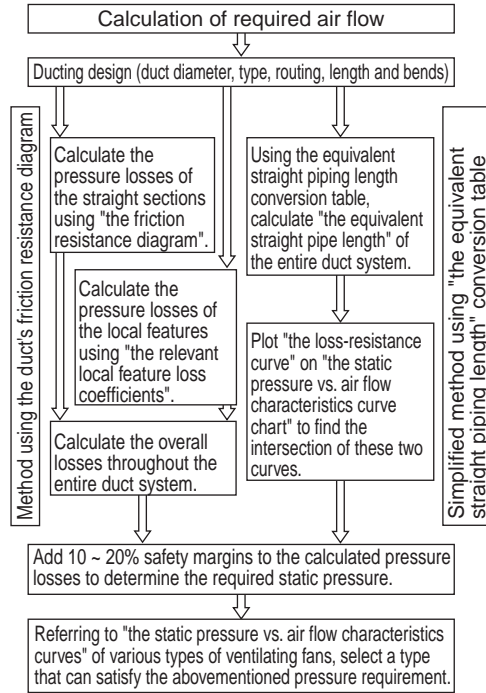

### 11 - 3 - 2 Pressure Loss Calculation for Straight Duct

■ For round ducts

- The resistance of a duct can be calculated using the following equation. Pressure drop  $\Delta P$  due to the frictional resistance of a straight duct can be calculated using the following equation.

$$\text{Resistance of duct } \Delta P \text{ (Pa)} = \lambda \times \frac{\gamma}{2} \times \frac{L}{d} \times V^2 \times 9.80665$$

- $\lambda$  : Duct friction coefficient (0.01~0.25)
- $\gamma$  : Air specific gravity (kg/m<sup>3</sup>) = 1.20 kg/m<sup>3</sup>
- L : Duct length (m)
- d : Duct diameter (m)
- V : Duct air velocity (m/sec)

$$V = \frac{Q}{d^2} \times \frac{4}{3,600\pi}$$

Q : Air flow (m<sup>3</sup>/h)

Where,  $\lambda = 0.01$  (very smooth pipe), and  $\gamma = 1.2$

$$P = 0.01 \times \frac{1.2}{2} \times \frac{L}{d} \times \left\{ \frac{Q}{d^2} \times \frac{4}{3,600\pi} \right\}^2 \times 9.80665$$

**Friction coefficient of major duct types**

Duct material	$\lambda$
Aluminum flexible duct	0.03~0.04
Vinyl chloride pipe	0.01~0.02
Galvanized steel pipe	0.016~0.025



# 11 Appendix

## 11 - 3 Calculation of Duct Pressure Loss

### 11 - 3 - 2 Pressure Loss Calculation for straight Duct

1. Using the duct's friction resistance diagram

#### Friction resistance diagram for round duct (galvanized steel pipe)

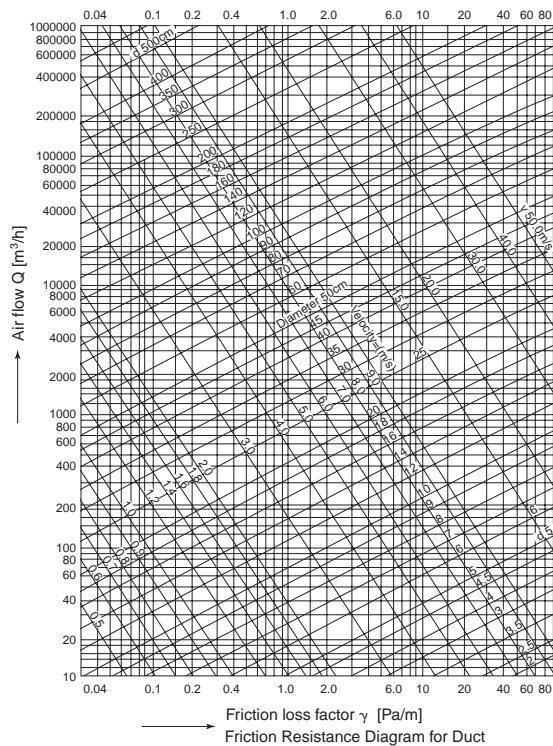

#### <How to use the diagram>

(Conditions)

- A ventilating fan intended for use with a ducted system should be chosen.
- Required air flow : 300 m<sup>3</sup>/h
- Duct diameter : φ15 cm
- Duct length : 5 m

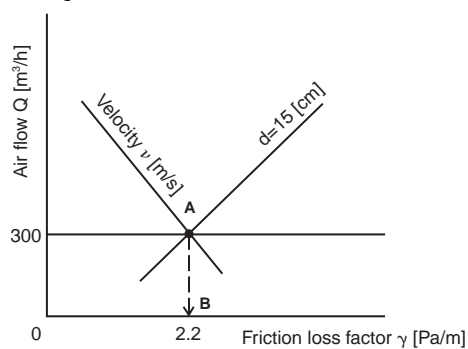

1. Find the intersection of the duct diameter  $d$  (15 cm) and air flow  $Q$  (300 m<sup>3</sup>/h) => Point **A**
2. Draw a vertical line through Point **A** until it intersects with the abscissa => Point **B**
3. Read the Point **B** (2.2 Pa/m for this case). Multiply the value by the duct length. The answer is 11 Pa.

# 11 Appendix

## 11 - 3 Calculation of Duct Pressure Loss

### 11 - 3 - 2 Pressure Loss Calculation for straight Duct

■ Conversion from rectangular to round duct

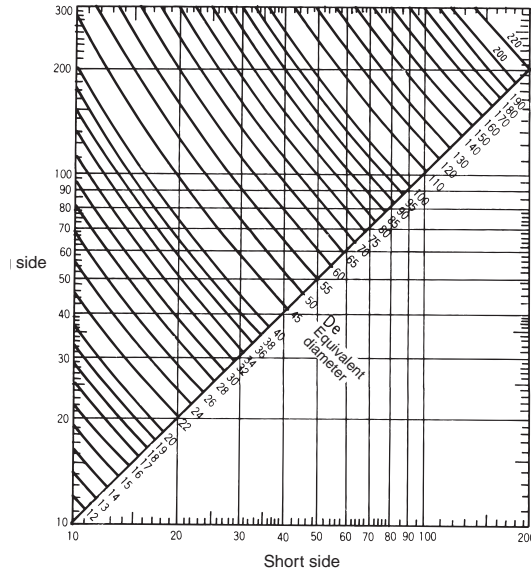

<How to use the chart>

Example) A rectangular duct of 40×200 is equivalent to a round duct of 90 in diameter.

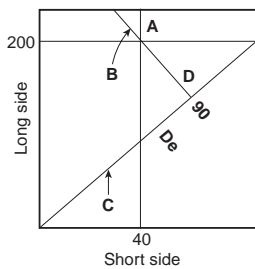

I) Find the intersection of the short side 40 and long side 200 : Point **A**.

II) Draw the line **B** passing through Point **A** until it intersects with the slant line **C** : Point **D**.

This is the equivalent diameter. In this case, the diameter is 90.

### 11 - 3 - 3 Pressure Loss Due to Local Features

1. Local feature loss coefficient (local feature resistance coefficient)

Bends, and sections where the sectional area is suddenly changed, have, unlike straight sections, particular types of pressure losses due to eddy current and other factors. The pressure loss of these non-straight parts is given by the following equation.

$$\Delta P \text{ (Pa)} = \zeta \cdot \gamma \frac{V^2}{2g} = \zeta \cdot P_v$$

Where  $\zeta$  : Local loss coefficient

$v$  : Air velocity.....[m/s]

\* This is the velocity measured at the upstream side of the feature except junctions.

$P_v$  : Dynamic pressure.....[Pa]

2. Calculation of pressure loss due to local features

(Example) Bend as shown in the figure

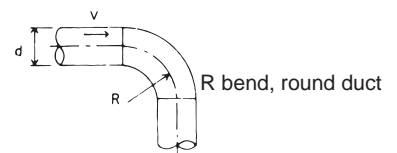

[Conditions]  $\frac{R}{d} = 1.5$       $v = 5.0$  [m/s]

$\zeta = 24$

$P_v = \frac{V^2}{2g}$       $\gamma = \frac{25}{2} \times 1.2$

$P_v = 1.53$  [Pa]

$\Delta P = \zeta$  (Local loss coefficient)  $\times P_v$  (Dynamic pressure)  
 $= 0.24 \times 1.5326 = 0.37$  Pa

# 11 Appendix

## 11 - 3 Calculation of Duct Pressure Loss

### 11 - 3 - 3 Pressure Loss Due tot Local Features

The right column of Table A shows the duct diameter equivalent to this pressure loss of the local feature. Note that the values shown in the table are for  $\lambda = 0.018$ . For other values of the friction resistance coefficient ( $\lambda$ ) to be used, use the following equation to find appropriate conversion.

$$l_e = \frac{\zeta}{\lambda} d$$

$l_e$  : equivalent straight pipe length of partial resistance...[m]  
 $d$  : straight pipe diameter.....[m]  
 $\zeta$  : Local loss coefficient

**Table A**

No.	Name	Sketch	Status		Loss coefficient $\zeta$
			H/W	R/dR/W	
1	R bend, round duct		-	0.5	0.90
				0.75	0.45
				1.0	0.33
				1.5	0.24
				2.0	0.19
2	Straight bend, round duct		-	-	1.30
3	R bend, rectangular duct		0.25	0.5	1.25
				0.75	0.60
				1.0	0.37
				1.5	0.19
				0.5	1.10
			0.5	0.75	0.50
				1.0	0.28
				1.5	0.13
			1.0	0.5	1.00
				0.75	0.41
				1.0	0.22
				1.5	0.09
				4.0	0.5
			0.75		0.37
			1.0		0.19
4.0	1.5	0.07			
	0.25	1.25			
	0.5	1.47			
	1.0	1.50			
4	Straight bend, rectangular duct		-	4.0	1.38
				0.25	1.25
				0.5	1.47
				1.0	1.50
5	Pipe inlet (with round hood)		theta	20°	0.02
				40°	0.03
				60°	0.05
				90°	0.11
				120°	0.20
6	Pipe inlet (with rectangular hood)		theta	20°	0.13
				40°	0.08
				60°	0.12
				90°	0.19
				120°	0.27

# 11 Appendix

## 11 - 3 Calculation of Duct Pressure Loss

### 11 - 3 - 3 Pressure Loss Due tot Local Features

(Example)

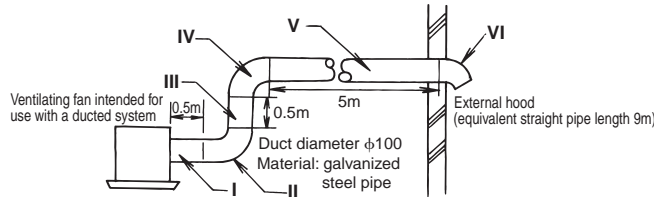

(For galvanized steel pipe with  $\lambda = 0.02$ , approximate value)

- To convert a local resistance to the equivalent straight pipe length, use the table A shown in the previous page.
- For this example, the equivalent length can be calculated as follows

Piping Art	Equivalent straight pipe length (pipe diameter 100)
I	0.5 m
II	2m
III	0.5m
IV	2m
V	5m
VI	9m
Total	19m

<Calculate from the equivalent straight pipe length (le) and air flow (Q)>

Example)

Equivalent straight pipe length : 19 m, Air flow : 120 [m<sup>3</sup>/h]

To find a ventilating fan that can satisfy these requirements, find the intersection of the pipe resistance curve for  $l_e$  : 19 [m] and the static pressure / air flow characteristics curve, and then draw a vertical line through the intersection **A** until it each the abscissa. The intersection **B** of the vertical line and abscissa shows the required air flow capacity of the fan. In this case, the fan rating capacity should be greater than 120 m<sup>3</sup>/h.

**Static pressure - air flow characteristics curve**

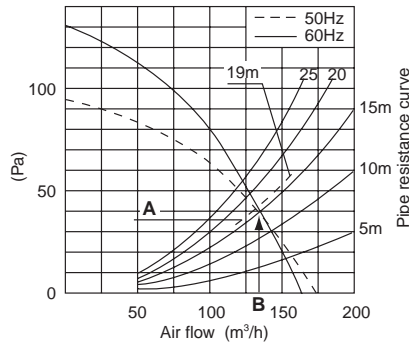

# 11 Appendix

## 11 - 4 Notes for Ducted Systems

- To connect the ventilation duct to a common (multipurpose) duct, use a 2 m-long steel leading duct or smoke reverse flow prevention damper per the regulations for the Building Standard Act. In the latter case, an inspection port should be installed on the ceiling so that the damper can be accessed through the port.

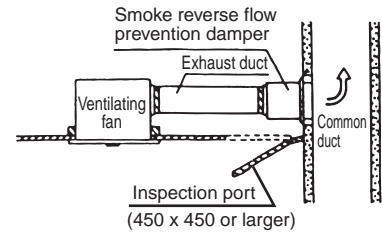

- If an intermediate fan is installed midway in the duct, an inspection port should be installed on the ceiling so that the fan can be accessed through the port.

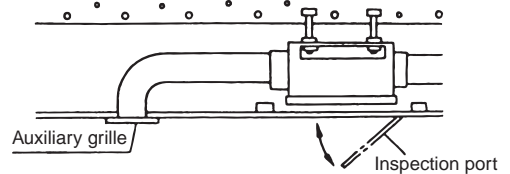

- The ducting examples shown in figures should be avoided. These invite larger noise and smaller air flow, and adversely affect the motor.

Deep bend



Unnecessarily many bends



Reduced size



Inclined connection



Bend located too close to the fan

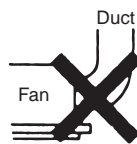

Bending the duct near the shutter frame may not permit the shutter to open completely. To avoid this, there should be a distance of minimum 150 mm between the bend and shutter.

To install a bellows, it should not be expanded near the connection

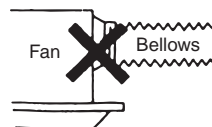

Each local rule or regulation may have different requirements for bellows. For details, consult the authorities. Connection to an aluminum flexible duct.

Bend located too close to the fan

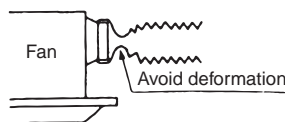

Deformed flexible duct may not permit the shutter to open completely.

- Depending on the room structure, the noise may increase by 8 to 10 phons due to echoes and/or other factors.
- To avoid entry of rainwater, exhaust ducts extending outside should be inclined down by 1/100 or larger.

# 11 Appendix

## 11 - 4 Notes for Ducted Systems

### 11 - 4 - 0 Notes for Ducted Systems

- To use a two-room ventilating fan for a bathroom and other room, install the fan in the bathroom. Two-room ventilating fans are designed so that the air flow through the main opening on the fan is about twice larger than that through the sub opening (for cases where the distance between the main and sub openings is about 1 m). However, this air flow proportion can be adjusted by moving the air flow adjusting plate located on the grille of the main unit.

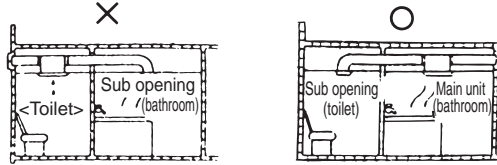

- Components that constitute the ceiling should be strong enough to prevent vibration and sympathetic sounds.  
Recommended material : gypsum board, cement excelsior board, fiber board
- Exhaust duct ends should be fitted with a vent cap or weather cover to prevent rainwater entry and bird nesting.
- In cold weather areas, the ducts should be thermal-insulated.

In cold weather areas, or in winter, condensation may occur due to the difference in temperature between the duct surroundings and living room. To avoid condensation, the ducting and their connections should be thermal-insulated.

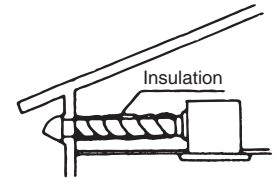

- Local rules and regulations may have special requirements for fire dampers and bellows. For details, consult the authorities.
- For bathrooms, use ventilating fans specially designed for bathroom use. Never fail to earth the fan.
- Electric wiring should be done by a qualified electrician (electric engineering firm). High-voltage connections are dangerous.

# 11 Appendix

## 11 - 5 How to use Psychrometric Chart

### 11 - 5 - 1 Unit conversion tables

- Btu/h =kcal/h x 3.97
- kW =kcal/h x 1/860
- Inches =mm x 0.0394
- Pounds =kg x 2.205
- Psi =kgf/cm<sup>2</sup>
- KPa =kgf/cm<sup>2</sup> x 14.22
- Cfm =m<sup>3</sup>/min x 35.3
- US Gallons =Liter x 0.264
- UK Gallons =Liter x 0.220

#### ■ General conversion tables

##### Pressure

bar	kgf/cm <sup>2</sup>	lb/in <sup>2</sup>	OZ/in <sup>2</sup>	British atm	Mercury (0°C)	
					mm	in
1	1.0197	14.50	2320	0.9869	750.0	29.53
0.980667	1	14.223	2275.66	0.9678	735.5	28.96
0.06895	0.07031	1	16	0.06804	51.71	0.0355
0.0 <sub>2</sub> 4309	0.0 <sub>2</sub> 4394	0.0625	1	0.0 <sub>2</sub> 4252	3.232	0.1276
1.0113	1.0333	14.70	235.2	1	760	29.921
1.3333	1.3596	19.34	309.4	1.316	1000	39.37
0.03386	0.0 <sub>2</sub> 453	0.4912	7.859	0.03342	25.4	1

##### Velocity

m/sec	m/min	km/hr	ft/sec	ft/min	mile/hr	Knot
1	60	3.6	3.28091	196.854	2.23698	1.9426
0.016667	1	0.06	0.05468	3.28091	0.03728	0.03237
0.27778	16.66667	1	0.91136	54.6815	0.62138	0.53962
0.30479	18.2874	1.09725	1	60	0.68182	0.59211
0.0 <sub>2</sub> 50798	0.30479	0.018287	0.016667	1	0.011364	0.0 <sub>3</sub> 98684
0.44703	26.8215	1.60931	1.46667	88	1	0.86842
0.51478	30.8867	1.8532	1.68889	101.337	1.15152	1

##### Area

mm <sup>2</sup>	cm <sup>2</sup>	m <sup>2</sup>	in <sup>2</sup>	ft <sup>2</sup>	yd <sup>2</sup>
1	0.01	0.000001	0.00155	—	—
100	1	0.0001	0.15501	0.0010764	0.0 <sub>3</sub> 1196
10×10 <sup>5</sup>	10×10 <sup>3</sup>	1	1550.1	10.7643	1.196
645.14	6.4514	0.0 <sub>3</sub> 64514	1	0.006944	0.0 <sub>3</sub> 7716
92900	92.9	0.0929	144	1	0.11111
836090	8360.9	0.83609	1296	9	1

##### Weight

mg	g	kg	grain	oz	lb
1	0.001	0.0 <sub>5</sub> 1	0.015432	0.0435274	0.0 <sub>5</sub> 22046
1000	1	0.001	15.4324	0.035274	0.0 <sub>2</sub> 22046
10×10 <sup>5</sup>	1000	1	15432.4	35.27394	2.20462
64.799	0.064799	0.0 <sub>4</sub> 64799	1	0.0 <sub>7</sub> 22857	0.0 <sub>3</sub> 14286
28349.5	28.34954	0.028349	437.5	1	0.0625
453592	453.592	0.45359	7000	16	1

# 11 Appendix

## 11 - 5 How to use Psychrometric Chart

### 11 - 5 - 1 Unit conversion tables

#### Length

m	km	ft	yd	mile
1	0.001	3.2809	1.09363	0.00062
1000	1	3280.9	1093.63	0.62138
0.30479	0.033048	1	0.33333	0.031894
0.91438	0.039144	3	1	0.035682
1609.31	1.60931	5280	1760	1

#### Flow rate

l/sec	l/min	m <sup>3</sup> /hr	m <sup>3</sup> /min	m <sup>3</sup> /sec	British gal/min	U.S. gal/min	ft <sup>3</sup> /hr	ft <sup>3</sup> /min	ft <sup>3</sup> /sec
1	60	3.6	0.06	0.001	13.197	15.8514	127.14	2.119	0.035317
0.01666	1	0.06	0.001	0.0416666	0.21995	0.26419	2.119	0.035317	0.035886
0.27777	16.666	1	0.016666	0.0327777	3.66583	4.40316	35.3165	0.58861	0.029801
16.666	1000	60	1	0.016666	219.95	264.19	2119	35.3165	0.058861
1000	60×10 <sup>3</sup>	3600	60	1	13198	15851	127150	2119	35.3165
0.075775	4.5465	0.27279	0.0245465	0.0475775	1	1.20114	9.6342	0.16057	0.022676
0.063086	3.7852	0.22711	0.0237852	0.063086	0.83254	1	8.0208	0.13368	0.02228
0.027865	0.47188	0.028315	0.0347188	0.0578647	0.103798	0.12467	1	0.016666	0.032777
0.47188	28.3153	1.6989	0.028315	0.0347188	6.22786	7.48055	60	1	0.016666
28.3153	1698.9	101.935	1.6989	0.028315	373.6716	448.833	3600	60	1

Note: 0.041 = 0.00001



# 11 Appendix

## 11 - 5 How to use Psychrometric Chart

### 11 - 5 - 1 Unit conversion tables

■ SI unit used for refrigeration / air conditioning and conversion table

Amount	SI unit		JIS unit Other units		Units mainly used in integral multiple of 10 of SI unit	Units mainly used in integral multiple of 10 of unit used in combination with SI unit or of unit allowed use in combination	Remarks
Length	m	m	in	ft	km dm cm mm μm		
		1	39.37	3.281			
		0.0254	1	0.0833			
		0.3048	12.00	1			
Area	m <sup>2</sup>	m <sup>2</sup>	in <sup>2</sup>	ft <sup>2</sup>	km <sup>2</sup> dm <sup>2</sup> cm <sup>2</sup> mm <sup>2</sup>		
		1	1550.0	10.76			
		0.000652	1	0.006944			
		0.09290	144.0	1			
Volume	m <sup>3</sup>	m <sup>3</sup>	in <sup>3</sup>	ft <sup>3</sup>	dm <sup>3</sup> cm <sup>3</sup> mm <sup>3</sup>	kℓ=m <sup>3</sup> ℓ =10 <sup>3</sup> m <sup>3</sup> 1dℓ=10 <sup>4</sup> m <sup>3</sup> 1cℓ=10 <sup>5</sup> m <sup>3</sup>	
		1	61020	35.31			
		1.639×10 <sup>5</sup>	1	5.787×10 <sup>4</sup>			
		0.02832	1728	1			
Mass	kg	kg	lb		Mg g mg		
		1	2.205				
		0.4536	1				
Density	kg/m <sup>3</sup>	kg/m <sup>3</sup>	g/cm <sup>3</sup>	lb/ft <sup>3</sup>			
		1000	1	62.43			
		1	0.001	0.06243			
		16.02	0.01602	1			
Speed	m/s	m/s	ft/s			km/h 1km/h= $\frac{1}{3.6}$ m/s	
		1	3.281				
		0.3048	1				
Temperature	K (°C) (Kelvin) (Celsius)	K	°F				
		1	0.5555				
		1.8	1				
Force (weight)	N (Newton)	N	kgf	lb	MN kN mN μN		IN=1kg×1m/s <sup>2</sup>
		1	0.102	0.245			
		9.807	1	2.205			
		4.448	0.4536	1			
Pressure	Pa (Pascal)	Pa	kgf/cm <sup>2</sup>	lb/in <sup>2</sup> (psi)	GPa MPa kPa hPa mPa μPa		Pa=N/m <sup>2</sup> hPa=mmbar
		1	1.02×10 <sup>5</sup>	1.45×10 <sup>4</sup>			
		9.807×10 <sup>4</sup>	1	14.22			
		6.895×10 <sup>3</sup>	0.07031	1			
Work	J (Joule)	J	kcal	BTU	TJ GJ MJ kJ		
		1	2.39×10 <sup>4</sup>	9.478×10 <sup>3</sup>			
		4186.05	1	3.968			
		1055.1	0.252	1			

# 11 Appendix

## 11 - 5 How to use Psychrometric Chart

### 11 - 5 - 1 Unit conversion tables

■ Pressure conversion table

kgf/cm <sup>2</sup> G	MPaG	p.s.i.G	kgf/cm <sup>2</sup> G	MPaG	p.s.i.G	p.s.i.G	MPaG	kgf/cm <sup>2</sup> G	p.s.i.G	MpaG	kgf/cm <sup>2</sup> G
0.0	0.00	0.0	12.0	1.18	170.6	0	0.00	0.0	350	2.41	24.6
0.2	0.02	2.8	12.2	1.20	173.5	5	0.03	0.4	355	2.45	25.0
0.4	0.04	5.7	12.4	1.22	176.3	10	0.07	0.7	360	2.48	25.3
0.6	0.06	8.5	12.6	1.23	179.2	15	0.10	1.1	365	2.52	25.7
0.8	0.08	11.4	12.8	1.25	182.0	20	0.14	1.4	370	2.55	26.0
1.0	0.10	14.2	13.0	1.27	184.9	25	0.17	1.8	375	2.58	26.4
1.2	0.12	17.1	13.2	1.29	187.7	30	0.21	2.1	380	2.62	26.7
1.4	0.14	19.9	13.4	1.31	190.5	35	0.24	2.5	385	2.65	27.1
1.6	0.16	22.8	13.6	1.33	193.4	40	0.27	2.8	390	2.68	27.4
1.8	0.18	25.6	13.8	1.35	196.2	45	0.31	3.2	395	2.72	27.8
2.0	0.20	28.4	14.0	1.37	199.1	50	0.34	3.5	400	2.76	28.1
2.2	0.22	31.3	14.2	1.39	201.9	55	0.38	3.9	405	2.79	28.5
2.4	0.23	34.1	14.4	1.41	204.8	60	0.41	4.2	410	2.83	28.8
2.6	0.25	37.0	14.6	1.43	207.6	65	0.45	4.6	415	2.86	29.2
2.8	0.27	39.8	14.8	1.45	210.5	70	0.48	4.9	420	2.90	29.5
3.0	0.29	42.7	15.0	1.47	213.3	75	0.51	5.3	425	2.93	30.0
3.2	0.31	45.5	15.2	1.49	216.1	80	0.55	5.6	430	2.97	30.2
3.4	0.33	48.3	15.4	1.50	219.0	85	0.59	6.0	435	3.00	30.6
3.6	0.35	51.2	15.6	1.53	221.8	90	0.62	6.3	440	3.03	30.9
3.8	0.37	54.0	15.8	1.55	224.7	95	0.66	6.7	445	3.07	31.3
4.0	0.39	56.9	16.0	1.57	227.5	100	0.69	7.0	450	3.10	31.6
4.2	0.41	59.7	16.2	1.58	230.4	105	0.72	7.4	455	3.14	32.0
4.4	0.43	62.6	16.4	1.61	233.2	110	0.76	7.7	460	3.17	32.3
4.6	0.45	65.4	16.6	1.63	236.1	115	0.79	8.1	465	3.20	32.7
4.8	0.47	68.3	16.8	1.65	238.9	120	0.83	8.4	470	3.24	33.0
5.0	0.49	71.1	17.0	1.67	241.7	125	0.86	8.8	475	3.28	33.4
5.2	0.51	73.9	17.2	1.69	244.6	130	0.89	9.1	480	3.31	33.7
5.4	0.53	76.8	17.4	1.71	247.4	135	0.93	9.5	485	3.34	34.1
5.6	0.55	79.6	17.6	1.72	250.3	140	0.97	9.8	490	3.38	34.5
5.8	0.57	82.5	17.8	1.74	253.1	145	1.00	10.2	495	3.41	34.8
6.0	0.59	85.3	18.0	1.76	256.0	150	1.03	10.5	500	3.45	35.2
6.2	0.61	88.2	18.2	1.78	258.8	155	1.07	10.9	505	3.48	35.5
6.4	0.63	91.0	18.4	1.80	261.6	160	1.10	11.2	510	3.52	35.9
6.6	0.65	93.9	18.6	1.82	264.5	165	1.13	11.6	515	3.55	36.2
6.8	0.67	96.7	18.8	1.84	267.3	170	1.17	12.0	520	3.59	36.6
7.0	0.69	99.5	19.0	1.86	270.2	175	1.21	12.3	525	3.62	36.9
7.2	0.71	102.4	19.2	1.88	273.0	180	1.25	12.7	530	3.65	37.3
7.4	0.73	105.2	19.4	1.90	275.9	185	1.28	13.0	535	3.69	37.6
7.6	0.74	108.1	19.6	1.92	278.7	190	1.31	13.4	540	3.72	38.0
7.8	0.76	110.9	19.8	1.94	281.6	195	1.34	13.7	545	3.76	38.3
8.0	0.78	113.8	20.0	1.96	284.4	200	1.38	14.1	550	3.79	38.7
8.2	0.80	116.6	20.2	1.98	287.2	205	1.41	14.4	555	3.83	39.0
8.4	0.82	119.4	20.4	2.00	290.1	210	1.45	14.8	560	3.86	39.4
8.6	0.84	122.3	20.6	2.02	292.9	215	1.48	15.1	565	3.90	39.7
8.8	0.86	125.1	20.8	2.04	295.8	220	1.52	15.5	570	3.93	40.0
9.0	0.88	128.0	21.0	2.06	298.6	225	1.55	15.8	575	3.97	40.4
9.2	0.90	130.8	21.2	2.08	301.5	230	1.59	16.2	580	4.00	40.8
9.4	0.92	133.7	21.4	2.10	304.3	235	1.62	16.5	585	4.03	41.1
9.6	0.94	136.5	21.6	2.12	307.2	240	1.66	16.9	590	4.07	41.5
9.8	0.96	139.4	21.8	2.14	310.0	245	1.69	17.2	595	4.10	41.8
10.0	0.98	142.2	22.0	2.16	312.8	250	1.72	17.6	600	4.14	42.2
10.2	1.00	145.0	22.2	2.18	315.7	255	1.76	17.9	605	4.17	42.5
10.4	1.02	147.9	22.4	2.19	318.5	260	1.79	18.3	610	4.21	42.9
10.6	1.04	150.7	22.6	2.21	321.4	265	1.83	18.6	615	4.24	43.2
10.8	1.06	153.6	22.8	2.23	324.2	270	1.86	19.0	620	4.28	43.6
11.0	1.08	156.4	23.0	2.25	327.1	275	1.90	19.3	625	4.31	43.9
11.2	1.09	159.3	23.2	2.27	329.9	280	1.93	19.7	630	4.34	44.3
11.4	1.12	162.1	23.4	2.29	332.7	285	1.96	20.0	635	4.38	44.6
11.6	1.14	165.0	23.6	2.31	335.6	290	2.00	20.4	640	4.41	45.0
11.8	1.16	167.8	23.8	2.33	338.4	295	2.03	20.7	645	4.45	45.3
						300	2.07	21.1	650	4.48	45.7
						305	2.10	21.4	655	4.52	46.0
						310	2.13	21.8	660	4.55	46.4
						315	2.17	22.1	665	4.58	46.7
						320	2.20	22.5	670	4.62	47.1
						325	2.24	22.8	675	4.65	47.5
						330	2.27	23.2	680	4.68	47.8
						335	2.31	23.6	685	4.72	48.2
						340	2.34	23.9	690	4.75	48.5
						345	2.37	24.3	695	4.79	48.9

$p.s.i.=14.22 \times kgf/cm^2$   
 $kgf/cm^2=10.2 \times Mpa$   
 $kgf/cm^2=0.0703 \times p.s.i.$   
 $MPa=0.098 \times kgf/cm^2$   
 $p.s.i.=145.0 \times MPa$   
 $MPa=0.006896 \times p.s.i.$

**i** Note : This conversion system is based on GAUGE pressure.

# 11 Appendix

## 11 - 5 How to use Psychrometric Chart

### 11 - 5 - 1 Unit conversion tables

■ Temperature conversion table

°C → °F	°C → °F	°F → °C	°F → °C
-10	14.0	50	122.0
-9	15.8	51	123.8
-8	17.6	52	125.6
-7	19.4	53	127.4
-6	21.2	54	129.2
-5	23.0	55	131.0
-4	24.8	56	132.8
-3	26.6	57	134.6
-2	28.4	58	136.4
-1	30.2	59	138.2
0	32.0	60	140.0
1	33.8	61	141.8
2	35.6	62	143.6
3	37.4	63	145.4
4	39.2	64	147.2
5	41.0	65	149.0
6	42.8	66	150.8
7	44.6	67	152.6
8	46.4	68	154.4
9	48.2	69	156.2
10	50.0	70	158.0
11	51.8	71	159.8
12	53.6	72	161.6
13	55.4	73	163.4
14	57.2	74	165.2
15	59.0	75	167.0
16	60.8	76	168.8
17	62.6	77	170.6
18	64.4	78	172.4
19	66.2	79	174.2
20	68.0	80	176.0
21	69.8	81	177.8
22	71.6	82	179.6
23	73.4	83	181.4
24	75.2	84	183.2
25	77.0	85	185.0
26	78.8	86	186.8
27	80.6	87	188.6
28	82.4	88	190.4
29	84.2	89	192.2
30	86.0	90	194.0
31	87.8	91	195.8
32	89.6	92	197.6
33	91.4	93	199.4
34	93.2	94	201.2
35	95.0	95	203.0
36	96.8	96	204.8
37	98.6	97	206.6
38	100.4	98	208.4
39	102.2	99	210.2
40	104.0	100	212.0
41	105.8	101	213.8
42	107.6	102	215.6
43	109.4	103	217.4
44	111.2	104	219.2
45	113.0	105	221.0
46	114.8	106	222.8
47	116.6	107	224.6
48	118.4	108	226.4
49	120.2	109	228.2
0	-17.8	120	48.9
2	-16.7	122	50.0
4	-15.6	124	51.1
6	-14.4	126	52.2
8	-13.3	128	53.3
10	-12.2	130	54.4
12	-11.1	132	55.6
14	-10.0	134	56.7
16	-8.9	136	57.8
18	-7.8	138	58.9
20	-6.7	140	60.0
22	-5.6	142	61.1
24	-4.4	144	62.2
26	-3.3	146	63.3
28	-2.2	148	64.4
30	-1.1	150	65.6
32	0.0	152	66.7
34	1.1	154	67.8
36	2.2	156	68.9
38	3.3	158	70.0
40	4.4	160	71.1
42	5.6	162	72.2
44	6.7	164	73.3
46	7.8	166	74.4
48	8.9	168	75.6
50	10.0	170	76.7
52	11.1	172	77.8
54	12.2	174	78.9
56	13.3	176	80.0
58	14.4	178	81.1
60	15.6	180	82.2
62	16.7	182	83.3
64	17.8	184	84.4
66	18.9	186	85.6
68	20.0	188	86.7
70	21.1	190	87.8
72	22.2	192	88.9
74	23.3	194	90.0
76	24.4	196	91.1
78	25.6	198	92.2
80	26.7	200	93.3
82	27.8	202	94.4
84	28.9	204	95.6
86	30.0	206	96.7
88	31.1	208	97.8
90	32.2	210	98.9
92	33.3	212	100.0
94	34.4	214	101.1
96	35.6	216	102.2
98	36.7	218	103.3
100	37.8	220	104.4
102	38.9	222	105.6
104	40.0	224	106.7
106	41.1	226	107.8
108	42.2	228	108.9
110	43.3	230	110.0
112	44.4	232	111.1
114	45.6	234	112.2
116	46.7	236	113.3
118	47.8	238	114.4

\*F=9/5\*°C+32

\*C=(F-32)×5/9

# 11 Appendix

## 11 - 5 How to use Psychrometric Chart

### 11 - 5 - 2 Refrigerant

#### ■ Fluorocarbon and global environment

Influence of refrigerant given on global environment

#### 1. Ozone layer destruction

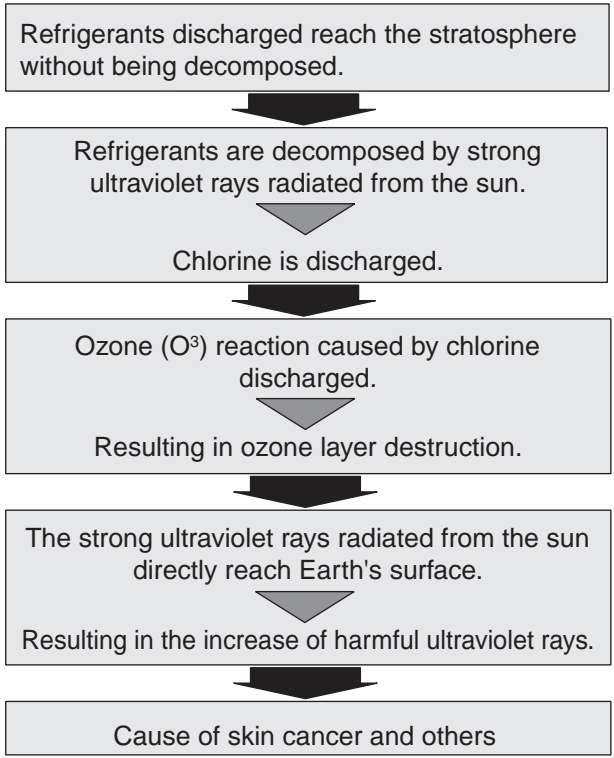
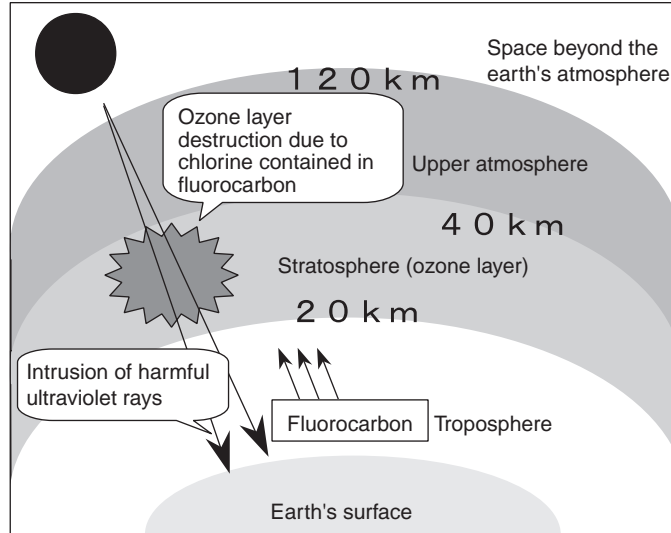

# 11 Appendix

## 11 - 5 How to use Psychrometric Chart

### 11 - 5 - 2 Refrigerant

#### 2. Global warming

(Principle)

Due to the results of human activities such as a large quantity of consumption of petrochemical fuels (e.g. petroleum, coal, and natural gas) and forest destruction, carbon dioxide, chlorofluorocarbon, methane, and others in the atmosphere have been increasing beyond the limit that natural force can remove them.

As a result, the dissipation of heat from Earth's surface is interrupted (greenhouse effect), thus resulting in global warming.

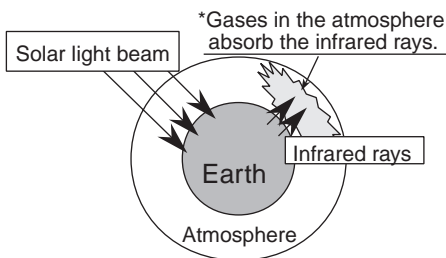

Carbon dioxide, fluorocarbon, methane, nitride, and others are released from Earth's surface.



Infrared rays (heat rays) from Earth's surface are absorbed.



Heat (temperature) cannot be dissipated from Earth's surface.



Resulting in temperature rise and sea level rise.

# 11 Appendix

## 11 - 5 How to use Psychrometric Chart

### 11 - 5 - 2 Refrigerant

■ Refrigerant R-410A saturation curve

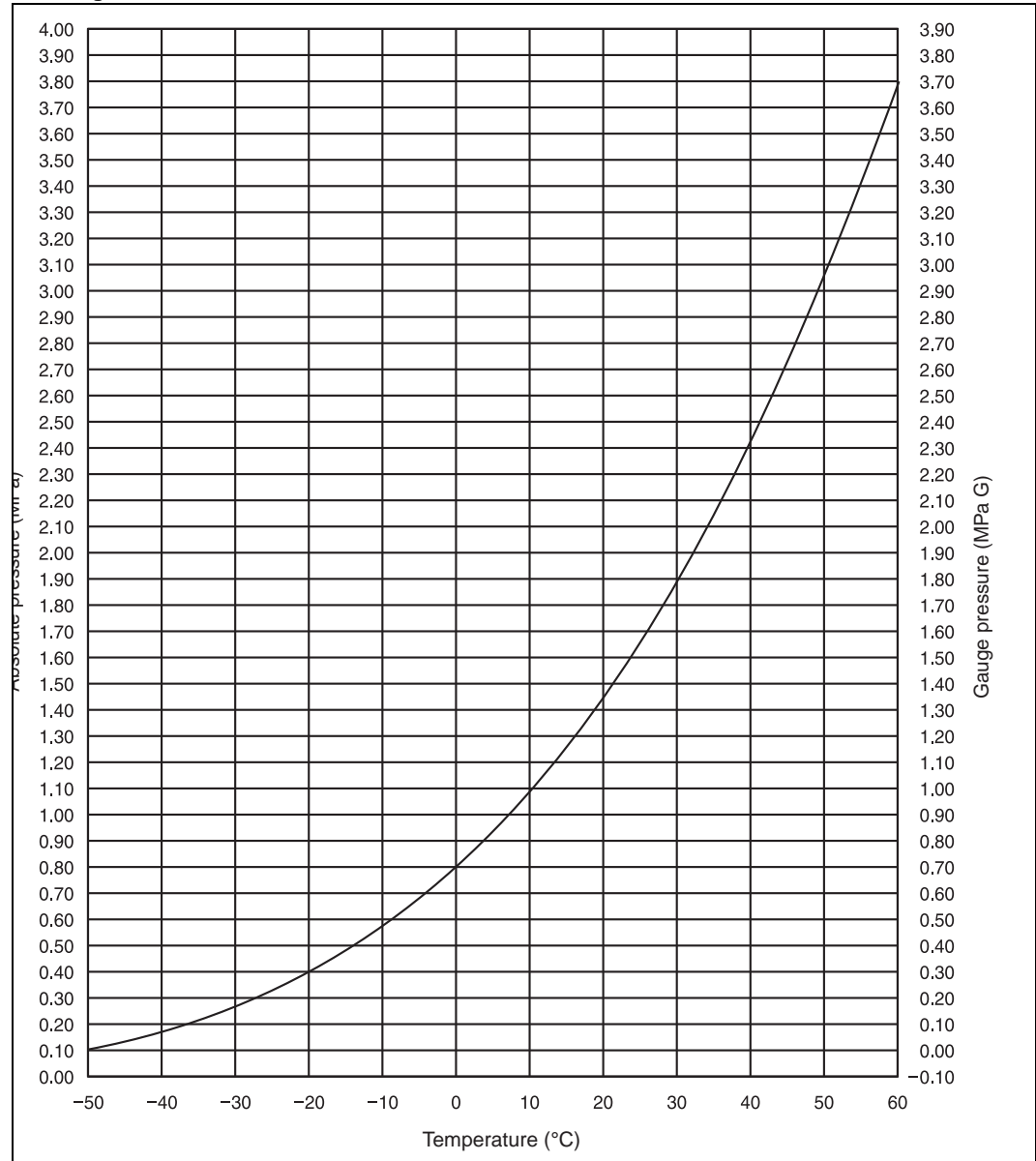

# 11 Appendix

## 11 - 5 How to use Psychrometric Chart

### 11 - 5 - 2 Refrigerant

■ R-410A Saturation pressure (gauge pressure) chart

Press. MpaG	Temp °C	Press. MpaG	Temp °C	Press. MpaG	Temp °C
0	-51.58	0.9	7	3.49	57
0.06	-42	0.93	8	3.57	58
0.07	-41	0.97	9	3.65	59
0.08	-40	1	10	3.73	60
0.085	-39	1.03	11	3.82	61
0.09	-38	1.06	12	3.9	62
0.1	-37	1.09	13	3.99	63
0.11	-36	1.12	14	4.08	64
0.12	-35	1.16	15		
0.13	-34	1.2	16		
0.14	-33	1.24	17		
0.15	-32	1.27	18		
0.16	-31	1.31	19		
0.17	-30	1.35	20		
0.18	-29	1.39	21		
0.19	-28	1.43	22		
0.21	-27	1.48	23		
0.22	-26	1.52	24		
0.23	-25	1.56	25		
0.24	-24	1.6	26		
0.26	-23	1.65	27		
0.27	-22	1.7	28		
0.29	-21	1.75	29		
0.3	-20	1.79	30		
0.32	-19	1.84	31		
0.33	-18	1.89	32		
0.35	-17	1.92	33		
0.36	-16	1.94	34		
0.38	-15	2.02	35		
0.4	-14	2.1	36		
0.42	-13	2.16	37		
0.43	-12	2.21	38		
0.45	-11	2.27	39		
0.47	-10	2.33	40		
0.49	-9	2.39	41		
0.51	-8	2.45	42		
0.54	-7	2.51	43		
0.56	-6	2.57	44		
0.58	-5	2.64	45		
0.6	-4	2.7	46		
0.63	-3	2.77	47		
0.65	-2	2.83	48		
0.68	-1	2.9	49		
0.7	0	2.97	50		
0.73	1	3.04	51		
0.75	2	3.11	52		
0.78	3	3.19	53		
0.81	4	3.26	54		
0.84	5	3.34	55		
0.87	6	3.41	56		

# 11 Appendix

## 11 - 5 How to use Psychrometric Chart

### 11 - 5 - 2 Refrigerant

■ Thermodynamic characteristics of R-410A

Temperature (°C)	Steam pressure (kPa)		Density (kg/m <sup>3</sup> )		Specific heat at constant pressure (kJ/kgK)		Specific enthalpy (kJ/kg)		Specific entropy (kJ/kgK)	
	Liquid	Vapor	Liquid	Vapor	Liquid	Vapor	Liquid	Vapor	Liquid	Vapor
-70	36.13	36.11	1410.7	1.582	1.372	0.695	100.8	390.6	0.649	2.074
-68	40.83	40.80	1404.7	1.774	1.374	0.700	103.6	391.8	0.663	2.066
-66	46.02	45.98	1398.6	1.984	1.375	0.705	106.3	393.0	0.676	2.058
-64	51.73	51.68	1392.5	2.213	1.377	0.710	109.1	394.1	0.689	2.051
-62	58.00	57.94	1386.4	2.463	1.378	0.715	111.9	395.3	0.702	2.044
-60	64.87	64.80	1380.2	2.734	1.379	0.720	114.6	396.4	0.715	2.037
-58	72.38	72.29	1374.0	3.030	1.380	0.726	117.4	397.6	0.728	2.030
-56	80.57	80.46	1367.8	3.350	1.382	0.732	120.1	398.7	0.741	2.023
-54	89.49	89.36	1361.6	3.696	1.384	0.737	122.9	399.8	0.754	2.017
-52	99.18	99.03	1355.3	4.071	1.386	0.744	125.7	400.9	0.766	2.010
-51.58	101.32	101.17	1354.0	4.153	1.386	0.745	126.3	401.1	0.769	2.009
-50	109.69	109.51	1349.0	4.474	1.388	0.750	128.5	402.0	0.779	2.004
-48	121.07	120.85	1342.7	4.909	1.391	0.756	131.2	403.1	0.791	1.998
-46	133.36	133.11	1336.3	5.377	1.394	0.763	134.0	404.1	0.803	1.992
-44	146.61	146.32	1330.0	5.880	1.397	0.770	136.8	405.2	0.816	1.987
-42	160.89	160.55	1323.5	6.419	1.401	0.777	139.6	406.2	0.828	1.981
-40	176.24	175.85	1317.0	6.996	1.405	0.785	142.4	407.3	0.840	1.976
-38	192.71	192.27	1310.5	7.614	1.409	0.792	145.3	408.3	0.852	1.970
-36	210.37	209.86	1304.0	8.275	1.414	0.800	148.1	409.3	0.864	1.965
-34	229.26	228.69	1297.3	8.980	1.419	0.809	150.9	410.2	0.875	1.960
-32	249.46	248.81	1290.6	9.732	1.424	0.817	153.8	411.2	0.887	1.955
-30	271.01	270.28	1283.9	10.53	1.430	0.826	156.6	412.1	0.899	1.950
-28	293.99	293.16	1277.1	11.39	1.436	0.835	159.5	413.1	0.911	1.946
-26	318.44	317.52	1270.2	12.29	1.442	0.844	162.4	414.0	0.922	1.941
-24	344.44	343.41	1263.3	13.26	1.448	0.854	165.3	414.9	0.934	1.936
-22	372.05	370.90	1256.3	14.28	1.455	0.864	168.2	415.7	0.945	1.932
-20	401.34	400.06	1249.2	15.37	1.461	0.876	171.1	416.6	0.957	1.927
-18	432.36	430.95	1242.0	16.52	1.468	0.886	174.1	417.4	0.968	1.923
-16	465.20	463.64	1234.8	17.74	1.476	0.897	177.0	418.2	0.980	1.919
-14	499.91	498.20	1227.5	19.04	1.483	0.909	180.0	419.0	0.991	1.914
-12	536.58	534.69	1220.0	20.41	1.491	0.921	182.9	419.8	1.003	1.910
-10	575.26	573.20	1212.5	21.86	1.499	0.933	185.9	420.5	1.014	1.906
-8	616.03	613.78	1204.9	23.39	1.507	0.947	189.0	421.2	1.025	1.902
-6	658.97	656.52	1197.2	25.01	1.516	0.960	192.0	421.9	1.036	1.898
-4	704.15	701.49	1189.4	26.72	1.524	0.975	195.0	422.6	1.048	1.894
-2	751.64	748.76	1181.4	28.53	1.533	0.990	198.1	423.2	1.059	1.890
0	801.52	798.41	1173.4	30.44	1.543	1.006	201.2	423.8	1.070	1.886
2	853.87	850.52	1165.3	32.46	1.552	1.022	204.3	424.4	1.081	1.882
4	908.77	905.16	1157.0	34.59	1.563	1.039	207.4	424.9	1.092	1.878
6	966.29	962.42	1148.6	36.83	1.573	1.057	210.5	425.5	1.103	1.874
8	1026.5	1022.4	1140.0	39.21	1.584	1.076	213.7	425.9	1.114	1.870
10	1089.5	1085.1	1131.3	41.71	1.596	1.096	216.8	426.4	1.125	1.866
12	1155.4	1150.7	1122.5	44.35	1.608	1.117	220.0	426.8	1.136	1.862
14	1224.3	1219.2	1113.5	47.14	1.621	1.139	223.2	427.2	1.147	1.859
16	1296.2	1290.8	1104.4	50.09	1.635	1.163	226.5	427.5	1.158	1.855
18	1371.2	1365.5	1095.1	53.20	1.650	1.188	229.7	427.8	1.169	1.851
20	1449.4	1443.4	1085.6	56.48	1.666	1.215	233.0	428.1	1.180	1.847
22	1530.9	1524.6	1075.9	59.96	1.683	1.243	236.4	428.3	1.191	1.843
24	1615.8	1609.2	1066.0	63.63	1.701	1.273	239.7	428.4	1.202	1.839
26	1704.2	1697.2	1055.9	67.51	1.721	1.306	243.1	428.6	1.214	1.834
28	1796.2	1788.9	1045.5	71.62	1.743	1.341	246.5	428.6	1.225	1.830
30	1891.9	1884.2	1034.9	75.97	1.767	1.379	249.9	428.6	1.236	1.826
32	1991.3	1983.2	1024.1	80.58	1.793	1.420	253.4	428.6	1.247	1.822
34	2094.5	2086.2	1012.9	85.48	1.822	1.465	256.9	428.4	1.258	1.817
36	2201.7	2193.1	1001.4	90.68	1.855	1.514	260.5	428.3	1.269	1.813
38	2313.0	2304.0	989.5	96.22	1.891	1.569	264.1	428.0	1.281	1.808
40	2428.4	2419.2	977.3	102.1	1.932	1.629	267.8	427.7	1.292	1.803
42	2548.1	2538.6	964.6	108.4	1.979	1.696	271.5	427.2	1.303	1.798
44	2672.2	2662.4	951.4	115.2	2.033	1.771	275.3	426.7	1.315	1.793
46	2800.7	2790.7	937.7	122.4	2.095	1.857	279.2	426.1	1.327	1.788
48	2933.7	2923.6	923.3	130.2	2.168	1.955	283.2	425.4	1.339	1.782
50	3071.5	3061.2	908.2	138.6	2.256	2.069	287.3	424.5	1.351	1.776
52	3214.0	3203.6	892.2	147.7	2.362	2.203	291.5	423.5	1.363	1.770
54	3361.4	3351.0	875.1	157.6	2.493	2.363	295.8	422.4	1.376	1.764
56	3513.8	3503.5	856.8	168.4	2.661	2.557	300.3	421.0	1.389	1.757
58	3671.3	3661.2	836.9	180.4	2.883	2.799	305.0	419.4	1.403	1.749
60	3834.1	3824.2	814.9	193.7	3.191	3.106	310.0	417.6	1.417	1.741
62	4002.1	3992.7	790.1	208.6	3.650	3.511	315.3	415.5	1.433	1.732
64	4175.7	4166.8	761.0	225.6	4.415	4.064	321.2	413.0	1.450	1.722

(Z0168)



# 11 Appendix

## 11 - 5 How to use Psychrometric Chart

### 11 - 5 - 2 Refrigerant

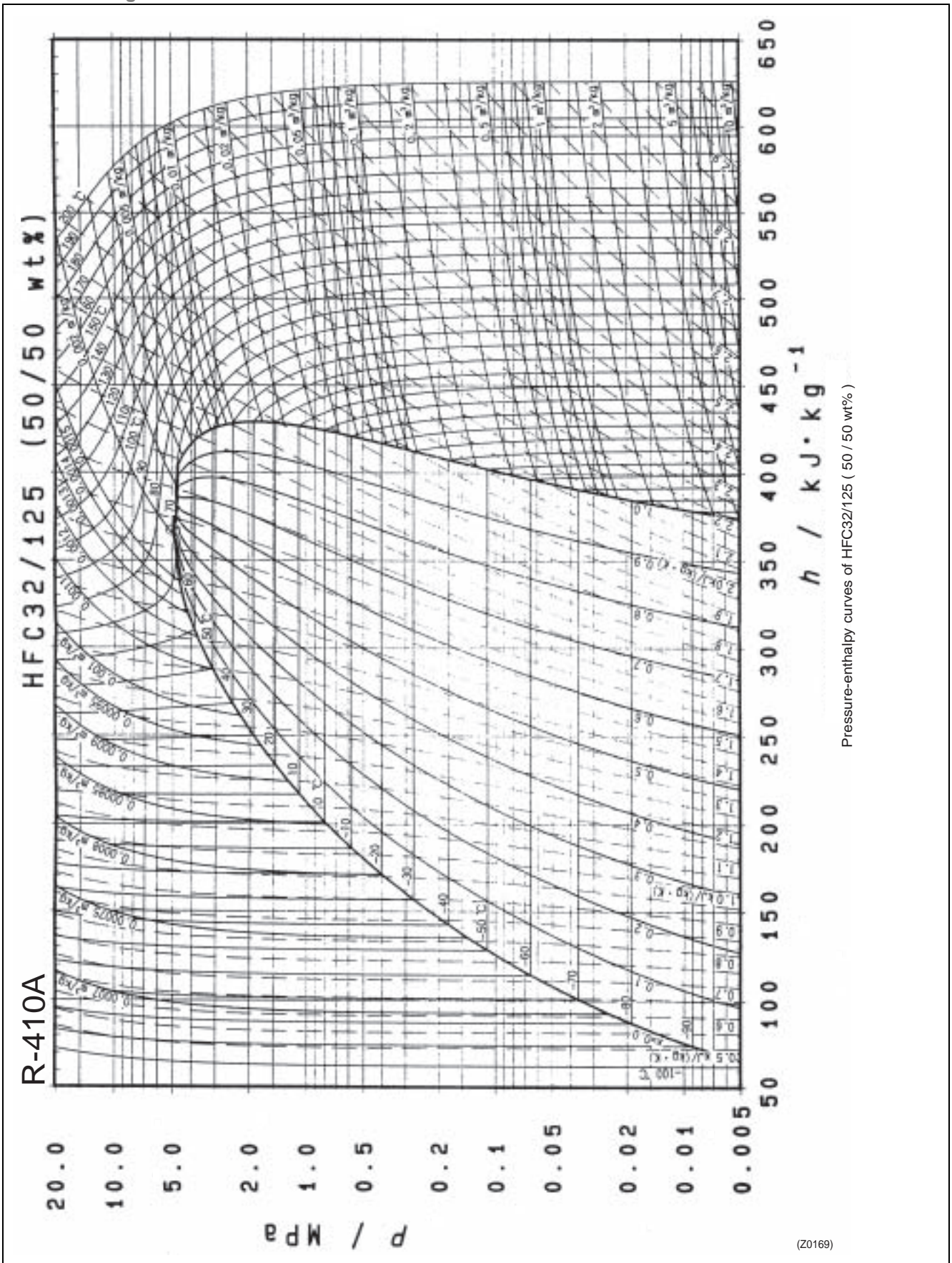

# 11 Appendix

## 11 - 5 How to use Psychrometric Chart

### 11 - 5 - 3 Psychrometric Chart

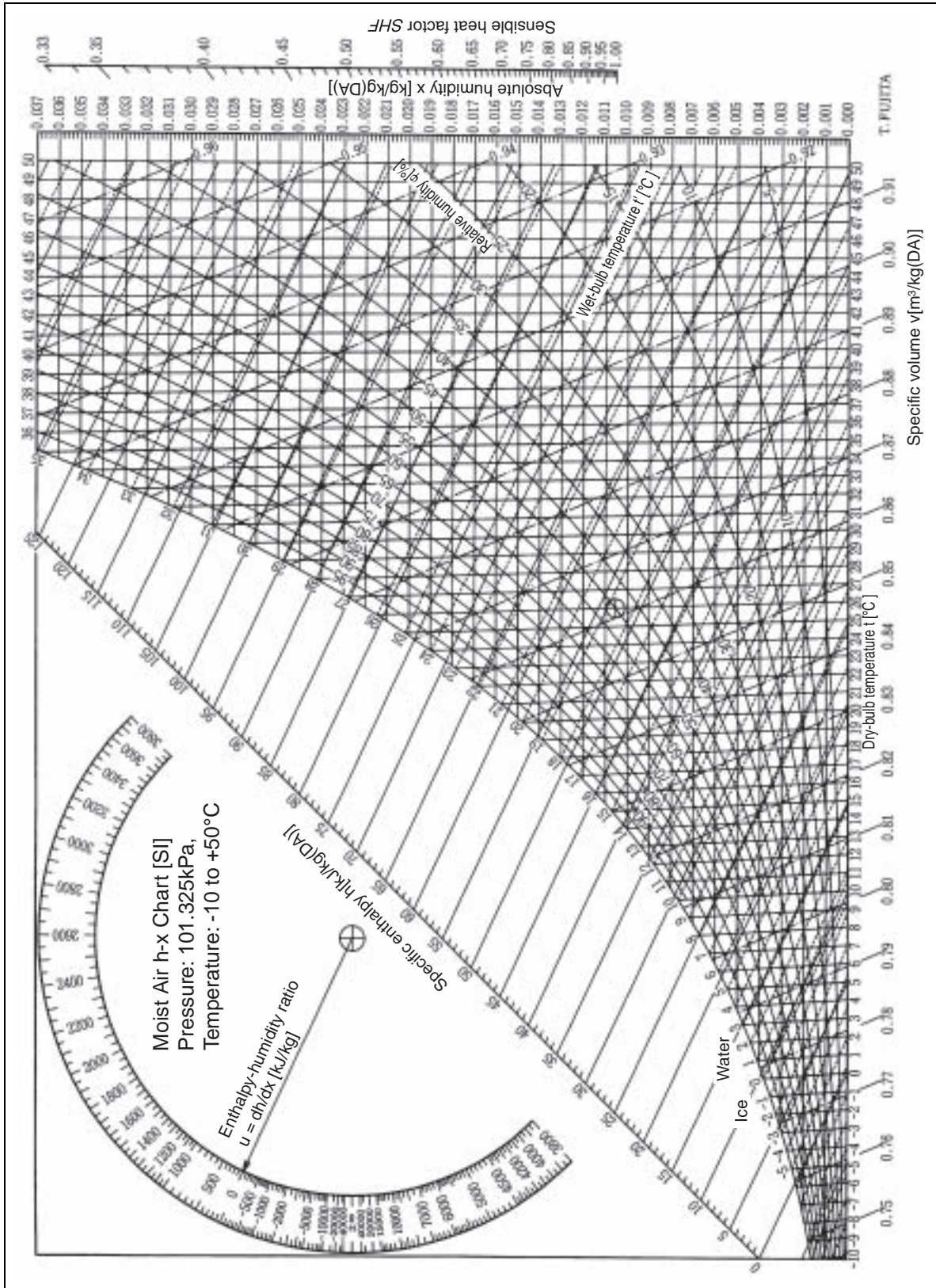

# 3

## Ventilation



Daikin's unique position as a manufacturer of air conditioning equipment, compressors and refrigerants has led to its close involvement in environmental issues. For several years Daikin has had the intension to become a leader in the provision of products that have limited impact on the environment. This challenge demands the eco design and development of a wide range of products and an energy management system, resulting in energy conservation and a reduction of waste.



Daikin Europe N.V. is approved by LRQA for its Quality Management System in accordance with the ISO9001 standard. ISO9001 pertains to quality assurance regarding design, development, manufacturing as well as to services related to the product.



ISO14001 assures an effective environmental management system in order to help protect human health and the environment from the potential impact of our activities, products and services and to assist in maintaining and improving the quality of the environment.



Daikin units comply with the European regulations that guarantee the safety of the product.

The present publication is drawn up by way of information only and does not constitute an offer binding upon Daikin Europe N.V.. Daikin Europe N.V. has compiled the content of this publication to the best of its knowledge. No express or implied warranty is given for the completeness, accuracy, reliability or fitness for particular purpose of its content and the products and services presented therein. Specifications are subject to change without prior notice. Daikin Europe N.V. explicitly rejects any liability for any direct or indirect damage. In the broadest sense, arising from or related to the use and/or interpretation of this publication. All content is copyrighted by Daikin Europe N.V..

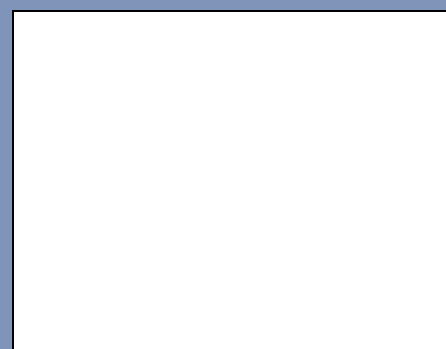

### DAIKIN EUROPE N.V.

Naamloze Vennoetschap  
Zandvoordestraat 300  
B-8400 Oostende, Belgium  
www.daikin.eu  
BTW: BE 0412 120 336  
RPR Oostende

VRV® products are not within the scope of the Eurovent certification programme.

EEDEN08-205 • 04/2008 • Copyright © Daikin  
The present publication supersedes EEDEN07-201  
Prepared in Belgium by Lannoo (www.lannooprint.be), a company whose concern for the environment is set in the EMAS and ISO 14001 systems.  
Responsible Editor: Daikin Europe N.V., Zandvoordestraat 300, B- 8400 Oostende

