

Remote Management Card

RMCARD205

RMCARD305

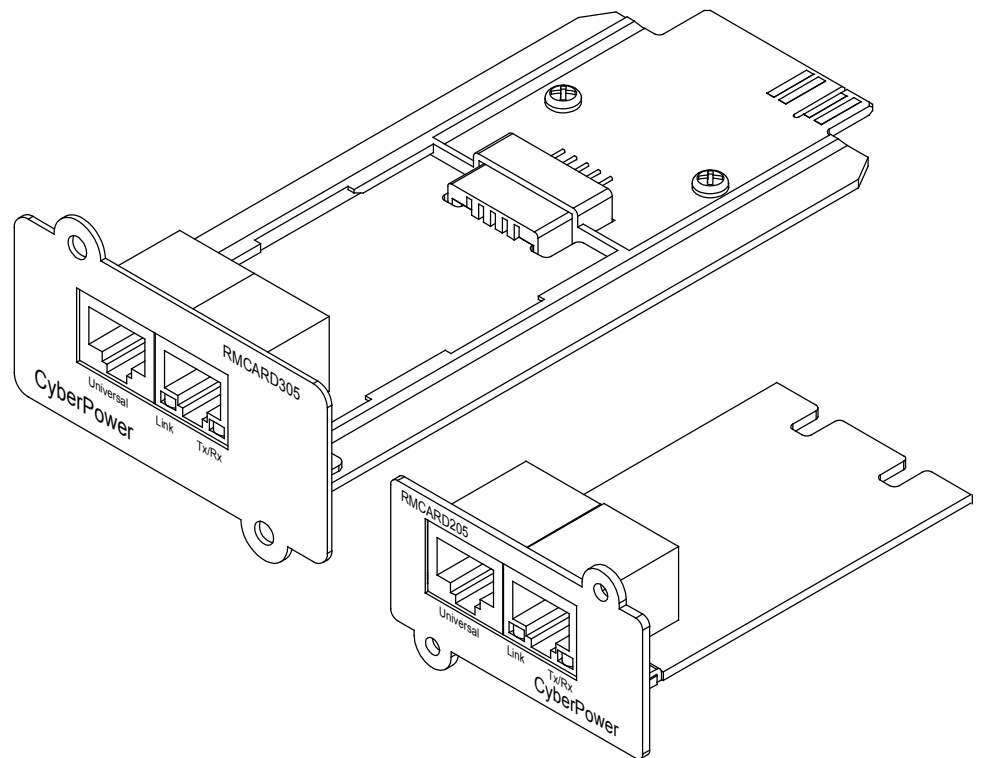

SAVE THESE INSTRUCTIONS

Please read this guide and follow the instructions for installation and use.

Table of Contents

INTRODUCTION.....	1
Overview	1
System Requirements	1
Unpacking	1
Front Panel	2
LED Status Indicator	2
INSTALLATION	3
Step 1. Hardware Installation	3
Step 2. Configure the IP Address	4
WEB INTERFACE	6
Login User Account	6
FIRMWARE UPGRADE	6
Using Upgrade and Configuration Utility Tool	7
RESET TO FACTORY DEFAULT SETTING/ RECOVER FROM A LOST PASSWORD	10
RMCARD ADAPTER GUIDE	11
SOFTWARE SUPPORT	13
TROUBLESHOOTING	14
CONFORMANCE APPROVALS	15

INTRODUCTION

Overview

The CyberPower Remote Management Card allows a UPS/ATS PDU system and environmental sensor to be managed, monitored, and configured. After installing the hardware and configuring an IP address, the user can access, monitor, and control the UPS/ATS PDU from anywhere in the world! Simply use a web browser or SSH client to access your UPS/ATS PDU. Servers and workstations can be protected by the UPS utilizing PowerPanel® Business Edition Client to gracefully shutdown when signaled by the Remote Management Card.

System Requirements

- A 10/100Mbps Ethernet connection to an existing network
- Web Browser or SSH client
- (Optional) NMS (Network Management System) compliant with SNMP

Unpacking

Inspect the Remote Management Card upon receipt. The package should contain the following:

- CyberPower Remote Management Card
- RJ45/DB9 Serial Port Connection Cable
- Quick Start Guide
- Spare Jumper
- RMCARD205 Front Panel (with RMCARD305 only)

Front Panel

RMCARD205

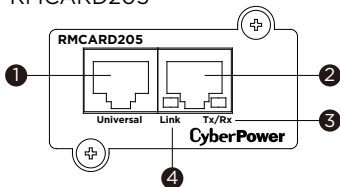

RMCARD305

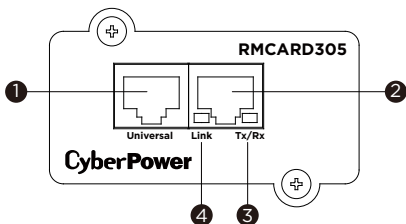

1. Universal Port
2. Ethernet Port
3. Tx/Rx Indicator
4. Link Indicator

LED Status Indicators

Link LED	Condition
Off	The Remote Management Card is not connected to the Network / or the Remote Management Card power is off
On (Yellow)	The Remote Management Card is connected to the Network
Tx/Rx LED	
Off	The Remote Management Card power is off
On (Green)	The Remote Management Card power is on
Flashing (Green)	- Receiving/transmitting data packet - Reset finished

INSTALLATION

Step 1. Hardware Installation

NOTE: The CyberPower Remote Management Card is hot-swappable, so you do not need to turn off the device to install it.

1. Remove the two retaining screws of the expansion slot, and then remove the cover.
2. Install the CyberPower Remote Management Card into the expansion slot.
3. Insert and tighten the retaining screws.
4. Connect an Ethernet cable to the Ethernet port of the CyberPower Remote Management Card.
5. (Optional) To connect an environmental sensor, use a RJ45 Ethernet cable. Connect one end to the Universal port on the RMCARD and the other end into the sensor. For more information, please see the ENVIROSENSOR user's manual.

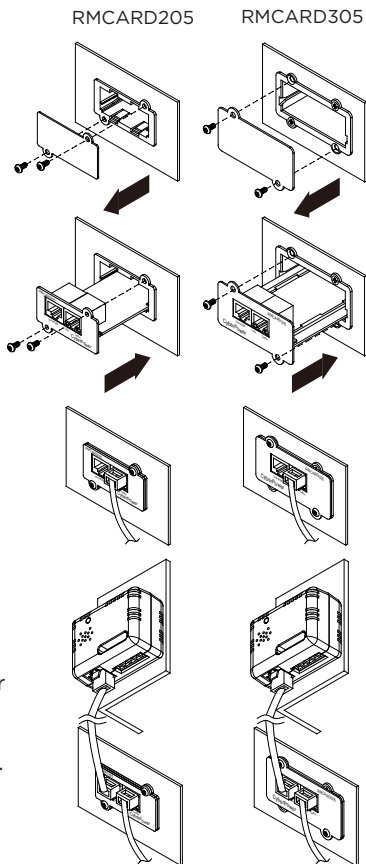

Step 2. Configure the IP Address for the CyberPower Remote Management Card

Method 1: Using the Power Device Network Utility

1. Install the Power Device Network Utility available for download at www.CyberPower.com.
2. After installation completes, run the “Power Device Network Utility”.
3. The main window of the Power Device Network Utility program is shown in Figure 1. The configuration tool will display all CyberPower Remote Management devices present on the local network subnet. The “Refresh” button is used to search the local network subnet again.

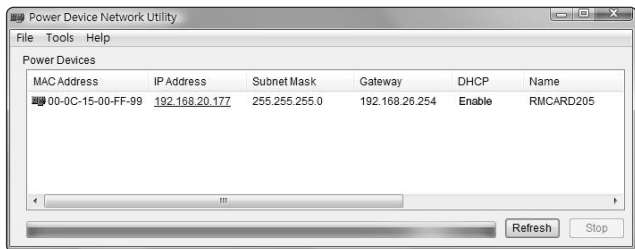

Figure 1. The main window of the “Power Device Network Utility” program

4. Select the Remote Management Card you are setting up. Click on the Tools menu and select “Device Setup” or double click the Remote Management Card you want to configure.
5. You can modify the IP Address, Subnet Mask, and Gateway address for the Device MAC Address listed in the Device Network Settings window, as shown in Figure 2. **The factory default IP Address is 192.168.20.177** and the default Subnet Mask is 255.255.255.0.
6. Modify the IP, subnet mask or gateway address. Enter the new addresses into the corresponding fields and then click “Save”.

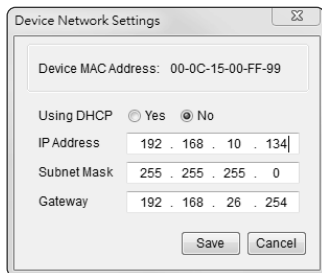

Figure 2. The Device Network setting window

7. You will need to enter a User Name and Password for the Remote Management Card in the authentication window, as shown in Figure 3.

- Default user name: **cyber**
- Default password: **cyber**

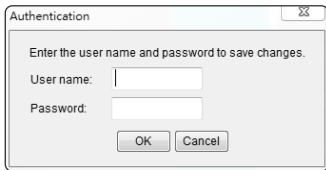

Figure 3. Authentication window

8. If the IP address change is successful, you will see a message confirming the IP set up, as shown in Figure 4.

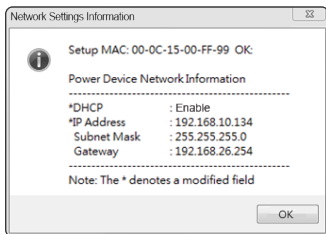

Figure 4. Setup IP Address successfully message

Method 2: Using a Command Prompt

NOTE: These instructions are for Windows OS. For other OS please refer to RMCARD User's Manual available for download at CyberPower Systems official website: www.CyberPower.com.

1. Obtain the MAC address from the label on the Remote Management Card. Each Management Card has a unique MAC address.
2. Use the ARP command to set the IP address.

Example:

To assign the IP Address 192.168.10.134 for the Remote Management Card, which has a MAC address of 00-0C-15-00-FF-99 you will type in the following in the command prompt from a PC connected to the same network as the Remote Management Card.

- (1) Type in "arp -s 192.168.10.134 00-0C-15-00-FF-99" then press **Enter**.
3. Use the Ping command to assign a size of 123 bytes to the IP.
 - (1) Type in "ping 192.168.10.134 -l 123" then press **Enter**.
 - (2) If the replies are received, your computer can communicate with the IP address.

WEB INTERFACE

Login User Account

You will need to enter a User Name and Password to login to the interface, and can select a preferred language after login. There are two user account types.

1. Administrator

- Default username: **cyber**
- Default password: **cyber**

2. View only

- Default username: **device**
- Default password: **cyber**

You will be asked to reset a username and password upon the first login. The administrator can access all functions, including enable/disable the view only account. The viewer can access read only features but cannot change any settings. For detailed descriptions and explanations of the Web UI, please refer to RMCARD User's Manual.

FIRMWARE UPGRADE

By upgrading the firmware, you can obtain both the new features and updates/improvements to existing functionality. To ensure the RMCARD firmware is kept up to date, please visit our website every 3 months to see if there is any updated firmware version available. You can check the "Firmware version" on the [**System->About**] page on the web user interface of the RMCARD. There are two files to update in order to upgrade the firmware version.

- A. cpsrm2scfw_XXX.bin
- B. cpsrm2scdata_XXX.bin

NOTE: Please do not turn the UPS/ATS PDU off when processing the Firmware upgrade.

Using Upgrade and Configuration Utility Tool (Bulk Firmware Upgrade Tool)

1. Install the CyberPower Upgrade and Configuration Utility tool available for download at www.CyberPower.com.
2. After installation completes, run the “Upgrade and Configuration Utility”.
3. The main window of the Upgrade and Configuration Utility tool program is shown in Figure 5. The configuration tool will display all CyberPower Remote Management devices present on the local network subnet. The “Discover” button is used to search the local network subnet again.

NOTE: You can click “View” to select the items you want to view.

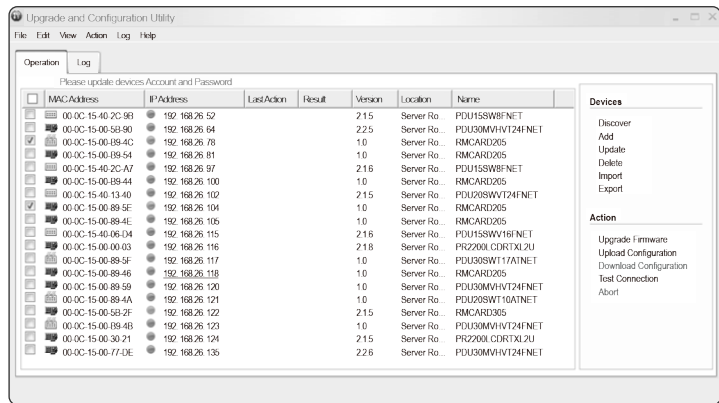

Figure 5. The main window of the “Upgrade and Configuration Utility” program

4. Check the boxes to select the devices you wish to upgrade, and select “Update” on the right to update the device user account and password. Once the update is confirmed, the status icon next to the IP Address will change from orange to green.

NOTE: You must update the device user account and password credentials before firmware upgrade.

5. Select the devices you wish to upgrade by checking their respective checkbox and select “Upgrade Firmware”.

NOTE: You can upgrade the firmware of multiple devices that use the same firmware files (Bulk firmware upgrade).

6. Select the Firmware and Data files and click “OK”, as shown in Figure 6.

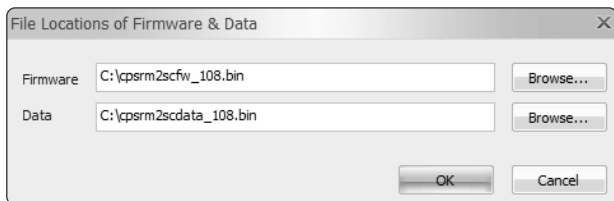

Figure 6. The File Locations of Firmware & Data window

7. Click “Yes” to start firmware upgrade on selected devices, as shown in Figure 7.

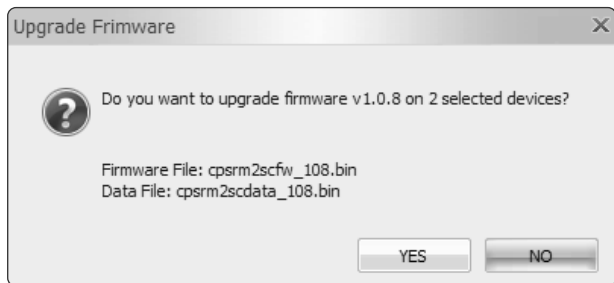

Figure 7. Confirm Upgrade Firmware message window

8. If the firmware upgrade is implemented, you will see the Result in the main window, as shown in Figure 8.

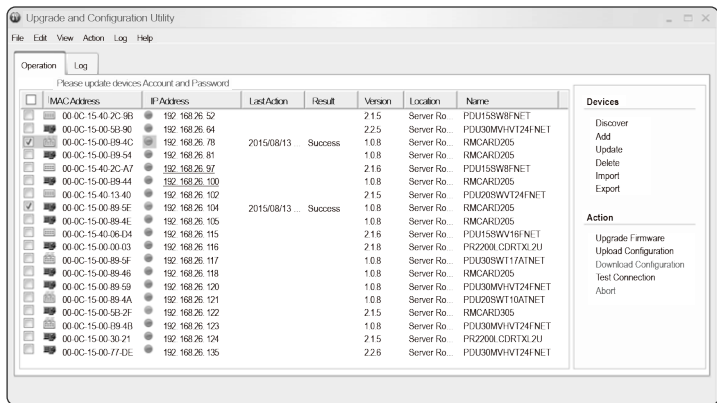
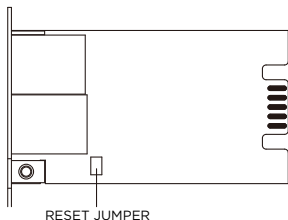

Figure 8. Firmware upgrade success in the main window

RESET TO FACTORY DEFAULT SETTING/RECOVER FROM A LOST PASSWORD

To reset the CyberPower Remote Management Card to its factory default setting (including web log-in user name and password), please follow these steps:



RMCARD205

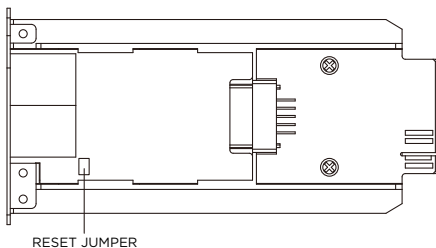

RMCARD305

1. Remove the card from the UPS/ATS PDU without turning the UPS/ATS PDU off.
2. Remove the jumper from the reset pins as illustrated. Do not dispose of the jumper.
3. Insert the card into the expansion port on the UPS/ATS PDU.
4. Wait until the green Tx/Rx LED is flashing (the frequency of the ON/OFF flashing is once per second).
5. Remove the card again.
6. Place the jumper back onto the Reset pins.
7. Install card into the expansion port again and tighten the retaining screws.

RMCARD ADAPTER GUIDE

Remove the adapter to convert an RMCARD305 to an RMCARD205

1. Remove the two screws from the adapter holding the card in place.

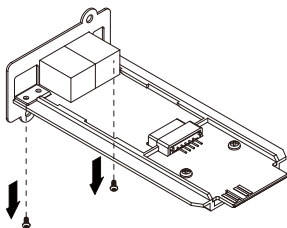

2. Remove the card from the adapter.

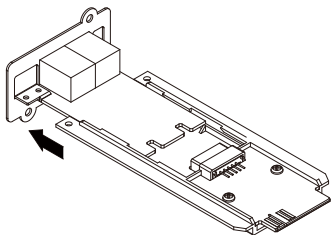

3. Remove the screw holding the RMCARD305 front panel to the card.

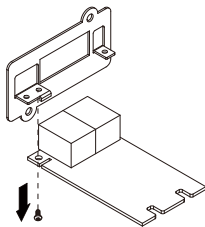

4. Attach the RMCARD205 front panel to the card.

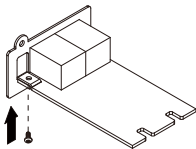

Add the adapter to convert an RMCARD205 to an RMCARD305

1. Remove the screw holding the front panel to the card and remove the RMCARD205 front panel.

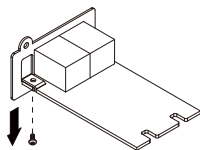

2. Screw on the RMCARD305 front panel to the card.

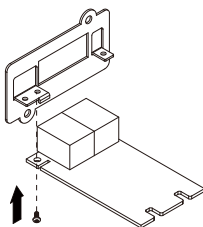

3. Install the card into the adapter. Ensure that the card is securely seated in place.

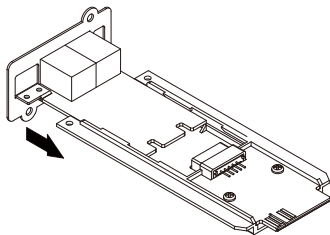

4. Use the two tray screws to secure the card to the adapter.

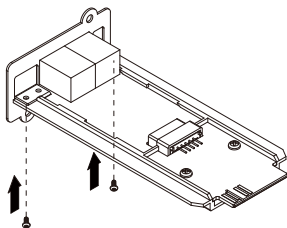

NOTE: The RMCARD Adapter Kit is not included with the RMCARD205. Please contact CyberPower for ordering information or Technical Support.

NOTE: RMCARD205 is designed for the 43x18mm (1.69x0.71 inch) SNMP card expansion port of CyberPower PR, OR, and 1-3kVA OL series UPS, and ATS PDU.

RMCARD305 is designed for the 57x23mm (2.24x0.91 inch) SNMP card expansion port of CyberPower OL6-10kVA series UPS.

SOFTWARE SUPPORT

PowerPanel® Business Edition Client is used to perform a graceful operating system shutdown when protected by a UPS/ATS PDU with a remote management card installed. PowerPanel® Business Edition software is available on CyberPower Systems official website. Please visit www.CyberPower.com and go to the software section for free download.

Communicate with PowerPanel® Business Edition Client

The remote management card requires to authenticate with PowerPanel® Business Edition Client via a shared secret phrase, as shown in Figure 9.

NOTE: The default secret phrase is 'powerpanel.encryption.key'.

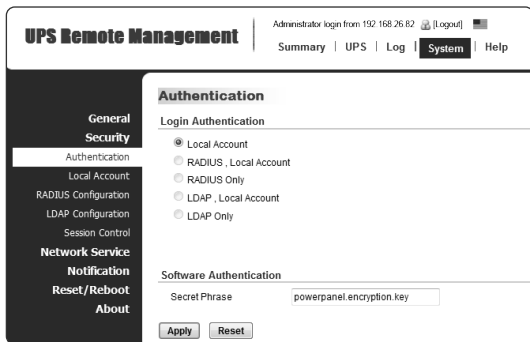

Figure 9. RMCARD System>Authentication web UI

NOTE: PowerPanel® Business Edition software supports automated graceful shutdown of VMware ESX/ESXi hosts as well as other virtualization platforms such as Microsoft Hyper-V and Citrix.



TROUBLESHOOTING

Problem	Solution
<p>Unable to configure the Remote Management Card IP Address using method 1 or method 2</p>	<ol style="list-style-type: none"> 1. Check the LED status, it is normal when the yellow and green LEDs are both on. If green LED is off: ▶ Check if the Remote Management Card is properly seated in the device and the device has power. If yellow LED is off: ▶ Ensure the network connection is good. 2. Ensure the PC being used is on the same local network subnet as the CyberPower device you are trying to communicate with. 3. Ensure the Jumper on the Reset Pin is correctly installed.
<p>Unable to ping the Remote Management Card</p>	<ol style="list-style-type: none"> 1. Use method 1 and/or method 2 to get/set a correct IP address for the Remote Management Card. 2. If the PC being used is on a different network subnet from the Remote Management Card, verify the setting of subnet mask and the IP address of gateway.
<p>Lost the user name and password</p>	<p>Please refer to the “Reset to Factory Default Setting / Recover from a Lost Password” section.</p>
<p>Default Network Setting</p>	<p>IP: 192.168.20.177 Subnet mask: 255.255.255.0 DHCP: On</p>
<p>Unable to access the Web Interface</p>	<ol style="list-style-type: none"> 1. Ensure you can ping the RMCARD. 2. Ensure you are specifying the correct URL. 3. Ensure the HTTP/HTTPS access is enabled by logging in to the card via CLI (Telnet or SSH client).
<p>Unable to operate a SNMP get/set</p>	<p>SNMPv1: Verify the community name. SNMPv3: Verify the user profile configuration.</p>
<p>Unable to receive traps</p>	<ol style="list-style-type: none"> 1. Ensure the trap types (SNMPv1/SNMPv3) and trap receiver are configured correctly. 2. Ensure the IP address of gateway is configured correctly if the RMCARD and NMS are on a different network.

CONFORMANCE APPROVALS

FCC Warning

This equipment has been tested and found to comply with the limits for a Class A Digital Device, pursuant to Part 15 of the FCC Rules. These limits are designed to provide reasonable protection against harmful interference in residential installation. This equipment generates, uses and can radiate radio frequency energy and, if not installed and used in accordance with the instructions, may cause harmful interference to radio communications. Operation of this equipment in a residential area is likely to cause harmful interference in which case the user will be required to correct the interference at his own expense.

Any special accessories needed for compliance must be specified in the instruction.

This device complies with part 15 of the FCC Rules. Operation is subject to the following two conditions: (1) This device may not cause harmful interference, and (2) this device must accept any interference received, including interference that may cause undesired operation.

The Class A digital apparatus meets all requirements of the Canadian Interference-Causing Equipment Regulation.

Cet appareil numérique de la class A respecte toutes les exigences du Reglement sur le materiel brouilleur du Canada.

European Union

This is a class A product. In a domestic environment this product may cause radio interference in which case the user may be required to take adequate measures.

⚠ WARNING: This product can expose you to chemicals including Styrene, which is known to the State of California to cause cancer, and Bisphenol-A, which is known to the State of California to cause birth defects or other reproductive harm.

For more information go to www.P65Warnings.ca.gov.

For warranty and additional information, please visit:
www.cyberpower.com.

CyberPower

Cyber Power Systems, Inc.

www.cyberpower.com

For USA and Canada:

4241 12th Ave East, Suite 400

Shakopee, MN 55379

Toll-free: (877) 297-6937

For all other regions:

Please visit our website for local contact information.

