



WSAN-EE 17-21-25-31-41- 51-61-71-81-91

AIR COOLED HEAT PUMP FOR EXTERNAL INSTALLATION

Installation and Use Manual

UNIT IDENTIFICATION	4
INSTRUCTIONS FOR THE USER	5
GENERAL WARNINGS	8
RESIDUAL RISKS	9
RECEPTION	12
INSPECTION UPON RECEPTION.....	12
STORAGE.....	12
HANDLING.....	12
POSITIONING	13
GENERAL.....	13
FUNCTIONAL CLEARANCES.....	13
POSITIONING.....	13
WATER CONNECTIONS	15
GENERAL.....	15
EXCHANGER USE SIDE.....	15
DIAGRAM OF RECOMMENDED USE SIDE CONNECTION.....	16
USE SCHEMA.....	16
WINTER CONDENSATION.....	16
ELECTRICAL CONNECTION	17
GENERAL.....	17
STANDARD UNIT ELECTRICAL DATA.....	17
CONNECTION TO THE MAINS.....	18
SYSTEM COMPOSITION.....	18
FUNCTIONAL CONNECTIONS.....	19
START-UP	27
PRELIMINARY CHECKS.....	27
REFRIGERANT SYSTEM.....	27
WATER SYSTEM.....	27
ELECTRICAL SYSTEM.....	27
VERIFY tensions – absorptions.....	28
UNIT EQUIPPED WITH SCROLL COMPRESSORS.....	28
REMOTE INPUT CONFIGURATIONS.....	28
SETTING THE SET-POINT.....	28
EVAPORATOR WATER FLOW RATE.....	28
REFRIGERANT CIRCUIT PARAMETER CHECK.....	28
CONTROL	29
OPERING MODES.....	29
SET POINT.....	31
USER REMOTE KEYPAD.....	32
FUNCTIONING TEST.....	33
ACCESSIBLE PARAMETERS FROM REMOTE OR SERVICE KEYBOARD.....	34
ALARMS.....	36
ROUTINE MAINTENANCE	37
MAINTENANCE INSPECTIONS.....	38
97/23 CE PED directive.....	38
PUT AT REST.....	38
REFRIGERANT TABLES.....	39
TROUBLESHOOTING	41
DECOMMISSIONING OF THE UNIT	43
DISCONNECTING THE UNIT.....	43
DISMANTLING AND DISPOSAL.....	43
TECHNICAL DATA	44
DIMENSIONS	47

UNIT IDENTIFICATION

SERIAL NUMBER LABEL

The units are identified by the serial number label shown here.

The label lists the type of unit (series and size), serial number, year of manufacture, number of electrical diagram, main technical data, logo and address of the manufacturer.

The label is placed on the unit, generally near the electrical panel and also on the external panelling.

IT MUST NEVER BE REMOVED.

SERIAL NUMBER

This provides unique identification of the machine. It makes it possible to trace the specific features of the unit and to identify the components installed in it.

Without this number, it is not possible to identify with certainty the spare parts that are specific to that unit.

When requesting assistance, always provide the type of machine and the serial number.

Write them in the space below so that they are readily available when needed.

Type of unit : _____

Serial number : _____

Wiring diagram : _____

Year of manufacture : _____

<div style="display: flex; justify-content: space-around; align-items: center;"> <div style="border: 1px dashed black; padding: 5px; font-weight: bold; font-size: 1.2em;">LOGO</div> <div style="font-size: 2em; font-weight: bold;">CE</div> </div>	
<small>TIPO TYPE/TYP TYPE/TIPO</small>	
<small>NUMERO MATRICOLA SERIAL NUMBER / SERIENNUMMER NUMERO DE SERIE / NUMERO DE SERIE</small>	
<small>ANNO DI FABBRICAZIONE YEAR OF MANUFACTURE / BAUJAHR ANNEE DE FABRICATION/AÑO DE FABRICACIÓN</small>	
<small>REFRIGERANTE REFRIGERANT / KÄLTEMITTEL REFRIGERANT / REFRIGERANTE</small>	<small>GRUPPO (PED) GROUP / GRUPPE GROUPE / GRUPO</small>
<small>CARICA REFRIGERANTE REFRIG. CHARGE / KÄLTEMITTELFÜLLUNG CHARGE REFRIG./CARGA REFRIG.</small>	
	<small>Kg</small>
<small>TENSIONE VOLTAGE / SPANNUNG TENSION / TENSION</small>	
	<small>V/Ph/Hz</small>
<small>F.L.A.</small>	
	<small>A</small>
<small>F.L.I.</small>	
	<small>kW</small>
<small>SCHEMA ELETTRICO WIRING DIAGRAM / SCHALTPLAN SCHEMA ELECTRIQUE/ESQUEMA ELÉCTRICO</small>	
	<small>N°</small>
<small>PRESSIONE MASSIMA ESERCIZIO MAX OPERATING PRESS. / MAX BETRIEBSDRUCK PRESS. DE SERVICE MAX/PRESION DE EJERCICIO MÁX</small>	
	<small>bar</small>
<small>CATEGORIA PED PED CATEGORY / PED KATEGORIE CATEGORIE PED / CATEGORIA PED</small>	
	<small>PS H/L bar</small>
<small>TEMP. LATO BP TEMPERATURE ON LP SIDE / TEMP. ND-SEITE TEMP. COTE BP / TEMP. PARTE BP</small>	
	<small>°C</small>
<small>INDIRIZZO / ADDRESS / ADRESSE / ADRESSE / DIRECCIÓN</small>	

INSTRUCTIONS FOR THE USER

- **This is a partial sintex of the information provided in the manual; carefully read this manual**
- Carefully read this manual. Keep it with the electrical diagram. Make it available to technicians for servicing.
- Ask the installer for training on start-up, shutdown, changing set points, placing in at-rest status, maintenance, what to do or not to do in the event of a breakdown.
- Provide for scheduled maintenance by specialized technicians so as to ensure long-lasting operation of the unit.
- If you expect the machine to be shut down for long periods of time, disconnect the electrical power supply. In winter, take necessary measures to deal with possible freezing (unit and system pipes) .

PRINCIPLE OF OPERATION

SUMMER: the cooling cycle allows the transfer of excess indoor heat to the external environment.

1. The compressor compresses the refrigerant gas, placing it at high pressure and high temperature.
2. In the external coil, the refrigerant is cooled, and the heat is released into the environment by means of the fan. This is why the coil needs to be kept clean and free of obstacles.
3. When it cools, the refrigerant becomes liquid.
4. The expansion valve causes a sudden drop in the pressure of the refrigerant, which becomes very cold as its volume increases.
5. In the exchanger, the refrigerant evaporates and absorbs the heat from the water that returns to the system, cooling it.

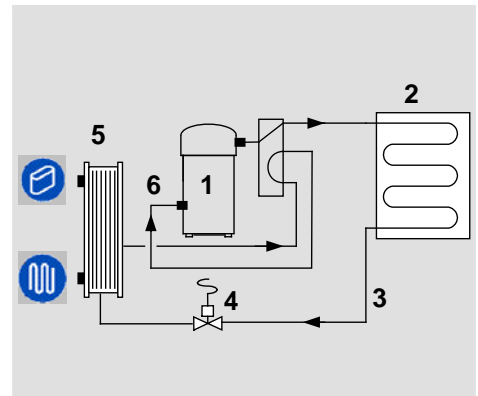

WINTER : the cooling cycle makes it possible to absorb energy (heat at low temperature) from the external environment and to transfer it to the area to be heated.

1. The compressor compresses the refrigerant fluid, placing it at high pressure and high temperature.
2. The 4-way valve reverses the flow with respect to respect to SUMMER operation.
3. In the plate exchanger, the water that returns to the system absorbs heat from the refrigerant.
4. As it cools, the refrigerant condenses and becomes liquid.
5. The expansion valve causes a sudden drop in the pressure of the refrigerant, which becomes very cold as its volume increases.
6. In the external coil, the cold refrigerant evaporates and absorbs heat from the fresh air. In this phase, as the coil cools, it may freeze. This is why the cycle is automatically reversed periodically for a short time so as to defrost it

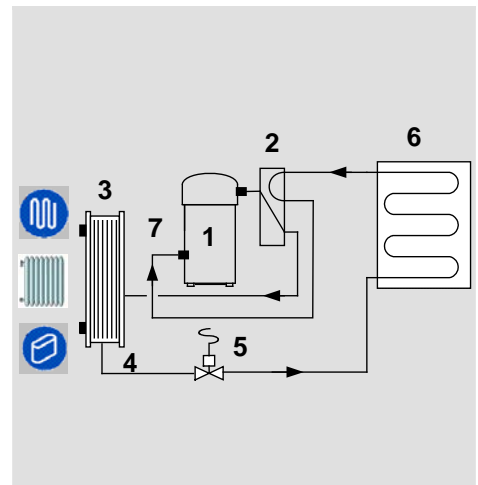

WATER CIRCUIT





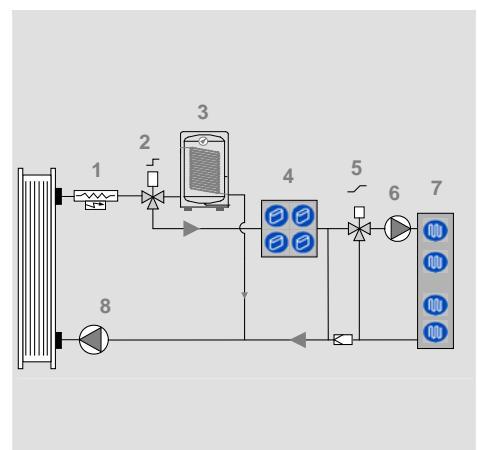

The diagram on the side is indicative and includes optional components; check with the installer about the system configuration used.

1. the electric heaters supplement the heating capacity supplied by the unit;
2. the 3-way valve diverts the water either towards the sanitary hot water storage or towards the heating equipment;
3. sanitary hot water storage;
4. fan coil heating;
5. if the room needs to be heated, the 3-way valve diverts the water towards the underfloor piping (all or in part); if instead the underfloor piping is satisfied, it returns the water directly to the unit;
6. the pump keeps the water in circulation in the underfloor piping
7. underfloor heating
8. the pump returns the water to the unit



TO DO FOR:

Some functions are active only if they are enabled during installation (remote ON-OFF, remote SUMMER WINTER change, remote ECO, sanitary hot water, set point compensation). Check with the installer about the configuration used.

Start the unit	LONG pressing of the ON/OFF button	
Choose the SUMMER mode possible also by external enabling (see ELECTRICAL CONNECTIONS)	“SUN” button Green led on	
Choose the WINTER mode possible also by external enabling (see ELECTRICAL CONNECTIONS)	“SNOW-FLAKE” button Green led on	
Limit the energetic consumption Control by external enabling (see ELECTRICAL CONNECTIONS)	ECO button	
Choose the optimal comfort level	COMFORT button	
Activate the hot sanitary water production	Through remote consent outside the unit “SNOW-FLAKE” button on “SUN” led is flashing	
Minimize the consumptions maintaining the system at a safety temperature in WINTER (MAINTENANCE function)	Put the unit in OFF (parameter 45 must be = 1) yellow led is flashing	
Minimize the consumptions maintaining the system at a safety temperature in SUMMER (MAINTENANCE function)	Put the unit in OFF (parameter 44 must be = 1) yellow led is flashing	
Identify the cause of the unit shutdown	RED LED lit - flashing: the alarm resets automatically - on continuously: a manual reset is necessary	



ELECTRICAL CIRCUIT ALARM

- Inlet probe
- Outlet probe
- Radiant panel water probe
- Coil/flow probe
- External probe
- Pressure 1 probe
- Water reset inlet
- External relative humidity probe
- Phase monitor
- Electric heater output probe
- serial faulty alarm



REFRIGERANT CIRCUIT ALARM

- HP
- LP
- CCMP/VENT
- HP1 Pre-Alarm
- BP1 Pre-Alarm
- serial faulty alarm



WATER CIRCUIT ALARM

- Flow pump
- System charged with water
- Antifreeze alarm
- Antifreeze PREAlarm
- Pump alarm
- C1 PREAlarm
- PRad. Cooling limit alarm
- PRad. Water frost alarm
- Coil frost alarm
- Alarm ?T° incongruous
- Electric heater antifreeze alarm
- serial faulty alarm

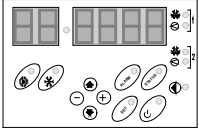
To reset the current alarm ONLY AFTER THE CAUSE ELIMINATION !	TEST + ON/OFF contemporary for some seconds	
Modify the HOT SANITARY water temperature	Control parameter 117	<p>Only by SERVICE keypad</p> 
Modify the water temp. in HEATING	Control parameter 33	
Modify the water temp. in ECO HEATING	Control parameter 30	
Modify the water temp. in COOLING	Control parameter ametro 32	
Modify the water temp. in ECO cooling	Control parameter 29	
Modify the water temp. in MAINTENANCE heating	Control parameter parametro 43	
Modify the water temp. in MAINTENANCE cooling	Control parameter 42	

COMMON CAUSES OF SHUTDOWN

- | | |
|--|---|
| <ol style="list-style-type: none"> 1. coils dirty - clogged by leaves - nearby obstacles - covered with snow 2. set point too low (in summer) or too high (in winter) 3. water in system is too hot (in summer, for example with machine left off over the weekend) or too cold (in winter) 4. water filter dirty 5. external permissions (remote ON-OFF etc.) | <ol style="list-style-type: none"> 6. water cut-off valves closed 7. system not pressurized - air needs to be vented 8. circulator pump not running (after seasonal shutdown) 9. unit exchanger dirty 10. fans blocked by snow |
|--|---|

GENERAL WARNINGS

MANUAL PURPOSE

This manual has been designed to enable the unit to be installed, started up and maintained correctly.

MANUAL INSTRUCTIONS

It is essential to observe these instructions.

The manufacturer declines all liability for any damage that may be caused whether directly or indirectly to persons or things if these instructions are not heeded.

MANUAL STORAGE

This manual and the unit's wiring diagram should be carefully stored so that they are readily available to the operator when required.

EXPERT PERSONAL

The unit must be installed, tested and maintained by expert personal who meet the relevant legal requirements (Italian law No. 46 of 5/3/1990).

LOCAL SAFETY REGULATION INSTALLATION

The installation must be performed observing the local safety regulations.

POWER SUPPLY

Make sure the power supply conforms to the data on the unit's rating plate, located inside the door of the main electrical panel.

PACKAGING

The packaging material (plastic bags, polystyrene foam, nails, etc.) is potentially dangerous and should therefore be kept away from children and recycled in compliance with the local regulations in force.

MAINTENANCE

Before performing any service operations, cut off the power. Perform the operations in conformity with the local regulations in force.

PERIODICAL INSPECTIONS

Perform periodical inspections to locate possible loosened or broken parts. If the repairs are not performed, there will be a higher risk for things and peoples to become damaged and injured.

FAULT – POOR OPERATION

Switch off the unit in the event of faults or poor operation.

REPAIR

Only have repairs carried out by a service centre authorised by the manufacturer, and insist on the use of original spare parts only.

Failure to comply with the above may compromise the safety of the unit.

MODIFICATIONS

The manufacturer will not accept any responsibility, and the warranty will lapse, in the event of electric and/or mechanical modifications. Any modification which is not formally authorized, and which does not respect the instructions given in this manual, will cause the warranty to lapse.

INTENDED USE

The unit must only be used for the specific purpose it was designed :

The unit is designed to cool/heat water or a water and glycol mix for air-conditioning, within the limits defined in the technical bulletin and this manual.

Any use other than that specified does not imply any commitment or constraint by the manufacturer in any way whatsoever.

ADDITIONAL SAFETY PRECAUTIONS

This unit has been especially designed and manufactured so to prevent any risk to persons and health hazard.

For this reason, design solutions fit to eliminate (where possible) any cause of risk and sensibly reduce the probability of danger have been adopted.

Please refer to the "Residual Risks" section of this manual and strictly observe the behaviour prescriptions listed there in order to prevent any possible risk that hasn't been possible to avoid in the design stage.

DATA UPDATING

The manufacturer may be able to modify the data without prior notice as a consequence of constant improvements.

REGULATIONS AND CERTIFICATIONS

UNI EN ISO 9001 CERTIFICATION

Clivet S.p.A., in order to guarantee customer satisfaction, has chosen the ISO 9001 Quality System as the reference for all its business activities. This is demonstrated by the company's commitment to ongoing improvements in the quality and reliability of its products; its sales, design, purchasing, production and after-sales service activities are the means used to reach such purpose.

CE MARK



Clivet products bear the CE mark, in compliance with the requirements of the following EC directives, including the latest amendments, and with the corresponding national approximated legislation:

- - 98/37/CE
- - 89/336/CEE as modified by the directives 92/31/CEE and 93/68/CEE
- - 73/23/CEE as modified by the directive 93/68/CEE
- - 97/23/CE

EUROVENT CERTIFICATION



Clivet is participating in the EUROVENT Certification Programme "Liquid Chilling Packages". Products are listed in the EUROVENT Directory of Certified Products and in the site www.eurovent-certification.com. Eurovent Chillers Certification Programme covers air cooled packaged chillers up to 600 kW and water cooled packaged chillers up to 1500 kW.

RESIDUAL RISKS

GENERAL

This section lists some of the more common situations which, being beyond the control of the manufacturer, could be a source of risk to persons or property.

DANGER AREA

The figure below highlights the area in which only authorised personnel may operate.

- **External danger zone**, identified by a precise area around the unit and its vertical projection on the ground in the case of hanging unit.
- **Internal danger zone**, identified by the area that can be entered only after having intentionally removed the protecting panels or parts of these.

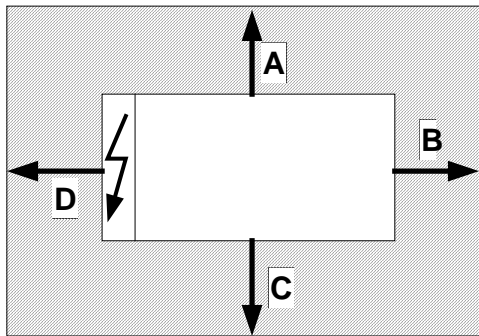

A = 1000mm B = 1000mm
C = 1000mm D = 1000mm

HANDLING

If handling operations are undertaken without adopting all the necessary safety procedures and exercising due care, the unit can fall or topple, causing damage — possibly extremely serious — to persons and/or property, and to the unit itself.

Ensure the unit is handled and manoeuvred as directed on the packing and in the present manual, and in accordance with local regulations.

In the event of refrigerant gas escaping, refer to the “Safety datasheet” for the particular refrigerant.

INSTALLATION

Incorrect installation of the unit can result in water leaks, accumulation of condensate, escape of refrigerant, electric shocks, fire, as well as irregular operation or damage to the unit itself.

Make certain that the installation is carried out only by a qualified technician, also that the directions contained in this manual are followed and local statutory regulations observed.

In the event of the unit being installed in a site where there is even the slightest risk of inflammable gas escapes and consequently the possibility of such gases accumulating in area around the unit, the risk of explosion and fire cannot be discounted.

Take every care and precaution when selecting the installation site.

Installation on a structure not able to bear the weight and/or afford a secure anchorage of the equipment may cause the unit to fall and/or topple, resulting in damage to persons or property, or to the unit itself. Make certain that every care

and precaution is taken when positioning and securing the unit.

If the unit is easily accessible to children, unauthorized persons or animals, this is a situation that can give rise to accidents and injuries, perhaps serious. Install the unit in a place where access is allowed only to authorized persons, or install barriers or guards preventing unauthorized entry.

GENERAL RISKS

A smell of burning, smoke or other indications of serious irregularity could signal the onset of situations liable to cause damage to persons or property or to the unit itself. Isolate the unit from the electrical power supply (red-and-yellow) switch.

Contact an authorized service centre so that the source of the problem can be identified and remedied.

Accidental contact with heat exchange coils, compressors, pressure pipelines or other components can result in wounding or burns, or both.

Always wear suitable clothing, including protective gloves, when working in the danger area.

Maintenance or repairs carried out by unskilled operatives can result in harm or damage to persons and property, or to the unit itself. Always contact an authorized service centre.

Failure to close the panels of the unit, or to check that all the fixing screws of the panels are properly tightened, can result in harm or damage to persons or property, or to the unit itself.

Verify periodically that all panels are closed and made properly secure.

In the event of fire, the temperature of the refrigerant can rise to the point that pressure will exceed safety levels and perhaps cause fluid to be projected. It may also happen that parts of the circuit isolated by closed valves will explode.

Do not stand near safety valves, and never leave the valves of the refrigerant circuit closed.

ELECTRICAL SYSTEM

If the power line connecting the unit to the a.c. supply is incomplete, or if the connection is made with cables of incorrect cross section and/or with insufficiently rated protective devices, this can result in electric shock, toxicity hazard, damage to the unit or fire.

All work on the electrical system should be carried out referring to the wiring diagram and to the directions given in this manual, and the system itself must be dedicated.

Failure to secure the cover enclosing electrical components can lead to the infiltration of dust and water, ultimately causing electric shocks, damage to the unit, or fire.

Always fasten the cover securely to the unit.

If live metal parts of the unit are not connected properly to the earth system, they can cause electric shock or even death by electrocution.

Make absolutely certain that the connection to the earth system is made in accordance with correct practice.

Contact with live parts rendered accessible internally of the unit when the guards are removed can result in electric shock, burns or death by electrocution.

Before exposing these parts, make certain the isolating switch on the power line to the unit is set to the OFF position and padlocked, and post a warning sign.

Contact with parts that could become live when the unit is started up can result in electric shock, burns or death by electrocution.

When there is no need for circuits to be powered up, set the isolating switch on the power line to the OFF position, padlock it and post a warning sign.

MOVING PARTS

Contact with the fan rotors can cause injury.

Before removing the protective grilles or the fans themselves, make certain the isolating switch on the power line to the unit is set to the OFF position and padlocked, and post a warning sign.

Before removing the protective grilles or the fans themselves, make certain the isolating switch on the power line to the unit is set to the OFF position and padlocked, and post a warning sign.

REFRIGERANT

In the event of safety valves coming into operation and releasing refrigerant gas, persons in the vicinity can be

injured or suffer toxic effects. Always wear suitable clothing and protective goggles when working in potential hazard areas.

In the event of refrigerant gas escaping, refer to the "Safety datasheet" for the particular refrigerant.

If an open flame or heat source is brought into contact with the refrigerant, or the pressurized gas circuit should overheat (e.g. during welding operations), this can cause explosion or fire. Do not position any heat source within the hazard area.

Maintenance or repair operations involving welding must be carried out with the system emptied of refrigerant.

WATER SYSTEM

Defects affecting pipelines, connections or valves and other control componentry can result in water being leaked or sprayed from the system, occasioning damage to property or causing short circuits in the unit.

Make certain all hydraulic connections are securely made, following the directions given in the present manual.

REFRIGERANT SAFETY CHARGE

		R-407C
01	Identifying elements for the substance	Product name: forane 407C N°SDS 01965/1 Supplier: ELF ATOCHEM ITALIA Via G.Murat 17, 20159 Milano tel. 02/668111
02	Information concerning composition of components	Chemical nature of the compound Mixture based on: Forane 32(difluoromethane) (N° CAS: 75-10-5) Forane 125 (pentafluoroethane) (N° CAS: 354-33-6) Forane 134a (1.1.1.2 tetrafluoroethane) (N° CAS: 811-97-2)
03	Identification of risk	Greatest physical and chemical dangers: Thermal decomposition in toxic and corrosive products
04	First-aid measures	General information: Inhalation: Carry the victim into the open air. Resort to oxygen or artificial respiration if necessary. Contact with skin: Frostbite must be treated in the same way as burns. Contact with the eyes: Immediate rinsing in abundant water. If irritation should continue, consult an ophthalmologist. Medical instructions: Do not administer catecholamines (due to the cardiac sensitisation caused by the product)
05	Fire prevention measures	Specific dangers: Thermal decomposition into toxic and corrosive products. Hydrofluoric acid. Carbon monoxides. Specific means of intervention: Cool containers/cisterns with jets of water. Prevent any sparks or flames. Do NOT smoke. Special protection systems for fire-fighting squads: Carry breathing apparatus and wear protective clothing.
06	Measures to take in case of accidental spillage	Individual precautions: Avoid contact with the skin, eyes and inhalation of vapours. Use personal protection devices. In an enclosed space: ventilate or use breathing apparatus (risk of suffocation). NO SMOKING ALLOWED Precautions for environmental protection: Minimise the amount of waste deposited in the environment.
07	Manipulation and storage	Technical measures/precautions. Form of storage and manipulation applicable to the products: PRESSURIZED GAS. Ensure adequate ventilation and evacuation for the level of equipment. Advice for use: Prevent sparks and contact with hot surfaces. DO NOT SMOKE. Technical measures/Storage procedures: Store at ambient temperature in the original container. Keep away from flames, hot surfaces and sparks. Store in a cool, well-ventilated place. Protect full containers from sources of heat to avoid excessive pressures. Recommended: Ordinary steel. Avoid: Alloy containing more than 2% magnesium. Plastics.
08	Control of individual exposure/protection	Precautionary measures to be taken: Ensure a sufficient exchange of air and/or suction in workplaces. Control parameters. Exposure limits: There is no F-USA limit value Forane 134a Elf recommended limit value: VME=1000ppm Forane 32 Elf recommended limit value: VME=1000ppm Forane 125 Elf recommended limit value: VME=1000ppm Respiratory protection: In case of insufficient ventilation, carry suitable breathing apparatus. Protection for the hands: Gloves Protection for the eyes: Protective eyewear.

09	Physical and chemical properties	<p>Physical state (20°C): liquid gas Colour: colourless Smell: Slightly similar to ether; pH: not applicable. Boiling point/interval: -42,4 °C Melting point/interval: Not inflammable in test conditions Vapour pressure: (25°C): 1.13 Mpa (11,3 bar) a (50°C): 2.11 Mpa (21,1 bar) a (70°C): 3.26 Mpa (32,6 bar) Vapour density: At boiling point 4,54 kg/m³ Density: (25°C) 1133 kg/m³ a (50°C) 1004 kg/m³ a (70°C) 861 kg/m³</p>
10	Stability and reactivity	<p>Conditions to avoid: Avoid contact with flames and red-hot metal surfaces. Dangerous decomposition products: Thermal decomposition into toxic and corrosive products: Toxic fluorinates Hydrogen fluoride (hydrofluoric acid) Further information: Product stable in normal storage and handling conditions</p>
11	Toxicological information	<p>Inhalation: Practically non-toxic in experiments conducted on animals Forane 134a, 32, 125. No rat mortality at 500000 ppm/4h. As with other volatile aliphatic halogenated compounds, with the accumulation of vapours and/or the inhalation of large quantities, the product can cause: loss of consciousness and heart problems aggravated by stress and lack of oxygen; risk of death. Contact with skin: Frostbite possible from splashes of liquefied gas. Chronic toxicity: Studies on extended inhalation in animals have not highlighted any sub-chronic toxic effect (rat/3 months/ Inhalation:50000ppm) Specific effects: Genotoxicity, according to experimental data available Forane 134a, 32, 125 NOT Genotoxic Carcinogenic effect: Forane 134a experiments on animals have not demonstrated a clear cancerogenous effect (rat /oral inhalation) Toxicity for reproduction: Foetal development Forane 134a, 32, 125 according to available data there are no toxic effects for foetal development. Fertility, according to available data for animals: Forane 134a no effect on fertility (mice/inhalation)</p>
12	Ecological information	<p>Forane 32 Durability/degradability: Not easily biodegradable in water: 5% after 28d Bioaccumulation: Practically non-absorbable by biological organisms log pow 0,21 Forane 125 Mobility: Rapid evaporation t ½ life 3,2 h (estimated) Durability/degradability: Not easily biodegradable in water: 5% after 28 days. In the atmosphere degradation at rate of 1/2 life in 28,3 y (estimated). . Potential for destruction of ozone ODP (R-11 = 1)=0. Potential greenhouse effect (GWP): (HGWP) = 0,58. Low absorption in ground and sediments log Koc= 1,3-1,7 Bioaccumulation: Practically non-absorbable by biological organisms log pow 1,48 Forane 134a Mobility: Rapid evaporation t ½ life 3 h (estimated) Durability/degradability: Not easily biodegradable in water: 3% after 28 days. In the atmosphere degradation at rate of 3% after 28 days (estimated). Potential for destruction of ozone ODP (R-11 = 1)=0. Potential greenhouse effect (GWP): (HGWP) = 0,26. Bioaccumulation: Practically non-absorbable by biological organisms log pow 1,06</p>
13	Notes concerning disposal	<p>Disposal of product: recycle or incenerate.</p>
14	Information on shipping	<p>Consult the ELF ATOCHEM safety service for supplementary information and updates ONU number 3163. RID/ADR class 2 figure (and letter) 4° a Regulations: No. danger/No. material 20/3163 label 2 IMDG class 2.2 ONU (IMDG) 3163 Regulations: 2.2 /2 label IATA class 2.2 ONU (IATA) or No.ID 3163 Regulations: 2.2 /2 label</p>
15	Information on regulation	<p>EEC directives Security reports: D.91/155/CEE modified by D.93/112/CEE: Dangerous substances Classification/CE mark Dangerous manufactured compounds: Not classified as dangerous Inventory: EINECS compliant</p>
16	Other information	<p>Recommended uses: low-temperature coolant Bibliographical references: Encyclopedie des gas (Air Liquide-ed.1976- ELSEVIER AMSTERDAM)</p>

This document refers to the product as is and which conforms to the specifications supplied by ELF ATOCHEM. If combinations or mixtures are made, check that there are no new dangers resulting from this action. The information provided in this report has been provided in good faith and is based on our latest knowledge of the product in question as of the date of publication of the same. The attention of users is drawn to the potential risks of employing the product for any use other than that for which it is intended. This report must be used and reproduced solely for purposes of prevention and safety. The list of legislative, regulatory or administrative texts must not be considered exhaustive. The product user is under obligation to refer to all the official texts concerning the use, conservation and manipulation of the product for which he is sole responsible. The product user must also provide all those who might come into contact with the product with the information necessary for their safety at work and the protection of their health and that of the environment, giving them a copy of this safety information report.

RECEPTION

INSPECTION UPON RECEPTION

Check on arrival that the unit has not suffered damage during transit and that it is complete in every part as specified in the order. In the event of visible damage/deficiencies being discovered, make a note immediately on the delivery document with the comment: **CONDITIONAL ACCEPTANCE — CLEAR EVIDENCE OF DEFICIENCIES/DAMAGE DURING TRANSIT**

Inform both the supplier and the carrier of the details by fax and by registered mail with advice of receipt not later than 8 days after taking consignment. Notifications sent after 8 days have elapsed will be ignored.

STORAGE

Shelter from: direct sunlight, rain, sand and wind

Temperature: maximum 60°C minimum -10°C

Maximum humidity: 90%

The respect of the instructions on the exterior side of the packaging assures the physical and functional integrity of the unit for the final user's advantage.

It is recommended to:

- Handle carefully
- Keep in a dry place
- Avoid putting other objects on top of the unit (respect the limits of levels of superimposition shown in the package)
- Avoid placing the unit with thermoretractable protection under the sun since the pressure of the circuits can assume values which activate the safety valves.

HANDLING

The operation of handling the unit must be carried out respecting the instructions of the safety norms in force (Legislative Decree 626/94 and following modifications)

Before starting the handling operations:

- Value the critical points during handling (stairs, flights, disconnected routes, doors, etc)
- Verify that the lifting capacity of the means used is adequate to the unit weight
- Consider that the barycentre could be moved with respect to the center of the unit
- Before starting to lift, verify that the unit is at a stable balance

The following examples are indications; the choice of the means and of the handling modes will depend on factors, such as:

- The unit weight
- Type and overall dimensions of the unit
- Place and route for the handling (dirt yard, asphalted square, etc)
- Condition of the place of destination (roof, square, etc)
- Handling distance characteristics (distances, flights, steps, doors)

LABELS / YELLOW BRACKETS SHOW THE LIFTING POINTS

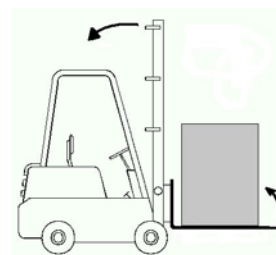
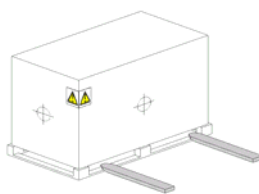
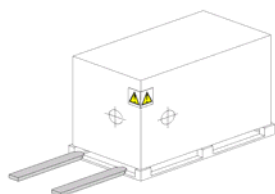

REMOVING THE PACKING

For removing the packaging, use specific personal protection for the operator (gloves, glasses, etc.).

While removing the packaging, pay attention not to damage the unit.

Check for any visible damage.

Dispose of the packaging by taking it to specialist collection or recycling centres in accordance with local regulations.

POSITIONING

GENERAL

For installing air-conditioning systems, it is necessary to consider the following:

- the technical spaces necessary for the machine and system
- the place where the machine will be installed
- the transport of thermal carrier fluids and relevant connections to the unit:
 - water
 - air
 - refrigerant (unit in more sections)
- electrical connections

If these aspects are not evaluated carefully, they can affect the performances and the working life of the unit.

FUNCTIONAL CLEARANCES

When placing the unit, please respect the functional clearances indicated in DIMENSIONS section.

The functional spaces need to be observed because of the following:

- to guarantee the good operation of the unit
- to allow the performance of all maintenance operations
- to protect the authorized operators and exposed people

If more units are placed close to one another, the functional spaces must be doubled.

POSITIONING

1. The units are designed for **OUTDOOR** installations, performed in fixed positions and in areas accessible only to qualified and authorized personnel
2. **SAFETY VALVE** (only if present on the unit) : the installer is responsible for evaluating the opportunity of installing drain tubes, in conformity with the local regulations in force (EN 378)
3. Install the unit **raised** from the ground
4. avoid installations in places subject to **flooding**
5. Consider the maximum level which can be reached by **snow**
6. Verify that the fixing/supporting points are level and suitable to support the **weight of the unit** (see the weight and the weights distribution)
7. It is recommended to put the unit on specific **antivibration devices**

Each support point of the unit sustains a different weight. Therefore, each anti-vibration device is sized for a specific support point, and can only be placed there. The anti-vibration devices must therefore be placed in accordance with the instructions provided with them and with the dimensional drawings in which the support points are indicated by W1 , W2 , W3 etc .

On each anti-vibration device (if provided by CLIVET), its identifying code is stamped, for example C6100100

Flexible joints are necessary on all the hydraulic/aerualic connections (the joints are not supplied by Clivet)

8. **Anchor** the unit to the ground; foresee windbreak barriers in case of places where there are strong prevalent winds .
9. during winter operation, a considerable amount of **condensation** water is produced, which must be removed from the unit.

Make sure that removal of condensation water does not create any problems for persons or property, such as dripping from balconies, onto walkways, etc.

For long periods of heat pump operation with outside temperature below 0 °C, the condensation might **freeze**, causing a build-up of ice. The installation of anti-freeze heating elements should be considered.

For the units that are equipped with a condensation drain, this is shown on the dimensional drawing.

10. The choice of the location of the unit is of fundamental importance for correct operation; to avoid:
 - **obstacles** that block the flow of air
 - difficulty in air **circulation**
 - **leaves** or other objects that may block the exchanger coils
 - **winds** that contrast or excessively assist the air flow
 - phenomena of **stratification** or air **re-circulation**
 - nearby **sources** of heat (chemney, extractor ecc)
 - positioning under the round level or near very high walls
- The previous situations cause working anomalies or stop the machine and cause:
- during **SUMMER** operation, increase of the condensation pressure with the decay of performances and possible stops due to high pressure.
 - during **WINTER** operation, decrease of the evaporation pressure with increase to the amount of defrosting and consequent decay of the performances and possible stops due to high pressure

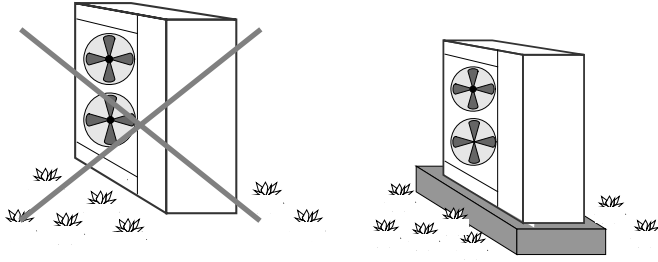

Install the unit raised off the ground and on a sturdy base.

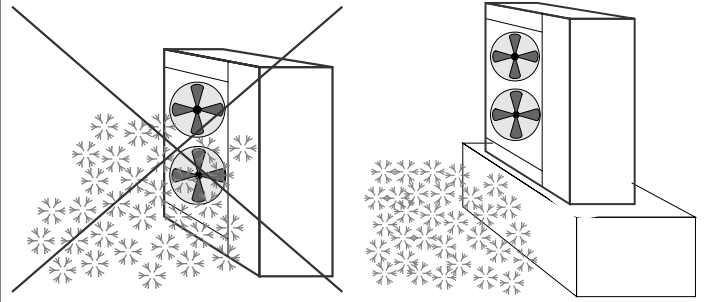

Consider the maximum depth that snowfall might reach.

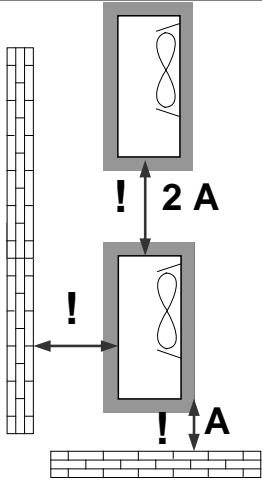

Consider clearances and direction of expelled air.

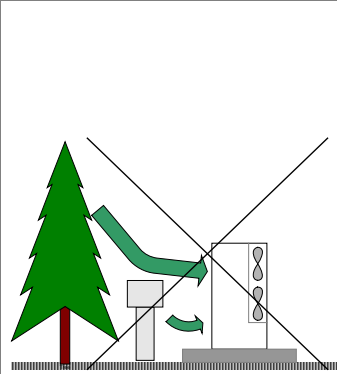
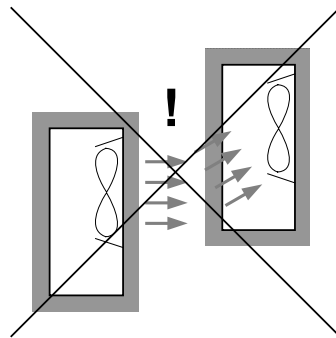

Keep the coil clean. Avoid zones with leaves / dirt / corrosives.

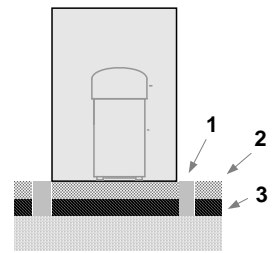

1. elastic joint
2. floating floor
3. soundproofing

Prevent the transmission of vibrations.

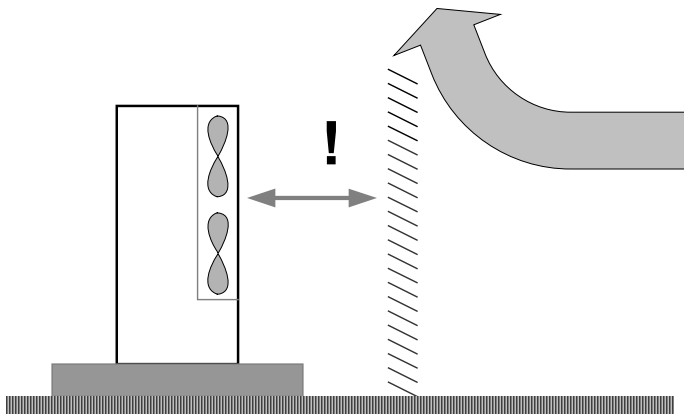

Provide windbreaks in locations with strong winds

WATER CONNECTIONS

GENERAL

Piping must be designed with the least possible number of bends and head variations. If the pressure chute of the installation is above the useful prevalence of the pump, the water delivery capacity is reduced as well as, as a consequence, the thermal exchange and the yield.

INTERCEPTING VALVES

Install on the input and output of the user parts (exchangers, coils, humidifiers, etc) So that it will be possible to carry out all the service operations and possible substitutions without emptying the installation.

PRESSURE AND TEMPERATURE INDICATOR

Install on the input and output of the user parts (exchangers, coils, humidifiers, etc) So that it will be possible to carry out all the service operations.

AUTOMATIC OR MANUAL ESCAPE VALVES

Install the highest points of tubes in a way that the air can escape from the circuit.

BLEEDING COCK

Install them at the lowest points of the circuit, so as to allow emptying.

LEAKAGE TESTS

Before performing the insulation of the tubes, carry out a leakage test.

TUBE INSULATION

All tubes of water must be insulated so that to avoid the formation of condensation and thermal dispersions along the tubes themselves. Verify that the insulation is the vapour coil type. The connections for the air escape and for the emptying must be out of the insulating thickness to assure the accessibility.

CONNECTIONS SUPPORTS

The weight of the hydraulic connections must be supported in the exterior of the unit so as not to stress the connections of user devices (exchangers, coils, humidifiers, etc) .

ANTI-VIBRATION DEVICES

In case of units with anti-vibration devices, it is necessary to assemble elastic joints, even on water connections.

RISK OF FREEZE

If the unit and the relevant water connections are subject to temperatures near 0°C:

- mix the water of the system with glycol
- protect the tubes with heating cables under the tubes insulation
- empty the system by verifying that:
 - no taps are closed so they can not trap the water, even after emptying
 - there are no low points where the water can stagnate even after emptying; blow if necessary

INSTALLATION EMPTYING

The refilling of the water present in the installation increase the oxidation phenomena and lime deposits.

If necessary empty only the interested system section and anyway empty or refill the installation if necessary .

EXPANSION TANK

The installation must be kept at the right pressure by both an expansion tank and a combined valve of pressure reduction and discharge; if the components are present on the unit, they must be installed on the installation. The expansion tank must be dimensioned in function of the water in the installation.

MAX. WORKING PRESSURE = 5,5bar

ARIES EFFECTS AND AIR BUBBLES CAN PRODUCE THE OVERCOMING AND CAUSE WATER DROPS.

EXCHANGER USE SIDE

FILTER

It is very important for the water to be free of impurities. If it is not, the efficiency of thermal exchange is diminished. In worst cases, the exchanger can be irreparably damaged. If the filter is not present on the machine, it must be immediately installed upstream from the unit, in a position which can be easily reached for cleaning.

The filter mesh must be :

- < 1 mm unit with 1 compressor
- < 1.5 mm multicompressor unit.

FLOW SWITCH

The flow switch must be present as a component of the system, so as to ensure shutdown of the unit if water is not circulating. It must be installed in a straight tract of the tubes, not near the elbows, which can generate harmful turbulence

UNFREEZABLE LIQUIDS

If the unit is used when the water temperature is lower than + 4°C, avoid the formation of ice by using unfreezable liquids (ex. Ethilenic Glycol) in the necessary percentage. The use must also be determined for ambient temperatures near 0°C .

ANTIFREEZE RESISTANCES

If the unit is equipped with antifreeze resistances on the exchanger side (standard or optional according to the models), verify that they are electrically fed during periods that the machine is stopped (night, weekends, long stops)

WASHING THE SYSTEM

Carefully wash the system by using clean water and discharge it before connecting the unit.

DIAGRAM OF RECOMMENDED USE SIDE CONNECTION

Depending on the type of machine and the selected setup, some components may be integrated into the unit.

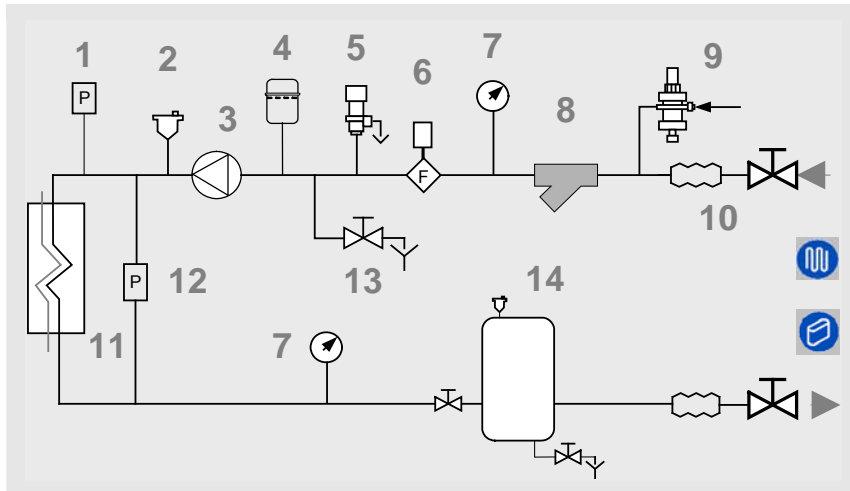

1. Charged system pressure switch
2. vent
3. circulating pump / pump
4. expansion tank
5. safety valve
6. flow switch
7. pressure switch / thermometer
8. filter
9. filling valve
10. antivibration joints
11. user side exchanger
12. Differential pressure switch
13. Discharge cock
14. inertial storage tank

The accumulation tank is necessary in the event of the following:

- the water in the system is very low
- the unit will not be used in a private house (in an industrial process or other)

USE SCHEMA

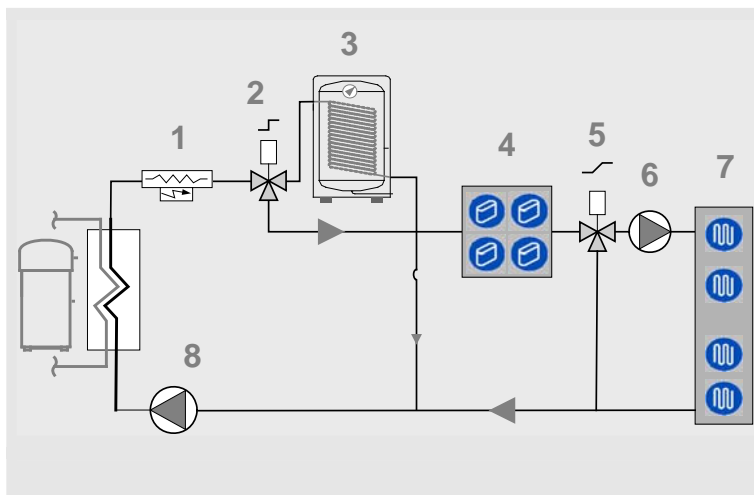

1. Heating integration
2. 3-ways ON-OFF sanitary H2O
3. sanitary boiler
4. fancoil
5. 3-ways radiant panels
6. radiant pump
7. radiants
8. pump / circulating pump

for more details see the ELECTRICAL DATA section

WINTER CONDENSATION

When a heat pump is running it produces a considerable amount of water due to the defrosting cycles of the external coil.

The condensation must be eliminated in a manner to avoid wetting pedestrian areas.

With extensive very cold outdoor temperatures, condensation could freeze and block the flow, causing a slow build-up of ice;

therefore special attention must be paid to eliminating condensation, raising the unit off the ground and evaluating whether antifreeze elements should be installed

For units with condensation trays, refer to the dimensional diagrams to calculate the condensation discharge.

For units without condensation tray, evaluate the suitability of placing a tray beneath the unit base.

ELECTRICAL CONNECTION

GENERAL

The characteristics of the electrical lines and relevant components must be determined by **SPECIALIZED PERSONNEL ABLE TO DESIGN ELECTRICAL INSTALLATIONS**; moreover, the lines must be in conformity with professional procedures and the regulations in force.

All electrical operations should be performed by trained **PERSONNEL HAVING THE NECESSARY REQUISITES UNDER LAW** and being informed about the risks relevant to these activities.

Before performing any operation on the electrical system, make sure that the unit supply line is **SELECTED AT START**.

The earth connection must be made prior to other electrical connections.

For all electrical type operations, **REFER TO THE ELECTRICAL DIAGRAM ATTACHED TO THE UNIT**; the number of the diagram is shown on the registration plate positioned on the electrical board or next to it.

The electrical diagram should be carefully kept together with this manual and should be **AVAILABLE FOR FUTURE INTERVENTION ON THE UNIT**.

LINE OF UNIT POWER SUPPLY

The **ELECTRICAL DATA OF THE UNIT** are shown in the technical chart of this manual and on the unit registration plate. The presence of accessories can vary according to

the unit; the electrical data shown in the technical chart refer to standard units. In the event of differences between the data of the registration plate and the data shown in this manual, as well as in the technical chart, please refer to the **DATA SHOWN IN THE REGISTRATION PLATE**.

The protection device of the unit power supply line should break off the short circuit power whose value should be determined according to the plant features.

The section of supply cables and protection cable must be seized according to the characteristics of the protections used.

SIGNALS / DATA LINES

Do not overpass the maximum power allowed, which varies, according to the type of signal.

Lay the cables far from power cables or cables having a different tension and that are able to emit electromagnetic disturbances.

Do not lay the cable near devices which can generate electromagnetic interferences.

Do not lay the cables parallel to other cables; cable crossings are possible, only if laid at 90°.

Connect the screen to the ground, only if there are no disturbances

Assure the continuity of the screen during the entire extension of the cable.

Observe, if any, the requirements about impedance, capacity, attenuation

STANDARD UNIT ELECTRICAL DATA

VOLTAGE: 230/1/50

Size		17	21	25
F.L.A. - FULL LOAD CURRENT AT MAX ADMISSIBLE CONDITIONS				
F.L.A. - Total	A	11.8	14.7	15.9
L.R.A. LOCKED ROTOR AMPERES				
L.R.A. - Compressor 1	A	37	52	60
F.L.I. FULL LOAD POWER INPUT AT MAX ADMISSIBLE CONDITION				
F.L.I. - Total	kW	2.5	3.2	3.5
M.I.C. MAXIMUM INRUSH CURRENT				
M.I.C. - Value	A	38.3	53.6	61.6

power supply 230/1/50 Hz +/-6%

VOLTAGE: 400/3/50+N

Size		31	41	51	61	71	81	91
F.L.A. - FULL LOAD CURRENT AT MAX ADMISSIBLE CONDITIONS								
F.L.A. - Total	A	8.6	11.9	14.3	15.8	18.1	19.2	21.9
L.R.A. LOCKED ROTOR AMPERES								
L.R.A. - Compressor 1	A	46	50	66	74	101	99	123
F.L.I. FULL LOAD POWER INPUT AT MAX ADMISSIBLE CONDITION								
F.L.I. - Total	kW	4.3	5.5	6.6	7.6	8.6	9.7	11.7
M.I.C. MAXIMUM INRUSH CURRENT								
M.I.C. - Value	A	48.1	51.1	67.3	78.5	105.5	103.5	127.5

power supply 400/3/50 + neutral
Maximum Phase Unbalance: 2%

power supply: 400/3/50 Hz +/-6%

CONNECTION TO THE MAINS

1. Make sure that the sectioning device at the beginning of the unit's power line is opened, locked and equipped with a signal.
2. Open the general line disconnecting switch (if present)
3. Verify that the net is in conformity with the data shown in the registration plate placed on the electrical board.
4. Check the dimensional drawing for the input of the electrical lines
5. Take away the closing plate placed on the electric board (ONLY IF PRESENT) and drill a hole through it to pass the cables through)
6. Protect the cables, using the fairlead of an adequate size.
7. Using the layout of the electrical diagram, single out the connecting terminals of the electrical supply cables, of the neutral (if foreseen) and the PE protection cable
8. Connect the cables to the relevant terminal boards
9. Before supplying power to the unit, make sure that all the safety devices that were removed during electrical connections are positioned again.

SYSTEM COMPOSITION

The system is composed of the following modules; some are optional that could be not installed. Some are supplied in packages separate from the unit: check the shipping document descriptions

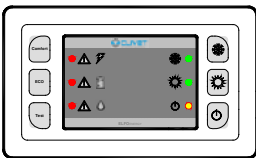
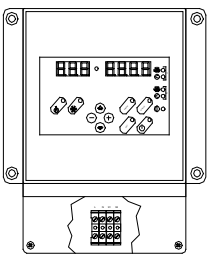
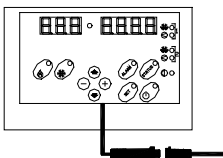
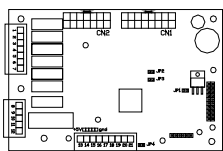
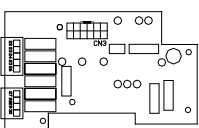
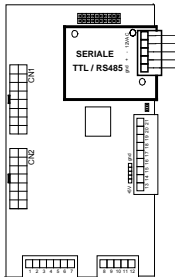
	<p>USER AMBIENT TERMINAL Permits setting the unit function modes (cooling – heating, ECO) and to display the alarms (ELECTRIC, REFRIGERATOR, WATER). This is standard on certain types of unit</p>
	<p>REMOTE KEYPAD OPTIONAL The interface terminal enables to control every machine function, to program the different adjustment parameters and possibly to display the unit statuses and alarms. It remotely repeats all functions available on the machine keyboard</p>
	<p>SERVICE KEYPAD OPTIONAL Useful during the maintenance operations; it is fitted with a cable with automotive rapid connector for the utilization in proximity to the unit. The functionalities are analogous to the remote keypad ones.</p>
	<p>MAIN ADJUSTMENT MODULE It controls unit (inlets, outlets, configuration parameters)</p>
	<p>EXPANSION PLUG-IN MODULE It is connected to the main module by a coupling comb. This may be fitted on the unit depending on the unit type and the accessories that are installed.</p>
	<p>SERIAL CONVERTER TTL/RS485 OPTIONAL Plugged-in in the main module on the electric board (see lay in the wiring diagram). It is possible to connect up to 127 units with a single supervision system. The connection with a PC must use a RS485/232 converter; the serial line RS232 can be max. 10-m long. CONNECTIONS: make reference to the electrical panel and to the SIGNALS AND DATA LINES paragraph</p>

FUNCTIONAL CONNECTIONS

FOR ALL THE CONNECTIONS MAKE REFERENCE TO THE ELECTRICAL PANEL SUPPLIED WITH UNIT

Use voltage-free remote control devices that are suitable to commutate very low loads (12V, 10mA)

Few inputs must be activated by configuration parameters whose access is reserved to authorized assistance centres (in order to avoid unauthorized modifications)

1. remote ON / OFF
2. remote SUMMER / WINTER
3. remote SECOND SET POINT (ECO)
4. Machine OPERATION / SHUTDOWN SIGNAL
5. REMOTE KEYPAD
6. ELECTRIC INTEGRATION during heating
7. coupling with BOILER
8. SANITARY HOT WATER
9. UNDERFLOOR HEATING
10. SET POINT COMPENSATION for outside temperature/enthalpy
11. SET POINT COMPENSATION with 4-20 mA signal
12. interface via RS485

1. ON / OFF FROM REMOTE CONTROL

Generally the unit is delivered with bridged terminals; if the control is not used, the bridge should not be removed

2. CHANGING FROM SUMMER TO WINTER USING THE REMOTE CONTROL

This function is activated with the 163 remmode = 1 parameter.

Selection switch open – unit in heating mode, selection switch closed – unit in cooling mode, this way the keyboard or supervisor unit selection is deactivated.

3. SECOND SET POINT FROM REMOTE CONTROL (ECO)

Use of a second set point (par 29 cooling, par 30 heating), usually higher in summer and lower in winter (ECO). The commutation can be also performed manually by keypad.

The SANITARY HOT WATER option may entail modifications of the input in question: see the relative section.

4. SIGNALIZATION OF MALFUNCTIONING/ UNIT FUNCTIONING

Remote signalisation of the proper function (ex. green light) or signalisation of blocks of the machine (ex. red light). Maximum voltage at the terminal ends is 24v ac and maximum power is 1A (ac1) .

5. REMOTE KEYPAD

Max. Length	100 metres
VOLTAGE	230/1/50
Signal conductor number	2 + shield
Min. length	0.34 mm ²

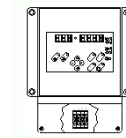

6. ADDITIONAL HEATING ELEMENT

It is possible to control an external element for additional heating, typically electric heaters.

The control can be:

- ON-OFF (max 1 A)
- modulating WITH SIGNAL 0-10 V

(in this case a plug-in expansion module is necessary, an optional that must be assembled by the customer (refer to the instructions in the kit) and enabled with the parameter 140=1
The diagram on the side is indicative: check the position of the water connections on the dimensional drawing of the unit or on the adhesive labels on the unit itself

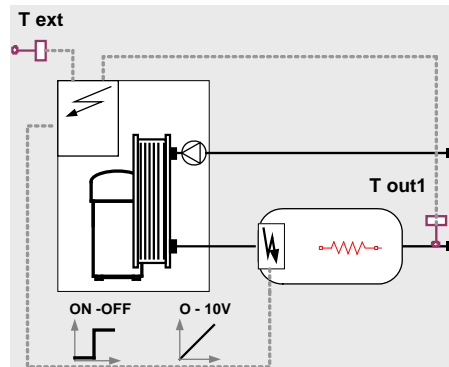

The parameters 178 and 179 can be used to select the behaviour of the heaters:	P 178	P 179
AS AN ADDITIONAL ELEMENT ONLY the heaters are considered as a second power step	1	0
IN REPLACEMENT OF THE COMPRESSOR the heaters operate only when the compressor is disabled due to an external temp. lower than par. 180	1	1
MAIN ADJUSTMENT UNIT IN HEATING MODE in heat pump mode the compressor is disabled	2	1
POWER LIMITATION ACCORDING TO EXTERNAL TEMPERATURE the following behaviour occurs as the external temperature decreases: 1st Zone = Compressor Enabled / Heaters Disabled 2nd Zone = Compressor Enabled / Heaters Enabled 3rd Zone = Compressor Disabled / Heaters Enabled	2	2

It is necessary to declare the presence of the outlet probe **Tout 1** with par. 70 = 1.

This probe becomes the reference for heat adjustment in heating mode; furthermore it manages the antifreeze protection for this part of the system.

par	Description	Meaning	value
70	Tout1En	Enables output probe	
140	PlugInEn	Enables PLUG-IN presence . 1=YES / 0=NO	
177	PotRes	Power provided by the additional heaters	100
178	ModeHeater	Enable compressor operation in heating	0
179	LimPotTextEn	Enable capacity limit for ext. temperature	0
180	LimText	Ext. temperature limit for compressor operation	0
181	IstRes	Differential on LimText value for heaters activation	5

7. COUPLING WITH BOILER

This function allows the unit to be coupled to a boiler with "high temperature" thermostat setting (70 °C for example), i.e., with a working point above the operating limits of the unit.

The coupling to the boiler is managed using:

- the external air temperature probe **Text** that disables the unit and activates the boiler for external temperatures less than the threshold set by parameter 88
- valves **YV1** and **YV2** that disconnect the unit from the system when the water temperature of the system detected by the probe **Tout1** is above the operating limit set by parameter 86

It is not possible to switch to the boiler in case of unit shutdown.

MAINTENANCE

With the unit coupled to a boiler the maintenance function, if enabled, activates the boiler instead of the heat pump if necessary.

The diagram on the side is indicative: check the position of the water connections on the dimensional drawing of the unit or on the adhesive labels on the unit itself.

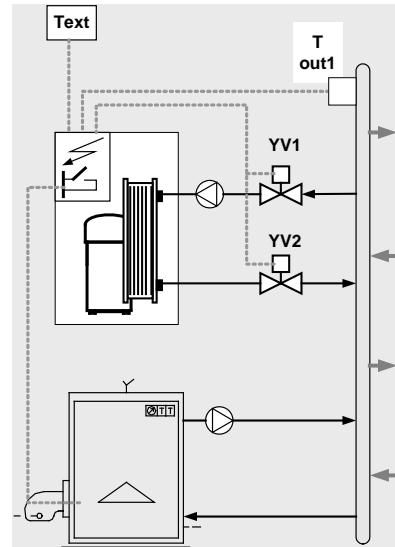

Par	Description	meaning	Default	U. m.
85	CaldaiaEn	Enable Boiler+Heat Pump Function	0	float
86	SogliaMaxImp	Water temperature value above which the heat pump is disabled and the output YV1 / 2 remains energized	55	°C
87	IsteresiSMI	Hysteresis for heat pump activation and YV1 / 2 deactivation	2	°C
88	SogliaExt	External temperature threshold below which the Boiler is enabled	-5	°C
89	IsteresiExt	External temperature hysteresis for heat pump activation	3	°C
70	Tout1En	Enable probe output		

8. CONTROL OF THE 3-WAY VALVE FOR SANITARY HOT WATER

Sanitary hot water can be produced in summer and winter, based on an **external request**, by controlling a dedicated 3-way valve.

When the contact is closed, the valve switches to the sanitary hot water storage and the unit changes its working set point to the sanitary hot water set point (par 117).

The passage from SANITARY HOT WATER mode to COOLING (or vice versa) is timed and occurs only when the temperature of the water has dropped below the safety limit defined by parameter 108.

Similarly, in the passage from SANITARY HOT WATER to HEATING the switching occurs when the temperature of the water has increased beyond the safety limit defined by parameter 109.

This function requires the optional **plug-in expansion module** that must be assembled by the customer (refer to the instructions in the kit) and enabled with the parameter 140 = 1.

To enable the SANITARY HOT WATER management in summer as well, par. 119 must be = 1

If the SANITARY HOT WATER set point is satisfied but the external request remains active, the **INCONGRUENT THERMOSTAT C36 shutdown is signalled**: the sanitary hot water boiler thermostat must be set to the same value as the sanitary hot water set point of the machine.

If remote control will also be used for the SECOND SET POINT, it is necessary to set par. 50 = 2. In this mode the inputs on the main card will be configured as follows:

- CN1_10/11 sanitary hot water request
- CN1_14/16 second set point

Refer to the wiring diagram to identify the corresponding terminals

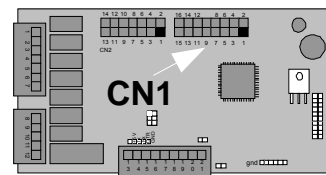
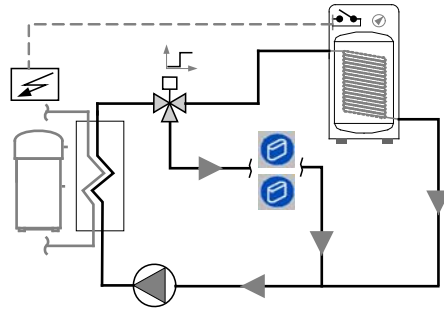

PLUG IN module

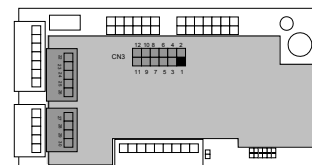

par	Description	Meaning	value
49	Comando2°Set	Mode control 2° set point by parameter	0
50	EnH2OSanitaria	Enabling sanitary water valve management	0
108	TlimiteCool	H2O input value below which the compressor is enabled in cool mode	21
109	TLimiteHeat	H2O input value above which the compressor is enabled in heat mode	25
117	SetH2OSanitaria	Set Point sanitary water	35
119	ModeEnable	Configure operation mode	
140	PlugInEn	Enables the PLUG-IN presence. 1=YES / 0=NO	

With par. 50 = 1 the management becomes the following:

- CN1_10/11 unconfigured
- CN1_14/16 second set point / sanitary hot water

MODE	INPUT 2° set point on the main board	VALVE POS.	SET POINT	2° SET POINT
HEATING	ON	to the installation	set heat	2° set point heat *
SANITARY WATER	OFF	to the boiler	SetH2OSanitaria	Not manageable
COOLING	ON	to the installation	set cool	second set point cool *

In this mode the 2nd set point (ECO) cannot be enabled by remote consent; it can be enabled from the LED keypad with the ECO key or by setting parameter 49 = 1

SANITARY HOT WATER: COMPENSATION OF THE SET POINT FOR EXTERNAL TEMPERATURE

The set point can be compensated according to the external temperature in 2 modes:

- hot season thermal efficiency curve
when the external temperature is high, the sanitary hot water set point is decreased; in this manner the thermal efficiency is increased
curve A in the graph the compensation is enabled in the standard configuration
- compressor operation limit
when the external temperature is particularly cold, the sanitary hot water set point is decreased in order to guarantee operation of the compressor even near its operation limits curve B in the graph the compensation must be enabled during start-

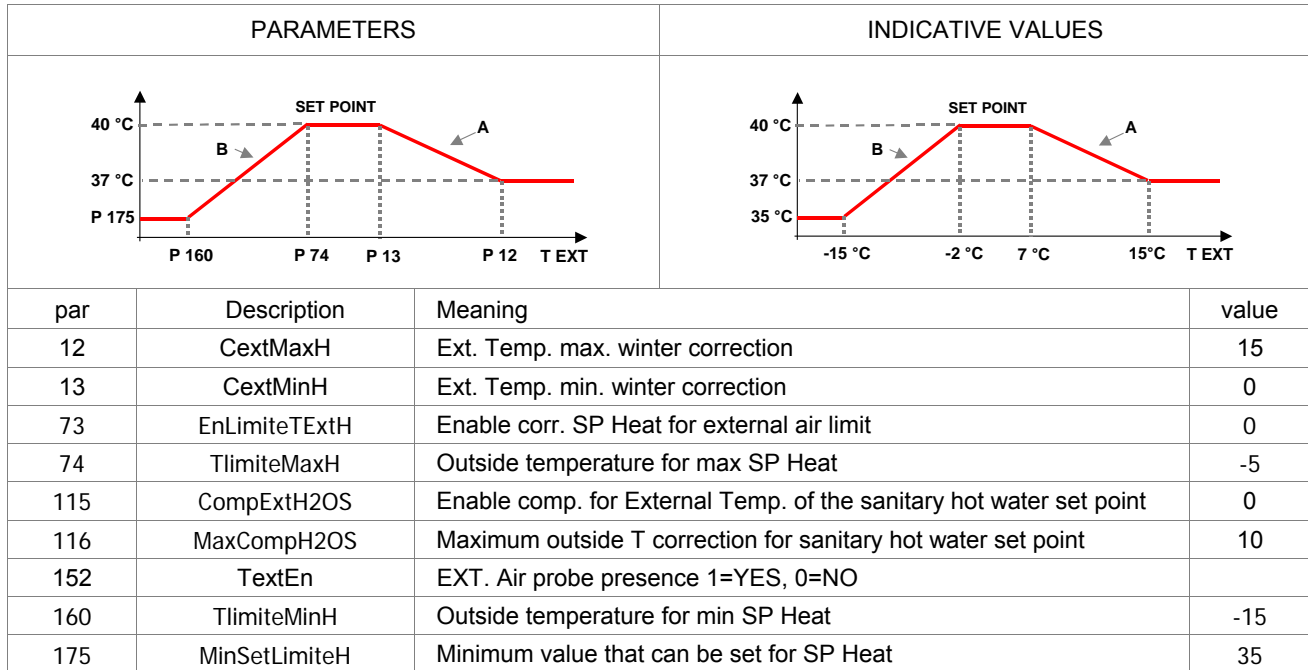

9. DUAL CONTROLS FOR TEMPERATURE – RADIANT PANELS

It is necessary the expansion **plug-in module** that must be fitted by the client (r refer to the kit instructions) and enabled by parameter 140 = 1.

With the optional kit, the mixed elements can be controlled: fan coils + radiant panels:

- Radiant panel circulator
- Mixing valve (0-10 volt or ON-OFF)
- Delivery probe (NTC type, 10 Kohm at 25°C)
- External control: COOLING/HEATING LIMIT (avoids dew / overheating).

ATTENTION: to prevent dew in summer or superheating in winter, it is very important to fit an external device and interface it with the unit that in case of signalling will force the recycling valve on the radiant panels.

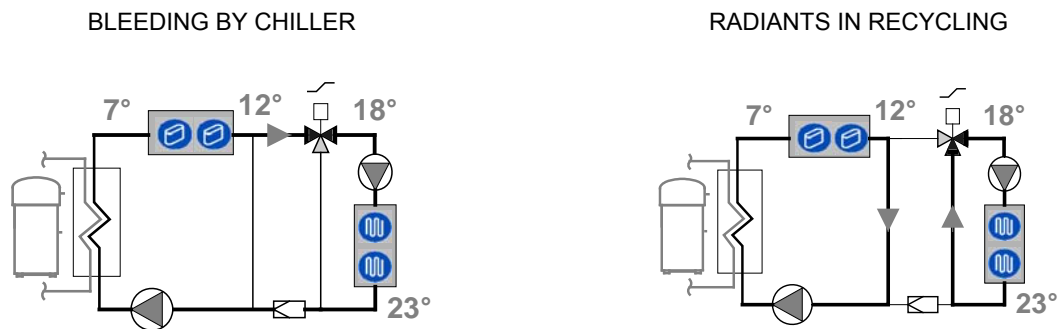

Output status on the optional plug-in module

valv 0-10	10 volt	valv 0-10	0 volt
3-point valve	out 22-23 = ON	3-point valve	out 22-23 = OFF
	out 22-25 = OFF		out 22-25 = ON

The water set point at the radiant panels can be managed in three ways:

1. the valve is managed to maintain the outlet temperature at par 192 value, independently of the unit operating mode (COOLING or HEATING).
2. calculated automatically in function of the external air temperature; two set are calculated (HEAT. / COOL.) that become actives on the basis of the unit operating mode. This configuration is obtained setting par 190=1

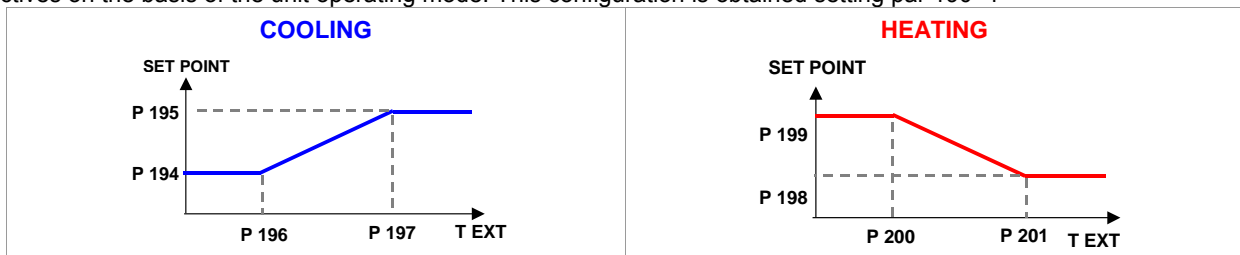

3. the installation maintains the summer set point at a value higher than the critical one, to avoid the dew formation on the floor. The unit can be connected via MODBUS to an external device (for example ELFOCONTROL) that transmits the temperature values and the ambient humidity. This configuration is obtained setting par 191 = 1.

If the unit is at service of an installation only for radiant panels (without mixing valve and fan coil) modify the following pump configuration parameters:

par	Description	Original value	Correct value
183	MaxTempC	12	8
184	MinTempH	12	8
185	IstTempC	4	2
186	IstTempH	4	2

10. SET POINT COMPENSATION WITH 4-20 mA SIGNAL (WATER RESET)

It optimizes the energetic efficiency of the unit by automatically changing the set-point according to an external signal of 4-20 ma type.

It requests the **expansion plug-in module** option that must be fitted by the client (refer to the kit instructions) and enabled by parameter 140 = 1.

This function must be enabled with parameter18 (=0 not enabled, =1 only summer, = 2 only winter, = 3 summer and winter)

par	Description	Meaning	value
18	WaterReset	Water Reset enabling 0=No 1=Cool 2=Heat 3=Always	0
19	MaxCWRH	Max. value of the Winter WR correction	10
20	SWRMAXH	Corresponding signal of the winter max. correction	4
21	SWRMinH	Corresponding signal of the winter min. correction	20
22	MaxCWRC	Summer correction max. value	8
23	SWRMaxC	Corresponding signal of the summer MAX. correction	20
24	SWRMinC	Corresponding signal of the summer MIN. correction	4
140	PlugInEn	Enables PLUG-IN presence . 1=YES / 0=NO	

SET POINT CURVE IN COOLING

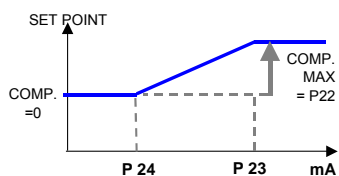

SET POINT CURVE IN HEATING

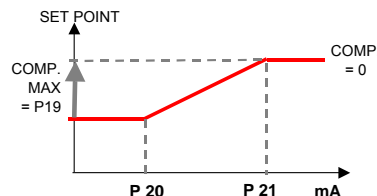

11. SET POINT COMPENSATION ON THE TEMPERATURE OR EXTERNAL ENTHALPY

Optimises unit energy efficiency by automatically adjusting the set-point according to enthalpy or the external temperature.

Requires the **external humidity probe** or the **external temperature probe**, which are optional for certain types of units and must be installed by the customer and enabled by parameters 152=1 and 156=1.

par	Description	Meaning	value
9	CompExt	External temp. comp. enabling 0=No 1=Cool 2=Heat 3=Always	0
10	CextMaxC	Ext. Temp. max. summer correction	15
11	CextMinC	Ext. Temp. min. summer correction	30
12	CextMaxH	Ext. Temp. max. winter correction	15
13	CextMinH	Ext. Temp. min. winter correction	0
14	MaxCExtC	Summer correction max. value	8
15	MaxCExtH	Winter correction max. value	10
16	HExtMinC	Ext. enthalpy min. correction	10,5
17	HExtMaxC	Ext. enthalpy max. correction	13,5
152	TextEn	EXT. Air probe presence 1=YES, 0=NO	
156	URProbeExt	Enables external UR% probe. 1=YES, 0=NO	

SET POINT CURVE IN COOLING

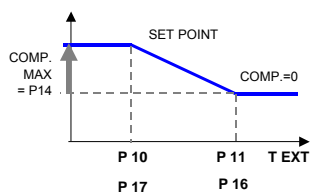

SET POINT CURVE IN HEATING

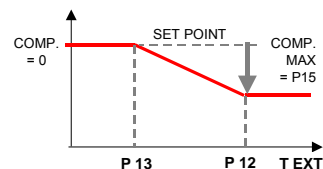

12. UNIT INTERFACE VIA RS 485

Below the indications for the serial connection ; refer anyway to the CLIVET “RS 485 NETWORKS – GUIDELINES” document and ask for the COMMUNICATION PROTOCOL about the COMPACT electronics

- The total length of each single serial line, don't have to be over 1000 metres
- The potential difference between the “ground” of two RS485 switches must be less of 7 V
- Couple of conductors twisted and shielded
- Section of conductor $0.22\text{mm}^2 \dots 0.35\text{mm}^2$
- Nominal capacity between conductors $< 50 \text{ pF/m}$ nominal impedance 120Ω
- Recommended cable BELDEN 3105 A

TYPE OF NETWORK

The serial lines must be connected in bus typology, i.e. nodes to more points are not admitted

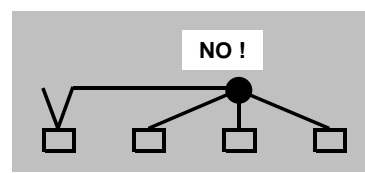
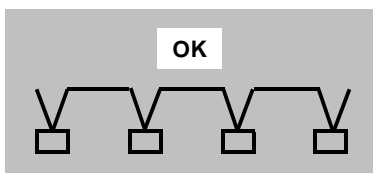

SHIELD

- It must be connected to a ground without disturbances
- Connected to ground in only one point
- Provide to the shield continuity during all the serial cable extension.

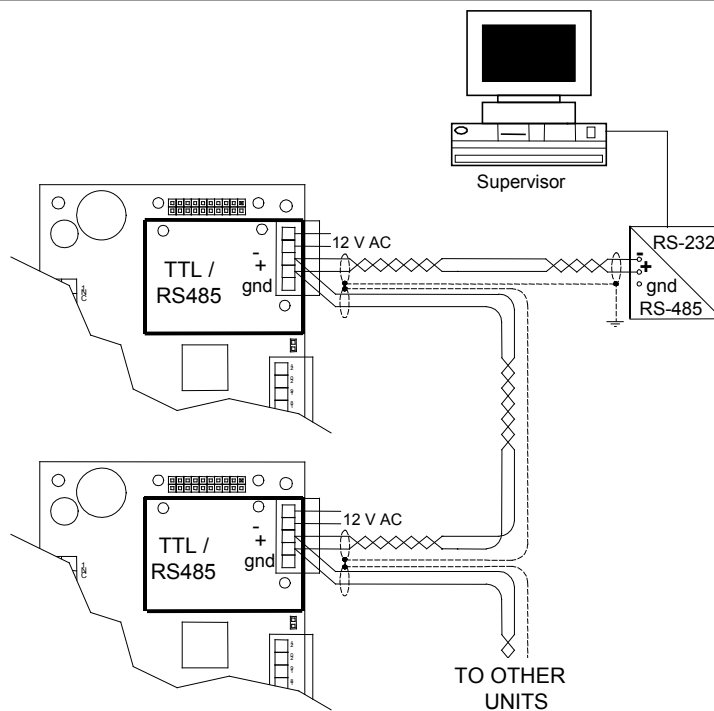
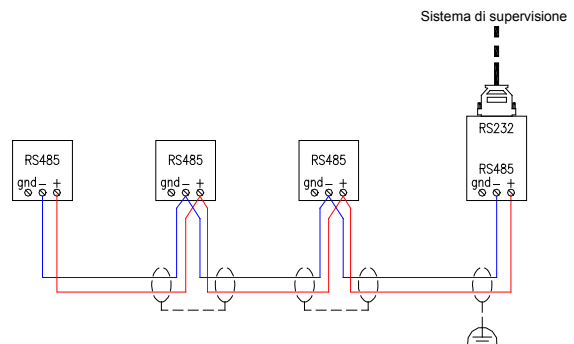

START-UP

ALL THE EQUIPMENT MUST BE COMMISSIONED BY AUTHORISED SERVICE CENTRES.
THIS SERVICE IS LIMITED TO START-UP OF THE UNIT ONLY AND NOT THE CONNECTIONS OR INSTALLATION OF THE SYSTEM.

ONLY QUALIFIED TECHNICIANS MUST PERFORM THE FOLLOWING OPERATIONS.

PRELIMINARY CHECKS

Before checking, please verify the following

1. the unit should be installed properly and in conformity with this manual.
2. the electrical power supply line should be sectioned at the beginning.
3. the sectioning device is locked and the proper warning "not to operate" sign is placed on the handle.
4. make sure no tension is present
5. the coils must be clean and free of obstacles
6. the ventilators must be free of leaves, cardboard, fixed obstacles (beams, barriers, etc.), snow, etc
7. the external ventilators must not be blocked

The external ventilators can be subject to a temporary block, especially if the inactivity period before the first start-up was quite long or if outside temperature is very low. It is also possible to unblock them manually (ONLY WHEN THE UNIT IS UNPLUGGED – RISK OF INJURES) so that jams or electric overloads are avoided when the unit is restarted.

REFRIGERANT SYSTEM

Carefully check the refrigerating circuit: the presence of oil stains can mean leakage caused by transportation, movements or other).

Open the cocks of the refrigerator circuit, if there are any.

Using the unit manometers, if present, or service manometers, verify that the refrigerating circuit is in pressure.

Make sure that all the service outlets are closed with proper caps; if caps are not present a leak of refrigerant can be possible.

WATER SYSTEM

Ensure that the plumbing system has been washed. Drain the wash water before connecting the unit to the system.

Check that the water circuit has been filled and pressurised.

Perform a seal check at max. working pressure checking that no leaks are present.

Check that the shut-off valves in the circuit are in the "OPEN" position.

Check that there is no air in the circuit. If required, bleed it using the vent valves in the system.

Check that there are no ARIES EFFECTS in the transient (pump and / or valve activation/deactivation)

When using antifreeze solutions, make sure the glycol percentage is suitable for the type of use envisaged.

% weight of ethylene glycol	10 %	20 %	30 %	40 %
Freezing point	- 4 °C	- 9 °C	- 15 °C	- 23 °C
Safety temperature	- 2 °C	- 7 °C	- 13 °C	- 21 °C

Check that the circulator pumps are not blocked. In fact, their motor shaft may seize up, especially after long shutdowns. Unblocking can be accomplished with a screwdriver using the purge hole.

ELECTRICAL SYSTEM

Check the proper tightening of the screws that fix the conductors to the electrical components in the board (during handling and transportation, the vibrations could have loosened them).

Verify that the unit is connected to the ground plant.

Control that all panels and protection devices of the unit are repositioned and blocked.

Charge the unit by closing the sectioning device, but leave it on OFF.

Make sure that the tension and net frequency values are within the limit of:

230 +/- 6% single phase unit; 400/3/50 +/- 6% three-phase unit

Control the unbalancing of the phases: it must be lower than 2% .

Example:

L1 - L2 = 388 V, L2 - L3 = 379 V, L3 - L1 = 377 V

average of the measured values = $(388 + 379 + 377) / 3 = 381$

maximum deviation from the average = $388 - 381 = 7V$

Unbalancing = $(7/381) \times 100 = 1.83\% = \text{ACCEPTABLE}$

Operating out of the indicated limits causes the loss of the guarantee as well as very serious damages.

IF THE CRANKCASE RESISTANCES ARE FITTED

when the unit is started up for the first time and following all prolonged periods of inactivity is OBLIGATORY to connect the oil resistances on the compressor crankcase at least 8 hours before the compressor is to be started.

BEFORE POWERING THE RESISTANCES, OPEN THE COMPRESSORS COCKS, IF PRESENT.

To supply the resistances is necessary to switch off the isolator switch on the unit.

To make sure that the resistances are working, check the power input with amperometric pliers.

At start-up the compressor crankcase temperature on the lower side must be higher at least of 10°C than the outside temperature.

DO NOT START THE COMPRESSOR WITH THE CRANKCASE OIL BELOW OPERATING TEMPERATURE.

VERIFY TENSIONS – ABSORPTIONS

Check that the temperatures of the fluids are included in the WORKING LIMITS.

If the controls of the previous paragraphs are positive, it is possible to restart the unit.

For information on the control panel, refer to the paragraph CONTROL.

While the unit is working (ATTENTION ELECTRIC RISK: WORK SAFELY) check:

- Power supply tension
- Phase unbalance
- Total absorption of the unit
- Absorption of the single electric loads

UNIT EQUIPPED WITH SCROLL COMPRESSORS

The GENERAL TECHNICAL DATA table shows the type of compressor on the unit.

The Scroll compressors have only one direction of rotation.

In the event that the direction is reversed, the compressor will not be damaged, but its noisiness will increase and pumping will be negatively affected. After a few minutes, the compressor will stop because of the activation of the thermal protection. In this event, cut the power and reverse the 2 phases on the machine power.

Prevent the compressor from working with in reverse rotation: more than 2-3 anomalous starts up can damage it.

Make sure the direction of rotation is correct, measure the condensation and suction pressure. Pressure must clearly differ: at the start, the suction pressure decreases whilst the condensation pressure increases.

The phase optional monitor, which controls the phase sequence, can be installed later.

REMOTE INPUT CONFIGURATIONS

Check used remote inputs are activated (ON-OFF etc.) as given in the instructions in the ELECTRIC WIRING chapter.

SETTING THE SET-POINT

Check if it is necessary to modify the set-points shown in the CONTROL chapter

EVAPORATOR WATER FLOW RATE

Check that the difference between the temperature of exchanger return and supply water corresponds to power according to this formula:

unit cooling power (kW) x 860 = Dt (°C) x flow rate (L/h).

The cooling power is shown in the TABLE ON GENERAL TECHNICAL DATA included in this manual, referred to specific air/water conditions, or in the tables on cooling PERFORMANCE IN THE TECHNICAL BULLETIN referred to various conditions of use.

Check for water side exchanger pressure drops:

- Determine the water flow rate.
- Measure the difference in pressure between exchanger input and output and compare it with the graph on WATER SIDE EXCHANGER PRESSURE DROPS.

The measurement of pressure will be easier if pressure gauges are installed as indicated in the DIAGRAM OF SUGGESTED WATER CONNECTIONS .

REFRIGERANT CIRCUIT PARAMETER CHECK

Detecting the operational conditions is useful to control the unit along time: the performed records must be kept and be available during maintenance interventions.

When the unit works in stable conditions and according to the operating limits, take note of the following data:

1. compressor discharge temperature (WARNING – BURN DANGER)
2. condensing pressure
3. liquid temperature
4. dehydrator filter upstream and downstream temperature
5. return pressure
6. return temperature
7. exchanger input water temperature
8. exchanger output water temperature
9. fresh air temperature (coil input)
10. air temperature coming out from fans

CONTROL

The HEATING mode functions are active only on HEAT PUMP unit version .
 In ONLY COOL units, the relative parameters are VISIBLE but NOT ACTIVE , for example the winter setpoint.

OPERING MODES

ON – OFF	Unit can be switched on and off by: <ul style="list-style-type: none"> • keypad • remote switch (see ELECTRICAL CONNECTIONS paragraph) • Supervisor
COOLING	The compressor is activated with outlet temperature higher than set point
	To switch from cooling to heating and vice versa, proceed as follows: <ul style="list-style-type: none"> • Turn the unit OFF • Wait until the plant water temperature (and external air) fall within the operating limits. They can be switched over from the remote controls (refer to the ELECTRIC WIRING paragraph).
HEATING	The compressor is activated with outlet temperature lower than set point
ECO	A secondary set-point can be used, with respect to the comfort setting
MAINTENANCE	the plant can be kept within the operating limits even when the unit is OFF or on STANDBY
DEFROSTING	The external coil is free from ice stopping the fans and forcing for a short period the unit in cooling
SANITARY H2O PRODUCTION	A specific set point is used, higher than the HEATING set (see ELECTRICAL CONNECTIONS paragraph).

CHARACTERISTICS

THERMOREGULATION

The thermoregulation is based on the OUTLET temperature.
 The unit is dimensioned for a determined TOTAL HEAD between input and output water temperature.
 Usually the project step is 5°C; if the value is different, it is necessary reset parameters 37 and 38 (accessible to the service centre).
 In function of the total head, the installation determines the head quote that every resource (compressor, heating elements) is able to provide: the STEP HEAD.
 The control logic insert gradually the resources when the outlet temperature is higher than the set point + the head step.
 The resources are activated one at a time and only at the SCAN TIME expiring.
 The scan time is not fixed but it changes in function of the margin between the water outlet temperature and the Set point value. Higher is the margin value (both in positive and in negative) shorter will be the space among the scan points.
 The scan time value is visualized at status 4; when the status 3 has reached the status 4 value, the compressor operating request is activated.
 What above described, refer to the COOLING operating; in HEATING the logic is the same but “overturned” (compressor insertion for outlet temp. < set-point –step head).

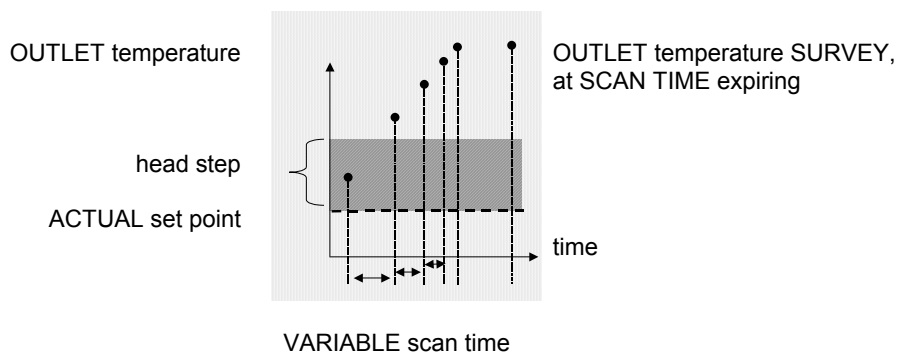

SET-POINT COMPENSATIONS

The compensations are evolved functions to protect the compressors and to adapt, as far as possible, the unit operating to the installation and use characteristics.

The compensations prolong the compressor operating time and limit the start number; to do this they delay the compressor insertion point adding an offset.

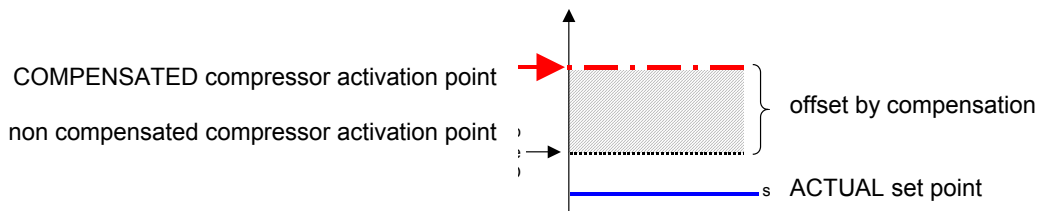

- The compensation on the DURATION is useful when the installation water content is limited.
- The compensation on the CHARGE is useful if the variable charge is present.

For the enabling and the configuration is necessary the parameter modification with reserved access to the service centres. In industrial applications where is requested a temperature check is possible to disable the COMPENSATIONS.

SET-POINT CORRECTIONS

The correction aim is to optimize the unit energetic efficiency.

To do this the corrections modify the set point in a dynamic way in function of determined variables: for example in summer operating with low external temperatures, so with a reduced charge, is possible to obtain the internal comfort also with set point higher than standard, obtaining a higher energetic efficiency.



The static set point can so be modified in a dynamic way by two CORRECTIONS based on as many unit external factors:

- correction based on the ext. temp. / enthalpy
- correction based on the Water reset (4-20 mA signal provided by the Client)

The correct set point, to whom have been summed or removed the corrections, is named ACTUAL set-point and it is visible at status n°1.

The STATA menu visualizes the compensation value on the ext. temperature (status 5) and WR (status 6)

For further details see the ELECTRICAL CONNECTIONS section.

SET POINT CORRECTION FOR COMPRESSOR OPERATING LIMIT

The function is active only in HEATING; it allows extending the operating limits decreasing gradually the set point when the external temperature descends more than determined limits.

In the graph, the correction action is indicated by the curve left side (B).

The curve right side (A) represents the correction state on the external temperature (optional, see the ELECTRICAL CONNECTIONS section).

The following data are indicatives .

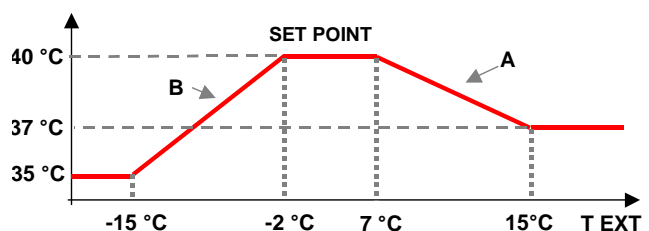

DEFROSTING

The defrosting aim is to maintain the external coil free from ice during the winter mode : to do that the unit is periodically commuted in "summer" mode for few minutes and the fans are stopped.

The defrosting phase is started when the evaporating pressure falls below a fixed value . A count starts and at its end, if the temperature on the coil is lower than the threshold, the defrosting starts .

The count changes according to the external temperature and to the ice quantity on the coil (by some indirect variables) .

When defrosting is complete, the unit returns automatically to the Winter mode.

Defrosting is managed according to the external temperature and humidity in the air:

- more humidity = frequent defrosting
- external temperature next to 0°C = frequent defrosting

By the EXTERNAL HUMIDITY PROBE option cod PE2N0005 the defrosting is optimised according to the external temperature and humidity .

CIRCULATION PUMP

The pump is always activated with the units ON.

The delivery capacity is variable to soften the thermal shock to the compressors when the plant temperature is close to the threshold limits.

Delivery capacity depends on the intake temperature:

- SUMMER: high water temperature reduces delivery
- WINTER: low water temperature reduces delivery

CIRCULATION PUMP – CONDENSER (RUNNING WATER)

The pump is started BEFORE the compressor start and stopped AFTER the condenser stop .

VENTILATION

Fans are controlled with a variable speed:

- in SUMMER, the speed increases according to the increase of external air temperature
- in WINTER the speed increases according to the decrease of the external tempe

SET POINT

SUMMER - WINTER

The thermoregulator manages two set points:

- SUMMER set-point for cooling (parameter 32)
- WINTER set-point for heating (parameter 33)

The control is performed on the OUTLET TEMPERATURE, comparing it with the actual set-point value (visible at status 1).

SET-POINT CALCULATION:

- desired medium outlet water temperature = 7°C
- Project temperature differential = 5°C (that is inlet water = 12°C)
- $\frac{1}{4}$ of the project temperature differential = $5 / 4 = 1.25^\circ\text{C}$
- set-point to be set = $7 - 1.25 = 5.7^\circ\text{C}$

SECONDARY SET POINT – ECO

A secondary set point can be used with different levels to the “normal” set point.

It is normally set to give lower energy consumption with respect to the comfort setting:

- The SECONDARY SUMMER set point is higher than the SUMMER setting.
- The SECONDARY WINTER set point is lower than the WINTER setting.

It can be set according to individual requirements.

- Secondary summer set-point parameter 29
- Secondary winter set-point parameter 30

It can be activated from the keyboard, supervisor unit or the remote control. To change it using the remote control refer to the ELECTRIC WIRING paragraph.

MAINTENANCE

This way, the plant can be kept within the operating limits even when the unit is OFF or on STANDBY, for example during the weekend or the night-time.

Periodically the system activates the circulation pump, measures the water temperature and activates the compressor, if required, to take the water temperature to the set-point level.

- Summer maintenance set-point par 42
- Winter maintenance set-point par 43

This function is activated by parameters 44 (activate summer maintenance level) and 45 = 1 (activate winter maintenance level).

In this mode on the service keypad is displayed : STB

DUAL CONTROLS FOR TEMPERATURE – RADIANT PANELS

With the optional kit, a mixed plant can be controlled:

- Fan coil (with the set-points seen above)
- Radiant panels (with specific radiant set-points)

The radiant set point can be determined in different ways, for further details see the ELECTRICAL CONNECTIONS section.

FUNCTIONING WITH ETHYLENE GLYCOL

The units foreseen to function with glycoled water come out from the premise with standard parameters. After having added glycol ethylene to water, the technician will properly set the plant.

Parameter to modify	
32	Summer set point
77	Antifreeze heater set
80	Antifreeze alarm
84	Antifreeze pre-alarm threshold

USER REMOTE KEYPAD

The keyboard allows visualizing and changing the functioning conditions of the unit. The service keyboard is needed to visualize or modify the functioning parameters.

BUTTON FUNCTION

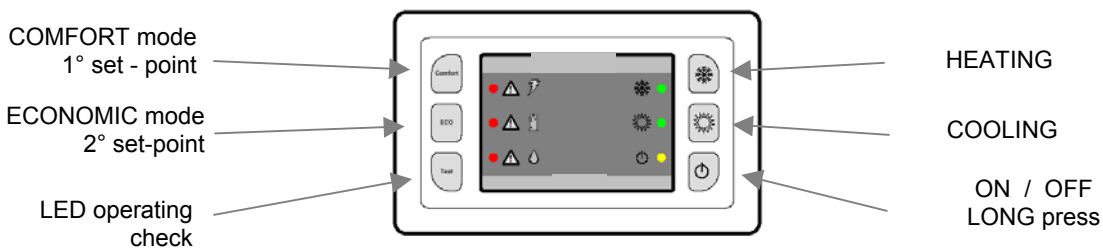

LED MEANING

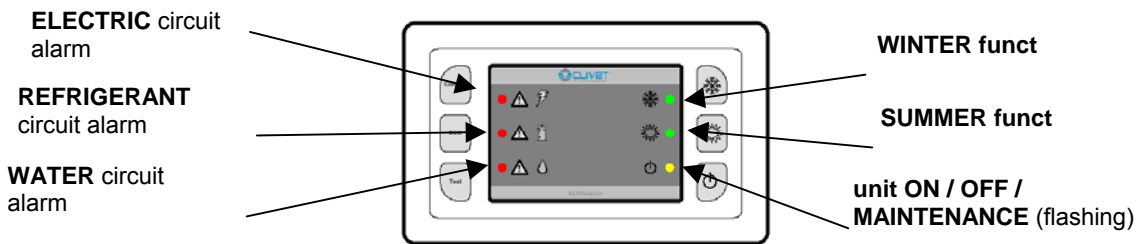

SANITARY HOT WATER PRODUCTION SIGNAL

For the machine types that manage sanitary hot water production, the status is displayed with the WINTER and SUMMER operation LEDs:

WINTER	SUMMER
ON	FLASHING

ON - OFF

The ON-OFF control from the keyboard allows activating or deactivating the normal functioning of the unit.

SETTING THE OPERATING MODE

COOLING: to set the SUMMER operating mode, press the key for a few moments. When the mode has been activated, the corresponding green led lights up.

HEATING: to activate the WINTER operating mode, press the key for a few moments.

When the mode has been activated, the corresponding green led lights up.

MAINTENANCE: The operating mode leds remain alight even when the machine is in the maintenance status. The maintenance set-points (if activated) control the water temperature when the unit is OFF or on STANDBY. To do this, the circulation pump is periodically activated, which tests the water temperature and activates the compressor if required.

SELECTING OPERATING TEMPERATURE

COMFORT: to select the COMFORT temperature for the current operating mode, press the COMFORT key. The set point is only displayed on the machine.

When this mode is activated, the led to the left of the key lights up and remains alight.

ECO: to select the ECONOMIC temperature for the current operating mode, press the ECO key.

In the winter this reduces the set point and increases it in the summer.

When this mode is activated, the green led to the left of the key flashes slowly.

ALARMS

FLASHING LED: there is an anomaly at the AUTOMATIC reset

FIXED LIGHT LED: there is an anomaly at the MANUAL reset

ALARM RESET: TEST + ON/OFF keys pressed simultaneously for more than 2 seconds.

Alarm type:



ELECTRICAL CIRCUIT ALARM

- Inlet probe
- Outlet probe
- Radiant panel water probe
- Coil/flow probe
- External probe
- Pressure 1 probe
- Water reset inlet
- External relative humidity probe
- Phase monitor
- Electric heater output probe

Allarme serial faulty



REFRIGERANT CIRCUIT ALARM

- HP
- LP
- CCMP/VENT
- HP1 Pre-Alarm
- BP1 Pre-Alarm

Allarme serial faulty



WATER CIRCUIT ALARM

- Flow pump
- System charged with water
- Antifreeze alarm
- Antifreeze PREAlarm
- Pump alarm
- C1 PREAlarm
- PRad. Cooling limit alarm
- PRad. Water frost alarm
- Coil frost alarm
- Alarm ?T° incongruous
- Electric heater antifreeze alarm
- Allarme serial faulty

FUNCTIONING TEST

The "Test" key allows the verification of the proper functioning of the all six signalisation LEDs.

When it is pressed, all leds are ON until the key is released.

REMOTE OR SERVICE KEYPAD (OPTIONALS)

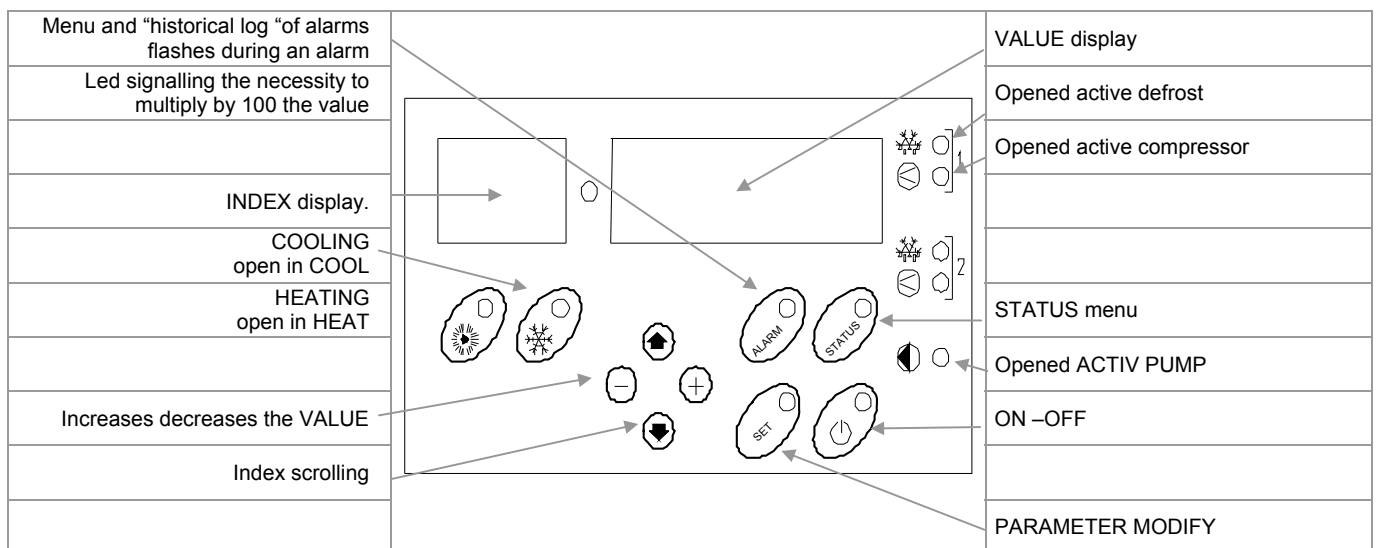

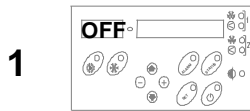

1 unit in OFF.
by keypad
by supervisor

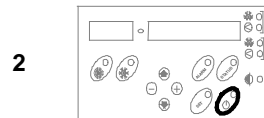

2 switching: long ON -
OFF
pressure

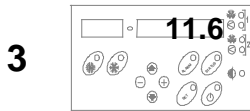

3 OUTLET temperature
visualization

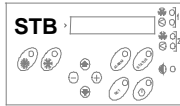

Units in :

- MANTEINTENANCE or
- In TRANSITION mode (for ex. from heating to cooling or to sanitary H2O)

ACCESSIBLE PARAMETERS FROM REMOTE OR SERVICE KEYBOARD

num. Par.	Description	Value	UM
29	Summer secondary Set Point	10	°C
30	Winter secondary Set Point	35	°C
32	Summer Set Point	5.7	°C
33	Winter Set Point	41.2	°C
42	Summer Set Point Maintenance	20	°C
43	Winter Set Point Maintenance	30	°C
44	Enables Summer Maintenance	0	num
45	Enables Winter Maintenance	0	num
77	Antifreeze heater set point	4	°C
80	Antifreeze alarm	4	°C
84	Limit of deactivation before reaching the antifreeze steps	4.5	°C
117	Sanitary water set point	35	°C
163	Configures remote inputs: 1 = H/C by keypad or supervisor		
216	Keypad address on Clivet Bus net: 7 =local; 1=remote	0	num

PARAMETER MODIFICATION

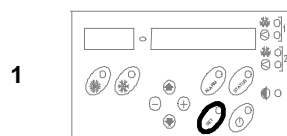

1 Push SET button

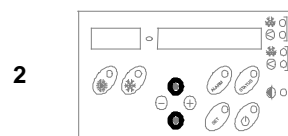

2 Select the
parameter

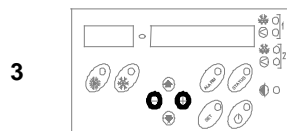

3 Modify the value

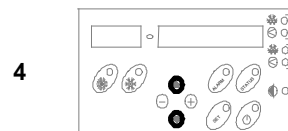

4 Select another
parameter





5 SET to esc

VISIBLE STATUS FROM REMOTE KEYBOARD OR SERVICE KEYBOARD

INDEX	DESCRIPTION	VALUE
1	Current Set Point	°C
2	Temperature drop in degrees centigrade given by the compressor including compensations, if any	°C
3	Resource activation timer When this value reaches the value fixed at the 4 status, the thermal regulator will compare the input temperature with the set point and will activate the resources, if necessary	Secondi
4	Dynamic TimeScan relating to source activation	Secondi
5	Value in degrees of the external air compensation	°C
6	Value in degrees of the water reset signal compensation	°C
7	Value in degrees of the charge compensation	°C
9	Inlet temperature	°C
10	Outlet temperature	°C
11	Outlet temperature of radiant panel water	°C
12	Coil temperature	°C
13	Condensing pressure	Bar
14	Fan/Valve 1 percentage	0-100%
15	Heater output temperature	
18	Water Reset signal value	4-20 mA
19	Outdoor temperature	°C
20	Outdoor Humidity	0-100%
21	Machine Clock - fed unit hours	Num
22	Working hours C1	Num
23	Pickups C1	Num
24	Radiant panel valve status (Out-2)	ON-OFF
25	Radiant panel valve status	%
26	Percentage pump	%
27	Integration heater status	ON-OFF
28	Radiant panel valve status (Out-1)	ON-OFF
29	Radiant Set Point	°C
30	Keypad software	EJ – t
31	Year of certification of the keyboard SW	2007
32	Month of certification of the keyboard SW	04
33	Day of certification of the keyboard SW	03
34	Base Software	EJ – b
35	Year of certification of the keyboard SW	2007
36	Month of certification of the keyboard SW	03
37	Day of certification of the keyboard SW	14

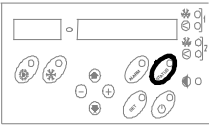
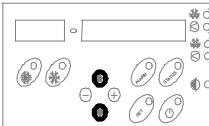
STATUS DISPLAY

- 1  push STATUS button
- 2  Select status
- 3  STATUS to esc

ALARMS

BEFORE RESETTING THE ALARM, IDENTIFY AND ELIMINATE THE CAUSE OF ITS ACTIVATION. REPEATED RESETS CAN CAUSE IRREVERSIBLE DAMAGES.

The **ALARMS** show a potentially dangerous situation for machine safety.

Before resetting the alarm, discover and remove the cause: repeated resetting could cause irreversible damage. To avoid this, the unit can only be reset **MANUALLY** from the keyboard (only when the cause for the alarm has been removed).

PRE-ALARMS and **SIGNALS** warn of a risky situation. These could be acceptable only if they happen occasionally or in transitory situations (for example when the plant is being started up).

They are reset **AUTOMATICALLY**, as soon as the cause has been removed, without any input from the keyboard.

The pre-alarms are signalled by the fixed C code (not flashing) and on the right the control temperature.

The **FAULTS** warn of problems with the probes and transducers, and are reset **AUTOMATICALLY** to allow the unit to continue running, perhaps with fewer functions.

In case of doubt, always contact an authorised service centre.

The presence of an alarm is signalled by the **ALARM CODE** flashing and the time at which the alarm/alarms occurred.

The cumulative block relay activates simultaneously to the alarm code visualization.

Certain alarms, in particular **PRE-ALARMS**, do not activate the relays.

The complete list of alarms is provided below; depending on the machine type and its configuration, some of the codes shown may not be used.

E	00	Serial faulty - comunicazione tastiera / scheda base	Auto.
E	1	Faulty or disconnected water inlet probe	Auto
E	2	Faulty or disconnected water outlet probe	Auto.
E	3	Faulty or disconnected radiating panel water probe (radiating panel option)	Auto.
E	4	Faulty or disconnected coil probe	Auto.
E	5	Electric heater output probe	Auto.
E	6	Faulty or disconnected external probe	Auto.
E	7	Faulty or disconnected pressure transducer	Auto.
E	8	Plug-in pressure probe	
C	9	Water Reset inlet in short circuit or out of range	Auto.
E	10	Faulty or disconnected external RH% probe	Auto.
E	11	High pressure	MANUAL
E	12	Low pressure	Auto.
E	13	Condensing fan and/or compressor thermal switch	MANUAL
E	14	Electric heater antifreeze alarm	MANUAL
E	17	Pump flow	Auto.
E	18	System charged with water	MANUAL
E	19	Phase monitor	Auto.
E	20	Antifreeze alarm	MANUAL
C	21	Antifreeze PREAlarm	Auto.
C	22	High pressure PreAlarm	Auto.
C	24	Pump change	Auto.
E	25	flow alarm C1	Auto.
E	30	Coil frost alarm	MANUAL
E	31	Cooling limit alarm (radiating panel option)	Auto.
E	32	Water frost alarm (radiating panel option)	Auto.
E	33	Incongruent DeltaT alarm	MANUAL
C	34	Low pressure pre-alarm	Auto.
C / E	35	Inlet water temperature over threshold after cooling / sanitary hot water switching and vice versa	Auto
C	36	Incongruent sanitary H2O thermostat	Auto



1

flashing
Alarm code
Alarm unit hours



2

opened alarm log
short pressure
ALARM

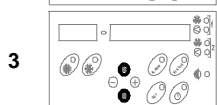

3

The most recent alarm is
visualized
Use the arrow keys to visualize
other alarms



4

To esc
Short pressure
ALARM



5

To RESET
LONG pressure
ALARM

ROUTINE MAINTENANCE

BEFORE UNDERTAKING ANY SORT OF MAINTENANCE OR CLEANING, DISCONNECT THE ELECTRICAL POWER SUPPLY TO THE UNIT, AND ENSURE THAT OTHER PEOPLE CANNOT RE-CONNECT IT .

All equipment is subjected to wear out.

The maintenance makes :

1. keeps the unit efficiency
2. the components last longer
3. keeps their efficiency and limits breakdowns

Therefore, it is fundamental to perform periodical checks: a few controls can be performed by the user (AUTONOMOUS MAINTENANCE) and they are mainly

cleaning activities; otherwise, controls have to be performed by specialized technicians (INSPECTIONS).

The machine should have a log book used to keep track of the performed controls. This will make fixing up breakdowns easier.

Take note of the date, type of control (autonomous maintenance, inspection or fixing up), description of the control, actions taken and so on.

SERVICES

Parts subject to intervention:

- FRESH AIR COIL
- WATER CONDENSER
- STRUCTURE
- ELECTRIC FANS

FRESH AIR COIL

ATTENTION: contact with the exchanger fins can cause cuts. Wear protective gloves to perform the above described operations.

It is extremely important that the battery gives the maximum thermal exchange; therefore, its surface must be cleaned from dust and deposits. Remove all impurities from the surface.

Using an air pressure gun, clean the aluminum surface of the battery. Be careful to direct the air in the opposite

direction of the fan air movement. Hold the gun parallel to the fins to avoid damages. As an alternative, an aspirator can be used to suck impurities from the air input side.

Verify that the aluminum fins are not bent or damaged. In the event of damages, contact the authorized assistance center and get the battery "ironed out" in order to restore the initial condition for an optimal air flow.

WATER EXCHANGER

It is very important for the exchanger to be able to provide the maximum thermal exchange. Therefore, it is essential for the inner surfaces to be clean of dirt and incrustations.

Periodically check the difference between the temperature of the supply water and the condensation temperature. If the difference is greater than 8 °C – 10 ° C it is advisable to clean the exchanger.

STRUCTURE

Check the condition of the parts making up the structure. Paint so as to eliminate or reduce oxidation at the points in the unit where this problem may occur. Check that the

panelling is fastened correctly. Poor fastening may give rise to malfunctions and abnormal noise and vibration.

ELECTRIC FANS

Make sure that the fans and the relative protection grids are well fixed.

Check, if possible, the unbalances of the electro-fan evident by noise and anomalous vibrations. Verify that the terminal protection covers are closed and the cable holders are properly positioned.

MAINTENANCE INSPECTIONS

Foresee inspection assistance carried out by authorized centers or by qualified personnel.

The inspections should be carried out at least:

- - Every year for only the cooling units
- - Every six months for the cooling and warming units

The frequency, however, depends on the use: in the event of frequent use (continuous or very intermittent use, near the operating limits, etc) or critical use (service necessary) it is recommended to plan inspections at close intervals.

The inspections to be performed are as follows:

- verify the power supply tension (when emptied or filled)
- inspect the electrical board (status of solenoid starter contacts, terminal closings, the status of wiring and relevant insulations)
- inspect the absorption of the single electrical loads
- verify the cleaning and the efficiency of the exchangers
- inspect the cleaning of the filters (air/water)

- verify the leakage from the refrigerating circuit
- Verify the protection devices (safety valves, pressure switches, thermostats, etc.), the adjustment systems, the control devices (alarm signalizations, probes, manometers, etc)
- check the operating parameters of the refrigerating circuit (see the following REFRIGERANT TABLES and the START-UP section)

For units equipped with safety valves, follow the Manufacturer's instructions.

Verify periodically the cleaning of the safety valves and that oxidative / corrosive phenomena are not present, in particular for installations near the sea, in industrial areas or in rooms with a corrosive atmosphere.

97/23 CE PED DIRECTIVE

97/23 CE PED DIRECTIVE gives instructions for installers, users and maintenance technicians as well. Refer to local actuation norms.

In Italy, refer to the Ministerial Decree of 1st December 2004 no. 329 (and following modifications) which defines the performances to be executed; the units of 1st category and those defined by the art. 3.3 97/23/EC are not included in this regulation (see the serial number plate on the unit) .

Briefly and as an example, see the following :

1. COMPULSORY VERIFICATION OF THE FIRST INSTALLATION only for units assembled on the installer's building site (for ex. Condensing circuit + direct expansion unit)
2. CERTIFICATION OF SETTING IN SERVICE for all the units
3. PERIODICAL VERIFICATIONS to be executed with the frequency indicated by the Manufacturer (see the MAINTENANCE INSPECTIONS paragraph)

PUT AT REST

If a long period of inactivity is foreseen, for example the winter for the cooling unit, the following is recommended:

- to turn the power off in order to avoid electrical risks or damages by lightning strike
- to avoid the risk of frosts as shown in the HYDRAULIC CONNECTIONS section, and, in particular
 - to empty or add glycole in the plant sections subjected to temperatures below zero
 - to empty or add glycole in the water heating coils, also in summer
 - to power antifreeze resistances if present

If the period of inactivity is particularly long or in the event of extremely low temperatures, the external fans can be blocked temporarily; therefore, it is recommended to switch them on every month in order to avoid seizures or electrical overloads when the unit will be switched on.

The restarting of the unit has to be carried out by qualified personnel, in particular, after the winter break for cooling units or when seasonal switching should be performed.

When restarting, refer to the SWITCHING ON section.

Schedule technical assistance in advance to avoid hitches and be able to use the installation when necessary.

REFRIGERANT TABLES

THIS SECTION IS DEVOTED ONLY TO QUALIFIED TECHNICIANS THAT KNOW THE FOLLOWING:

- THE OPERATIONAL PRINCIPLES OF THE REFRIGERATING CIRCUIT OPERATION
- THE MODES OF DETECTING TEMPERATURE AND PRESSURE
- THE RISKS RELEVANT TO THESE OPERATIONS

The data of the tables allow the testing of the refrigerating circuit operation by the detection of a few objective parameters.

The data are significant if they are detected simultaneously and while the refrigerating circuit is running.

- Liquid temperature
- Return pressure
- Return temperature
- Condensing pressure

OVERHEATING = return temperature – Saturation temperature			
	R22	R407C	R410A
Return pressure	3.8 bar	3.8 bar	7.2 bar
Return temperature	7.3 °C	7.3 °C	7.3 °C
overheating	$7.3 - (-1.13) = 8.43$ °C	$1.3 - 1.18 = 6.12$ °C for calculation consider the Td (dew point)	$7.3 - 0.8 = 6.5$ °C
SUBCOOLING = condensing temperature (pressure *) – liquid temperature			
	R22	R407C	R410A
Condensing pressure	18.6 bar	18.6 bar	29.6 bar
Liquid temp.	42.9 °C	42.9 °C	45 °C
subcooling	$50.39 - 42.9 = 7.49$ °C	$44.74 - 42.9 = 1.84$ °C for calculation consider the Tb (bubble point)	$49.91 - 45 = 4.91$ °C

* It is important that the condensation pressure is detected as close as possible to the point where the liquid temperature is detected, in the event that the calculation will be effected by the losses of charge (and, therefore, of temperature) caused by the refrigerating circuit components placed between the two measurement points.

For R410A the glide was not considered, since it is close to 0.

The values in the tables refer to a specific refrigerant supplier; slight differences are possible with other suppliers.

Pg = P gauge = relevant pressure (read on the pressure gauge)

Ts = saturation pressure

Td = dew point temperature

Tb = bubble point temperature

Pg	R407C	Td [°C]	Tb [°C]	Pg	R407C	Td [°C]	Tb [°C]	Pg	R407C	Td [°C]	Tb [°C]	Pg	R407C	Td [°C]	Tb [°C]
0.0	-36.90	-43.90		11.0	30.73	25.30		22.0	56.00	51.63		33.0	72.94	69.73	
0.2	-33.11	-40.05		11.2	31.32	25.92		22.2	56.36	52.01		33.2	73.21	70.02	
0.4	-29.80	-36.67		11.4	31.91	26.52		22.4	56.72	52.39		33.4	73.47	70.30	
0.6	-26.83	-33.65		11.6	32.49	27.12		22.6	57.08	52.77		33.6	73.72	70.58	
0.8	-24.15	-30.92		11.8	33.07	27.72		22.8	57.43	53.14		33.8	73.98	70.87	
1.0	-21.69	-28.41		12.0	33.63	28.30		23.0	57.79	53.51		34.0	74.24	71.15	
1.2	-19.41	-26.09		12.2	34.19	28.88		23.2	58.14	53.88		34.2	74.49	71.43	
1.4	-17.29	-23.93		12.4	34.75	29.46		23.4	58.48	54.25		34.4	74.75	71.70	
1.6	-15.31	-21.90		12.6	35.30	30.03		23.6	58.83	54.62		34.6	75.00	71.98	
1.8	-13.44	-19.99		12.8	35.84	30.59		23.8	59.17	54.98		34.8	75.25	72.26	
2.0	-11.66	-18.19		13.0	36.37	31.14		24.0	59.51	55.34		35.0	75.50	72.53	
2.2	-9.98	-16.47		13.2	36.90	31.69		24.2	59.85	55.70		35.2	75.75	72.81	
2.4	-8.38	-14.83		13.4	37.43	32.23		24.4	60.19	56.05		35.4	75.99	73.08	
2.6	-6.85	-13.27		13.6	37.95	32.77		24.6	60.53	56.41		35.6	76.24	73.35	
2.8	-5.38	-11.77		13.8	38.46	33.31		24.8	60.86	56.76		35.8	76.48	73.62	
3.0	-3.97	-10.33		14.0	38.97	33.83		25.0	61.19	57.11		36.0	76.73	73.89	
3.2	-2.61	-8.94		14.2	39.47	34.35		25.2	61.52	57.46		36.2	76.97	74.16	
3.4	-1.31	-7.61		14.4	39.97	34.87		25.4	61.84	57.81		36.4	77.21	74.43	
3.6	-0.04	-6.31		14.6	40.46	35.38		25.6	62.17	58.15		36.6	77.45	74.69	
3.8	1.18	-5.06		14.8	40.95	35.89		25.8	62.49	58.49		36.8	77.69	74.96	
4.0	2.36	-3.85		15.0	41.43	36.39		26.0	62.81	58.83		37.0	77.92	75.22	
4.2	3.51	-2.68		15.2	41.91	36.89		26.2	63.13	59.17		37.2	78.16	75.49	
4.4	4.62	-1.54		15.4	42.39	37.39		26.4	63.45	59.51		37.4	78.39	75.75	
4.6	5.71	-0.43		15.6	42.86	37.87		26.6	63.76	59.85		37.6	78.62	76.01	
4.8	6.76	0.65		15.8	43.32	38.36		26.8	64.07	60.18		37.8	78.86	76.27	
5.0	7.79	1.70		16.0	43.78	38.84		27.0	64.38	60.51		38.0	79.09	76.53	
5.2	8.79	2.73		16.2	44.24	39.32		27.2	64.69	60.84		38.2	79.31	76.79	
5.4	9.77	3.73		16.4	44.69	39.79		27.4	65.00	61.17		38.4	79.54	77.05	
5.6	10.72	4.71		16.6	45.14	40.26		27.6	65.31	61.50		38.6	79.77	77.31	
5.8	11.65	5.67		16.8	45.59	40.72		27.8	65.61	61.82		38.8	79.99	77.56	
6.0	12.56	6.60		17.0	46.03	41.18		28.0	65.91	62.14		39.0	80.22	77.82	
6.2	13.46	7.52		17.2	46.47	41.64		28.2	66.21	62.46		39.2	80.44	78.07	
6.4	14.33	8.41		17.4	46.90	42.09		28.4	66.51	62.78		39.4	80.66	78.33	
6.6	15.18	9.29		17.6	47.33	42.54		28.6	66.81	63.10		39.6	80.88	78.58	
6.8	16.02	10.15		17.8	47.76	42.99		28.8	67.10	63.42		39.8	81.10	78.83	
7.0	16.85	11.00		18.0	48.18	43.43		29.0	67.40	63.73		40.0	81.31	79.08	
7.2	17.65	11.83		18.2	48.60	43.87		29.2	67.69	64.05		40.2	81.53	79.33	
7.4	18.45	12.64		18.4	49.02	44.30		29.4	67.98	64.36		40.4	81.74	79.58	
7.6	19.22	13.44		18.6	49.43	44.74		29.6	68.27	64.67		40.6	81.95	79.83	
7.8	19.99	14.23		18.8	49.84	45.16		29.8	68.56	64.98		40.8	82.16	80.08	
8.0	20.74	15.00		19.0	50.25	45.59		30.0	68.84	65.29		41.0	82.37	80.33	
8.2	21.48	15.76		19.2	50.65	46.01		30.2	69.13	65.59		41.2	82.58	80.57	
8.4	22.20	16.51		19.4	51.05	46.43		30.4	69.41	65.90		41.4	82.79	80.82	
8.6	22.92	17.25		19.6	51.45	46.85		30.6	69.69	66.20		41.6	82.99	81.06	
8.8	23.62	17.97		19.8	51.85	47.26		30.8	69.97	66.50		41.8	83.19	81.31	
9.0	24.32	18.69		20.0	52.24	47.67		31.0	70.25	66.80		42.0	83.40	81.55	
9.2	25.00	19.39		20.2	52.63	48.08		31.2	70.52	67.10		42.2	83.60	81.80	
9.4	25.67	20.08		20.4	53.01	48.49		31.4	70.80	67.40		42.4	-	-	
9.6	26.34	20.77		20.6	53.39	48.89		31.6	71.07	67.69		42.6	-	-	
9.8	26.99	21.44		20.8	53.77	49.29		31.8	71.34	67.99		42.8	-	-	
10.0	27.63	22.11		21.0	54.15	49.69		32.0	71.61	68.28		43.0	-	-	
10.2	28.27	22.76		21.2	54.53	50.08		32.2	71.88	68.57		43.2	-	-	
10.4	28.90	23.41		21.4	54.90	50.47		32.4	72.15	68.87		43.4	-	-	
10.6	29.51	24.05		21.6	55.27	50.86		32.6	72.42	69.15		43.6	-	-	
10.8	30.13	24.68		21.8	55.64	51.25		32.8	72.68	69.44		43.8	-	-	

TROUBLESHOOTING

THE OPERATIONS MUST BE CARRIED OUT BY TECHNICAL QUALIFIED PERSONNEL HAVING THE REQUISITES UNDER LAW REQUISITES AND IN CONFORMITY WITH THE SAFETY REGULATIONS IN FORCE.

THE INTERVENTIONS WITHIN THE WARRANTY PERIOD WILL BE CARRIED OUT BY AUTHORIZED SERVICE CENTERS.

BEFORE RESETTING AN ALARM, IDENTIFY AND ELIMINATE ITS CAUSE. REPEATED RESETS MAY CAUSE SERIOUS DAMAGES.

In certain machine configurations, some safeties may be placed in series and lead back to a single input on the electronic module.

Therefore, check on the electrical diagram whether the device to which the alarm corresponds has other devices or safeties connected in series.

Below is a list of the possible causes of alarms.

HIGH PRESSURE (in cooling)

1. high water temperature (see operating limits)
2. high air temperature (see operating limits)
3. coil dirty / clogged
4. fans don't work / low speed
5. Manostat/transducer: loose electric contacts/terminals, wiring cables interrupted
6. Anti-condensation gas in the cooling circuit
7. Too much refrigerant
8. Check the trigger point for the manostat and transducer
9. Check the manostat or transducer pressure control point (deposits of oil, dirt, pin blocked mechanically)

LOW PRESSURE (in cooling)

1. low air temperature (see operating limits)
2. low water temperature (see operating limits)
3. insufficient water flow to the exchanger (high thermal difference between input and output)
4. not CONSTANT flow (for example, if the pumps are turned off, certain areas of the plant are excluded or included, other uses are isolated, etc)
5. Water filter clean / valves open /air bubbles in the plant
6. dirty exchanger
7. Manostat/transducer: loose electric contacts/terminals, wiring cables interrupted
8. refrigerant circuit empty, visible leaks of refrigerant/oil, insufficient charge
9. Blocked dehydrator filter
10. thermostatic device not operating correctly
11. Check the trigger point for the manostat and transducer
12. Check the manostat or transducer pressure control point (deposits of oil, dirt, pin blocked mechanically)

FAULTY PROBE

1. Identify the part on the wiring diagram.
2. Loose electric contacts/terminals, leads broken
3. Check the correct probe ohmic level (using a tester)
4. Change the probe.
5. Check the electronic module configuration (only an authorised service centre can do this)
6. Change the electronic module

FAULTY PRESSURE TRANSDUCER

1. Identify the part on the wiring diagram
2. Loose electric contacts/terminals, leads broken
3. Check the pressure test points are in working order
4. Change the part
5. Check the electronic module configuration (only an authorised service centre can do this)
6. Change the electronic module

COMPRESSOR PROTECTION

1. Identify the part on the wiring diagram
2. Loose electric contacts/terminals, leads broken
3. electrical windings interrupted
4. Vacuum power voltage below the limits
5. power contactors / contacts defective
6. start-up power voltage lower than the limits
7. electrical absorption high / unbalanced
8. High compressor discharge temperature > thermostatic device needs calibrating, insufficient refrigerant charge

HIGH PRESSURE (in heating)

1. high air temperature (see operating limits)
2. high water temperature (see operating limits)
3. insufficient water flow to the exchanger (high thermal difference between input and output)
4. not CONSTANT flow (for example, if the pumps are turned off, certain areas of the plant are excluded or included, other uses are isolated, etc)
5. Water filter clean / valves open /air bubbles in the plant
6. dirty exchanger
7. Manostat/transducer: loose electric contacts/terminals, wiring cables interrupted
8. condensation gas in the cooling circuit
9. Too much refrigerant
10. Check the trigger point for the manostat and transducer
11. Check the manostat or transducer pressure control point (deposits of oil, dirt, pin blocked mechanically)

FAN PROTECTION

1. Identify the part on the wiring diagram
2. fan mechanically jammed, bearings / drive belt (if present)
3. Loose electric contacts/terminals, leads broken
4. electrical windings of fan interrupted
5. power supply voltage below limits
6. electrical absorption high / unbalanced

PUMP PROTECTION

1. Identify the part on the wiring diagram
2. pump jammed (probable for circulator pump after lengthy seasonal shutdowns)
3. Loose electric contacts/terminals, leads broken
4. electrical windings of fan interrupted
5. power supply voltage below limits
6. electrical absorption high / unbalanced

LOW PRESSURE (in heating)

1. low water temperature (see operating limits)
2. low air temperature (see operating limits)
3. coil dirty / clogged
4. fans don't work / low speed
5. Manostat/transducer: loose electric contacts/terminals, wiring cables interrupted
6. Check the trigger point for the manostat and transducer
7. refrigerant circuit pressurized? visible refrigerant leakage? correct charge?
8. Blocked dehydrator filter ?
9. thermostatic device not operating correctly?
10. Check the manostat or transducer pressure control point (deposits of oil, dirt, pin blocked mechanically)

DECOMMISSIONING OF THE UNIT

DISCONNECTING THE UNIT

The units must be disconnected by authorised personnel, who before proceeding must first read the Residual Risks section in this manual.

Before disconnecting the unit, the following must be recovered, if present:

- the refrigerant (if the circuits cannot be isolated): the refrigerant must be removed using suction devices operating in a closed circuit, so as to ensure that none of the compound is released into the atmosphere.
- the antifreeze in the circuits: when removing this fluid, make sure that it does not leak and that it is not released into the environment. The antifreeze fluid must be stored in special containers.

When recovering the substances present in the unit, all measures must be taken to avoid damaging persons and things and polluting the surrounding area.

Awaiting dismantling and disposal, the unit can also be stored outdoors, as bad weather and rapid changes in temperature will not cause damage to the environment, if electric, cooling and hydraulic circuits of the unit are integral and closed.

DISMANTLING AND DISPOSAL

THE UNIT MUST ALWAYS BE SENT TO AUTHORISED CENTRES FOR DISMANTLING AND DISPOSAL.

When dismantling the unit, the fan, the motor and the coil, if operating, may be recovered by the specialist centres for reuse.

All the materials must be recovered or disposed of in compliance with the corresponding national standards in force.

For further information on the decommissioning of the unit, contact the manufacturer.

TECHNICAL DATA

SIZE			17	21	25	31	41	51	61	71	81	91
COOLING												
Cooling capacity	1	kW	4.12	5.13	6.89	8.02	9.86	12.2	14.5	15.9	17.9	20.9
Compressor power input		kW	1.57	1.94	2.3	2.79	3.42	4.1	4.69	5.46	6.17	7.95
Total power input	2	kW	1.76	2.19	2.56	3.16	3.97	4.74	5.31	6.1	6.77	8.59
EER			2.34	2.35	2.69	2.54	2.48	2.58	2.74	2.62	2.65	2.43
HEATING												
Heat output	3	kW	4.78	5.98	7.74	9.31	11.2	13.6	16.3	17.8	20.6	24.3
Compressor power input		kW	1.53	1.92	2.3	2.98	3.55	4.4	5.11	5.86	6.57	8.24
Total power input		kW	1.72	2.17	2.56	3.35	4.1	5.03	5.73	6.5	7.18	8.88
COP			2.77	2.76	3.02	2.78	2.72	2.7	2.84	2.77	2.86	2.74
COMPRESSOR												
Type of compressors			Rotativo					Scroll				
No. of Compressors		Nr						1				
Std Capacity control steps		Nr						1				
Refrigerant charge (C1)		kg	2	2	3	3	3.8	4.2	5.2	5.2	6	6
Refrigerant circuits		Nr						1				
INTERNAL EXCHANGER												
Type of internal exchanger								PHE				
No. of internal exchangers	4	Nr						1				
Water flow rate		l/s	0.2	0.2	0.3	0.4	0.5	0.6	0.7	0.8	0.9	1
Useful pump discharge head		kPa	60	50	48	37	155	135	129	116	118	97
Water content		l	1.5	1.5	1.5	1.6	1.6	1.8	1.8	1.8	2	2
EXTERNAL SECTION FANS												
Type of fans	5							AX				
Number of fans		Nr	1		2							
Standard air flow		l/s	505	686	974	1320	1364	2195	2432	2432	2286	2286
Installed unit power		kW	0.07	0.12	0.07	0.12	0.12	0.15	0.15	0.15	0.15	0.15
HYDRAULIC CIRCUIT												
Max water side pressure		kPa						550				
Safety valve calibration		kPa						600				
EXPANSION VESSEL												
Expansion vessel capacity		l	2					5				
No. of expansion vessels		Nr						1				
POWER SUPPLY												
Standard power supply			230/1/50					400/3/50				
NOISE LEVELS												
Sound pressure level (1 m)		dB(A)	53	54	54	56	58	60	60	60	62	63
DIMENSIONS												
Length		mm	895	895	895	895	1040	1040	1325	1325	1325	1325
Depth		mm	359	359	359	359	411	411	555	555	555	555
Height		mm	895	895	1095	1095	1175	1175	1225	1225	1225	1225
STANDARD UNIT WEIGHTS												
Shipping weight		kg	98	100	110	113	125	128	168	170	173	176
Operating weight		kg	100	102	112	115	127	130	170	172	175	178

(1) data referred to the following conditions :

internal exchanger water = 12/7°C
outside air temperature 35°C

(2) The total input is given by the compressor input + fans power input + pump power input - proportional part of the water pump to supply the available head to installation input

(3) data referred to the following conditions :

room temperature = 7°C (RH = 85%)
external exchanger water outlet temperature 45°C

(4) PHE = plates

(5) AX = axial-flow fan

SETTING THE CUT-OUT DEVICES AND CONTROLS

		Opens	Closes	Value
High pressure switch	kPa	2800	2000	--
Low pressure switch	kPa	230	360	--
Antifreeze protection	°C	4	6,5	--
High pressure safety valve	kPa	--	--	3000
Low pressure safety valve	kPa	--	--	1900
Max compressor start per hour	Nr	--	--	10
Safety discharge thermostat	°C	--	--	120

OPERATING LIMITS (COOLING)

SIZE			17	21	25	31	41	51	61	71	81	91
EXTERNAL EXCHANGER												
Max air intake temperature	1	°C	46.5	47	47.5	47.5	46	47.5	48	47	47.5	45
Min. air intake temperature	2	°C	-10									
INTERNAL EXCHANGER												
Max water inlet temperature	3	°C	20	20.7	20.4	23	21.5	21	22	22.5	22.5	23
Max water inlet temperature	4	°C	19.8	20.3	20	22	21	20.4	21.5	22	22	22.5
Min. water outlet temperature	5	°C	4									
Water thermal head (min / max)		°C	3 / 8									

OPERATING LIMITS (HEATING)

SIZE			17	21	25	31	41	51	61	71	81	91
EXTERNAL EXCHANGER												
Max air temperature inlet (WB)	6	°C	21	21.5	21.5	22	22	22	21.5	23	22	24
Min air inlet temperature (W.B.)		°C	-7									
INTERNAL EXCHANGER												
Min. water outlet temperature	7	°C	28	28	28	28	28	28	28	28	28	28
Max water outlet temperature	7	°C	55	54.5	54.5	53.5	54	53.5	55.5	55	54.5	54.5
Water thermal head (min / max)		°C	3 / 8									

- (1) internal exchanger water = 12/7°C
- (2) water to internal exchanger 12/7°C, still air
- (3) external exchanger air intake 30°C
- (4) external exchanger air inlet temperature 40°C

- (5) antifreeze intervention
- (6) WATER TO INTERNAL EXCHANGER 40/45°C
- (7) outdoor air temperature 7°C DB - 6°C WB

ATTENTION: IN CASE OF PREDOMINANT WINDS, WINDBREAK BARRIERS ARE NECESSARY.

FOULING CORRECTION FACTOR

m ² °C/W	INTERNAL EXCHANGER		EXTERNAL EXCHANGER	
	F1	FK1	F2	FK2
0.44 x 10 ⁽⁻⁴⁾	1.00	1.00	1.00	1.00
0.88 x 10 ⁽⁻⁴⁾	0.97	0.99	0.97	1.08
1.76 x 10 ⁽⁻⁴⁾	0.94	0.98	0.92	1.05

The cooling performance values provided in the tables are based on the external exchanger having clean plates (fouling factor 1). For different fouling factor values, multiply the performance by the coefficients shown in the table.

F1 = Cooling capacity correction factors

FK1 = Compressor power input correction factor

CORRECTION FACTOR FOR ANTIFREEZE SOLUTIONS

% ethylene glycol by weight		5%	10%	15%	20%	25%	30%	35%	40%
Freezing temperature	°C	-2.0	-3.9	-6.5	-8.9	-11.8	-15.6	-19.0	-23.4
Safety temperature	°C	3.0	1.0	-1.0	-4.0	-6.0	-10.0	-14.0	-19.0
Cooling Capacity Factor	Nr	0.995	0.990	0.985	0.981	0.977	0.974	0.971	0.968
Compressor input Factor	Nr	0.997	0.993	0.990	0.988	0.986	0.984	0.982	0.981
Internal exchanger Glycol solution flow Factor	Nr	1.003	1.010	1.020	1.033	1.050	1.072	1.095	1.124
Pressure drop Factor	Nr	1.029	1.060	1.090	1.118	1.149	1.182	1.211	1.243

The correction factors shown refer to water and glycol ethylene mixes used to prevent the formation of frost on the exchangers in the water circuit during inactivity in winter.

INTERNAL EXCHANGER PRESSURE DROP

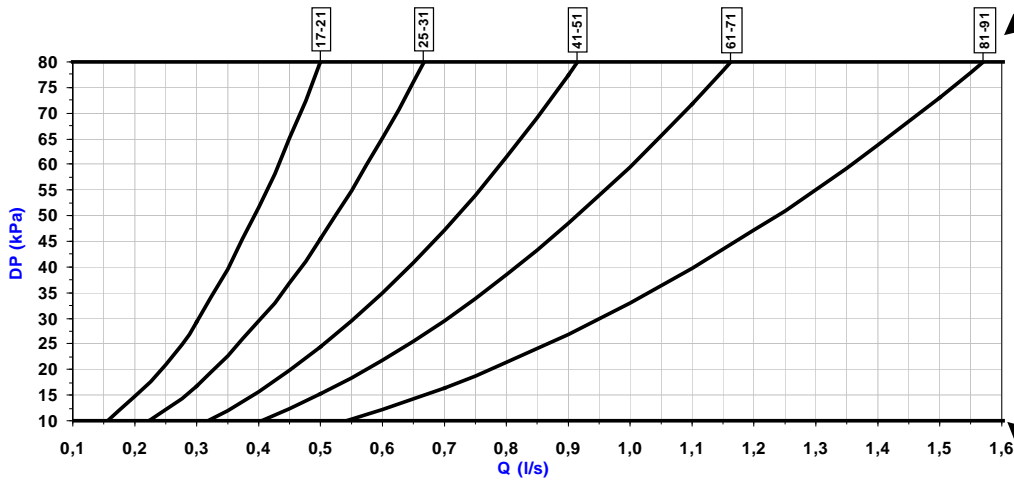

EVAPORATOR PRESSURE DROP LIMIT. CAUTION: DO NOT USE OVER THIS LIMIT

UNIT WITHOUT HYDRAULIC CIRCUIT COMPONENTS
 DP = PRESSURE DROP
 Q = WATER FLOW

EVAPORATOR PRESSURE DROP LIMIT. CAUTION: DO NOT USE UNDER THIS LIMIT

PUMP PERFORMANCE

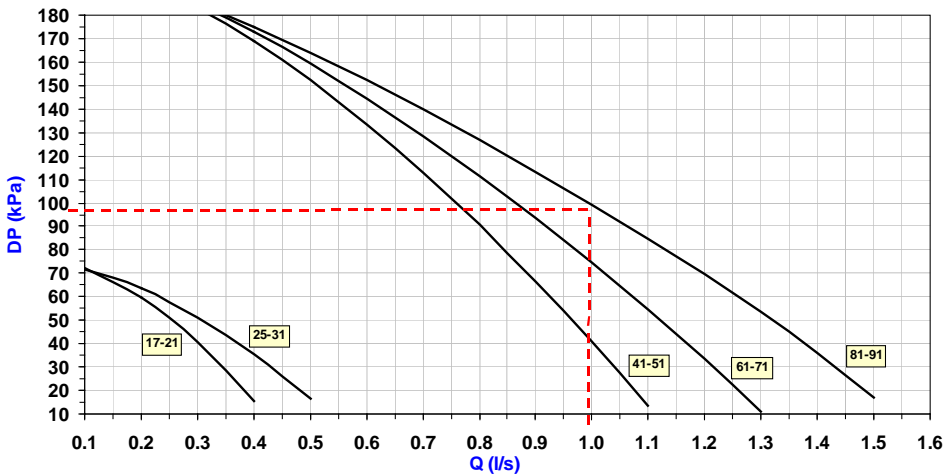

CURVE OF DISCHARGE HEAD WITH HYDRONIC ASSEMBLY THE HEADS ARE INTENDED AS AVAILABLE AT THE UNIT CONNECTIONS
 DP = AVAILABLE HEAD
 Q = WATER FLOW

SOUND LEVELS

Size	Sound Power Level (dB)								Sound pressure level dB(A)	Sound power level dB(A)
	Octave band (Hz)									
	63	125	250	500	1000	2000	4000	8000		
17	73	72	66	67	62	53	46	44	53	67
21	94	64	57	59	54	49	40	38	54	68
25	93	60	60	59	55	51	46	46	54	68
31	96	71	59	57	55	51	49	37	56	70
41	98	72	63	64	61	56	54	39	58	72
51	78	75	79	72	68	61	51	43	60	74
61	78	72	78	72	69	62	52	37	60	74
71	79	73	79	72	69	62	52	38	60	74
81	82	76	82	75	72	65	54	41	62	77
91	84	78	84	75	70	66	55	48	63	78

Measures according to ISO 3744 regulations, with respect to the EUROVENT 8/1 certification.
 The sound pressure level is measured 1 metre from the external surface of the unit operating in an open field. Data refer to the following conditions: internal exchanger water = 12/7°C

DIMENSIONS

Size 17-21

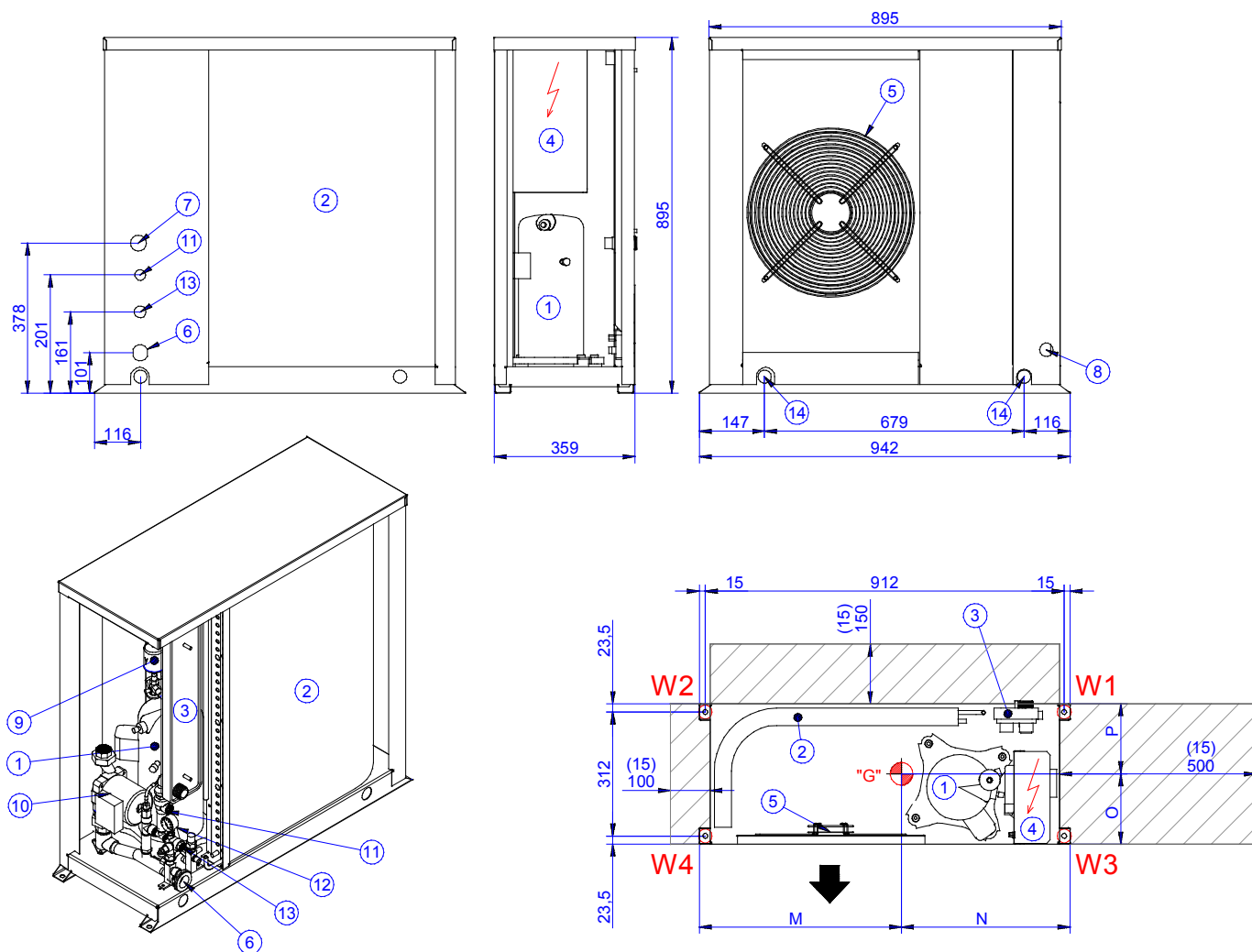

The units require minimum clearances for operation and maintenance. The following sketch describes the minimum clearances to be considered. In the event of multiple units, the functional clearances must be doubled.

Size		17	21
M	mm	455	453
N	mm	440	442
O	mm	180	178
P	mm	179	181
Length	mm	895	895
Depth	mm	359	359
Height	mm	895	895
W1	kg	33	34
W2	kg	15	15
W3	kg	35	36
W4	kg	17	17
Operating weight	kg	100	102
Shipping weight	kg	98	100

- (1) COMPRESSOR
- (2) EXTERNAL EXCHANGER
- (3) INTERNAL EXCHANGER
- (4) ELECTRICAL PANEL
- (5) HELICAL FANS
- (6) WATER INLET 1" GAS
- (7) WATER OUTLET 1" GAS
- (8) POWER INPUT
- (9) EXPANSION VESSEL
- (10) PUMP
- (11) WATER SIDE SAFETY VALVE
- (12) WATER FILL ASSEMBLY WITH PRESSURE GAUGE
- (13) 1/2" GAS CHARGE FITTING
- (14) LIFTING HOLES
- (15) CLEARANCE ACCESS RECOMMENDED
- ("G") BARYCENTRE

Size 25-31

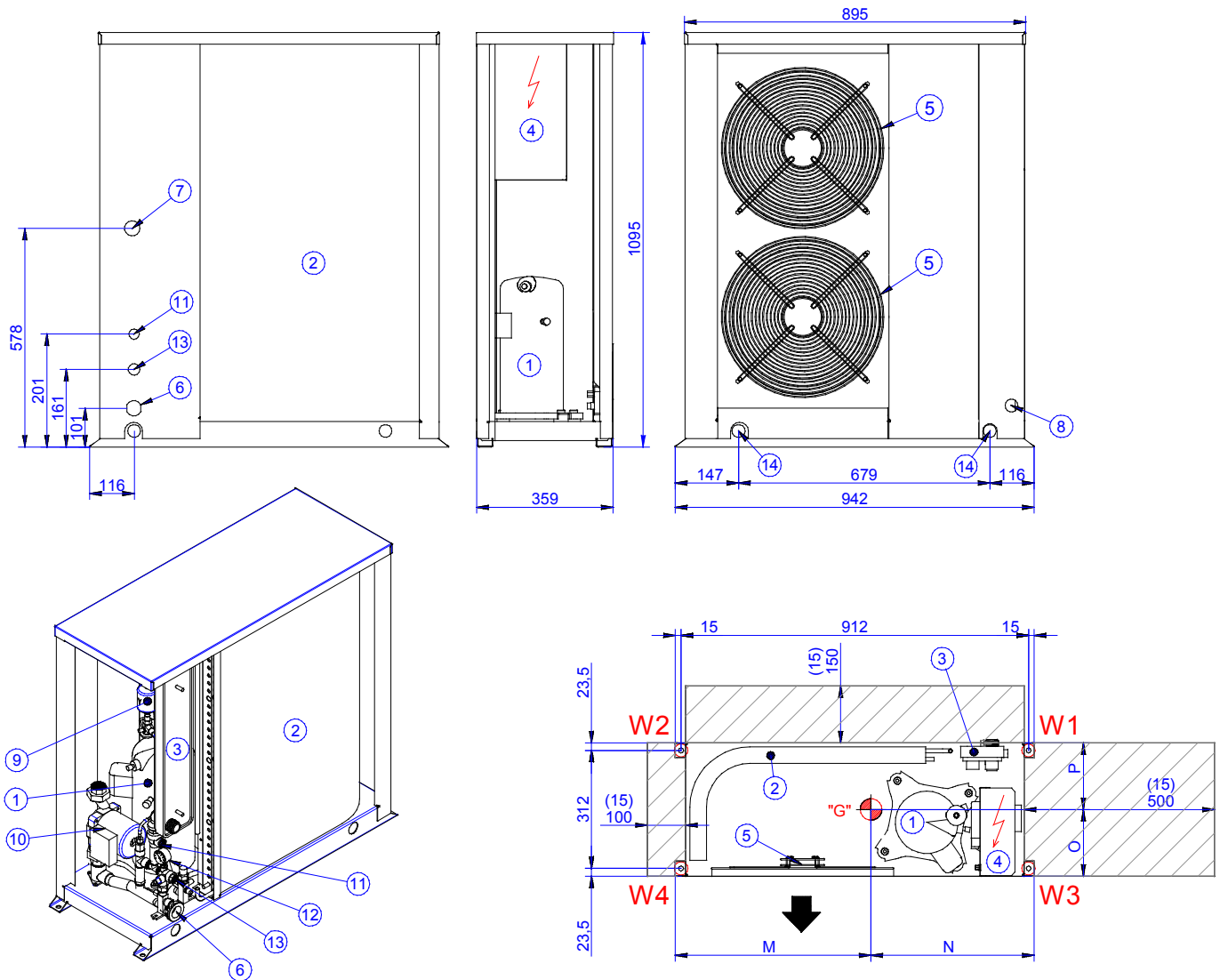

The units require minimum clearances for operation and maintenance. The following sketch describes the minimum clearances to be considered. In the event of multiple units, the functional clearances must be doubled.

Size		25	31
M	mm	450	450
N	mm	445	445
O	mm	175	175
P	mm	184	184
Length	mm	895	895
Depth	mm	359	359
Height	mm	1095	1095
W1	kg	39	40
W2	kg	15	16
W3	kg	41	42
W4	kg	17	17
Operating weight	kg	112	115
Shipping weight	kg	110	113

- (1) COMPRESSOR
- (2) EXTERNAL EXCHANGER
- (3) INTERNAL EXCHANGER
- (4) ELECTRICAL PANEL
- (5) HELICAL FANS
- (6) WATER INLET 1" GAS
- (7) WATER OUTLET 1" GAS
- (8) POWER INPUT
- (9) EXPANSION VESSEL
- (10) PUMP
- (11) WATER SIDE SAFETY VALVE
- (12) WATER FILL ASSEMBLY WITH PRESSURE GAUGE
- (13) 1/2" GAS CHARGE FITTING
- (14) LIFTING HOLES
- (15) CLEARANCE ACCESS RECOMMENDED
- ("G") BARYCENTRE

Size 41-51

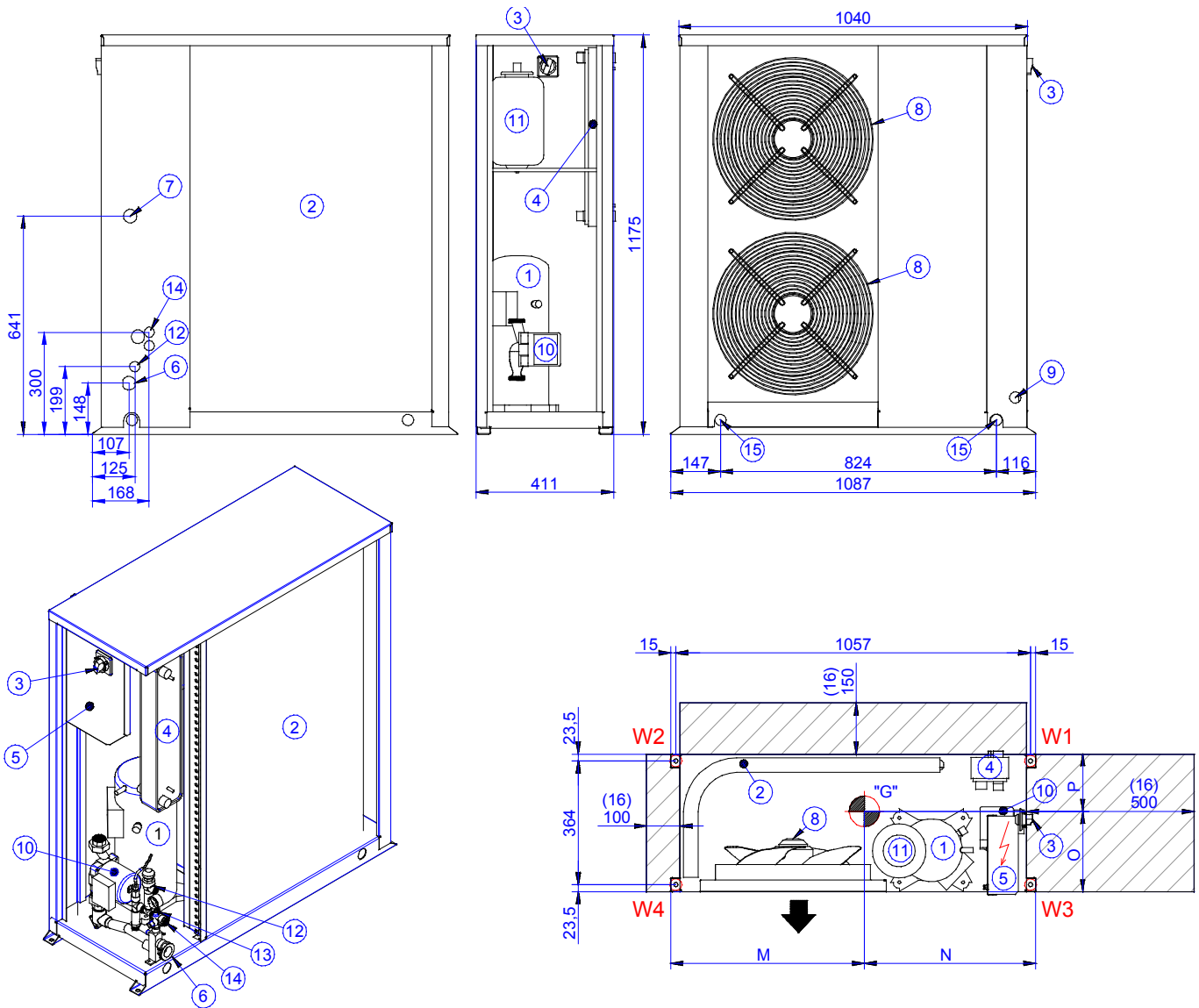

The units require minimum clearances for operation and maintenance. The following sketch describes the minimum clearances to be considered. In the event of multiple units, the functional clearances must be doubled.

Size		41	51
M	mm	545	545
N	mm	495	495
O	mm	205	205
P	mm	206	206
Length	mm	1040	1040
Depth	mm	411	411
Height	mm	1175	1175
W1	kg	44	44
W2	kg	18	19
W3	kg	45	46
W4	kg	20	21
Operating weight	kg	127	130
Shipping weight	kg	125	128

- (1) COMPRESSOR
- (2) EXTERNAL EXCHANGER
- (3) MAIN ISOLATOR SWITCH
- (4) INTERNAL EXCHANGER
- (5) ELECTRICAL PANEL
- (6) WATER INLET 1" GAS
- (7) WATER OUTLET 1" GAS
- (8) HELICAL FANS
- (9) POWER INPUT
- (10) PUMP
- (11) EXPANSION VESSEL
- (12) WATER SIDE SAFETY VALVE
- (13) WATER FILL ASSEMBLY WITH PRESSURE GAUGE
- (14) 1/2" GAS CHARGE FITTING
- (15) LIFTING HOLES
- (16) CLEARANCE ACCESS RECOMMENDED
- ("G") BARYCENTRE

Size 61-71-81-91

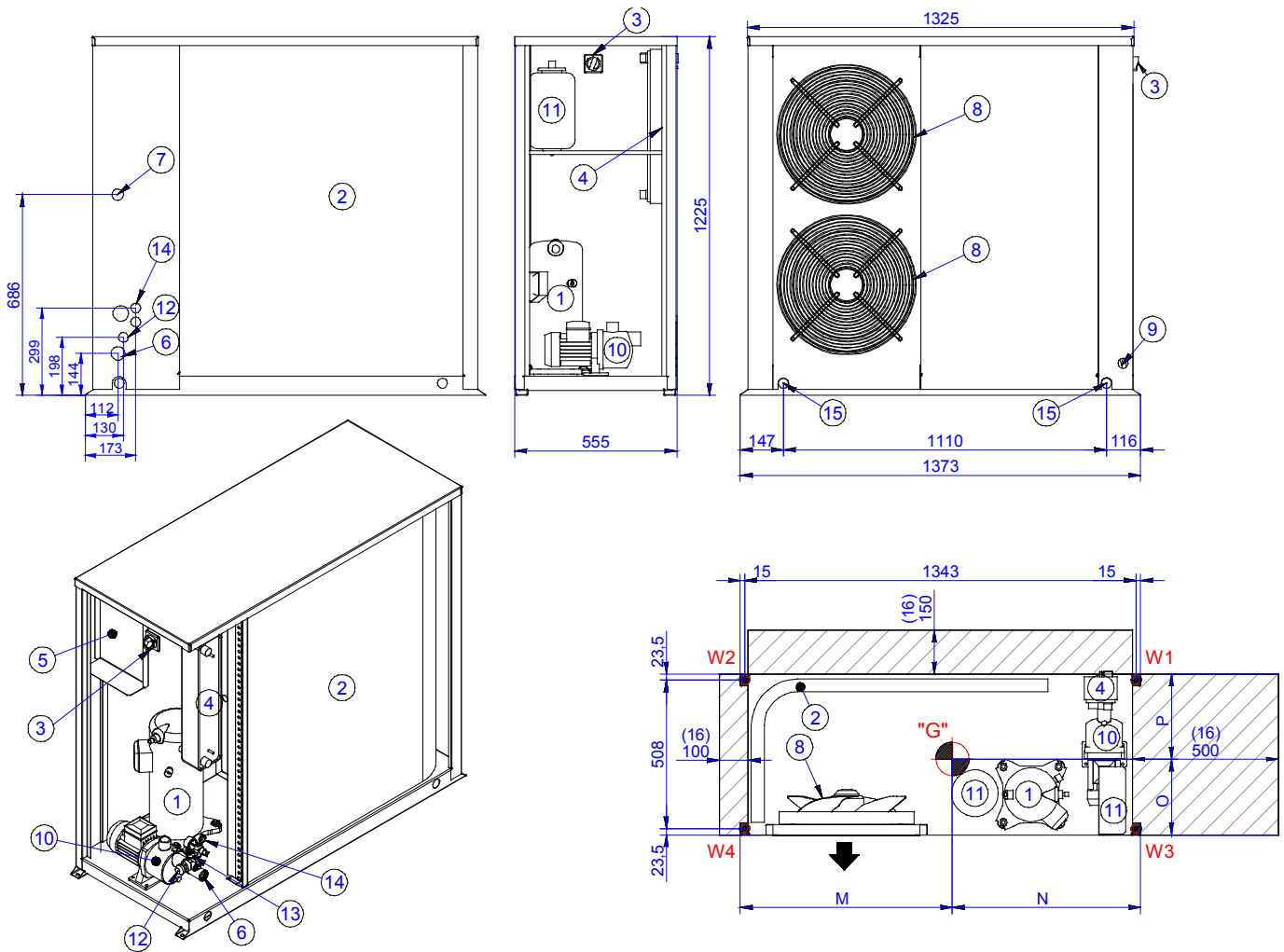

The units require minimum clearances for operation and maintenance. The following sketch describes the minimum clearances to be considered. In the event of multiple units, the functional clearances must be doubled.

Size		61	71	81	91
M	mm	675	675	677	680
N	mm	650	650	648	645
O	mm	265	265	265	265
P	mm	290	290	290	290
Length	mm	1325	1325	1325	1325
Depth	mm	555	555	555	555
Height	mm	1225	1225	1225	1225
W1	kg	51	52	53	54
W2	kg	32	32	33	33
W3	kg	53	54	55	56
W4	kg	34	34	34	35
Operating weight	kg	170	172	175	178
Shipping weight	kg	168	170	173	176

- (1) COMPRESSOR
- (2) EXTERNAL EXCHANGER
- (3) MAIN ISOLATOR SWITCH
- (4) INTERNAL EXCHANGER
- (5) ELECTRICAL PANEL
- (6) WATER INLET 1" GAS
- (7) WATER OUTLET 1" GAS
- (8) HELICAL FANS
- (9) POWER INPUT
- (10) PUMP
- (11) EXPANSION VESSEL
- (12) WATER SIDE SAFETY VALVE
- (13) WATER FILL ASSEMBLY WITH PRESSURE GAUGE
- (14) 1/2" GAS CHARGE FITTING
- (15) LIFTING HOLES
- (16) CLEARANCE ACCESS RECOMMENDED
- ("G") BARYCENTRE

CLIVET SPA
Feltre (BL) ITALY
Tel. + 39 0439 3131
Fax + 39 0439 313300
info@clivet.it

CLIVET ESPAÑA S.A.
(Madrid) SPAIN
Tel. + 34 91 6658280
Fax + 34 91 6657806
info@clivet.es

CLIVET UK LTD
Fareham (Hampshire) U.K.
Tel. + 44 (0) 1489 572238
Fax + 44 (0) 1489 573033
info@clivet-uk.co.uk

CLIVET NEDERLAND B.V.
Amersfoort - Netherlands
Tel. + 31 (0) 33 7503420
Fax + 31 (0) 33 7503424
info@clivet.nl

CLIVET TFA (PVT) LTD
Bangalore - INDIA
Tel. + 91 80 25351617
Fax + 91 80 25351392
sales@clivettfa.com

The data contained in this bulletin is not binding and may be changed by the manufacturer without prior notice. All reproduction, even partial, is PROHIBITED.

© COPYRIGHT - CLIVET S.P.A. - FELTRE (BL) - ITALIA