



# WSAR-MT

## 21-25-31-41-51-61-81

AIR-WATER HEAT PUMP FOR OUTDOOR INSTALLATION

### Installation and Use Manual



<b>UNIT IDENTIFICATION</b> .....	<b>4</b>
<b>INSTRUCTIONS FOR THE USER</b> .....	<b>5</b>
<b>GENERAL WARNINGS</b> .....	<b>6</b>
<b>RESIDUAL RISKS</b> .....	<b>7</b>
<b>RECEPTION</b> .....	<b>10</b>
INSPECTION UPON RECEPTION.....	10
STORAGE.....	10
HANDLING.....	10
<b>POSITIONING</b> .....	<b>11</b>
GENERAL.....	11
FUNCTIONAL CLEARANCES.....	11
POSITIONING.....	11
<b>WATER CONNECTIONS</b> .....	<b>13</b>
GENERAL.....	13
EXCHANGER USE SIDE.....	13
WINTER CONDENSATION.....	14
<b>ELECTRICAL CONNECTION</b> .....	<b>15</b>
GENERAL.....	15
STANDARD UNIT ELECTRICAL DATA.....	15
CONNECTION TO THE MAINS.....	16
<b>START-UP</b> .....	<b>21</b>
PRELIMINARY CHECKS.....	21
REFRIGERANT SYSTEM.....	21
WATER SYSTEM.....	21
ELECTRICAL SYSTEM.....	21
VERIFY TENSIONS – ABSORPTIONS.....	21
UNIT EQUIPPED WITH SCROLL COMPRESSORS.....	21
REMOTE INPUT CONFIGURATIONS.....	22
SETTING THE SET-POINT.....	22
EVAPORATOR WATER FLOW RATE.....	22
REFRIGERANT CIRCUIT PARAMETER CHECK.....	22
<b>CONTROL</b> .....	<b>23</b>
<b>ALARMS</b> .....	<b>27</b>
<b>STATA</b> .....	<b>29</b>
<b>ROUTINE MAINTENANCE</b> .....	<b>31</b>
<b>SERVICES : PARTS SUBJECT TO INTERVENTION</b> .....	<b>31</b>
MAINTENANCE INSPECTIONS.....	32
97/23 CE PED directive.....	32
PUT AT REST.....	32
REFRIGERANT TABLES.....	33
<b>TROUBLESHOOTING</b> .....	<b>34</b>
<b>DECOMMISSIONING OF THE UNIT</b> .....	<b>36</b>
DISCONNECTING THE UNIT.....	36
DISMANTLING AND DISPOSAL.....	36
TECHNICAL DATA.....	38
DIMENSIONS.....	41

## UNIT IDENTIFICATION

### SERIAL NUMBER LABEL

The units are identified by the serial number label shown here.

The label lists the type of unit (series and size), serial number, year of manufacture, number of electrical diagram, main technical data, logo and address of the manufacturer.

The label is placed on the unit, generally near the electrical panel and also on the external panelling.

IT MUST NEVER BE REMOVED.

### SERIAL NUMBER

This provides unique identification of the machine. It makes it possible to trace the specific features of the unit and to identify the components installed in it.

Without this number, it is not possible to identify with certainty the spare parts that are specific to that unit.

When requesting assistance, always provide the type of machine and the serial number.

Write them in the space below so that they are readily available when needed.

Type of unit : \_\_\_\_\_

Serial number : \_\_\_\_\_

Wiring diagram : \_\_\_\_\_

Year of manufacture : \_\_\_\_\_

<div style="display: flex; justify-content: space-around; align-items: center;"> <div style="border: 1px dashed black; padding: 5px; font-weight: bold; font-size: 1.2em;">LOGO</div> <div style="font-size: 2em; font-weight: bold;">CE</div> </div>	
<small>TIPO TYPE/TYP TYPE/TIPO</small>	
<small>NUMERO MATRICOLA SERIAL NUMBER / SERIENNUMMER NUMERO DE SERIE / NUMERO DE SERIE</small>	
<small>ANNO DI FABBRICAZIONE YEAR OF MANUFACTURE / BAUJAHR ANNEE DE FABRICATION/AÑO DE FABRICACIÓN</small>	
<small>REFRIGERANTE REFRIGERANT / KÄLTEMITTEL REFRIGERANT / REFRIGERANTE</small>	<small>GRUPPO (PED) GROUP / GRUPPE GROUPE / GRUPO</small>
<small>CARICA REFRIGERANTE REFRIG. CHARGE / KÄLTEMITTELFÜLLUNG CHARGE REFRIG./CARGA REFRIG.</small>	<small>Kg</small>
<small>TENSIONE VOLTAGE / SPANNUNG TENSION / TENSION</small>	<small>V/Ph/Hz</small>
<small>F.L.A.</small>	<small>A</small>
<small>F.L.I.</small>	<small>kW</small>
<small>SCHEMA ELETTRICO WIRING DIAGRAM / SCHALTPLAN SCHEMA ELECTRIQUE/ESQUEMA ELÉCTRICO</small>	
<small>PRESSIONE MASSIMA ESERCIZIO MAX OPERATING PRESS. / MAX BETRIEBSDRUCK PRESS. DE SERVICE MAXI/PRESION DE EJERCICIO MÁX</small>	
<small>CATEGORIA PED PED CATEGORY / PED KATEGORIE CATEGORIE PED / CATEGORIA PED</small>	<small>PS H/L bar</small>
<small>TEMP LATO BP TEMPERATURE ON LP SIDE / TEMP. ND-SEITE TEMP. COTE BP / TEMP. PARTE BP</small>	
<small>INDIRIZZO / ADDRESS / ADRESSE / ADRESSE / DIRECCION</small>	

## INSTRUCTIONS FOR THE USER

- **This is a partial shynthesis of the information provided in the manual; carefully read this manual**
- Carefully read this manual. Keep it with the electrical diagram. Make it available to technicians for servicing.
- Ask the installer for training on start-up, shutdown, changing set points, placing in at-rest status, maintenance, what to do or not to do in the event of a breakdown.
- Provide for scheduled maintenance by specialized technicians so as to ensure long-lasting operation of the unit.
- If you expect the machine to be shut down for long periods of time, disconnect the electrical power supply. In winter, take necessary measures to deal with possible freezing (unit and system pipes) .

### PRINCIPLE OF OPERATION

**SUMMER:** the cooling cycle allows the transfer of excess indoor heat to the external environment.

1. The compressor compresses the refrigerant gas, placing it at high pressure and high temperature.
2. In the external coil, the refrigerant is cooled, and the heat is released into the environment by means of the fan. This is why the coil needs to be kept clean and free of obstacles.
3. When it cools, the refrigerant becomes liquid.
4. The expansion valve causes a sudden drop in the pressure of the refrigerant, which becomes very cold as its volume increases.
5. In the exchanger, the refrigerant evaporates and absorbs the heat from the water that returns to the system, cooling it.

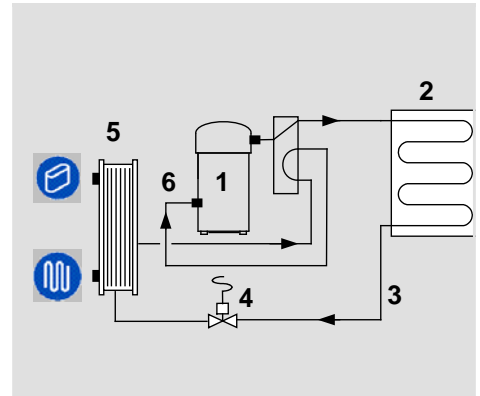

**WINTER :** the cooling cycle makes it possible to absorb energy (heat at low temperature) from the external environment and to transfer it to the area to be heated.

1. The compressor compresses the refrigerant fluid, placing it at high pressure and high temperature.
2. The 4-way valve reverses the flow with respect to respect to SUMMER operation.
3. In the plate exchanger, the water that returns to the system absorbs heat from the refrigerant.
4. As it cools, the refrigerant condenses and becomes liquid.
5. The expansion valve causes a sudden drop in the pressure of the refrigerant, which becomes very cold as its volume increases.
6. In the external coil, the cold refrigerant evaporates and absorbs heat from the fresh air. In this phase, as the coil cools, it may freeze. This is why the cycle is automatically reversed periodically for a short time so as to defrost it

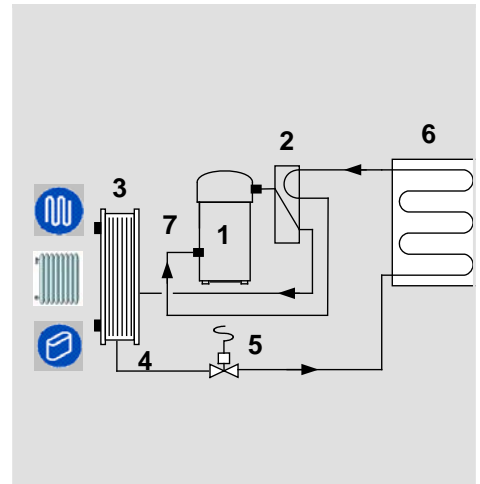

## GENERAL WARNINGS

### MANUAL PURPOSE

This manual has been designed to enable the unit to be installed, started up and maintained correctly.

### MANUAL INSTRUCTIONS

It is essential to observe these instructions.

The manufacturer declines all liability for any damage that may be caused whether directly or indirectly to persons or things if these instructions are not heeded.

### MANUAL STORAGE

This manual and the unit's wiring diagram should be carefully stored so that they are readily available to the operator when required.

### EXPERT PERSONAL

The unit must be installed, tested and maintained by expert personal who meet the relevant legal requirements (Italian law No. 46 of 5/3/1990).

### LOCAL SAFETY REGULATION INSTALLATION

The installation must be performed observing the local safety regulations.

### POWER SUPPLY

Make sure the power supply conforms to the data on the unit's rating plate, located inside the door of the main electrical panel.

### PACKAGING

The packaging material (plastic bags, polystyrene foam, nails, etc.) is potentially dangerous and should therefore be kept away from children and recycled in compliance with the local regulations in force.

### MAINTENANCE

Before performing any service operations, cut off the power. Perform the operations in conformity with the local regulations in force.

### PERIODICAL INSPECTIONS

Perform periodical inspections to locate possible loosened or broken parts. If the repairs are not performed, there will be a higher risk for things and peoples to become damaged and injured.

### FAULT – POOR OPERATION

Switch off the unit in the event of faults or poor operation.

### REPAIR

Only have repairs carried out by a service centre authorised by the manufacturer, and insist on the use of original spare parts only.

Failure to comply with the above may compromise the safety of the unit.

### MODIFICATIONS

The manufacturer will not accept any responsibility, and the warranty will lapse, in the event of electric and/or mechanical modifications. Any modification which is not formally authorized, and which does not respect the instructions given in this manual, will cause the warranty to lapse.

### INTENDED USE

The unit must only be used for the specific purpose it was designed :

The unit is designed to cool/heat water or a water and glycol mix for air-conditioning, within the limits defined in the technical bulletin and this manual.

Any use other than that specified does not imply any commitment or constraint by the manufacturer in any way whatsoever.

### ADDITIONAL SAFETY PRECAUTIONS

This unit has been especially designed and manufactured so to prevent any risk to persons and health hazard. For this reason, design solutions fit to eliminate (where possible) any cause of risk and sensibly reduce the probability of danger have been adopted. Please refer to the "Residual Risks" section of this manual and strictly observe the behaviour prescriptions listed there in order to prevent any possible risk that hasn't been possible to avoid in the design stage.

### DATA UPDATING

The manufacturer may be able to modify the data without prior notice as a consequence of constant improvements.

## REGULATIONS AND CERTIFICATIONS

### UNI EN ISO 9001 CERTIFICATION

Clivet S.p.A., in order to guarantee customer satisfaction, has chosen the ISO 9001 Quality System as the reference for all its business activities. This is demonstrated by the company's commitment to ongoing improvements in the quality and reliability of its products; its sales, design, purchasing, production and after-sales service activities are the means used to reach such purpose.

### CE MARK



Clivet products bear the CE mark, in compliance with the requirements of the following EC directives, including the latest amendments, and with the corresponding national approximated legislation:

- - 98/37/CE
- - 89/336/CEE as modified by the directives 92/31/CEE and 93/68/CEE
- - 73/23/CEE as modified by the directive 93/68/CEE
- - 97/23/CE

### EUROVENT CERTIFICATION



Clivet is participating in the EUROVENT Certification Programme "Liquid Chilling Packages". Products are listed in the EUROVENT Directory of Certified Products and in the site [www.eurovent-certification.com](http://www.eurovent-certification.com). Eurovent Chillers Certification Programme covers air cooled packaged chillers up to 600 kW and water cooled packaged chillers up to 1500 kW.

## RESIDUAL RISKS

### GENERAL

This section lists some of the more common situations which, being beyond the control of the manufacturer, could be a source of risk to persons or property.

### DANGER AREA

The figure below highlights the area in which only authorised personnel may operate.

- **External danger zone**, identified by a precise area around the unit and its vertical projection on the ground in the case of hanging unit.
- **Internal danger zone**, identified by the area that can be entered only after having intentionally removed the protecting panels or parts of these.

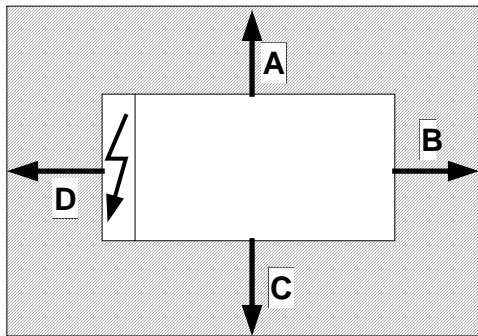

A = 1000 mm

B = 1000 mm

C = 1000 mm

D = 1000 mm

### HANDLING

If handling operations are undertaken without adopting all the necessary safety procedures and exercising due care, the unit can fall or topple, causing damage — possibly extremely serious — to persons and/or property, and to the unit itself.

Ensure the unit is handled and manoeuvred as directed on the packing and in the present manual, and in accordance with local regulations.

In the event of refrigerant gas escaping, refer to the “Safety datasheet” for the particular refrigerant.

### INSTALLATION

Incorrect installation of the unit can result in water leaks, accumulation of condensate, escape of refrigerant, electric shocks, fire, as well as irregular operation or damage to the unit itself.

Make certain that the installation is carried out only by a qualified technician, also that the directions contained in this manual are followed and local statutory regulations observed.

In the event of the unit being installed in a site where there is even the slightest risk of inflammable gas escapes and consequently the possibility of such gases accumulating in area around the unit, the risk of explosion and fire cannot be discounted.

Take every care and precaution when selecting the installation site.

Installation on a structure not able to bear the weight and/or afford a secure anchorage of the equipment may cause the unit to fall and/or topple, resulting in damage to persons or property, or to the unit itself. Make certain that every care

and precaution is taken when positioning and securing the unit.

If the unit is easily accessible to children, unauthorized persons or animals, this is a situation that can give rise to accidents and injuries, perhaps serious. Install the unit in a place where access is allowed only to authorized persons, or install barriers or casing preventing unauthorized entry.

### GENERAL RISKS

A smell of burning, smoke or other indications of serious irregularity could signal the onset of situations liable to cause damage to persons or property or to the unit itself. Isolate the unit from the electrical power supply (red-and-yellow) switch.

Contact an authorized service centre so that the source of the problem can be identified and remedied.

Accidental contact with heat exchange coils, compressors, pressure pipelines or other components can result in wounding or burns, or both.

Always wear suitable clothing, including protective gloves, when working in the danger area.

Maintenance or repairs carried out by unskilled operatives can result in harm or damage to persons and property, or to the unit itself. Always contact an authorized service centre.

Failure to close the panels of the unit, or to check that all the fixing screws of the panels are properly tightened, can result in harm or damage to persons or property, or to the unit itself.

Verify periodically that all panels are closed and made properly secure.

In the event of fire, the temperature of the refrigerant can rise to the point that pressure will exceed safety levels and perhaps cause fluid to be projected. It may also happen that parts of the circuit isolated by closed valves will explode.

Do not stand near safety valves, and never leave the valves of the refrigerant circuit closed.

### ELECTRICAL SYSTEM

If the power line connecting the unit to the a.c. supply is incomplete, or if the connection is made with cables of incorrect cross section and/or with insufficiently rated protective devices, this can result in electric shock, toxicity hazard, damage to the unit or fire.

All work on the electrical system should be carried out referring to the wiring diagram and to the directions given in this manual, and the system itself must be dedicated.

Failure to secure the cover enclosing electrical components can lead to the infiltration of dust and water, ultimately causing electric shocks, damage to the unit, or fire.

Always fasten the cover securely to the unit.

If live metal parts of the unit are not connected properly to the earth system, they can cause electric shock or even death by electrocution.

Make absolutely certain that the connection to the earth system is made in accordance with correct practice.

Contact with live parts rendered accessible internally of the unit when the casing are removed can result in electric shock, burns or death by electrocution.

Before exposing these parts, make certain the isolating switch on the power line to the unit is set to the OFF position and padlocked, and post a warning sign.

Contact with parts that could become live when the unit is started up can result in electric shock, burns or death by electrocution.

When there is no need for circuits to be powered up, set the isolating switch on the power line to the OFF position, padlock it and post a warning sign.

**MOVING PARTS**

Contact with the fan rotors can cause injury.

Before removing the protective grilles or the fans themselves, make certain the isolating switch on the power line to the unit is set to the OFF position and padlocked, and post a warning sign.

Before removing the protective grilles or the fans themselves, make certain the isolating switch on the power line to the unit is set to the OFF position and padlocked, and post a warning sign.

**REFRIGERANT**

In the event of safety valves coming into operation and releasing refrigerant gas, persons in the vicinity can be

injured or suffer toxic effects. Always wear suitable clothing and protective goggles when working in potential hazard areas.

In the event of refrigerant gas escaping, refer to the "Safety datasheet" for the particular refrigerant.

If an open flame or heat source is brought into contact with the refrigerant, or the pressurized gas circuit should overheat (e.g. during welding operations), this can cause explosion or fire. Do not position any heat source within the hazard area.

Maintenance or repair operations involving welding must be carried out with the system emptied of refrigerant.

**WATER SYSTEM**

Defects affecting pipelines, connections or valves and other control componentry can result in water being leaked or sprayed from the system, occasioning damage to property or causing short circuits in the unit.

Make certain all hydraulic connections are securely made, following the directions given in the present manual.

**REFRIGERANT SAFETY CHARGE**

<b>R-407C</b>		
01	Identification of the product and of the supplier	Chart No FRIG 8 Product R-410A Identification of the supplier. See heading or bottom of page. No of emergency telephone. See heading or bottom of page.
02	Composition / information on ingredients	Substance/ Compound . Compound Elements / Impurities. It contains the following elements Difluorometan (R32) 50 % in weight Pentafluoroetan (R125) 50 % in weight CEE No Non applicable for mixtures. Commercial name /
03	Hazard identification	Hazard identification. Liquefied gas. Vapours are heavier than air and can cause choking by reducing the oxygen available for breathing. A rapid evaporation of the liquid can cause freezing. It can cause cardiac arrhythmia.
04	First aid measures	Inhalation. Do not administer anything to fainted people. Take to open air. Administer oxygen or practice artificial breathing if necessary. Do not administer adrenaline or similar substances. Contact with eyes. Rinse carefully with plenty of water for at least 15 minutes and consult a doctor. Contact with the skin. Rinse immediately with plenty of water. Immediately take off all contaminated cloths. Ingestion. Way of exposure not very probable.
05	Anti-fire measures	Specific hazards. Pressure increase. Dangerous combustible products. Halogen acids, traces of carbonyl halogens. Extinction means. You can use all extinction means available. Special methods. Cool the containers/tanks with sprays of water. Special protection means. In close spaces, use the self-breather.
06	Measures against the accidental leakages of the product.	Personal protections. Evacuate the personnel in safety areas. Foresee an adequate ventilation. Use means of personal protection. Protection for the environment. It evaporates. Methods for eliminating the product. It evaporates.
07	Handling and stocking.	Handling and stocking. Assure a sufficient exchange of air and/or a suction system in work areas. Use only in well-ventilated rooms. Do not breathe vapours or aerosols. Carefully close the containers and keep them in a cool, dry and well-ventilated place. Keep in the original containers. Incompatible products. Explosives, inflammable materials, organic peroxides.
08	Check of the exposition / personal protection	Personal protection. Assure an adequate ventilation, especially in closed rooms. Control parameters. Difluorometan (R32): Recommended limits of exposition: AEL (8h and 12h TWA) = 1000 ml/m3 Pentafluoroetan (R125): Recommended limits of exposition: AEL (8h and 12h TWA) = 1000 ml/m3 Protection of respiratory tract. For the rescue and for service work in the tanks, use an autonomous breather. Vapours are heavier than the air and can cause choking by reducing the oxygen available for breathing. Protection for the eyes. Total protection glasses. Protection for the hands. Rubber gloves. Hygienic measures. Do not smoke.



09	Chemical -physical properties.	Relative density, gas (air=1) Heavier than air. Solubility in water (mg/l). Not known, but probably very low. Aspect. Colorless liquefied gas. Smell. Simile to ether. Point of ignition. Don't ignite.
10	Stability and reactivity.	Stability and reactivity. No decomposition if used following the instructions. Materials to avoid. Alkaline metals, earth alkaline metals, granulated metal salts, Al, Zn, Be etc. in powder. Dangerous decomposition products. Halogen acids, traces of carbonyl halogens.
11	Toxicological information	Local effects. Concentration substantially above the TLV value (1000 ppm) can cause narcotic effects. Inhalation of products at high concentration decomposition can cause respiratory insufficiency (pulmonary edema). Long term toxicity. It has shown no carcinogenic, teratogen or mutagenic effects on animal experiments. Specific effects. A rapid evaporation of the liquid can cause freezing. It can cause cardiac arrhythmia.
12	Ecological information	Effects connected to ecotoxicity Pentafluoroetan (R125) Potential of global heating of halocarbides; HGWP; (R-11 = 1) = 0.84 Potential of ozone impoverishment; ODP; (R-11 = 1) = 0
13	Disposal considerations	General considerations. Do not drain where the accumulation can be dangerous Usable as reconditioning. Depressurized containers should be given back to the supplier. Contact the supplier if the use of instructions is necessary.
14	Transport information	Designation for the transport LIQUEFIED GAS N.A.S (DIFLUOROMETAN, PENTAFLUROETAN) UN No 3163 Class/Div 2.2 ADR /RID Nr 2, 2°A No hazard ADR/RID 20 ADR Label. Label 2: not toxic gas not inflammable. CEFIC Groupcard 20g39 - A Other information for the transport. Avoid the transport on vehicles where the loading zone is not separated from the driver compartment. Verify that the driver is informed on the potential risk of the load and that he knows what to do in case of an accident or emergency. Before starting the transport, verify that the load is well fixed and : Verify that the container valve is closed and does not leak Verify that the blind cap of the valve, if supplied, is correctly assembled. Verify that the cap (if supplied) is well assembled and that there is adequate ventilation Verify that the norms in force are respected.
15	Information on the norms in force	The product must be labeled according to the 1999/45/CE normative. Observe the following norms, the relevant updating and the applicable modifications: Circulars no.46/79 and 61/81 of the Work Ministry: risks connected to the use of products containing aromatic amines. Law Decree no. 133/92 : Norms relevant to the draining of dangerous substances in water Law Decree no. 277/91 : Protection of workers for noise, lead and amianthus Law 256/74, Ministerial Decree of 28th Jan. 1992, Legislative Decree no 52 of 3rd Feb. 1997, Ministerial Decree of 28 <sup>th</sup> Apr. 1997 and following modifications: Classification, packaging and labeling of compounds and dangerous substances Decree of the Republic President no.175/88, following modifications and updating: Activities with risks of serious accidents (Seveso Law) Decree of the Republic President no 203/88 : Emissions in the atmosphere Decree of the Republic President no.303/56: Hygiene of work Decree of the Republic President no.547/55 : Norms concerning the accident prevention Legislative Decree. no.152 of 11th May 1999 : Protection of waters.
16	Other information	Suggested uses. Refrigerant. High concentrations can cause asphyxia. Keep in a dry and well-ventilated place. Do not breathe in the gas. The asphyxia risk is often under-evaluated and must be put into evidence during the operator's training.

Verify that all national and regional regulations are observed.

Before using this product in any new process or experiment, a deep study about the safety and the product compatibility with the materials must be performed.

The above information is based on our present know-how and describes the product considering the safety needs. However, they do not represent a guarantee and a warranty of the qualities in a juridical sense. Everyone is personally responsible for the observation of these norms.

Information present in this document is valid at the time of printing. The company is not responsible for any damages caused by the incorrect use of the product and/or for the use in conditions different from the conditions suggested.

## RECEPTION

### INSPECTION UPON RECEPTION

Check on arrival that the unit has not suffered damage during transit and that it is complete in every part as specified in the order. In the event of visible damage/deficiencies being discovered, make a note immediately on the delivery document with the comment: **CONDITIONAL ACCEPTANCE — CLEAR EVIDENCE OF DEFICIENCIES/DAMAGE DURING TRANSIT**

Inform both the supplier and the carrier of the details by fax and by registered mail with advice of receipt not later than 8 days after taking consignment. Notifications sent after 8 days have elapsed will be ignored.

### STORAGE

Shelter from: direct sunlight, rain, sand and wind

Temperature: maximum 60°C minimum -10°C

Maximum humidity: 90%

The respect of the instructions on the exterior side of the packaging assures the physical and functional integrity of the unit for the final user's advantage.

It is recommended to:

- Handle carefully
- Keep in a dry place
- Avoid putting other objects on top of the unit (respect the limits of levels of superimposition shown in the package)
- Avoid placing the unit with thermoretractable protection under the sun since the pressure of the circuits can assume values which activate the safety valves.

### HANDLING

The operation of handling the unit must be carried out respecting the instructions of the safety norms in force (Legislative Decree 626/94 and following modifications)

Before starting the handling operations:

- Value the critical points during handling (stairs, flights, disconnected routes, doors, etc)
- Verify that the lifting capacity of the means used is adequate to the unit weight
- Consider that the barycentre could be moved with respect to the center of the unit
- Before starting to lift, verify that the unit is at a stable balance

The choice of the means and of the handling modes will depend on factors, such as:

- The unit weight
- Type and overall dimensions of the unit
- Place and route for the handling (dirt yard, asphalted square, etc)
- Condition of the place of destination (roof, square, etc)
- Handling distance characteristics (distances, flights, steps, doors)

### REMOVING THE PACKING

For removing the packaging, use specific personal protection for the operator (gloves, glasses, etc.).

While removing the packaging, pay attention not to damage the unit.

Check for any visible damage.

Dispose of the packaging by taking it to specialist collection or recycling centres in accordance with local regulations

## POSITIONING

### GENERAL

For installing air-conditioning systems, it is necessary to consider the following:

- the technical spaces necessary for the machine and system
- the place where the machine will be installed
- the transport of thermal carrier fluids and relevant connections to the unit:
  - water
  - air
  - refrigerant (unit in more sections)
- electrical connections

If these aspects are not evaluated carefully, they can affect the performances and the working life of the unit.

### FUNCTIONAL CLEARANCES

When placing the unit, please respect the functional clearances indicated in DIMENSIONS section.

The functional spaces need to be observed because of the following:

- to guarantee the good operation of the unit
- to allow the performance of all maintenance operations
- to protect the authorized operators and exposed people

If more units are placed close to one another, the functional spaces must be doubled.

### POSITIONING

1. The units are designed for **OUTDOOR** installations, performed in fixed positions and in areas accessible only to qualified and authorized personnel
2. **SAFETY VALVE** (only if present on the unit) : the installer is responsible for evaluating the opportunity of installing drain tubes, in conformity with the local regulations in force ( EN 378 )
3. Install the unit **raised** from the ground
4. avoid installations in places subject to **flooding**
5. Consider the maximum level which can be reached by **snow**

6. Verify that the fixing/supporting points are level and suitable to support the **weight of the unit** (see the weight and the weights distribution)

7. It is recommended to put the unit on specific **antivibration devices**

8. **Anchor** the unit to the ground; foresee windbreak barriers in case of places where there are strong prevalent winds .

9. During winter operation, a considerable amount of **condensation** water is produced, which must be removed from the unit.

Make sure that removal of condensation water does not create any problems for persons or property, such as dripping from balconies, onto walkways, etc.

For long periods of heat pump operation with outside temperature below 0 °C, the condensation might **freeze**, causing a build-up of ice. The installation of anti-freeze heating elements should be considered.

For the units that are equipped with a condensation drain, this is shown on the dimensional drawing.

10. The choice of the location of the unit is of fundamental importance for correct operation; to avoid:

- **obstacles** that block the flow of air
- difficulty in air **circulation**
- **leaves** or other objects that may block the exchanger coils
- **winds** that contrast or excessively assist the air flow
- phenomena of **stratification** or air **re-circulation**
- nearby **sources** of heat (chimney, extractor ecc)
- positioning under the round level or near very high walls

The previous situations cause working anomalies or stop the machine and cause.

1. cement base plate
- gravel for frost protection
- gravel - crushed stone for exhaust air condensate absorption
- electrical hydraulic lines

### ANCHOR THE UNIT TO THE GROUND

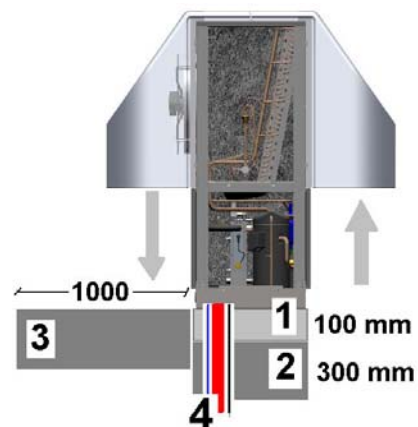
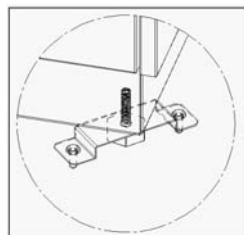
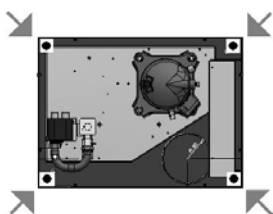

## ACCESS TO THE UNIT INTERIOR

To access to the unit interior remove in sequence :

1. lower lateral panels
2. upper lateral panels
3. the casing

Removable panels and casing



Electrical panel that can be opened

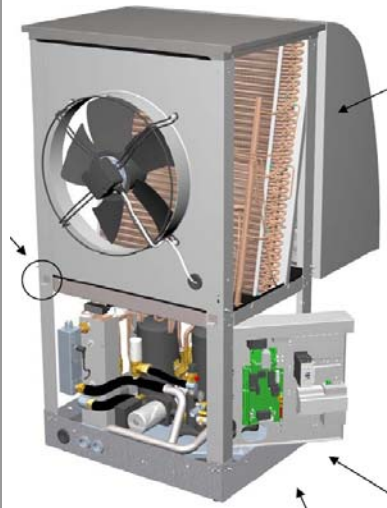

Coupling points for panels and casing

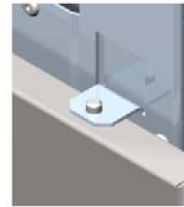

# WATER CONNECTIONS

## GENERAL

Piping must be designed with the least possible number of bends and head variations. If the pressure chute of the installation is above the useful prevalence of the pump, the water delivery capacity is reduced as well as, as a consequence, the thermal exchange and the yield.

### INTERCEPTING VALVES

Install on the input and output of the user parts (exchangers, coils, humidifiers, etc) So that it will be possible to carry out all the service operations and possible substitutions without emptying the installation.

### PRESSURE AND TEMPERATURE INDICATOR

Install on the input and output of the user parts (exchangers, coils, humidifiers, etc) So that it will be possible to carry out all the service operations.

### AUTOMATIC OR MANUAL ESCAPE VALVES

Install the highest points of tubes in a way that the air can escape from the circuit.

### BLEEDING COCK

Install them at the lowest points of the circuit, so as to allow emptying.

### LEAKAGE TESTS

Before performing the insulation of the tubes, carry out a leakage test.

### TUBE INSULATION

All tubes of water must be insulated so that to avoid the formation of condensation and thermal dispersions along the tubes themselves. Verify that the insulation is the vapour coil type. The connections for the air escape and for the emptying must be out of the insulating thickness to assure the accessibility.

## CONNECTIONS SUPPORTS

The weight of the hydraulic connections must be supported in the exterior of the unit so as not to stress the connections of user devices (exchangers, coils, humidifiers, etc) .

### ANTI-VIBRATION DEVICES

In case of units with anti-vibration devices, it is necessary to assemble elastic joints, even on water connections.

### RISK OF FREEZE

If the unit and the relevant water connections are subject to temperatures near 0°C:

- mix the water of the system with glycol
- protect the tubes with heating cables under the tubes insulation
- empty the system by verifying that:
  - no taps are closed so they can not trap the water, even after emptying
  - there are no low points where the water can stagnate even after emptying; blow if necessary

### INSTALLATION EMPTYING

The refilling of the water present in the installation increase the oxidation phenomena and lime deposits.

If necessary empty only the interested system section and anyway empty or refill the installation if necessary .

### EXPANSION TANK

The installation must be kept at the right pressure by both an expansion tank and a combined valve of pressure reduction and discharge; if the components are present on the unit, they must be installed on the installation. The expansion tank must be dimensioned in function of the water in the installation.

**MAX. WORKING PRESSURE = 3 Bar**

ARIES EFFECTS AND AIR BUBBLES CAN PRODUCE THE OVERCOMING AND CAUSE WATER DROPS.

## EXCHANGER USE SIDE

### FLOW SWITCH

The flow switch must be present as a component of the system, so as to ensure shutdown of the unit if water is not circulating. It must be installed in a straight tract of the tubes, not near the elbows, which can generate harmful turbulence

### UNFREEZABLE LIQUIDS

If the unit is used when the water temperature is lower than + 4°C, avoid the formation of ice by using unfreezable liquids (ex. Ethilenic Glycol) in the necessary percentage.

The use must also be determined for ambient temperatures near 0°C .

### ANTIFREEZE RESISTANCES

If the unit is equipped with antifreeze resistances on the exchanger side (standard or optional according to the models), verify that they are electrically fed during periods that the machine is stopped (night, weekends, long stops)

### WASHING THE SYSTEM

Carefully wash the system by using clean water and discharge it before connecting the unit.

## INPUTS

To perform water / electrical connections remove first the plate cover ( 1 )

In case of unit **lower input** , use the pre-cutting hole on the base plate ( B )

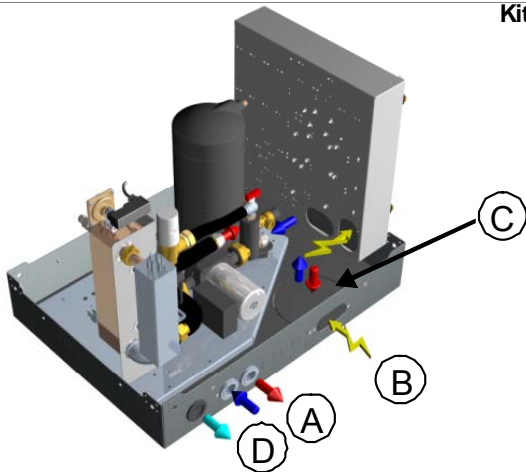
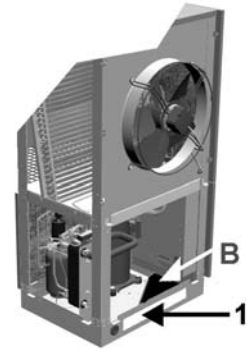

### Kit idronico:

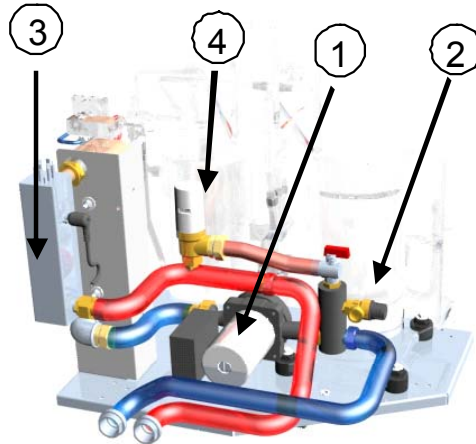

### Unit water and electrical connections

- A Lateral output input for water circuit
- B Electric line input
- C Output input from below for water circuit hole diameter 180 mm
- D Condensate discharge output

### Optional hydronic kit

- 1. circulating pump
- 2. water safety valve 3bar
- 3. integrative resistance 2/4/6 kW
- 4. overpressur valve (by-pass) (only for size 21)  
water circuit expansion tank by 18 litres (only for size 61-81)

## WINTER CONDENSATION

When a heat pump is running it produces a considerable amount of water due to the defrosting cycles of the external coil.

The condensation must be eliminated in a manner to avoid wetting pedestrian areas.

With extensive very cold outdoor temperatures, condensation could freeze and block the flow, causing a slow build-up of ice; therefore special attention must be paid to eliminating condensation, raising the unit off the ground and evaluating whether antifreeze elements should be installed.

- 1) condensate discharge on internal tray
- 2) condensate discharge carried to the outside

Connect the condensate discharge duct (C) to the tray (A).  
Fix it with a clamp (B).

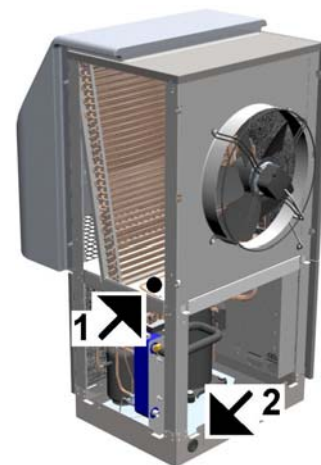

### Condensate connection

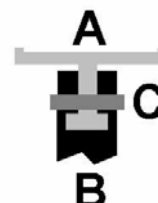

## ELECTRICAL CONNECTION

### GENERAL

The characteristics of the electrical lines and relevant components must be determined by **SPECIALIZED PERSONNEL ABLE TO DESIGN ELECTRICAL INSTALLATIONS**; moreover, the lines must be in conformity with professional procedures and the regulations in force.

All electrical operations should be performed by trained **PERSONNEL HAVING THE NECESSARY REQUISITES UNDER LAW** and being informed about the risks relevant to these activities.

Before performing any operation on the electrical system, make sure that the unit supply line is **SELECTED AT START**.

The earth connection must be made prior to other electrical connections.

For all electrical type operations, **REFER TO THE ELECTRICAL DIAGRAM ATTACHED TO THE UNIT**; the number of the diagram is shown on the registration plate positioned on the electrical board or next to it.

The electrical diagram should be carefully kept together with this manual and should be **AVAILABLE FOR FUTURE INTERVENTION ON THE UNIT**.

#### LINE OF UNIT POWER SUPPLY

The **ELECTRICAL DATA OF THE UNIT** are shown in the technical chart of this manual and on the unit registration plate. The presence of accessories can vary according to

the unit; the electrical data shown in the technical chart refer to standard units. In the event of differences between the data of the registration plate and the data shown in this manual, as well as in the technical chart, please refer to the **DATA SHOWN IN THE REGISTRATION PLATE**.

The protection device of the unit power supply line should break off the short circuit power whose value should be determined according to the plant features.

The section of supply cables and protection cable must be seized according to the characteristics of the protections used.

#### SIGNALS / DATA LINES

Do not overpass the maximum power allowed, which varies, according to the type of signal.

Lay the cables far from power cables or cables having a different tension and that are able to emit electromagnetic disturbances.

Do not lay the cable near devices which can generate electromagnetic interferences.

Do not lay the cables parallel to other cables; cable crossings are possible, only if laid at 90°.

Connect the screen to the ground, only if there are no disturbances

Assure the continuity of the screen during the entire extension of the cable.

Observe, if any, the requirements about impedance, capacity, attenuation

## STANDARD UNIT ELECTRICAL DATA

### OUTDOOR UNIT – BASE CONFIGURATION

#### VOLTAGE 400/3/50+N

Sizes		21	25	31	41	51	61	81
<b>F.L.A. FULL LOAD CURRENT AT MAX ADMISSIBLE CONDITIONS</b>								
FLA Compressor	A	4	5,15	6,61	7,39	9,15	10,69	14,94
FLA Fan	A	0,84	0,84	0,84	0,84	0,84	2,65	2,65
FLA Total	A	4,84	5,99	7,45	8,23	9,99	13,34	17,59
<b>F.L.I. FULL LOAD POWER INPUT AT MAX ADMISSIBLE CONDITION</b>								
FLI Compressor	kW	2,40	3,19	3,90	4,47	5,50	6,42	8,24
FLI Fan	A	0,19	0,19	0,19	0,19	0,19	0,61	0,61
FLI Total	kW	2,59	3,38	4,09	4,66	5,69	7,03	8,85
<b>M.I.C. MAXIMUM INRUSH CURRENT</b>								
MIC - value	A	26,84	32,84	46,84	52,34	64,84	76,65	101,65

#### VOLTAGE 230/1/50

Sizes		21	25	31	41
<b>F.L.A. FULL LOAD CURRENT AT MAX ADMISSIBLE CONDITIONS</b>					
FLA Compressor	A	11,95	15,36	19,14	22,18
FLA Fan	A	0,84	0,84	0,84	0,84
FLA Total	A	12,79	16,2	19,98	23,02
<b>F.L.I. FULL LOAD POWER INPUT AT MAX ADMISSIBLE CONDITION</b>					
FLI Compressor	kW	2,63	3,22	4,02	4,83
FLI Fan	A	0,19	0,19	0,19	0,19
FLI Total	kW	2,82	3,41	4,21	5,02
<b>M.I.C. MAXIMUM INRUSH CURRENT</b>					
MIC - value	A	58,84	76,84	97,84	108,84

## ACCESSORY ELECTRICAL DATA

Sizes		21	25	31	41	51	61	81
<b>Circulating pump data</b>								
F.L.A. – Circulating pump	A	0,95	0,95	1.24	1.24	1.24	3.20	3.20
F.L.I. - Circulating pump	kW	0,20	0,20	0,26	0.26	0.26	0.66	0.66
<b>Integration resistance data</b>								
F.L.A. - Integration resistance	(1) A	26.08	26.08	26.08	26.08	-	-	-
F.L.A. - Integration resistance	(2) A	8.67	8.67	8.67	8.67	8.67	8.67	8.67
F.L.I. - Integration resistance	(3) kW	6	6	6	6	6	6	6

(1) data referred to voltage 230/1/50

(2) data referred to voltage 400/3/50+N

(3) data refer to the highest step of input available on the additional heating elements.

## CONNECTION TO THE MAINS

1. Make sure that the sectioning device at the beginning of the unit's power line is opened, locked and equipped with a signal.
2. Open the general line disconnecting switch (if present)
3. Verify that the net is in conformity with the data shown in the registration plate placed on the electrical board.
4. Check the dimensional drawing for the input of the electrical lines
5. Take away the closing plate placed on the electric board (ONLY IF PRESENT) and drill a hole through it to pass the cables through)
6. Protect the cables, using the fairlead of an adequate size.
7. Using the layout of the electrical diagram, single out the connecting terminals of the electrical supply cables, of the neutral (if foreseen) and the PE protection cable
8. Connect the cables to the relevant terminal boards
9. Before supplying power to the unit, make sure that all the safety devices that were removed during electrical connections are positioned again.

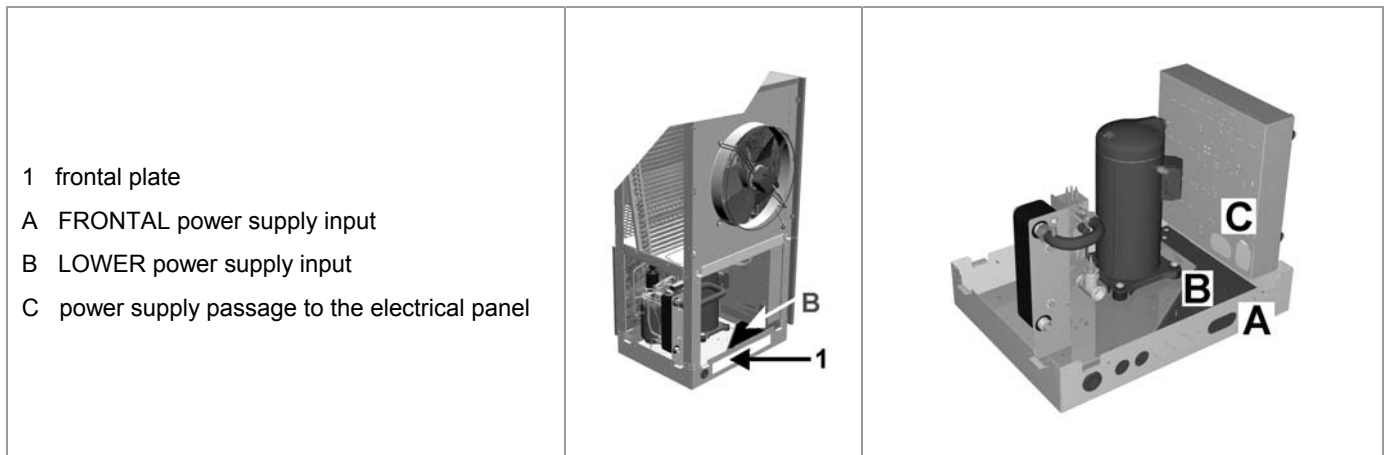

The units can be designed for double power supply

### Low cost mains : XS1

To feed in the reduced fare time bands , control the compressor and the other components

### Constant mains : XS2

Always fed , it controls the resistances.

If the double power supply is used, remove the jumpers ( see the electrical panel ) .

If the single power supply is used, use the **XS1** input

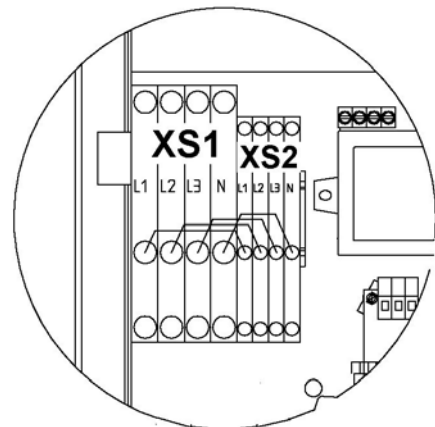



### Customer connection terminal block

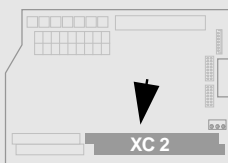

### Remote ON – OFF: S A 1

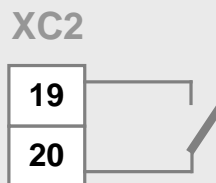

### Remote Summer – Winter: S A 2

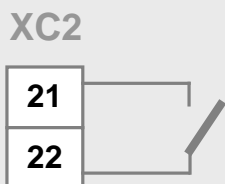

The Summer-Winter operating mode can be chosen by remote selector .

To enable the remote mode change, set the par 280 RemMode = 0 ; the mode can no more be chosen by keypad because the corresponding button is disabled.

To allow the change by keypad or supervisor par 280 RemMode = 1 (standard configuration).

### Remote second set : S A 3

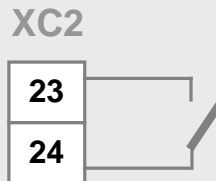

The second setpoint is used to reduce the energy consumptions (ex. by night or during the absence periods).

It can be enabled both by remote and by keypad ; it is not necessary to set any parameter .

The value of the second set can be modified by parameters 42 and 43.

### unit OPERATING signalling

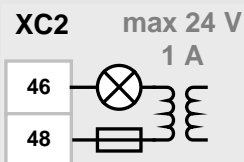

### Unit LOCKOUT signalling

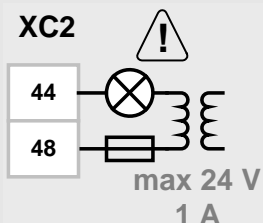

### RS 485 SERIAL COMMUNICATION

RS 485 module on the main board



Shielded cable with twisted conductor

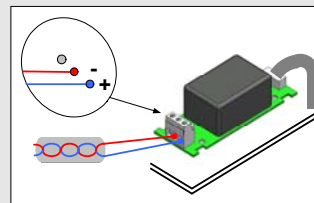

#### TYPE OF CABLE :

Right for the data transmission on the RS-485 serial lines

Twisted and shielded conductor couple

Conductor section 0.22mm<sup>2</sup>...0.35mm<sup>2</sup>

Nominal capacity between conductors < 50 pF/m

Nominal impedance 120 Ω

BELDEN 3105° recommended cable

### Domestic hot water request : S A 4

XC2

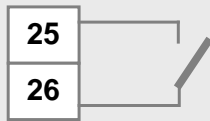

For the production of domestic hot water the 3-way valve must be present. For details see on the side .

When the production of domestic hot water is active, it is not possible to change the operating mode neither by keypad nor by SA2 .

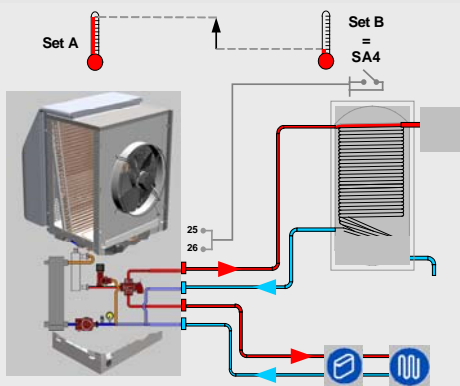

### PARAMETERS TO BE PERSONALIZED

- 12 Enables the domestic hot water management :  
0=No dom. hot water, 1=domestic hot water and system mode without restrictions, 2= domestic hot water and system heat only, 3= domestic hot water and system cool only, 4=only dom. hot water mode
- 359 Enables the outside temp. compensation of the dom. hot water set point: 1=YES, 0=no
- 360 Max. correction value of the outside T for domestic hot water setpoint
- 361 0=Sanitary priority, 1=System priority
- 362 0=Sanitary priority, 1=System priority
- 363 Domestic hot water management: 0=Managed according to the logic set by parameter 12, 1= In Heat always excited, 2= In Cool always excited
- 364 Domestic hot water Set Point**
- 365 Max. recharge time in sanitary for return to system water in the forced management of dom. hot water production
- 366 Max. permanence time in system water where the domestic hot water forced production is prevented

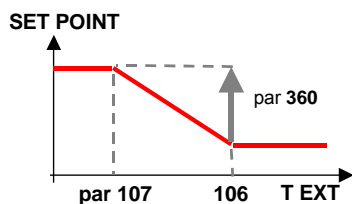

### EXT. 3-WAY VALVE

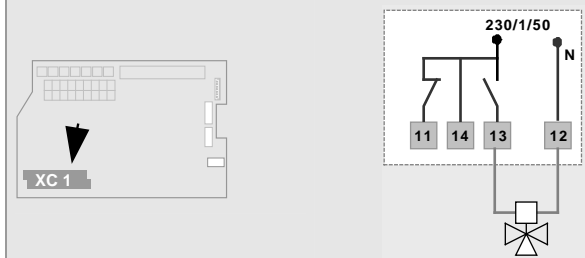

For the production of domestic hot water the 3-way valve must be present .

If the unit has been bought without this option, it is possible to fit the 3-way valve also afterwards.

See also on the side

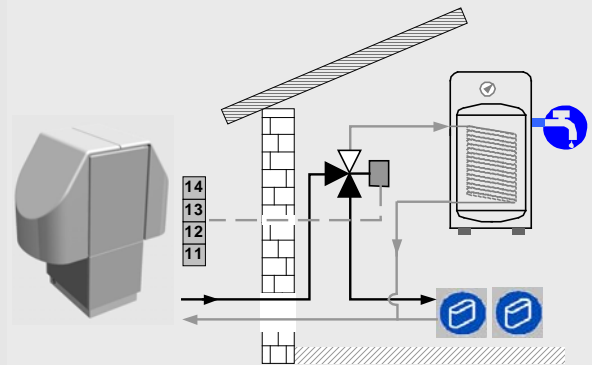

### Compressor disabling : EDS

XC2

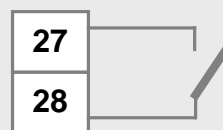

It is possible to disable the compressor from remote contact .

Ex.: if double power supply is available (low cost line, facilitated rate + constant power supply line, normal rate) the compressor can be enabled only during the time bands with facilitated rate.

During the time bands with normal rate, the heating is produced by the integration resistances .

### SET POINT CORRECTION ON OUTSIDE TEMPERATURE and HUMIDITY

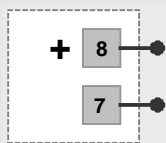
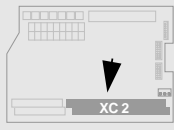

#### SUMMER

With low outside temperatures the refrigerant needs is reduced .

The internal comfort can be obtained also with a set-point higher than standard.

The correction is added to the set-point ( it increases at the outside temp. decreasing)

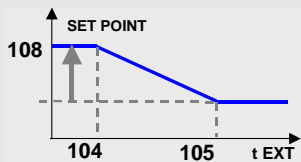

#### WINTER

With mild outside temperatures the thermal needs is reduced.

The internal comfort can be obtained also with a lower set-point.

The correction is subtracted to the set-point ( it decreases at the outside temp. increasing)

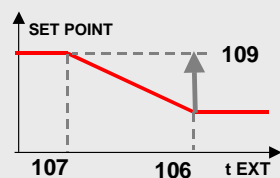

#### Parameters to be personalized

- 4 Enables compensations (0=No 1=Cool 2=Heat 3=Always)
- 104 Outside temp.: max. Summer correction
- 105 Outside temp.: min. Summer correction
- 106 Outside temp.: max. Winter correction
- 107 Outside temp.: min. Winter correction
- 108 Max. Summer correction value
- 109 Max. Winter correction value

### WATER RESET

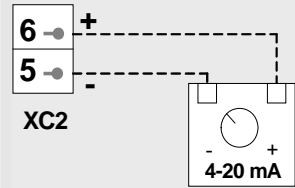
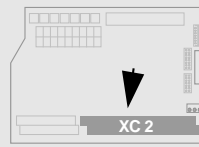

#### SUMMER

If the refrigerant needs is low, the setpoint is lowered: the WR signal is high or maximum.

The correction is added to the set-point (it increases at the outside temp. decreasing)

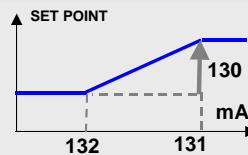

#### WINTER

If the thermal needs is low, the setpoint is lowered: the WR signal is low or null.

The correction is subtracted to the set-point (it decreases at the outside temp. increasing)

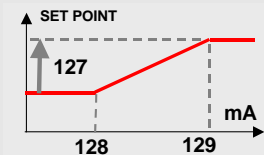

#### Parameters to be personalized

- 5 Enables Water Reset (0=No 1=Cool 2=Heat 3=Always)
- 127 Max. value of the winter WR correction
- 128 Signal corresponding to the max. winter correction
- 129 Signal corresponding to the min. winter correction
- 130 Max. Summer correction value
- 131 Signal corresponding to the max. summer correction
- 132 Signal corresponding to the min. summer correction

### AUXILIARY HEATER IN INTEGRATION

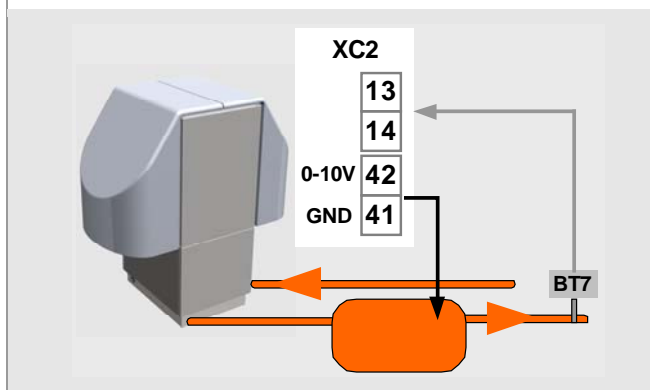

### AUXILIARY HEATER IN REPLACEMENT

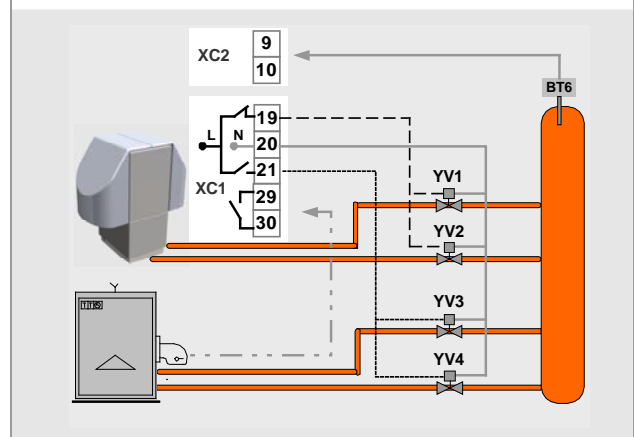

### CLIVET BUS connection

max 50 mt - standard

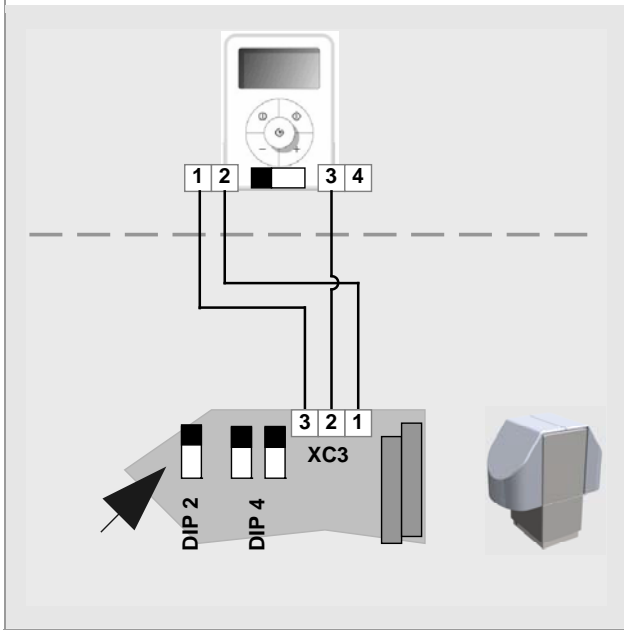

### MODBUS connection

max 1000 mt - optional

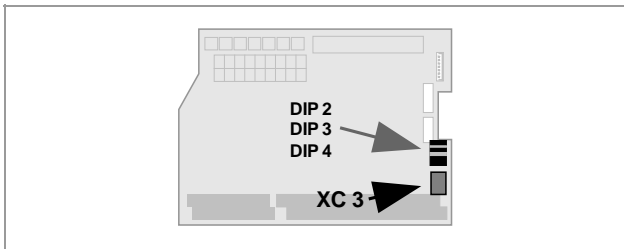
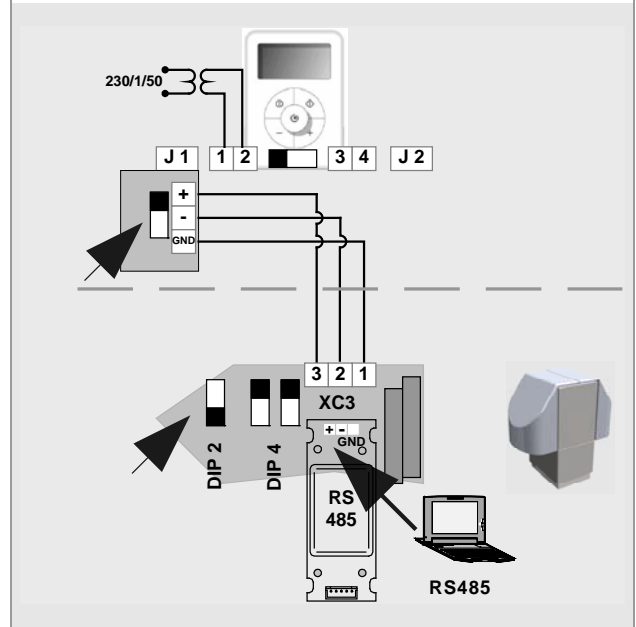

### SYSTEM MANAGER

Necessary configuration if are present the domestic hot water module or the mixing module for radiant panels

max 1000 mt - optional

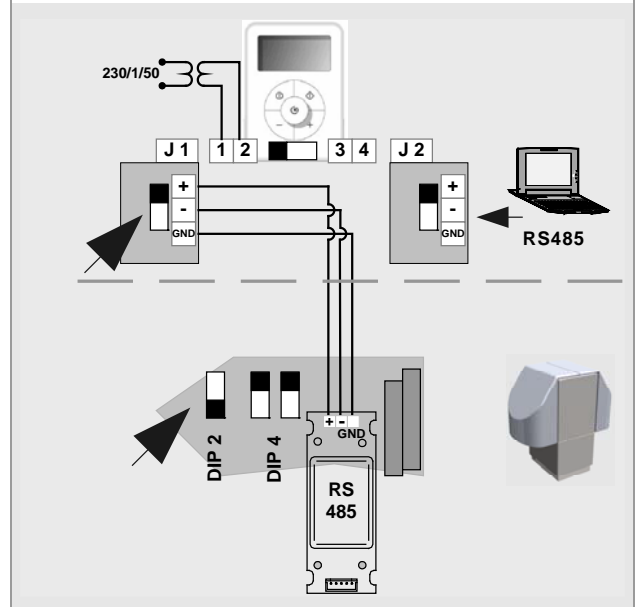

### ROOM CHRONOTHERMOSTAT mode

mode

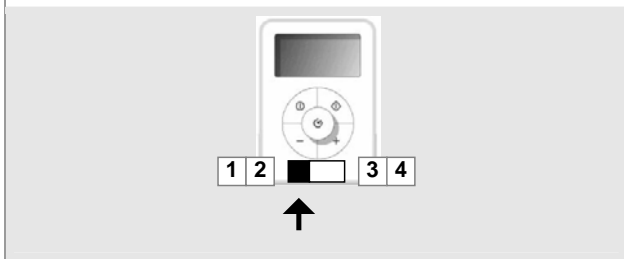

### UNIT INTERFACE KEYPAD mode

mode

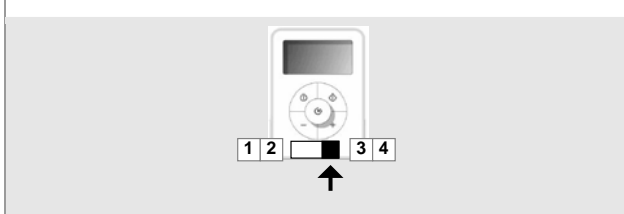

## START-UP

ALL THE EQUIPMENT MUST BE COMMISSIONED BY AUTHORISED SERVICE CENTRES.  
THIS SERVICE IS LIMITED TO START-UP OF THE UNIT ONLY AND NOT THE CONNECTIONS OR INSTALLATION OF THE SYSTEM.

ONLY QUALIFIED TECHNICIANS MUST PERFORM THE FOLLOWING OPERATIONS.

### PRELIMINARY CHECKS

Before checking, please verify the following

1. the unit should be installed properly and in conformity with this manual.
2. the electrical power supply line should be sectioned at the beginning.
3. the sectioning device is locked and the proper warning "not to operate" sign is placed on the handle.
4. make sure no tension is present
5. the coils must be clean and free of obstacles
6. the ventilators must be free of leaves, cardboard, fixed obstacles (beams, barriers, etc.), snow, etc

### REFRIGERANT SYSTEM

Carefully check the refrigerating circuit: the presence of oil stains can mean leakage caused by transportation, movements or other).

Open the cocks of the refrigerator circuit, if there are any.

Using the unit manometers, if present, or service manometers, verify that the refrigerating circuit is in pressure.

Make sure that all the service outlets are closed with proper caps; if caps are not present a leak of refrigerant can be possible.

### WATER SYSTEM

Ensure that the plumbing system has been washed. Drain the wash water before connecting the unit to the system.

Check that the water circuit has been filled and pressurised.

Perform a seal check at max. working pressure checking that no leaks are present.

Check that the shut-off valves in the circuit are in the "OPEN" position.

Check that there is no air in the circuit. If required, bleed it using the vent valves in the system.

Check that there are no ARIES EFFECTS in the transient (pump and / or valve activation/deactivation)

When using antifreeze solutions, make sure the glycol percentage is suitable for the type of use envisaged.

% weight of ethylene glycol	10 %	20 %	30 %	40 %
Freezing point	- 4 °C	- 9 °C	- 15 °C	- 23 °C
Safety temperature	- 2 °C	- 7 °C	- 13 °C	- 21 °C

Check that the circulator pumps are not blocked. In fact, their motor shaft may seize up, especially after long shutdowns. Unblocking can be accomplished with a screwdriver using the purge hole.

### ELECTRICAL SYSTEM

Check the proper tightening of the screws that fix the conductors to the electrical components in the board (during handling and transportation, the vibrations could have loosened them).

Verify that the unit is connected to the ground plant.

Control that all panels and protection devices of the unit are repositioned and blocked.

Charge the unit by closing the sectioning device, but leave it on OFF.

Make sure that the tension and net frequency values are within the limit of:

230 +/- 10% single phase unit; 400/3/50 +/- 10% three-phase unit

Control the unbalancing of the phases: it must be lower than 2% .

Example:

L1 - L2 = 388 V, L2 - L3 = 379 V, L3 - L1 = 377 V

average of the measured values =  $(388 + 379 + 377) / 3 = 381$

maximum deviation from the average =  $388 - 381 = 7V$

Unbalancing =  $(7/381) \times 100 = 1.83\% = \text{ACCEPTABLE}$

Operating out of the indicated limits causes the loss of the guarantee as well as very serious damages.

### IF THE CRANKCASE RESISTANCES ARE FITTED

when the unit is started up for the first time and following all prolonged periods of inactivity is OBLIGATORY to connect the oil resistances on the compressor crankcase at least 8 hours before the compressor is to be started.

BEFORE POWERING THE RESISTANCES, OPEN THE COMPRESSORS COCKS, IF PRESENT.

To supply the resistances is necessary to switch off the isolator switch on the unit.

To make sure that the resistances are working, check the power input with amperometric pliers.

At start-up the compressor crankcase temperature on the lower side must be higher at least of 10°C than the outside temperature.

DO NOT START THE COMPRESSOR WITH THE CRANKCASE OIL BELOW OPERATING TEMPERATURE.

### VERIFY TENSIONS – ABSORPTIONS

Check that the temperatures of the fluids are included in the WORKING LIMITS.

If the controls of the previous paragraphs are positive, it is possible to restart the unit.

For information on the control panel, refer to the paragraph CONTROL.

While the unit is working (ATTENTION ELECTRIC RISK: WORK SAFELY) check:

- Power supply tension
- Phase unbalance
- Total absorption of the unit
- Absorption of the single electric loads

### UNIT EQUIPPED WITH SCROLL COMPRESSORS

The GENERAL TECHNICAL DATA table shows the type of compressor on the unit.

The Scroll compressors have only one direction of rotation.

In the event that the direction is reversed, the compressor will not be damaged, but its noisiness will increase and pumping will be negatively affected. After a few minutes, the compressor will stop because of the activation of the

thermal protection. In this event, cut the power and reverse the 2 phases on the machine power.

Prevent the compressor from working with in reverse rotation: more than 2-3 anomalous starts up can damage it.

Make sure the direction of rotation is correct, measure the condensation and suction pressure. Pressure must clearly differ: at the start, the suction pressure decreases whilst the condensation pressure increases.

The phase optional monitor, which controls the phase sequence, can be installed later.

## REMOTE INPUT CONFIGURATIONS

Check used remote inputs are activated (ON-OFF etc.) as given in the instructions in the ELECTRIC WIRING chapter.

## SETTING THE SET-POINT

Check if it is necessary to modify the set-points shown in the CONTROL chapter

## EVAPORATOR WATER FLOW RATE

Check that the difference between the temperature of exchanger return and supply water corresponds to power according to this formula:

$$\text{unit cooling power (kW)} \times 860 = \text{Dt (}^{\circ}\text{C)} \times \text{flow rate (L/h)}.$$

The cooling power is shown in the TABLE ON GENERAL TECHNICAL DATA included in this manual, referred to specific air/water conditions, or in the tables on cooling PERFORMANCE IN THE TECHNICAL BULLETIN referred to various conditions of use.

Check for water side exchanger pressure drops:

- Determine the water flow rate.
- Measure the difference in pressure between exchanger input and output and compare it with the graph on WATER SIDE EXCHANGER PRESSURE DROPS.

The measurement of pressure will be easier if pressure gauges are installed as indicated in the DIAGRAM OF SUGGESTED WATER CONNECTIONS .

## REFRIGERANT CIRCUIT PARAMETER CHECK

Detecting the operational conditions is useful to control the unit along time: the performed records must be kept and be available during maintenance interventions.

When the unit works in stable conditions and according to the operating limits, take note of the following data:

1. compressor discharge temperature (WARNING – BURN DANGERI)
2. condensing pressure
3. liquid temperature
4. dehydrator filter upstream and downstream temperature
5. return pressure
6. return temperature
7. exchanger input water temperature
8. exchanger output water temperature
9. return air temperature
10. supply air temperature

## BYPASS VALVE CALIBRATION

The by-pass valve ensures a flow recirculation proportional to the number valves being closet, while restricting the maximum differential pressure value generated by the pump.

Rapid regulation of the by-pass valve :  
the system must be operating, the regulating valves must be fully open and the by-pass valve must be set to its maximum value

Fully close approximately the 30% of the total number of the thermostatic valves

Gradually open the valve using the control knob.





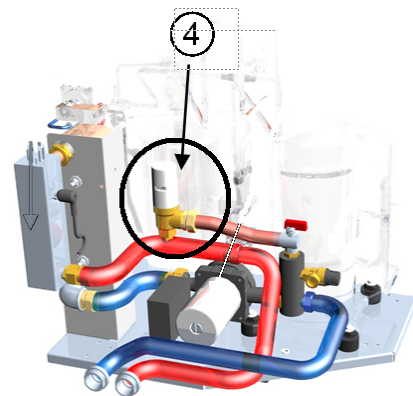

Use a thermometer, or simply your hand, to check that the hot water is flowing into the by-pass circuit.

As soon as a rise in the temperature is noted, open the thermostatic valves again and check that the hot water stops flowing into the by-pass.

Secure the knob in this position with the fixing screw.





## CONTROL

		HEAT / COOL – EXIT (previous menu)
		ALARMS / AHEAD fast menu
		STATA / BACK fast menu
		ON / OFF – MAIN MENU
		ENTER : access to menu
		AHEAD BACK slow

**switch on / switch off** : the unit

**comfort / economic** : choose between max. comfort or min. consumptions

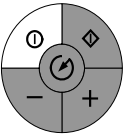
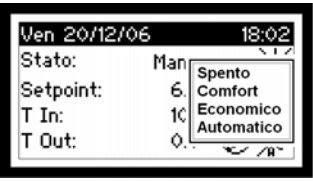
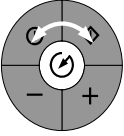
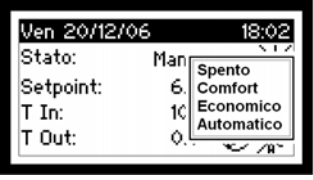
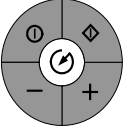





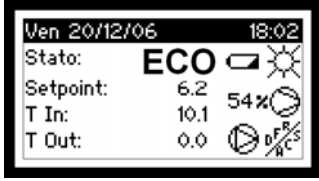

**automatic** : daily/weekly scheduling

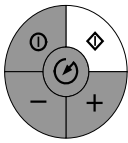
<p><b>1</b></p> <p>Press the button 1...2...3...4 sec</p>		
<p><b>2</b></p> <p>Rotate the button to scroll the menu</p>		
<p><b>3</b></p> <p>Press the button To confirm the choice</p>		

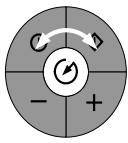
4 It appears the new chosen status ( ECO )

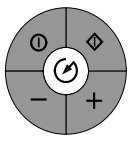

**COOL / HEAT / produce DOMESTIC HOT WATER**

<p>1 Press the button</p>		
<p>2 Rotate the button to scroll the menu</p>		
<p>3 Press the button to confirm the choice</p>		
<p>4 It appears the symbol of the new choice</p>	<p>  Cooling   Heating   Domestic hot water production         </p>	

**TO MODIFY THE SET  
( COOLING – HEATING )**

1

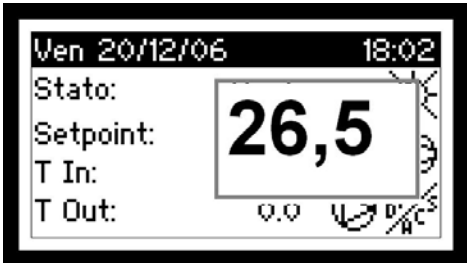

**UNIT KEYPAD mode**

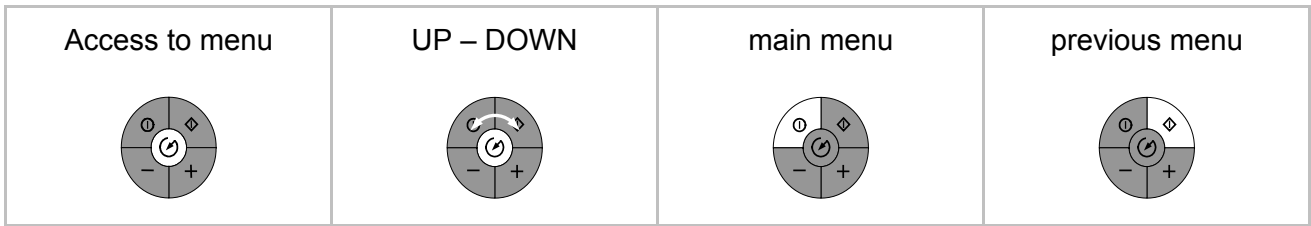

<ul style="list-style-type: none"> <li>main menu</li> </ul>	<ul style="list-style-type: none"> <li><b>stata</b></li> <li>base FW version</li> <li>keypad FW version</li> <li>unit stata</li> <li>stata I/O</li> </ul>	<ul style="list-style-type: none"> <li>digital inputs</li> <li>analogical inputs</li> <li>digital outputs</li> <li>analogical outputs</li> </ul>
<ul style="list-style-type: none"> <li><b>alarms</b></li> </ul>	<ul style="list-style-type: none"> <li>active alarms</li> <li>alarm log</li> <li>alarm reset</li> <li>log reset</li> </ul>	
<ul style="list-style-type: none"> <li><b>configuration</b></li> </ul>	<ul style="list-style-type: none"> <li>keypad</li> <li>unit</li> <li>system variables</li> </ul>	<ul style="list-style-type: none"> <li>setup</li> <li>setpoint</li> <li>language</li> <li>all</li> <li>configuration</li> <li>setpoint</li> <li>demand limit</li> <li>pump 1 hours</li> </ul>
<ul style="list-style-type: none"> <li><b>date and hour</b></li> <li><b>password</b></li> </ul>		

to go to the CHRONOTHERMOSTAT – SYSTEM MANAGER mode

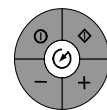

1 2 3 4 sec

**CHRONOTHERMOSTAT – SYSTEM MANAGER mode**

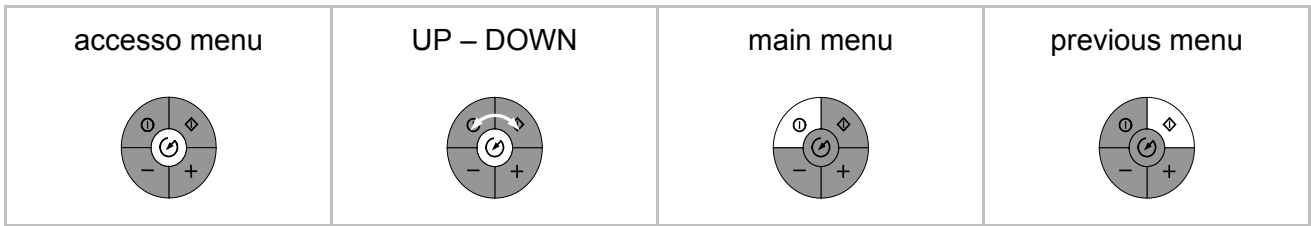

main menu	<b>stata</b>	keypad FW version	
		unit stata	heat pump
			ACS module
			terminals
	<b>alarms</b>	heat pump	
		ACS module	
		terminals	
	<b>configuration</b>	keypad	setup
			setpoint
			language
		zones	
		sanitary	setup
			antilegionella
		system	unit list
			autoconfiguration
	<b>scheduling</b>	zones	weekly
			zone .....
			zone .....
			programs
			program ....
			program ....
			name modification
		sanitary	weekly
			programs
			name modification
	<b>date and hour</b>		
	<b>password</b>		

## IN CASE OF ALARM

The ALARMS indicates a potentially dangerous situation for the unit integrity.  
 Before resetting the alarm, identify and remove the lockout cause.  
 Resetting more than once can cause irreversible damages .  
 In case of doubt please contact an authorized service centre.

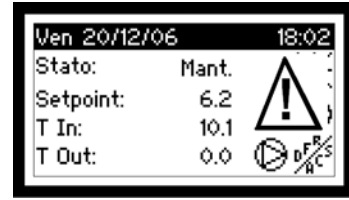

1 Press to see the alarm

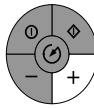

### Active alarms

XXX  
 Alarm description  
 Date xxxxxx  
 Hour xxxxxxxxxxxx

Or

Press to access to the MAIN menu

1 then

rotate to choose the ALARM menu

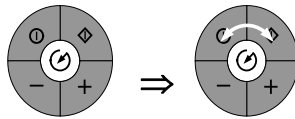

### MAIN MENU

Stato

## ALARMS

Configuration  
 Date and hour  
 ...

Press to access to the ALARM menu

2 then

rotate to choose the desired menu

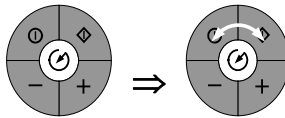

### ALARM MENU

Active alarms  
 Alarm log  
 Alarm reset  
 Log reset

3

Press to go back to the previous menu

or...

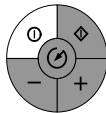

### ALARM MENU

Active alarms  
 Alarm log  
 Alarm reset  
 Log reset

4 Press to go back to the main panel

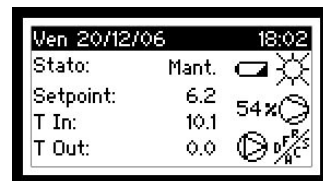
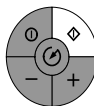

## LIST OF ALARMS

num	Description	Electrical Refrigerant Hydraulic	Reset Manual Automatic	Alarm Prealarm
E 00	Base keypad Timeout	E/R/H	A	A
E 01	Input temp. probe utility side	E	A	A
E 02	Supply temp. probe utility side	E	A	A
E 03	Outside temp. probe	E	A	A
E 04	Coil/output temp. probe source	E	A	A
E 05	Return temp. probe source side	E	A	A
E 06	Temp. probe in accumulation	E	A	A
E 07	AUX. heater temp. probe (utility side)	E	A	A
E 08	Pressure 1 probe (HP)	E	A	A
E 09	Pressure 2 probe (LP)	E	A	A
E 10	Ext. RH% probe	E	A	A
E 11	Water Reset input	E	A	A
E 12	Demand Limit input	E	A	A
E 13	Phase monitor	E	A	A
F 01	High pressure (HP)	R	A/M	A
F 02	Low pressure (LP)	R	A/M	A
F 03	Compressor 1 overload	R	M	A
F 04	Compressor 2 overload	R	M	A
F 05	Prealarm HP1	R	A	P
F 06	Prealarm LP1	R	A	P
F 07	Fan overload	R	M	A
f/F 08	Prealarm HP2	R	A/M	P/A
f/F 09	Prealarm LP2	R	A/M	P/A
f/F 10	Max pressure ratio	R	A/M	P/A
f/F 11	Defrosting forcing for low pressure	R	A/M	P/A
I 01	Utility pump flow	H	A/M	A
I 02	Source pump flow	H	A/M	A
I 03	Pump 1 overload (utility side)	H	M	A
I 04	Pump 2 overload (utility side)	H	M	A
I 05	Frost alarm (utility)	H	M	A
I 06	Frost alarm source side	H	M	A
I 07	AUX heater antifreeze	H	M	A
I 08	Water charge system (utility)	H	M	A
I 09	Incongruent T Delta	H	M	A
I 10	Thermal alarm on all pumps (utility side)	H	M	A
I 11	Antifreeze prealarm (utility)	H	A	P
I 12	Pump change (utility)	H	A	P
I 13	User input water temperature out of limit of the current operating mode	H	A	P
I 14	Dom. hot water incongruent thermostat	H	A	P

**CHECK THE STATA  
( water and air temperatures, etc )**

1 Press to access to the STATA menu  
than rotate to scroll .  
The complete stata list is at the following page

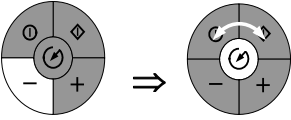

**STATA**

S1 xxxx  
S2 XXXX  
S3  
S4  
S5

2 Press to go back to the main panel

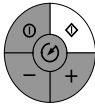

Wen 20/12/06 18:02

Stato: Mant. 

Setpoint: 6.2 54% 

T In: 10.1 

T Out: 0.0 

Or :

1 Press to access to the MAIN menu  
than rotate to choose the STATA menu

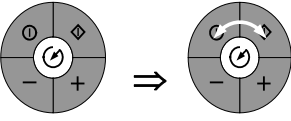

**MAIN MENU**

---

**STATA**

---

Alarms  
Configuration  
Date and hour  
Password

2 Press to access to the STATA menu  
than rotate to choose the desired menu

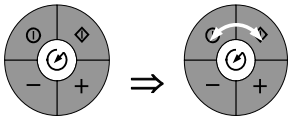

**STATA MENU**

BASE FW version  
KEYPAD FW version  
Unit stata  
Unit I / O

3 Press to access to the desired menu  
Than Rotate to choose the following menu

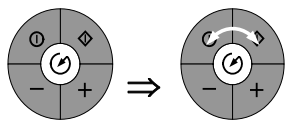

**UNIT I/O**

DIGITAL INPUTS  
ANALOGICAL INPUTS  
DIGITAL OUTPUTS  
ANALOGICAL OUTPUTS

4 Press to go back to the previous menu

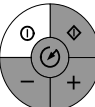

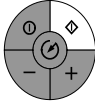

5 Or Press to go back to the main panel



Wen 20/12/06 18:02

Stato: Mant. 

Setpoint: 6.2 54% 

T In: 10.1 

T Out: 0.0 

## UNIT STATA

Num. status	DESCRIPTION	UM
1	Current Set point	°C
2	Current step difference (with compensations)	°C
3	Resource insertion timer	Seconds
4	Dynamic TimeScan of the resource insertion	Seconds
5	Outside T compensation	°C
6	Ambient T compensation	°C
7	WR compensation	°C
8	Charge compensation	°C
9	Duty Cycle compensation	°C
10	Compensation on duration	°C
11	Water input temperature	°C
12	Water output temperature	°C
13	Aux. heater output temperature	°C
14	Fresh air temperature	°C
15	Condensing coil temperature	°C
16	Storage temperature	°C
17	Utility 1 pump	
18	Utility 2 pump	
19	Utility pump (0-10V)	%
20	Secondary pump	
21	Ventilation ON-OFF	
22	Ventilation (0-10V)	%
23	Condensing pressure	Bar
24	Evaporating pressure	Bar
25	Aux. heater	
26	Aux. heater (0-10V)	%
27	Boiler control	
28	Boiler valve control	
29	Relative humidity	%
30	Source valve or Free cooling	
31	Compressor at variable speed (0-10V)	%
32	Compressor 1 operating hours	
33	Compressor 1 starts	
34	Compressor 2 operating hours	
35	Compressor 2 starts	
36	Base FW	
37	Keypad FW	

## ROUTINE MAINTENANCE

BEFORE UNDERTAKING ANY SORT OF MAINTENANCE OR CLEANING, DISCONNECT THE ELECTRICAL POWER SUPPLY TO THE UNIT, AND ENSURE THAT OTHER PEOPLE CANNOT RE-CONNECT IT .

All equipment is subjected to wear out.

The maintenance makes :

1. keeps the unit efficiency
  2. the components last longer
  3. keeps their efficiency and limits breakdowns
- Therefore, it is fundamental to perform periodical checks: a few controls can be performed by the user (AUTONOMOUS MAINTENANCE) and they are mainly cleaning activities; otherwise, controls have to be performed by specialized technicians (INSPECTIONS).

The machine should have a log book used to keep track of the performed controls. This will make fixing up breakdowns easier.

Take note of the date, type of control (autonomous maintenance, inspection or fixing up), description of the control, actions taken and so on.

## SERVICES : parts subject to intervention

- CONDENSATE DISCHARGE
- FRESH AIR COIL
- ELECTRIC FANS
- WATER CONDENSER
- STRUCTURE

### STRUCTURE

Check the condition of the parts making up the structure. Paint so as to eliminate or reduce oxidation at the points in the unit where this problem may occur. Check that the panelling is fastened correctly. Poor fastening may give rise to malfunctions and abnormal noise and vibration.

### FRESH AIR COIL

ATTENTION: contact with the exchanger fins can cause cuts. Wear protective gloves to perform the above described operations.

It is extremely important that the battery gives the maximum thermal exchange; therefore, its surface must be cleaned from dust and deposits. Remove all impurities from the surface.

Using an air pressure gun, clean the aluminum surface of the battery. Be careful to direct the air in the opposite direction of the fan air movement. Hold the gun parallel to the fins to avoid damages. As an alternative, an aspirator can be used to suck impurities from the air input side.

Verify that the aluminum fins are not bent or damaged. In the event of damages, contact the authorized assistance center and get the battery "ironed out" in order to restore the initial condition for an optimal air flow.

### ELECTRIC FANS

Make sure that the fans and the relative protection grids are well fixed.

Check, if possible, the unbalances of the electro-fan evident by noise and anomalous vibrations. Verify that the terminal protection covers are closed and the cable holders are properly positioned.

### CONDENSATE DISCHARGE

Dust and deposits could cause obstructions. Clean the tank, pour some water into the tank and check water flows normally.

### WATER EXCHANGER

It is very important for the exchanger to be able to provide the maximum thermal exchange. Therefore, it is essential for the inner surfaces to be clean of dirt and incrustations.

Periodically check the difference between the temperature of the supply water and the condensation temperature. If the difference is greater than 8 °C – 10 °C it is advisable to clean the exchanger.

### RETURN GRILLE

Periodically check that the grille (3) is not clogged up with dirt, leaves, etc.

- 1) condensate discharge on internal tray
- 2) condensate discharge carried to the outside
- 3) Return grille



## MAINTENANCE INSPECTIONS

Foresee inspection assistance carried out by authorized centers or by qualified personnel.

The inspections should be carried out at least:

- - Every year for only the cooling units
- - Every six months for the cooling and warming units

The frequency, however, depends on the use: in the event of frequent use (continuous or very intermittent use, near the operating limits, etc) or critical use (service necessary) it is recommended to plan inspections at close intervals.

For units equipped with safety valves, follow the Manufacturer's instructions.

Verify periodically the cleaning of the safety valves and that oxidative / corrosive phenomena are not present, in particular for installations near the sea, in industrial areas or in rooms with a corrosive atmosphere.

The inspections to be performed are as follows:

- verify the power supply tension (when emptied or filled)
- inspect the electrical board (status of solenoid starter contacts, terminal closings, the status of wiring and relevant insulations)
- inspect the absorption of the single electrical loads
- verify the cleaning and the efficiency of the exchangers
- inspect the cleaning of the filters (air/water)
- verify the leakage from the refrigerating circuit
- Verify the protection devices (safety valves, pressure switches, thermostats, etc.), the adjustment systems, the control devices (alarm signalizations, probes, manometers, etc)
- check the operating parameters of the refrigerating circuit (see the following REFRIGERANT TABLES and the START-UP section)

## 97/23 CE PED DIRECTIVE

97/23 CE PED DIRECTIVE gives instructions for installers, users and maintenance technicians as well. Refer to local actuation norms.

In Italy, refer to the Ministerial Decree of 1<sup>st</sup> December 2004 no. 329 (and following modifications) which defines the performances to be executed; the units of 1<sup>st</sup> category and those defined by the art. 3.3 97/23/EC are not included in this regulation (see the serial number plate on the unit) .

Briefly and as an example, see the following :

1. COMPULSORY VERIFICATION OF THE FIRST INSTALLATION only for units assembled on the installer's building site (for ex. Condensing circuit + direct expansion unit)
2. CERTIFICATION OF SETTING IN SERVICE for all the units
1. PERIODICAL VERIFICATIONS to be executed with the frequency indicated by the Manufacturer (see the MAINTENANCE INSPECTIONS paragraph)

## PUT AT REST

If a long period of inactivity is foreseen, for example the winter for the cooling unit, the following is recommended:

- to turn the power off in order to avoid electrical risks or damages by lightning strike
- to avoid the risk of frosts as shown in the HYDRAULIC CONNECTIONS section, and, in particular
  - to empty or add glycol in the plant sections subjected to temperatures below zero
  - to empty or add glycol in the water heating coils, also in summer
  - to power antifreeze resistances if present

If the period of inactivity is particularly long or in the event of extremely low temperatures, the external fans can be blocked temporarily; therefore, it is recommended to switch them on every month in order to avoid seizures or electrical overloads when the unit will be switched on.

The restarting of the unit has to be carried out by qualified personnel, in particular, after the winter break for cooling units or when seasonal switching should be performed.

When restarting, refer to the SWITCHING ON section.

Schedule technical assistance in advance to avoid hitches and be able to use the installation when necessary.



## REFRIGERANT TABLES

THIS SECTION IS DEVOTED ONLY TO QUALIFIED TECHNICIANS THAT KNOW THE FOLLOWING:

- THE OPERATIONAL PRINCIPLES OF THE REFRIGERATING CIRCUIT OPERATION
- THE MODES OF DETECTING TEMPERATURE AND PRESSURE
- THE RISKS RELEVANT TO THESE OPERATIONS

The data of the tables allow the testing of the refrigerating circuit operation by the detection of a few objective parameters. The data are significant if they are detected simultaneously and while the refrigerating circuit is running.

<b>OVERHEATING = return temperature – Saturation temperature</b>	
	<b>R407C</b>
Return pressure	3.8 bar
Return temperature	7.3 °C
overheating	7.3–1.18 = <b>6.12 °C</b> for calculation consider the Td ( dew point )
<b>SUBCOOLING = condensing temperature (pressure *) – liquid temperature</b>	
<b>R407C</b>	
Condensing pressure	18.6 bar
Liquid temp.	42.9 °C
subcooling	44.74 – 42.9 = <b>1.84 °C</b> for calculation consider the Tb ( bubble point )

- It is important that the condensation pressure is detected as close as possible to the point where the liquid temperature is detected, in the event that the calculation will be effected by the losses of charge (and, therefore, of temperature) caused by the refrigerating circuit components placed between the two measurement points.

The values in the tables refer to a specific refrigerant supplier; slight differences are possible with other suppliers

Pg = P gauge = relevant pressure (read on the pressure gauge)

Td = dew point temperature

Tb = bubble point temperature

Pg	R407C Td [°C]	Tb [°C]	Pg	R407C Td [°C]	Tb [°C]	Pg	R407C Td [°C]	Tb [°C]	Pg	R407C Td [°C]	Tb [°C]
0.0	-36.90	-43.90	11.0	30.73	25.30	22.0	56.00	51.63	33.0	72.94	69.73
0.2	-33.11	-40.05	11.2	31.32	25.92	22.2	56.36	52.01	33.2	73.21	70.02
0.4	-29.80	-36.67	11.4	31.91	26.52	22.4	56.72	52.39	33.4	73.47	70.30
0.6	-26.83	-33.65	11.6	32.49	27.12	22.6	57.08	52.77	33.6	73.72	70.58
0.8	-24.15	-30.92	11.8	33.07	27.72	22.8	57.43	53.14	33.8	73.98	70.87
1.0	-21.69	-28.41	12.0	33.63	28.30	23.0	57.79	53.51	34.0	74.24	71.15
1.2	-19.41	-26.09	12.2	34.19	28.88	23.2	58.14	53.88	34.2	74.49	71.43
1.4	-17.29	-23.93	12.4	34.75	29.46	23.4	58.48	54.25	34.4	74.75	71.70
1.6	-15.31	-21.90	12.6	35.30	30.03	23.6	58.83	54.62	34.6	75.00	71.98
1.8	-13.44	-19.99	12.8	35.84	30.59	23.8	59.17	54.98	34.8	75.25	72.26
2.0	-11.66	-18.19	13.0	36.37	31.14	24.0	59.51	55.34	35.0	75.50	72.53
2.2	-9.98	-16.47	13.2	36.90	31.69	24.2	59.85	55.70	35.2	75.75	72.81
2.4	-8.38	-14.83	13.4	37.43	32.23	24.4	60.19	56.05	35.4	75.99	73.08
2.6	-6.85	-13.27	13.6	37.95	32.77	24.6	60.53	56.41	35.6	76.24	73.35
2.8	-5.38	-11.77	13.8	38.46	33.31	24.8	60.86	56.76	35.8	76.48	73.62
3.0	-3.97	-10.33	14.0	38.97	33.83	25.0	61.19	57.11	36.0	76.73	73.89
3.2	-2.61	-8.94	14.2	39.47	34.35	25.2	61.52	57.46	36.2	76.97	74.16
3.4	-1.31	-7.61	14.4	39.97	34.87	25.4	61.84	57.81	36.4	77.21	74.43
3.6	-0.04	-6.31	14.6	40.46	35.38	25.6	62.17	58.15	36.6	77.45	74.69
<b>3.8</b>	<b>1.18</b>	-5.06	14.8	40.95	35.89	25.8	62.49	58.49	36.8	77.69	74.96
4.0	2.36	-3.85	15.0	41.43	36.39	26.0	62.81	58.83	37.0	77.92	75.22
4.2	3.51	-2.68	15.2	41.91	36.89	26.2	63.13	59.17	37.2	78.16	75.49
4.4	4.62	-1.54	15.4	42.39	37.39	26.4	63.45	59.51	37.4	78.39	75.75
4.6	5.71	-0.43	15.6	42.86	37.87	26.6	63.76	59.85	37.6	78.62	76.01
4.8	6.76	0.65	15.8	43.32	38.36	26.8	64.07	60.18	37.8	78.86	76.27
5.0	7.79	1.70	16.0	43.78	38.84	27.0	64.38	60.51	38.0	79.09	76.53
5.2	8.79	2.73	16.2	44.24	39.32	27.2	64.69	60.84	38.2	79.31	76.79
5.4	9.77	3.73	16.4	44.69	39.79	27.4	65.00	61.17	38.4	79.54	77.05
5.6	10.72	4.71	16.6	45.14	40.26	27.6	65.31	61.50	38.6	79.77	77.31
5.8	11.65	5.67	16.8	45.59	40.72	27.8	65.61	61.82	38.8	79.99	77.56
6.0	12.56	6.60	17.0	46.03	41.18	28.0	65.91	62.14	39.0	80.22	77.82
6.2	13.46	7.52	17.2	46.47	41.64	28.2	66.21	62.46	39.2	80.44	78.07
6.4	14.33	8.41	17.4	46.90	42.09	28.4	66.51	62.78	39.4	80.66	78.33
6.6	15.18	9.29	17.6	47.33	42.54	28.6	66.81	63.10	39.6	80.88	78.58
6.8	16.02	10.15	17.8	47.76	42.99	28.8	67.10	63.42	39.8	81.10	78.83
7.0	16.85	11.00	18.0	48.18	43.43	29.0	67.40	63.73	40.0	81.31	79.08
7.2	17.65	11.83	18.2	48.60	43.87	29.2	67.69	64.05	40.2	81.53	79.33
7.4	18.45	12.64	18.4	49.02	44.30	29.4	67.98	64.36	40.4	81.74	79.58
7.6	19.22	13.44	<b>18.6</b>	49.43	<b>44.74</b>	<b>29.6</b>	68.27	64.67	40.6	81.95	79.83
7.8	19.99	14.23	18.8	49.84	45.16	29.8	68.56	64.98	40.8	82.16	80.08
8.0	20.74	15.00	19.0	50.25	45.59	30.0	68.84	65.29	41.0	82.37	80.33
8.2	21.48	15.76	19.2	50.65	46.01	30.2	69.13	65.59	41.2	82.58	80.57
8.4	22.20	16.51	19.4	51.05	46.43	30.4	69.41	65.90	41.4	82.79	80.82
8.6	22.92	17.25	19.6	51.45	46.85	30.6	69.69	66.20	41.6	82.99	81.06
8.8	23.62	17.97	19.8	51.85	47.26	30.8	69.97	66.50	41.8	83.19	81.31
9.0	24.32	18.69	20.0	52.24	47.67	31.0	70.25	66.80	42.0	83.40	81.55
9.2	25.00	19.39	20.2	52.63	48.08	31.2	70.52	67.10	42.2	83.60	81.80
9.4	25.67	20.08	20.4	53.01	48.49	31.4	70.80	67.40	42.4	-	-
9.6	26.34	20.77	20.6	53.39	48.89	31.6	71.07	67.69	42.6	-	-
9.8	26.99	21.44	20.8	53.77	49.29	31.8	71.34	67.99	42.8	-	-
10.0	27.63	22.11	21.0	54.15	49.69	32.0	71.61	68.28	43.0	-	-
10.2	28.27	22.76	21.2	54.53	50.08	32.2	71.88	68.57	43.2	-	-
10.4	28.90	23.41	21.4	54.90	50.47	32.4	72.15	68.87	43.4	-	-
10.6	29.51	24.05	21.6	55.27	50.86	32.6	72.42	69.15	43.6	-	-
10.8	30.13	24.68	21.8	55.64	51.25	32.8	72.68	69.44	43.8	-	-

# TROUBLESHOOTING

**THE OPERATIONS MUST BE CARRIED OUT BY TECHNICAL QUALIFIED PERSONNEL HAVING THE REQUISITES UNDER LAW REQUISITES AND IN CONFORMITY WITH THE SAFETY REGULATIONS IN FORCE.**

**THE INTERVENTIONS WITHIN THE WARRANTY PERIOD WILL BE CARRIED OUT BY AUTHORIZED SERVICE CENTERS.**

**BEFORE RESETTING AN ALARM, IDENTIFY AND ELIMINATE ITS CAUSE.  
REPEATED RESETS MAY CAUSE SERIOUS DAMAGES.**

In certain machine configurations, some safeties may be placed in series and lead back to a single input on the electronic module.

Therefore, check on the electrical diagram whether the device to which the alarm corresponds has other devices or safeties connected in series.

Below is a list of the possible causes of alarms.

## **HIGH PRESSURE** (in cooling)

1. high water temperature (see operating limits)
2. high air temperature (see operating limits)
3. coil dirty / clogged
4. fans don't work / low speed
5. Manostat/transducer: loose electric contacts/terminals, wiring cables interrupted
6. Anti-condensation gas in the cooling circuit
7. Too much refrigerant
8. Check the trigger point for the manostat and transducer
9. Check the manostat or transducer pressure control point (deposits of oil, dirt, pin blocked mechanically)

## **LOW PRESSURE** (in cooling)

1. low air temperature (see operating limits)
2. low water temperature (see operating limits)
3. insufficient water flow to the exchanger (high thermal difference between input and output)
4. not CONSTANT flow (for example, if the pumps are turned off, certain areas of the plant are excluded or included, other uses are isolated, etc )
5. Water filter clean / valves open /air bubbles in the plant
6. dirty exchanger
7. Manostat/transducer: loose electric contacts/terminals, wiring cables interrupted
8. refrigerant circuit empty, visible leaks of refrigerant/oil, insufficient charge
9. Blocked dehydrator filter
10. thermostatic device not operating correctly
11. Check the trigger point for the manostat and transducer
12. Check the manostat or transducer pressure control point (deposits of oil, dirt, pin blocked mechanically)

## **FAULTY PROBE**

1. Identify the part on the wiring diagram.
2. Loose electric contacts/terminals, leads broken
3. Check the correct probe ohmic level (using a tester)
4. Change the probe.
5. Check the electronic module configuration (only an authorised service centre can do this)
6. Change the electronic module

## **FAULTY PRESSURE TRANSDUCER**

1. Identify the part on the wiring diagram
2. Loose electric contacts/terminals, leads broken
3. Check the pressure test points are in working order
4. Change the part
5. Check the electronic module configuration (only an authorised service centre can do this)
6. Change the electronic module

### COMPRESSOR PROTECTION

1. Identify the part on the wiring diagram
2. Loose electric contacts/terminals, leads broken
3. electrical windings interrupted
4. Vacuum power voltage below the limits
5. power contactors / contacts defective
6. start-up power voltage lower than the limits
7. electrical absorption high / unbalanced
8. High compressor discharge temperature > thermostatic device needs calibrating, insufficient refrigerant charge

### HIGH PRESSURE (in heating)

1. high air temperature (see operating limits)
2. high water temperature (see operating limits)
3. insufficient water flow to the exchanger (high thermal difference between input and output)
4. not CONSTANT flow (for example, if the pumps are turned off, certain areas of the plant are excluded or included, other uses are isolated, etc )
5. Water filter clean / valves open /air bubbles in the plant
6. dirty exchanger
7. Manostat/transducer: loose electric contacts/terminals, wiring cables interrupted
8. condensation gas in the cooling circuit
9. Too much refrigerant
10. Check the trigger point for the manostat and transducer
11. Check the manostat or transducer pressure control point (deposits of oil, dirt, pin blocked mechanically)

### FAN PROTECTION

1. Identify the part on the wiring diagram
2. fan mechanically jammed, bearings / drive belt (if present)
3. Loose electric contacts/terminals, leads broken
4. electrical windings of fan interrupted
5. power supply voltage below limits
6. electrical absorption high / unbalanced

### PUMP PROTECTION

1. Identify the part on the wiring diagram
2. pump jammed (probable for circulator pump after lengthy seasonal shutdowns)
3. Loose electric contacts/terminals, leads broken
4. electrical windings of fan interrupted
5. power supply voltage below limits
6. electrical absorption high / unbalanced

### LOW PRESSURE (in heating)

1. low water temperature (see operating limits)
2. low air temperature (see operating limits)
3. coil dirty / clogged
4. fans don't work / low speed
5. Manostat/transducer: loose electric contacts/terminals, wiring cables interrupted
6. Check the trigger point for the manostat and transducer
7. refrigerant circuit pressurized? visible refrigerant leakage? correct charge?
8. Blocked dehydrator filter ?
9. thermostatic device not operating correctly?
10. Check the manostat or transducer pressure control point (deposits of oil, dirt, pin blocked mechanically)

## DECOMMISSIONING OF THE UNIT

### DISCONNECTING THE UNIT

The units must be disconnected by authorised personnel, who before proceeding must first read the Residual Risks section in this manual.

Before disconnecting the unit, the following must be recovered, if present:

- the refrigerant (if the circuits cannot be isolated): the refrigerant must be removed using suction devices operating in a closed circuit, so as to ensure that none of the compound is released into the atmosphere.
- the antifreeze in the circuits: when removing this fluid, make sure that it does not leak and that it is not released into the environment. The antifreeze fluid must be stored in special containers.

When recovering the substances present in the unit, all measures must be taken to avoid damaging persons and things and polluting the surrounding area.

Awaiting dismantling and disposal, the unit can also be stored outdoors, as bad weather and rapid changes in temperature will not cause damage to the environment, if electric, cooling and hydraulic circuits of the unit are integral and closed.

### DISMANTLING AND DISPOSAL

THE UNIT MUST ALWAYS BE SENT TO AUTHORISED CENTRES FOR DISMANTLING AND DISPOSAL.

When dismantling the unit, the fan, the motor and the coil, if operating, may be recovered by the specialist centres for reuse.

All the materials must be recovered or disposed of in compliance with the corresponding national standards in force.

For further information on the decommissioning of the unit, contact the manufacturer.

# TECHNICAL DATA

## TECHNICAL DATA BASE CONFIGURATION

Sizes			21	25	31	41	51	61	81	
<b>400/3/50+N</b>										
<b>Heating</b>			<b>A7(6)W30/35</b>							
Heat capacity	1	KW	6.13	8.16	10.0	11.2	14.0	17.7	22.9	
Total absorbed capacity	1	kW	1.57	2.05	2.51	2.87	3.55	4.42	5.87	
COP EUROVENT	4		3.95	4.03	4.03	3.96	4.00	4.06	3.96	
COP EN14511			3.91	3.98	3.98	3.90	3.94	4.01	3.90	
<b>Heating</b>			<b>A2(1)W30/35</b>							
Heat capacity	2	KW	4.81	6.49	7.83	8.80	11.1	13.9	18.1	
Total absorbed capacity	2	kW	1.49	1.92	2.35	2.72	3.33	4.11	5.48	
COP EN14511			3.24	3.38	3.33	3.24	3.34	3.38	3.31	
<b>Cooling</b>			<b>A35W23/18</b>							
Cooling capacity	3	KW	6.44	8.50	10.7	11.9	14.5	18.1	22.4	
Total absorbed capacity	3	kW	2.26	2.99	3.81	4.46	5.61	6.26	8.07	
EER EUROVENT	4		2.88	2.87	2.83	2.68	2.61	2.92	2.81	
ESEER	5		2.62	2.62	2.71	2.57	2.46	2.74	2.51	
<b>230/1/50</b>										
<b>Heating</b>			<b>A7(6)W30/35</b>							
Heat capacity	1	KW	6.22	7.91	10.2	11.3	-	-	-	
Total absorbed capacity	1	kW	1.69	2.03	2.73	3.01	-	-	-	
COP EUROVENT	4		3.72	3.94	3.78	3.80	-	-	-	
COP EN14511			3.69	3.90	3.73	3.75	-	-	-	
<b>Heating</b>			<b>A2(1)W30/35</b>							
Heat capacity	2	KW	4.92	6.25	8.01	8.91	-	-	-	
Total absorbed capacity	2	kW	1.59	1.90	2.54	2.83	-	-	-	
COP EN14511			3.10	3.29	3.15	3.14	-	-	-	
<b>Cooling</b>			<b>A35W23/18</b>							
Cooling capacity	3	KW	6.46	8.03	10.3	11.9	-	-	-	
Total absorbed capacity	3	kW	2.47	3.15	4.11	4.76	-	-	-	
EER EUROVENT	4		2.64	2.57	2.52	2.52	-	-	-	
ESEER	5		2.38	2.49	2.41	2.47	-	-	-	
<b>COMPRESSORS</b>										
Type of compressors			SCROLL							
N° of compressors			1							
Std. Capacity steps			1							
Refrigerant circuits			1							
Refrigerant charge (R-407C)	7	kg	3.1	5.8	5.8	5.8	6.2	7.5	8	
<b>INTERNAL EXCHANGER</b>										
Type of internal exchanger	8		PHE							
N° of internal exchangers			1							
Water flow-rate	1	l/s	0.29	0.39	0.48	0.54	0.67	0.85	1.09	
Exchanger pressure drop	1	kPa	18	19	20	23	23	20	25	
Water content		l	0.5	0.6	0.7	0.7	0.8	1.1	1.4	
<b>FANS</b>										
Type of fans	9		AX							
N°. of fans			1							
Std. air flow-rate		m <sup>3</sup> /h	2500	2800	3200	3400	3400	7000	8000	
<b>WATER CIRCUIT</b>										
Water side max. pressure		kPa	270				270		270	
Safety valve calibration		KPa	300				300		300	
Water fittings			1"				1 ¼"		1 ¼"	
<b>DIMENSIONS / STANDARD UNIT WEIGHTS</b>										
Length		mm	1420	1420	1420	1420	1420	1835	1835	
Depth		mm	800	800	800	800	800	1250	1250	
Height		mm	1485	1485	1485	1485	1485	1770	1770	
Unit packing volume		m <sup>3</sup>	1.12	1.12	1.12	1.12	1.12	2.46	2.46	
Casing packing volume		m <sup>3</sup>	0.57	0.57	0.57	0.57	0.57	1.48	1.48	
Unit shipping weight /panels/casing		kg	108/37/50	108/37/50	113/37/50	113/37/50	133/37/50	195/55/75	255/55/75	
Operating weight		kg	195	205	210	210	235	315	375	

All of the above data are compliant with standard EN 14511:2004 unless otherwise specified. Defrost cycles have already been taken into consideration. Performance refers to a unit operating in optimal conditions of installation with the heat exchangers perfectly clean.

- (1) data referred to the following conditions:  
internal exchanger water: 30 / 35°C  
fresh air temperature: +7°C B.S. / +6°C B.U.
- (2) data referred to the following conditions:  
internal exchanger water: 30 / 35°C  
fresh air temperature: +2°C B.S. / +1°C B.U.
- (3) data referred to the following conditions:  
internal exchanger water: 23 / 18°C  
fresh air temperature: +35°C B.S. / 50% U.R.

- (4) efficiency in accordance with EUROVENT documentation "Rating Standard for Liquid Chilling Packages" 6/C/003-2006, also considering possible defrost cycles. Total input is obtained from the compressor input and fan input.
- (5) ESEER = European Seasonal Energy Efficiency Ratio.  
Water output = 7°C
- (6) The sound pressure at 10 m from the external surface of the unit in open field conditions, in accordance with EN 3744.
- (7) indicative values  
(8) PHE = plates  
(9) AX = axials

## OPERATING LIMITS

Sizes		21	25	31	41	51	61	81
<b>COOLING</b>								
<b>EXTERNAL EXCHANGER</b>								
Input air max. temperature	1	°C		43				
<b>INTERNAL EXCHANGER</b>								
Output water max. temperature	2	°C		18				
Output water min. temperature	2	°C		4				
<b>HEATING</b>								
<b>EXTERNAL EXCHANGER</b>								
Input air max. temperature	3	°C		40				
Input air min. temperature	4	°C		-15				
<b>INTERNAL EXCHANGER</b>								
Output water min. temperature	5	°C		60				
Output water max. temperature	6	°C		23				

**ATTENTION: IN CASE OF PREDOMINANT WINDS, WINDBREAK BARRIERS ARE NECESSARY.**  
water thermal head= 5K

- (1) internal exchanger water = 12/7°C  
(2) external exchanger input air 35°C BS

- (3) data referred to still air and operation with ventilation control device (maximum outlet water temperature 52°C)  
(4) water to the internal exchanger 40/45°C  
(5) ambient temperature = 0°C BS; 88% UR  
(6) Minimum water temperature at exchanger inlet 14°C during max. 15 minutes, thanks to the variable flow rate device of the circulator.

### Unit limits in COOLING

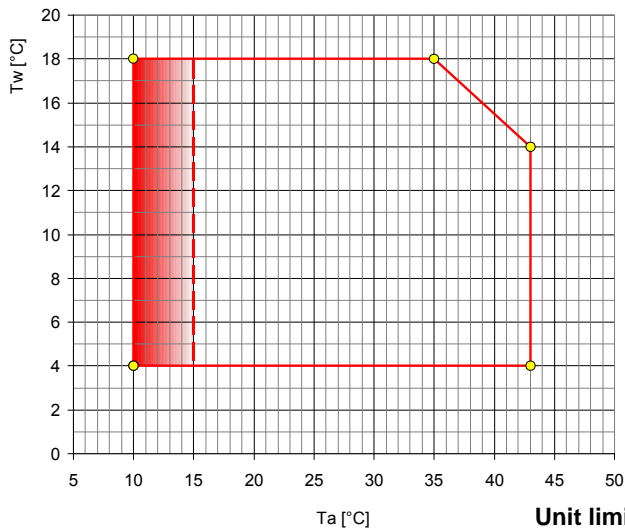

The limits are indicative and have been calculated considering:  
- values general and not specifications,  
- clean coil without frost,  
- non-critical positioning and correct use of the unit,  
- operation at full load.

- (1) The shaded area shows operation with air flow rate in modulation

$T_w$  [°C] = heat exchanger outlet water temperature  
 $T_a$  [°C] = dry bulb air temperature (R.H. = 50%)  
difference between inlet / outlet water temperature = 5°C

### Unit limits in HEATING

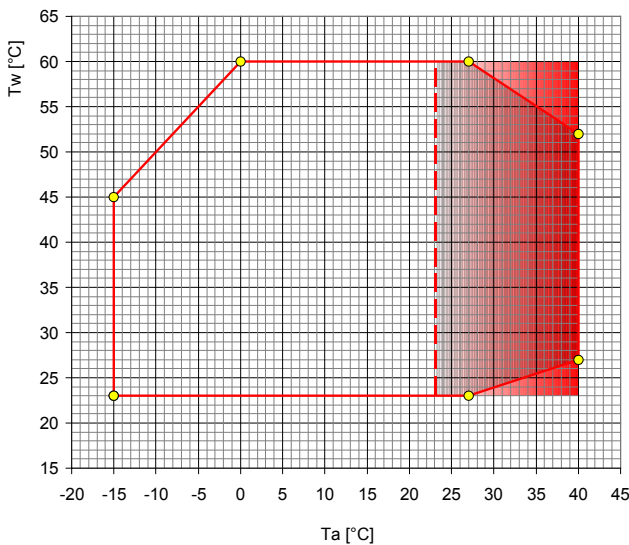

The limits are indicative and have been calculated considering:  
- values general and not specifications,  
- clean coil without frost,  
- non-critical positioning and correct use of the unit,  
- operation at full load.

- (1) The shaded area shows operation with air flow rate in modulation

$T_w$  [°C] = heat exchanger outlet water temperature  
 $T_a$  [°C] = dry bulb air temperature (R.H. = 50%)  
difference between inlet / outlet water temperature = 5°C

## SOUND LEVELS

Size	Sound Power Level (dB)								Sound pressure level	Sound power level
	Octave band (Hz)									
	63	125	250	500	1000	2000	4000	8000	dB(A)	dB(A)
<b>31</b>	76	74	63	59	57	52	42	34	<b>47</b>	63
<b>25</b>	80	76	65	61	58	54	44	36	<b>49</b>	65
<b>31</b>	83	78	68	62	61	55	45	38	<b>51</b>	67
<b>41</b>	83	79	68	64	62	57	47	39	<b>52</b>	68
<b>51</b>	85	80	69	65	63	57	48	40	<b>53</b>	69
<b>61</b>	88	85	75	71	68	63	53	45	<b>58</b>	75
<b>81</b>	92	84	76	72	69	65	55	47	<b>59</b>	76

Measures according to EN 3744 regulations, with respect to the EUROVENT 8/1 certification.

The sound pressure is measured at 1 m from the external surface of the unit in open field conditions.

Data referred to the following conditions :  
water to internal exchanger 30/35°C  
outdoor air temperature 7°C DB / 6°C WB

## FOULING CORRECTION FACTOR

m <sup>2</sup> °C/W	INTERNAL EXCHANGER	
	F1	FK1
0.44 x 10 <sup>^(-4)</sup>	1,00	1,00
0.88 x 10 <sup>^(-4)</sup>	0,97	0,99
1.76 x 10 <sup>^(-4)</sup>	0,94	0,98

The cooling performance values provided in the tables are based on the external exchanger having clean plates (fouling factor 1). For different fouling factor values, multiply the performance by the coefficients shown in the table.

F1 = Cooling capacity correction factors

FK1 = Compressor power input correction factor

## CORRECTION FACTOR FOR ANTIFREEZE SOLUTIONS

% ethylene glycol by weight		5%	10%	15%	20%	25%	30%	35%	40%
Freezing temperature	°C	-2.0	-3.9	-6.5	-8.9	-11.8	-15.6	-19.0	-23.4
Safety temperature	°C	3.0	1.0	-1.0	-4.0	-6.0	-10.0	-14.0	-19.0
Cooling Capacity Factor	Nr	0.995	0.990	0.985	0.981	0.977	0.974	0.971	0.968
Compressor input Factor	Nr	0.997	0.993	0.990	0.988	0.986	0.984	0.982	0.981
Internal exchanger Glycol solution flow Factor	Nr	1.003	1.010	1.020	1.033	1.050	1.072	1.095	1.124
Pressure drop Factor	Nr	1.029	1.060	1.090	1.118	1.149	1.182	1.211	1.243

The correction factors shown refer to water and glycol ethylene mixes used to prevent the formation of frost on the exchangers in the water circuit during inactivity in winter.

## INTERNAL EXCHANGER PRESSURE DROP

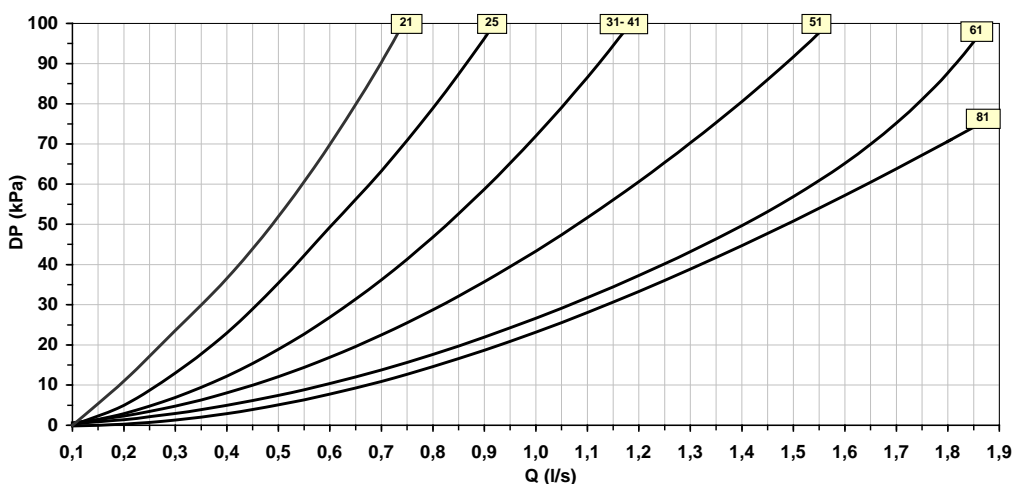

DP = PRESSURE DROP

Q = WATER FLOW

Water flow referred to the following nominal conditions:

Internal water exchanger: 30 / 35°C

Fresh air temperature: +7°C B.S. / +6°C B.U.



## DIMENSIONS

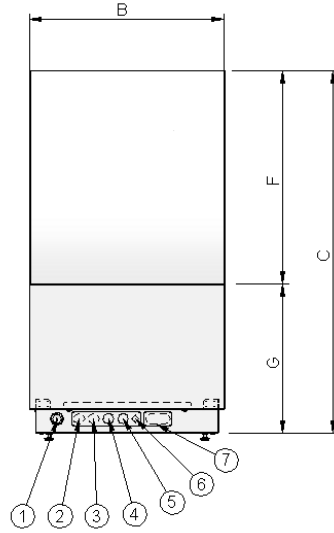
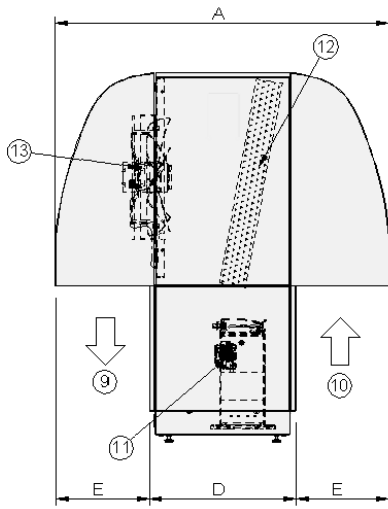

- (1) condensate discharge
- (2) installation input
- (3) installation output
- (4) domestic hot water input
- (5) domestic hot water output
- (6) installation charge
- (7) power input
- (8) E.P. and maintenance
- (9) outlet air direction
- (10) inlet air direction
- (11) compressor
- (12) finned exchanger
- (13) fan

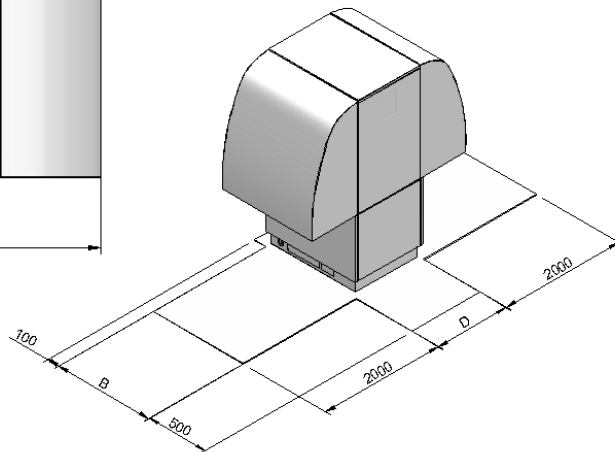
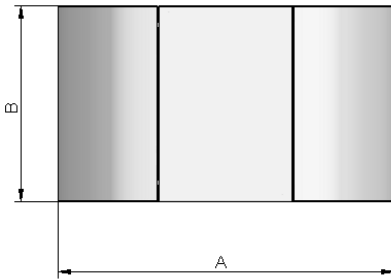

SIZE		21	25	31	41	51	61	81
A	mm	1420	1420	1420	1420	1420	1835	1835
B	mm	800	800	800	800	800	1250	1250
C	mm	1485	1485	1485	1485	1485	1770	1770
D	mm	600	600	600	600	600	775	775
E	mm	410	410	410	410	410	530	530
F	mm	870	870	870	870	870	1120	1120
G	mm	615	615	615	615	615	650	650
Length	mm	1420	1420	1420	1420	1420	1835	1835
Depth	mm	800	800	800	800	800	1250	1250
Height	mm	1485	1485	1485	1485	1485	1770	1770

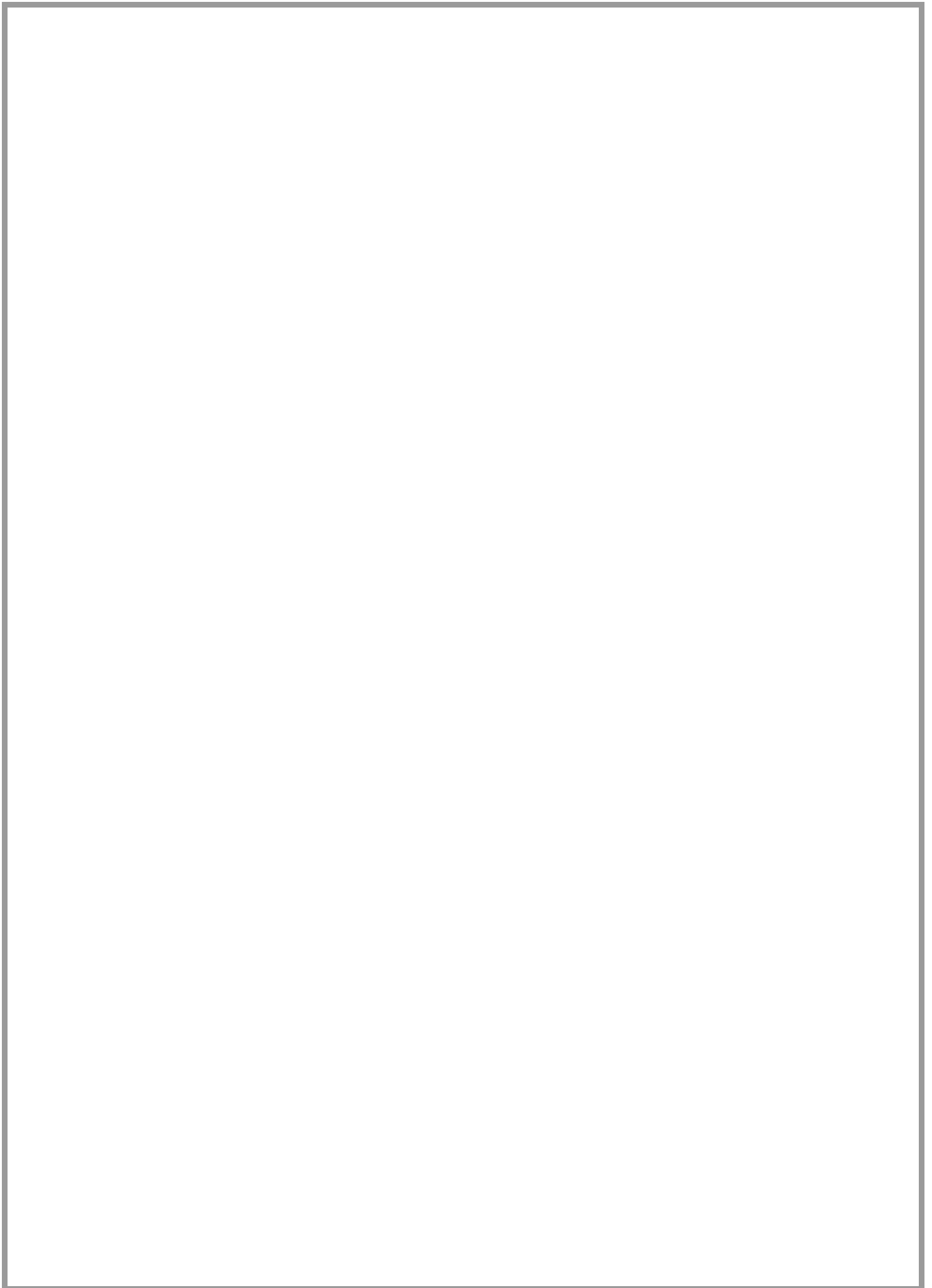

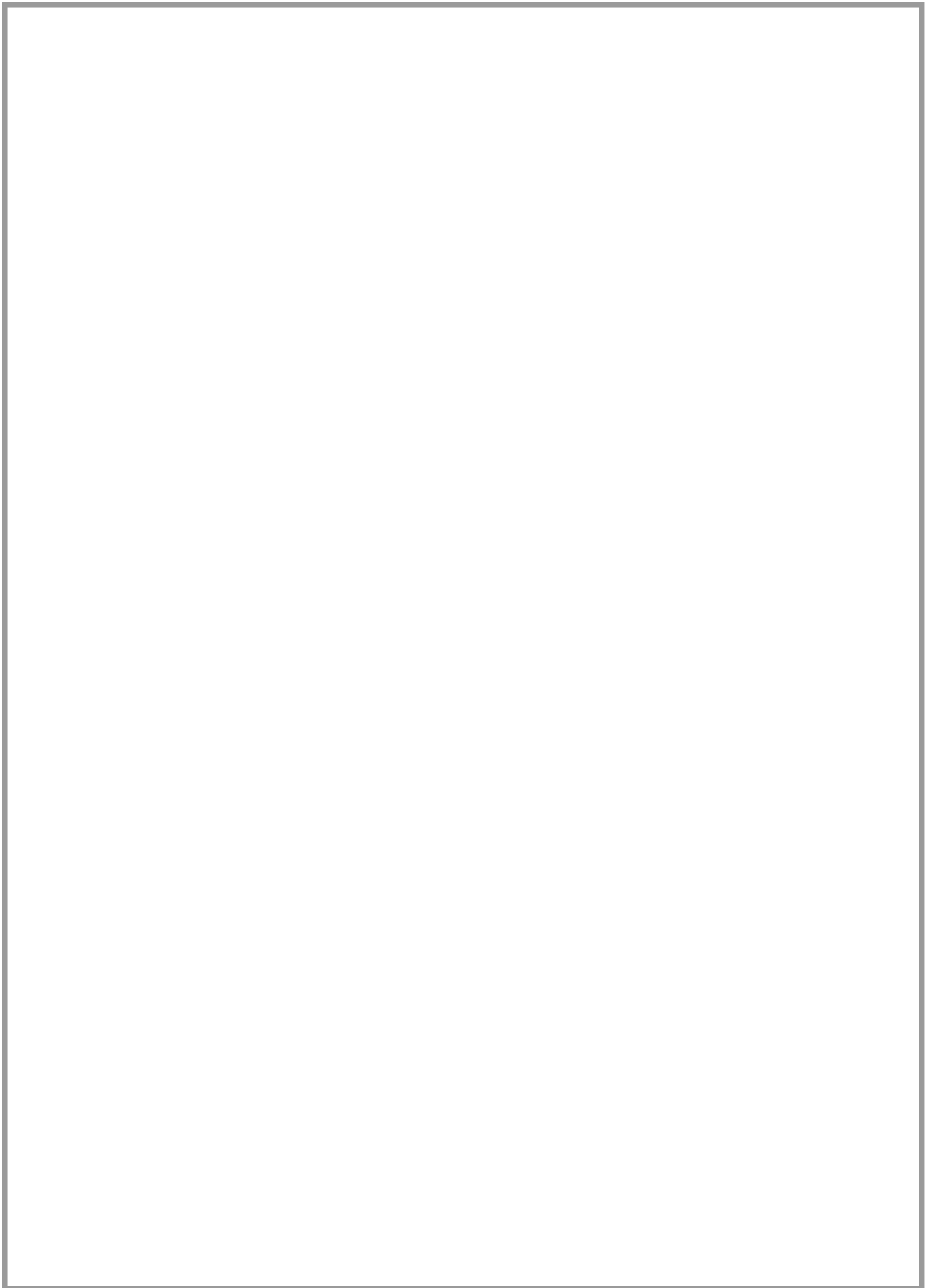

**CLIVET SPA**  
**Feltre (BL) ITALY**  
Tel. + 39 0439 3131  
Fax + 39 0439 313300  
info@clivet.it

**CLIVET ESPAÑA S.A.**  
**(Madrid) SPAIN**  
Tel. + 34 91 6658280  
Fax + 34 91 6657806  
info@clivet.es

**CLIVET UK LTD**  
**Fareham (Hampshire) U.K.**  
Tel. + 44 (0) 1489 572238  
Fax + 44 (0) 1489 573033  
info@clivet-uk.co.uk

**CLIVET NEDERLAND B.V.**  
**Amersfoort - Netherlands**  
Tel. + 31 (0) 33 7503420  
Fax + 31 (0) 33 7503424  
info@clivet.nl

**CLIVET TFA (PVT) LTD**  
**Bangalore - INDIA**  
Tel. + 91 80 25351617  
Fax + 91 80 25351392  
sales@clivettfa.com

The data contained in this bulletin is not binding and may be changed by the manufacturer without prior notice. All reproduction, even partial, is PROHIBITED.

© COPYRIGHT - CLIVET S.P.A. - FELTRE (BL) - ITALIA