



WBAN 41-61-81

AIR TO WATER HEAT PUMP FOR OUTDOOR INSTALLATION
OPERATION IN HEATING-ONLY MODE

Installation and Use Manual

UNIT IDENTIFICATION	4
INSTRUCTIONS FOR THE USER.....	5
GENERAL WARNINGS.....	8
RESIDUAL RISKS	9
RECEPTION	12
INSPECTION UPON RECEPTION	12
STORAGE.....	12
HANDLING.....	12
POSITIONING	13
GENERAL.....	13
FUNCTIONAL CLEARANCES	13
POSITIONING.....	13
WATER CONNECTIONS	15
GENERAL.....	15
EXCHANGER USE SIDE.....	15
DIAGRAM OF RECOMMENDED USE SIDE CONNECTION	16
WINTER CONDENSATION	16
ELECTRICAL CONNECTION	17
GENERAL.....	17
STANDARD UNIT ELECTRICAL DATA.....	17
START-UP	25
PRELIMINARY CHECKS	25
REFRIGERANT SYSTEM.....	25
WATER SYSTEM.....	25
ELECTRICAL SYSTEM	25
VERIFY TENSIONS – ABSORPTIONS	26
UNIT EQUIPPED WITH SCROLL COMPRESSORS.....	26
REMOTE INPUT CONFIGURATIONS.....	26
SETTING THE SET-POINT	26
EVAPORATOR WATER FLOW RATE.....	26
REFRIGERANT CIRCUIT PARAMETER CHECK	26
CONTROL	27
USER KEYPAD.....	27
REMOTE OR SERVICE KEYPAD (OPTIONALS).....	28
VISIBLE STATUS FROM REMOTE KEYBOARD OR SERVICE KEYBOARD	30
ROUTINE MAINTENANCE	32
MAINTENANCE INSPECTIONS	33
97/23 CE PED DIRECTIVE.....	33
PUT AT REST.....	33
REFRIGERANT TABLES.....	34
TROUBLESHOOTING	36
DECOMMISSIONING OF THE UNIT.....	37
DISCONNECTING THE UNIT.....	37
DISMANTLING AND DISPOSAL	37
TECHNICAL DATA	38
DIMENSIONS	41

UNIT IDENTIFICATION

SERIAL NUMBER LABEL

The units are identified by the serial number label shown here.

The label lists the type of unit (series and size), serial number, year of manufacture, number of electrical diagram, main technical data, logo and address of the manufacturer.

The label is placed on the unit, generally near the electrical panel and also on the external panelling.

IT MUST NEVER BE REMOVED.

SERIAL NUMBER

This provides unique identification of the machine. It makes it possible to trace the specific features of the unit and to identify the components installed in it.

Without this number, it is not possible to identify with certainty the spare parts that are specific to that unit.

When requesting assistance, always provide the type of machine and the serial number.

Write them in the space below so that they are readily available when needed.

Type of unit : _____

Serial number : _____

Wiring diagram : _____

Year of manufacture : _____

<div style="display: flex; justify-content: space-around; align-items: center;"> <div style="border: 1px dashed black; padding: 5px; font-weight: bold; font-size: 1.2em;">LOGO</div> <div style="font-size: 2em; font-weight: bold;">CE</div> </div>	
TIPO TYPE/TYP TYPE/TIPO	
NUMERO MATRICOLA SERIAL NUMBER / SERIENNUMMER NUMERO DE SERIE / NUMERO DE SERIE	
ANNO DI FABBRICAZIONE YEAR OF MANUFACTURE / BAUJAHR ANNEE DE FABRICATION / AÑO DE FABRICACIÓN	
REFRIGERANTE REFRIGERANT / KÄLTEMITTEL REFRIGERANT / REFRIGERANTE	GRUPPO (PED) GROUP / GRUPPE GROUPE / GRUPO
CARICA REFRIGERANTE REFRIG. CHARGE / KÄLTEMITTELFÜLLUNG CHARGE REFRIG / CARGA REFRIG.	
	Kg
TENSIONE VOLTAGE / SPANNUNG TENSION / TENSION	
	V/Ph/Hz
F.L.A.	
	A
F.L.I.	
	kW
SCHEMA ELETTRICO WIRING DIAGRAM / SCHALTPLAN SCHEMA ELECTRIQUE / ESQUEMA ELÉCTRICO	
	N°
PRESSIONE MASSIMA ESERCIZIO MAX OPERATING PRESS. / MAX BETRIEBSDRUCK PRESS. DE SERVICE MAX / PRESIÓN DE EJERCICIO MÁX	
	bar
CATEGORIA PED PED CATEGORY / PED KATEGORIE CATEGORIE PED / CATEGORÍA PED	
	PS H/L bar
TEMP. LATO BP TEMPERATURE ON LP SIDE / TEMP. ND-SEITE TEMP. COTE BP / TEMP. PARTE BP	
	°C
INDIRIZZO / ADDRESS / ADRESSE / ADRESSE / DIRECCIÓN	

INSTRUCTIONS FOR THE USER

- **This is a partial sintex of the information provided in the manual; carefully read this manual**
- Carefully read this manual. Keep it with the electrical diagram. Make it available to technicians for servicing.
- Ask the installer for training on start-up, shutdown, changing set points, placing in at-rest status, maintenance, what to do or not to do in the event of a breakdown.
- Provide for scheduled maintenance by specialized technicians so as to ensure long-lasting operation of the unit.
- If you expect the machine to be shut down for long periods of time, disconnect the electrical power supply. In winter, take necessary measures to deal with possible freezing (unit and system pipes) .

PRINCIPLE OF OPERATION

WINTER : the cooling cycle makes it possible to absorb energy (heat at low temperature) from the external environment and to transfer it to the area to be heated.

1. The compressor compresses the refrigerant fluid, placing it at high pressure and high temperature.
2. the 4-way valve diverts the flow;
3. In the plate exchanger, the water that returns to the system absorbs heat from the refrigerant.
4. As it cools, the refrigerant condenses and becomes liquid.
5. The expansion valve causes a sudden drop in the pressure of the refrigerant, which becomes very cold as its volume increases.
6. In the external coil, the cold refrigerant evaporates and absorbs heat from the fresh air. In this phase, as the coil cools, it may freeze. This is why the cycle is automatically reversed periodically for a short time so as to defrost it

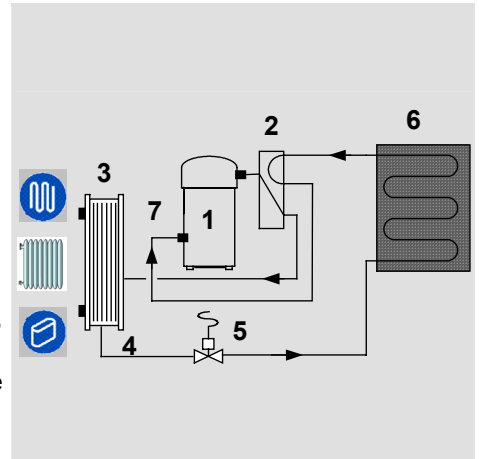

WATER CIRCUIT

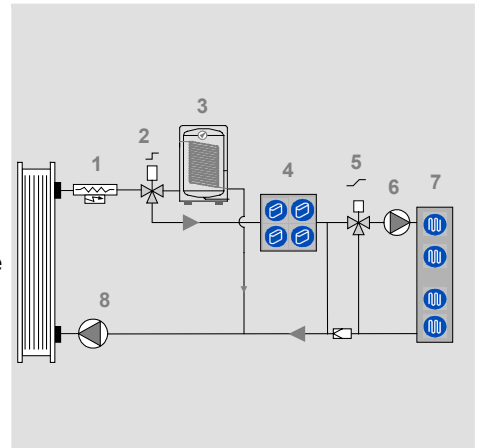

The diagram on the side is indicative and includes optional components; check with the installer about the system configuration used.

1. the electric resistances supplement the heating capacity supplied by the unit;
2. the 3-way valve diverts the water either towards the sanitary hot water storage or towards the heating equipment;
3. sanitary hot water storage;
4. fan coil heating;
5. if the room needs to be heated, the 3-way valve diverts the water towards the underfloor piping (all or in part); if instead the underfloor piping is satisfied, it returns the water directly to the unit;
6. the pump keeps the water in circulation in the underfloor piping
7. underfloor heating
8. the pump returns the water to the unit



TO DO FOR:

Some functions are active only if they are enabled during installation (remote ON-OFF, remote SUMMER WINTER change, remote ECO, sanitary hot water, set point compensation). Check with the installer about the configuration used.

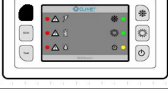
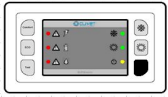
Start the unit	LONG pressing of the ON/OFF button	
Choose the WINTER mode possible also by external enabling (see ELECTRICAL CONNECTIONS)	“SNOW-FLAKE” button Green led on	
Limit the energetic consumption Control by external enabling (see ELECTRICAL CONNECTIONS)	ECO button	
Choose the optimal comfort level	COMFORT button	
Activate the hot sanitary water production	Through remote consent outside the unit “SNOW-FLAKE” button on “SUN” led is flashing	
Minimize the consumptions maintaining the system at a safety temperature in WINTER (MAINTENANCE function)	Put the unit in OFF (parameter 45 must be = 1) yellow led is flashing	
Identify the cause of the unit shutdown	RED LED lit - flashing: the alarm resets automatically - on continuously: a manual reset is necessary	



ELECTRICAL CIRCUIT ALARM

- Return probe
- Supply probe
- Radiant panel water probe
- Coil/flow probe
- External probe
- Pressure 1 probe
- Water reset return
- External relative humidity probe
- Phase monitor
- Electric resistance output probe
- serial faulty alarm



REFRIGERANT CIRCUIT ALARM

- HP
- LP
- CCMP/VENT
- HP1 Pre-Alarm
- BP1 Pre-Alarm
- serial faulty alarm



WATER CIRCUIT ALARM

- Flow pump
- System charged with water
- Antifreeze alarm
- Antifreeze PREAlarm
- Pump alarm
- C1 PREAlarm
- PRad. Cooling limit alarm
- PRad. Water frost alarm
- Coil frost alarm
- Alarm ?T° incongruous
- Electric resistance antifreeze alarm
- serial faulty alarm

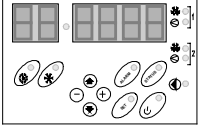
To reset the current alarm ONLY AFTER THE CAUSE ELIMINATION !	TEST + ON/OFF contemporary for some seconds	
Modify the HOT SANITARY water temperature	Control parameter 117	Only by SERVICE keypad 
Modify the water temp. in HEATING	Control parameter 33	
Modify the water temp. in ECO HEATING	Control parameter 30	
Modify the water temp. in MAINTENANCE heating	Control parameter 43	

COMMON CAUSES OF SHUTDOWN

- | | |
|--|--|
| <ol style="list-style-type: none"> 1. coils dirty - clogged by leaves - nearby obstacles - covered with snow 2. set point too low (in summer) or too high (in winter) 3. water in system is too hot (in summer, for example with machine left off over the weekend) or too cold (in winter) 4. water filter dirty 5. external permissions (remote ON-OFF etc.) | <ol style="list-style-type: none"> 6. water cut-off valves closed 7. system not pressurized - air needs to be vented 8. system pump off 9. circulator pump not running (after seasonal shutdown) 10. unit exchanger dirty 11. fans blocked by snow |
|--|--|

GENERAL WARNINGS

MANUAL PURPOSE

This manual has been designed to enable the unit to be installed, started up and maintained correctly.

MANUAL INSTRUCTIONS

It is essential to observe these instructions.

The manufacturer declines all liability for any damage that may be caused whether directly or indirectly to persons or things if these instructions are not heeded.

MANUAL STORAGE

This manual and the unit's wiring diagram should be carefully stored so that they are readily available to the operator when required.

EXPERT PERSONAL

The unit must be installed, tested and maintained by expert personal who meet the relevant legal requirements (Italian law No. 46 of 5/3/1990).

LOCAL SAFETY REGULATION INSTALLATION

The installation must be performed observing the local safety regulations.

POWER SUPPLY

Make sure the power supply conforms to the data on the unit's rating plate, located inside the door of the main electrical panel.

PACKAGING

The packaging material (plastic bags, polystyrene foam, nails, etc.) is potentially dangerous and should therefore be kept away from children and recycled in compliance with the local regulations in force.

MAINTENANCE

Before performing any service operations, cut off the power. Perform the operations in conformity with the local regulations in force.

PERIODICAL INSPECTIONS

Perform periodical inspections to locate possible loosened or broken parts. If the repairs are not performed, there will be a higher risk for things and peoples to become damaged and injured.

FAULT – POOR OPERATION

Switch off the unit in the event of faults or poor operation.

REPAIR

Only have repairs carried out by a service centre authorised by the manufacturer, and insist on the use of original spare parts only.

Failure to comply with the above may compromise the safety of the unit.

MODIFICATIONS

The manufacturer will not accept any responsibility, and the warranty will lapse, in the event of electric and/or mechanical modifications. Any modification which is not formally authorized, and which does not respect the instructions given in this manual, will cause the warranty to lapse.

INTENDED USE

The unit must only be used for the specific purpose it was designed :

The unit is designed to heat water or a water and glycol mix for air-conditioning, within the limits defined in the technical bulletin and this manual.

Any use other than that specified does not imply any commitment or constraint by the manufacturer in any way whatsoever.

ADDITIONAL SAFETY PRECAUTIONS

This unit has been especially designed and manufactured so to prevent any risk to persons and health hazard.

For this reason, design solutions fit to eliminate (where possible) any cause of risk and sensibly reduce the probability of danger have been adopted.

Please refer to the "Residual Risks" section of this manual and strictly observe the behaviour prescriptions listed there in order to prevent any possible risk that hasn't been possible to avoid in the design stage.

DATA UPDATING

The manufacturer may be able to modify the data without prior notice as a consequence of constant improvements.

REGULATIONS AND CERTIFICATIONS

UNI EN ISO 9001 CERTIFICATION

Clivet S.p.A., in order to guarantee customer satisfaction, has chosen the ISO 9001 Quality System as the reference for all its business activities. This is demonstrated by the company's commitment to ongoing improvements in the quality and reliability of its products; its sales, design, purchasing, production and after-sales service activities are the means used to reach such purpose.

CE MARK



Clivet products bear the CE mark, in compliance with the requirements of the following EC directives, including the latest amendments, and with the corresponding national approximated legislation:

- - 98/37/CE
- - 89/336/CEE as modified by the directives 92/31/CEE and 93/68/CEE
- - 73/23/CEE as modified by the directive 93/68/CEE
- - 97/23/CE

RESIDUAL RISKS

GENERAL

This section lists some of the more common situations which, being beyond the control of the manufacturer, could be a source of risk to persons or property.

DANGER AREA

The figure below highlights the area in which only authorised personnel may operate.

- **External danger zone**, identified by a precise area around the unit and its vertical projection on the ground in the case of hanging unit.
- **Internal danger zone**, identified by the area that can be entered only after having intentionally removed the protecting panels or parts of these.

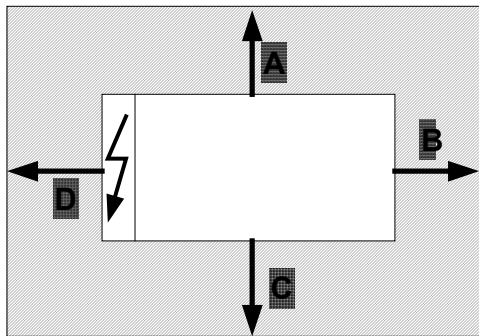

A = 1000mm B = 1000mm
C = 1000mm D = 1000mm

HANDLING

If handling operations are undertaken without adopting all the necessary safety procedures and exercising due care, the unit can fall or topple, causing damage — possibly extremely serious — to persons and/or property, and to the unit itself.

Ensure the unit is handled and manoeuvred as directed on the packing and in the present manual, and in accordance with local regulations.

In the event of refrigerant gas escaping, refer to the “Safety datasheet” for the particular refrigerant.

INSTALLATION

Incorrect installation of the unit can result in water leaks, accumulation of condensate, escape of refrigerant, electric shocks, fire, as well as irregular operation or damage to the unit itself.

Make certain that the installation is carried out only by a qualified technician, also that the directions contained in this manual are followed and local statutory regulations observed.

In the event of the unit being installed in a site where there is even the slightest risk of inflammable gas escapes and consequently the possibility of such gases accumulating in area around the unit, the risk of explosion and fire cannot be discounted.

Take every care and precaution when selecting the installation site.

Installation on a structure not able to bear the weight and/or afford a secure anchorage of the equipment may cause the unit to fall and/or topple, resulting in damage to persons or property, or to the unit itself. Make certain that every care

and precaution is taken when positioning and securing the unit.

If the unit is easily accessible to children, unauthorized persons or animals, this is a situation that can give rise to accidents and injuries, perhaps serious. Install the unit in a place where access is allowed only to authorized persons, or install barriers or guards preventing unauthorized entry.

GENERAL RISKS

A smell of burning, smoke or other indications of serious irregularity could signal the onset of situations liable to cause damage to persons or property or to the unit itself. Isolate the unit from the electrical power supply (red-and-yellow) switch.

Contact an authorized service centre so that the source of the problem can be identified and remedied.

Accidental contact with heat exchange coils, compressors, pressure pipelines or other components can result in wounding or burns, or both.

Always wear suitable clothing, including protective gloves, when working in the danger area.

Maintenance or repairs carried out by unskilled operatives can result in harm or damage to persons and property, or to the unit itself. Always contact an authorized service centre.

Failure to close the panels of the unit, or to check that all the fixing screws of the panels are properly tightened, can result in harm or damage to persons or property, or to the unit itself.

Verify periodically that all panels are closed and made properly secure.

In the event of fire, the temperature of the refrigerant can rise to the point that pressure will exceed safety levels and perhaps cause fluid to be projected. It may also happen that parts of the circuit isolated by closed valves will explode.

Do not stand near safety valves, and never leave the valves of the refrigerant circuit closed.

ELECTRICAL SYSTEM

If the power line connecting the unit to the a.c. supply is incomplete, or if the connection is made with cables of incorrect cross section and/or with insufficiently rated protective devices, this can result in electric shock, toxicity hazard, damage to the unit or fire.

All work on the electrical system should be carried out referring to the wiring diagram and to the directions given in this manual, and the system itself must be dedicated.

Failure to secure the cover enclosing electrical components can lead to the infiltration of dust and water, ultimately causing electric shocks, damage to the unit, or fire.

Always fasten the cover securely to the unit.

If live metal parts of the unit are not connected properly to the earth system, they can cause electric shock or even death by electrocution.

Make absolutely certain that the connection to the earth system is made in accordance with correct practice.

Contact with live parts rendered accessible internally of the unit when the guards are removed can result in electric shock, burns or death by electrocution.

Before exposing these parts, make certain the isolating switch on the power line to the unit is set to the OFF position and padlocked, and post a warning sign.

Contact with parts that could become live when the unit is started up can result in electric shock, burns or death by electrocution.

When there is no need for circuits to be powered up, set the isolating switch on the power line to the OFF position, padlock it and post a warning sign.

MOVING PARTS

Contact with the fan rotors can cause injury.

Before removing the protective grilles or the fans themselves, make certain the isolating switch on the power line to the unit is set to the OFF position and padlocked, and post a warning sign.

Before removing the protective grilles or the fans themselves, make certain the isolating switch on the power line to the unit is set to the OFF position and padlocked, and post a warning sign.

REFRIGERANT

In the event of safety valves coming into operation and releasing refrigerant gas, persons in the vicinity can be

injured or suffer toxic effects. Always wear suitable clothing and protective goggles when working in potential hazard areas.

In the event of refrigerant gas escaping, refer to the "Safety datasheet" for the particular refrigerant.

If an open flame or heat source is brought into contact with the refrigerant, or the pressurized gas circuit should overheat (e.g. during welding operations), this can cause explosion or fire. Do not position any heat source within the hazard area.

Maintenance or repair operations involving welding must be carried out with the system emptied of refrigerant.

WATER SYSTEM

Defects affecting pipelines, connections or valves and other control componentry can result in water being leaked or sprayed from the system, occasioning damage to property or causing short circuits in the unit.

Make certain all hydraulic connections are securely made, following the directions given in the present manual.

REFRIGERANT SAFETY CHARGE

R-407C		
01	Identifying elements for the substance	Product name: forane 407C N°SDS 01965/1 Supplier: ELF ATOCHEM ITALIA Via G.Murat 17, 20159 Milano tel. 02/668111
02	Information concerning composition of components	Chemical nature of the compound Mixture based on: Forane 32(difluoromethane) (N° CAS: 75-10-5) Forane 125 (pentafluoroethane) (N° CAS: 354-33-6) Forane 134a (1.1.1.2 tetrafluoroethane) (N° CAS: 811-97-2)
03	Identification of risk	Greatest physical and chemical dangers: Thermal decomposition in toxic and corrosive products
04	First-aid measures	General information: Inhalation: Carry the victim into the open air. Resort to oxygen or artificial respiration if necessary. Contact with skin: Frostbite must be treated in the same way as burns. Contact with the eyes: Immediate rinsing in abundant water. If irritation should continue, consult an ophthalmologist. Medical instructions: Do not administer catecholamines (due to the cardiac sensitisation caused by the product)
05	Fire prevention measures	Specific dangers: Thermal decomposition into toxic and corrosive products. Hydrofluoric acid. Carbon monoxides. Specific means of intervention: Cool containers/cisterns with jets of water. Prevent any sparks or flames. Do NOT smoke. Special protection systems for fire-fighting squads: Carry breathing apparatus and wear protective clothing.
06	Measures to take in case of accidental spillage	Individual precautions: Avoid contact with the skin, eyes and inhalation of vapours. Use personal protection devices. In an enclosed space: ventilate or use breathing apparatus (risk of suffocation). NO SMOKING ALLOWED Precautions for environmental protection: Minimise the amount of waste deposited in the environment.
07	Manipulation and storage	Technical measures/precautions. Form of storage and manipulation applicable to the products: PRESSURIZED GAS. Ensure adequate ventilation and evacuation for the level of equipment. Advice for use: Prevent sparks and contact with hot surfaces. DO NOT SMOKE. Technical measures/Storage procedures: Store at ambient temperature in the original container. Keep away from flames, hot surfaces and sparks. Store in a cool, well-ventilated place. Protect full containers from sources of heat to avoid excessive pressures. Recommended: Ordinary steel. Avoid: Alloy containing more than 2% magnesium. Plastics.
08	Control of individual exposure/protection	Precautionary measures to be taken: Ensure a sufficient exchange of air and/or suction in workplaces. Control parameters. Exposure limits: There is no F-USA limit value Forane 134a Elf recommended limit value: VME=1000ppm Forane 32 Elf recommended limit value: VME=1000ppm Forane 125 Elf recommended limit value: VME=1000ppm Respiratory protection: In case of insufficient ventilation, carry suitable breathing apparatus. Protection for the hands: Gloves Protection for the eyes: Protective eyewear.

09	Physical and chemical properties	<p>Physical state (20°C): liquid gas Colour: colourless Smell: Slightly similar to ether; pH: not applicable. Boiling point/interval: -42,4 °C Melting point/interval: Not inflammable in test conditions Vapour pressure: (25°C): 1.13 Mpa (11,3 bar) a (50°C): 2.11 Mpa (21,1 bar) a (70°C): 3.26 Mpa (32,6 bar) Vapour density: At boiling point 4,54 kg/m3 Density: (25°C) 1133 kg/m3 a (50°C) 1004 kg/m3 a (70°C) 861 kg/m3</p>
10	Stability and reactivity	<p>Conditions to avoid: Avoid contact with flames and red-hot metal surfaces. Dangerous decomposition products: Thermal decomposition into toxic and corrosive products: Toxic fluorinates Hydrogen fluoride (hydrofluoric acid) Further information: Product stable in normal storage and handling conditions</p>
11	Toxicological information	<p>Inhalation: Practically non-toxic in experiments conducted on animals Forane 134a, 32, 125. No rat mortality at 500000 ppm/4h. As with other volatile aliphatic halogenated compounds, with the accumulation of vapours and/or the inhalation of large quantities, the product can cause: loss of consciousness and heart problems aggravated by stress and lack of oxygen; risk of death. Contact with skin: Frostbite possible from splashes of liquefied gas. Chronic toxicity: Studies on extended inhalation in animals have not highlighted any sub-chronic toxic effect (rat/3 months/ Inhalation:50000ppm) Specific effects: Genotoxicity, according to experimental data available Forane 134a, 32, 125 NOT Genotoxic Carcinogenic effect: Forane 134a experiments on animals have not demonstrated a clear cancerogenous effect (rat /oral inhalation) Toxicity for reproduction: Foetal development Forane 134a, 32, 125 according to available data there are no toxic effects for foetal development. Fertility, according to available data for animals: Forane 134a no effect on fertility (mice/inhalation)</p>
12	Ecological information	<p>Forane 32 Durability/degradability: Not easily biodegradable in water: 5% after 28d Bioaccumulation: Practically non-absorbable by biological organisms log pow 0,21 Forane 125 Mobility: Rapid evaporation t ½ life 3,2 h (estimated) Durability/degradability: Not easily biodegradable in water: 5% after 28 days. In the atmosphere degradation at rate of 1/2 life in 28,3 y (estimated). . Potential for destruction of ozone ODP (R-11 = 1)=0. Potential greenhouse effect (GWP): (HGWP) = 0,58. Low absorption in ground and sediments log Koc= 1,3-1,7 Bioaccumulation: Practically non-absorbable by biological organisms log pow 1,48 Forane 134a Mobility: Rapid evaporation t ½ life 3 h (estimated) Durability/degradability: Not easily biodegradable in water: 3% after 28 days. In the atmosphere degradation at rate of 3% after 28 days (estimated). Potential for destruction of ozone ODP (R-11 = 1)=0. Potential greenhouse effect (GWP): (HGWP) = 0,26. Bioaccumulation: Practically non-absorbable by biological organisms log pow 1,06</p>
13	Notes concerning disposal	<p>Disposal of product: recycle or incenerate.</p>
14	Information on shipping	<p>Consult the ELF ATOCHEM safety service for supplementary information and updates ONU number 3163. RID/ADR class 2 figure (and letter) 4° a Regulations: No. danger/No. material 20/3163 label 2 IMDG class 2.2 ONU (IMDG) 3163 Regulations: 2.2 /2 label IATA class 2.2 ONU (IATA) or No.ID 3163 Regulations: 2.2 /2 label</p>
15	Information on regulation	<p>EEC directives Security reports: D.91/155/CEE modified by D.93/112/CEE: Dangerous substances Classification/CE mark Dangerous manufactured compounds: Not classified as dangerous Inventory: EINECS compliant</p>
16	Other information	<p>Recommended uses: low-temperature coolant Bibliographical references: Encyclopedie des gas (Air Liquide-ed.1976- ELSEVIER AMSTERDAM)</p>

This document refers to the product as is and which conforms to the specifications supplied by ELF ATOCHEM. If combinations or mixtures are made, check that there are no new dangers resulting from this action. The information provided in this report has been provided in good faith and is based on our latest knowledge of the product in question as of the date of publication of the same. The attention of users is drawn to the potential risks of employing the product for any use other than that for which it is intended. This report must be used and reproduced solely for purposes of prevention and safety. The list of legislative, regulatory or administrative texts must not be considered exhaustive. The product user is under obligation to refer to all the official texts concerning the use, conservation and manipulation of the product for which he is sole responsible. The product user must also provide all those who might come into contact with the product with the information necessary for their safety at work and the protection of their health and that of the environment, giving them a copy of this safety information report.

RECEPTION

INSPECTION UPON RECEPTION

Check on arrival that the unit has not suffered damage during transit and that it is complete in every part as specified in the order. In the event of visible damage/deficiencies being discovered, make a note immediately on the delivery document with the comment: **CONDITIONAL ACCEPTANCE — CLEAR EVIDENCE OF DEFICIENCIES/DAMAGE DURING TRANSIT**

Inform both the supplier and the carrier of the details by fax and by registered mail with advice of receipt not later than 8 days after taking consignment. Notifications sent after 8 days have elapsed will be ignored.

STORAGE

Shelter from: direct sunlight, rain, sand and wind

Temperature: maximum 60°C minimum -10°C

Maximum humidity: 90%

The respect of the instructions on the exterior side of the packaging assures the physical and functional integrity of the unit for the final user's advantage.

It is recommended to:

- Handle carefully
- Keep in a dry place
- Avoid putting other objects on top of the unit (respect the limits of levels of superimposition shown in the package)
- Avoid placing the unit with thermoretractable protection under the sun since the pressure of the circuits can assume values which activate the safety valves.

HANDLING

The operation of handling the unit must be carried out respecting the instructions of the safety norms in force (Legislative Decree 626/94 and following modifications)

Before starting the handling operations:

- Value the critical points during handling (stairs, flights, disconnected routes, doors, etc)
- Verify that the lifting capacity of the means used is adequate to the unit weight
- Consider that the barycentre could be moved with respect to the center of the unit
- Before starting to lift, verify that the unit is at a stable balance

The following examples are indications; the choice of the means and of the handling modes will depend on factors, such as:

- The unit weight
- Type and overall dimensions of the unit
- Place and route for the handling (dirt yard, asphalted square, etc)
- Condition of the place of destination (roof, square, etc)
- Handling distance characteristics (distances, flights, steps, doors)

LABELS / YELLOW BRACKETS SHOW THE LIFTING POINTS

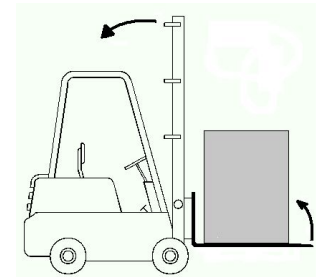
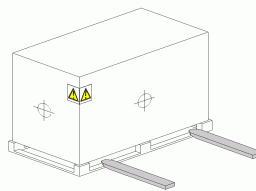
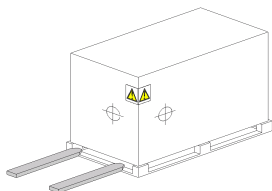

REMOVING THE PACKING

For removing the packaging, use specific personal protection for the operator (gloves, glasses, etc.).

While removing the packaging, pay attention not to damage the unit.

Check for any visible damage.

Dispose of the packaging by taking it to specialist collection or recycling centres in accordance with local regulations.

POSITIONING

GENERAL

For installing air-conditioning systems, it is necessary to consider the following:

- the technical spaces necessary for the machine and system
- the place where the machine will be installed
- the transport of thermal carrier fluids and relevant connections to the unit:
 - water
 - air
 - refrigerant (unit in more sections)
- electrical connections

If these aspects are not evaluated carefully, they can affect the performances and the working life of the unit.

FUNCTIONAL CLEARANCES

When placing the unit, please respect the functional clearances indicated in DIMENSIONS section.

The functional spaces need to be observed because of the following:

- to guarantee the good operation of the unit
- to allow the performance of all maintenance operations
- to protect the authorized operators and exposed people

If more units are placed close to one another, the functional spaces must be doubled.

POSITIONING

1. The units are designed for **OUTDOOR** installations, performed in fixed positions and in areas accessible only to qualified and authorized personnel
2. **SAFETY VALVE** (only if present on the unit) : the installer is responsible for evaluating the opportunity of installing drain tubes, in conformity with the local regulations in force (EN 378)
3. Install the unit **raised** from the ground
4. avoid installations in places subject to **flooding**
5. Consider the maximum level which can be reached by **snow**
6. Verify that the fixing/supporting points are level and suitable to support the **weight of the unit** (see the weight and the weights distribution)
7. It is recommended to put the unit on specific **antivibration devices**

Each support point of the unit sustains a different weight. Therefore, each anti-vibration device is sized for a specific support point, and can only be placed there. The anti-vibration devices must therefore be placed in accordance with the instructions provided with them and with the dimensional drawings in which the support points are indicated by W1 , W2 , W3 etc .

On each anti-vibration device (if provided by CLIVET), its identifying code is stamped, for example C6100100

Flexible joints are necessary on all the hydraulic/aerualic connections (the joints are not supplied by Clivet)

8. **Anchor** the unit to the ground; foresee windbreak barriers in case of places where there are strong prevalent winds .
9. during winter operation, a considerable amount of **condensation** water is produced, which must be removed from the unit.

Make sure that removal of condensation water does not create any problems for persons or property, such as dripping from balconies, onto walkways, etc.

For long periods of heat pump operation with outside temperature below 0°C, the condensation might **freeze**, causing a build-up of ice. The installation of anti-freeze heating elements should be considered.

For the units that are equipped with a condensation drain, this is shown on the dimensional drawing.

10. The choice of the location of the unit is of fundamental importance for correct operation; to avoid:
 - **obstacles** that block the flow of air
 - difficulty in air **circulation**
 - **leaves** or other objects that may block the exchanger coils
 - **winds** that contrast or excessively assist the air flow
 - phenomena of **stratification** or air **re-circulation**
 - nearby **sources** of heat (chemney, extractor ecc)
 - positioning under the round level or near very high walls

The previous situations cause working anomalies or stop the machine and cause:

 - during WINTER operation, decrease of the evaporation pressure with increase to the amount of defrosting and consequent decay of the performances and possible stops due to high pressure.

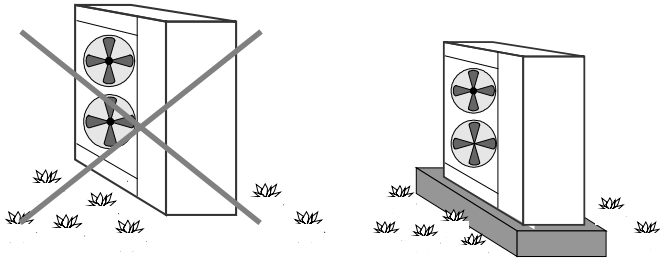

Install the unit raised off the ground and on a sturdy base.

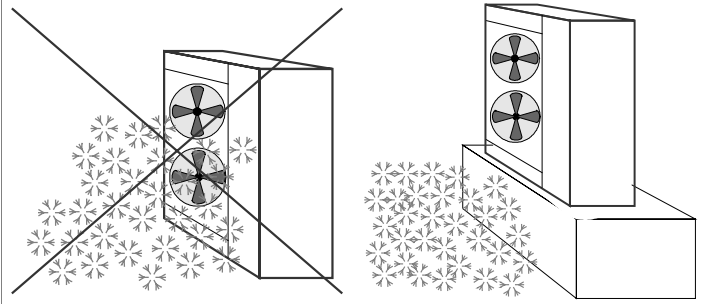

Consider the maximum depth that snowfall might reach.

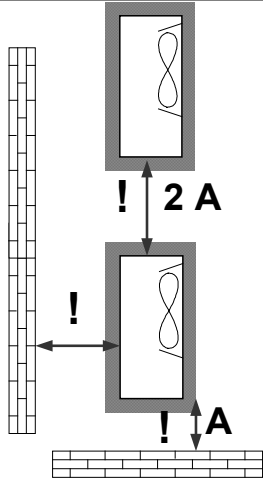

Consider clearances and direction of expelled air.

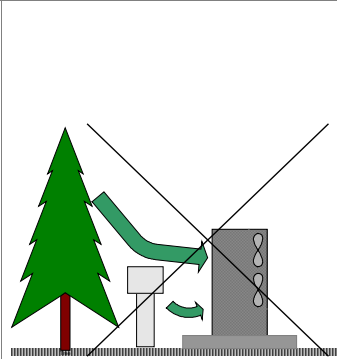
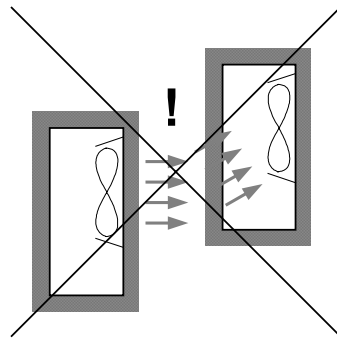

Keep the coil clean. Avoid zones with leaves / dirt / corrosives.

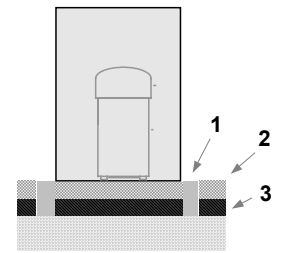

1. elastic joint
2. floating floor
3. soundproofing

Prevent the transmission of vibrations.

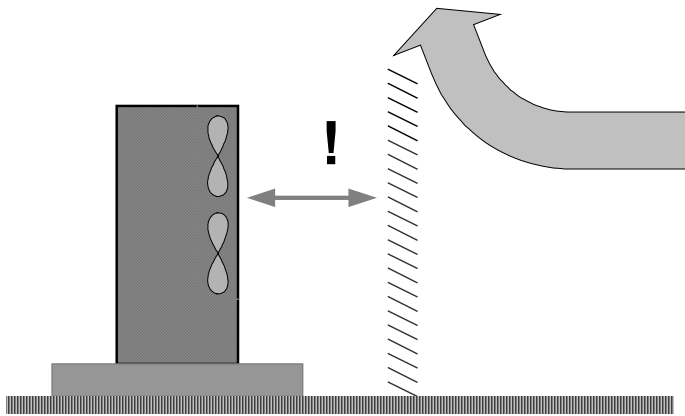

Provide windbreaks in locations with strong winds

WATER CONNECTIONS

GENERAL

Piping must be designed with the least possible number of bends and head variations. If the pressure chute of the installation is above the useful prevalence of the pump, the water delivery capacity is reduced as well as, as a consequence, the thermal exchange and the yield.

INTERCEPTING VALVES

Install on the input and output of the user parts (exchangers, coils, humidifiers, etc) So that it will be possible to carry out all the service operations and possible substitutions without emptying the installation.

PRESSURE AND TEMPERATURE INDICATOR

Install on the input and output of the user parts (exchangers, coils, humidifiers, etc) So that it will be possible to carry out all the service operations.

AUTOMATIC OR MANUAL ESCAPE VALVES

Install the highest points of tubes in a way that the air can escape from the circuit.

BLEEDING COCK

Install them at the lowest points of the circuit, so as to allow emptying.

LEAKAGE TESTS

Before performing the insulation of the tubes, carry out a leakage test.

TUBE INSULATION

All tubes of water must be insulated so that to avoid the formation of condensation and thermal dispersions along the tubes themselves. Verify that the insulation is the vapour coil type. The connections for the air escape and for the emptying must be out of the insulating thickness to assure the accessibility.

CONNECTIONS SUPPORTS

The weight of the hydraulic connections must be supported in the exterior of the unit so as not to stress the connections of user devices (exchangers, coils, humidifiers, etc) .

ANTI-VIBRATION DEVICES

In case of units with anti-vibration devices, it is necessary to assemble elastic joints, even on water connections.

RISK OF FREEZE

If the unit and the relevant water connections are subject to temperatures near 0°C:

- mix the water of the system with glycol
- protect the tubes with heating cables under the tubes insulation
- empty the system by verifying that:
 - no taps are closed so they can not trap the water, even after emptying
 - there are no low points where the water can stagnate even after emptying; blow if necessary

INSTALLATION EMPTYING

The refilling of the water present in the installation increase the oxidation phenomena and lime deposits.

If necessary empty only the interested system section and anyway empty or refill the installation if necessary .

EXPANSION TANK

The installation must be kept at the right pressure by both an expansion tank and a combined valve of pressure reduction and discharge; if the components are present on the unit, they must be installed on the installation. The expansion tank must be dimensioned in function of the water in the installation.

MAX. WORKING PRESSURE = 5.5 bar

ARIES EFFECTS AND AIR BUBBLES CAN PRODUCE THE OVERCOMING AND CAUSE WATER DROPS.

EXCHANGER USE SIDE

FILTER

It is very important for the water to be free of impurities. If it is not, the efficiency of thermal exchange is diminished. In worst cases, the exchanger can be irreparably damaged. If the filter is not present on the machine, it must be immediately installed upstream from the unit, in a position which can be easily reached for cleaning

The filter mesh must be :

- < 1 mm unit with 1 compressor
- < 1.5 mm multicompressor unit.

FLOW SWITCH

The flow switch must be present as a component of the system, so as to ensure shutdown of the unit if water is not circulating. It must be installed in a straight tract of the tubes, not near the elbows, which can generate harmful turbulence

UNFREEZABLE LIQUIDS

If the unit is used when the water temperature is lower than + 4°C, avoid the formation of ice by using unfreezable liquids (ex. Ethilenic Glycol) in the necessary percentage. The use must also be determined for ambient temperatures near 0°C .

ANTIFREEZE RESISTANCES

If the unit is equipped with antifreeze resistances on the exchanger side (standard or optional according to the models), verify that they are electrically fed during periods that the machine is stopped (night, weekends, long stops)

WASHING THE SYSTEM

Carefully wash the system by using clean water and discharge it before connecting the unit.

DIAGRAM OF RECOMMENDED USE SIDE CONNECTION

Depending on the type of machine and the selected setup, some components may be integrated into the unit.

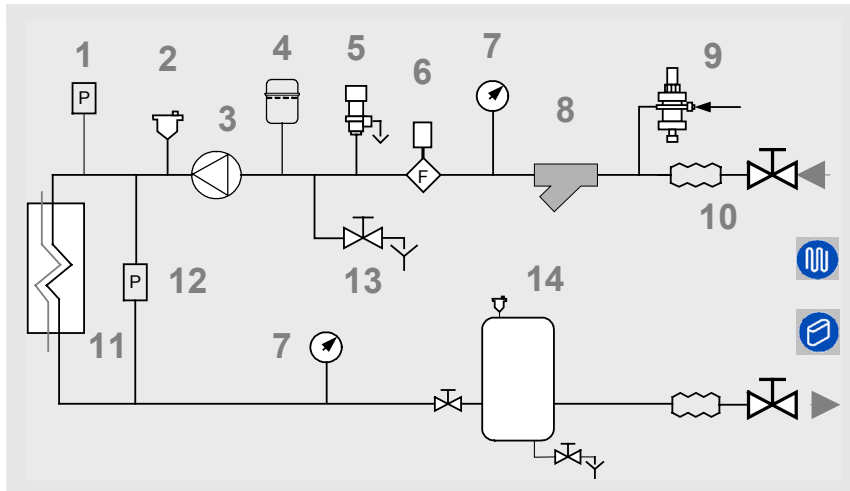

1. Charged system pressure switch
2. vent
3. circulating pump / pump
4. expansion tank
5. safety valve
6. flow switch
7. pressure switch / thermometer
8. filter
9. filling valve
10. antivibration joints
11. user side exchanger
12. Differential pressure switch
13. Discharge cock
14. inertial storage tank

The accumulation tank is necessary in the event of the following:

- the water in the system is very low
- the unit will not be used in a private house (in an industrial process or other)

WINTER CONDENSATION

When a heat pump is running it produces a considerable amount of water due to the defrosting cycles of the external coil.

The condensation must be eliminated in a manner to avoid wetting pedestrian areas.

The units are equipped with a condensation collection basin: **connect both connections** to guarantee the disposal.

The connection must not transfer mechanical stresses and it must be performed paying attention to avoid the damaging of the unit discharge connection.

With extensive very cold outdoor temperatures, condensation could freeze and block the flow, causing a slow build-up of ice; therefore special attention must be paid to eliminating condensation, raising the unit off the ground and evaluating whether antifreeze elements should be installed (also to protect the connection sleeve to the basin) .

THE FROST OF THE CONDENSATE WATER CAN LEAD TO UNIT IRREVERSIBLE DAMAGES.

ELECTRICAL CONNECTION

GENERAL

The characteristics of the electrical lines and relevant components must be determined by SPECIALIZED PERSONNEL ABLE TO DESIGN ELECTRICAL INSTALLATIONS; moreover, the lines must be in conformity with professional procedures and the regulations in force.

All electrical operations should be performed by trained PERSONNEL HAVING THE NECESSARY REQUISITES UNDER LAW and being informed about the risks relevant to these activities.

Before performing any operation on the electrical system, make sure that the unit supply line is SELECTED AT START.

The earth connection must be made prior to other electrical connections.

For all electrical type operations, REFER TO THE ELECTRICAL DIAGRAM ATTACHED TO THE UNIT; the number of the diagram is shown on the registration plate positioned on the electrical board or next to it.

The electrical diagram should be carefully kept together with this manual and should be AVAILABLE FOR FUTURE INTERVENTION ON THE UNIT.

LINE OF UNIT POWER SUPPLY

The ELECTRICAL DATA OF THE UNIT are shown in the technical chart of this manual and on the unit registration plate. The presence of accessories can vary according to the unit; the electrical data shown in the technical chart

refer to standard units. In the event of differences between the data of the registration plate and the data shown in this manual, as well as in the technical chart, please refer to the DATA SHOWN IN THE REGISTRATION PLATE.

The protection device of the unit power supply line should break off the short circuit power whose value should be determined according to the plant features.

The section of supply cables and protection cable must be seized according to the characteristics of the protections used.

SIGNALS / DATA LINES

Do not overpass the maximum power allowed, which varies, according to the type of signal.

Lay the cables far from power cables or cables having a different tension and that are able to emit electromagnetic disturbances.

Do not lay the cable near devices which can generate electromagnetic interferences.

Do not lay the cables parallel to other cables; cable crossings are possible, only if laid at 90°.

Connect the screen to the ground, only if there are no disturbances

Assure the continuity of the screen during the entire extension of the cable.

Observe, if any, the requirements about impedance, capacity, attenuation

STANDARD UNIT ELECTRICAL DATA

VOLTAGE: 230/1/50

Sizes		41
F.L.A. FULL LOAD CURRENT AT MAX ADMISSIBLE CONDITIONS		
F.L.A. – Circulating pump	A	1
F.L.A. - Totale	A	30,4
F.L.I. FULL LOAD POWER INPUT AT MAX ADMISSIBLE CONDITION		
F.L.I. – Circulating pump	kW	0,2
F.L.I. – Tota	kW	6,1
M.I.C. MAXIMUM INRUSH CURRENT		
M.I.C. - Value	A	162,3

power supply 230/1/50 Hz +/-6%

voltage unbalance: max 2 %

VOLTAGE: 400/3/50+N

Sizes		41	61	81
F.L.A. FULL LOAD CURRENT AT MAX ADMISSIBLE CONDITIONS				
F.L.A. - Circulating pump	A	1	1	3,2
F.L.A. - Total	A	10,6	15,3	22,9
F.L.I. FULL LOAD POWER INPUT AT MAX ADMISSIBLE CONDITION				
F.L.I. – Circulating pump	kW	0,2	0,2	0,7
F.L.I. – Total	kW	5,5	7,8	11,1
M.I.C. MAXIMUM INRUSH CURRENT				
M.I.C. - Value	A	66,3	103,3	103,5

power supply 400/3/50 (+ NEUTRO) +/- 6%

voltage unbalance: max 2 %

SYSTEM COMPOSITION

The system is composed of the following modules; some are optional that could be not installed. Some are supplied in packages separate from the unit: check the shipping document descriptions

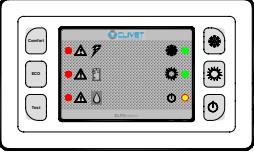
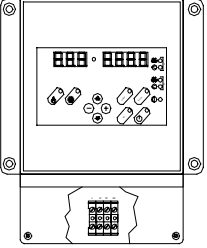
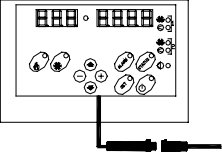
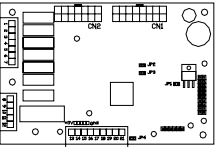
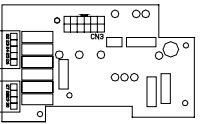
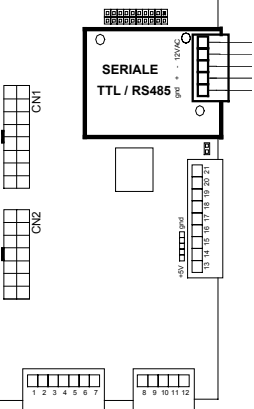
	<p>USER AMBIENT TERMINAL Permits setting the unit function modes (cooling – heating, ECO) and to display the alarms (ELECTRIC, REFRIGERATOR, WATER). This is standard on certain types of unit</p>
	<p>REMOTE KEYPAD OPTIONAL The interface terminal enables to control every machine function, to program the different adjustment parameters and possibly to display the unit statuses and alarms. It remotely repeats all functions available on the machine keyboard</p>
	<p>SERVICE KEYPAD OPTIONAL Useful during the maintenance operations; it is fitted with a cable with automotive rapid connector for the utilisation in proximity to the unit. The functionalities are analogous to the remote keypad ones.</p>
	<p>MAIN ADJUSTMENT MODULE It controls unit (inlets, outlets, configuration parameters)</p>
	<p>EXPANSION PLUG-IN MODULE It is connected to the main module by a coupling comb. This may be fitted on the unit depending on the unit type and the accessories that are installed.</p>
	<p>SERIAL CONVERTER TTL/RS485 OPTIONAL Plugged-in in the main module on the electric board (see lay in the wiring diagram). It is possible to connect up to 127 units with a single supervision system. The connection with a PC must use a RS485/232 converter; the serial line RS232 can be max. 10-m long. CONNECTIONS: make reference to the electrical panel and to the SIGNALS AND DATA LINES paragraph</p>

FUNCTIONAL CONNECTIONS

FOR ALL THE CONNECTIONS MAKE REFERENCE TO THE ELECTRICAL PANEL SUPPLIED WITH UNIT

Use voltage-free remote control devices that are suitable to commutate very low loads (12V, 10mA)

Few inputs must be activated by configuration parameters whose access is reserved to authorized assistance centres (in order to avoid unauthorized modifications)

1. remote ON / OFF
2. remote SECOND SET POINT (ECO)
3. Machine OPERATION / SHUTDOWN SIGNAL
4. REMOTE KEYPAD
5. PHASE MONITOR
6. ELECTRIC INTEGRATION during heating*
7. coupling with BOILER*
8. SANITARY HOT WATER*
9. UNDERFLOOR HEATING
10. SET POINT COMPENSATION for outside temperature/enthalpy
11. SET POINT COMPENSATION with 4-20 mA signal
12. interface via RS485

1. ON / OFF FROM REMOTE CONTROL

Generally the unit is delivered with bridged terminals; if the control is not used, the bridge should not be removed

2. SECOND SET POINT FROM REMOTE CONTROL (ECO)

Use of a second set point (par 29 cooling, par 30 heating), usually higher in summer and lower in winter (ECO). The commutation can be also performed manually by keypad.

The SANITARY HOT WATER option may entail modifications of the input in question: see the relative section.

SANITARY WATER ENABLING

The input is the same of the SET-ECO above described . By parameter is possible to set it as a control input for sanitary H2O to which can be connect for example a boiler thermostat .

This function exclude the possibility to use the second setpoint by remote control .

3. SIGNALIZATION OF MALFUNCTIONING/ UNIT FUNCTIONING

Remote signalisation of the proper function (ex. green light) or signalisation of blocks of the machine (ex. red light). Maximum voltage at the terminal ends is 24v ac and maximum power is 1A (ac1) .

4. REMOTE KEYPAD

Max. Length	100 metres
VOLTAGE	230/1/50
Signal conductor number	2 + shield
Min. length	0.34 mm ²

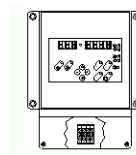

5. PHASE MONITOR

It allows to control the presence and the correct phase sequence of the power supply.

It is separately supplied with assembly in the unit electric panel installed by the customer.

6. ADDITIONAL HEATING ELEMENT

It is possible to control an external element for additional heating, typically electric resistances.

The control can be:

- ON-OFF (max 1 A)
- modulating WITH SIGNAL 0-10 V

(in this case a plug-in expansion module is necessary, an optional that must be assembled by the customer (refer to the instructions in the kit) and enabled with the parameter 140=1
The diagram on the side is indicative: check the position of the water connections on the dimensional drawing of the unit or on the adhesive labels on the unit itself.

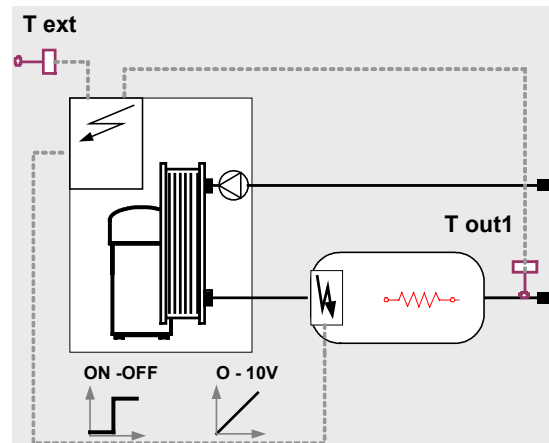

The parameters 178 and 179 can be used to select the behaviour of the resistances:	P 178	P 179
AS AN ADDITIONAL ELEMENT ONLY the resistances are considered as a second power step	1	0
IN REPLACEMENT OF THE COMPRESSOR the resistances operate only when the compressor is disabled due to an external temp. lower than par. 180	1	1
MAIN ADJUSTMENT UNIT IN HEATING MODE in heat pump mode the compressor is disabled	2	1
POWER LIMITATION ACCORDING TO OUTSIDE TEMPERATURE the following behaviour occurs as the outside temperature decreases: 1st Zone = Compressor Enabled / Resistances Disabled 2nd Zone = Compressor Enabled / Resistances Enabled 3rd Zone = Compressor Disabled / Resistances Enabled	2	2

It is necessary to declare the presence of the supply probe **Tout 1** with par. 70 = 1.

This probe becomes the reference for heat adjustment in heating mode; furthermore it manages the antifreeze protection for this part of the system.

par	description	Meaning	value
70	Tout1En	Enables output probe	
140	PlugInEn	Enables PLUG-IN presence . 1=YES / 0=NO	
177	PotRes	Power provided by the additional resistances	100
178	ModeResistance	Enable compressor operation in heating	0
179	LimPotTextEn	Enable capacity limit for ext. temperature	0
180	LimText	Ext. temperature limit for compressor operation	0
181	IstRes	Differential on LimText value for resistances activation	5

ELECTRIC RESISTANCES 2, 4, 6 kW

The unit can be equipped with the electric resistance kit .

The capacity installed is of 6 kW, distributed on 3 resistances from 2 kW , each one protected by a fuse assembled on DIN bar in the electric panel .

To limit the capacity at 4 kW is sufficient to remove a fuse ; to limit it at 2 kW it is necessary to remove 2 fuses (see the wiring diagram).

7. COUPLING WITH BOILER

This function allows the unit to be coupled to a boiler with "high temperature" thermostat setting (70 °C for example), i.e., with a working point above the operating limits of the unit.

The coupling to the boiler is managed using:

- the fresh air temperature probe **Text** that disables the unit and activates the boiler for outside temperatures less than the threshold set by parameter 88
- valves **YV1** and **YV2** that disconnect the unit from the system when the water temperature of the system detected by the probe **Tout1** is above the operating limit set by parameter 86

It is not possible to switch to the boiler in case of unit shutdown.

MAINTENANCE

With the unit coupled to a boiler the maintenance function, if enabled, activates the boiler instead of the heat pump if necessary.

The diagram on the side is indicative: check the position of the water connections on the dimensional drawing of the unit or on the adhesive labels on the unit itself.

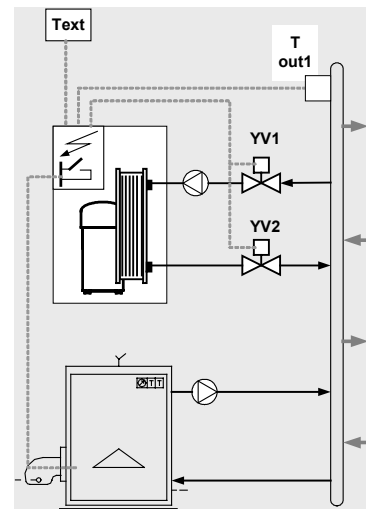

Par	Description	meaning	Default	U. m.
85	CaldaiaEn	Enable Boiler+Heat Pump Function	0	float
86	SogliaMaxImp	Water temperature value above which the heat pump is disabled and the output YV1 / 2 remains energized	55	°C
87	IsteresiSMI	Hysteresis for heat pump activation and YV1 / 2 deactivation	2	°C
88	SogliaExt	Outside temperature threshold below which the Boiler is enabled	-5	°C
89	IsteresiExt	Outside temperature hysteresis for heat pump activation	3	°C
70	Tout1En	Enable probe output		

8. CONTROL OF THE 3-WAY VALVE FOR SANITARY HOT WATER

Sanitary hot water can be produced in summer and winter, based on an **external request**, by controlling a dedicated 3-way valve.

When the contact is closed, the valve switches to the sanitary hot water storage and the unit changes its working set point to the sanitary hot water set point (par 117).

The passage from SANITARY HOT WATER mode to COOLING (or vice versa) is timed and occurs only when the temperature of the water has dropped below the safety limit defined by parameter 108.

Similarly, in the passage from SANITARY HOT WATER to HEATING the switching occurs when the temperature of the water has increased beyond the safety limit defined by parameter 109.

This function requires the optional **plug-in expansion module** that must be assembled by the customer (refer to the instructions in the kit) and enabled with the parameter 140 = 1.

To enable the SANITARY HOT WATER management in summer as well, par. 119 must be = 1

If the SANITARY HOT WATER set point is satisfied but the external request remains active, the **INCONGRUENT THERMOSTAT C36 shutdown is signalled**: the sanitary hot water boiler thermostat must be set to the same value as the sanitary hot water set point of the machine.

If remote control will also be used for the SECOND SET POINT, it is necessary to set par. 50 = 2. In this mode the inputs on the main card will be configured as follows:

- CN1_10/11 sanitary hot water request
- CN1_14/16 second set point

Refer to the wiring diagram to identify the corresponding terminals

par	Description	Meaning	value
49	Comando2°Set	Mode control 2° set point by parameter	0
50	EnH2OSanitaria	Enabling sanitary water valve management	0
109	TLimiteHeat	H2O input value above which the compressor is enabled in heat mode	25
117	SetH2OSanitaria	Set Point sanitary water	35
119	ModeEnable	Configure operation mode	
140	PlugInEn	Enables the PLUG-IN presence. 1=YES / 0=NO	

With par. 50 = 1 the management becomes the following:

- CN1_10/11 unconfigured
- CN1_14/16 second set point / sanitary hot water

In this mode the 2nd set point (ECO) cannot be enabled by remote consent; it can be enabled from the LED keypad with the ECO key or by setting parameter 49 = 1

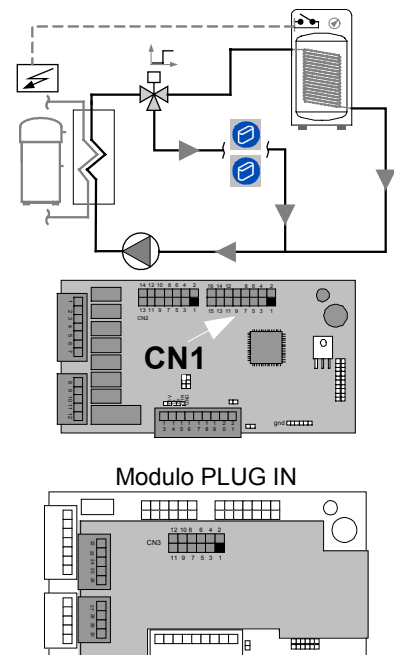

SANITARY HOT WATER: COMPENSATION OF THE SET POINT FOR OUTSIDE TEMPERATURE*

The set point can be compensated according to the outside temperature in 2 modes:

1. hot season thermal efficiency curve
 when the outside temperature is high, the sanitary hot water set point is decreased; in this manner the thermal efficiency is increased
 curve A in the graph
 the compensation is enabled in the standard configuration
2. compressor operation limit
 when the outside temperature is particularly cold, the sanitary hot water set point is decreased in order to guarantee operation of the compressor even near its operation limits
 curve B in the graph
 the compensation must be enabled during start-up

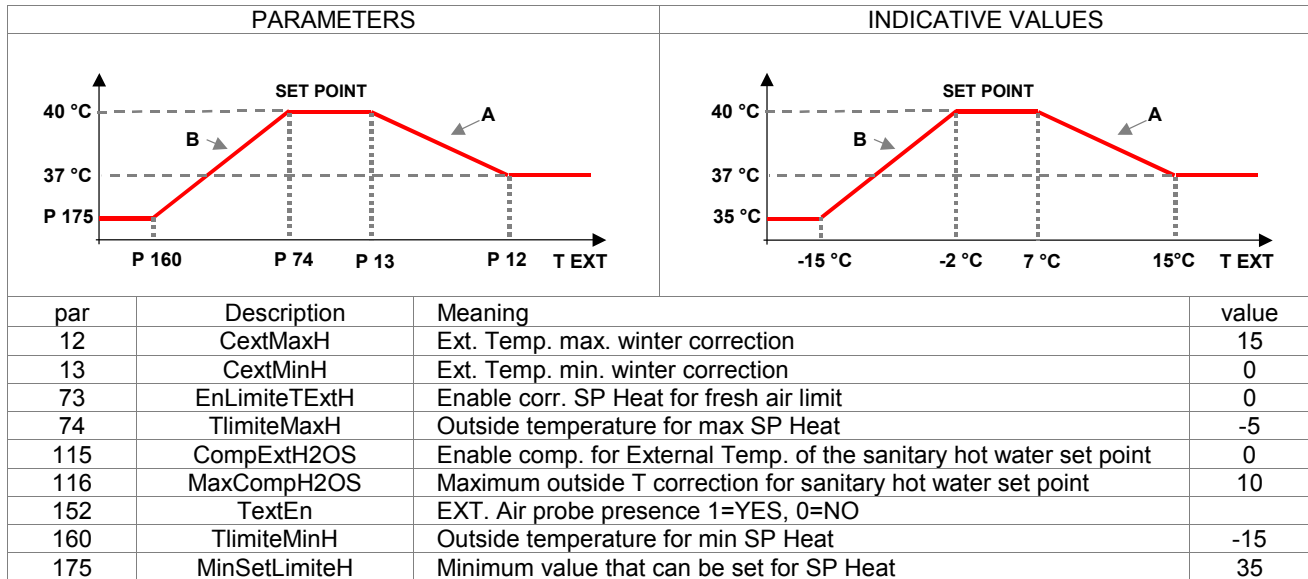

9. DUAL CONTROLS FOR TEMPERATURE – RADIANT PANELS

It is necessary the expansion **plug-in module** that must be fitted by the client (r refer to the kit instructions) and enabled by parameter 140 = 1.

With the optional kit, the mixed elements can be controlled: fan coils + radiant panels:

- Radiant panel circulator
- Mixing valve (0-10 volt or ON-OFF)
- Delivery probe (NTC type, 10 Kohm at 25°C)
- External control: COOLING/HEATING LIMIT (avoids dew / overheating).

ATTENTION: to prevent dew in summer or superheating in winter, it is very important to fit an external device and interface it with the unit that in case of signalling will force the recycling valve on the radiant panels

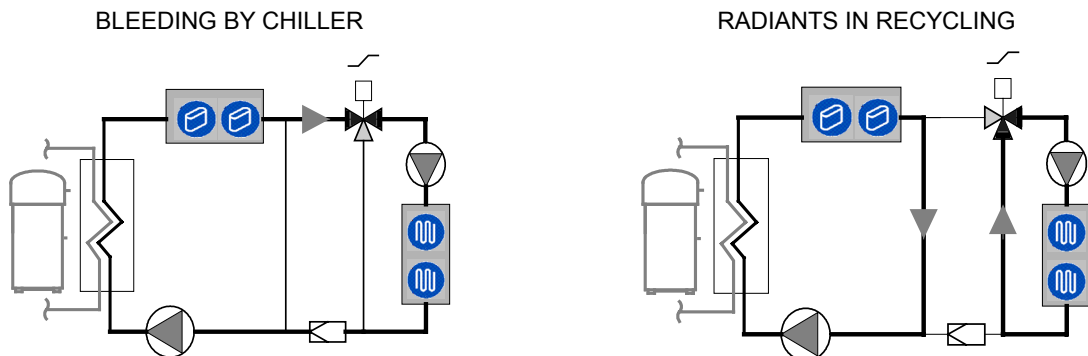

Output status on the optional plug-in module

valv 0-10	10 volt	valv 0-10	0 volt
3-point valve	out 22-23 = ON	3-point valve	out 22-23 = OFF
	out 22-25 = OFF		out 22-25 = ON

The water set point at the radiant panels can be managed in three ways:

1. the valve is managed to maintain the supply temperature at par 192 value.
2. calculated automatically in function of the fresh air temperature; two set are calculated. This configuration is obtained setting par 190=1

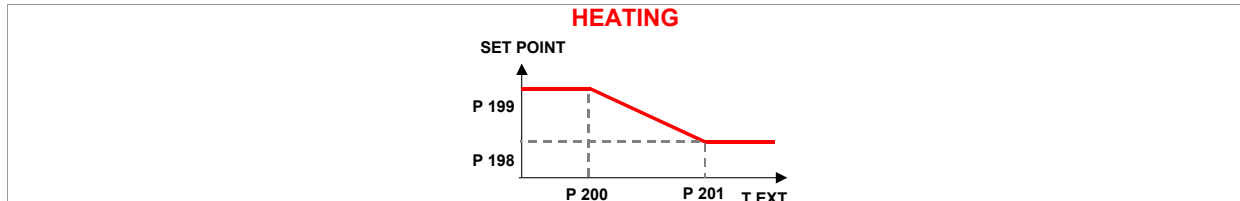

3. the installation maintains the summer set point at a value higher than the critical one, to avoid the dew formation on the floor. The unit can be connected via MODBUS to an external device (for example ELFOCONTROL) that transmits the temperature values and the ambient humidity. This configuration is obtained setting par 191 = 1.

If the unit is at service of an installation only for radiant panels (without mixing valve and fan coil) modify the following pump configuration parameters:

par	Description	Original value	Correct value
183	MaxTempC	12	8
184	MinTempH	12	8
185	IstTempC	4	2
186	IstTempH	4	2

10. SET POINT COMPENSATION WITH 4-20 mA SIGNAL (WATER RESET)

It optimizes the energetic efficiency of the unit by automatically changing the set-point according to an external signal of 4-20 ma type. It requests the **expansion plug-in module** option that must be fitted by the client (refer to the kit instructions) and enabled by parameter 140 = 1. This function must be enabled with parameter18 (=0 not enabled, =1 only summer, = 2 only winter, = 3 summer and winter).

par	Description	Meaning	value
18	WaterReset	Water Reset enabling 0=No 1=Cool 2=Heat 3=Always	0
19	MaxCWRH	Max. value of the Winter WR correction	10
20	SWRMAXH	Corresponding signal of the winter max. correction	4
21	SWRMinH	Corresponding signal of the winter min. correction	20
140	PlugInEn	Enables PLUG-IN presence . 1=YES / 0=NO	

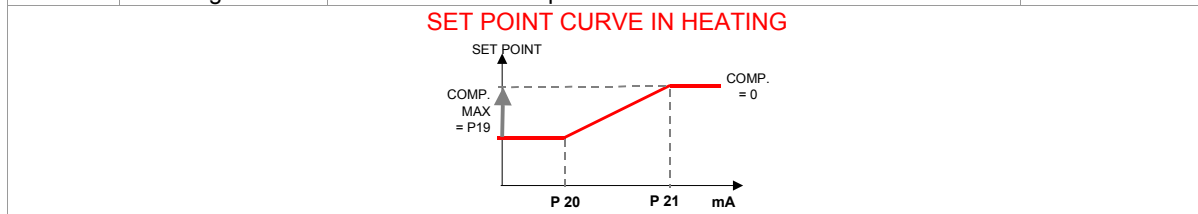

11. SET POINT COMPENSATION ON THE TEMPERATURE OR EXTERNAL ENTHALPY

Optimises unit energy efficiency by automatically adjusting the set-point according to enthalpy or the outside temperature. Requires the **external humidity probe** or the **outside temperature probe**, which are optional for certain types of units and must be installed by the customer and enabled by parameters 152=1 and 156=1.

par	Description	Meaning	value
9	CompExt	External temp. comp. enabling 0=No 1=Cool 2=Heat 3=Always	0
12	CextMaxH	Ext. Temp. max. winter correction	15
13	CextMinH	Ext. Temp. min. winter correction	0
15	MaxCExtH	Winter correction max. value	10
16	HExtMinC	Ext. enthalpy min. correction	10,5
17	HExtMaxC	Ext. enthalpy max. correction	13,5
152	TextEn	EXT. Air probe presence 1=YES, 0=NO	
156	URProbeExt	Enables external UR% probe. 1=YES, 0=NO	

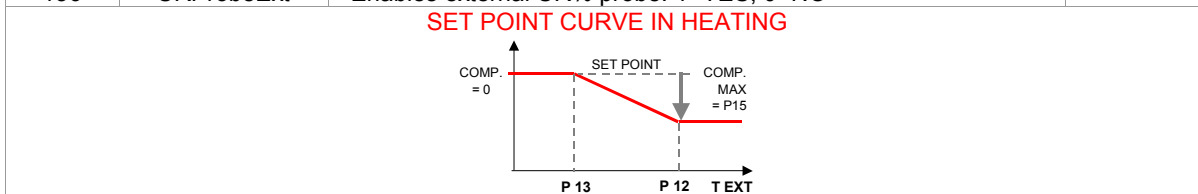

12. UNIT INTERFACING VIA RS 485

Below the indications for the serial connection ; refer anyway to the CLIVET "RS 485 NETWORKS – GUIDELINES" document and ask for the COMMUNICATION PROTOCOL about the COMPACT electronics

- The total length of each single serial line, don't have to be over 1000 metres
- The potential difference between the "ground" of two RS485 switches must be less of 7 V
- The total length of each single serial line, don't have to be over 1000 metres
- The potential difference between the "ground" of two RS485 switches must be less of 7 V

TYPE OF NETWORK

The serial lines must be connected in bus typology, i.e. nodes to more points are not admitted

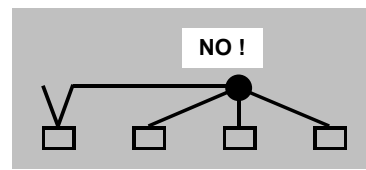
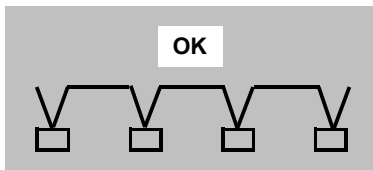

SHIELD

- It must be connected to a ground without disturbances
- Connected to ground in only one point
- Provide to the shield continuity during all the serial cable extension.

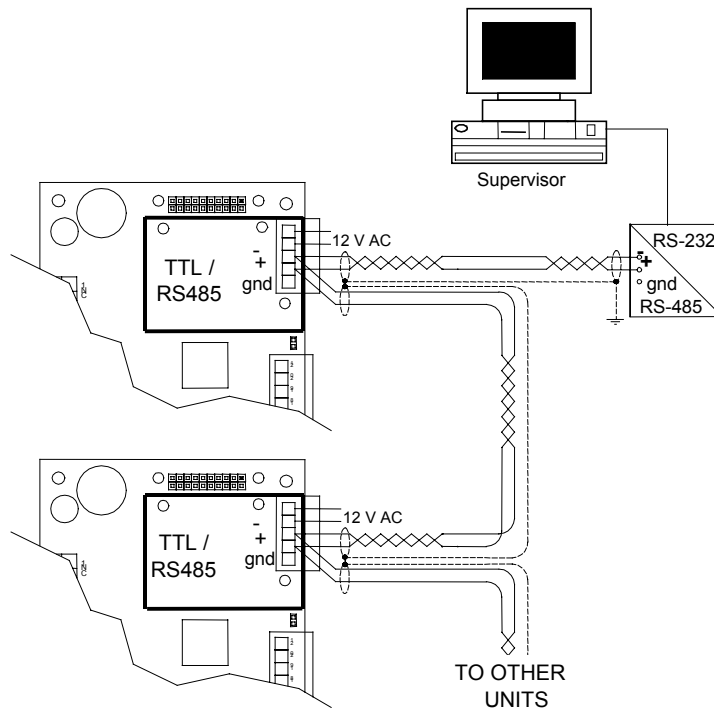
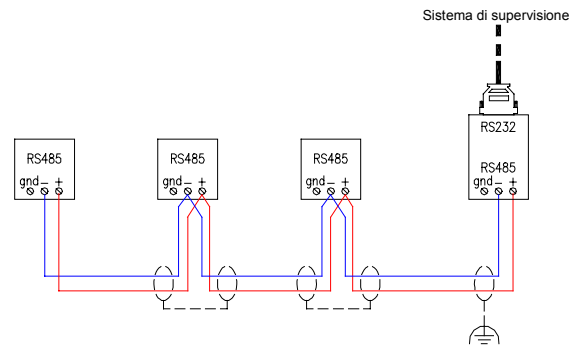

START-UP

ALL THE EQUIPMENT MUST BE COMMISSIONED BY AUTHORISED SERVICE CENTRES.
THIS SERVICE IS LIMITED TO START-UP OF THE UNIT ONLY AND NOT THE CONNECTIONS OR INSTALLATION OF THE SYSTEM.

ONLY QUALIFIED TECHNICIANS MUST PERFORM THE FOLLOWING OPERATIONS.

PRELIMINARY CHECKS

Before checking, please verify the following

1. the unit should be installed properly and in conformity with this manual.
2. the electrical power supply line should be sectioned at the beginning.
3. the sectioning device is locked and the proper warning "not to operate" sign is placed on the handle.
4. make sure no tension is present
5. the coils must be clean and free of obstacles
6. the ventilators must be free of leaves, cardboard, fixed obstacles (beams, barriers, etc.), snow, etc
7. the external ventilators must not be blocked
The external ventilators can be subject to a temporary block, especially if the inactivity period before the first start-up was quite long or if outside temperature is very low. It is also possible to unblock them manually (ONLY WHEN THE UNIT IS UNPLUGGED – RISK OF INJURES) so that jams or electric overloads are avoided when the unit is restarted.

REFRIGERANT SYSTEM

Carefully check the refrigerating circuit: the presence of oil stains can mean leakage caused by transportation, movements or other).

Open the cocks of the refrigerator circuit, if there are any.

Using the unit manometers, if present, or service manometers, verify that the refrigerating circuit is in pressure.

Make sure that all the service outlets are closed with proper caps; if caps are not present a leak of refrigerant can be possible.

WATER SYSTEM

Ensure that the plumbing system has been washed. Drain the wash water before connecting the unit to the system.

Check that the water circuit has been filled and pressurised.

Perform a seal check at max. working pressure checking that no leaks are present.

Check that the shut-off valves in the circuit are in the "OPEN" position.

Check that there is no air in the circuit. If required, bleed it using the vent valves in the system.

Check that there are no ARIES EFFECTS in the transient (pump and / or valve activation/deactivation)

When using antifreeze solutions, make sure the glycol percentage is suitable for the type of use envisaged.

% weight of ethylene glycol	10 %	20 %	30 %	40 %
Freezing point	- 4 °C	- 9 °C	- 15 °C	- 23 °C
Safety temperature	- 2 °C	- 7 °C	- 13 °C	- 21 °C

Check that the circulator pumps are not blocked. In fact, their motor shaft may seize up, especially after long shutdowns. Unblocking can be accomplished with a screwdriver using the purge hole.

ELECTRICAL SYSTEM

Check the proper tightening of the screws that fix the conductors to the electrical components in the board (during handling and transportation, the vibrations could have loosened them).

Verify that the unit is connected to the ground plant.

Control that all panels and protection devices of the unit are repositioned and blocked.

Charge the unit by closing the sectioning device, but leave it on OFF.

Make sure that the tension and net frequency values are within the limit of:

230 +/- 6% single phase unit; 400/3/50 +/- 6% three-phase unit

Control the unbalancing of the phases: it must be lower than 2% .

Example:

L1 - L2 = 388 V, L2 - L3 = 379 V, L3 - L1 = 377 V

average of the measured values = $(388 + 379 + 377) / 3 = 381$

maximum deviation from the average = $388-381 = 7V$

Unbalancing = $(7/381) \times 100 = 1.83\% = \text{ACCEPTABLE}$

Operating out of the indicated limits causes the loss of the guarantee as well as very serious damages.

IF THE CRANKCASE RESISTANCES ARE FITTED

when the unit is started up for the first time and following all prolonged periods of inactivity is OBLIGATORY to connect the oil resistances on the compressor crankcase at least 8 hours before the compressor is to be started.

BEFORE POWERING THE RESISTANCES, OPEN THE COMPRESSORS COCKS, IF PRESENT.

To supply the resistances is necessary to switch off the isolator switch on the unit.

To make sure that the resistances are working, check the power input with amperometric pliers.

At start-up the compressor crankcase temperature on the lower side must be higher at least of 10°C than the outside temperature.

DO NOT START THE COMPRESSOR WITH THE CRANKCASE OIL BELOW OPERATING TEMPERATURE.

VERIFY TENSIONS – ABSORPTIONS

Check that the temperatures of the fluids are included in the WORKING LIMITS.

If the controls of the previous paragraphs are positive, it is possible to restart the unit.

For information on the control panel, refer to the paragraph CONTROL.

While the unit is working (ATTENTION ELECTRIC RISK: WORK SAFELY) check:

- Power supply tension
- Phase unbalance
- Total absorption of the unit
- Absorption of the single electric loads

UNIT EQUIPPED WITH SCROLL COMPRESSORS

The GENERAL TECHNICAL DATA table shows the type of compressor on the unit.

The Scroll compressors have only one direction of rotation.

In the event that the direction is reversed, the compressor will not be damaged, but its noisiness will increase and pumping will be negatively affected. After a few minutes, the compressor will stop because of the activation of the thermal protection. In this event, cut the power and reverse the 2 phases on the machine power.

Prevent the compressor from working with in reverse rotation: more than 2-3 anomalous starts up can damage it.

Make sure the direction of rotation is correct, measure the condensation and suction pressure. Pressure must clearly differ: at the start, the suction pressure decreases whilst the condensation pressure increases.

The phase optional monitor, which controls the phase sequence, can be installed later.

REMOTE INPUT CONFIGURATIONS

Check used remote inputs are activated (ON-OFF etc.) as given in the instructions in the ELECTRIC WIRING chapter.

SETTING THE SET-POINT

Check if it is necessary to modify the set-points shown in the CONTROL chapter

EVAPORATOR WATER FLOW RATE

Check that the difference between the temperature of exchanger return and supply water corresponds to power according to this formula:

unit cooling power (kW) x 860 = Dt (°C) x flow rate (L/h).

The cooling power is shown in the TABLE ON GENERAL TECHNICAL DATA included in this manual, referred to specific air/water conditions, or in the tables on cooling PERFORMANCE IN THE TECHNICAL BULLETIN referred to various conditions of use.

Check for water side exchanger pressure drops:

- Determine the water flow rate.
- Measure the difference in pressure between exchanger input and output and compare it with the graph on WATER SIDE EXCHANGER PRESSURE DROPS.

The measurement of pressure will be easier if pressure gauges are installed as indicated in the DIAGRAM OF SUGGESTED WATER CONNECTIONS .

REFRIGERANT CIRCUIT PARAMETER CHECK

Detecting the operational conditions is useful to control the unit along time: the performed records must be kept and be available during maintenance interventions.

When the unit works in stable conditions and according to the operating limits, take note of the following data:

1. compressor discharge temperature (WARNING – BURN DANGER)
2. condensing pressure
3. liquid temperature
4. dehydrator filter upstream and downstream temperature
5. return pressure
6. return temperature
7. exchanger input water temperature
8. exchanger output water temperature
9. fresh air temperature (coil input)
10. air temperature coming out from fans

CONTROL

USER KEYPAD

The keyboard allows visualizing and changing the functioning conditions of the unit.
The service keyboard is needed to visualize or modify the functioning parameters.

BUTTON FUNCTION

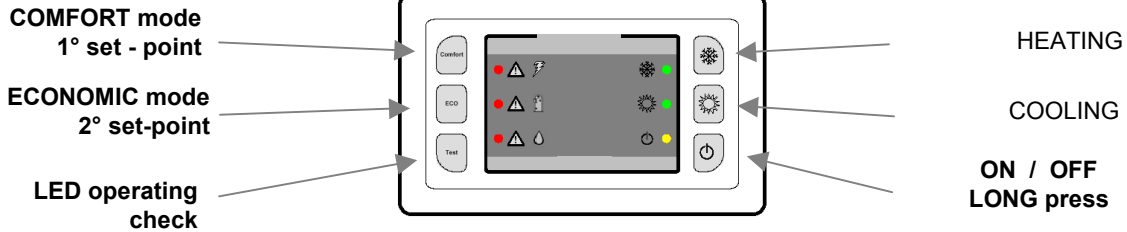

LED MEANING

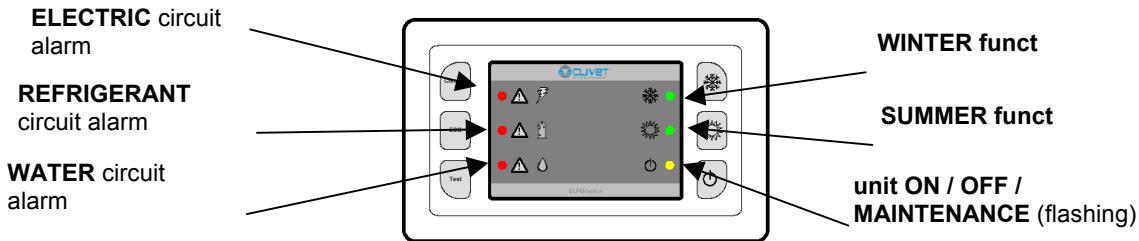

SANITARY HOT WATER PRODUCTION SIGNAL

For the machine types that manage sanitary hot water production, the status is displayed with the WINTER and SUMMER operation LEDs:

 WINTER	 SUMMER
ON	FLASHING

ON - OFF

The ON-OFF control from the keyboard allows activating or deactivating the normal functioning of the unit.

SETTING THE OPERATING MODE

COOLING: to set the SUMMER operating mode, press the  key for a few moments. When the mode has been activated, the corresponding green led lights up.

HEATING: to activate the WINTER operating mode, press the  key for a few moments.

When the mode has been activated, the corresponding green led lights up.

MAINTENANCE: The operating mode leds remain alight even when the machine is in the maintenance status. The maintenance set-points (if activated) control the water temperature when the unit is OFF or on STANDBY. To do this, the circulation pump is periodically activated, which tests the water temperature and activates the compressor if required.

SELECTING OPERATING TEMPERATURE

COMFORT: to select the COMFORT temperature for the current operating mode, press the COMFORT key. The set point is only displayed on the machine.

When this mode is activated, the led to the left of the key lights up and remains alight.

ECO: to select the ECONOMIC temperature for the current operating mode, press the ECO key.

In the winter this reduces the set point and increases it in the summer.

When this mode is activated, the green led to the left of the key flashes slowly.

ALARMS

FLASHING LED: there is an anomaly at the AUTOMATIC reset

FIXED LIGHT LED: there is an anomaly at the MANUAL reset

ALARM RESET: TEST + ON/OFF keys pressed simultaneously for more than 2 seconds.

Alarm type:



ELECTRICAL CIRCUIT ALARM

Return probe
Supply probe
Radiant panel water probe
Coil/flow probe
External probe
Pressure 1 probe
Water reset return
External relative humidity probe
Phase monitor
Electric resistance output probe

Allarme serial faulty



REFRIGERANT CIRCUIT ALARM

HP
LP
CCMP/VENT
HP1 Pre-Alarm
BP1 Pre-Alarm

Allarme serial faulty



WATER CIRCUIT ALARM

Flow pump
System charged with water
Antifreeze alarm
Antifreeze PREAlarm
Pump alarm
C1 PREAlarm
PRad. Cooling limit alarm
PRad. Water frost alarm
Coil frost alarm
Alarm ?T° incongruous
Electric resistance antifreeze alarm
Allarme serial faulty

FUNCTIONING TEST

The "Test" key allows the verification of the proper functioning of the all six signalisation LEDs. When it is pressed, all leds are ON until the key is released.

REMOTE OR SERVICE KEYPAD (OPTIONALS)

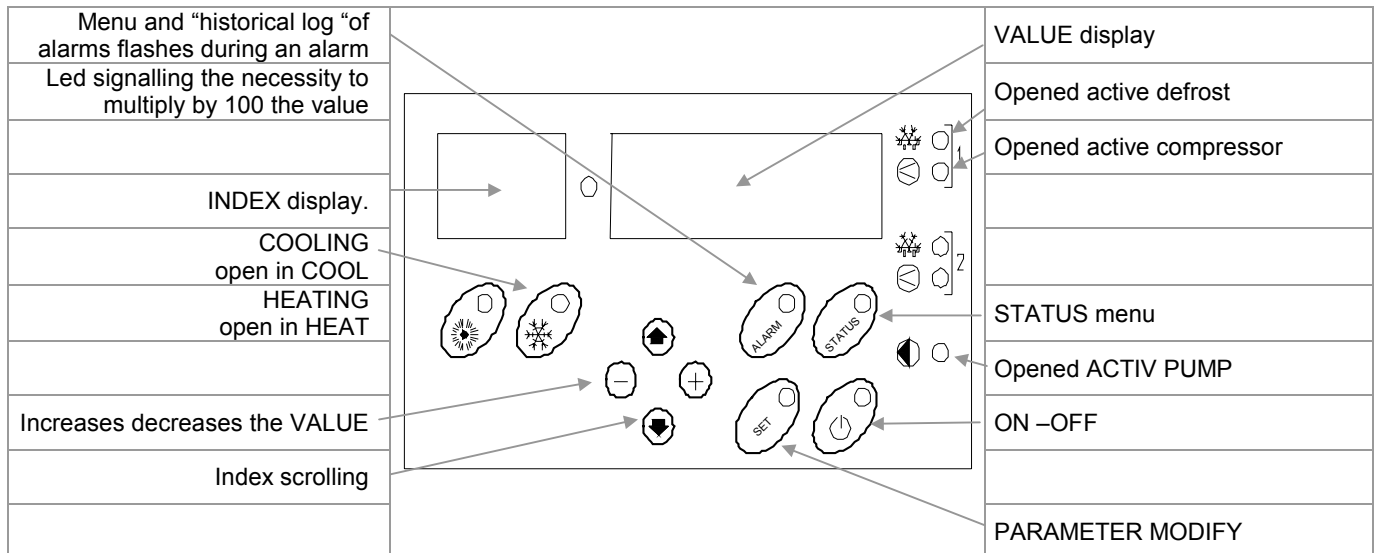

1



unit in OFF.
by keypad
by supervisor

2

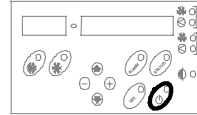

switching: long ON -
OFF
pressure

3

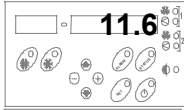

SUPPLY temperature
visualization

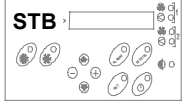

Unità in :

- MANTEINTENANCE or
- In TRANSITION mode (for ex. from heating to cooling or to sanitary H2O)

ACCESSIBLE PARAMETERS FROM REMOTE OR SERVICE KEYBOARD

num. Par.	Description	Value	UM
29	Summer secondary Set Point	10	°C
30	Winter secondary Set Point	35	°C
32	Summer Set Point	5.7	°C
33	Winter Set Point	41.2	°C
42	Summer Set Point Maintenance	20	°C
43	Winter Set Point Maintenance	30	°C
44	Enables Summer Maintenance	0	num
45	Enables Winter Maintenance	0	num
77	Antifreeze resistance set point	4	°C
80	Antifreeze alarm	4	°C
84	Limit of deactivation before reaching the antifreeze steps	4.5	°C
117	Sanitary water set point	35	°C
163	Configures remote inputs: 1 = H/C by keypad or supervisor		
216	Keypad address on Clivet Bus net: 7 =local; 1=remote	0	num

PARAMETER MODIFICATION

1

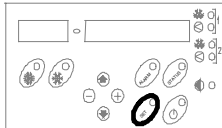

Push SET button

2

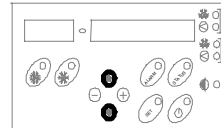

Select the
parameter

3

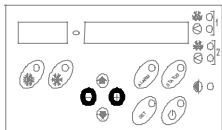

Modify the value

4

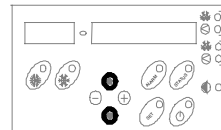

Select another
parameter

5

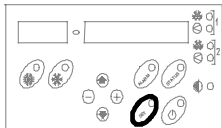

SET to esc

VISIBLE STATUS FROM REMOTE KEYBOARD OR SERVICE KEYBOARD

UNIT STATA MENU		
INDICE	DESCRIPTION	VALUE
1	Current Set Point	°C
2	Temperature drop in degrees centigrade given by the compressor including compensations, if any	°C
3	Resource activation timer When this value reaches the value fixed at the next status (TimeScan), the thermal regulator will compare the input temperature with the set point and will activate the resources (compressor and/or resistances)	Seconds
4	Dynamic TimeScan relating to source activation	Seconds
5	Value in degrees of the fresh air compensation	°C
6	Value in degrees of the water reset signal compensation	°C
7	summation CompCar + CompOn + CompDuty	°C
8	Value in degrees of the duty-cycle compensation	°C
9	Return temperature	°C
10	Supply temperature	°C
11	Water temperature of refreshing panel	°C
12	Coil temperature (if condensing in water becomes condenser antifreeze probe)	°C
13	Condensing pressure	Bar
14	Fan/Coil percentage 1	0-100%
15	Resistance output temperature	
18	Water Reset signal value	4-20 mA
19	Outdoor temperature	°C
20	Outdoor Humidity	0-100%
21	Machine Clock – (only fed unit hours)	Num
22	Working hours C1	Num
23	Pickups C1	Num
24	Radiant panel valve status	ON-OFF
25	Radiant panel valve status	%
26	Pump percentage	%
27	Integration resistance status	ON-OFF
28	Refreshing panel valve (Out-1)	ON-OFF
29	Radiant set Point	°C
30	Keypad software	EJ – t (ELFO Junior – keypad)
31	Year of certification of the keyboard SW	2007
32	Month of certification of the keyboard SW	04
33	Day of certification of the keyboard SW	03
34	Base Software	EJ – b (ELFO Junior – base)
35	Year of certification of the keyboard SW	2007
36	Month of certification of the keyboard SW	03
37	Day of certification of the keyboard SW	14

STATUS DISPLAY

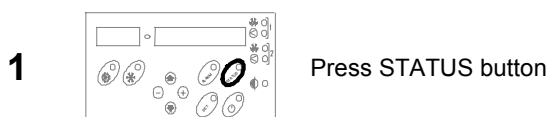

ALARMS

BEFORE RESETTING THE ALARM, IDENTIFY AND ELIMINATE THE CAUSE OF ITS ACTIVATION.

REPEATED RESETS CAN CAUSE IRREVERSIBLE DAMAGES.

The **ALARMS** show a potentially dangerous situation for machine safety.

Before resetting the alarm, discover and remove the cause: repeated resetting could cause irreversible damage. To avoid this, the unit can only be reset **MANUALLY** from the keyboard (only when the cause for the alarm has been removed).

PRE-ALARMS and SIGNALS warn of a risky situation. These could be acceptable only if they happen occasionally or in transitory situations (for example when the plant is being started up).

They are reset **AUTOMATICALLY**, as soon as the cause has been removed, without any input from the keyboard.

The pre-alarms are signalled by the fixed C code (not flashing) and on the right the control temperature.

The **FAULTS** warn of problems with the probes and transducers, and are reset **AUTOMATICALLY** to allow the unit to continue running, perhaps with fewer functions.

In case of doubt, always contact an authorised service centre.

The presence of an alarm is signalled by the **ALARM CODE** flashing and the time at which the alarm/alarms occurred.

The cumulative block relay activates simultaneously to the alarm code visualization.

Certain alarms, in particular **PRE-ALARMS**, do not activate the relays.

The complete list of alarms is provided below; depending on the machine type and its configuration, some of the codes shown may not be used.

E	00	Serial faulty - comunicazione tastiera / scheda base	Auto.
E	1	Faulty or disconnected water return probe	Auto.
E	2	Faulty or disconnected water supply probe	Auto.
E	3	Faulty or disconnected radiating panel water probe (radiating panel option)	Auto.
E	4	Faulty or disconnected coil probe	Auto.
E	5	Electric resistance output probe	Auto.
E	6	Faulty or disconnected external probe	Auto.
E	7	Faulty or disconnected pressure transducer	Auto.
E	8	Plug-in pressure probe	
SC	9	Water Reset return in short circuit or out of range	Auto.
E	10	Faulty or disconnected external RH% probe	Auto.
E	11	High pressure	MANUAL
E	12	Low pressure	Auto.
E	13	Condensing fan and/or compressor thermal switch	MANUAL
E	14	Electric resistance antifreeze alarm	MANUAL
E	17	Pump flow	Auto.
E	18	System charged with water	MANUAL
E	19	Phase monitor	Auto.
E	20	Antifreeze alarm	MANUAL
CS	21	Antifreeze PREAlarm	Auto.
CS	22	High pressure PreAlarm	Auto.
CS	24	Pump change	Auto.
E	25	flow alarm C1	Auto.
E	30	Coil frost alarm	MANUAL
E	31	Cooling limit alarm (radiating panel option)	Auto.
E	32	Water frost alarm (radiating panel option)	Auto.
E	33	Incongruent DeltaT alarm	MANUAL
S/EC	34	Low pressure pre-alarm	Auto.
C / E	35	Return water temperature over threshold after cooling / sanitary hot water switching and vice versa	Auto
C	36	Incongruent sanitary H2O thermostat	Auto

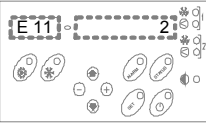
- 

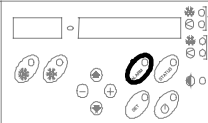
1 flashing
Alarm code
Alarm unit hours
- 

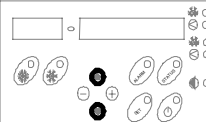
2 opened alarm log
short pressure
ALARM
- 

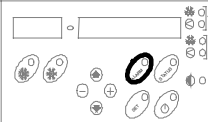
3 The most recent alarm is
visualized
Use the arrow keys to
visualize other alarms
- 

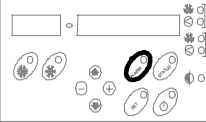
4 To esc
Short pressure
ALARM
- 

5 To RESET
LONG pressure
ALARM

ROUTINE MAINTENANCE

BEFORE UNDERTAKING ANY SORT OF MAINTENANCE OR CLEANING, DISCONNECT THE ELECTRICAL POWER SUPPLY TO THE UNIT, AND ENSURE THAT OTHER PEOPLE CANNOT RE-CONNECT IT .

All equipment is subjected to wear out.

The maintenance makes :

1. keeps the unit efficiency
2. the components last longer
3. keeps their efficiency and limits breakdowns

Therefore, it is fundamental to perform periodical checks: a few controls can be performed by the user (AUTONOMOUS MAINTENANCE) and they are mainly

cleaning activities; otherwise, controls have to be performed by specialized technicians (INSPECTIONS).

The machine should have a log book used to keep track of the performed controls. This will make fixing up breakdowns easier.

Take note of the date, type of control (autonomous maintenance, inspection or fixing up), description of the control, actions taken and so on.

SERVICES

Parts subject to intervention:

- FRESH AIR COIL
- WATER CONDENSER
- STRUCTURE
- EXTERNAL FANS

FRESH AIR COIL

ATTENTION: contact with the exchanger fins can cause cuts. Wear protective gloves to perform the above described operations.

It is extremely important that the battery gives the maximum thermal exchange; therefore, its surface must be cleaned from dust and deposits. Remove all impurities from the surface.

Using an air pressure gun, clean the aluminum surface of the battery. Be careful to direct the air in the opposite

direction of the fan air movement. Hold the gun parallel to the fins to avoid damages. As an alternative, an aspirator can be used to suck impurities from the air input side.

Verify that the aluminum fins are not bent or damaged. In the event of damages, contact the authorized assistance center and get the battery "ironed out" in order to restore the initial condition for an optimal air flow.

WATER EXCHANGER

It is very important for the exchanger to be able to provide the maximum thermal exchange. Therefore, it is essential for the inner surfaces to be clean of dirt and incrustations.

Periodically check the difference between the temperature of the supply water and the condensation temperature. If the difference is greater than 8 °C – 10 ° C it is advisable to clean the exchanger.

STRUCTURE

Check the condition of the parts making up the structure. Paint so as to eliminate or reduce oxidation at the points in the unit where this problem may occur. Check that the

panelling is fastened correctly. Poor fastening may give rise to malfunctions and abnormal noise and vibration.

ELECTRIC FANS

Make sure that the fans and the relative protection grids are well fixed.

Check, if possible, the unbalances of the electro-fan evident by noise and anomalous vibrations. Verify that the terminal protection covers are closed and the cable holders are properly positioned.

MAINTENANCE INSPECTIONS

Foresee inspection assistance carried out by authorized centers or by qualified personnel.

The inspections should be carried out at least:

- - Every year for only the cooling units
- - Every six months for the cooling and warming units

The frequency, however, depends on the use: in the event of frequent use (continuous or very intermittent use, near the operating limits, etc) or critical use (service necessary) it is recommended to plan inspections at close intervals.

The inspections to be performed are as follows:

- verify the power supply tension (when emptied or filled)
- inspect the electrical board (status of solenoid starter contacts, terminal closings, the status of wiring and relevant insulations)
- inspect the absorption of the single electrical loads
- verify the cleaning and the efficiency of the exchangers
- inspect the cleaning of the filters (air/water)

- verify the leakage from the refrigerating circuit
- Verify the protection devices (safety valves, pressure switches, thermostats, etc.), the adjustment systems, the control devices (alarm signalizations, probes, manometers, etc)
- check the operating parameters of the refrigerating circuit (see the following REFRIGERANT TABLES and the START-UP section)

For units equipped with safety valves, follow the Manufacturer's instructions.

Verify periodically the cleaning of the safety valves and that oxidative / corrosive phenomena are not present, in particular for installations near the sea, in industrial areas or in rooms with a corrosive atmosphere.

97/23 CE PED DIRECTIVE

97/23 CE PED DIRECTIVE gives instructions for installers, users and maintenance technicians as well. Refer to local actuation norms.

In Italy, refer to the Ministerial Decree of 1st December 2004 no. 329 (and following modifications) which defines the performances to be executed; the units of 1st category and those defined by the art. 3.3 97/23/EC are not included in this regulation (see the serial number plate on the unit) .

Briefly and as an example, see the following :

1. COMPULSORY VERIFICATION OF THE FIRST INSTALLATION only for units assembled on the installer's building site (for ex. Condensing circuit + direct expansion unit)
2. CERTIFICATION OF SETTING IN SERVICE for all the units
3. PERIODICAL VERIFICATIONS to be executed with the frequency indicated by the Manufacturer (see the MAINTENANCE INSPECTIONS paragraph)

PUT AT REST

If a long period of inactivity is foreseen, for example the winter for the cooling unit, the following is recommended:

- to turn the power off in order to avoid electrical risks or damages by lightning strike
- to avoid the risk of frosts as shown in the HYDRAULIC CONNECTIONS section, and, in particular
 - to empty or add glycole in the plant sections subjected to temperatures below zero
 - to empty or add glycole in the water heating coils, also in summer
 - to power antifreeze resistances if present

If the period of inactivity is particularly long or in the event of extremely low temperatures, the external fans can be blocked temporarily; therefore, it is recommended to switch them on every month in order to avoid seizures or electrical overloads when the unit will be switched on.

The restarting of the unit has to be carried out by qualified personnel, in particular, after the winter break for cooling units or when seasonal switching should be performed.

When restarting, refer to the SWITCHING ON section.

Schedule technical assistance in advance to avoid hitches and be able to use the installation when necessary.

REFRIGERANT TABLES

THIS SECTION IS DEVOTED ONLY TO QUALIFIED TECHNICIANS THAT KNOW THE FOLLOWING:

- THE OPERATIONAL PRINCIPLES OF THE REFRIGERATING CIRCUIT OPERATION
- THE MODES OF DETECTING TEMPERATURE AND PRESSURE
- THE RISKS RELEVANT TO THESE OPERATIONS

The data of the tables allow the testing of the refrigerating circuit operation by the detection of a few objective parameters.

The data are significant if they are detected simultaneously and while the refrigerating circuit is running.

- Liquid temperature
- Return pressure
- Return temperature
- Condensing pressure

OVERHEATING = return temperature – Saturation temperature			
	R22	R407C	R410A
Return pressure	3.8 bar	3.8 bar	7.2 bar
Return temperature	7.3 °C	7.3 °C	7.3 °C
overheating	$7.3 - (-1.13) = 8.43 \text{ °C}$	$1.3 - 1.18 = 6.12 \text{ °C}$ for calculation consider the Td (dew point)	$7.3 - 0.8 = 6.5 \text{ °C}$
SUBCOOLING = condensing temperature (pressure *) – liquid temperature			
	R22	R407C	R410A
Condensing pressure	18.6 bar	18.6 bar	29.6 bar
Liquid temp.	42.9 °C	42.9 °C	45 °C
subcooling	$50.39 - 42.9 = 7.49 \text{ °C}$	$44.74 - 42.9 = 1.84 \text{ °C}$ for calculation consider the Tb (bubble point)	$49.91 - 45 = 4.91 \text{ °C}$

* It is important that the condensation pressure is detected as close as possible to the point where the liquid temperature is detected, in the event that the calculation will be effected by the losses of charge (and, therefore, of temperature) caused by the refrigerating circuit components placed between the two measurement points.

For R410A the glide was not considered, since it is close to 0.

The values in the tables refer to a specific refrigerant supplier; slight differences are possible with other suppliers.

Pg = P gauge = relevant pressure (read on the pressure gauge)

Ts : saturation pressure

Td = dew point temperature

Tb = bubble point temperature

Pg	R407C	Td [°C]	Tb [°C]	Pg	R407C	Td [°C]	Tb [°C]	Pg	R407C	Td [°C]	Tb [°C]	Pg	R407C	Td [°C]	Tb [°C]
0.0	-36.90	-43.90		11.0	30.73	25.30		22.0	56.00	51.63		33.0	72.94	69.73	
0.2	-33.11	-40.05		11.2	31.32	25.92		22.2	56.36	52.01		33.2	73.21	70.02	
0.4	-29.80	-36.67		11.4	31.91	26.52		22.4	56.72	52.39		33.4	73.47	70.30	
0.6	-26.83	-33.65		11.6	32.49	27.12		22.6	57.08	52.77		33.6	73.72	70.58	
0.8	-24.15	-30.92		11.8	33.07	27.72		22.8	57.43	53.14		33.8	73.98	70.87	
1.0	-21.69	-28.41		12.0	33.63	28.30		23.0	57.79	53.51		34.0	74.24	71.15	
1.2	-19.41	-26.09		12.2	34.19	28.88		23.2	58.14	53.88		34.2	74.49	71.43	
1.4	-17.29	-23.93		12.4	34.75	29.46		23.4	58.48	54.25		34.4	74.75	71.70	
1.6	-15.31	-21.90		12.6	35.30	30.03		23.6	58.83	54.62		34.6	75.00	71.98	
1.8	-13.44	-19.99		12.8	35.84	30.59		23.8	59.17	54.98		34.8	75.25	72.26	
2.0	-11.66	-18.19		13.0	36.37	31.14		24.0	59.51	55.34		35.0	75.50	72.53	
2.2	-9.98	-16.47		13.2	36.90	31.69		24.2	59.85	55.70		35.2	75.75	72.81	
2.4	-8.38	-14.83		13.4	37.43	32.23		24.4	60.19	56.05		35.4	75.99	73.08	
2.6	-6.85	-13.27		13.6	37.95	32.77		24.6	60.53	56.41		35.6	76.24	73.35	
2.8	-5.38	-11.77		13.8	38.46	33.31		24.8	60.86	56.76		35.8	76.48	73.62	
3.0	-3.97	-10.33		14.0	38.97	33.83		25.0	61.19	57.11		36.0	76.73	73.89	
3.2	-2.61	-8.94		14.2	39.47	34.35		25.2	61.52	57.46		36.2	76.97	74.16	
3.4	-1.31	-7.61		14.4	39.97	34.87		25.4	61.84	57.81		36.4	77.21	74.43	
3.6	-0.04	-6.31		14.6	40.46	35.38		25.6	62.17	58.15		36.6	77.45	74.69	
3.8	1.18	-5.06		14.8	40.95	35.89		25.8	62.49	58.49		36.8	77.69	74.96	
4.0	2.36	-3.85		15.0	41.43	36.39		26.0	62.81	58.83		37.0	77.92	75.22	
4.2	3.51	-2.68		15.2	41.91	36.89		26.2	63.13	59.17		37.2	78.16	75.49	
4.4	4.62	-1.54		15.4	42.39	37.39		26.4	63.45	59.51		37.4	78.39	75.75	
4.6	5.71	-0.43		15.6	42.86	37.87		26.6	63.76	59.85		37.6	78.62	76.01	
4.8	6.76	0.65		15.8	43.32	38.36		26.8	64.07	60.18		37.8	78.86	76.27	
5.0	7.79	1.70		16.0	43.78	38.84		27.0	64.38	60.51		38.0	79.09	76.53	
5.2	8.79	2.73		16.2	44.24	39.32		27.2	64.69	60.84		38.2	79.31	76.79	
5.4	9.77	3.73		16.4	44.69	39.79		27.4	65.00	61.17		38.4	79.54	77.05	
5.6	10.72	4.71		16.6	45.14	40.26		27.6	65.31	61.50		38.6	79.77	77.31	
5.8	11.65	5.67		16.8	45.59	40.72		27.8	65.61	61.82		38.8	79.99	77.56	
6.0	12.56	6.60		17.0	46.03	41.18		28.0	65.91	62.14		39.0	80.22	77.82	
6.2	13.46	7.52		17.2	46.47	41.64		28.2	66.21	62.46		39.2	80.44	78.07	
6.4	14.33	8.41		17.4	46.90	42.09		28.4	66.51	62.78		39.4	80.66	78.33	
6.6	15.18	9.29		17.6	47.33	42.54		28.6	66.81	63.10		39.6	80.88	78.58	
6.8	16.02	10.15		17.8	47.76	42.99		28.8	67.10	63.42		39.8	81.10	78.83	
7.0	16.85	11.00		18.0	48.18	43.43		29.0	67.40	63.73		40.0	81.31	79.08	
7.2	17.65	11.83		18.2	48.60	43.87		29.2	67.69	64.05		40.2	81.53	79.33	
7.4	18.45	12.64		18.4	49.02	44.30		29.4	67.98	64.36		40.4	81.74	79.58	
7.6	19.22	13.44		18.6	49.43	44.74		29.6	68.27	64.67		40.6	81.95	79.83	
7.8	19.99	14.23		18.8	49.84	45.16		29.8	68.56	64.98		40.8	82.16	80.08	
8.0	20.74	15.00		19.0	50.25	45.59		30.0	68.84	65.29		41.0	82.37	80.33	
8.2	21.48	15.76		19.2	50.65	46.01		30.2	69.13	65.59		41.2	82.58	80.57	
8.4	22.20	16.51		19.4	51.05	46.43		30.4	69.41	65.90		41.4	82.79	80.82	
8.6	22.92	17.25		19.6	51.45	46.85		30.6	69.69	66.20		41.6	82.99	81.06	
8.8	23.62	17.97		19.8	51.85	47.26		30.8	69.97	66.50		41.8	83.19	81.31	
9.0	24.32	18.69		20.0	52.24	47.67		31.0	70.25	66.80		42.0	83.40	81.55	
9.2	25.00	19.39		20.2	52.63	48.08		31.2	70.52	67.10		42.2	83.60	81.80	
9.4	25.67	20.08		20.4	53.01	48.49		31.4	70.80	67.40		42.4	-	-	
9.6	26.34	20.77		20.6	53.39	48.89		31.6	71.07	67.69		42.6	-	-	
9.8	26.99	21.44		20.8	53.77	49.29		31.8	71.34	67.99		42.8	-	-	
10.0	27.63	22.11		21.0	54.15	49.69		32.0	71.61	68.28		43.0	-	-	
10.2	28.27	22.76		21.2	54.53	50.08		32.2	71.88	68.57		43.2	-	-	
10.4	28.90	23.41		21.4	54.90	50.47		32.4	72.15	68.87		43.4	-	-	
10.6	29.51	24.05		21.6	55.27	50.86		32.6	72.42	69.15		43.6	-	-	
10.8	30.13	24.68		21.8	55.64	51.25		32.8	72.68	69.44		43.8	-	-	

TROUBLESHOOTING

THE OPERATIONS MUST BE CARRIED OUT BY TECHNICAL QUALIFIED PERSONNEL HAVING THE REQUISITES UNDER LAW REQUISITES AND IN CONFORMITY WITH THE SAFETY REGULATIONS IN FORCE.

THE INTERVENTIONS WITHIN THE WARRANTY PERIOD WILL BE CARRIED OUT BY AUTHORIZED SERVICE CENTERS.

BEFORE RESETTING AN ALARM, IDENTIFY AND ELIMINATE ITS CAUSE.

REPEATED RESETS MAY CAUSE SERIOUS DAMAGES.

In certain machine configurations, some safeties may be placed in series and lead back to a single input on the electronic module.

Therefore, check on the electrical diagram whether the device to which the alarm corresponds has other devices or safeties connected in series.

Below is a list of the possible causes of alarms.

FAULTY PROBE

1. Identify the part on the wiring diagram.
2. Loose electric contacts/terminals, leads broken
3. Check the correct probe ohmic level (using a tester)
4. Change the probe.
5. Check the electronic module configuration (only an authorised service centre can do this)
6. Change the electronic module

FAULTY PRESSURE TRANSDUCER

1. Identify the part on the wiring diagram
2. Loose electric contacts/terminals, leads broken
3. Check the pressure test points are in working order
4. Change the part
5. Check the electronic module configuration (only an authorised service centre can do this)
6. Change the electronic module

COMPRESSOR PROTECTION

1. Identify the part on the wiring diagram
2. Loose electric contacts/terminals, leads broken
3. electrical windings interrupted
4. Vacuum power voltage below the limits
5. power contactors / contacts defective
6. start-up power voltage lower than the limits
7. electrical absorption high / unbalanced
8. High compressor discharge temperature > thermostatic device needs calibrating, insufficient refrigerant charge

HIGH PRESSURE

1. high air temperature (see operating limits)
2. high water temperature (see operating limits)
3. insufficient water flow to the exchanger (high thermal difference between input and output)
4. not CONSTANT flow (for example, if the pumps are turned off, certain areas of the plant are excluded or included, other uses are isolated, etc)
5. Water filter clean / valves open /air bubbles in the plant
6. dirty exchanger
7. Manostat/transducer: loose electric contacts/terminals, wiring cables interrupted
8. condensation gas in the cooling circuit
9. Too much refrigerant
10. Check the trigger point for the manostat and transducer
11. Check the manostat or transducer pressure control point (deposits of oil, dirt, pin blocked mechanically)

FAN PROTECTION

1. Identify the part on the wiring diagram
2. fan mechanically jammed, bearings / drive belt (if present)
3. Loose electric contacts/terminals, leads broken
4. electrical windings of fan interrupted
5. power supply voltage below limits
6. electrical absorption high / unbalanced

PUMP PROTECTION

1. Identify the part on the wiring diagram
2. pump jammed (probable for circulator pump after lengthy seasonal shutdowns)
3. Loose electric contacts/terminals, leads broken
4. electrical windings of fan interrupted
5. power supply voltage below limits
6. electrical absorption high / unbalanced

LOW PRESSURE

1. high water temperature (see operating limits)
2. high air temperature (see operating limits)
3. coil dirty / clogged
4. fans don't work / low speed
5. Manostat/transducer: loose electric contacts/terminals, wiring cables interrupted
6. Check the trigger point for the manostat and transducer
7. refrigerant circuit pressurized? visible refrigerant leakage? correct charge?
8. Blocked dehydrator filter ?
9. thermostatic device not operating correctly?
10. Check the manostat or transducer pressure control point (deposits of oil, dirt, pin blocked mechanically)

DECOMMISSIONING OF THE UNIT

DISCONNECTING THE UNIT

The units must be disconnected by authorised personnel, who before proceeding must first read the Residual Risks section in this manual.

Before disconnecting the unit, the following must be recovered, if present:

- the refrigerant (if the circuits cannot be isolated): the refrigerant must be removed using suction devices operating in a closed circuit, so as to ensure that none of the compound is released into the atmosphere.
- the antifreeze in the circuits: when removing this fluid, make sure that it does not leak and that it is not released into the environment. The antifreeze fluid must be stored in special containers.

When recovering the substances present in the unit, all measures must be taken to avoid damaging persons and things and polluting the surrounding area.

Awaiting dismantling and disposal, the unit can also be stored outdoors, as bad weather and rapid changes in temperature will not cause damage to the environment, if electric, cooling and hydraulic circuits of the unit are integral and closed.

DISMANTLING AND DISPOSAL

THE UNIT MUST ALWAYS BE SENT TO AUTHORISED CENTRES FOR DISMANTLING AND DISPOSAL.

When dismantling the unit, the fan, the motor and the coil, if operating, may be recovered by the specialist centres for reuse.

All the materials must be recovered or disposed of in compliance with the corresponding national standards in force.

For further information on the decommissioning of the unit, contact the manufacturer.

TECHNICAL DATA

Sizes			41	61	81
Heating					
Heat output	1	kW	15,3	19,8	26,7
Compressor power input	1	kW	4,07	5,32	7,23
Total power input	2	kW	4,39	5,64	7,87
COP	1		3,49	3,51	3,39
Compressor					
Type of compressors			SCROLL		
No. of Compressors		Nr	1		
Std Capacity control steps		Nr	1		
Oil charge (C1)		l	1,4	1,7	4
Refrigerant charge (C1)		kg	4	4,2	5,5
Refrigerant circuits		Nr	1		
External exhcanger					
Type of internal exchanger	3		PHE		
No. of internal exchangers		Nr	1		
Water flow-rate	4	l/s	0,63	0,79	1,06
Pump available pressure	4	kPa	37	30	110
Water content		l	2	2,2	2,7
External section fans					
Type of fans	5		AX		
Number of fans		Nr	2		4
Standard air flow	1	l/s	1780	1780	2500
Installed unit power		kW	0,16		
Connections					
Water fittings			1" Gas F		
Hydraulic circuit					
Max water side pressure		kPa	550		
Safety valve calibration		kPa	600		
Expansion vessel					
Expansion vessel capacity		l	5		
Water side max. pressure		kPa	600		
Nitrogen buffer pressure		kPa	150		
No. of expansion vessels		Nr	1		
Power supply					
STD power supply		V	230/1/50	400/3/50+N	400/3/50+N
Sound levels					
Sound pressure level (1 m) (1m)		db(A)	58	60	64
Dimensions					
Length		mm	1120	1120	1526
Depth		mm	524	524	557
Height		mm	1176	1176	1224
Standard unit weights					
Shipping weight		kg	153	160	270
Operating weight		kg	150	157	266

(1) data referred to the following conditions :

water to internal exchanger 40/45°C

fresh air temperature 6.1 °C W.B.

(2) Total input is obtained from compressor input + fan input

(3) PHE = plates

(4) data referred to the following conditions :

supply water internal exchanger 45°C

external exchanger air intake = 6.1 °C W.B.

DT=difference between return/supply water temperature=6°C

(5) AX = axial-flow fan

OPERATIVE LIMITS (HEATING)

Sizes			41	61	81
EXTERNAL EXCHANGER					
Max air temperature return	1	°C		40	
Min air return temperature (W.B.)	2	°C	-18	-17	-17
INTERNAL EXCHANGER					
Max. water supply temperature	3	°C		60	
Min. water supply temperature	4	°C		20	
Water thermal head (min / max)		°C		3/8	

Water thermal head = 5°C

ATTENTION: IN CASE OF PREDOMINANT WINDS, WINDBREAK BARRIERS ARE NECESSARY.

- (1) Dati riferiti ad aria esterna in quiete
acqua scambiatore interno = 40/45°C
- (2) acqua scambiatore interno = 40/45°C
- (3) temperatura ambiente = 7°C (U.R. = 85%)
- (4) Minima temperatura acqua in ingresso allo scambiatore 14°C per massimo 15 minuti, grazie al dispositivo di variazione della portata del circolatore (standard).

SETTING THE CUT-OUT DEVICES AND CONTROLS

		On	Off	Value
High pressure safety switch	kPa	2940	2140	--
Low pressure safety switch	kPa	700	1700	--
Antifreeze protection	°C	3	5,5	
Max compressor starts per hour	Nr	--	--	10
Safety discharge thermostat	°C	--	--	120
HP safety plug fuse	°C	--	--	124

INTEGRATED HEAT CAPACITIES

Internal exchanger return air temperature D.B. (°C)	-5 / -5.4	0 / -0.6	5 / 3.9	ALTRI
Multiplicative coefficient of the heat capacity	0.89	0.88	0.94	1

To obtain integrated heat capacities (effective heat capacity considering the possible defrosting cycles), multiply the value of kWt described in the heating performance tables for the following coefficients in the table.

FOULING CORRECTION FACTOR

m ² °C/W	INTERNAL EXCHANGER	
	F1	FK1
0.44 x 10 ^{^(-4)}	1.00	1.00
0.88 x 10 ^{^(-4)}	0.97	0.99
1.76 x 10 ^{^(-4)}	0.94	0.98

F1 = Cooling capacity correction factors

FK1 = Compressor power input correction factor

CORRECTION FACTOR FOR ANTIFREEZE SOLUTIONS

% ethylene glycol by weight		5%	10%	15%	20%	25%	30%	35%	40%
Freezing temperature	°C	-2.0	-3.9	-6.5	-8.9	-11.8	-15.6	-19.0	-23.4
Safety temperature	°C	3.0	1.0	-1.0	-4.0	-6.0	-10.0	-14.0	-19.0
Cooling Capacity Factor	Nr	0.995	0.990	0.985	0.981	0.977	0.974	0.971	0.968
Compressor input Factor	Nr	0.997	0.993	0.990	0.988	0.986	0.984	0.982	0.981
Internal exchanger Glycol solution flow Factor	Nr	1.003	1.010	1.020	1.033	1.050	1.072	1.095	1.124
Pressure drop Factor	Nr	1.029	1.060	1.090	1.118	1.149	1.182	1.211	1.243

The correction factors shown refer to water and glycol ethylene mixes used to prevent the formation of frost on the exchangers in the water circuit during inactivity in winter.

INTERNAL EXCHANGER PRESSURE DROP

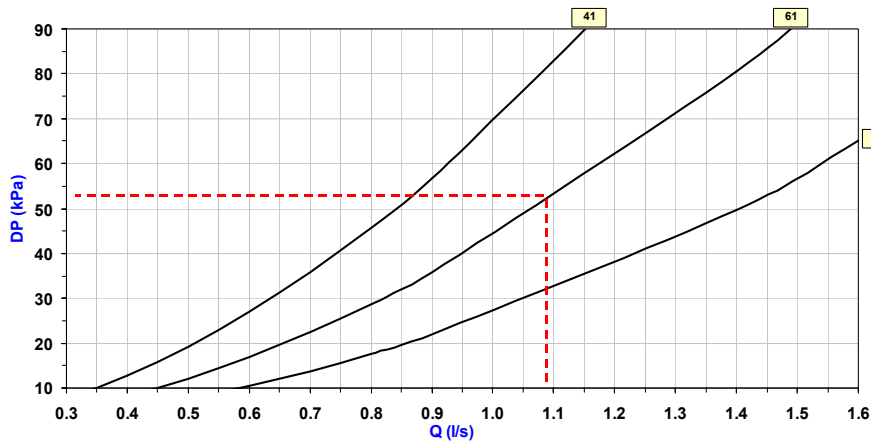

Q = WATER FLOW
DP = AVAILABLE PRESSURE

PUMP PERFORMANCE

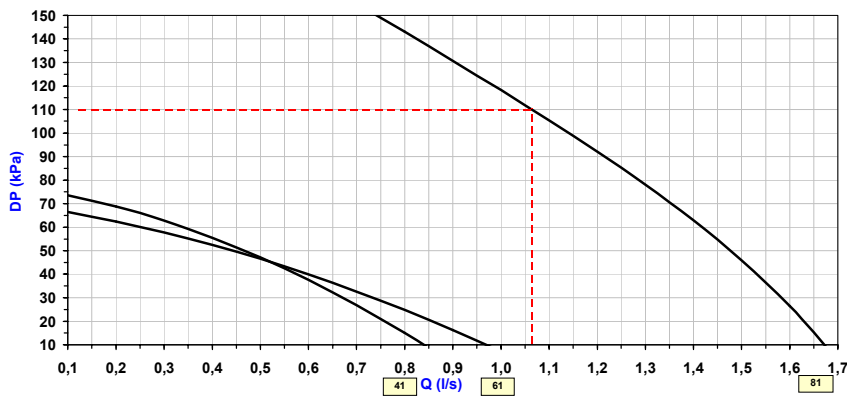

Q = WATER FLOW
DP = AVAILABLE PRESSURE

SOUND LEVELS

Size	Sound Power Level (dB)								Sound pressure level dB(A)	Sound power level dB(A)
	Octave band (Hz)									
	63	125	250	500	1000	2000	4000	8000		
41	54	62	67	69	70	66	58	45	58	73
61	55	63	69	71	72	68	59	47	60	75
81	60	68	73	75	76	72	64	51	64	79

Measures according to ISO 3744 regulations, with respect to the EUROVENT 8/1 certification.

The sound pressure level is measured 1 metre from the external surface of the unit operating in an open field. Data refer to the following conditions: internal exchanger water = 40/45°C

DIMENSIONS

Sizes 41-61

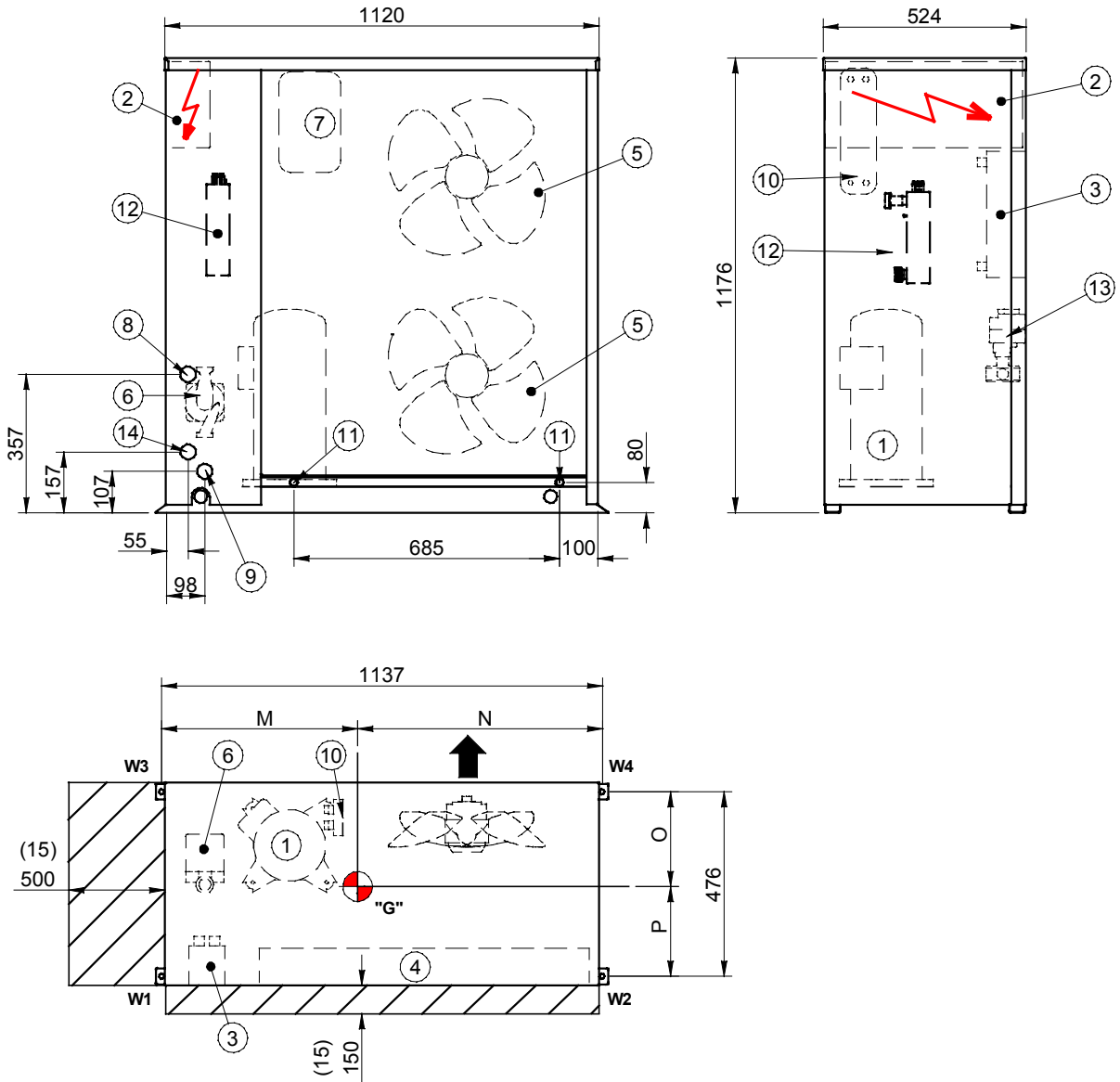

- (1) COMPRESSOR
- (2) ELECTRICAL PANEL
- (3) INTERNAL EXCHANGER
- (4) EXTERNAL EXCHANGER
- (5) FAN
- (6) CIRCULATING PUMP
- (7) EXPANSION VESSEL
- (8) WATER SUPPLY 1" GAS
- (9) WATER RETURN 1" GAS
- (10) ECONOMISER EXCHANGER
- (11) CONDENSATE DISCHARGE
- (12) AUXILIARY ELECTRIC RESISTANCES (OPTIONAL)
- (13) 3-WAY VALVE WATER LINE (OPTIONAL)
- (14) SANITARY WATER SUPPLY 1" F GAS (OPTIONAL)
- (15) CLEARANCE ACCESS RECOMMENDED
- (G) POSITION OF THE UNIT'S CENTRE OF GRAVITY

	Size	41	61
M	mm	466	457
N	mm	671	680
O	mm	224	226
P	mm	252	250
Length	mm	1120	1120
Depth	mm	524	524
Height	mm	1176	1176
W1	kg	42	45
W2	kg	29	30
W3	kg	47	50
W4	kg	33	33
Operating weight	kg	150	157
Shipping weight	kg	153	160

Size 81

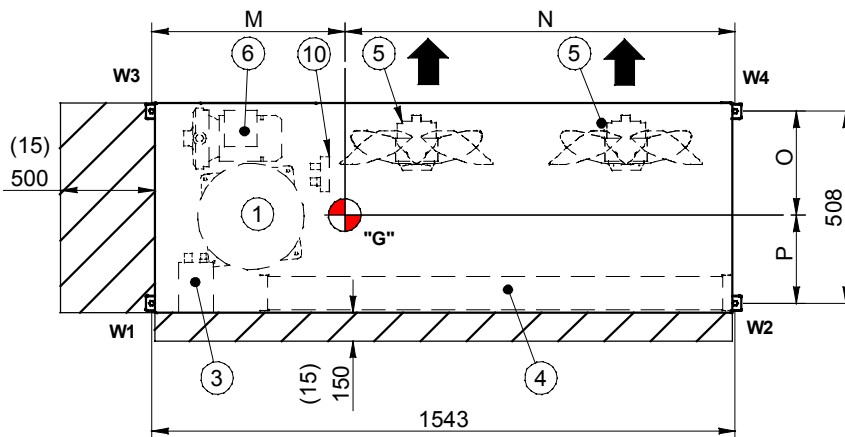
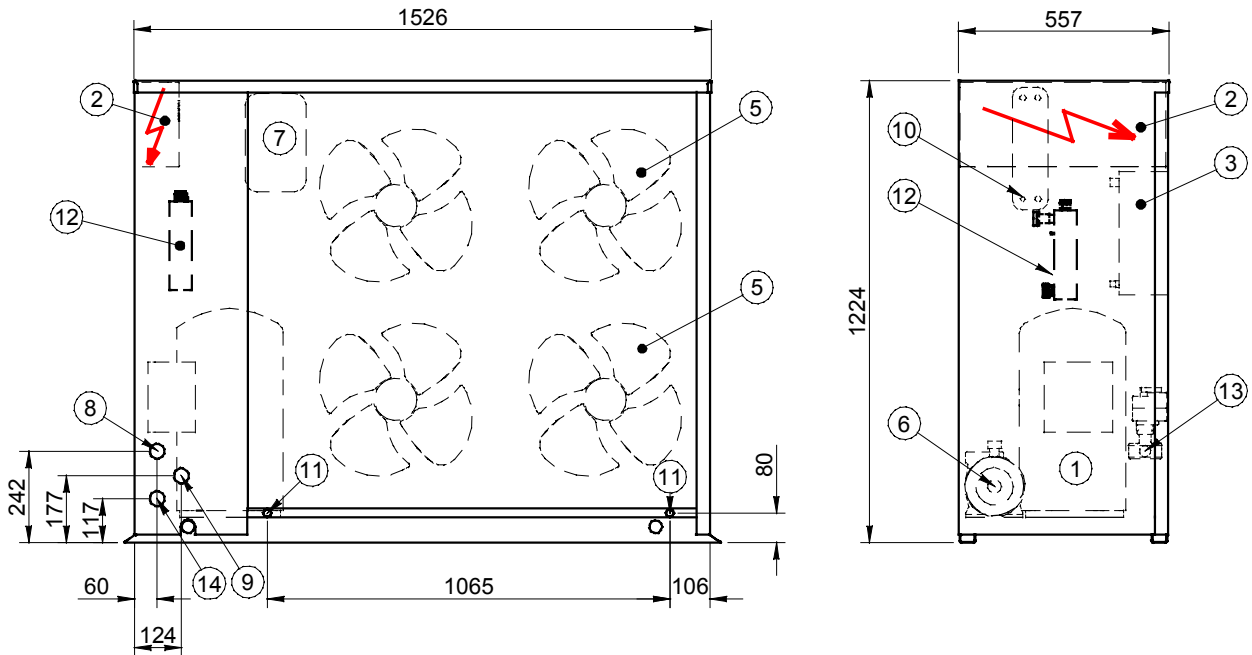

- (1) COMPRESSOR
- (2) ELECTRICAL PANEL
- (3) INTERNAL EXCHANGER
- (4) EXTERNAL EXCHANGER
- (5) FAN
- (6) CIRCULATING PUMP
- (7) EXPANSION VESSEL
- (8) WATER SUPPLY 1" GAS
- (9) WATER RETURN 1" GAS
- (10) ECONOMISER EXCHANGER
- (11) CONDENSATE DISCHARGE
- (12) AUXILIARY ELECTRIC RESISTANCES (OPTIONAL)
- (13) 3-WAY VALVE WATER LINE (OPTIONAL)
- (14) SANITARY WATER SUPPLY 1" F GAS (OPTIONAL)
- (15) CLEARANCE ACCESS RECOMMENDED
- (G) POSITION OF THE UNIT'S CENTRE OF GRAVITY

	Size	81
M	mm	526
N	mm	1017
O	mm	266
P	mm	242
Length	mm	1526
Depth	mm	557
Height	mm	1224
W1	kg	92
W2	kg	48
W3	kg	83
W4	kg	43
Operating weight	kg	266
Shipping weight	kg	270

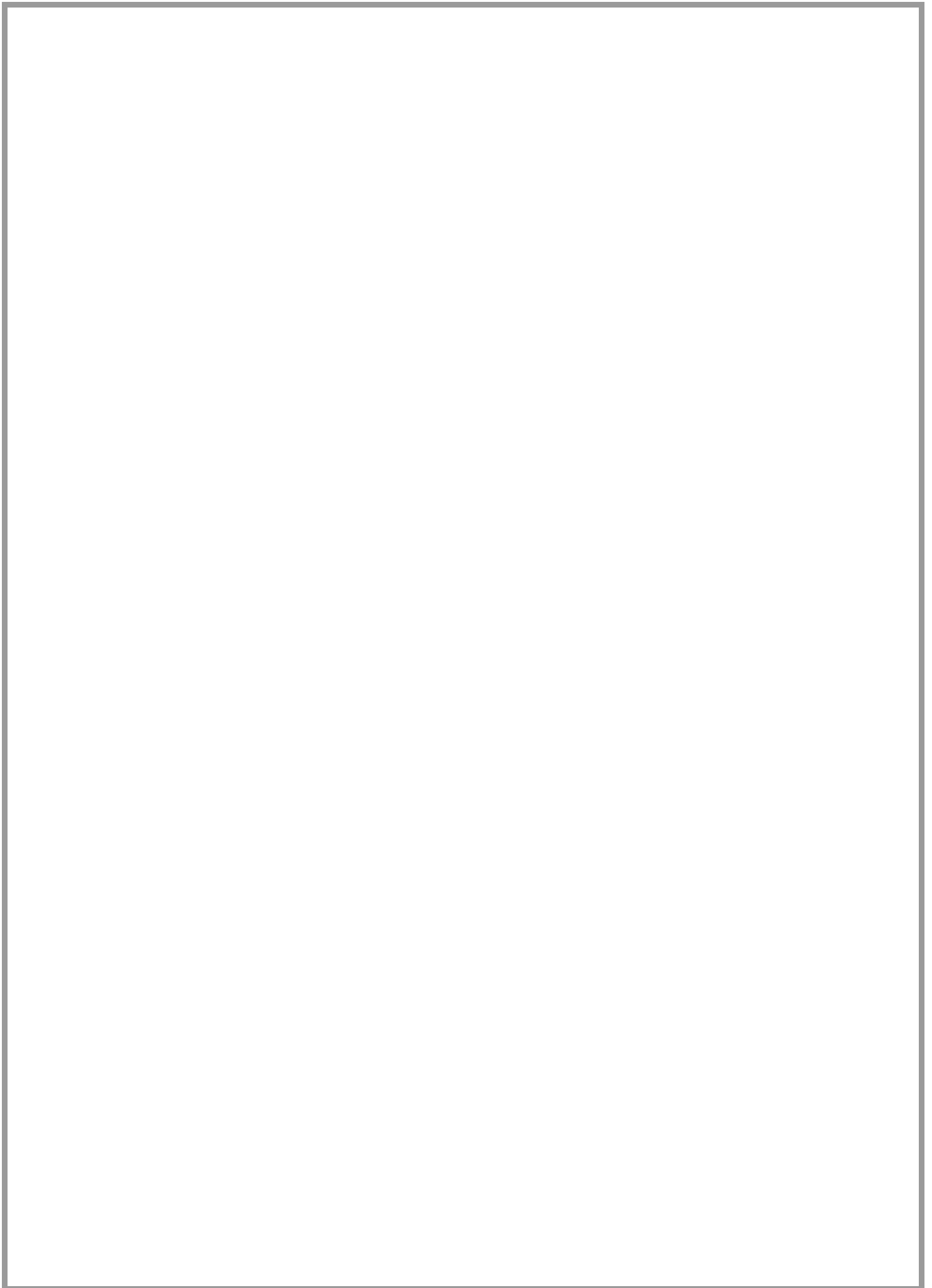

CLIVET SPA
Feltre (BL) ITALY
Tel. + 39 0439 3131
Fax + 39 0439 313300
info@clivet.it

CLIVET ESPAÑA S.A.
(Madrid) SPAIN
Tel. + 34 91 6658280
Fax + 34 91 6657806
info@clivet.es

CLIVET UK LTD
Fareham (Hampshire) U.K.
Tel. + 44 (0) 1489 572238
Fax + 44 (0) 1489 573033
info@clivet-uk.co.uk

CLIVET NEDERLAND B.V.
Amersfoort - Netherlands
Tel. + 31 (0) 33 7503420
Fax + 31 (0) 33 7503424
info@clivet.nl

CLIVET TFA (PVT) LTD
Bangalore - INDIA
Tel. + 91 80 25351617
Fax + 91 80 25351392
sales@clivettfa.com

The data contained in this bulletin is not binding and may be changed by the manufacturer without prior notice. All reproduction, even partial, is PROHIBITED.

© COPYRIGHT - CLIVET S.P.A. - FELTRE (BL) - ITALIA