

**Operating Manual****OM 200MICRO**Group: **Chiller**Part Number: **585515Y**Effective: **April 2000**Supersedes: **OM125****200-Series MicroTech Control Panel****For Centrifugal Chillers**

# Table of Contents

- Introduction..... 3**
- General Description ..... 4**
  - General Description.....4
  - Control Panel Layout.....4
  - Component Description .....6
- Keypad/Display Operation..... 13**
  - Menu Structure .....17
- MicroTech Status Menus ..... 18**
- Control Menu Description ..... 24**
- Alarm Menus Description..... 38**
- Master/Slave Setup..... 41**
- Alarms ..... 43**



McQuay" and MicroTech are registered trademarks of McQuay International  
©1998 McQuay International

"Illustrations and information cover McQuay International products at the time of publication and we reserve the right to make changes in design and construction at anytime without notice."

# Introduction

---

This manual provides installation, setup and troubleshooting information for the **200 Series MicroTech** control panel for McQuay centrifugal chillers. Please refer to IOMM WSCWDC for information relating to the unit itself.

All operational descriptions contained in this manual are based on MicroTech control software versions CFG3E04I (*English*) and CFG3S04I (*metric*). Chiller operating characteristics and menu selections may vary with other versions of control software. Contact McQuayService for software update information.

## Installation Precautions

### WARNING

**Electric shock hazard. Can cause personal injury or equipment damage. This equipment must be properly grounded. Connections to and service of the MicroTech control panel must be performed only by personnel that are knowledgeable in the operation of the equipment being controlled.**

### CAUTION

**Static sensitive components. A static discharge while handling electronic circuit boards can cause damage to the components. Discharge any static electrical charge by touching the bare metal inside the control panel before performing any service work. Never unplug any cables, circuit board terminal blocks, or power plugs while power is applied to the panel.**

### NOTICE

**This equipment generates, uses and can radiate radio frequency energy and, if not installed and used in accordance with this instruction manual, may cause interference to radio communications. It has been tested and found to comply with the limits for a Class A digital device, pursuant to part 15 of the FCC rules. These limits are designed to provide reasonable protection against harmful interference when the equipment is operated in a commercial environment. Operation of this equipment in a residential area is likely to cause harmful interference in which case the user will be required to correct the interference at his own expense. McQuay International Corporation disclaims any liability resulting from any interference or for the correction thereof.**

## Temperature and humidity considerations

The MicroTech controller is designed to operate within an ambient temperature range of -40 to +149°F (-40 to +65.1°C) with a maximum relative humidity of 95% (non-condensing).

# General Description

## General Description

The MicroTech control panel contains a model 280 microprocessor based controller which provides all monitoring and control functions required for the safe, efficient operation of the chiller. The operator can monitor all operating conditions by using the panel's built in 4-line by 40-character keypad / display or by using an IBM compatible computer running McQuay Monitor software. In addition to providing all normal operating controls, the MicroTech controller monitors all safety devices on the unit and will take corrective action if the chiller is operating outside of its normal design conditions. If a fault condition develops, the controller will shut the system down and activate an alarm output. Important operating conditions at the time an alarm condition occurs are retained in the controller's memory to aid in troubleshooting and fault analysis.

The system is protected by a password scheme which only allows access by authorized personnel. A password must be entered into the panel keypad by the operator before any setpoints may be altered.

## Control Panel Layout

Figure 1, Major Component Locations

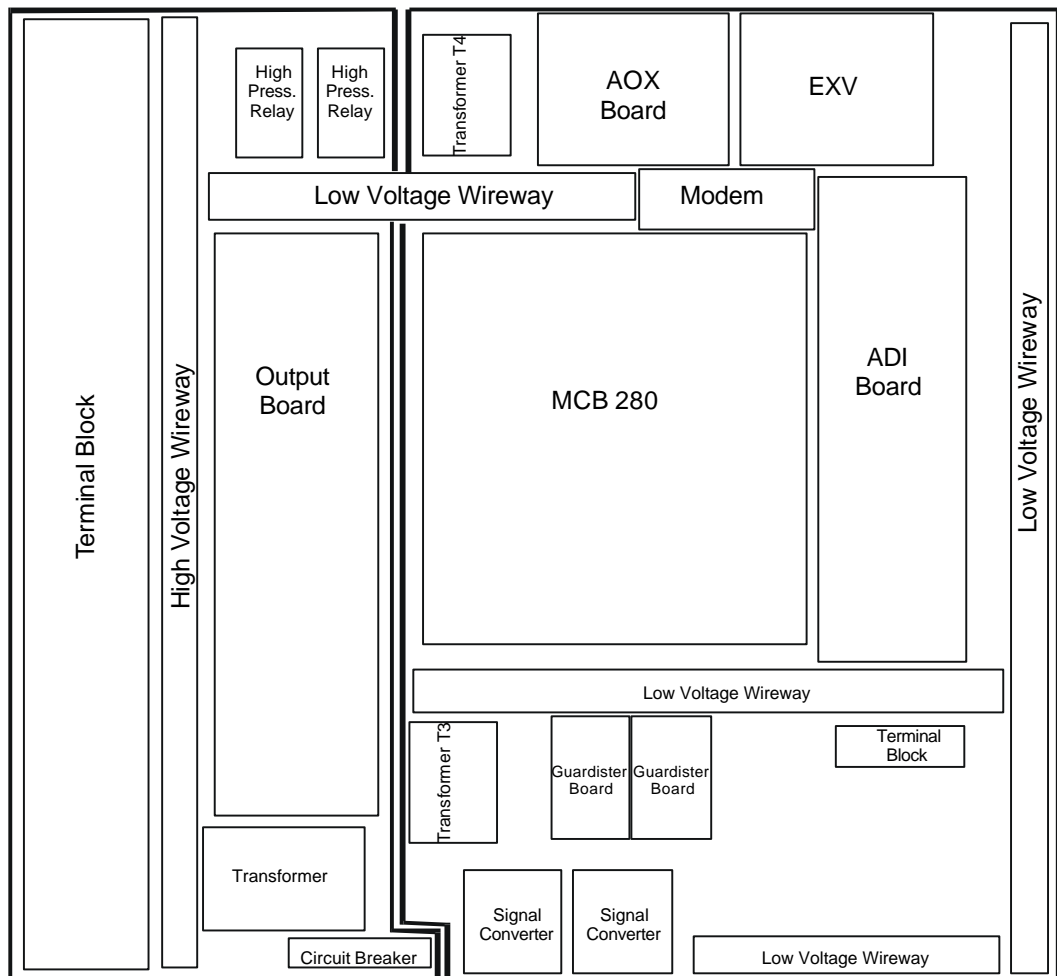

## Features of the Control Panel

- Control of leaving chilled water within a  $\pm 0.2^{\circ}\text{F}$  ( $\pm 0.1^{\circ}\text{C}$ ) control band.
- Readout of all temperature and pressure readings:
  - entering and leaving chilled water temperature
  - enter and leaving condenser water temperature
  - saturated evaporator refrigerant temperature and pressure
  - saturated condenser temperature and pressure - outside air temperature (optional)
  - suction line, liquid line and discharge line temperatures - calculated superheat for discharge and suction lines
  - oil sump temperature - oil feed temperature and pressure
  - optional condenser heat recovery temperature
- Automatic control of primary and \*\*secondary evaporator and condenser pumps.
- Control of up to 4 stages of cooling tower fans plus modulating bypass valve.
- Panel mounted 12 key keypad plus 6 Quick Access function keys. Operator can log chiller operating conditions from a single keypad/display instead of reading gauges, thermometers, pots, etc. The display is a backlit, 4 line by 40 character LCD type for easy viewing in all lighting conditions.
- New auto-logging feature will automatically log chiller functions at the time of peak load. The controller will store and display up to six weeks of accumulated data.
- Two levels of security protection against unauthorized changing of set points and other control parameters.
- Complete warning and fault diagnostics to inform operators of warning and fault conditions in plain language. All warnings, problems and faults are time and date stamped so there is no guessing of when the fault condition occurred. In addition, the operating conditions that existed just prior to shutdown can be recalled to aid in isolating the cause of the problem.
- Eight previous faults and related operating conditions are available from the display.
- Soft loading feature reduces electrical consumption and peak demand charges during loop pull-down.
- Adjustable load pull-down rate reduces under-shoot during loop pull-down.
- Easy integration into building automation systems via separate 4-20mA dc signals for chilled water reset and demand limiting.
- Internal time-clock for on/off scheduling. The time clock accommodates a 7 day schedule plus holiday, 1 start and stop per day, and 14 holidays with programmable duration.
- Communications capabilities for remote monitoring, changing of set points, trend logging, remote reset, alarm and event detection, via a compatible IBM-PC running McQuay MicroTech™ software.
- Manual control mode allows the service technician to command the unit to different operating states. Useful for system checkout.
- BAS communication capability via McQuay's Open Protocol strategy to over 10 major BAS manufacturers.
- Service Test mode for troubleshooting controller hardware.
- Display available in either U.S. Customary or S.I. units. Keypad programmable alarm contacts for normally open, or normally closed, and optional pulse output on problem and warning conditions.
- Pressure transducers for direct reading of system pressures. Preemptive control of low evaporator pressure conditions to take corrective action prior to a fault trip.
- Preemptive control of high discharge temperature.
- Modulating oil cooler valve control (optional).
- Minimum vane position set point.
- \*\*Secondary throughout this publication implies a parallel or standby pump.

## Component Description

Figure 2, Model 280 Microprocessor Control Board

### Microprocessor Control Board (MCB1)

The Model 280 Microprocessor Control Board contains the electronic hardware and software required to monitor and control the unit. It receives input from the ADI Board and sends commands to the Output Board to maintain the unit's optimum operating mode for the current conditions. Status lights are mounted on the control board to indicate the operating condition of the microprocessor.

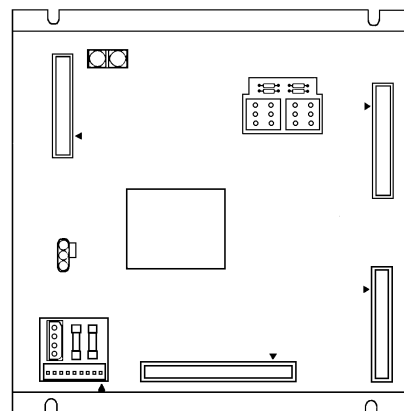

### Pre-Start Checkout

#### Hexadecimal Switches

For proper chiller operation, each MicroTech® controller must have a unique network address. The controller's hex switch settings define its location in a network as well as its unit type. For a stand-alone chiller, the Hi and Lo switches should be set to 0 and 1 respectively. After changing a hex switch setting, the controller's power must be cycled by opening, and then closing, the panel circuit breaker.

---

**Note:** The chiller should be in an "Off" mode before resetting the hex switch positions.

---

### Powering the Control Panel

There are three status LED's located on the model 280 controller which will indicate the microprocessor's operating condition. When power is first applied to the control panel, the red *reset* LED will illuminate for approximately 3 seconds. During this time, the microprocessor is checking the control software and performing internal hardware tests. When these tests are complete the *reset* LED will turn off and the green *running* LED will illuminate indicating the controller's circuitry and software are operating correctly. The amber *output 0 active* LED is associated with the external alarm output. This LED may or may not be illuminated at this time based on the setpoints under menu 36.

Figure 3, Status LEDs

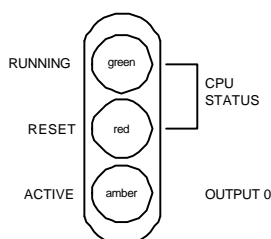

If the *reset* LED stays on or the *running* LED fails to illuminate, disconnect the controller power by opening circuit breaker CB-1 and re-check the field wiring. Observe the controller's LED's while re-connecting power by closing CB-1. If the green *running* LED still does not turn on, a hardware failure exists or the control software is corrupted. Downloading new control software or replacing the 280 controller should correct the problem.

With the controller powered up and the green *running* LED illuminated, the backlite panel on the display module will be illuminated and the unit status menu will be visible. If the display text looks faded or appears as “blocks” the contrast needs to be adjusted. Watch the display and adjusting the contrast control with a small flat-blade screwdriver until the best setting is determined.

**Figure 4, Contrast Adjustment**

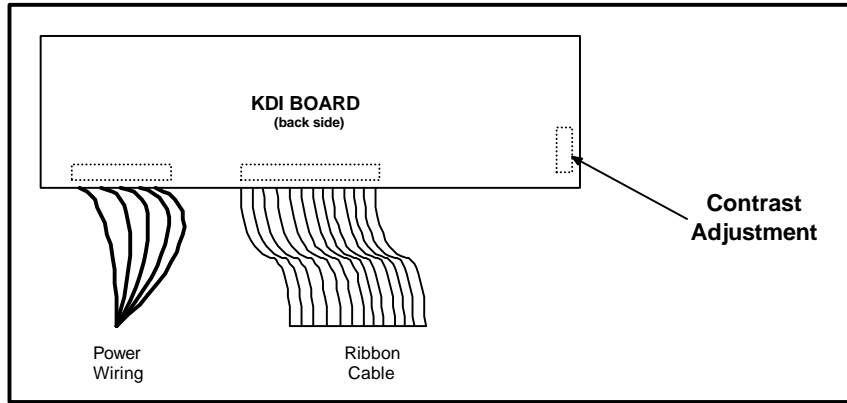

The MicroTech controller contains factory installed default setpoints which will be appropriate for most common installations. Step through all of the unit’s setpoints by using the keypad / display and adjust them as required to meet the specific job requirements. Any faults appearing on the display should be cleared at this time by pressing the **CLEAR** key.

### Digital Output Board

The Output Board contains up to 24 solid state relays which are used to control the compressor, cooling tower fans, solenoid valves and alarm annunciation. It receives control signals from the Microprocessor Control Board through a 50 conductor ribbon cable.

**Figure 5, Digital Output Board**

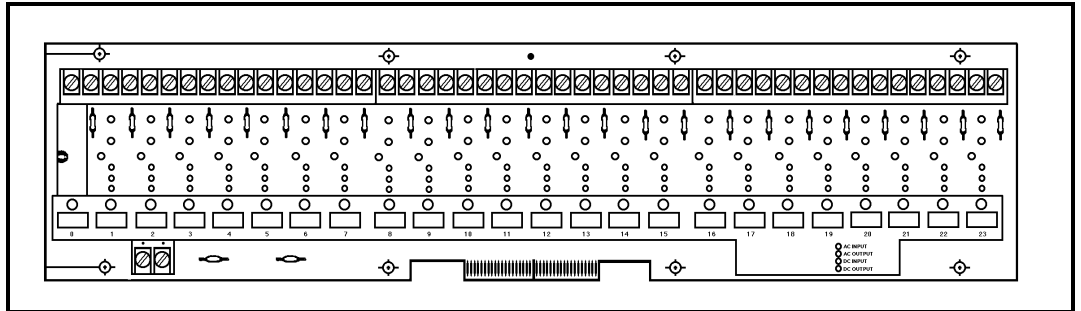

### Digital Outputs

Solid state digital relays are used to switch most of the external devices controlled by the MicroTech® panel. These devices may be pumps or solenoids that are either on or off.

**Table 1, Digital Outputs**

No.	Description	LED Off	LED On
0	Alarm LED and Contact	Programmable	Programmable
1	Unload Solenoid and Front Panel LED	-	Unload
2	Load Solenoid and Front Panel LED	-	Load
3	Motor Control Relay	Off	On
4	Motor Control Relay Latch	Unlatched	Latched
5	Oil Pump	Off	On
6	Oil Sump Heater	Off	On
7	Oil Cooler close	Off	On
8	Oil Cooler Open	Off	On
9	*Hot Gas Bypass Solenoid	Off	On
10	*Liquid Injection	Off	On
11	Cooling Tower #1	Off	On
12	Cooling Tower #2	Off	On
13	Cooling Tower #3	Off	On
14	Cooling Tower #4	Off	On
15	Evaporator Water Pump #1	Off	On
16	Evaporator Water Pump #2	Off	On
17	Condenser Water Pump #1	Off	On
18	Condenser Water Pump #2	Off	On
19	Spare		
20	Spare		
21	Spare		
22	Spare		
23	Spare		

**Analog/Digital Input Board (ADI)**

The ADI Board provides low voltage power for the temperature and pressure sensors. It also provides optical isolation between the Microprocessor Control Board and all 24V switch inputs. LED's are furnished on the board to give a visual indication of the status of all digital inputs. All analog and digital signals from sensors, transducers and switches are received by the ADI Board and then sent to the Microprocessor Control Board for interpretation.

**Figure 6, ADI Board**

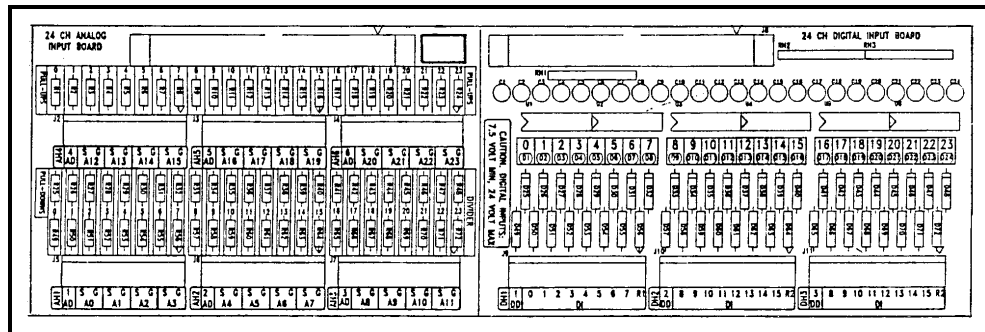

**Analog Inputs**

Analog inputs arriving at the ADI board are comprised of temperature, pressure, and flow signals. In addition, the chiller control panel mA receive chilled water reset and demand limit signals in the range



of 4-20 mA. Temperature and pressure readings have a resolution of 0.1°F and 0.1 psi respectively. Flow readings and remote reset signals are resolved to  $\pm 1\%$ .

**Table 2, Controller Input Signals**

ADI	Sensor No.	Description	Range	
0	S00	Leaving Evaporator Water Temperature	-40 - 263 F	(-40-128.4°C)
1	S01	Entering Evaporator Water Temperature	-40 - 263 F	(-40-128.4°C)
2	S02	Compressor Suction Temperature	-40 - 263 F	(-40-128.4°C)
3	S03	External Chilled Water Reset ( <i>by others</i> )	4-20mA = 0-100%	
4	S04	External motor Current Reset ( <i>by others</i> )	4-20mA = 0-100%	
5	S05	Refrigerant Leak Monitor Signal ( <i>by others</i> )	4-20mA = 0-100 PPM	
6	S06	Evaporator Water Flow Transmitter Signal ( <i>by others</i> )	4-20mA = 0-65535	
7	S07	Condenser Water Flow Transmitter Signal ( <i>by others</i> )	4-20mA = 0-65535	
8	S08	Condenser Liquid Line Temperature	-40 - 263 F	(-40-128.4°C)
9	S09	Entering Condenser Water Temperature	-40 - 263 F	(-40-128.4°C)
10	S10	Leaving Condenser Water Temperature	-40 - 263 F	(-40-128.4°C)
11	S11	Percent Unit Amps	0-5V = 0-125% RLA	
12	S12	Compressor Discharge Temperature	-40 - 263 F	(-40-128.4°C)
13	S13	Oil Feed Temperature	-40 - 263 F	(-40-128.4°C)
14	S14	Oil Sump Temperature	-40 - 263 F	(-40-128.4°C)
15	S15	Oil Vent Pressure	0-165 psig	(0-1137.6 kPa)
16	S16	Evaporator Refrigerant Pressure	0-165 psig	(0-1137.6 kPa)
17	S17	Condenser Refrigerant Pressure	0-165 psig	(0-1137.6 kPa)
18	S18	Oil Feed Gauge Pressure	0-165 psig	(0-1137.6 kPa)
19	S19	Transducer Power Voltage Ratio	Used for Calibration	
20	S20	Outdoor Air Temperature	-40 - 263 F	(-40-128.4°C)
21	S21	Heat Recovery Entering Water Temperature	-40 - 263 F	(-40-128.4°C)
22	S22	Heat Recovery Leaving Water Temperature	-40 - 263 F	(-40-128.4°C)
23	S23	Spare		

## Digital Inputs

Digital inputs indicate the status of external two-position devices such as a flow switch or remote time clock. The ADI board senses the presence or absence of 24VAC and provides a corresponding indication to the microprocessor control board.

**Table 3, Digital Inputs**

No.	Description	Lo Voltage	Hi Voltage
0	Front Panel "Stop/Auto" Switch	Stop	Auto
1	Compressor High Pressure Switch	Alarm	Normal
2	Motor High Temperature (Guardistor)	Alarm	Normal
3	Vanes Closed	Open	Closed
4	Starter Transition	-	Delta
5	Starter Fault	Alarm	Normal
6	Evaporator Water Flow Switch	No Flow	Flow
7	Condenser Water Flow Switch	No Flow	Flow
8	Remote Start/Stop	Stop	Enable
9	Chiller/Templifier/Ice	Chiller	Templifier/Ice

## Analog Output Board (AOX)

The AOX board converts control instructions from the Microprocessor Control Board's expansion bus into an analog control signal suitable for driving a cooling tower bypass valve. Each AOX board is factory set via jumper to provide an output signal range of 0 - 10 VDC. An additional output on the AOX board provides an analog signal that is proportional to compressor motor current.

**Figure 7, AOX Board**

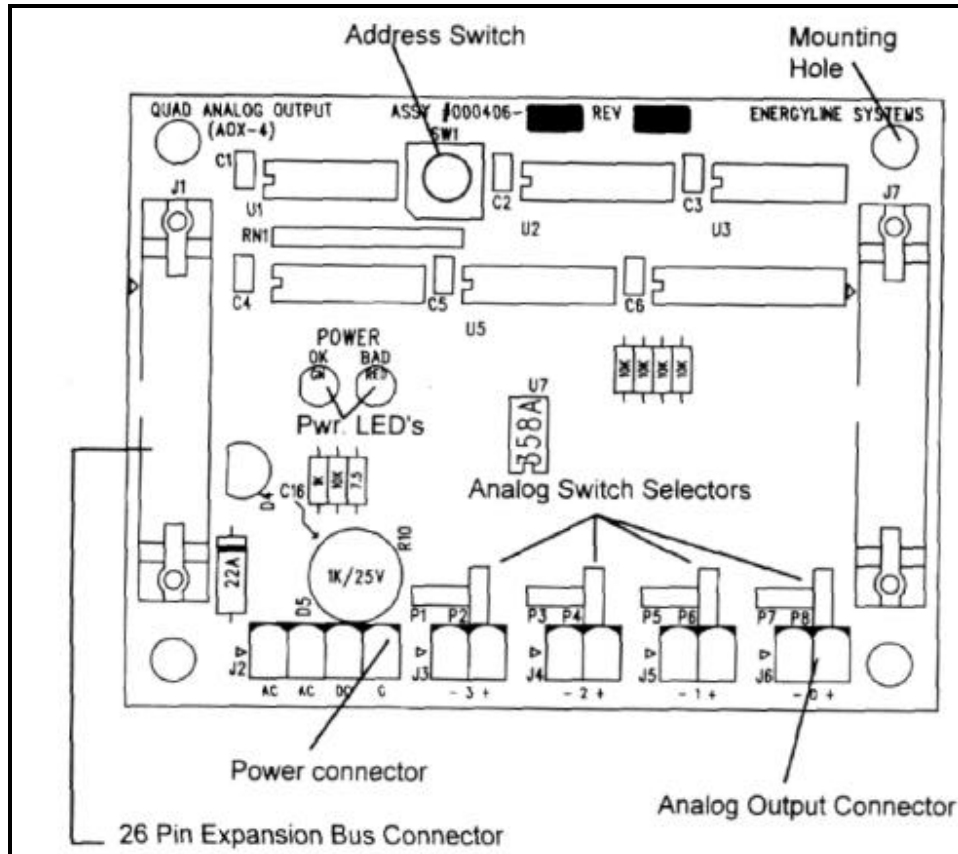

### Analog Outputs (Optional)

The analog outputs available at the AOX board provide a variable voltage used to control field mounted devices. The range of the output signal is jumper selectable: 0-10 VDC (default); 0-5 VDC; 4-20 mA.

**Table 4, AOX Board #1**

No.	Description	Conversion
0	Cooling Tower Bypass Valve	0-255 : 0-100% Open
1	Proportional Motor Current Output	0-255 : 0-100% RLA
2	*Compressor Variable Frequency Drive	0-255 : 0-100% Open
3	*Cooling Tower Variable Frequency Drive	0-255 : 0-100%

## Signal Converter Board

The AC current signal generated by the starter is converted by the signal converter board into a 0-5 VDC signal that is directly proportional to the chiller amp draw. The amp draw signal is sent to the ADI board for conditioning and then to the M280 controller.

**Figure 8, Signal Converter Board**

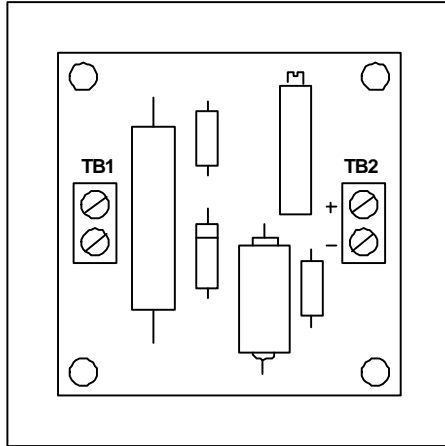

## Guardistor Board

The Guardistor board monitors the motor winding temperature through the embedded Guardistor sensors. If the motor temperature rises to an unsafe level, the board will signal the M280 controller and the chiller will be shut down.

**Figure 9, Guardistor Board**

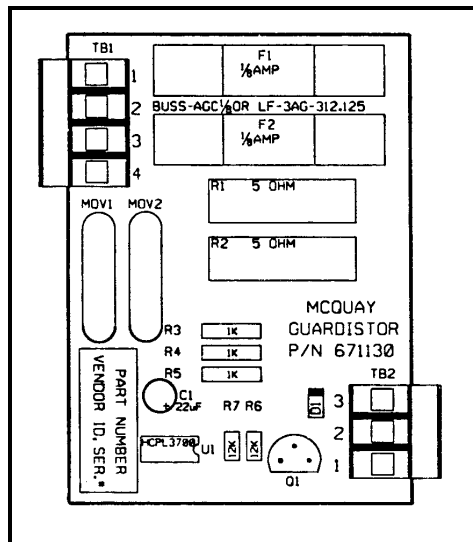

## Power Transformers

Transformers T2, T3 and T4 provide operating power to the MicroTech controller and its associated components. T2 is a conventional ferrite core transformer that converts 120VAC from the control transformer into 24VAC. T3 and T4 are transformers that convert 24VAC from T2 into a center-tapped 18VAC.

# Keypad/Display Operation

The Keypad/Display is the primary operator interface to the unit. All operating conditions, system alarms and setpoints can be monitored from this display and all adjustable setpoints can be modified from this keyboard if the operator has entered a valid operator password.

## General Description

The MicroTech keypad consists of eighteen pressure sensitive membrane switches used to step through, access, and manipulate the information in the MicroTech controller. The selected information is presented on a four line by forty character backlit LCD display.

The information stored in the MicroTech controller can be accessed through the keypad by following the tree-like structure of menus and menu items. The keypad keys are divided into four groups with four or more keys in each to ease navigation through the available menus and items.

**Figure 10, MicroTech Keypad**

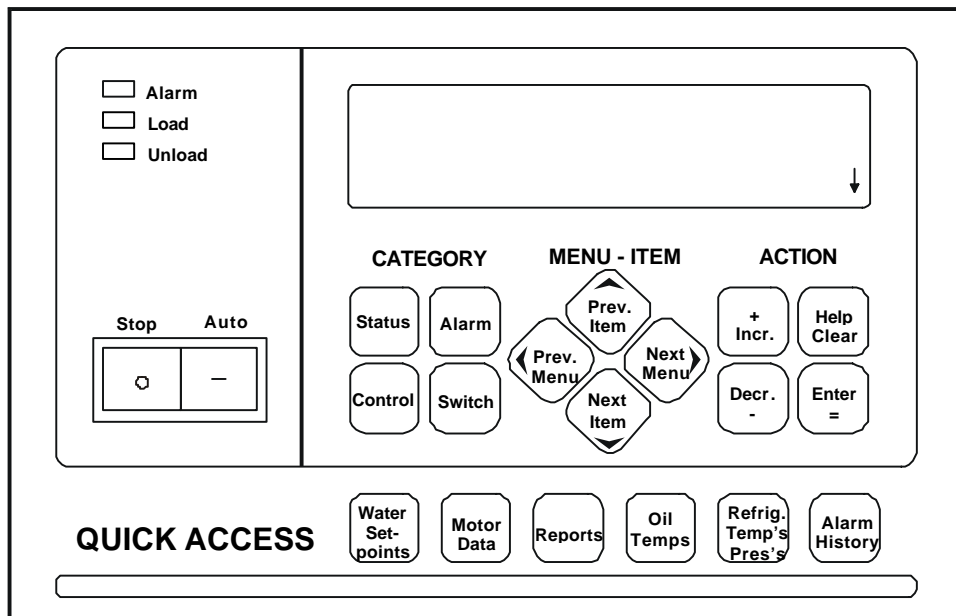

**Figure 11, Example of a typical MicroTech display screen indicating item lines and fields**

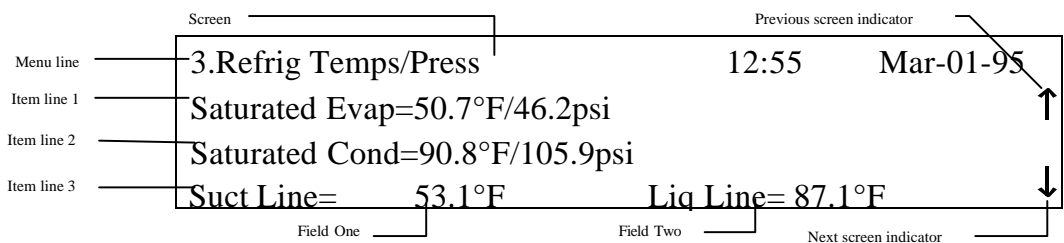

## Category Group

The keys in this group provide quick access to strategic menus throughout the menu tree-structure. This reduces the need to step through all the menus, one by one, in order to reach the desired information.

**Figure 12, Category Group**

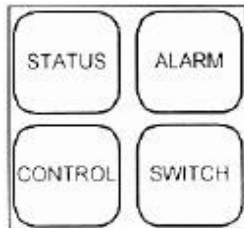

### Status Key

Menus and menu items in this category provide information on the MicroTech operating conditions and the chiller operating conditions. The entries under each menu item in this category provide information only and are not changeable through the MicroTech keypad.

Pressing the "STATUS" key at any time shifts the display to Menu #1 which is the first menu of the STATUS category.

### Control Key

Menus and menu items in this category provide for the adjustment of all the unit control parameters. These include capacity control, pump control and cooling tower control parameters as well as time schedules and alarm limits. The entries under these menu items are changeable through the MicroTech keypad.

Pressing the "CONTROL" key at any time shifts the display to Menu #11 (*Control Mode*) which is the first menu of the CONTROL category.

### Alarm Key

Menus and menu items in this category provide information regarding current and previous fault conditions along with the operating temperatures and pressures at the time the fault occurred.

Pressing the "ALARM" key at any time shifts the display to Menu #27 which is the first menu of the ALARM category.

### Switch Key

Pressing the "SWITCH" key at any time toggles the display between the current menu (*Status/Control*) item and the related menu (*Control/Status*) item somewhere else in the tree-structure. This allows checking actual conditions against setpoints. The status menu numbers that have related control menus are 1, 2, 3, 6 and 7. The reciprocal occurs when in the control menu, pressing the "SWITCH" key toggles to the related status menu showing actual conditions. The control menu numbers that have related status menus are 11, 12, 18, 19 and 22. Pressing the "SWITCH" key the second time takes the operator back to the original menu item. For example, if this key is pressed while the current menu item is menu item 2B (*Leaving Evaporator =*), the display shifts to menu item 12B (*Local Evaporator Setpoint =*). This provides for easy review of actual versus setpoint values.

## Menu - Item Group

Figure 13, Menu - Item Group

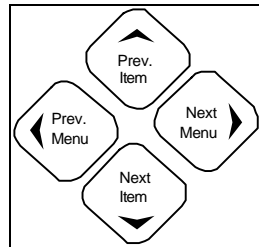

The keys in this group are used to scroll through the various menus and items presented on the controller's display. A menu contains a specific group of items.

**Note:** When Menu #1 is currently in the display (the first menu in the menu tree-structure), pressing "PREV." causes an "beginning of menus" message to appear in the display.

### Previous Menu

Pressing "PREV." shifts the display to the previous group of items within a menu. **Note:** When the first item in a menu is currently in the display, pressing "PREV." causes an "beginning of items" message to appear in the display.

### Next Menu

Pressing "NEXT" shifts the display to the next group of items in a menu. **Note:** When the last item in a menu is currently in the display, pressing "NEXT" causes an "end of items" message to appear in the display.

### Previous Item

Pressing "PREV." shifts the display to the previous group of items within a menu. **Note:** When the first item in a menu is currently in the display, pressing "PREV." causes an "beginning of items" message to appear in the display.

### Next Item

Pressing "NEXT" shifts the display to the next group of items in a menu. **Note:** When the last item in a menu is currently in the display, pressing "NEXT" causes an "end of items" message to appear in the display.

## Action Group

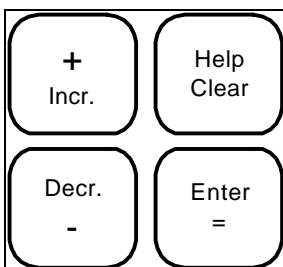

The keys in this group are for making changes to unit control parameters or for clearing fault conditions.

**Note:** Before a change to a parameter can be made or before a fault can be cleared, the display prompts the user with an "Enter Password" message. At this point, the password must be entered before the user can continue with the action.

**Increment (+)**

When changing the value of a menu item entry, pressing "INCR. +" shifts the selected menu item to the next higher value or next available selection.

**Decrement (-)**

When changing the value of a menu item entry, pressing "DECR.-" shifts the selected menu item to the next lower value or previous available selection.

**Enter (=)**

Once a change has been made to a desired value, pressing "ENTER =" locks in the new value.

**Help / Clear**

Pressing "ALARMS" followed by "CLEAR" clears the current fault. Also, when a change is made to a menu item, pressing "CLEAR" returns the display to the original value as long as "ENTER" has not yet been pressed. **Note:** The cause of a fault should always be determined and corrected before clearing the fault through the keypad.

**Keypad Password**

When changing any menu item entry (+ or- key), the user is prompted to enter a valid password. The change will not be allowed until the correct password is entered. The password for centrifugal units is always four successive presses of the "Enter" key.

Once this has been done, the user can make changes to menu item entries. After entering the correct password, the controller will allow a 5 minute time period during which the operator may make any necessary setpoint adjustments. Any keypad activity will reset the timer for the full 5 minutes so the password only needs to be entered once per session. After 5 minutes of inactivity, the password access time will expire providing protection against unauthorized users.

**Quick Access Group**

The quick access keys provide a fast shortcut directly into the most frequently used MicroTech menus. For example, pressing the "WATER SET POINTS" key moves you directly to menu #12 without having to step through intermediate menus via the "PREVIOUS" and "NEXT" keys.

**Figure 14, Quick Access Group**

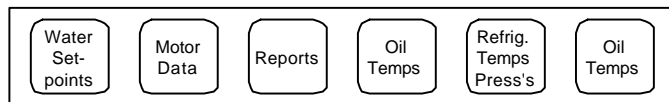
**Display Format**

The information stored in the MicroTech controller tree structure can be viewed directly on the control panel's 4 line by 40 character display. The currently selected menu is shown on the top line along with the current date and time. Up to six menu items may be shown on the lower three lines of the display. Alarm menus may have an additional field on line 1.

Either English or Metric units of measure may be displayed by installing the appropriate controller software.



### English Customary Units:

Temperature = °F (Fahrenheit)  
Pressure = Psi (Pound per sq. inch)  
                  Psig  
                  Psid

### Metric Units:

Temperature = °C (Centigrade)  
Pressure = kPa (Kilo Pascals)  
                  kPag  
                  kPda

## Menu Structure

### Displaying Setpoints

To view set points or operating conditions press the "PREV MENU" or "NEXT MENU" key until menu of interest appears. (*Remember pressing a key in the Category group goes to the first menu of that group.*) To view additional set points or conditions under the menu selected press the "PREV MENU" or "NEXT MENU" key.

### Changing Setpoints

Set points/values that can be modified are under the control and alarm categories. Once the menu is selected, the set point/value can be changed by pressing the "+ INCR." or "- DECR." key. The display screen will change and in place of the date and time the term "ENTER PASSWORD:" will be displayed. The operator must enter the appropriate password by pressing the correct four keys in sequence. The display will indicate "PASSWORD VERIFIED:" or "INVALID PASSWORD:" in place of the time and date. When the correct password is entered, the term "<Change Values Mode>" is displayed in place of the time and date. The first value on the display that can be changed will flash on and off. Pressing the "NEXT/ PREV MENU" or "NEXT/PREV ITEM" keys will select the next set point/value on the screen that can be changed. Pressing the "+ INCR." or "- DECR." key will change the numeric value or select the next option. When the correct value or option is flashing, press the "ENTER =" key to store it into memory. The flashing will stop and the time and date is returned to the display screen. Follow this sequence to change additional set points/values. (*The term "Enter Password" will not be displayed unless there has not been any keypad activity for flve minutes.*)

### Display Screen

The display screen is divided into lines and fields. The top line will indicate the menu number and a menu description on the left side, and the time and date on the right side. The time and date will be replaced with directions when modifying set points and values.

The first line normally will have two fields except when viewing alarms then there is a third field. Line 2 and line 3 have two fields. Different menus will have varying amounts of information and not all the fields will be used.

When selecting new menus using the "NEXT MENU" and "PREV MENU" keys, the display is considered screen one. If additional screens are available, there will be an arrow pointing down in the last block in the right hand screen corner. To obtain additional information available under a specific menu, press the "NEXT ITEM" and "PREV ITEM" keys. This will toggle between the available screens displaying the various set points and values. Most menus will have only one screen; however, Menu 10 (Auto Logging) has 24 screens. The range of information that can be displayed in a field is extensive and the next section will show all possible field names, set points and values.

# MicroTech Status Menus

Press the "STATUS" key under the Category Group and the information in Menu 1 (Unit Status) will be displayed. Information displayed in menus 1-10 indicates current operating conditions and cannot be reset from the display keypad. Refer to the Metric Menu section for displays in metric values. This menu has one screen with three lines of information. Line 1 contains the unit operating status in field 1 and the motor % amps in field 2. Line 2, field 1 indicates the entering evaporator water temperature and line 2, field 2 indicates the entering condenser water temperature. Line 3, field 1 indicates the leaving evaporator water temperature and line 3, field 2 indicates the leaving condenser water temperature. This information gives the operator a quick view of the operating condition of the unit. Pressing the switch key will toggle between this menu and Menu 11 (*Control Mode*). This allows the operator to compare actual operating status versus control mode.

## Menu 1, Unit Status

Screen	Line	Display	Field	Item	Range	Extended Name
1	1	Running: Spt 44.0°F	1	AllSystemsOff		Chiller Operating Mode
				Off: Alarm		
				Off: Ambient Lockout		
				Off: Front Panel Sw		
				Off: Remote Contacts		
				Off: Remote Comm		
				Off: Time Schedule		
				Off: Manual Setpoint		
				Off: System Comm		
				Start Requested		
				Waiting Low Sump T		
				Evap Pump Off		
				Waiting For Load		
				Cond Pump Off		
				Cond Pump On		
				MCR Started		
				MCR Off: Rapid Shtdn		
				MCR Off: Routn Shtdn		
				Evap Pump Off		
				Running: Hi Disch T		
				Running: Lo Evap T		
				Running: Soft Load		
				Running: Max Pulldn		
				Running: Rem Amp Lim		
				Running: Man Amp Lim		
				Running: Net Amp Lim		
				Running: Manual Load		
				Running: Max Amp Lim		
				Running: Min Amp Lim		
				Load Recycle		
				Pre-Lube		
				Start Unload		
				Post-Lube		
Evap Pump on-Recirc						
Oil Pump On-Prelube						
Startup Unloading						
Running OK:						
Shutdown Unloading						
Post Lube						
		Motor Amps=xx%RLA	2		1-100%	Motor Current
	2	Ent Evap=xx.x°F	1			Entering Evap Water Temp
		Ent Cond=xx.x°F	2			Entering Cond Water Temp
	3	Lvg Evap=xx.x°F	1			Leaving Evap Water Temp
		Lvg Cond=xx.x°F	2			Leaving Cond Water Temp

Press the "NEXT MENU" key and Menu 2 (*Water Temps/Flow*) will be displayed. This menu has two screens. Screen 1, line 1, field 1 indicates the entering evaporator water temperature and line 1, field 2 indicates entering condenser water temperature. Line 2, field 1 indicates the leaving evaporator water

temperature and line 2, field 2 indicates the leaving condenser water temperature. Line 3, field 1 indicates the evaporator delta temperature. This is the difference between the entering and leaving water temperature and indicates the 'load' on the chiller and the performance of the chiller. Line 3, field 2 indicates the condenser delta temperature. The design delta temperature of the evaporator and condenser should be recorded. Any large changes in the delta temperatures is an indication of potential problems that could be associated with fouled condenser or evaporator tubes.

Press the "NEXT ITEM" key and screen 2 will display additional information. Line 1, field 1 will indicate the entering heat recovery temperature. *(This is an optional operating parameter and it will display a value only if the optional heat recovery sensors are installed.)* Line 1, field 2 will indicate the flow rate through the evaporator in gallons per minute (*gpm*). (This is an option and the optional flow meter must be installed in the piping system.) Line 2, field 1 indicates the leaving heat recovery water temperature (*optional*). Line 2, field 2 indicates the condenser water flow in gallons per minute (*optional*). Line 3, field 1 indicates the delta temperature of the heat recovery system (*optional*). The delta temperature of the heat recovery system multiplied by the water flow rate and a special factor would provide the amount of heat recovered in Btu's. This information could be compared to design conditions to determine system operation. Pressing the switch key will toggle between this menu and Menu 12 (*Leaving Evap Set Points*). This allows the operator to compare actual operating conditions versus set points.

**Menu 2, Water Temperatures**

Item					
Screen	Line	Display	Field	Range	Extended Name
1	1	Ent Evap=xx.x°F	1		Entering Evap Water Temp
		Ent Cond=xx.x°F	2		Entering Cond Water Temp
	2	Lvg Evap=xx.x°F	1		Leaving Evap Water Temp
		Lvg Cond=xx.x°F	2		Leaving Cond Water Temp
	3	Delta T=xx.x°F	1		Evap Water Delta Temp
		Delta T=xx.x°F	2		Cond Water Delta Temp
2	1	Ent Ht Rcvy=xx.x°F	1		Heat Rcvy Ent Water Temp
		Evap Flow=xxxxgpm	2		Averaged Evap Water Flow
	2	Lvg Ht Rcvy=xx.x°F	1		Heat Rcvy Lvg Water Temp
		Cond Flow=xxxxgpm	2		Averaged Cond Water Flow
	3	Delta T=xx.x°F	1		Heat Rcvy Delta Temp

Press the "NEXT MENU" key and Menu 3 (*Refrig Temps/Press*) will be displayed. This menu has three screens. The refrigerant temperatures and pressures allows the operator to determine if the chiller is performing properly. These values should be recorded in a chiller log on a daily basis. The values will change as the load, condenser temperature and evaporator temperature vary. The operator should be able to correlate displayed information to varying load conditions.

Screen 1, line 1, field 1 indicates the saturated evaporator refrigerant pressure and temperature. The evaporator pressure is measured using a pressure transducer and the associated temperature is calculated using refrigerant tables stored in the computer memory. Line 2, field 1 indicates the saturated condenser refrigerant pressure and temperature. The condenser pressure is measured using a pressure transducer and the associated temperature is calculated. Line 3, field 1 indicates the suction line temperature. This is measured with a thermister in the inlet suction pipe before the inlet guide vanes at the compressor. Line 3, field 2 indicates the liquid line temperature and is measured with a thermister in the liquid line leaving the condenser.

Press the "NEXT ITEM" key and screen two will display additional information. Screen 2, line 1, field 1 indicates the suction superheat. This value is determined by subtracting the saturated evaporator temperature from the suction line temperature. Line 1, field 2 indicates the amount of subcooling of the liquid refrigerant. This temperature is calculated by subtracting the liquid line temperature from the condenser temperature. Line 2, field 1 indicates the refrigerant temperature after it leaves the compressor and before entering the condenser. Line 2, field 2 indicates the condenser approach temperature. This temperature is calculated by subtracting the leaving condenser water temperature from the saturated condenser refrigerant temperature. Line 3, field 1 indicates the discharge refrigerant superheat. This temperature is calculated by subtracting the refrigerant saturated condenser temperature from the refrigerant discharge temperature. Line 3, field 2 indicates the evaporator

approach temperature. This temperature is calculated by subtracting the evaporator refrigerant temperature from the evaporator leaving water temperature.

Press the "NEXT ITEM" key and screen 3 will display additional information. Line 1, field 1 indicates the compressor lift pressure. This value is calculated by subtracting the evaporator pressure from the condenser pressure. This indicates the work by the compressor.

### Menu 3, Refrigerant Temps/Press

Item					
Screen	Line	Display	Field	Range	Extended Name
1	1	Saturated Evap=xx.x°F/xx.xpsi	1		Saturated Refg Evap Temp/Press
	2	Saturated Cond=xx.x°F/xx.xpsi	1		Saturated Refg Cond Temp/Press
	3	Suct Line=xx.x°F	1		Suction Line Refg Temp
Liquid Line=xx.x°F		2		Liquid Line Refg Temp	
2	1	Suct Suprht=xx.x°F	1		Suction Superheat
		SubCool=xx.x°F	2		Liquid SubCooling
	2	Discharge=xx.x°F	1		Discharge Temp
		Cond Apprch=xx.x°F	2		Condenser Approach Temp
	3	Dsch Suprht=xx.x°F	1		Discharge Superheat
		Evap Apprch=xx.x°F	2		Evap Approach Temp
3	1	Lift Press=xx.xpsi	1		System Lift Pressure
	2	Lift Temp=xx.x°F	1		System Lift Temperature

Press the "NEXT MENU" key and Menu 4 (*Motor Amps*) will be displayed. Menu four has one screen. Line 1, field 1 indicates the percent rated load amps. This value is calculated by comparing measured run amps with a full load amp value entered by the start-up technician. Line 2, field 1 indicates the actual motor amps as measured by a current transformer on one leg of the compressor wiring. Line 3, field 1 indicates the amp limiting value if limiting is being enforced by the control software. Pressing the switch key will toggle between this menu and Menu 13 (*Motor Amp Set Points*). This allows the operator to compare actual operating conditions versus set points.

### Menu 4, Motor Amps

Item					
Screen	Line	Display	Field	Range	Extended Name
1	1	% Rated Ld amps=xx.x%	1		Percent Rated Load Amps
	2	Motor Amps=xxxx	1		Actual Motor Amps
	3	Limit=xxx	1		Effective Amp Limiting

Press the "NEXT MENU" key and Menu 5 (Oil Temperatures) will be displayed. Menu five has one screen. Line 1, field 1 indicates the oil vent pressure as measured with a pressure transducer in the oil sump housing. Line 1, field 2 indicates the oil temperature in the oil sump as measured with a thermister located in the oil sump housing. Line 2, field 1 indicates the oil feed pressure as measured by a pressure transducer in the oil line of the oil pump discharge. Line 2, field 2 indicates the temperature of the oil as measured by a thermister in the oil line after the oil cooler. This is the temperature of the oil that is supplied to the compressor for lubrication. Line 3, field 1 indicates the net oil pressure as calculated by subtracting the evaporator pressure from the oil feed pressure. This indicates the actual oil pump pressure. Pressing the switch key will toggle between this menu and Menu 21 (*Oil Set Points*). This allows the operator to compare actual operating conditions versus set points.

### Menu 5, Oil Temperature

Item					
Screen	Line	Display	Field	Range	Extended Name
1	1	Vent Press=xx.xpsi	1		Oil Vent Pressure
		Sump Temp=xx.x°F	2		Oil Sump Temp
	2	Feed Press=xx.xpsi	1		Oil Feed Pressure
		Feed Temp=xx.x°F	2		Oil Feed Temp
	3	Net Press=xx.xpsi	1		Oil System Net Pressure

Press the "NEXT MENU" key and Menu 6 (*Pump Status*) will be displayed. Menu six has one screen. Line 1, field 1 displays the evaporator pump running status. Line 1, field 2 displays the condenser pump running status. Line 2, field 1 indicates which evaporator pump is operating as the lead pump. Line 2, field 2 indicates which condenser pump is operating as the lead pump. Pressing the switch key will toggle between this menu and Menu 18 (*Pump Set Points*). This allows the operator to compare actual operating conditions versus set points.

**Menu 6, Pump Status**

Item						
Screen	Line	Display	Field	Range	Extended Name	
1	1	Evap	1	Pumps Off	Evaporator Pump Status	
				Pmp #1 Start		
				Pmp #2 Start		
				Pump #1 On		
				Pump #2 On		
				Pumps Fail		
	2	Cond	2	Pumps Off	Condenser Pump Status	
				Pmp #1 Start		
				Pmp #2 Start		
				Pump #1 On		
				Pump #2 On		
				Pumps Fail		
	2	2	Evap Lead=	1	Pmp #1	Currently Selected Lead Pump
					Pmp #2	
Cond Lead=		2			Pmp #1	Currently Selected Lead Pump
					Pmp #2	

Press the "NEXT MENU" key and Menu 7 (*Tower Status*) will be displayed. Menu seven has two screens. Screen 1, line 1, field 1 indicates the current cooling tower stage in operation. This is optional and will be valid only if the chiller is controlling the cooling tower fans. Line 2, field 1 indicates the entering condenser water temperature. Line 3, field 1 indicates the cooling tower bypass valve position. This is optional and will be valid only if a cooling tower valve is controlled by the chiller. Screen 2, line 1, field 1 indicates the outdoor air temperature. This is optional and will be valid if an out door thermistor is installed. Pressing the switch key will toggle between this menu and Menu 19 (*Cooling Tower Control*). This allows the operator to compare actual operating conditions versus set points.

**Menu 7, Tower Status**

Item					
Screen	Line	Display	Field	Range	Extended Name
1	1	Cooling Tower Stage=x	1	1-4	Current Cooling Tower Stage
	2	Ent Condenser Water Temp=			Entering Condenser Water Temp
	3	Cooling. Tower Bypass Valve Pos=xx%		0-100%	Cooling Tower Bypass Valve Position
2	1	Outdoor Air=xx.x°F	1		Outdoor Air Temp

Press the "NEXT MENU" key and Menu 8 (*Operating Hours*) will be displayed. Menu eight has two screens. Line 1, field 1 indicates the total compressor operating hours. Line 1, field 2 indicates the number of compressor starts. Line 2, field 1 indicates time of the last compressor start. Line 2, field 2 indicates the date of the last compressor start. Line 3, field 1 indicates the time of the last compressor stop. Line 3, field 2 indicates the dates of the last compressor stop. Screen 2, line 1, field 1 indicates the run hours of number one evaporator pump. Line 1, field 2 indicates the run hours of number one condenser pump. Line 2, field 1 indicates the run hours of number two evaporator pump. This is optional and requires a second evaporator pump controlled by the chiller. Line 2, field 2 indicates the run hours of the second condenser pump. This is optional and requires a second condenser pump controlled by the chiller.

### Menu 8, Operating Hours

Screen	Line	Display	Item		
			Field	Range	Extended Name
1	1	Comp Hours=xxxx	1		Compressor Operating Hours
		Starts=xxxx	2		Compressor Starts
	2	Last Start=xx:xx mm/dd/yy	1		Time of Last Chiller Start
			2		Date of Last Chiller Start
	3	Last Stop=xx:xx mm/dd/yy	1		Time of Last chiller Stop
			2		Date of Last Chiller Stop
2	1	Evap Pmp #1=xxxx	1		Evap Pump #1 Run Hours
		Cond Pmp #1=xxxx	2		Condenser Pump #1 Run Hours
	2	Evap Pmp #2=xxxx	1		Evaporator Pump #2 Run Hours
		Cond Pmp #2=xxxx	2		Condenser Pump #2 Run Hours

Press the "NEXT MENU" key and Menu 9 (*Network Status*) will be displayed. Menu nine has one screen. This menu is only accessible when you have two series 200 MicroTech panels and one has been configured as a master. This menu only displays on the master MicroTech. The slave MicroTech will not have Menu 9.

Line 1, field 1 displays the active master command status. Line 1, field 2 indicates which chiller is the lead unit. Designation is master or slave. Line 2, field 1 indicates the command to the slave chiller. Line 2, field 2 displays the lead lag configuration. Line 3, field 1 indicates the communication status between the master and slave unit. Pressing the switch key will toggle between this menu and Menu 23 (*Lead Lag Setup*). This allows the operator to compare actual operating conditions versus set points. Menu 23 is only available on the master chiller when a network exists between two 200 Series MicroTech chillers. A network can be established between two single (*PE*) compressor chillers or one (*PF*) dual compressor chiller. The values 'Recr' and 'Auto' will display only if there is a CSC panel providing central control.

### Menu 9, Network Status

Screen	Line	Display	Item		
			Field	Range	Extended Name
1	1	Master Commands	1	Stop	Active Master Command
				Auto	
				Recr	
				Run	
	2	Lead Unit=	2	Master	Control Panel Definition
				Slave	
	2	Slave Commands	1	Stop	Active Slave Command
				Auto	
				Recr	
				Run	
	2	Status=	2	Lead&Lag Off	Lead/Lag System
				Lead On	
Lag On					
Lead&Lag On					
3	Comm Status=	1	No Comm	Status of Communication Link	
			Comm OK		

Press the "NEXT MENU" key and Menu 10 (*Auto Logging*) will be displayed. Menu ten has twenty-four screens. There are four screens per log, therefore, there are six weeks of log information. The MicroTech will automatically record the information listed in screens 1 through 4 (*referred to the active window*) at the time of the highest peak percent run load amps. The first weeks information (*active window*) will be saved in a buffer then cleared to accept the next weeks information. The start day and start time along with the end day and time is configured in Menu 24 (*Service*). Due to the length of the screens, only the first eight are presented. These indicate the active window (*current week*) and previous week of information.

**Menu 10, Auto Logging**

Screen	Line	Display	Item		
			Field	Range	Extended Name
1	1	Wk Ending	1		Date of Current Log
	2	Peak=xxx%	1		Recorded Peak % RLA
		Evap=xx.xpsi	2		Recorded Evaporator Pressure
	3	mm-dd xx:xx	1		Date and Time of Log Entry
Cond=xxx.xpsi		2		Recorded Condenser Pressure	
2	1	Ent Evap=xx.x°F	1		Recorded Ent Evap Water Temp
		Ent Cond=xx.x°F	2		Recorded Ent Cond Water Temp
	2	Lvg Evap=xx.x°F	1		Recorded Lvg Evap Water Temp
		Lvg Cond=xx.x°F	2		Recorded Lvg Cond Water Temp
	3	Evap Aprch=xx.x°F	1		Recorded Evap Approach
		Cond Aprch=xx.x°F	2		Recorded Cond Approach
3	1	Discharge=xx.x°F	1		Recorded Discharge Temp
		SubCool=xx.x°F	2		Recorded Subcooling
	2	Dsch Suprht=xx.x°F	1		Recorded Discharge Superheat
		Suct Suprht=xx.x°F	2		Recorded Suction Superheat
4	1	Sump Temp=xx.x°F	1		Recorded Oil Sump Temp
	2	Feed Temp=xx.x°F	1		Recorded Oil Feed Temp
		Evap Flow=xx.x°F	2		Recorded Evap Water Flow
	3	Feed Press=xx.xpsi	1		Recorded Oil Feed Pressure
		Cond Flow=xxxxgpm	1		Recorded Cond Water Flow
5	1	Wk Ending	1		Date of Previous Log
	2	Peak=xxx%	1		Recorded Peak % RLA
		Evap=xx.xpsi	2		Recorded Evap Pressure
	3	mm-dd xx:xx	1		Date and Time of Log Entry
Cond=xxx.xpsi		2		Recorded Cond Pressure	
6	1	Ent Evap=xx.x°F	1		Recorded Ent Evap Water Temp
		Ent cond=xx.x°F	2		Recorded Ent Cond Water Temp
	2	Lvg Evap=xx.x°F	1		Recorded Lvg Evap Water Temp
		Lvg Cond=xx.x°F	2		Recorded Lvg Cond Water Temp
	3	Evap Aprch=xx.x°F	1		Recorded Evap Approach
		Cond Apprch=xx.x°F	2		Recorded Cond Approach
7	1	Discharge=xx.x°F	1		Recorded Discharge Temp
		Subcool=xx.x°F	2		Recorded Subcooling
	2	Dsch Suprht=xx.x°F	1		Recorded Discharge Superheat
		Suct Suprht=xx.x°F	2		Recorded Suction Superheat
8	1	Sump Temp=xx.x°F	1		Recorded Oil Sump Temp
	2	Feed Temp=xx.x°F	1		Recorded Oil Feed Temp
		Evap Flow=xxxxgpm	2		Recorded Evap Water Flow
	3	Feed Press=xx.xpsi	1		Recorded Oil Feed Pressure
		Cond Flow=xxxxgpm	2		Recorded Cond Water Flow

# Control Menu Description

Press the "CONTROL" key under the 'Category Group' and Menu 11 (*Control Mode*) will be displayed. Menus 11-26 are the control menus. All control set points and value selections are entered into the MicroTech from these menus. The default set point is indicated under the display column and the range of set points or values are indicated in the range column. The service technician responsible for start-up will input all necessary set points and select the proper values for the chiller to operate.

**Warning!**  
**Improper set points or values can cause erratic chiller operation and damage to the chiller. Please use caution whenever changing set points or values.**

Menu 11 has one screen. This menu is password protected and requires the operator password. The operational mode selected will control the chiller as described below until the value is changed.

### Menu 11, Control Mode

		Item			
Screen	Line	Display	Field	Range	Extended Name
1	1	Mode=	1	Service Testing	Selected Unit Operation
				Manual Enable	
				Auto: Network	
				Auto: Local	
				Manual Off	

**Manual Off**—This mode causes the chiller to stop. If the unit is operating, it will go through a controlled shutdown and remain off. If the unit is off, it will remain off.

**Auto:Local**—This mode allows the chiller to operate according to its internal MicroTech set points. Chiller operation will start if the remote start/stop input is made, internal time clock calling for operation and front panel switch set to the auto position.

**Auto:Network**—This mode will control the chiller from a remote panel such as a Chiller System Controller (*CSC*). A network implies two or more 200 series controllers connected to a level 1 device.

**Manual Enable**—This mode allows the chiller to operate if the front panel switch is set to auto. The MicroTech will ignore the remote start/stop input and the internal time clock schedule.

**Service Testing**—This mode shuts down the chiller and the chiller is in the manual off mode. Menu 25 (*Service Testing*) allows the service technician to check the individual outputs and calibrate the selected transducers.

Press the "NEXT MENU" key and menu 12 (*Leaving Evap Set Points*) will be displayed. Menu 12 has three screens. This menu is password protected and requires the operator password.



### Menu 12, Leaving Evap Set Points

Screen	Line	Display	Field	Item	
				Range	Extended Name
1	1	Spt Source=Local	1	Local	Lvg Set Point Source
				Network	
	2	Active Spt=xx.x°F	2		Current Active Set Point
				Local Spt=44.0°F	User Adjustable Chw Set Point
				Startup DT=3.0°F	Startup Delta Temp
				Network Spt=xx.x°F	Chw Spt Supplied by Network
3	Shutdn DT=3.0°F	2	1-3	Shutdown Delta Temp	
2	1	Chw Reset=No Reset	1	No Reset	Chw Reset Method
				Return	
				4-20mA	
				OAT	
				Ice	
	2	Max Lvg Spt=54.0°F	2	10-80	Upper Chw Set Point Limit
				Return Spt=54.0°F	Set point for Return Water Reset
3	Reset Signal=xx.xmA	1	0-20mA	External Reset Signal Amplitude	
			Max Reset At=50°F	Upper OAT Reset Limit	
			2	10-90	
3	1	Pulldn Rate=0.5/m	1	0.1-5.0	Maximum Chw Pulldown Rate

**Spt Source=** The value selected determines the source for the set point.

**Auto:Local**—Will allow the chiller to use it's internal set point selected in this menu screen 1, line 2 (local spt). Local is also the selection if a master/slave arrangement exists between two 200 series controllers for the purpose of lead/lag control and load balance control.

**Auto:Network**—Will control the chiller from a remote panel such as a Chiller System Controller (CSC). A network implies two or more 200 series controllers connected to a level 1 device.

**Active Spt=** This is a status value and cannot be changed. Active spt indicates the current set point (factoring in any reset signals) that is controlling the chiller and can be used to determine if the chiller is maintaining leaving chilled water temperature set point.

**Local Spt=** This is the actual chilled water leaving temperature for the chiller to maintain if there is not a network. **Local spt** is active depending upon which set point source was selected. A value must be entered into **local spt**. This is the default value used to control the chiller if a network communication failure occurs.

**Startup Dt=** This value is added to the **active spt** set point. When the chiller is waiting for load and the water circulating through the evaporator exceeds the **active spt** plus the **startup dt**, the chiller will start operation. Example: **active spt** = 44, **startup dt** = 10, the chiller will start when the water temperature exceeds 54.

The **startup dt** along with the **shutdn dt** can be used to reduce cycling of the chiller.

**Network Spt=** This value cannot be adjusted. It is the value supplied by the network if a network exists. The **active spt** can be compared to the **local spt** and **network spt** to determine which set point is controlling the chiller.

**Shutdn Dt=** This value is subtracted from the **active spt**. When the leaving chilled water temperature reaches this calculated value, the chiller will shutdown. Example: **active spt** = 44, **shutdn dt** = 4, the chiller will shutdown when the water temperature leaving the evaporator is less than 40.

The **shutdn dt** along with the **startup dt** can be used to reduce cycling of the chiller.

**Chw Reset=** There are several methods that can be selected to reset the leaving evaporator chilled water temperature.

**No Reset**—This does not provide any reset and is the default value.

**Return**—This measures the evaporator return water temperature and as the return comes back cooler (*indicating cooling load is reduced*) the leaving water temperature is increased. This reduces motor amps and provides an operational cost savings.

**4-20mA**—This is an optional input to the MicroTech. This input is usually from a building automation system.

As the input changes from 4 to 20 mA, the leaving chilled water temperature is increased from **local spt** (*in a linear manner*) until the **max lvg spt** is reached. When the **spt source** is set to network, the 4-20 mA input is supplied to the master MicroTech control. The master will issue reset instructions to the slave MicroTech. Upon network communication failure the slave unit will revert back to **local spt** control. Network failure on a dual machine will require immediate attention.

**Oat**—The leaving water temperature set point is increased as the outside air temperature decreases. The leaving water temperature set point will be reset upward from the **local spt** to the **max lvg spt** (*in a linear manner*) between the **max reset** and **no reset** values. The outside air temperature can be used to determine when the building load will decrease because of cooler outside air temperatures. Since the building load is reduced the leaving evaporator water temperature can be increased providing reduced operational costs.

**Ice**—This option allows the chiller to operate at temperatures that are required by ice banks. **Ice** option requires an external 24 vac input to change the chiller from regular operation to ice operation. The **local spt** should be set to equal the ice temperature plus the **shutdn dt**. The **max lvg spt** would determine the normal or day operating temperature. All refrigerant set points must be adjusted according to the operating temperatures and pressures.

**Max Lvg Spt**= This is the highest leaving water temperature allowed when using **return**, **4-20** or **oat reset**. This is the day or normal operating temperature if ice is selected as a reset option. If this set point is set to high it can cause the compressor to surge and damage the chiller.

**Return Spt**= This value will control the MicroTech if the **chw reset** option was set to return. When the return water temperature reaches **return spt** the leaving evaporator water temperature will be increased to maintain the **return spt**. The leaving water temperature will not exceed the **max lvg spt**.

**No Reset At**—A value must be entered if **oat** was selected as the **chw reset** option. Select an outside air temperature to stop the reset option.

**Reset Signal**= The actual value of the external reset signal.

**Max Reset At**—A value must be entered if **oat** was selected as the **chw reset** option. Select an outside air temperature at which the maximum reset will occur.

**Pulldn Rate**= This value will determine how fast the MicroTech will allow the chiller to reach **local spt**. The maximum allowable change in the chilled water temperature in degrees per minute. Compressor loading will be inhibited if the rate of change is exceeded.

Press the "NEXT MENU" key and menu 13 (*Motor Amp Set Points*) will be displayed. Menu 13 has 2 screens. This menu is password protected and requires the operator password.

### Menu 13, Motor Amp Set Points

		Item			
Screen	Line	Display	Field	Range	Extended Name
1	1	Amp Reset=No Reset	1	No Reset	Current Limit Method
				Demand Limit	
		Active Spt=0%	2		Active Amp Limit Set Point
	2	Reset Signal=0.0mA	1	0-20mA	Magnitude of External Signal
		Min Amp Spt=40%	2	20-80%	Minimum Amp Limit Value
	3	Network Spt=xx%	1		Network Amp Limit Value
Max Amp Spt=100%		2	40-100%	Maximum Amp Limit Value	
2	1	Soft Load=Off	1	Off-On	Soft Load Active
	2	Begin Amp Lim=40%	1	20-100%	Initial Soft Load Value
	3	Ramp Time=5Min	1	1-60Min	Soft Load Ramp Timer

**Amp Reset**= The value selected determines the type of motor amperage control.

**No Reset**—Allows the MicroTech to control chiller motor amperage depending on chiller load, high and low limits and from manual input.

**Demand Limit**—Allows the MicroTech to control chiller motor amperage based on a remote 4-20 mA signal supplied by a building automation system input. The 4-20 mA signal limits the capacity of the chiller and saves electrical demand charges.

**Active Spt**= This is a status value and cannot be changed. **Active spt** indicates the set point that is controlling the chiller. If current limiting is active, the maximum allowable percent of RLA will be displayed. It is a diagnostic aide when compared to the **max amp spt** value.

**Reset Signal**= A status value indicating the reset signal (*in milliamps*) currently being applied.

**Min Amp Spt**= A value must be entered even if the **demand limit** option was not selected. This is the minimum amperage (*low limit*) of the **demand limit** option and (*low limit*) for normal chiller operation. The chiller will not unload below this value.

**Network Spt**= This value cannot be adjusted (*0-100%*). It is the value supplied by the network level 1 controllers.

**Max Amp Spt**= This value has priority over demand limit and network spt. This should be the maximum operational amperage of the unit. Normal set point would be 100. This value can be used to limit the operational amperage should abnormal conditions exist.

**Soft Load**= This value activates the soft load (*ramp up*) option if set to on. Upon chiller start, soft load takes over control when the chiller amperage is equal to the **begin amp km** and loads up over the **ramp time** to the **max amp spt**.

**Begin Amp Lim**= A value must be entered if the **soft load** option was set to on. Select an amperage value that allows the chiller to start and establish proper operating conditions. This will eliminate nuisance start up trips.

**Ramp Time**= The default ramp time is usually adequate; however the soft load time can be extended up to 60 minutes.

Press the "NEXT MENU" key and menu 14 (*Set Time/Date*) will be displayed. Menu 14 has one screen. This menu is password protected and requires the operator password.

These values must be set in the menu to allow MicroTech to control start/stop and holiday functions. MicroTech will not start the chiller until this menu is completed.

**Menu 14, Set Time Date**

		Item			
Screen	Line	Display	Field	Range	Extended Name
1	1	hh:mm:ss	1	00:00:00-23:59:59	Current Hour, Min, Sec
		day	2	Sun-Sat	Current Day
		mm-dd-yy	3	Jan-Dec, 1-31,00-99	Current Date

Press the "NEXT MENU" key and menu 15 (*Schedule*) will be displayed. Menu 15 has two screens. This menu is password protected and requires the operator password.

### Menu 15, Schedule

Screen	Line	Display	Item		
			Field	Range	Extended Name
1	1	Override=00.0Hr	1	00.00-63.75	Manual Schedule Override
		Network Sched=	2	1-32	Network Time Schedule
	2	Sun 00:00-23:59	1	00:00-23:59	Sunday Run Schedule
		Tue 00:00-23:59	2	00:00-23:59	Tuesday Run Schedule
	3	Mon 00:00-23:59	1	00:00-23:59	Monday Run Schedule
		Wed 00:00-23:59	2	00:00-23:59	Wednesday Run Schedule
2	1	Thu 00:00-23:59	1	00:00-23:59	Thursday Run Schedule
		Sat 00:00-23:59	2	00:00-23:59	Saturday Run Schedule
	2	Fri 00:00-23:59	1	00:00-23:59	Friday Run Schedule
		Hol 00:00-23:59	2	00:00-23:59	Holiday Run Schedule
	3	One Event N/A-00:00-23:59	1	Jan-Dec	Time Schedule Override
			2	00-31	
			3	00:00-23:59	

**Override=** This allows the operator (manual input) to input a time value that the MicroTech will ignore the normal or holiday start/stop schedule. This timed override will start when the value is entered.

**Network Sched=** Network schedules can be provided through a network master panel when the **Mode** (menu 11) is set to **auto:network**. If a master/slave arrangement is active, the master panel will control the schedule. The slave unit should be programmed the same as the master to have consistent operation should the network communications fail.

**Sun thru Fri**—The start time (*first value*) and stop time for each day of the week should be entered. The default value (00:00-23:59) allows the chiller to operate continuously.

**Hol**—The time entered at this menu will control the chiller run time for the holiday dates entered in menu 16 (*holiday date*).

**One Event**—This is a one time schedule which will allow the chiller to operate on the month, day and time specified. This allows a special override time to be set in advance instead of using the **Override** as described above.

Press the "NEXT MENU" key and menu 16 (*Holiday Date*) will be displayed. Menu 16 has three screens. This menu is password protected and requires the operator password. Screen one has 1-6, screen two has 7-12 and screen three has 13-14 holiday dates. The first screen is shown for description purposes. The month, day and number of days in the holiday is selected. The start and stop time was selected in menu 15 (*Schedule*).

### Menu 16, Holiday Date

Screen	Line	Display	Item		
			Field	Range	Extended Name
1	1	#1=N/A-00 00 Day(s)	1	Jan-Dec	Holiday Month
			2	00-31	Holiday Date
			3	00-31	Duration Days
		#4=N/A-00 00 Day(s)	1	Jan-Dec	Holiday Month
			2	00-31	Holiday Date
			3	00-31	Duration Days
	2	#2=N/A-00 00 Day(s)	1	Jan-Dec	Holiday Month
			2	00-31	Holiday Date
			3	00-31	Duration Days
		#5=N/A-00 00 Day(s)	1	Jan-Dec	Holiday Month
			2	00-31	Holiday Date
			3	00-31	Duration Days
	3	#3=N/A-00 00 Day(s)	1	Jan-Dec	Holiday Month
			2	00-31	Holiday Date
			3	00-31	Duration Days
		#6=N/A-00 00 Day(s)	1	Jan-Dec	Holiday Month
			2	00-31	Holiday Date
			3	00-31	Duration Days

Table Continued

**Table 16 Continued**

Screen	Line	Display	Item			
			Field	Range	Extended Name	
2	1	#7=N/A-00 00 Day(s)	1	Jan-Dec	Holiday Month	
			2	00-31	Holiday Date	
			3	00-31	Duration Days	
		#10=N/A-00 00 Day(s)	1	Jan-Dec	Holiday Month	
			2	00-31	Holiday Date	
			3	00-31	Duration Days	
	2	2	#8=N/A-00 00 Day(s)	1	Jan-Dec	Holiday Month
				2	00-31	Holiday Date
				3	00-31	Duration Days
		#11=N/A-00 00 Day(s)	1	Jan-Dec	Holiday Month	
			2	00-31	Holiday Date	
			3	00-31	Duration Days	
3	3	#9=N/A-00 00 Day(s)	1	Jan-Dec	Holiday Month	
			2	00-31	Holiday Date	
			3	00-31	Duration Days	
	#12=N/A-00 00 Day(s)	1	Jan-Dec	Holiday Month		
		2	00-31	Holiday Date		
		3	00-31	Duration Days		
3	1	#13=N/A-00 00 Day(s)	1	Jan-Dec	Holiday Month	
			2	00-31	Holiday Date	
			3	00-31	Duration Days	
	2	#14=N/A-00 00 Day(s)	1	Jan-Dec	Holiday Month	
			2	00-31	Holiday Date	
			3	00-31	Duration Days	

Press the "NEXT MENU" key and menu 17 (*Timers*) will be displayed. Menu 17 has one screen. This menu is password protected and requires the operator password.

**Menu 17, Timers**

Screen	Line	Display	Item		
			Field	Range	Extended Name
1	1	Start-Start=15Min	1	15-60 Min	Start to Start Delay Timer
	2	Evap Recirc=15Sec	1	15 Sec-5 Min	Chilled Water Recirculation Timer
	3	Stop-Start=3Min	1	3-20 Min	Stop to Start Delay Timer

**Start-Start=** This value determines the minimum time between chiller starts. The chiller must run the time selected before it will start again. If the chiller runs less that the time selected the timer will have to time out before another start is allowed. This is to eliminate chiller cycling that could damage the motor by starting to frequently.

**Evap Recirc=** This value determines the time the chilled water pump must run before the start sequence is started. This value insures that the chilled water system has an adequate load to start the chiller. It also insures that the chilled water pump has time to establish constant flow in the system to prevent nuisance water flow switch trips.

**Stop-Start=** This value is similar to the Start-Start already described. This time insures that there is adequate time between stop to start for the chiller to become stable or pressures to equalize. This can also be used to minimize short cycling.

Press the "NEXT MENU" key and menu 18 (Pump Set Points) will be displayed. Menu 18 has one screen. This menu is password protected and requires the operator password.

**Menu 18, Pump Set Points**

				Item	
Screen	Line	Display	Field	Range	Extended Name
1	1	Evap=Pmp 1 Only	1	Pmp 1 Only	Evap Pump Selection Mode
				Pmp 2 Only	
				Auto Lead	
				#1 Primary	
				#2 Primary	
	2	Cond=Pmp 1 Only	1	Pmp 1 Only	Cond Pump Selection Mode
				Pmp 2 Only	
				Auto Lead	
				#1 Primary	
				#2 Primary	

**Evap=** This value determines how the pumps will be controlled by the MicroTech. The controlling of the pump(s) is optional.

**Pmp 1 Only**—The pump designated as number 1 will be started and the second pump (*number 2*) will not be started if number 1 fails.

**Pmp 2 Only**—The pump designated as number 2 will be started and the second pump (*number 1*) will not be started if number 2 fails.

**Auto Lead**—The MicroTech will try and balance the operating hours between the two pumps by starting the pump with the least amount of run time. In case of pump failure, the MicroTech will start the next pump.

**#1 Primary**—The number 1 pump will be started each time with number 2 as a standby. If pump 1 fails the standby pump will be started.

**#2 Primary**—The number 2 pump will be started each time with number 1 as a standby. If pump 2 fails the standby pump will be started.

**Cond=** This value determines how the pumps will be controlled by the MicroTech. The controlling of the pump(s) is optional.

**Pmp 1 Only**—The pump designated as number 1 will be started and the second pump (*number 2*) will not be started if number 1 fails.

**Pmp 2 Only**—The pump designated as number 2 will be started and the second pump (*number 1*) will not be started if number 2 fails.

**Auto Lead**—The MicroTech will try and balance the operating hours between the two pumps by starting the pump with the least amount of run time. In case of pump failure, the MicroTech will start the next pump.

**#1 Primary**—The number 1 pump will be started each time with number 2 as a standby. If pump 1 fails the standby pump will be started.

**#2 Primary**—The number 2 pump will be started each time with number 1 as a standby. If pump 2 fails the standby pump will be started.

Press the "NEXT MENU" key and menu 19 will be displayed. When cooling tower control is desired, up to four digital outputs may be used to stage multiple tower fans. An optional analog output is available for tower bypass valve control. Separate temperature set points are provided for each cooling tower stage. The first tower stage is turned on when the entering condenser water temperature exceeds the stage 1 set point. Subsequent stages are turned on when the time since the last stage change exceeds the minimum stage up time. The number of stages will not be increased above the total number of tower stages defined in the cooling tower menu. The number of tower stages is decreased when the entering condenser water temperature drops below the current stage set point by more than the stage differential and the time since the last stage change exceeds the minimum

stage down time. The number of stages also will be decreased when the maximum number of stages is less than the current stage.

The sequence described above allows stages to be turned on based on temperature only or on a combination of temperature and time. Control may be based only on temperature by setting the stage 1 set point lowest and the other stages set points successively higher. This provides automatic reset of the condenser water as the tower capacity requirements increases. If a specific entering condenser water temperature is desired at all times, the set points for all stages can be set to the same value and staging is based on that temperature and the stage up and stage down timers.

### Menu 19, Cooling Tower Control

Item					
Screen	Line	Display	Field	Range	Extended Name
1	1	Tower Control=Yes	1	Yes No	Tower Control
		Tower Stages=2	2	1-4	Total Cooling tower Stages
	2	StageUp time=2Min	1	2-60 Min	Stage Up Delay
		StageDn Time=5Min	2	1-60 Min	Stage Down Delay
3	Stage Differential=3.0°F	1	1-10°F	Staging Differential	
2	1	Stage #1 On=70.0°F	1	40-120°F	Stage #1 Set point
		Stage #4 On=70.0°F	2	40-120°F	Stage #4 Set point
		Stage #2 On=70.0°F	1	40-120°F	Stage #2 Set point
		Stage #3 On=70.0°F	1	40-120°F	Stage #3 Set point

**Tower Control**= Set this value to 'yes' for fan staging control or by-pass valve control and 'no' if condenser water temperature is not controlled by the MicroTech.

**Tower Stages**= This value will determine how the MicroTech calculates the time to increase or decrease the cooling tower controlling sequence. The number of stages refers to cooling tower fans or to bypass valve control.

**Stageup Time**= This value will delay the MicroTech from starting the staging control. This can be used to provide specific system control requirements.

**Stagedn Time**= This value will delay the MicroTech from staging down for the time specified. This can be used to provide specific system control requirements.

**Stage Differential**= This value is the control band for the fan staging control logic. This value must be exceeded to stage up or down.

**Stage #1 On**= This value determines when the first stage control will start. This value plus 1/2 the stage differential determines the control point value. This value is active on stage up and stage down.

**Stage #2-4 On**= Same as **Stage #1 On**.

Press the "NEXT MENU" key and menu 20 will be displayed. This menu will provide control of the cooling tower valve. If a bypass valve is to be used to provide a low limit for the tower, the valve set point should be set for the Valve Control method and the valve set point should be less than the fan stage 1 set point. In this situation, the number of cooling tower stages is increased only when the valve position exceeds the maximum position set point so the valve is fully open to the tower when any cooling tower stage is on. The entering condenser water temperature will vary as stages are turned on and off.

If a relatively constant entering condenser water temperature is desired, the valve set point should be selected as the Stage Control method. In this situation the valve is modulated to maintain the current stage temperature set point. The number of cooling tower stages is increased only when the valve position exceeds the maximum position set point and the temperature and time requirements described above for staging up are met. The valve will then modulate closed when the temperature starts to drop after the fan stage is added.

The number of cooling tower stages is decreased only when the valve position drops below the minimum position set point and the temperature and time requirements described above for fan staging down are met. The valve then modulates open as the temperature starts to rise after the fan stage is turned off.

When the chiller is commanded to start, and either type of valve control is selected, the bypass valve is positioned to anticipate the heat rejection needed at the time of startup. When condenser flow has not been confirmed, but the chiller is in the start requested state, the valve position is based on the minimum position, maximum position and Oat set points. If the optional outdoor air temperature sensor is not installed, the valve position is determined solely by the minimum and maximum position set points. If the maximum and minimum positions are set to the same value, the valve will always be set to that fixed position prior to start-up.

### Menu 20, Tower Valve Control

Item					
Screen	Line	Display	Field	Range	Extended Name
1	1	Valve Control=None	1	None	Cooling Tower Bypass Ctrl Type
				Valve Set Point	
				Stage Set Point	
	2	Valve Spt=65.0°F	1	40-99.5°F	Bypass Valve Control Set Point
		Value Deadb=2.0°F	2	1.0-10.0°F	Bypass Valve Control Dead Band
	3	Min Position=20%	1	0-50%	For Calculating Valve Position
Max Positon=80%		2	50-100%	For Calculating Valve Position	
2	1	Valve Type=NC	1	NC to Tower	Bypass Valve Default Position
				NO to Tower	
	2	Mod Limit=7.5°F	1	4.0-25.0°F	Bypass Valve Modulation Limit
	3	Sample time=15Sec	2	15Sec-15Min	Ent Cond Temp Integration Time
		Max Change=4%	1	1-20%	Max Allowable Valve Pos Change
	PA Time=15Min	2	1.0-60 Min	Proj Ahead Calculation Window	
3	1	Min Start Pos=0%	1	0-100%	Min Valve Position at Startup
		Max Start Position=100%	2	0-100%	Max Valve Position at Startup
	2	Min Pos At=60°F	1	0-99.5°F	OAT for Minimum Position
		Max Pos At=90°F	2	0-99.5°F	OAT for Maximum Position

**Valve Control**= A value must be selected telling the MicroTech which type of control will be used for the tower valve. If none is selected, the remaining values are not required for tower control.

**Valve Spt**= This value is the water temperature the MicroTech will maintain by modulating the tower valve.

**Valve Deadb**= This value is the control dead band that is used in the MicroTech when calculating control actions.

**Min Position**= This value is used in calculating when the valve position will change. The default values should be adequate for most applications.

**Max Position**= This value is used in calculating when the valve position will change. The default values should be adequate for most applications.

**Valve Type**= This value indicates the type of output (*increasing or decreasing voltage*) supplied to the control valve controller. If the valve requires an 0-10 Vdc to open select the 'N/C' valve. The 'N/O' selection would provide a 0 Vdc for valve to be open and a 10 Vdc for the valve to be fully closed.

**Mod Limit**= This value is used in MicroTech calculations and can increase or decrease the controller sensitivity.

**Sample Time**= This value determines how frequently the MicroTech looks at the water temperature entering the condenser.

**Max Change**= The value limits the amount the valve position can change at one time.

**PA Time**= This value will reduce control point overshoot and produce quicker response to load variations.



**Min Start Pos=** This value will control the minimum position of the valve during pre-start at a pre-selected (*Min Pos At=*) outside air temperature.

**Max Start Pos=** This value will control the maximum position of the valve during pre-start at a pre-selected (*Max Pos At=*) outside air temperature.

**Min Pos At=** The outside air temperature associated with the Min Start Pos=.

**Max Pos At=** The outside air temperature associated with the Max Start Pos=.

Press the "NEXT MENU" key and menu 21 (*Oil Set Points*) will be displayed. Menu 21 has one screen. This menu is password protected and requires the service password. These values are set by the start up technician. Changing these values could cause compressor damage. The menu can be monitored and set points compared to actual operating conditions.

**Menu 21, Oil Set Points**

Item					
Screen	Line	Display	Field	Range	Extended Name
1	1	Feed Spt=100.0°F	1	90-190°F	Oil Feed Set Point
	2	No Start Diff=40.0°F	1	30-60°F	
	3	Htr On Diff=30.0°F	1	10-40°F	

Press the "NEXT MENU" key and menu 22 (*Alarm Set Points*) will be displayed. Menu 22 has six screens. This menu is password protected and requires the service password. These values are set by the start up technician. Changing these values could cause compressor damage. The menu can be monitored and set points compared to actual operating conditions.

**Menu 22, Alarm Set Points**

Item					
Screen	Line	Display	Field	Range	Extended Name
1	1	Low Evap Press-Shutdn 26.0psi	1	10-45psi	
	2	Low Evap Press-Unload 31.0psi	1	10-45psi	
	3	Low Evap Press-hold 38.0psi	1	10-45psi	
2	1	High Dsch Temp-Shutdn 190.0°F	1	120-240°F	
	2	High Dsch Temp-Load 170.0°F	1	120-240°F	
	3	High Cond Press-Shutdn 140.0psi	1	120-240psi	
3	1	Motor Current threshold 10%	1	1-20%	
	2	High Oil Feed Temp 140.0°F	1	120-150°F	
	3	Low Oil Delta Temp 40.0°F	1	20-80°F	
4	1	Low Net Oil Press 50.0psi	1	40-60psi	
	2	Low Dsch Sprht at Min RLA 15.0°F	1	0-50°F	
	3	High Dsch Sprht at Min RLA 70.0°F	1	10-90°F	
5	1	Low Dsch Sprht at Max RLA 6.0°F	1	0-50°F	
	2	High Dsch Sprht at Max RLA 25.0°F	1	10-90°F	
	3	Surge-Hi Suct Sprht-Starting 50.0°F	1	25-90°F	
6	1	Surge-Hi Suct Sprht-Running 25.0°F	1	5-45°F	
	2	Evap Water Freeze 34.0°F	1	-9 - 45°F	
	3	Cond Water Freeze 34.0°F	1	-9 - 45°F	

Press the "NEXT MENU" key and menu 23 (*Lead Lag Setup*) will be displayed. Menu 23 has two screens. This menu is password protected and requires the operator password. If 'master' is selected in menu 26, screen two, then menu 23 is available on the master unit only. This relates to having a network consisting of two MicroTechs, and operating in a master/slave mode. The start up technician will set all values.

### Menu 23, Lead Lag Setup

Screen	Line	Display	Item		
			Field	Range	Extended Name
1	1	Slave Address=01.00	1	00-09	Slave Unit Network Address
		Start-Up=NotUnld	2	NoUnload Unload	Unload Lead During Lag Start
	2	LL Mode=auto	1	Auto	Lead Lag Control Mode
				Slave Lead	
				Master Lead	
		Enable Lag=95%	2	0-100%	Lag Start Threshold
	3	LL SwOver=N/A	1	N/A	Scheduled Lead Unit Switch Over Day
				Sun	
				Mon	
				Tue	
Wed					
Thu					
Fri					
Sat					
	Disable Lag=40%	2	1-100%	Lag Stop Threshold	
2	1	Delay timer=5Min	1	1-60Min	Lag Unit time Delay
	2	Lag-Standby=No	1	No-Yes	Lag Unit Standby Operation

**Slave Address=** This value is the network address of the slave MicroTech. The wrong value will disconnect the communications between the chillers and they would revert back to local control. This could cause damage to a dual chiller unit. The slave address should be 01.01.

**Start-Up=** This value directs the lead chiller to unload or not to unload. A dual chiller must unload the lead chiller when starting the lag chiller. This is optional in a two (2) single chiller configuration.

**LL Mode=** The value selected will direct the network to start the chillers in a fixed sequence.

**Auto—**The chiller with the least run time will start as the lead unit. The chiller with the most run time will turn off first when only one chiller is required to meet load conditions.

**Slave Lead—**The slave chiller will start first each time and the master chiller will shutdown when only one chiller is needed to meet load requirements.

**Master Lead—**The master chiller will start first each time and the slave chiller will shutdown when only one chiller is needed to meet load requirements.

**Enable Lag=** This is the amp value (*percentage*) when the lag chiller will be started. This value must be maintained for a predetermine amount of time to indicate a true load.

**LL SwOver=** Day of week for lead lag switch to occur.

**Disable Lag=** This is the amp value (*percentage*) when the lag chiller will be shutdown. This value must be maintained for a predetermine amount of time to indicate a true load.

**Delay Timer=** This value is used to delay the starting and stopping of the lag chiller. The maximum amps must be maintained for the period of the **Delay Timer** value before the lag chiller will start. The minimum amps must be maintained for the period of the **Delay Timer** value for the lag chiller to stop.

**Lag-Standby=** This value sets the lag chiller as a standby chiller and will only start if the lead chiller fails.

Press the "NEXT MENU" key and menu 24 (*Service*) will be displayed. Menu 24 has three screens. This menu is password protected and requires the service password.

**Menu 24, Service**

Screen	Line	Display	Item			
			Field	Range	Extended Name	
1	1	Manual Load=Off	1	Off-on	Enable Manual Loading	
		Hot Gas Bypass=30%	2	20-70%	Hot Gas Bypass Enable Setpoint	
	2	Setpoint=40%	1	0-100%	Manual Load Setpoint	
		Post Lube=15	2	10Sec-5Min	Oil Pump Delay Off Time	
		Timers=Normal	1	Normal	Setup Timers for Service	
2	Fast		Maximum Shutdown Delay			
2	1	Auto Log Window	1	Sun-Sat	Auto Log Start Date	
			1	00:00-23:59	Auto Log Start Time	
			2	Sun-Sat	Auto Log Stop Date	
			2	00:00-23:59	Auto Log Stop time	
	2	Evap Offset=0.0psi	1	-9.9psi - 15.0psi	Evap Press Transducer Calibration	
		Oil Feed=0.0psi	2	-9.9psi - 15.0psi	Oil Feed Press Transducer Calibration	
	3	Cond Offset=0.0psi	1	-9.9psi - 15.0psi	Cond Press Transducer Calibration	
		Oil Vent=0.0psi	2	-9.9psi - 15.0psi	Oil Vent Press Transducer Calibration	
	3	1	Tower Bypass Valve=0mA/0VDC	1	0mA/0VDC - 4mA/1VDC/2VDC	Controls Output of AOX Board
		2	Mtr Current Input=0mA/0VDC	1	0mA/0VDC - 4mA/1VDC/2VDC	Input signal Conditioner for Motor Current
3		Pump Down=No	1	No-Yes	Pump Down on Stop	

Press the "NEXT MENU" key and menu 25 (*Service Testing*) will be displayed. Menu 25 has five screens. This menu is password protected and requires the service password.

**Menu 25, Service Testing**

Screen	Line	Display	Item		
			Field	Range	Extended Name
1	1	Output #0=Off	1	Off-On	Manual Output Control
		Output #3=Off	2	Off-On	Manual Output Control
	2	Output #1=Off	1	Off-On	Manual Output Control
		Output #4=Off	2	Off-On	Manual Output Control
		3	Output #2=Off	1	Off-On
Output #5=Off	2		Off-On	Manual Output Control	
2	1	Output #6=Off	1	Off-On	Manual Output Control
		Output #9=Off	2	Off-On	Manual Output Control
	2	Output #7=Off	1	Off-On	Manual Output Control
		Output #10=Off	2	Off-On	Manual Output Control
		3	Output #8=Off	1	Off-On
Output #11=Off	2		Off-On	Manual Output Control	
3	1	Output #12=Off	1	Off-On	Manual Output Control
		Output #15=Off	2	Off-On	Manual Output Control
	2	Output #13=Off	1	Off-On	Manual Output Control
		Output #16=Off	2	Off-On	Manual Output Control
		3	Output #14=Off	1	Off-On
Output #17=Off	2		Off-On	Manual Output Control	
4	1	Output #18=Off	1	Off-On	Manual Output Control
		Output #21=Off	2	Off-On	Manual Output Control
	2	Output #19=Off	1	Off-On	Manual Output Control
		Output #22=Off	2	Off-On	Manual Output Control
		3	Output #20=Off	1	Off-On
Output #23=Off	2		Off-On	Manual Output Control	
5	1	DI #0-7=00000000	1		Digital Input Status (0-7)
	2	DI #8-15=00000000	1		Digital Input Status (8-15)
	3	AI #19=0.0VDC	1		Analog Signal at Input 19 (Ref)

## Basic Chiller Setup

Press the "NEXT MENU" key and menu 26 (*Unit Setup*) will be displayed. Menu 26 has three screens. This menu is password protected and requires the operator password. Changing the values in this menu can cause network communications failure.

There are several menus that require resetting the default values for proper unit operation. The setup procedure will be performed by the startup technician and the information should be recorded for future use. This following procedure will show how to setup a single compressor (*WSC*) stand-alone unit without a network.

Set the toggle switch on the face of the MicroTech panel to the stop position. Press the "ALARM" key under the Category group. This brings up menu 27. Press the "PREV. MENU" key and menu 26 will be displayed. Menu 26 should be the first menu to be modified because the information entered affects other menus. The following will be in the sequence displayed on the screen. The values entered will depend upon the unit and the information required should be obtained and recorded before an attempt is made at inputting the data.

### Menu 26, Unit Setup

Item								
Screen	Line	Display	Field	Range	Extended Name			
1	1	IDENT=CFG3E04I	1		Software Version			
		Unit Type=WSC063	2	WSC048	Chiller Model Number			
				WSC050				
				WSC063				
				WSC079				
				WSC087				
				WSC100				
	2	Config=L2 TTY-Slave	1	L1-TTY-Master	Unit Controller Configuration			
				L1-TTY-TTY				
				L2-Master-Slave				
				L2-TTY-Slave				
				L3-TTY-Slave				
	3	Chiller Only	2	Chiller	Chiller Control Options			
				Templifier				
	3	Port A Baud =9600	1	1200	Port A Comm Rate			
2400								
4800								
9600								
Low Temperature=No		2	No-Yes	Ice Operation				
2	1	Master/Slave=Slave	1	Master	Network Configuration			
				Slave				
	2	OAT Sensor=None	1	Evap Gpm Sensor=No	Evaporator Flow Transmitter			
				Yes-No				
				None		Location of OAT		
				Local				
				Remote				
3	Ambient Lockout=No	1	0-65535	Maximum Flow Rate				
			Yes-No					
3	1	Cond Full Gpm=6500	1	0-65535	Maximum Flow Rate			
				Yes-No				
	2	Oil Cooler=Solenoid	2	Valve	Oil Cooler Control Method			
				Solenoid				
	3	Refrig Leak Sen=No	1	Yes-No	Refrigerant Leak Sensor Signal			
				Full Load Amp=300		2	0-65535	Chiller RLA
							Yes-No	

**Unit Type**= This value is the chiller unit model number. The MicroTech has different look up tables depending on the type of chiller.

**Ident**= This is the MicroTech software identification.

**Config**= This defines the network communication link, com port type and MicroTech controller level. The first field indicates the controller's network hierarchy. The second field indicates Port A's protocol. TTY is equal to the RS232 type and Master/Slave is equal to the RS 485 type.

**Chiller**= This value defines the chiller as a cooling only unit (*only*) or templifier unit.

**Port A Baud**= This value defines the communication baud rate for port A. This is critical if there is a network. (*Port A baud rate must be set to 9600 on the master unit.*)

**Low Temperature**= This value selects the operational mode of the unit. If 'ice' is selected, the MicroTech default values have to be reset to match the system requirements for an "Ice" application.

**Master/Slave**= This defines the network relationship between the two MicroTechs. For lead/lag operation, one controller must be set as the master and the other controller must be set as the slave. The master unit provides the control setpoints as long as the network is active. Menu 23 will be available only on the master unit.

**Evap Gpm Sensor**= Optional. This value defines if a flow sensor is present for the MicroTech to monitor.

**Oat Sensor**= This value defines if an outside air sensor is present for the MicroTech to monitor and use in the control decisions.

**Evap Full Gpm**= This value defines the full flow capabilities of the evaporator flow sensor. The MicroTech scales the value linearly between 4 and 20 milliamp input or 0 to 10VDC input.

**Ambient Lockout**= This value determines (*according to the outside air temperature*) the point that no chiller operation is needed.

**Cond Gpm Sensor**= Optional. This value defines if a flow sensor is present for the MicroTech to monitor.

**Cond Full Gpm**= This value defines the full flow capabilities of the condenser flow sensor. The MicroTech scales the value linearly between 4 and 20 milliamp input or 0 to 10 VDC input.

**Oil Cooler**= This value defines the type of oil cooler control valve and the type of control output the MicroTech will provide. Select **solenoid** for our standard solenoid and water regulating valve combination. Select **valve** for the special optional electric relay type valve used in place of our standard arrangement.

**Refig Leak Sen**= Optional. This value defines if a refrigerant leak detector is present in the system.

**Full Load Amp**= This value must match the compressor label value indicating the RLAs of the chiller unit. Several control and safety functions reference this value.

**Ht Recovery Sensor**= This value defines if heat recovery sensors are present for the MicroTech to monitor.

# Alarm Menus Description

Press the "ALARM" key under the 'Category Group' and menu 27 (*Alarms*) will be displayed. Menus 27-35 are the alarm menus.

Menu 27 has four screens. This menu is a display and does not require a password. The values displayed indicate the current alarm and the conditions at the time the alarm reported. When another alarm reports the values in this menu will be shifted to menu 28 (*Alarm Buffer #1*). Each time another alarm reports the alarms are shifted and the alarm buffers #1-#8 (*Menu 28-35*) are filled. The oldest alarm will be removed from memory. This allows for the current alarm and eight (8) previous alarms to be recorded for troubleshooting purposes.

## Menu 27, Current Alarm

Item					
Screen	Line	Display	Field	Range	Extended Name
1	1	No Active Alarms	1	Alarm Status Table	Current Alarm
		At 0:00	2	00:23-23:59	Time of Alarm
		On N/A-00	3	Jan-Dec/01-31	Date of Alarm
	2	Unit Status	1	Alarm Status Table	Unit Operating Mode at Alarm
		Ent Evap=xxx.x°F	2		Ent Evap Chw Temp at Alarm
		Motor Current=xxx%	1	0-100%	Percent RLA at Alarm
2	1	Lvg Evap=xxx.x°F	2		Lvg Evap Chw Temp at Alarm
		Ent cond=xxx.x°F	1		Ent Cond Water Temp at Alarm
	2	Cond=xxx.xpsi	2		Cond Refrigerant Press at Alarm
		Lvg Cond=xxx.x°F	1		Lvg Cond Water Temp at Alarm
	3	Evap Aprch=xxx.x°F	2		Evap Approach at Alarm
		Evap=xx.xpsi	1		Evap Refrigerant Press at Alarm
3	1	Cond Aprch=xxx.x°F	2		Cond Approach at Alarm
		Dischance=xxx.x°F	1		Discharge Temp at Alarm
	2	Subcool=xxx.x°F	2		Subcooling at Alarm
		Dsch Suprht=xxx.x°F	1		Discharge Superheat at Alarm
	3	Sump Temp=xxx.x°F	2		Oil Sump Temp at Alarm
		Suct Suprhtxxx.x°F	1		Suction Superheat at Alarm
4	1	Feed Tempxxx.x°F	2		Oil Feed Temp at Alarm
		Feed Press=xx.xpsi	1		Oil Feed Pressure at Alarm
	2	Evap Flow=xxxxgpm	1		Evaporator Water Flow at Alarm
		Cond Flow=xxxxgpm	1		Condenser Water Flow at Alarm

Press the "NEXT MENU" key and menu 28 (*Alarm Buffer #1*) will be displayed. Menu 28 has four screens. This menu is a display and does not require a password. This is the first of eight alarm buffers. The information displayed can provide troubleshooting information.

## Menu 28, Alarm Buffer #1

Item					
Screen	Line	Display	Field	Range	Extended Name
1	1	No Active Alarms	1	Alarm Status Table	Current Alarm
		At 0:00	2	00:23-23:59	Time of Alarm
		On N/A-00	3	Jan-Dec/01-31	Date of Alarm
	2	Unit Status	1	Alarm Status Table	Unit Operating Mode at Alarm
		Ent Evap=xxx.x°F	2		Ent Evap Chw Temp at Alarm
		Motor Current=xxx%	1	0-100%	Percent RLA at Alarm
2	1	Lvg Evap=xxx.x°F	2		Lvg Evap Chw Temp at Alarm
		Ent cond=xxx.x°F	1		Ent Cond Water Temp at Alarm
	2	Cond=xxx.xpsi	2		Cond Refrigerant Press at Alarm
		Lvg Cond=xxx.x°F	1		Lvg Cond Water Temp at Alarm
	3	Evap Aprch=xxx.x°F	2		Evap Approach at Alarm
		Evap=xx.xpsi	1		Evap Refrigerant Press at Alarm
3	1	Cond Aprch=xxx.x°F	2		Cond Approach at Alarm
		Dischance=xxx.x°F	1		Discharge Temp at Alarm
	2	Subcool=xxx.x°F	2		Subcooling at Alarm
		Dsch Suprht=xxx.x°F	1		Discharge Superheat at Alarm
	3	Sump Temp=xxx.x°F	2		Oil Sump Temp at Alarm
		Suct Suprhtxxx.x°F	1		Suction Superheat at Alarm
4	1	Feed Tempxxx.x°F	2		Oil Feed Temp at Alarm
4	1	Feed Press=xx.xpsi	1		Oil Feed Pressure at Alarm

2	Evap Flow=xxxxgpm	1	Evaporator Water Flow at Alarm
3	Cond Flow=xxxxgpm	1	Condenser Water Flow at Alarm

Follow the above sequence to view the alarm menu 29-35 (Alarm Buffers #2-#8).

Press the "NEXT MENU" key and menu 36 (*Alarm Output*) will be displayed. Menu 36 has one screen. This menu is password protected and requires the operator password. Menu 36 controls how the alarms are reported through the alarm relay. The alarm relay is the interface to most building automation systems or alarm device such as a bell or light.

Alarms are categorized into three different types. The alarms are defined as warnings, problems and faults. A warning is a pre-alarm condition and an indication of a potential problem. Problems are alarms that the MicroTech will cause a control modifications in an attempt to correct the problem. Faults are alarms that cause an immediate system shutdown to protect the chiller and its components.

Menu 36 controls the reporting of these alarms via the alarm relay. Use this menu to have only the alarms report that are necessary for your system.

### Menu 36, Alarm Output

Screen	Line	Display	Field	Range	Extended Name
1	1	Alarm-Normal=Open	1	Open	Alarm Reporting and Control of Alarm Relay
				Close	
		Problems=Fast	2	Fast	
				Slow	
				Close	
				Open	
	2	Comm Loss=Slow	1	Fast	
				Slow	
		Faults=Close	2	Fast	
				Slow	
				Close	
				Open	
3	Warnings=Slow	1	Fast		
			Slow		
			Close		
			Open		

**Alarm-Normal**= This value defines how the alarm contact will be in its normal (*non alarm*) position. Normally open or normally closed. All alarms as they report will cause the alarm output to close or open depending on this setting.

**Problems**= This value will define how problems will report (*open/close*) or how (*fast/slow*) the reporting will occur. Only one can be selected. If fast/slow is selected the alarm contact logic will follow the 'Alarm-Normal' value selected. Problem alarms are self-clearing but will be recorded into the alarm buffers. Problems are defined as conditions where the MicroTech will try corrective actions to avoid unit shutdown. Example, high head pressure. The MicroTech would unload the compressor to a point where the head pressure was in an acceptable range.

**Comm Loss**= This value must be set if a network exists. This value will define how the 'Com Loss' will report (*open/close*) or how (*fast/slow*) the reporting will occur. Only one can be selected. If fast/slow is selected the alarm contact logic will follow the 'Alarm Normal' value selected.

**Faults**= This value will define how faults will report (*open/close*) or how (*fast/slow*) the reporting will occur. Only one can be selected. If fast/slow is selected the alarm contact logic will follow the 'Alarm Normal' value selected. Fault alarms require manual clearing and will cause immediate shutdown of the unit. Faults should be investigated before clearing and allowing the unit to restart.

**Warnings**= This value will define how warnings will report (*open/close*) or how (*fast/slow*) the reporting will occur. Only one can be selected. If fast/slow is selected the alarm contact logic will follow the 'Alarm-Normal' value selected. Warning alarms are self-clearing but will be recorded into the alarm buffers.

Press the "NEXT MENU" key and menu 37 (*Message Board*) will be displayed. Menu 37 has one screen. This menu allows a technician to post a message via a computer. A message could be posted by a remote computer using the modem.

**Menu 37, Message Board**

Item					
Screen	Line	Display	Field	Range	Extended Name
1	1	No Message			A Message can be Posted via a Connected Computer



# Master/Slave Setup

Chiller setup for dual unit (*WDC*) or two single (*WSC*) units with master/slave and or lead/lag control. There are several menus that require modification to accomplish this setup. The first menu that has to be modified is menu 26. One MicroTech controller has to be designated as the Master unit. The other unit will be the Slave unit.

Set the toggle switch on the face of the MicroTech panel (*master and slave units*) to the stop position. Go to menu 26 on the Master unit. Only the values that require changes will be discussed.

## Menu 26, Unit Setup

		Item				
Screen	Line	Display	Field	Range	Extended Name	
1	1	IDENT=CFG3E02AC	1		Software Version	
		Unit Type=WSC063	2	WSC048	Chiller Model Number	
				WSC050		
				WSC063		
				WSC079		
				WSC087		
				WSC100		
	2	Config=L2 TTY-Slave	1	L1-TTY-Master	Unit Controller Configuration	
				L1-TTY-TTY		
				L2-Master-Slave		
				L2-TTY-Slave		
				L3-TTY-Slave		
	Chiller Only	2	Chiller	Chiller Control Options		
			Templifier			
	3	Port A Baud =9600	1	1200	Port A Comm Rate	
2400						
4800						
9600						
Low Temperature=No	2	No-Yes	Ice Operation			
2	1	Master/Slave=Slave	1	Master	Network Configuration	
			Slave			
	2	Evap Gpm Sensor=No	2	Yes-No	Evaporator Flow Transmitter	
				None		
	2	OAT Sensor=None	1	Local	Location of OAT	
				Remote		
				0-65535		Maximum Flow Rate
3	Ambient Lockout=No	1	Yes-No	Lockout on OAT		
			Cond Gpm Sensor=No		2	Yes-No
3	1	Cond Full Gpm=6500	1	0-65535	Maximum Flow Rate	
			2	Oil Cooler=Solenoid	Valve	Oil Cooler Control Method
					Solenoid	
	2	Refrig Leak Sen=No	1	Yes-No	Refrigerant Leak Sensor Signal	
				Full Load Amp=300		2
	3	Ht Recovery Sen=No	1	Yes-No	Heat Recovery Temp Sensor	

**Config**= This defines the communication link, com port type and MicroTech controller level. The master unit must be set to L2-Master-Slave. This setting makes menu 23 available only on the master unit. (*The slave unit must be set to L3TTY-Slave*).

**Master/Slave**= Set this to 'Master' on the Master unit. (*Set this value to 'Slave' on the slave unit*).

This completes the setup of menu 26 on both the master and slave units.

Go to menu 23 on the master unit. This menu is only available on the master unit. The network communications depends on the values selected in this menu.

### Menu 23, Lead Lag Setup

		Item			
Screen	Line	Display	Field	Range	Extended Name
1	1	Slave Address=01.00	1	00-09	Slave Unit Network Address
		Start-Up=NotUnld	2	NoUnload Unload	Unload Lead During Lag Start
	2	LL Mode=auto	1	Auto	Lead Lag Control Mode
				Slave Lead	
				Master Lead	
		Enable Lag=95%	2	0-100%	Lag Start Threshold
	3	LL SwOver=N/A	1	N/A	Scheduled Lead Unit Switch Over Day
				Sun	
				Mon	
				Tue	
Wed					
Thu					
Fri					
Sat					
	Disable Lag=40%	2	1-100%	Lag Stop Threshold	
2	1	Delay timer=5Min	1	1-60Min	Lag Unit time Delay
	2	Lag-Standby=No	1	No-Yes	Lag Unit Standby Operation

**Slave Address**= This value (01.01) is the network address of the slave MicroTech. This value is determined by the Hex switches on the MicroTech. The slave MicroTech will always be addressed as 01. The master unit can be any hex switch setting greater than 00 but less than FF. (00 & FF are reserved numbers and cannot be used.) The wrong value will disconnect the communications between the chillers and they would revert back to local control. This could cause damage to a dual chiller unit.

**Start-Up**= This value directs the lead chiller to unload or not to unload. A dual chiller must unload the lead chiller when starting the lag chiller. This is optional in a two (2) single chiller configuration.

**LL Mode**=The value selected will direct the network to start the chillers in a fixed sequence.

**Auto**—The chiller with the least run time will start as the lead unit. The chiller with the most run time will turn off first when only one chiller is required to meet load conditions.

**Slave Lead**—The slave chiller will start first each time and the master chiller will shutdown when only one chiller is needed to meet load requirements.

**Master Lead**—The master chiller will start first each time and the slave chiller will shutdown when only one chiller is needed to meet load requirements.

**Enable Lag**= This is the amp value (percentage) when the lag chiller will be started. This value must be maintained for a predetermine amount of time to indicate a true load.

**LL Swover**=Day of week for lead lag switch to occur. This is optional.

**Disable Lag**= This is the amp value (percentage) when the lag chiller will be shutdown. This value must be maintained for a predetermine amount of time to indicate a true load.

**Delay Timer**= This value is used to delay the start of the lag chiller if the lag chiller is used in a stand by mode only. Stand by means the chiller is only started when the lead chiller fails.

**Lag-Standby**= This value sets the lag chiller as a standby chiller and will only start if the lead chiller fails.

Cycle power to both MicroTech controllers. This is necessary for the hex switch settings and com port settings initialization.

Go to menu 11. Set **Auto:Network** in this menu for both the slave and master MicroTech. Set the toggle switch on the face of the MicroTech panel (master and slave units) to the auto position. The chillers will now start when load conditions require cooling.

# Alarms

Any condition that requires corrective action by the controller that overrides normal chiller operation or any condition that initiates an emergency chiller shutdown can be considered to be an alarm.

Alarms are arranged in increasing priority with higher priority alarms replacing any lower priority alarms that may exist. Once the abnormal condition is corrected, the alarm may be cleared by pressing the "CLEAR" key.

Alarms fall into three distinct categories: **Warnings**, **Problems**, and **Faults**.

## Warnings

A warning is enunciated whenever an abnormal condition exists which does not affect chiller operation.

WARNING	CONDITION	DISPLAY
Liquid Line Refrigerant Temperature Sensor Fail Warning	Sensor is shorted or open	Liq Line T Sen Warn
Entering Evaporator Water Temperature Sensor Fail Warning	Sensor is shorted or open	Ent Evap T Sen Warn
Leaving Condenser Water Temperature Sensor Fail Warning	Sensor is shorted or open	Lvg Cond T Sen
Low Discharge Superheat	Discharge Superheat temperature is lower than acceptable range for more than 3 minutes (adjustable)	Low Disch Superheat
High Discharge Superheat	Discharge Superheat temperature is lower than acceptable range for more than 3 minutes (adjustable)	Hi Disch Superheat

## Problems

A problem condition exists whenever the MicroTech controller must override normal chiller operation in order to keep the unit on line.

PROBLEM	CONDITION	DISPLAY	ACTION	CLEAR
Entering Evaporator Water Temperature Sensor Fail Problem	Sensor is shorted or open <i>and</i> Leaving Water reset is based on Entering Water Temperature	<u>Ent Evap T Seen Probe</u>	Leaving Water reset will change to No Reset	Manual - Reset will revert back to Entering Water on clearing
Outside Air Temperature Sensor Fail Problem	<u>Sensor is shorted or open and Leaving Water reset is based on Outside Air Temperature</u>	<u>Outside T Seen Probe</u>	<u>Leaving Water reset will change to No Reset</u>	<u>Manual - Reset will revert back to OAT on clearing</u>
<u>Low Evaporator Pressure - Inhibit Loading</u>	Sensor Pressure is less than low limit (38 psig)	<u>Lo Evap Press-NoLoad</u>	Inhibit loading	Automatically when: Evaporator Pressure rises above set point plus differential
Low Evaporator pressure - Unload	Evaporator Pressure is less than low limit (31 psig)	<u>Low Evap Press-Unload</u>	Unload to minimum position	Automatically when: Evaporator Pressure rises above set point plus differential
High Discharge Temperature - Load	Discharge temperature > high limit (120°F) <i>and</i> Suction Superheat < Low Limit (15°F)	<u>High Discharge T-Load</u>	Load compressor	Automatically when: Discharge Temperature < High Limit - Diff (3°F) or Suction Superheat > Low Limit + Diff (3°F)
Condenser Freeze Protect	Condenser Refrigerant Temperature < Condenser Freeze Protect Set Point (34°F)	<u>Cond Pres Lo-Freeze</u>	Start the Condenser pump	Condenser Refrigerant Temperature > Condenser Freeze Protect Set Point + Differential (2°F)

**Problems, continued**

PROBLEM	CONDITION	DISPLAY	ACTION	CLEAR
Evaporator Freeze Protect	Evaporator Refrigerant Temperature < Evaporator Freeze Protect Set Point (34°F)	<u>Evap Pres Lo-Freeze</u>	Start the Evaporator pump	Evaporator Refrigerant Temperature > Evaporator Freeze Protect Set Point + Differential (2°F)
Evaporator Pump 1 Fail	UnitStatus > EvapPmpOn_Recirc and UnitStatus < EvapPumpsOff and Evaporator Water Flow switch digital input in No Flow position for more than 3 seconds (adjustable) and Evaporator pump 2 is present and Evaporator pump 2 has not yet failed	<u>Evap Pump #1 Fail</u>	Unit will try to start evaporator pump 2	Manual
Evaporator Pump 2 Fail	UnitStatus > EvapPmpOn_Recirc and UnitStatus < EvapPumpsOff and Evaporator Water Flow switch digital input in No Flow position for more than 3 seconds (adjustable) and Evaporator pump 1 is present and Evaporator pump 1 has not yet failed	<u>Evap Pump #2 Fail</u>	Unit will try to start evaporator pump 1	Manual
Condenser Pump 1 Fail	UnitStatus > CondPmpOn_WaitingFor Flow and UnitStatus < CondPumpOff and Condenser Water Flow switch digital input in No Flow position for more than 3 seconds (adjustable) and Condenser pump 2 is present and Condenser pump 2 has not yet failed	<u>Cond Pump #1 Fail</u>	Unit will try to start condenser pump 2	Manual
Condenser Pump 2 Fail	UnitStatus > CondPmpOn_WaitingFor Flow and UnitStatus < CondPumpOff and Condenser Water Flow switch digital input in No Flow position for more than 3 seconds (adjustable) and Condenser pump 1 is present and Condenser pump 1 has not yet failed	<u>Cond Pump #2 Fail</u>	Unit will try to start condenser pump 1	Manual

## Faults

The chiller will be shut down by the MicroTech control panel in response to any of the following fault conditions. These faults must be cleared manually to restart the unit.

FAULT	CONDITION	DISPLAY
Low Evaporator Pressure	Evaporator Pressure is less than low limit (26 psig)	<u>Lo Evap Pressure-SD</u>
Low Oil Delta Pressure	Oil Pump output has been energized for more then 30 seconds and Oil Feed Pressure is less than the Evaporator Refrigerant Pressure by more than the alarm set point (30 psi)	<u>Lo Evap Pressure-SD</u>
Low Oil Feed Temperature	Oil Feed temperature is less than Evaporator Refrigerant Temperature plus Low Oil delta Spt (30°F) for greater than 1 minute (adjustable)	<u>Low Oil Feed Temp</u>
High Oil Feed Temperature	Oil Feed temperature is greater than high limit (140°F) for greater than 1 minute (adjustment)	<u>High Oil Feed Temp</u>
Low Motor Current	MCR has been energized for more than 30 seconds <i>and</i> Motor Current is less than low limit (10%)	<u>Low Motor Current</u>
High Motor Current	MCR has been de-energized for more than 30 seconds <i>and</i> Motor Current is greater than shutdown limit (10%)	<u>High Motor Current</u>
<u>High Discharge Line Temperature</u>	<u>Discharge Temperature is &gt; Set Point (190°F)</u>	Hi Disch Line Temp
<u>High Condenser Pressure</u>	Condenser Pressure is greater than high limit (140 psi) <i>or</i> High Cond Pressure digital input in Alarm position	<u>Hi Condenser Press</u>
<u>Mechanical High Pressure Switch</u>	<u>High Pressure digital input in Alarm position</u>	<u>Mech Hi Pres Switch</u>
<u>High Motor Temperature</u>	Motor High Temperature digital input in Alarm position	<u>High Motor Temp</u>
<u>High Suction Superheat</u>	Suction Superheat temperature > Set Point (50°F)	<u>Hi Suction Superht</u>
No Starter Transition	MCR has been turned on more than 15 seconds <i>and</i> Starter Transition digital input is not in Delta position	<u>No Starter Transition</u>
No Evaporator Water Flow Fault	UnitStatus > EvapPmpOn_Recirc and UnitStatus < EvapPmpsOff_Shutdn <i>and</i> Evaporator Water Flow switch digital input in No Flow position for more than 3 second (adjustable)	<u>No Evap Water Flow</u>
No Condenser Water Flow Fault	UnitStatus > CondPmpOn_WaitingForFlow and UnitStatus < CondPmpsOff_Shutdn <i>and</i> Condenser Water Flow switch digital input in No Flow position for more than 3 seconds (adjustable)	<u>No Cond Water Flow</u>
Starter Fault	MCR Output energized <i>and</i> Starter Fault digital input in Alarm position	<u>Starter Fault</u>
No 5Vdc at sensor #19	Analog sensor #19 value is < 213 or > 252 counts	No 5Vdc at Sen #19
Leaving Evaporator Water Temperature Sensor Fail	Sensor is shorted or open	Lvg Evap T Sen Fail
Evaporator Pressure Sensor Fail	Sensor is shorted or open	Evap Press Sen Fail
Entering Condenser Water Temperature Sensor Fail	Sensor is shorted or open	Ent Cond T Sen Fail
Suction Temperature Sensor Fail Warning	Sensor is shorted or open	Suction T Sen Fail
Discharge Temperature Sensor Fail	Sensor is shorted or open	Discharg T Sen Fail
Condenser Pressure Sensor Fail	Sensor is shorted or open	Cond Press Sen Fail
Oil Feed Temperature Sensor Fail	Sensor is shorted or open	Oil Feed T Sen Fail
Oil Sump Temperature Sensor Fail	Sensor is shorted or open	Oil Sump T Sen Fail



Post Office Box 2510, Staunton, Virginia 24402-2510 • (800) 432-1342 • [www.mcquay.com](http://www.mcquay.com)