

# VLS / VLC / VLH 504 ÷ 1204



English



127  
↓  
313 kW



133  
↓  
307 kW



**Air cooled water chillers, air cooled condensing units and air-to-water reverse cycle heat pumps**

**IOM VLSCH-N.2GB**  
Date : May 2006  
Supersedes : IOM VLSH-N.1GB





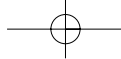

## Table of contents

### Table of contents

<b>1 FOREWORD</b>		<b>5 START-UP</b>	
1.1 Introduction	3	5.1 Preliminary check	20
1.2 Warranty	3	5.2 Start-up	20
1.3 Emergency stop/Normal stop	3	5.3 Checking the operation	21
1.4 An introduction to this manual	3	5.4 Delivery to the customer	21
<b>2 SAFETY</b>		<b>6 CONTROL</b>	
2.1 Foreword	4	6.1 Main Characteristics	22
2.2 Definitions	4	6.2 Protection and Safety Equipment	25
2.3 Access to the unit	5	<b>7 GENERAL DESCRIPTION</b>	
2.4 General precautions	5	7.1 Introduction	26
2.5 Precautions against residual risks	5	7.2 General specifications	26
2.6 Precautions during maintenance operations	6	7.3 Compressors	26
2.7 Safety labels	7	7.4 Refrigeration circuits	26
2.8 Safety regulations	9	7.5 Water heat exchanger	26
<b>3 TRANSPORT, LIFTING AND POSITIONING</b>		7.6 Air heat exchanger	27
3.1 Inspection	12	7.7 Fans	27
3.2 Lifting	12	7.8 Electric power supply and control system	28
3.3 Anchoring	13	7.9 Accessories	28
3.4 Storage	13	<b>8 TECHNICAL DATA</b>	
<b>4 INSTALLATION</b>		8.1 Pressure drop	30
4.1 Positioning of the unit	14	8.2 Technical data	31
4.2 Spring Isolator Installation	14	8.3 Electrical data	43
4.3 External hydraulic circuit	15	8.4 Position of shock absorbers and weight distribution on supports	49
4.4 Hydraulic connection	16	8.5 Overall dimensions	61
4.5 Draining the Defrosting Waste Water (for heat pump unit only)	16	8.6 Services spaces	69
4.6 Power supply	17		
4.7 Electrical connections	17		

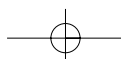

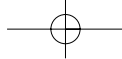

## Table of contents

---

### **9 MAINTENANCE**

9.1 General requirements	70
9.2 Planned maintenance	70
9.3 Refrigerant charge	71
9.4 Compressor	71
9.5 Condenser	71
9.6 Fans	71
9.7 Dehydrating filter	72
9.8 Sight glass	72
9.9 Thermostatic expansion valve	72
9.10 Evaporator	72

### **10 TROUBLESHOOTING**

### **11 SPARE PARTS**

11.1 Spare parts list	75
11.2 Oil for compressors	75
11.3 Wiring diagram	75

### **12 DISMANTLING, DEMOLITION AND SCRAPPING**

12.1 Generalities	76
-------------------	----

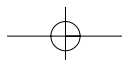

## Foreword

### 1 FOREWORD

#### 1.1 Introduction

Itelco-Clima units, manufactured to state-of-the-art design and implementation standards, ensure top performance, reliability and fitness to any type of air-conditioning systems.

These units are designed for cooling water or glycoled water (and for water heating in heat pump models) and are unfit for any purposes other than those specified in this manual.

This manual includes all the information required for a proper installation of the units, as well as the relevant operating and maintenance instructions.

It is therefore recommended to read this manual carefully before installation or any operation on the machine. The chiller installation and maintenance must be carried out by skilled personnel only (where possible, by one of Itelco-Clima's Authorised Service Centers).

The manufacturer may not be held liable for any damage to people or property caused by improper installation, start-up and/or improper use of the unit and/or failure to implement the procedures and instructions included in this manual.

#### 1.2 Warranty

These units are delivered complete, tested and ready for being operated. Any form of warranty will become null and void in the event that the appliance is modified without Itelco-Clima's preliminary written authorisation.

This warranty shall apply providing that the installation instructions have been complied with (either issued by Itelco-Clima, or deriving from the current practice), and the Form 1 ("Start-up") has been filled-in and mailed to Itelco-Clima (attn. After-Sales Service).

In order for this warranty to be valid, the following conditions shall be met:

- The machine must be operated only by skilled personnel from Itelco-Clima's Authorised After-Sales Service.
- Maintenance must be performed only by skilled personnel - from one of Itelco-Clima's Authorised After-Sales Centers.
- Use only original Itelco-Clima spare parts.
- Carry out all the planned maintenance provided for by this manual in a timely and proper way.

Failure to comply with any of these conditions will automatically void the warranty.

#### 1.3 Emergency stop / Normal stop

The emergency stop of the unit can be enabled using the master switch on the control panel (move down the lever).

For a normal stop, press the relevant push-buttons.

To restart the appliance, follow the procedure detailed in this manual.

#### 1.4 An introduction to the manual

For safety reasons, it is imperative to follow the instructions given in this manual. In case of any damage caused by non-compliance with these instructions, the warranty will immediately become null and void.

Conventions used throughout the manual:



The Danger sign recalls your attention to a certain procedure or practice which, if not followed, may result in serious damage to people and property.



The Warning sign precedes those procedures that, if not followed, may result in serious damage to the appliance.



The Notes contain important observations.



The Useful Tips provide valuable information that optimises the efficiency of the appliance.

This manual and its contents, as well as the documentation which accompanies the unit, are and remain the property of Itelco-Clima, which reserves any and all rights thereon. This manual may not be copied, in whole or in part, without Itelco-Clima's written authorization.

## Safety

### 2 SAFETY

#### 2.1 Foreword

These units must be installed in conformity with the provisions of Machinery Directive 98/37/EC, Low Voltage Directive 73/23/EC, Pressure Vessels Directive 97/23/EC, Electromagnetic Interference Directive 89/336/EC, as well as with other regulations applicable in the country of installation. If these provisions are not complied with, the unit must not be operated.



The unit must be grounded, and no installation and/or maintenance operations may be carried out before deenergising the electrical panel of the unit.

Failure to respect the safety measures mentioned above may result in electrocution hazard and fire in the presence of any short-circuits.



Inside the heat exchangers, the compressors and the refrigeration lines, this unit contains liquid and gaseous refrigerant under pressure. The release of this refrigerant may be dangerous and cause injuries.



The units are not designed to be operated with natural refrigerants, such as hydrocarbons. Itelco-Clima may not be held liable for any problems deriving from the replacement of original refrigerant or the introduction of hydrocarbons.

Itelco-Clima units are designed and manufactured according to the requirements of European Standard PED 97/23/EC (pressure vessels).

- The used refrigerants are included in group II (non-hazardous fluids).
- The maximum working pressure values are mentioned on the unit's data plate.
- Suitable safety devices (pressure switches and safety valves) have been provided, to prevent any anomalous overpressure inside the plant.
- The vents of the safety valves are positioned and oriented in such a way as to reduce the risk of contact with the operator, in the event that the valve is operated. Anyway, the installer will convey the discharge of the valves far from the unit.
- Dedicated guards (removable panels with tools) and danger signs indicate the presence of hot pipes or components (high surface temperature).



The guards of the fans (only for units provided with air heat exchangers) must be always mounted and must never be removed before de-energising the appliance.



It is the User's responsibility to ensure that the unit is fit for the conditions of intended use and that both installation and maintenance are carried out by experienced personnel, capable of respecting all the recommendations provided by this manual. It is important that the unit is adequately supported, as detailed in this manual. Non-compliance with these recommendations may create hazardous situations for the personnel.



The unit must rest on a base which meets the characteristics specified in this manual; a base with inadequate characteristics is likely to become a source of serious injury to the personnel.



The unit has not been design to withstand loads and/or stress that may be transmitted by adjacent units, piping and/or structures. Each external load or stress transmitted to the unit may break or cause breakdowns in the unit's structure, as well as serious dangers to people. In these cases, any form of warranty will automatically become null and void.



The packaging material must not be disposed of in the surrounding environment or burnt.

#### 2.2 Definitions

**OWNER:** means the legal representative of the company, body or individual who owns the plant where Itelco-Clima unit has been installed; he/she has the responsibility of making sure that all the safety regulations specified in this manual are complied with, along with the national laws in force.

**INSTALLER:** means the legal representative of the company who has been given by the owner the job of positioning and performing the hydraulic, electric and other connections of Itelco-Clima unit to the plant: he/she is responsible for handling and properly installing the appliance, as specified in this manual and according to the national regulations in force.

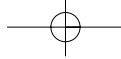

## Safety

**OPERATOR:** means a person authorised by the owner to do on Itelco-Clima unit all the regulation and control operations expressly described in this manual, that must be strictly complied with, without exceeding the scope of the tasks entrusted to him.

**ENGINEER:** means a person authorised directly by Itelco-Clima or, in all EC countries, excluding Italy, under his full responsibility, by the distributor of Itelco-Clima product, to perform any routine and extraordinary maintenance operations, as well as any regulation, control, servicing operations and the replacement of pieces, as may be necessary during the life of the unit.

### 2.3 Access to the unit

The unit must be placed in an area which can be accessed also by OPERATORS and ENGINEERS; otherwise the unit must be surrounded by a fence at not less than 2 meters from the external surface of the machine.

OPERATORS and ENGINEERS must enter the fenced area only after wearing suitable clothing (safety shoes, gloves, helmet etc.). The INSTALLER personnel or any other visitor must always be accompanied by an OPERATOR.

For no reason shall any unauthorised personnel be left alone in contact with the unit.

### 2.4 General precautions

The OPERATOR must simply use the controls of the unit; he must not open any panel, other than the one providing access to the control module.

The INSTALLER must simply work on the connections between plant and machine; he must not open any panels of the machine and he must not enable any control.

When you approach or work on the unit, follow the precautions listed below:

- do not wear loose clothing or jewellery or any other accessory that may be caught in moving parts
- wear suitable personal protective equipment (gloves, goggles etc.) when you have to work in the presence of free flames (welding operations) or with compressed air
- if the unit is placed in a closed room, wear ear protection devices
- cut off connecting pipes, drain them in order to balance the pressure to the atmospheric value before disconnecting them, disassemble connections, filters, joints or other line items
- do not use your hands to check for any pressure drops

- use tools in a good state of repair; be sure to have understood the instructions before using them
- be sure to have removed all tools, electrical cables and any other objects before closing and starting the unit again

### 2.5 Precautions against residual risks

#### Prevention of residual risks caused by the control system

- be sure to have perfectly understood the operating instructions before carrying out any operation on the control panel
- when you have to work on the control panel, keep always the operating instructions within reach
- start the unit only after you have checked its perfect connection to the plant
- promptly inform the ENGINEER about any alarm involving the unit
- do not reset manual restoration alarms unless you have identified and removed their cause

#### Prevention of residual mechanical risks

- install the unit according to the instructions provided in this manual
- carry out all the periodical maintenance operations prescribed by this manual
- wear a protective helmet before accessing the interior of the unit
- before opening any panelling of the machine, make sure that it is secured to it by hinges
- do not touch air condensation coils without wearing protective gloves
- do not remove the guards from moving elements while the unit is running
- check the correct position of the moving elements' guards before restarting the unit

#### Prevention of residual electrical risks

- connect the unit to the mains according to the instructions provided in this manual
- periodically carry out all the maintenance operations specified by this manual
- disconnect the unit from the mains by the external disconnecting switch before opening the electrical board
- check the proper grounding of the unit before start-up
- check all the electrical connections, the connecting cables, and in particular the insulation; replace worn or damaged cables

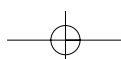

## Safety

- periodically check the board's internal wiring
- do not use cables having an inadequate section or flying connections, even for limited periods of time or in an emergency

### Prevention of other residual risks

- make sure that the connections to the unit conform to the instructions provided in this manual and on the unit's panelling
- if you have to disassemble a piece, make sure that it has been properly mounted again before restarting the unit
- do not touch the delivery pipes from the compressor, the compressor and any other piping or component inside the machine before wearing protective gloves
- keep a fire extinguisher for electrical appliances near the machine
- on the units installed indoors, connect the safety valve of the refrigeration circuit to a piping network that can channel any overflowing refrigerant outside
- remove and leak of fluid inside and outside the unit
- collect the waste liquids and dry any oil spillage
- periodically clean the compressor compartment, to remove any fouling
- do not store flammable liquids near the unit
- do not disperse the refrigerant and the lubricating oil into the environment
- weld only empty pipes; do not approach flames or other sources of heat to refrigerant pipes
- do not bend/hit pipes containing fluids under pressure

### 2.6 Precautions during maintenance operations

Maintenance operations can be carried out by authorised technicians only.

Before performing any maintenance operations:

- disconnect the unit from the mains with the external disconnecting switch
- place a warning sign "do not turn on - maintenance in progress" on the external disconnecting switch
- make sure that on-off remote controls are inhibited
- wear suitable personal protective equipment (helmet, safety gloves, goggles and shoes etc.)

To carry out any measurements or checks which require the activation of the machine:

- work with the electrical board open only for the necessary time
- close the electrical board as soon as the measurement or check has been completed
- for outdoor units, do not carry out any operations in the presence of dangerous climatic conditions (rain, snow, mist etc.)

The following precautions must be always adopted:

- do not scatter the fluids of the refrigeration circuit in the surrounding environment
- when replacing an eprom or electronic cards, use always suitable devices (extractor, antistatic bracelet, etc.)
- to replace a compressor, the evaporator, the condensing coils or any other weighty element, make sure that the lifting equipment is consistent with the weight to be lifted
- in air units with independent compressor compartment, do not access the fan compartment unless you have disconnected the machine by the disconnecting switch on the board and you have placed a warning sign "do not turn on - maintenance in progress"
- contact Itelco-Clima for any modifications to the refrigeration, hydraulic or wiring diagram of the unit, as well as to its control logics
- contact Itelco-Clima if it is necessary to perform very difficult disassembly and assembly operations
- use only original spare parts purchased directly from Itelco-Clima or the official retailers of the companies on the recommended spare parts list
- contact Itelco-Clima if it is necessary to handle the unit one year after its positioning on site or if you wish to dismantle it.



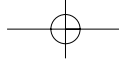

## Safety

### 2.7 Safety labels

The labels below will be affixed to each unit in the indicated point:



Identification of the refrigerant - External door

COD.PRODOTTO NEUTRO   
PRODUCT CODE

MODELLO   
MODEL

OdL

MATRICOLA   
SERIAL NUMBER

ANNO DI COSTRUZIONE

CARICA REFR. CIRCUITO R407C 2 3 4  
REFRIGERANT CHARGE CHARGE  Kg

ALTA PRESSIONE (max) bar   
HIGH PRESSURE

BASSA PRESSIONE (max) bar   
LOW PRESSURE

ALIM. POTENZA V/PH/Hz     
MAIN SUPPLY

CORRENTE DI SPUNTO (max) A   
LRA

CORRENTE A PIENO CARICO (max) A

POTENZA ASSORBITA (max) Kw   
POWER INPUT

PRESS. ESERC.ACQUA (max) bar   
WATER OPERATION PRESSURE

MASSA (max) Kg   
MASS

ITELCO CLIMA S.r.l Via XXV Aprile 29 20030 BARLASSINA MI(ITALIA)  
MADE IN ITALY

Identification of the unit - Outside, on the right-hand front column

TENERE SU QUESTA LINEA  
GANCIO DI SOLLEVAMENTO

KEEP LIFT HOOK  
ON THIS LINE

Gravity centre - Base

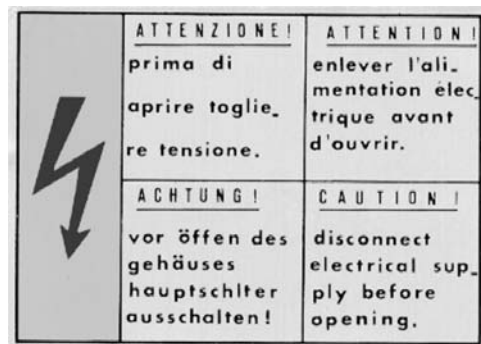

Electrical warning Adjacent to the master switch

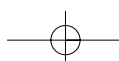

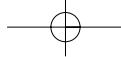

# Safety

## ATTENZIONE

INSERIRE LE RESISTENZE DI RISCALDAMENTO OLIO ALMENO 12 ORE PRIMA DI OGNI AVVIAMENTO (SE PREVISTE).

PRIMA DELLA MESSA IN TENSIONE ASSICURARSI CHE LE VITI DEI CIRCUITI ELETTRICI SIANO SERRATE COMPLETAMENTE.

## WARNING

ENERGIZE THE CRANCKCASE HEATER FOR AT LEAST 12 HOURS BEFORE EACH STARTING (IF FITTED).

BEFORE TIGHTENING-UP, TO TIGHTEN ALL TERMINAL SCREWS ESPECIALLY THOSE IN MAIN CIRCUIT.

881000215/B

### Start-up warning - Outside the door of the electrical board

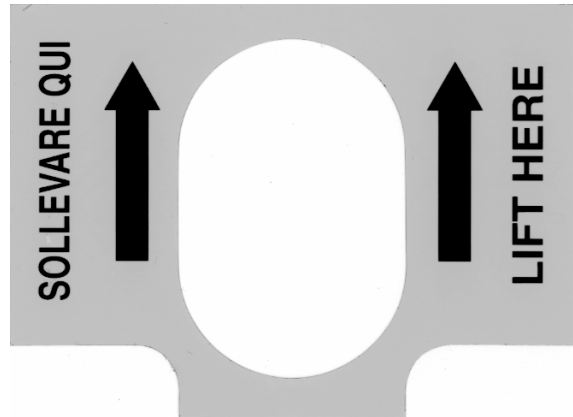

Lifting point - Base

CERTIFICATO DI COLLAUDO PRODUZIONE ITELCO-CLIMA  
 ITELCO-CLIMA PRODUCTION TEST CERTIFICATE  
 UNITA' ARIA-ARIA/ARIA-ACQUA - SEMICENTRALI - CHILLER AIR/AIR AIR/WATER

des. unita'-unit designation  
 1. coll. type  
 2. serie lotto produ. Serial number of product  
 3. tipo di distribuzione Distribution type

PROGR. COLL. NUMBER CHECK	DESCRIZIONE DEI TEST DESCRIPTION OF QUALITY CHECK	TIMBRO OPERAT. INSP. CODE
01	VERIFICA ASSEMBLAGGIO VERIFY ASSEMBLY COMPLETE	
02	VERIFICA VISIVA CABLAGGIO COLLEG. ELETTRICI E CONNESSIONE VERIFY WIRING CONNECTIONS	
03	VUOTO E CARICA REF. VACUUM AND CHARGE TEST	
04	VERIFICA CON CERCAFUGHE TENUTA CIRCUITO FRIGORIFERO REFRIGERANT LEAK TEST	
05	PROVE FUNZIONALI CON RILIEVI TEMPERATURE/PRESSIONI-RUMORE FUNCTION AND RUN TEST NOISE TEST	
06	VERIFICA INTERVENTI SICUREZZE PRESSIONE E TEMPERATURA CHECK OPERATION AND SAFETY DEVICES	
07	VERIFICA TENUTA CIRCUITO IDR. E FUNZIONAMENTO POMPA (SU PACK) HYDRAULIC CIRCUIT TEST (PUMP CHECK ONLY FOR PACK UNIT)	
08	VERIFICA MONTAGGIO ACCESSORI (SE PREVISTI) E DOCUMENTAZIONE CHECK ACCESSORIES/DOCUMENTATION	
09	CONTROLLO ESTETICO FINALE E PULIZIA INTERNA VISUAL CHECK FOR DIRT AND DAMAGE	

### Final Test Certificate - Inside the external door

EIN - INLET  
 ENTRÉE - ENTRATA  
 AUS - OUTLET  
 SORTIE - USCITA

### Fitting identification - Adjacent to fittings



### Grounding connection - On the electrical board, adjacent to the connection

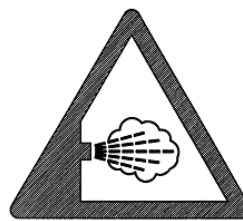

### Warning - safety valves' vents



### Warning - high-temperature zones Adjacent to hot pipes or components

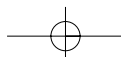

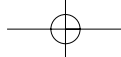

## Safety

### 2.8 Safety regulations

Refrigerant data	Safety data: R407C, R134a
Toxicity	Low
Contact with skin	If sprayed, the refrigerant is likely to cause frost burns. If absorbed by the skin, the danger is very limited; it may cause a slight irritation, and the liquid is degreasing. Unfreeze the affected skin with water. Remove the contaminated clothes with great care - in the presence of frost burns, the clothes may stick to the skin. Wash with plenty of warm water the affected skin. In the presence of symptoms such as irritation or blisters, obtain medical attention.
Contact with eyes	Vapours do not cause harmful effects. The spraying of refrigerant may cause frost burns. Wash immediately with a proper solution or with tap water for at least 10 minutes, and then obtain medical attention.
Ingestion	Very unlikely - should something happen, it will cause frost burns. Do not induce vomiting. Only if the patient is conscious, wash out mouth with water and give some 250 ml of water to drink. Then, obtain medical attention.
Inhalation	R407C, R134a: remarkable concentrations in the air may have an anaesthetic effect, up to fainting. The exposure to considerable amounts may cause irregular heartbeat, up to the sudden death of the patient. Very high concentrations may result in the risk of asphyxia, due to the reduction in the oxygen percentage in the atmosphere. Remove the patient to fresh air and keep warm and at rest. If necessary, give oxygen. In case of breathing difficulties or arrest, proceed with artificial respiration. In case of cardiac arrest, proceed with cardiac massage. Then, obtain medical attention.
Recommendations	Semiotics or support therapy is recommended. Cardiac sensitisation has been observed that, in the presence of circulating catecholamines such as adrenalin, may cause cardiac arrhythmia and accordingly, in case of exposure to high concentrations, cardiac arrest.
Prolonged exposure	R407C, R134a: a study on the effects of exposure to 50,000 ppm during the whole life of rats has identified the development of benign testicle tumour. This situation should therefore be negligible for personnel exposed to concentrations equal to or lower than professional levels.
Professional levels	R407C, R134a: Recommended threshold: 1000 ppm v/v - 8 hours TWA.
Stability	R407C, R134a: Not specified
Conditions to avoid	Do not use in the presence of flames, burning surfaces and excess humidity.
Hazardous reactions	May react with sodium, potassium, barium and other alkaline metals. Incompatible substances: magnesium and alloys with magnesium concentrations > 2%.
Hazardous decomposition products	R407C, R134a: Halogen acids produced by thermal decomposition and hydrolysis.

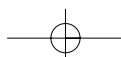

## Safety

---

General precautions	Do not inhale concentrated vapours. Their concentration in the atmosphere should not exceed the minimum preset values and should be maintained below the professional threshold. Being more weighty than the air, the vapour concentrates on the bottom, in narrow areas. Therefore, the exhaust system must work at low level.
Respiratory system protection	If you are in doubt about the concentration in the atmosphere, it is recommended to wear a respirator approved by an accident-prevention Authority, of the independent or oxygen type.
Storage	Cylinders must be stored in a dry and fresh place, free from any fire hazard, far from direct sunlight or other sources of heat, radiators etc. Keep a temperature below 45°C.
Protective clothing	Wear overalls, protective gloves and goggles or a mask.
Accidental release measures	It is important to wear protective clothing and a respirator. Stop the source of the leak, if you can do this without danger. Negligible leaks can be left evaporating under the sun, providing that the room is well ventilated. Considerable leaks: ventilate the room. Reduce the leak with sand, earth or other absorbing substances. Make sure that the liquid does not channelled into gutters, sewers or pits where the vapours are likely to create a stuffy atmosphere.
Disposal	The best method is recovery and recycling. If this method is not practicable, dispose according to an approved procedure, that shall ensure the absorption and neutralization of acids and toxic agents.
Fire fighting information	R407C, R134a: Not flammable in the atmosphere.
Cylinders	The cylinders, if exposed to fire, shall be cooled by water jets; otherwise, if heated, they may explode.
Protective fire fighting equipment	In case of fire, wear an independent respirator and protective clothing.

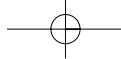

## Safety

<b>Refrigerant oil data</b>	<b>Safety data: Polyolester oil (POE)</b>
Classification	Not harmful
Contact with skin	May cause slight irritation. Does not require first aid measures. It is recommended to follow usual personal hygiene measures, including washing the exposed skin with soap and water several times a day. It is also recommended to wash your overalls at least once a week.
Contact with eyes	Wash thoroughly with a suitable solution or tap water.
Ingestion	Seek medical advice immediately.
Inhalation	Seek medical advice immediately.
Conditions to avoid	Strong oxidising substances, caustic or acid solutions, excess heat. May corrode some types of paint or rubber.
Protection of the respiratory system	Use in well ventilated rooms.
Protective clothing	Always wear protective goggles or a mask. Wearing protective gloves is not mandatory, but is recommended in case of prolonged exposure to refrigerant oil.
Accidental release measures	It is important to wear protective clothing and, especially, goggles. Stop the source of the leak. Reduce the leak with absorbing substances (sand, sawdust or any other absorbing material available on the market).
Disposal	The refrigerant oil and its waste will be disposed of in an approved incinerator, in conformity with the provisions and the local regulations applicable to oil waste.
Fire fighting information	In the presence of hot liquid or flames, use dry powder, carbon dioxide or foam. If the leak is not burning, use a water jet to remove any vapours and to protect the personnel responsible for stopping the leak.
Cylinders	The cylinders exposed to a fire will be cooled with water jets in case of fire.
Fire fighting protective equipment	In case of fire, wear an independent respirator.

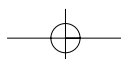

# Transport, Lifting and Positioning

## 3 TRANSPORT, LIFTING AND POSITIONING

Refrigerators are supplied assembled (apart from standard antivibrating rubber supports, that will be installed on site). The equipment are full of refrigerant and oil (except to the condensing unit), in the quantity required for a proper operation.

### 3.1 Inspection

When the unit is delivered, it is recommended to check it carefully and to identify any damage occurred during transportation. The goods are shipped ex-factory, at the buyer's risk. Check that the delivery includes all the components listed in the order.

In case of damage, note it down on the carrier's delivery note and issue a claim according to the instructions provided in the delivery note.

In the presence of any serious damage, that does not affect the surface only, it is recommended to inform Itelco-Clima immediately.

Please note that Itelco-Clima may not be held liable for any damage to the equipment during transportation, even though the carrier has been appointed by the factory.

### 3.2 Lifting

The unit must be lifted by using the hooks inserted into the relevant eyebolts (see the figure).

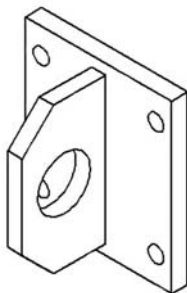

It is recommended to use a spacer to prevent cables from damaging the unit (see the figure).

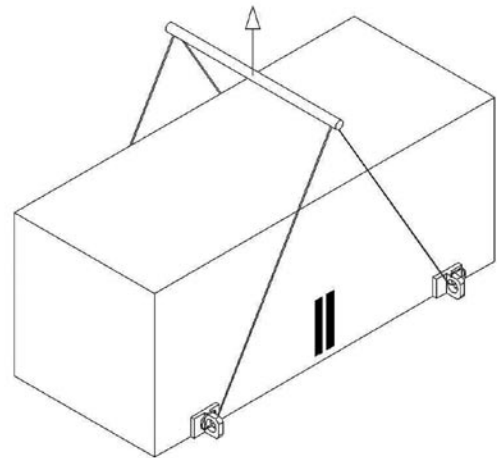

Before positioning the unit, make sure that the place of installation is appropriate and sturdy enough to hold the weight and to withstand the stress caused by the operation of the whole assembly.



Do not displace the unit on rollers, and do not lift it with a lift truck.

To lift and displace the unit :

- Insert and secure eyebolts into the holes marked on the frame.
- Connect cables to eyebolts.
- Insert spacer between cables.
- Hook near the barycentre of the unit.
- The cables must be long enough to form, if tensioned, an angle of at least 45° with respect to the horizontal plane.

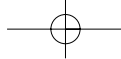

## Transport, Lifting and Positioning

---



For lifting operations, use only tools and material fit for this purpose, in accordance with accident-prevention regulations.



During the lifting and handling of the unit, be careful not to damage the finned pack of the coils positioned on the sides of the unit. The sides of the unit must be protected by cardboard or plywood sheets.



It is recommended not to remove the protective plastic envelope, that should prevent scraps from penetrating into the appliance and any damage to the surfaces, until the unit is ready for operation.

### 3.3 Anchoring

It is not essential to secure the unit to the foundations, unless in areas where there is a serious risk of earthquake, or if the appliance is installed on the top of a steel frame.

### 3.4 Storage

When the unit is to be stored before installation, adopt a few precautions to prevent any damage or risk of corrosion or wear:

- plug or seal every single opening, such as water fittings
- do not store the appliance in a room where the temperature exceeds 50°C for the units using R407C and, if possible, do not expose to direct sunlight
- it is recommended to store the unit in a roof where traffic is minimized, to prevent the risk of accidental damage
- the unit must not be washed with a steam jet
- take away and leave to the site manager all the keys providing access to the control board

Finally, it is recommended to carry out visual inspections at regular intervals.

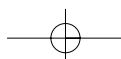

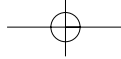

# Installation

## 4 INSTALLATION

### 4.1 Positioning of the unit



Before installing the unit, make sure that the structure of the building and/or the supporting surface can withstand the weight of the appliance. The weights of the units are listed in Chapter 8 of this manual.

These units have been designed for outdoor installation on a solid surface. Standard accessories include antivibrating rubber supports, that must be positioned under the base.

When the unit is to be installed on the ground, it is necessary to provide a concrete base, to ensure a uniform distribution of the weights.

As a general rule, no special sub-bases are required. However, if the unit is to be installed on the top of inhabited rooms, it is advisable to rest it on spring shock absorbers (optional), that will minimise the transmission of any vibration to the structures.



**The spring shock absorbers are fastened to suitable brackets (see the installation notes, paragraph 4.2), protruding from the base of the unit. The use of shock absorbers provided by the customer requires the adoption of suitable fastening brackets (that are an optional).**

To choose the place of installation of the unit, bear in mind that:

- the longitudinal axis of the unit must be parallel to the direction of prevailing winds, so as to ensure a uniform distribution of the air on finned exchangers
- the unit must not be installed near boilers' vent pipes
- the unit must not be installed leeward with respect to sources of air contaminated by greases, such as, for example, the outlets to kitchen exhaust hoods into the atmosphere. Otherwise, the grease is likely to deposit on the fins of the refrigerant /air exchangers, and would fix every type of atmospheric impurity, resulting in the quick clogging of the exchangers
- the unit must not be installed in areas subject to considerable snow falling
- the unit must not be installed in areas subject to flooding, under gutters etc.

- the unit must not be installed in air shafts, narrow courts or other small places, where the noise may be reflected by the walls or the air ejected by fans may short-circuit itself on refrigerant/air heat exchangers or condenser
- the place of installation must be have all the necessary spaces for air circulation and maintenance operations (see Chapter 9).

### 4.2 Spring Isolator Installation

- Prepare the base, that must be flat and plane.
- Lift the appliance and insert shock absorbers as follows:

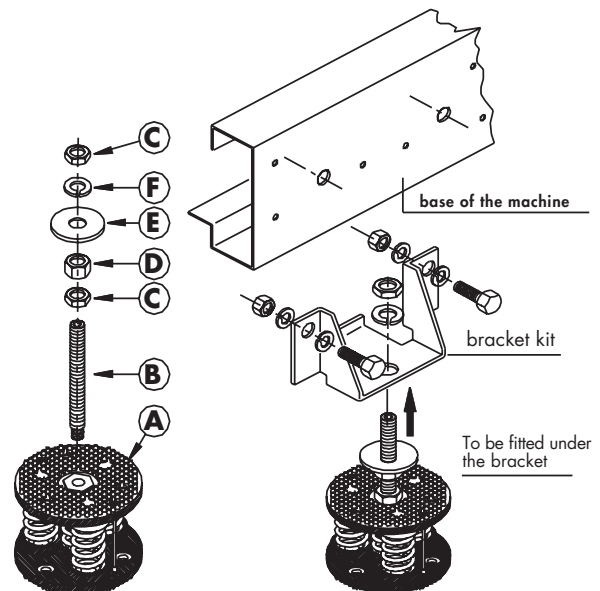

- 1) proceed with the assembly of the jack components (B-C-D-E-)
  - insert the rod of the jack (B) into the threaded hole on the upper plate of the antivibrating device (A)
  - insert the support, complete with jack, into the hole prepared on the bracket
  - position the bracket and the relevant jack on the base of the machine to be insulated, using the holes drilled for fastening.

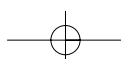



## Installation

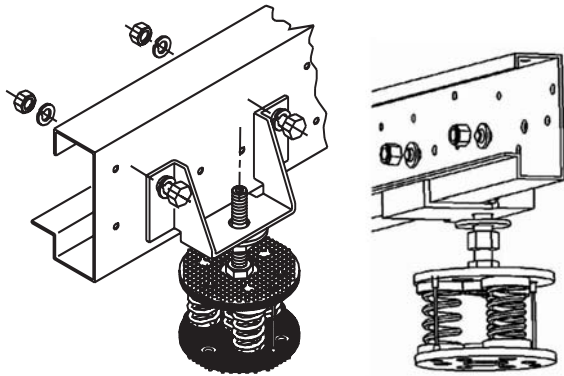

2) secured the bracket on the base with the screws forming part of the kit.

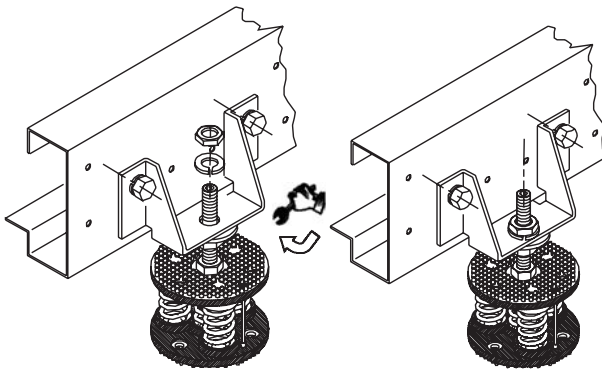

3) make sure that the bracket is secured and clamped to the base of the machine, and that it is resting on the flat washer (E) of the jack

- To offset any difference in height, work on high nut (D), using the relevant wrench
- Clamp in the obtain position with the grower washer (F) and the relevant low nut (C)

At the end of this operation, check that the machine is elastic on its axes, and preset for the installation of antivibrating joints in the water connections.

### 4.3 External hydraulic circuit



The external hydraulic circuit must ensure the water flow to the evaporator under any working or adjustment conditions.

The external hydraulic circuit should consist of the following elements:

- A circulation pump that can ensure the necessary capacity and discharge head.
- The capacity of the primary hydraulic circuit should not be less than 7.5 litres/KW of cooling capacity, in order to prevent the repeated start-up of the compressor and any damage to it. If the water capacity in the primary piping of the circuit and in the evaporator is lower than this value, an insulated storage tank shall be installed.
- A membrane expansion vessel provided with safety valve with vent, that must be visible.



The capacity of the expansion vessel must allow for an expansion of at least 2% of the volume of the fluid in the circuit (evaporator, piping, user circuit and standby tank, if any). The expansion vessel needs not be isolated, because no water can circulate inside it.

- A flow meter, to disable the appliance when the water is not circulating.



The flow meter must be connected (terminals 1-2) as shown in the wiring diagram of the "User's Terminal Box" (Paragraph 4.7).

**To install the flow meter, follow the manufacturer's instructions.**

As a general rule, the flow meter shall be mounted on a horizontal pipe, at a distance from the curves equal to 10 times the diameter of the pipe and far from valves or other components that are likely to hinder the water flow upstream of or downstream from the flow meter.

- The bleed valves must be mounted on the highest point of the piping.
- The stop valves must be mounted on the piping of the water entering/leaving the condenser.
- The discharge points (provided with plugs, cocks etc.) must be arranged in the lowest point of the piping.

## Installation

Then:

- Provide the evaporator with a by-pass circuit equipped with a valve to wash the plant.
- Insulate the piping, to prevent the risk of heat loss.
- Position a filter on the suction side of the evaporator of the heat recovery condenser.

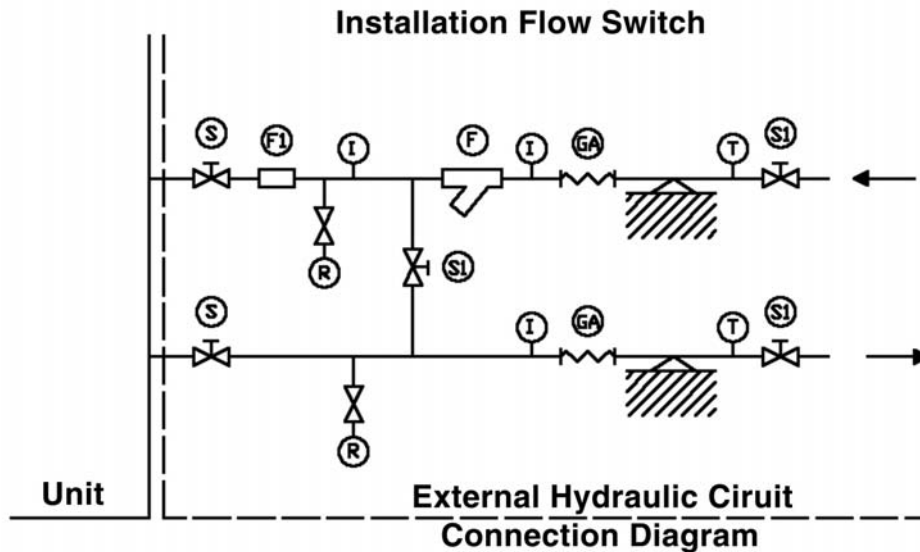

### Legends:

I: Pressure gauge connection  
 S: Gate valve  
 FI: Flow Switch

GA: Flexible hoses  
 R: Drain cock  
 T: Thermometer  
 F: Filter



Before filling the circuit, it is important to check that it is free from any foreign matter, sand, gravels, rust, welding deposits, waste and other materials that may damage the evaporator.

When cleaning the lines, it is recommended to create a circuit by-pass. It is important to mount a filtering medium (30 mesh) upstream of the chiller.



If necessary, the water required to fill the circuit must be treated to obtain the requested PH.

### 4.4 Hydraulic connection

The water inlet/outlet fittings shall conform to the instructions provided by the plates affixed near the connection points.

### 4.5 Draining the defrosting waste water (for heat pump unit only)

When heat pump units work in heating mode, during defrosting cycles, they may discharge water from the base. This is why the units should be installed at least 200 mm above the floor level, so as to allow the free drainage of waste water, without the risk of producing ice banks.

The heat pump units must be installed in positions where the defrosting water cannot create any damage.

## Installation

### 4.6 Power supply



Before carrying out any operations on the electrical system, make sure that the unit is deenergised.



It is important that the appliance is grounded.



The company in charge of the installation shall conform to the standards applicable to outdoor electrical connections.

**Itelco-Clima may not be held liable for any damage and/or injury caused by failure to comply with these precautions.**

The unit conforms to EN 60204-1.

The following connections shall be provided:

- A 3-phase and grounding connection for the power supply circuit.
- The electrical distribution system shall meet the power absorbed by the appliance.
- The disconnecting and magnetothermal switches must be sized to control the starting current of the unit.
- The power supply lines and the insulation devices must be designed in such a way that every line independent.
- It is recommended to install differential switches, to prevent any damage caused by phase drops.
- The fans and compressors are supplied through contactors controlled from the control panel.
- Each motor is provided with an internal safety thermal device and external fuses.
- The power supply cables must be inserted into dedicated openings on the front of the unit, and they will enter the electrical board through holes drilled on the bottom of the board.

### 4.7 Electrical connections

The unit must be installed on site according to the Machinery Directive (98/37/EC), the Low Voltage Directive (73/23/EC), the Electromagnetic Interference Directive (89/336/EC) and the usual procedures and standards applicable in the place of installation. The unit must not be operated if its installation has not been carried out according to the instructions provided in this manual.

**The power supply lines must consist of insulated copper conductors, dimensioned for the maximum absorbed current.**

Connection to terminals must be performed according to the diagram of connections (User's Terminal Box) provided in this manual and according to the wiring diagram which accompanies the unit.



Before connecting the power supply lines, check that the available voltage value does not exceed the range specified in the Electric Data (Chapter 8).

For 3-phase systems, check also that the unbalance between the phases does not exceed 2%. To perform this check, measure the differences between the voltage of each phase couple and their mean value during operation. The maximum % value of these differences (unbalance) must not exceed 2% of the mean voltage.

If the unbalance is unacceptable, contact the Energy Distributor to solve this problem.



Supplying the unit through a line whose unbalance exceeds the permissible value will automatically void the warranty.

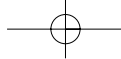

# Installation

## VLS/VLH Version – Electrical Connections

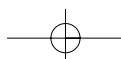
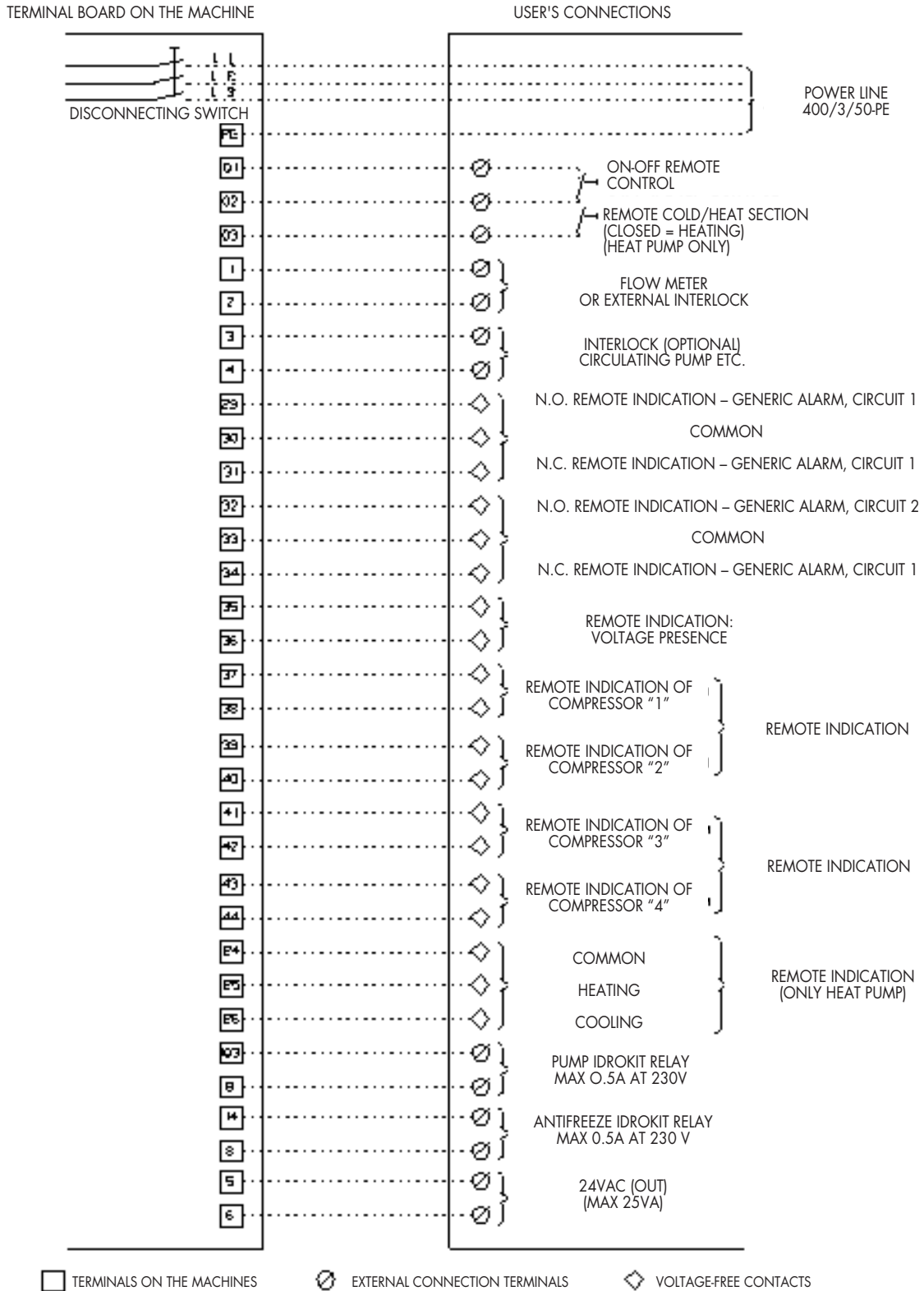

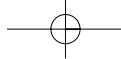

# Installation

## VLC version - Electrical Connections

INDOOR EVAPORATING UNIT

REQUEST STEP 1

REQUEST STEP 2

REQUEST STEP 3

REQUEST STEP 4

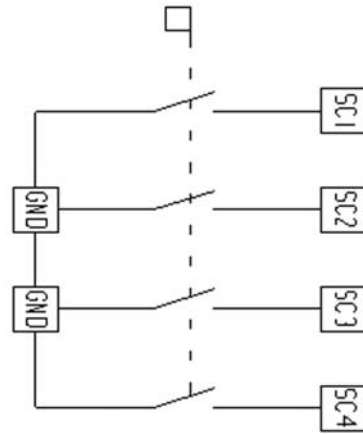

SOLENOID VALVE CONTROL (SYS 1)

SOLENOID VALVE CONTROL (SYS 2)

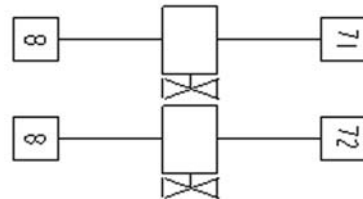

EXTERNAL INTERLOCK

EXTERNAL INTERLOCK

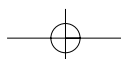
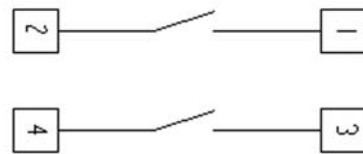

## Start-up

### 5 START-UP



The unit must be started for the first time by personnel suitably trained by one of Itelco-Clima's Authorised Service Centre. Failure to meet this requirement will immediately void the warranty.



The operations carried out by Itelco-Clima personnel are limited to the start-up of the unit, and do not include any other operation on the plant, such as, for example, electrical and hydraulic connections etc. All the other operations before start-up, including oil pre-heating for at least 12 hours, must be performed by the Installer.

#### 5.1 Preliminary check

The checks listed below shall be performed before starting the unit and before the arrival of the personnel authorised by Itelco-Clima.

- Check the section of power supply and grounding cables; make sure that terminals are tightened and check the correct operation of contactors, with the master switch open.
- Check that any voltage and phase variation in the power supply does not exceed the prefixed thresholds.
- Connect the contacts of the flow meter and the thermal relay of the pump and of the other devices (if any), to terminals 1-2 and 3-4, respectively.
- Check that the components of the external water circuit (pump, user equipment, filters, power supply tank and reservoir, if any) have been installed properly, and according to the manufacturer's instructions.
- Check the filling of the hydraulic circuits, and make sure that the fluid circulation is correct, without any trace of leaks and air bubbles. If you use ethylene glycol as antifreeze, check that its percentage is correct.
- Check that the direction of rotation of the pumps is correct, and that fluids have been circulating for at least 12 hours for both pumps. Then, clean the filters on the suction side of the pumps.
- Adjust the liquid distribution network in such a way that the flow rate is within the specified range.
- Check that the water quality is up to the specifications.
- Check that oil heaters, if any, have been turned on at least 12 hours before.

#### 5.2 Start-up

Start-up sequence:

- Turn on the master switch (at least 12 hours before).
- Check that the oil in the compressor has reached the requested temperature (the minimum temperature outside the pan must be approx. 40°C) and that the auxiliary control circuit is energised.
- Check the operation of all the external equipment, and make sure that the control devices of the plant are properly calibrated.
- Start the pump and check that the water flow is correct.
- Set the desired fluid temperature on the control board.
- Start the appliance (see Chapter 6).
- Check the correct direction of rotation of compressors. Scroll compressors cannot compress the refrigerant when they rotate in the opposite direction. To make sure that they are rotating in the correct direction, simply check that, just after the start-up of the compressor, the pressure drops on the LP side and rises on the HP side. Furthermore, if a scroll compressor rotate in the opposite direction, there is a considerable rise in the sound level of the unit, as well as in a dramatic reduction of current absorption compared to normal values. In case of wrong rotation, the scroll compressor can be definitely damaged.
- After about 15 minutes of operation check that there are no bubbles, through the sight glass on the liquid line.



The presence of bubbles may indicate that a part of the refrigerant charge has been released in one or more points. It is important to remove these leaks before proceeding.

- Repeat the start-up procedure after removing the leaks.
- Check the oil level in the compressor's sight glass.

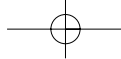

## Start-up

---

### 5.3 Checking the operation

Check the following:

- The temperature of the water entering the evaporator.
- The temperature of the water leaving the evaporator.
- The level of the water flow rate in the evaporator, if possible.
- The current absorption upon the start of the compressor and in case of stabilised operation.
- The fan's current absorption.

Check that the condensing and evaporation temperatures, during operation at high and low pressure detected by the pressure gauges of the refrigerant, are within the following range:  
(On the units not provided with HP/LP pressure gauges for the refrigerant, connect a pressure gauge to the Schreder valves on the refrigeration circuit).

<b>HP side</b>	Approx. 15 to 21 °C above the temperature of the air entering the condenser, for R407C units.
<b>LP side</b>	Approx. 2 to 4 °C below the temperature of the leaving chilled water, for R407C units.

### 5.4 Delivery to the customer

- Train the user according to the instructions provided in Section 6.

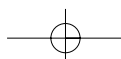

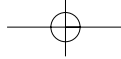

# Control

## 6 CONTROL

### 6.1 Main characteristics

- Microprocessor control.
- Accessible, easy to use control keyboard for the user.
- Proportional or proportional + integr. control on return water temperature (RWT).
- Hysteresis control on leaving water temperature (LWT).
- Access code to have access to the Manufacturer Level.
- Access code to have access to the Assistance Level.
- Sound signal (alarm and LED).
- Backlighted LCD Display.
- Closed loop (feedback) condensing pressure control.
- Pump-Down logics.
- Compressor turnover.
- Multilanguage messages.
- Counting of compressors' working hours.
- Displaying of high pressure values.
- History of stored alarms (option).
- Programming of different ranges of time and 4 set-points (option).

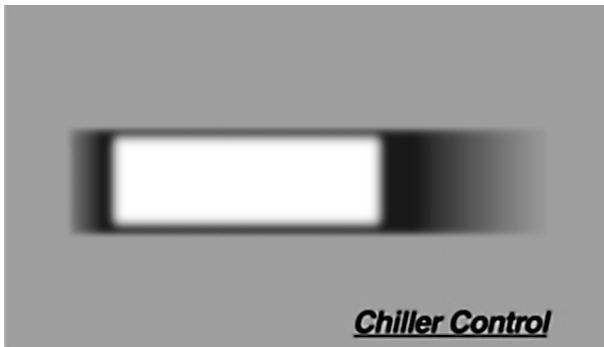

#### ■ Keyboard

The terminal makes it possible to carry out the following operations:

- initial configuration of the machine.
- possibility of modifying the main working parameters.
- displaying of the detected alarms, and relevant sound signal, by means of a 'buzzer'.
- displaying of any measured quantities.

The terminal is connected to the card by a 6-way phone cable.

Connecting the terminal to the motherboard is not essential for the normal operation of the controller.

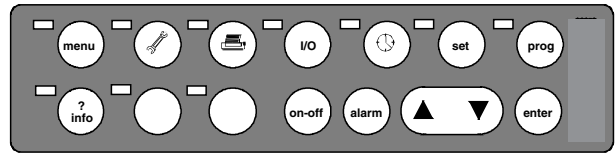

- Access the display mask of the inlet/outlet water temperature and machine status.
- Access the values relative to maintenance of devices under access code (Maintenance Level).
- Not available.
- Access the display mask of the status of digital/analog inputs and outputs.
- Access to the clock programming mask (if the clock card is available).
- Access the display/setting masks of the control setpoint (User Level - Setpoint).
- Access the "Service Level" masks, under access code.
- Displays the information about the software version.

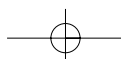



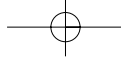

## Control



Figure 1

1. **on/off** key: allows you to turn the unit on/off. The green LED which lights up the key indicates the status of unit.
2. **alarm** key: used to display the alarms, as well as for their manual resetting and to silence the buzzer. If the key is lighed (red), at least an alarm has been detected.

Press it once to silence the buzzer and to display the activated alarm mask.

Press it again to reset the alarm signalling.

3. **up arrow**: allows you to set the values of control parameters and to shift from one mask to another.
4. **down arrow**: allows you to set the values of control parameters and to shift from one mask to another.
5. **enter** key: used to move the cursor inside the masks and to save the values of the set parameters. This key is constantly backlighted (yellow light), to indicate the presence of power supply.

### ■ Display

The display is of the backlighted LCD type, 4 lines x 20 columns.

The quantities and the information about operation are alternated in the form of subsequent screens known as masks.

You can shift from one mask to another using the keys of the terminal, as described below:

```

+-----+
| x      Riga0 |
| Home  Riga1 |
|                |
|                |
|                Riga2 |
|                Riga3 |
+-----+
    
```

If the cursor is positioned in the top left-hand corner (Home), press the UP/DOWN keys to access the subsequent masks associated to the selected branch. If a mask contains value input fields, then press the ENTER key to have the cursor move on these fields. Once you have reached the input field for quantities, you can modify their value, within the preset limits, by pressing the UP/DOWN keys. After fixing the desired value, simply press the ENTER key again to store it.

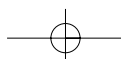
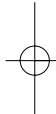
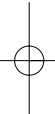

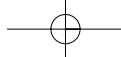

# Control

## ■ Alarm table

Code	Alarm description	Comp Status	Fan Status	Pump Status	Aut/Man Reset	Delay	Notes
AL01	CPS efficiency alarm	Off	Off	Off	Man	30 sec	
AL02	Sys 1 Antifreeze alarm	Off Sys 1	Run	Run	Man	No	
AL03	Sys 2 Antifreeze alarm	Off Sys 2	Run	Run	Man	No	
AL04	Flow meter alarm	Off	Off	Off	Man	Parameter	
AL05	Sys 1 Low pressure	Off Sys 1	Run	Run	Man	Parameter	
AL06	Sys 2 Low pressure	Off Sys 2	Run	Run	Man	Parameter	
AL07	Sys 1 High pressure	Off Sys 1	Run	Run	Man	No	
AL08	Sys 2 High pressure	Off Sys 2	Run	Run	Man	No	
AL11	Compressor 1 thermal switch	Off Comp. 1	Run	Run	Man	No	
AL12	Compressor 2 thermal switch	Off Comp. 2	Run	Run	Man	No	
AL13	Compressor 3 thermal switch	Off Comp. 3	Run	Run	Man	No	
AL14	Compressor 4 thermal switch	Off Comp. 4	Run	Run	Man	No	
AL15	Fan thermal	Off	Off	Run	Man	No	
AL21	Failure of probe B1 Tin	Off	Off	Run	Auto	10 sec	
AL22	Failure of probe B2 Tout1	Off	Off	Run	Auto	10 sec	
AL23	Failure of probe B3 Tout2	Off	Off	Run	Auto	10 sec	
AL24	Failure of probe B4 Tair	Run	Run	Run	Auto	10 sec	
AL25	Failure of probe B5 Tcoil1	Off	Off	Run	Auto	10 sec	(1)
AL26	Failure of probe B6 Tcoil2	Off	Off	Run	Auto	10 sec	(1)
AL27	Failure of probe B7 Sys 1 HP transducer	Off	Off	Run	Auto	10 sec	
AL28	Failure of probe B8 Sys 2 HP transducer	Off	Off	Run	Auto	10 sec	
AL31	Maintenance of compressor 1	Run	Run	Run	Man	No	
AL32	Maintenance of compressor 2	Run	Run	Run	Man	No	
AL33	Maintenance of compressor 3	Run	Run	Run	Man	No	
AL34	Maintenance of compressor 4	Run	Run	Run	Man	No	
AL55	Failure of clock card	Run	Run	Run	Man	No	

(1) = Forced defrosting every 40 min.

## ■ Setpoint

Pressing the Set key allows you to enter the Set point level accessible to the user. The parameters that can be set are listed below, along with the limit values and the default values (standard shop settings):

User parameters	Control mode	Min value	Max value	Default			
Cooling Set point	Return Control	8	20	10			
	Outlet Control	6	20	8			
Cooling Set point - glycol water	Return Control	-15	20	10			
	Outlet Control	-15	20	8			
Proportional band Neutral differential band	Return Control	1	10	5			
	Outlet Control	1	6	2			
Heating Set point	Return Control	20	45	40			
	Outlet Control	20	50	40			
Select language	—	ITA	ENG	FRENCH	GERMAN	SPANISH	Italian
System 1 ON/OFF	—	ON		OFF		OFF	
System 2 ON/OFF	—	ON		OFF		OFF	

In this level you can select the language of operation. The choice is between English and Italian. Languages available on demand: French - German - Spanish. Every single circuit is activated through the relevant parameters. All quantities at Manufacturer Level are available in Italian only.

NOTE: Leaving water temperature (VLS 504-1204)

WARNING: In VLS 504-1204 models, a pre-freezing control is always enabled. If the leaving water temperature reaches critical values, the unit's chilling capacity is reduced for some time.

In general, if the leaving water temperature (LWT) control is selected, the user and the installer shall bear in mind that the controlled temperature is given by the mean of the leaving water temperatures, from the two circuits.

For an ideal use of the control of the leaving non-glycol water, it is recommended to avoid presetting leaving water Set-Point values below 8°C (default).

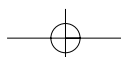

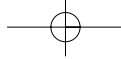

## Control

### 6.2 Protection and Safety Equipment

#### Defrosting System (only for VLH models)

The VLH units are provided with an automatic defrosting system, which prevents the formation of excessive ice banks on coolant/air exchangers during heat pump operation.

This system, which is part of the electronic control system, is of the time/temperature type, and when the temperature detected by a sensor at the inlet of the coil drops below 0°C, once the preset time is over, switches from heating to cooling the operation of the unit, with the fans stopped.

During the defrosting cycle the compressor works normally, but the coil's fans remain off. The defrosting cycle stops after the coil has been defrosted, and at this point the unit can work in heating mode again.



Both circuits are defrosted at the same time. For safety purposes, fans are started also during defrosting, if the discharge pressure reaches considerable values.

#### Frost Protection for the Chilled Fluid

These units are provided with frost protection for the chilled fluid. This protection consists of an electrical resistor positioned in contact with the coolant/circulating fluid exchanger, which is activated (although the unit is off) when the temperature of the fluid drops below 5 °C - the standard value for a non-glycol unit.

If the leaving water temperature drops below 4 °C (standard value for a non-glycol unit) the machine's antifreeze alarm is activated. If the circulating fluid is water, before the beginning of the cold season it is advisable to drain the circuit to prevent water frosting.

If the circuit cannot be drained, it is essential to avoid de-energizing the unit, so as to permit the activation, when necessary, of the frost protection.

#### Compressor Protection

Compressors are equipped with a heating element to prevent oil dilution, which may result in remarkable risks of failure of compressors.

The windings of the compressors' motors are provided with a thermal protection.

For VLS/VLH models an accessory kit for thermal protection is available, for any overcurrent of scroll compressors, which shall be shop-mounted.

#### Electrical flow switch

To ensure the correct operation of the unit, a electrical flow switch must be installed, to prevent the unit working in case of insufficient circulation of the chilled fluid.



The electrical flow switch must be carefully installed, according to the instructions given by the Manufacturer.

The electrical flow switch must be installed on the pressing side of the circulation pump for the fluid, just upstream of the heat exchanger's inlet. The electrical flow switch must be installed in a horizontal straight length of piping, in a position reasonably far (both upstream and downstream) from localized pressure drops (curves, valves etc.).

#### Continuous Regulation of the Fan Speed

When working in cooling mode, the standard unit can reach a temperature of -5°C. The fans' speed regulator, if installed, allows the unit to work at a room temperature down to -18°C.

#### Differential pressure switch

This pressure switch halts the operation of the unit in the event that it does not detect a sufficient pressure drop through the exchanger.

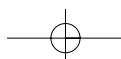

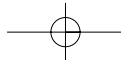

## General Description

### 7 GENERAL DESCRIPTION

#### 7.1 Introduction

The VLS/VLH units are water chillers /air-water heat pumps provided with hermetic scroll compressors with two refrigeration circuits.

These units are fit for cooling and heating intermediate fluids (glycoled water), for air-conditioning appli-

cations in industrial processes.

These units can be installed outdoor on the roof of a building or at ground level.

This series includes the following versions:

Version	Description
VLS/VLH Standard version (STD) VLS/VLH Low Noise version(LN) VLS/VLH Extra Low Noise version (ELN) VLS/VLH High Efficiency/Temperature version (HET)	Chillers/Heat pumps with air condensation, using the R407C refrigerant.

For each VLS version, the corresponding outdoor version (VLC) is available.

Available options:

Options	Description
VLS/D VLH/D	The heat recovery is carried out by a desuperheater mounted on the compressor's discharge line.

#### 7.2 General specifications

The VLS/VLH units are supplied complete and provided with all connecting pipes for the refrigerant and internal wiring.

The refrigeration circuit of each unit undergoes a pressure test, is drained, vacuumised, dehydrated and filled with refrigerant, and includes the necessary oil. Once assembled, each unit is subjected to a complete final testing and the correct operation of all refrigeration circuits is checked.

The base and the frame of each unit are made of very thick galvanised sheet, and are secured by screw and stainless bolts. All panels are secured by screw and tropicalised steel bolts, they can be disassembled for easy access to internal components.

All galvanised steel parts are painted with white polyester resin (RAL 9001), to ensure the resistance of the unit to corrosion and weather agents over time.

#### 7.3 Compressors

These units are provided with hermetic scroll compressors, with built-in motor protection.

Compressors are mounted on shock absorbers to reduce vibrations. Motors are of direct start-up type, cooled by the sucked refrigerant gas.

Thermistors protect the windings from any overtemperatures and the electronic control checks that the delivery temperature is within the permissible range.

The capacity control, as well as the control of the delivered cooling capacity, are always ensured by the electronic control.

#### 7.4 Refrigeration circuits

Each unit has two complete refrigeration circuits, including: a service valve to fill the unit with refrigerant, shut-off valves, thermostatic expansion valve, dehydrating filter, sight glass with humidity indicator, a differential pressure switch for the water. The outdoor VLC units, deriving from the VLS versions, are marked by the absence of the evaporator, and are equipped with shutoff cocks on the suction line and on the liquid line, so as to allow the connection of remote evaporators. Furthermore, each circuit is equipped with safety devices in accordance with PED 97/23/EC: HP and LP pressure switches, safety valves providing protection in case of fire or malfunction of compressors.

#### 7.5 Water heat exchanger

The evaporators are of stainless steel plate type. Their thermal insulation is ensured by a thick flexible closed-cell heat-insulating jacket. Furthermore, the frost protection is ensured by electric heaters. These exchangers can work at pressures up to 10 bar on the hydraulic side and 30 bar on the refrigerant side.

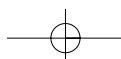

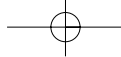

## General Description

The hydraulic connections to the evaporator are of 2" 1/2 Victaulic type on 504 – 804 units and 3" Victaulic type on 904 – 1204 units.

### 7.6 Air heat exchanger

Coils are made of copper pipes in staggered rows, mechanically expanded inside an aluminium finned pack.

### 7.7 Fans

Fans are of directly coupling propeller type, provided with aluminium blade with wing profile. Each fan is provided with galvanised steel accident-prevention guard.

Finally, motors are completely closed, protection class IP54, protection thermostat immersed in windings.

### VLS refrigeration diagram

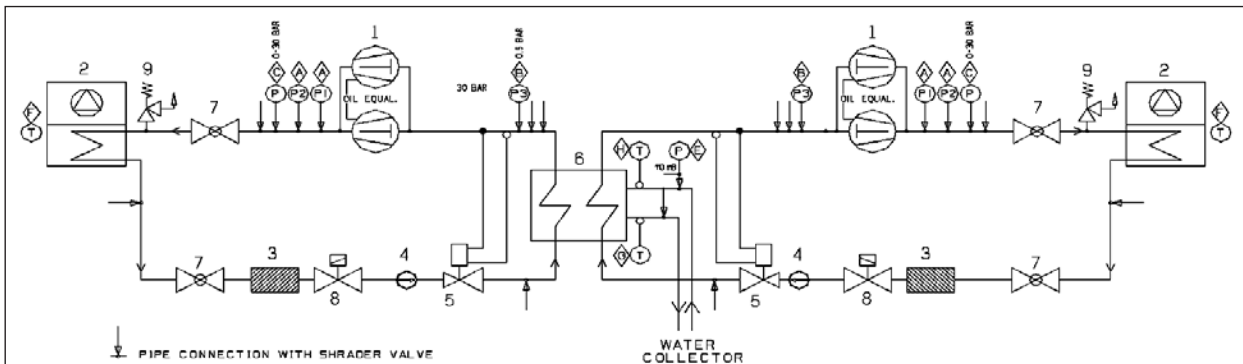

**Components:**

- 1) Compressor (Tandem Scroll)
- 2) Air condenser
- 3) Dehydrator filter
- 4) Liquid sight glass
- 5) Thermostatic expansion valve
- 6) Heat exchanger
- 7) Ball shutoff cock
- 8) Solenoid valve
- 9) Safety valve

**Safety and control devices:**

- A) HP pressure switch
- B) LP pressure switch
- C) HP transducer
- E) Differential pressure switch
- F) Air temperature sensor
- G) Water outlet temperature sensor
- H) Water inlet temperature sensor

### VLH refrigeration diagram

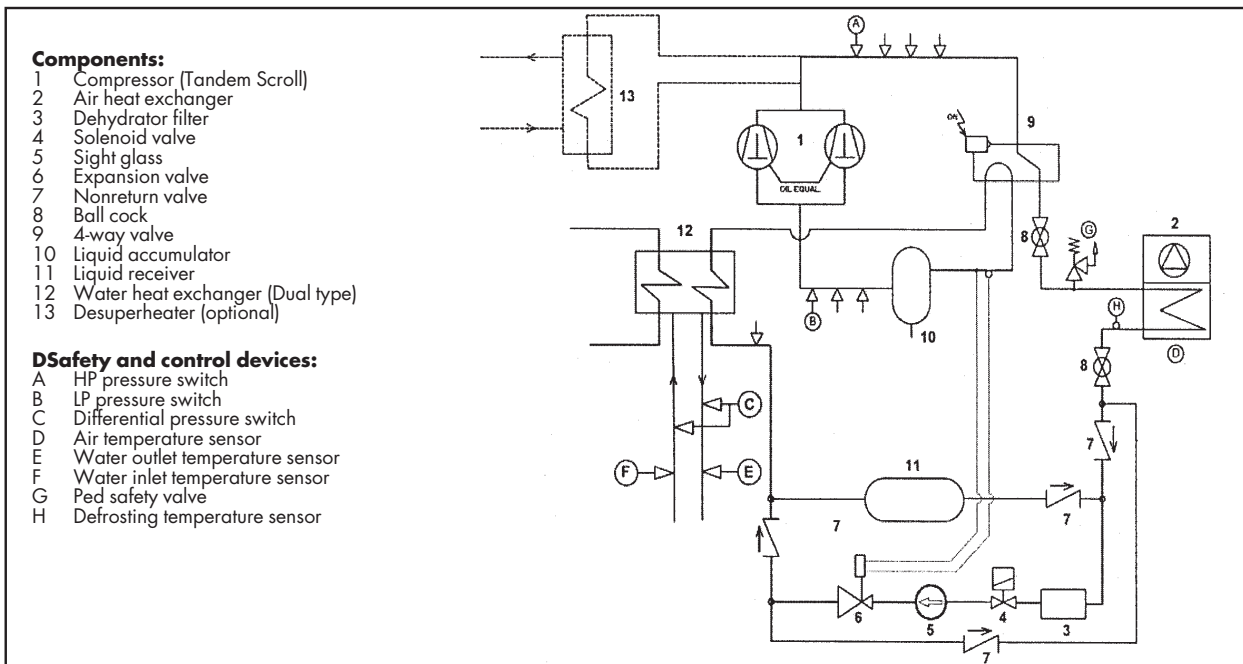

**Components:**

- 1 Compressor (Tandem Scroll)
- 2 Air heat exchanger
- 3 Dehydrator filter
- 4 Solenoid valve
- 5 Sight glass
- 6 Expansion valve
- 7 Nonreturn valve
- 8 Ball cock
- 9 4-way valve
- 10 Liquid accumulator
- 11 Liquid receiver
- 12 Water heat exchanger (Dual type)
- 13 Desuperheater (optional)

**DSafety and control devices:**

- A HP pressure switch
- B LP pressure switch
- C Differential pressure switch
- D Air temperature sensor
- E Water outlet temperature sensor
- F Water inlet temperature sensor
- G Ped safety valve
- H Defrosting temperature sensor

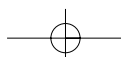

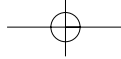

## General Description

### VLC refrigeration diagram

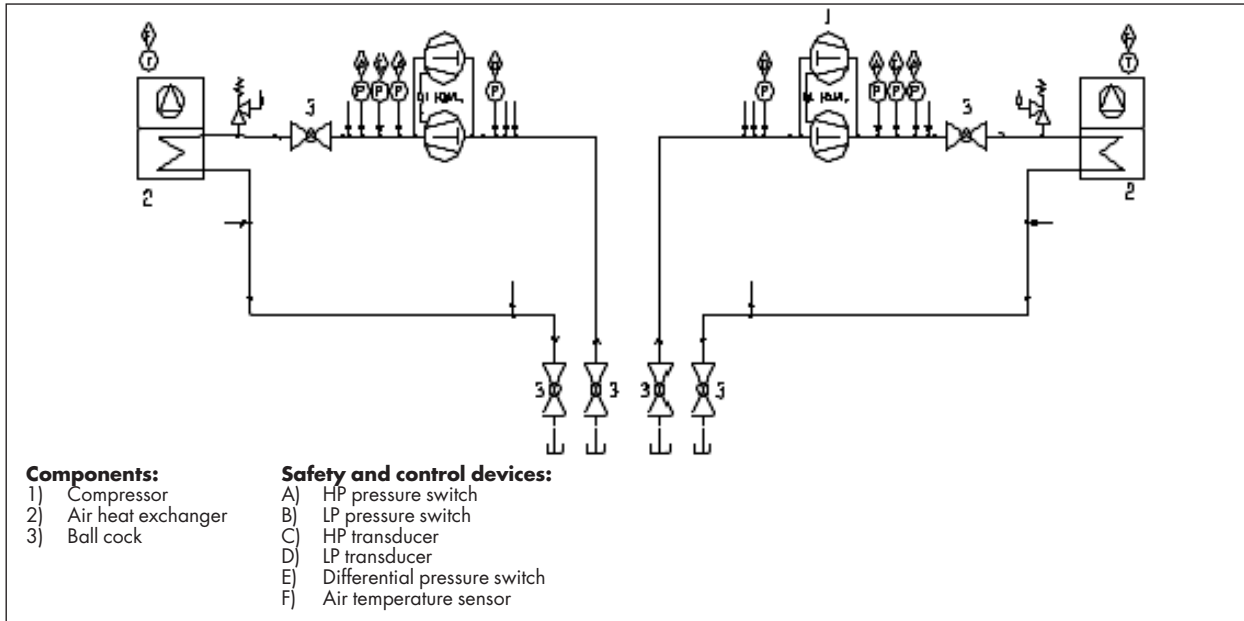

### 7.8 Electric power supply and control system

The control compartment contains an electronic card with keyboard and a display for working parameters, alarms, if any, and operating blocks.

It is complete with remote control switches and protection fuses for the motors of compressors, fans and pumps.

### 7.9 Accessories

List of available accessories, provided separately, to be mounted on site by the installer:

#### Water flow meter

Prevents the operation of the unit when the chilled fluid is insufficient. It is advisable to install a flow meter, to ensure the correct operation of the unit.

#### Water filter

Filter to be mounted on the suction side of the water heat exchanger.

#### Antivibrating supports (AVM)

Isolating spring supports, equipped with bolts for fastening to the base. They are supplied separated from the unit and must be mounted on site by the customer, at his own expense.

### Fan speed regulator

The speed regulator of the fans is mounted as a standard accessory for the Extra Low Noise units, and is an optional accessory for the Standard and Low Noise units. The fan speed is controlled in order to work at a low room temperature, and allows the unit to work down to a room temperature of  $-18^{\circ}\text{C}$ .

The control can be of the pressostatic step type, with temperature correction, or of continuous type (under pressure), with electronic regulator. The regulator is of electronic type only for the Extra Low Noise versions.

### Wire-type remote control kit

The kit includes a remote control for wall mounting, complete with 3m-long connecting cable, and installation manual and a transformer.

For longer distances (i.e. up to 50m) you can use a multipolar cable of minimum section (0.25mm). Conductors should be connected directly and according to the diagram with accompanies the installation instructions.

### Remote wall terminal

Makes it possible to check the unit through a remote terminal, up to a maximum distance of 200 meters.

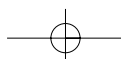

## General Description

---

### RS 485 MODBUS serial card

A communication interface makes it possible to control and manage the unit from a local station, with RS485 connection, up to a distance of 1,000m. It is possible to obtain the remote control and the management, by inserting the control into the management plant of the building.

### Hydronic module

The Hydronic Module, to be installed on site at the Customer's expense, is a hydraulic package which includes all the components required for the fluid distribution system. It has been designed for outdoor installation, on the roofing of the building, rather than directly at the ground level.

The Hydronic Module is enclosed in its own case and includes:

- an inertial tank
- a single or double pump for standard head or high head
- the expansion tank
- a water filter installed near the suction of the pump
- a pressure gauge
- shutoff valves for filter maintenance purposes
- a safety valve, calibrated at 3 bar
- an automatic air relief valve
- fill and drain valves
- thermal insulation for piping and hydronic components
- a switchboard (protection class IP54) provided with main disconnecting switch, contactors and fuses for the pump and the electric heaters, if any
- antifreeze electric heater (optional)
- kit of antivibrating devices (optional) to be used if the appliance is to be installed on the refrigerator
- cascade start-up sequencer (up to 4 parallel units).

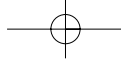

## Technical data

### 8 TECHNICAL DATA

#### 8.1 Pressure drops

PRESSURE DROPS IN THE EVAPORATOR										
		VLS 504	VLS 554	VLS 604	VLS 704	VLS 804	VLS 904	VLS 1004	VLS 1104	VLS 1204
<b>K</b>		7,2	7,2	6,1	6,1	4,6	1,9	1,9	1,9	1,9
Min. water flow rate	l/s	3,8	4,2	4,4	5,4	6,1	7,0	7,9	8,7	9,3
Nominal flow rate	l/s	6,1	6,7	7,1	8,6	9,7	11,2	12,6	13,9	15,0
Max. water flow rate	l/s	10,1	11,1	11,8	14,4	16,2	18,7	21,0	23,1	25,0
Min. pressure drops	kPa	10,3	12,5	11,8	17,7	16,9	9,5	11,9	14,5	16,8
Nominal pressure drops	kPa	26,4	32,1	30,2	45,2	43,2	24,2	30,5	37,0	43,1
Max. pressure drops	kPa	73,3	89,1	84,0	125,5	120,0	67,3	84,6	102,8	119,7

PRESSURE DROPS IN THE DESUPERHEATER										
		VLS 504	VLS 554	VLS 604	VLS 704	VLS 804	VLS 904	VLS 1004	VLS 1104	VLS 1204
<b>K</b>		259,2	259,2	259,2	155,5	64,8	64,8	64,8	64,8	64,8
Min. water flow rate	l/s	0,5	0,6	0,6	0,7	0,8	1,0	1,1	1,2	1,3
Nominal flow rate	l/s	0,8	0,9	1,0	1,2	1,3	1,5	1,7	1,9	2,0
Max. water flow rate	l/s	1,4	1,5	1,6	2,0	2,2	2,6	2,9	3,1	3,4
Min. pressure drops	kPa	6,9	8,5	9,7	8,6	4,6	6,0	7,5	8,8	10,5
Nominal pressure drops	kPa	17,7	21,8	24,9	22,1	11,7	15,4	19,3	22,5	26,9
Max. pressure drops	kPa	49,2	60,6	69,1	61,4	32,5	42,9	53,5	62,6	74,7

$$\Delta P = K \cdot Q^2 / 10$$

PRESSURE DROPS IN THE EVAPORATOR										
		VLH 504	VLH 554	VLH 604	VLH 704	VLH 804	VLH 904	VLH 1004	VLH 1104	VLH 1204
<b>K</b>		7,2	7,2	6,1	6,1	4,6	1,9	1,9	1,9	1,9
Min. water flow rate	l/s	3,8	4,1	4,4	5,1	5,9	6,7	7,4	8,3	8,8
Nominal flow rate	l/s	6,0	6,6	7,0	8,1	9,4	10,8	11,9	13,3	14,0
Max. water flow rate	l/s	10,0	11,0	11,6	13,6	15,7	18,0	19,8	22,1	23,4
Min. pressure drops	kPa	10,1	12,3	11,6	15,7	15,8	8,7	10,7	13,3	14,8
Nominal pressure drops	kPa	25,9	31,4	29,6	40,1	40,5	22,4	27,3	34,0	37,9
Max. pressure drops	kPa	71,9	87,3	82,3	111,5	112,6	62,2	75,8	94,4	105,3

PRESSURE DROPS IN THE DESUPERHEATER										
		VLH 504	VLH 554	VLH 604	VLH 704	VLH 804	VLH 904	VLH 1004	VLH 1104	VLH 1204
<b>K</b>		259,2	259,2	259,2	155,5	64,8	64,8	64,8	64,8	64,8
Min. water flow rate	l/s	0,5	0,5	0,6	0,7	0,8	0,9	1,0	1,1	1,2
Nominal flow rate	l/s	0,8	0,9	0,9	1,1	1,3	1,5	1,6	1,8	1,9
Max. water flow rate	l/s	1,3	1,5	1,6	1,9	2,2	2,4	2,7	3,0	3,2
Min. pressure drops	kPa	6,3	7,8	9,0	7,8	4,2	5,4	6,6	8,2	9,5
Nominal pressure drops	kPa	16,2	20,0	23,0	20,0	10,8	13,9	16,8	20,9	24,3
Max. pressure drops	kPa	45,1	55,5	63,9	55,5	30,0	38,5	46,7	58,1	67,4

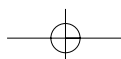



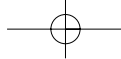

## Technical data

### 8.2 Technical data

VLS STD		504	554	604	704	804	904	1004	1104	1204
Power supply	V/ph/Hz	400 ( $\pm 10\%$ )/3/50								
Number of circuits		2	2	2	2	2	2	2	2	2
Number of steps		4	4	4	4	4	4	4	4	4
Capacity steps	%	20	23	25	20	20	15	25	23	25

#### Refrigerant

Type		R407C								
Charge (l)	kg	18,5	20,3	25,2	23,3	27,3	29,1	32,0	34,3*	36,8*

#### Compressors

Type		Scroll	Scroll	Scroll	Scroll	Scroll	Scroll	Scroll	Scroll	Scroll
Number		4	4	4	4	4	4	4	4	4
Start-up type		Direct	Direct	Direct	Direct	Direct	Direct	Direct	Direct	Direct

#### Evaporator

Type		Plate type								
Number		1	1	1	1	1	1	1	1	1
Water flow rate	L/s	6,1	6,7	7,1	8,6	9,7	11,2	12,6	13,9	15,0
Pressure drop	kPa	26,4	32,1	30,2	45,2	43,2	24,2	30,5	37,0	43,1
Minimum water content	l	10,4	10,4	12,3	12,3	14,5	26	26	26	26

#### Fans

Number		2	2	2	3	3	4	4	4	4
Air flow rate	m <sup>3</sup> /s	11,1	11,1	11,1	16,1	15,8	21,6	21,4	22,9	22,9
Power input	kW	2,8	2,8	2,8	4,2	4,2	5,6	5,6	8	8

#### Condenser

Type		Coil type (Al/Cu)								
------	--	-------------------	--	--	--	--	--	--	--	--

#### Hydraulic connections

Type		Threaded	Threaded	Threaded	Threaded	Threaded	Threaded	Threaded	Threaded	Threaded
Inlet diameter	inch	2 1/2" (male)					3" (male)			
Outlet diameter	inch	2 1/2" (male)					3" (male)			

#### Weights

Shipping	kg	1204	1238	1258	1545	1670	1825	1995	2215	2240
Operating	kg	1214	1248	1270	1560	1685	1855	2025	2245	2270

#### Dimensions

Length	mm	3300	3300	3300	4250	4250	4250	4250	4250	4250
Width	mm	1100	1100	1100	1100	1100	1100	1100	1100	1100
Height	mm	2254	2254	2254	2280	2280	2280	2280	2280	2280

(1) Indicative value. Always refer to the value specified on the unit's label.

\* = estimated value.

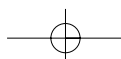

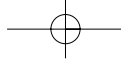

## Technical data

VLS LN		504	554	604	704	804	904	1004	1104	1204
Power supply	V/ph/Hz	400 ( $\pm 10\%$ )/3/50								
Number of circuits		2	2	2	2	2	2	2	2	2
Number of steps		4	4	4	4	4	4	4	4	4
Capacity steps	%	20	23	25	20	20	15	25	23	25

### Refrigerant

Type		R407C								
Charge (1)	kg	21,3*	22,0	25,4	23,0	27,3*	29,0	32,0	34,3*	36,8*

### Compressors

Type		Scroll	Scroll	Scroll	Scroll	Scroll	Scroll	Scroll	Scroll	Scroll
Number		4	4	4	4	4	4	4	4	4
Start-up type		Direct	Direct	Direct	Direct	Direct	Direct	Direct	Direct	Direct

### Evaporator

Type		Plate type								
Number		1	1	1	1	1	1	1	1	1
Water flow rate	L/s	6,1	6,7	7,1	8,6	9,7	11,2	12,6	13,9	15
Pressure drop	kPa	26,4	32,1	30,2	45,2	43,2	24,2	30,5	37,0	43,1
Minimum water content	l	10,4	10,4	12,3	12,3	14,5	26	26	26	26

### Fans

Number		2	2	3	3	3	4	4	4	4
Air flow rate	m <sup>3</sup> /s	8,1	8,1	10,8	12,5	12,2	16,6	16,3	17,0	17,0
Power input	kW	1,9	1,9	2,85	2,85	2,85	3,8	3,8	5	5

### Condenser

Type		Coil type (Al/Cu)								
------	--	-------------------	--	--	--	--	--	--	--	--

### Hydraulic connections

Type		Threaded	Threaded	Threaded	Threaded	Threaded	Threaded	Threaded	Threaded	Threaded
Inlet diameter	inch	2 1/2" (male)					3" (male)			
Outlet diameter	inch	2 1/2" (male)					3" (male)			

### Weights

Shipping	kg	1219	1253	1273	1585	1710	1865	2035	2230	2255
Operating	kg	1229	1263	1285	1600	1725	1895	2065	2260	2285

### Dimensions

Length	mm	3300	3300	3300	4250	4250	4250	4250	4250	4250
Width	mm	1100	1100	1100	1100	1100	1100	1100	1100	1100
Height	mm	2254	2254	2254	2280	2280	2280	2280	2280	2280

(1) Indicative value. Always refer to the value specified on the unit's label.

\* = estimated value.

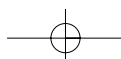

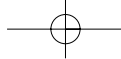

## Technical data

VLS ELN		504	554	604	704	804	904	1004	1104	1204
Power supply	V/ph/Hz	400 ( $\pm 10\%$ )/3/50								
Number of circuits		2	2	2	2	2	2	2	2	2
Number of steps		4	4	4	4	4	4	4	4	4
Capacity steps	%	20	23	25	20	20	15	25	23	25

### Refrigerant

Type		R407C								
Charge (1)	kg	19,3	25,0	25,2	24,0	30,8	31,5	36,0	34,3*	36,8*

### Compressors

Type		Scroll	Scroll	Scroll	Scroll	Scroll	Scroll	Scroll	Scroll	Scroll
Number		4	4	4	4	4	4	4	4	4
Start-up type		Direct	Direct	Direct	Direct	Direct	Direct	Direct	Direct	Direct

### Evaporator

Type		Plate type								
Number		1	1	1	1	1	1	1	1	1
Water flow rate	L/s	6,1	6,7	7,1	8,6	9,7	11,2	12,6	13,9	15
Pressure drop	kPa	26,4	32,1	30,2	45,2	43,2	24,2	30,5	37,0	43,1
Minimum water content	l	10,4	10,4	12,3	12,3	14,5	26	26	26	26

### Fans

Number		3	3	3	4	4	4	4	4	4
Air flow rate	m <sup>3</sup> /s	8,4	8,4	8,4	12,0	11,3	13,1	13,1	14,1	14,1
Power input	kW	2,85	2,85	2,85	3,8	3,8	3,8	3,8	5	5

### Condenser

Type		Coil type (Al/Cu)								
------	--	-------------------	--	--	--	--	--	--	--	--

### Hydraulic connections

Type		Threaded	Threaded	Threaded	Threaded	Threaded	Threaded	Threaded	Threaded	Threaded
Inlet diameter	inch	2 1/2" (male)					3" (male)			
Outlet diameter	inch	2 1/2" (male)					3" (male)			

### Weights

Shipping	kg	1244	1370	1390	1728	1846	2024	2124	2269	2294
Operating	kg	1254	1380	1402	1740	1860	2050	2150	2295	2320

### Dimensions

Length	mm	3300	3300	3300	4250	4250	4250	4250	4250	4250
Width	mm	1100	1100	1100	1100	1100	1100	1100	1100	1100
Height	mm	2254	2254	2254	2280	2280	2280	2280	2280	2280

(1) Indicative value. Always refer to the value specified on the unit's label.

\* = estimated value.

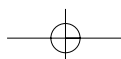

## Technical data

VLS HE		504	554	604	704	804	904	1004
Power supply	V/ph/Hz	400 (± 10%)/3/50						
Number of circuits		2	2	2	2	2	2	2
Number of steps		4	4	4	4	4	4	4
Capacity steps	%	20	23	25	20	20	15	25

### Refrigerant

Type		R407C						
Charge (l)	kg	21,4*	22,0	23,9*	25,8*	30,0	29,0	32,5*

### Compressors

Type		Scroll	Scroll	Scroll	Scroll	Scroll	Scroll	Scroll
Number		4	4	4	4	4	4	4
Start-up type		Direct	Direct	Direct	Direct	Direct	Direct	Direct

### Evaporator

Type		Plate type						
Number		1	1	1	1	1	1	1
Water flow rate	L/s	6,1	6,7	7,1	8,6	9,7	11,2	12,6
Pressure drop	kPa	26,4	32,1	30,2	45,2	43,2	24,2	30,5
Minimum water content	l	10,4	10,4	12,3	12,3	14,5	26	26

### Fans

Number		3	3	3	4	4	4	4
Air flow rate	m <sup>3</sup> /s	16,0	15,0	15,0	22,0	20,8	20,0	20,0
Power input	kW	4,2	4,2	4,2	5,6	5,6	5,6	5,6

### Condenser

Type		Coil type (Al/Cu)						
------	--	-------------------	--	--	--	--	--	--

### Hydraulic connections

Type		Threaded	Threaded	Threaded	Threaded	Threaded	Threaded	Threaded	
Inlet diameter	inch	2 1/2" (male)					3" (male)		
Outlet diameter	inch	2 1/2" (male)					3" (male)		

### Weights

Shipping	kg	1274	1400	1420	1758	1876	2054	2154
Operating	kg	1284	1410	1432	1770	1890	2080	2180

### Dimensions

Length	mm	3300	3300	3300	4250	4250	4250	4250
Width	mm	1100	1100	1100	1100	1100	1100	1100
Height	mm	2254	2254	2254	2280	2280	2280	2280

(1) Indicative value. Always refer to the value specified on the unit's label.

\* = estimated value.

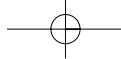

## Technical data

VLC STD		504	554	604	704	804	904	1004	1104	1204
Power supply	V/ph/Hz	400 ( $\pm 10\%$ )/3/50								
Number of circuits		2	2	2	2	2	2	2	2	2
Number of steps		4	4	4	4	4	4	4	4	4
Capacity steps	%	20	23	25	20	20	15	25	23	25

### Refrigerant

Type		R407C								
------	--	-------	--	--	--	--	--	--	--	--

### Compressors

Type		Scroll	Scroll	Scroll	Scroll	Scroll	Scroll	Scroll	Scroll	Scroll
Number		4	4	4	4	4	4	4	4	4
Start-up type		Direct	Direct	Direct	Direct	Direct	Direct	Direct	Direct	Direct

### Fans

Number		2	2	2	3	3	4	4	4	4
Air flow rate	m <sup>3</sup> /s	11,1	11,1	11,1	16,1	15,8	21,6	21,4	22,9	22,9
Power input	kW	2,8	2,8	2,8	4,2	4,2	5,6	5,6	8	8

### Condenser

Type		Coil type (Al/Cu)								
------	--	-------------------	--	--	--	--	--	--	--	--

### Hydraulic connections

Type		Threaded	Threaded	Threaded	Threaded	Threaded	Threaded	Threaded	Threaded	Threaded	
Inlet diameter	inch	2 1/2" (male)					3" (male)				
Outlet diameter	inch	2 1/2" (male)					3" (male)				

### Weights

Shipping	kg	1.111	1.142	1.143	1.433	1.540	1.653	1.817	2.037	2.062
----------	----	-------	-------	-------	-------	-------	-------	-------	-------	-------

### Dimensions

Length	mm	3300	3300	3300	4250	4250	4250	4250	4250	4250
Width	mm	1100	1100	1100	1100	1100	1100	1100	1100	1100
Height	mm	2254	2254	2254	2280	2280	2280	2280	2280	2280

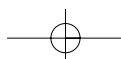

## Technical data

VLC LN		504	554	604	704	804	904	1004	1104	1204
Power supply	V/ph/Hz	400 ( $\pm 10\%$ )/3/50								
Number of circuits		2	2	2	2	2	2	2	2	2
Number of steps		4	4	4	4	4	4	4	4	4
Capacity steps	%	20	23	25	20	20	15	25	23	25

### Refrigerant

Type		R407C								
------	--	-------	--	--	--	--	--	--	--	--

### Compressors

Type		Scroll	Scroll	Scroll	Scroll	Scroll	Scroll	Scroll	Scroll	Scroll
Number		4	4	4	4	4	4	4	4	4
Start-up type		Direct	Direct	Direct	Direct	Direct	Direct	Direct	Direct	Direct

### Fans

Number		2	2	3	3	3	4	4	4	4
Air flow rate	m <sup>3</sup> /s	8,0	8,0	10,8	12,5	12,2	16,6	16,4	17,0	17,0
Power input	kW	1,9	1,9	2,85	2,85	2,85	3,80	3,80	5	5

### Condenser

Type		Coil type (Al/Cu)								
------	--	-------------------	--	--	--	--	--	--	--	--

### Hydraulic connections

Type		Threaded	Threaded	Threaded	Threaded	Threaded	Threaded	Threaded	Threaded	Threaded	
Inlet diameter	inch	2 1/2" (male)					3" (male)				
Outlet diameter	inch	2 1/2" (male)					3" (male)				

### Weights

Shipping	kg	1125	1153	1157	1474	1578	1693	1857	2052	2077
----------	----	------	------	------	------	------	------	------	------	------

### Dimensions

Length	mm	3300	3300	3300	4250	4250	4250	4250	4250	4250
Width	mm	1100	1100	1100	1100	1100	1100	1100	1100	1100
Height	mm	2254	2254	2254	2280	2280	2280	2280	2280	2280

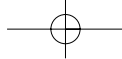

## Technical data

VLC ELN		504	554	604	704	804	904	1004	1104	1204
Power supply	V/ph/Hz	400 ( $\pm 10\%$ )/3/50								
Number of circuits		2	2	2	2	2	2	2	2	2
Number of steps		4	4	4	4	4	4	4	4	4
Capacity steps	%	20	23	25	20	20	15	25	23	25

### Refrigerant

Type		R407C								
------	--	-------	--	--	--	--	--	--	--	--

### Compressors

Type		Scroll	Scroll	Scroll	Scroll	Scroll	Scroll	Scroll	Scroll	Scroll
Number		4	4	4	4	4	4	4	4	4
Start-up type		Direct	Direct	Direct	Direct	Direct	Direct	Direct	Direct	Direct

### Fans

Number		3	3	3	4	4	4	4	4	4
Air flow rate	m <sup>3</sup> /s	8,4	8,4	8,4	12	11,3	13,1	13,1	14,1	14,1
Power input	kW	2,85	2,85	2,85	3,8	3,8	3,8	3,8	5	5

### Condenser

Type		Coil type (Al/Cu)								
------	--	-------------------	--	--	--	--	--	--	--	--

### Hydraulic connections

Type		Threaded	Threaded	Threaded	Threaded	Threaded	Threaded	Threaded	Threaded	Threaded	
Inlet diameter	inch	2 1/2" (male)					3" (male)				
Outlet diameter	inch	2 1/2" (male)					3" (male)				

### Weights

Shipping	kg	1149	1264	1275	1615	1709	1847	1938	2083	2108
----------	----	------	------	------	------	------	------	------	------	------

### Dimensions

Length	mm	3300	3300	3300	4250	4250	4250	4250	4250	4250
Width	mm	1100	1100	1100	1100	1100	1100	1100	1100	1100
Height	mm	2254	2254	2254	2280	2280	2280	2280	2280	2280

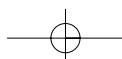

## Technical data

VLC HE		504	554	604	704	804	904	1004	
Power supply	V/ph/Hz	400 (± 10%)/3/50							
Number of circuits		2	2	2	2	2	2	2	
Number of steps		4	4	4	4	4	4	4	
Capacity steps	%	20	23	25	20	20	15	25	
<b>Refrigerant</b>									
Type		R407C							
<b>Compressors</b>									
Type		Scroll	Scroll	Scroll	Scroll	Scroll	Scroll	Scroll	
Number		4	4	4	4	4	4	4	
Start-up type		Direct	Direct	Direct	Direct	Direct	Direct	Direct	
<b>Fans</b>									
Number		3	3	3	4	4	4	4	
Air flow rate	m <sup>3</sup> /s	16	15	15	22	20,8	20	20	
Power input	kW	4,2	4,2	4,2	5,6	5,6	5,6	5,6	
<b>Condenser</b>									
Type		Coil type (Al/Cu)							
<b>Hydraulic connections</b>									
Type		Threaded	Threaded	Threaded	Threaded	Threaded	Threaded	Threaded	
Inlet diameter	inch	2 1/2" (male)					3" (male)		
Outlet diameter	inch	2 1/2" (male)					3" (male)		
<b>Weights</b>									
Shipping	kg	1179	1294	1305	1645	1738,5	1877	1968	
<b>Dimensions</b>									
Length	mm	3300	3300	3300	4250	4250	4250	4250	
Width	mm	1100	1100	1100	1100	1100	1100	1100	
Height	mm	2254	2254	2254	2280	2280	2280	2280	



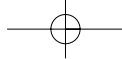

## Technical data

VLH STD		504	554	604	704	804	904	1004	1104	1204
Power supply	V/ph/Hz	400 ( $\pm 10\%$ )/3/50								
Number of circuits		2	2	2	2	2	2	2	2	2
Number of steps		4	4	4	4	4	4	4	4	4
Capacity steps	%	20	23	25	20	20	15	25	23	25

### Refrigerant

Type		R407C								
Charge (l)	kg	25	25	27	30	35	43	44	49*	54*

### Compressors

Type		Scroll	Scroll	Scroll	Scroll	Scroll	Scroll	Scroll	Scroll	Scroll
Number		4	4	4	4	4	4	4	4	4
Start-up type		Direct	Direct	Direct	Direct	Direct	Direct	Direct	Direct	Direct

### Evaporator

Type		Plate type								
Number		1	1	1	1	1	1	1	1	1
Water flow rate	L/s	6	6,6	7	8,1	9,4	10,8	11,9	13,3	14
Pressure drop	kPa	25,9	31,4	29,6	40,1	40,5	22,4	27,3	34	37,9
Minimum water content	l	10,4	10,4	12,3	12,3	14,5	26	26	26	26

### Fans

Number		2	2	2	3	3	4	4	4	4
Air flow rate	m <sup>3</sup> /s	11,1	11,1	11,1	20,0	19,2	24,1	22,7	21,6	21,6
Power input	kW	2,8	2,8	2,8	6	6	8	8	8	8

### Condenser

Type		Coil type (Al/Cu)								
------	--	-------------------	--	--	--	--	--	--	--	--

### Hydraulic connections

Type		Threaded	Threaded	Threaded	Threaded	Threaded	Threaded	Threaded	Threaded	Threaded
Inlet diameter	inch	2 1/2" (male)					3" (male)			
Outlet diameter	inch	2 1/2" (male)					3" (male)			

### Weights

Shipping	kg	1238	1272	1291	1608	1731	1899	1999	2284	2309
Operating	kg	1249	1283	1304	1620	1745	1925	2025	2310	2335

### Dimensions

Length	mm	3300	3300	3300	4250	4250	4250	4250	4250	4250
Width	mm	1100	1100	1100	1100	1100	1100	1100	1100	1100
Height	mm	2254	2254	2254	2280	2280	2280	2280	2280	2280

(1) Indicative value. Always refer to the value specified on the unit's label.

\* = estimated value.

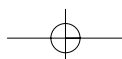

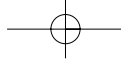

## Technical data

VLH LN		504	554	604	704	804	904	1004	1104	1204
Power supply	V/ph/Hz	400 (+ - 10 %)/3/50								
Number of circuits		2	2	2	2	2	2	2	2	2
Number of steps		4	4	4	4	4	4	4	4	4
Capacity steps	%	20	23	25	20	20	15	25	23	25

### Refrigerant

Type		R407C								
Charge (l)	kg	24	25*	27	28	32	40,5	41	49*	54*

### Compressors

Type		Scroll	Scroll	Scroll	Scroll	Scroll	Scroll	Scroll	Scroll	Scroll
Number		4	4	4	4	4	4	4	4	4
Start-up type		Direct	Direct	Direct	Direct	Direct	Direct	Direct	Direct	Direct

### Evaporator

Type		Plate type								
Number		1	1	1	1	1	1	1	1	1
Water flow rate	L/s	6	6,6	7	8,1	9,4	10,8	11,9	13,3	14
Pressure drop	kPa	25,9	31,4	29,6	40,1	40,5	22,4	27,3	34	37,9
Minimum water content	l	10,4	10,4	12,3	12,3	14,5	26	26	26	26

### Fans

Number		2	2	3	3	3	4	4	4	4
Air flow rate	m <sup>3</sup> /s	8,1	8,1	10,8	15,4	14,6	18,1	16,8	15,7	15,7
Power input	kW	1,9	1,9	2,85	3,75	3,75	5	5	5	5

### Condenser

Type		Coil type (Al/Cu)								
------	--	-------------------	--	--	--	--	--	--	--	--

### Hydraulic connections

Type		Threaded	Threaded	Threaded	Threaded	Threaded	Threaded	Threaded	Threaded	Threaded
Inlet diameter	inch	2 1/2" (male)					3" (male)			
Outlet diameter	inch	2 1/2" (male)					3" (male)			

### Weights

Shipping	kg	1238	1272	1291	1648	1771	1939	2109	2299	2324
Operating	kg	1264	1298	1345	1660	1785	1965	2135	2325	2350

### Dimensions

Length	mm	3300	3300	3300	4250	4250	4250	4250	4250	4250
Width	mm	1100	1100	1100	1100	1100	1100	1100	1100	1100
Height	mm	2254	2254	2254	2280	2280	2280	2280	2280	2280

(1) Indicative value. Always refer to the value specified on the unit's label.

\* = estimated value.

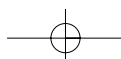

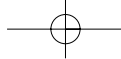

## Technical data

VLH ELN		604	704	804	904	1004	1104	1204
Power supply	V/ph/Hz	400 (+ - 10 %)/3/50						
Number of circuits		2	2	2	2	2	2	2
Number of steps		4	4	4	4	4	4	4
Capacity steps	%	25	20	20	15	25	23	25

### Refrigerant

Type		R407C						
Charge (1)	kg	25*	29,3	33*	37,5	41*	49*	54*

### Compressors

Type		Scroll	Scroll	Scroll	Scroll	Scroll	Scroll	Scroll
Number		4	4	4	4	4	4	4
Start-up type		Direct	Direct	Direct	Direct	Direct	Direct	Direct

### Evaporator

Type		Plate type						
Number		1	1	1	1	1	1	1
Water flow rate	L/s	7	8,1	9,4	10,8	11,9	13,3	14
Pressure drop	kPa	29,6	40,1	40,5	22,4	27,3	34	37,9
Minimum water content	l	12,3	12,3	14,5	26	26	26	26

### Fans

Number		3	4	4	4	4	4	4
Air flow rate	m <sup>3</sup> /s	9,7	13,25	12,5	13,8	13,8	13,8	13,8
Power input	kW	2,85	5	5	5	5	5	5

### Condenser

Type		Coil type (Al/Cu)						
------	--	-------------------	--	--	--	--	--	--

### Hydraulic connections

Type		Threaded	Threaded	Threaded	Threaded	Threaded	Threaded	Threaded
Inlet diameter	inch	2 1/2" (male)			3" (male)			
Outlet diameter	inch	2 1/2" (male)			3" (male)			

### Weights

Shipping	kg	1638	1788	1906	2086	2194	2334	2359
Operating	kg	1650	1800	1920	2112	2220	2360	2385

### Dimensions

Length	mm	4250	4250	4250	4250	4250	4250	4250
Width	mm	1100	1100	1100	1100	1100	1100	1100
Height	mm	2280	2280	2280	2280	2280	2280	2280

(1) Indicative value. Always refer to the value specified on the unit's label.

\* = estimated value.

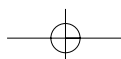

## Technical data

VLH HE		504	554	604	704	804	904	1004
Power supply	V/ph/Hz	400 (+ - 10%)/3/50						
Number of circuits		2	2	2	2	2	2	2
Number of steps		4	4	4	4	4	4	4
Capacity steps	%	20	23	25	20	20	15	25

### Refrigerant

Type		R407C						
Charge (1)	kg	24	24	26*	29	31*	34*	37*

### Compressors

Type		Scroll	Scroll	Scroll	Scroll	Scroll	Scroll	Scroll
Number		4	4	4	4	4	4	4
Start-up type		Direct	Direct	Direct	Direct	Direct	Direct	Direct

### Evaporator

Type		Plate type						
Number		1	1	1	1	1	1	1
Water flow rate	L/s	6	6,6	7	8,1	9,4	10,8	11,9
Pressure drop	kPa	25,9	31,4	29,6	40,1	40,5	22,4	27,3
Minimum water content	l	10,4	10,4	12,3	12,3	14,5	26	26

### Fans

Number		3	3	3	4	4	4	4
Air flow rate	m <sup>3</sup> /s	15,9	15,0	15,0	24,1	22,7	21,6	21,6
Power input	kW	4,2	4,2	4,2	8	8	8	8

### Condenser

Type		Coil type (Al/Cu)						
------	--	-------------------	--	--	--	--	--	--

### Hydraulic connections

Type		Threaded	Threaded	Threaded	Threaded	Threaded	Threaded	Threaded
Inlet diameter	inch	2 1/2" (male)					3" (male)	
Outlet diameter	inch	2 1/2" (male)					3" (male)	

### Weights

Shipping	kg	1249	1375	1395	1738	1856	2036	2144
Operating	kg	1259	1385	1407	1750	1870	206	2170

### Dimensions

Length	mm	3300	3300	3300	4250	4250	4250	4250
Width	mm	1100	1100	1100	1100	1100	1100	1100
Height	mm	2254	2254	2254	2280	2280	2280	2280

(1) Indicative value. Always refer to the value specified on the unit's label.

\* = estimated value.

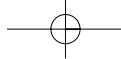

## Technical data

### 8.3 Unit Electrical Data

VLS/VLC STD		504	554	604	704	804	904	1004	1104	1204
Rated voltage	V-ph-Hz	400 ( $\pm 10\%$ )/3/50								
Max. absorbed power	kW	59,4	67,4	72,0	86	97	110	122	135	149
Rated current	A	85,6	94	102,6	119,5	133,7	150,6	164,8	N.D.	N.D.
Max. current FLA	A	101,8	111,8	122,2	144	161	182	200	235	264
Max. start-up current LRA	A	248	258	268	320	384	404	422	493	522
External fuses	(A)	160	160	160	200	200	250	250	250	315
Max. cable section (*)	mm <sup>2</sup>	70	70	70	3x95	3x95	3x120	3x120	3x185	3x185

#### Exchanger Resistance

Power supply	V(%)-ph-Hz	230 ( $\pm 10\%$ )/1/50								
Max. absorbed power	kW	130								

VLS/VLC LN		504	554	604	704	804	904	1004	1104	1204
Rated voltage	V-ph-Hz	400 ( $\pm 10\%$ )/3/50								
Max. absorbed power	kW	58,5	66,5	72,0	85	95	108	120	132	146
Rated current	A	83,6	92	102,3	116,5	130,7	146,6	160,8	N.D.	N.D.
Max. current FLA	A	99,8	109,8	121,9	141	158	178	196	228	257
Max. start-up current LRA	A	246	256	268	317	381	400	418	486	515
External fuses	(A)	160	160	160	200	200	250	250	250	315
Max. cable section (*)	mm <sup>2</sup>	70	70	70	3x95	3x95	3x120	3x120	3x185	3x185

#### Exchanger Resistance

Power supply	V(%)-ph-Hz	230 ( $\pm 10\%$ )/1/50								
Max. absorbed power	kW	130								

VLS/VLC ELN		504	554	604	704	804	904	1004	1104	1204
Rated voltage	V-ph-Hz	400 ( $\pm 10\%$ )/3/50								
Max. absorbed power	kW	59,4	67,4	72,0	86	96	108	120	132	146
Rated current	A	85,3	93,7	102,3	118	132	147	161	N.D.	N.D.
Max. current FLA	A	101,5	111,5	121,9	142	160	178	196	228	257
Max. start-up current LRA	A	247	257	268	319	382	400	418	486	515
External fuses	(A)	160	160	160	200	200	250	250	250	315
Max. cable section (*)	mm <sup>2</sup>	70	70	70	3x95	3x95	3x120	3x120	3x185	3x185

#### Exchanger Resistance

Power supply	V(%)-ph-Hz	230 ( $\pm 10\%$ )/1/50								
Max. absorbed power	kW	130								

(\*) The dimensioning of the unit's power cables is the responsibility of the installer, who shall consider: the rating, the maximum working temperature in the room, the type of insulation and the cable laying, the maximum length of the power supply line.  
N.D. Not available.

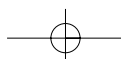

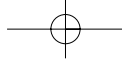

## Technical data

### Unit Electrical Data

VLS/VLC HE		504	554	604	704	804	904	1004
Rated voltage	V-ph-Hz	400 (±10%)/3/50						
Max. absorbed power	kW	60,8	68,8	73,4	88	98	110	122
Rated current	A	81,3	96,7	105,3	122	136	151	165
Max. current FLA	A	104,5	114,5	124,9	146	164	182	200
Max. start-up current LRA	A	250	260	271	323	386	404	422
External fuses	(A)	160	160	160	200	200	250	250
Max. cable section (*)	mm <sup>2</sup>	70	70	70	3x95	3x95	3x120	3x120

### Exchanger Resistance

Power supply	V(%)ph-Hz	230 (±10%)/1/50						
Max. absorbed power	kW	130						

(\*) The dimensioning of the unit's power cables is the responsibility of the installer, who shall consider: the rating, the maximum working temperature in the room, the type of insulation and the cable laying, the maximum length of the power supply line.

### Compressors Electrical Data

VLS/VLC		504	554	604	704	804	904	1004	1104	1204
Number		4	4	4	4	4	4	4	4	4
Nominal power input	kW	(9+13,7) x 2	(12+13,7) x 2	(13,7+13,7) x 2	(13,7+18,6) x 2	(13,7+23,0) x 2	(13,7+23,0) + (23,0+23,0) x 2	(23,0+23,0) x 2	(25,3+25,3) + (20,3+20,3) x 2	(25,3+25,3) x 2
Max. absorbed power	kW	(11+17) x 2	(15+17,3) x 2	(17+17,3) + (17,3+17,3) x 2	(17+24) x 2	(17+29) x 2	(17+29) + (29+29) x 2	(29+29) x 2	(35,2+35,2) + (28,1+28,1) x 2	(35,2+35,2) x 2
Rated current	A	(15,8+24,3) x 2	(20+24,3) x 2	(24,3+24,3) x 2	(24,3+31,4) x 2	(24,3+38,5) x 2	(24,3+38,5) + (38,5+38,5) x 2	(38,5+38,5) x 2	(44,2+44,2) + (34,3+34,3) x 2	(44,2+44,2) x 2
Max. current	A	(19+29,2) x 2	(24+29) x 2	(29+29) x 2	(29+38,5) x 2	(29+47) x 2	(29+47) + (47+47) x 2	(47+47) x 2	(62+62) + (47,5+47,5) x 2	(62+62) x 2
Oil pan resistor	W	(50-75) x 2	(50-75) x 2	(75-75) x 2	(75-130) x 2	(75-130) x 2	(75-130- 130-130) x 2	(130-130) x 2	(150-150) x 2	(150-150) x 2

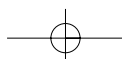

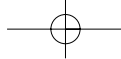

## Technical data

### Fans Electrical Data

<b>VLS/VLC STD</b>		<b>504</b>	<b>554</b>	<b>604</b>	<b>704</b>	<b>804</b>	<b>904</b>	<b>1004</b>	<b>1104</b>	<b>1204</b>
Power supply	V(%)·ph-Hz	400 (±10%)/3/50								
Number		2	2	2	3	3	4	4	4	4
Rated power	kW	1,4	1,4	1,4	1,4	1,4	1,4	1,4	2	2
Absorbed rated current FLA	A	2,7	2,7	2,7	2,7	2,7	2,7	2,7	4	4

<b>VLS/VLC LN</b>		<b>504</b>	<b>554</b>	<b>604</b>	<b>704</b>	<b>804</b>	<b>904</b>	<b>1004</b>	<b>1104</b>	<b>1204</b>
Power supply	V(%)·ph-Hz	400 (±10%)/3/50								
Number		2	2	3	3	3	4	4	4	4
Rated power	kW	0,94	0,94	0,94	0,95	0,95	0,95	0,95	1,3	1,3
Absorbed rated current FLA	A	1,7	1,7	1,7	1,7	1,7	1,7	1,7	2,3	2,3

<b>VLS/VLC ELN</b>		<b>504</b>	<b>554</b>	<b>604</b>	<b>704</b>	<b>804</b>	<b>904</b>	<b>1004</b>	<b>1104</b>	<b>1204</b>
Power supply	V(%)·ph-Hz	400 (±10%)/3/50								
Number		3	3	3	4	4	4	4	4	4
Rated power	kW	0,94	0,94	0,94	0,95	0,95	0,95	0,95	1,3	1,3
Absorbed rated current FLA	A	1,7	1,7	1,7	1,7	1,7	1,7	1,7	2,3	2,3

<b>VLS/VLC HE</b>		<b>504</b>	<b>554</b>	<b>604</b>	<b>704</b>	<b>804</b>	<b>904</b>	<b>1004</b>
Power supply	V(%)·ph-Hz	400 (±10%)/3/50						
Number		3	3	3	4	4	4	4
Rated power	kW	1,4	1,4	1,4	1,4	1,4	1,4	1,4
Absorbed rated current FLA	A	2,7	2,7	2,7	2,7	2,7	2,7	2,7

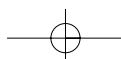

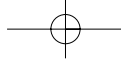

## Technical data

### Unit Electrical Data

VLH STD		504	554	604	704	804	904	1004	1104	1204
Rated voltage	V-ph-Hz	400 (±10%)/3/50								
Max. absorbed power	kW	59,4	67,4	72	88,2	104,6	110,3	112,3	135	149
Rated current	A	85,6	94	102,6	123,4	137,6	155,8	170	N.D.	N.D.
Max. current FLA	A	101,8	111,8	122,2	147,4	164,8	186,8	204,8	235	264
Max. start-up current LRA	A	248	258	268	324	388	392	428	493	522
External fuses	(A)	160	160	160	200	200	200	200	250	315
Max. cable section(*)	mm <sup>2</sup>	70	70	70	3x95	3x95	3x120	3x120	3x185	3x185

#### Exchanger Resistance

Power supply	V(%)ph-Hz	230 (±10%)/1/50								
Max. absorbed power	kW	130								

VLH LN		504	554	604	704	804	904	1004	1104	1204
Rated voltage	V-ph-Hz	400 (±10%)/3/50								
Max. absorbed power	kW	58,5	66,5	72,0	86,0	96,4	109,3	121,0	132	146
Rated current	A	83,6	92	102,3	118,4	132,5	149	163,2	N.D.	N.D.
Max. current FLA	A	99,8	109,8	121,9	142,3	159,7	180	198	228	257
Max. start-up current LRA	A	246	256	268	317	383	403	421	486	515
External fuses	(A)	160	160	160	200	200	250	250	250	315
Max. cable section(*)	mm <sup>2</sup>	70	70	70	3x95	3x95	3x120	3x120	3x185	3x185

#### Exchanger Resistance

Power supply	V(%)ph-Hz	230 (±10%)/1/50								
Max. absorbed power	kW	130								

VLH ELN		604	704	804	904	1004	1104	1204
Rated voltage	V-ph-Hz	400 (±10%)/3/50						
Max. absorbed power	kW	72,0	87,2	97,6	109,3	121,0	132	146
Rated current	A	102,3	120,6	134,8	149,0	163,2	N.D.	N.D.
Max. current FLA	A	121,9	144,6	162	180	198	228	257
Max. start-up current LRA	A	267,7	321,1	384,8	402,8	420,8	486	515
External fuses	(A)	160	200	200	250	250	250	315
Max. cable section(*)	mm <sup>2</sup>	70	3x95	3x95	3x120	3x120	3x185	3x185

#### Exchanger Resistance

Power supply	V(%)ph-Hz	230 (±10%)/1/50						
Max. absorbed power	kW	130						

(\*) The dimensioning of the unit's power cables is the responsibility of the installer, who shall consider: the rating, the maximum working temperature in the room, the type of insulation and the cable laying, the maximum length of the power supply line.  
N.D. Not available.

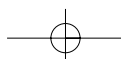



## Technical data

### Unit Electrical Data

VLH HE		504	554	604	704	804	904	1004
Rated voltage	V-ph-Hz	400 (±10%)/3/50						
Max. absorbed power	kW	60,8	68,8	73,4	90,2	100,6	112,3	124
Rated current	A	88,3	96,7	105,3	127,4	141,6	155,8	170
Max. current FLA	A	104,5	114,5	124,9	151,4	168,8	186,8	204,8
Max. start-up current LRA	A	246	260	271	328	392	410	428
External fuses	(A)	160	160	160	200	200	250	250
Max. cable section(*)	mm <sup>2</sup>	70	70	70	3x95	3x95	3x120	3x120

### Exchanger Resistance

Power supply	V(%)ph-Hz	230 (±10%)/1/50	
Max. absorbed power	kW	130	

(\*) The dimensioning of the unit's power cables is the responsibility of the installer, who shall consider: the rating, the maximum working temperature in the room, the type of insulation and the cable laying, the maximum length of the power supply line.

### Compressors Electrical Data

VLH		504	554	604	704	804	904	1004	1104	1204
Number		4	4	4	4	4	4	4	4	4
Nominal power input	kW	(9+13,7) x 2	(12+13,7) x 2	(13,7+13,7) x 2	(13,7+18,6) x 2	(13,7+23,0) x 2	(13,7+23,0) + (23,0+23,0) x 2	(23,0+23,0) x 2	(25,3+25,3) + (20,3+20,3) x 2	(25,3+25,3) x 2
Max. absorbed power	kW	(11+17,3) x 2	(15+17,3) x 2	(17,3+17,3) x 2	(17,3+23,8) x 2	(17,3+29) x 2	(17,3+29) + (29+29) x 2	(29+29) x 2	(35,2+35,2) + (28,1+28,1) x 2	(35,2+35,2) x 2
Rated current	A	(15,8+24,3) x 2	(20+24,3) x 2	(24,3+24,3) x 2	(24,3+31,4) x 2	(24,3+38,5) x 2	(24,3+38,5) + (38,5+38,5) x 2	(38,5+38,5) x 2	(44,2+44,2) + (34,3+34,3) x 2	(44,2+44,2) x 2
Max. current	A	(19+29,2) x 2	(24+29,2) x 2	(29,2+29,2) x 2	(29,2+38,5) x 2	(29,2+47,2) x 2	(29,2+47,2) + (47,2+47,2) x 2	(47,2+47,2) x 2	(62+62) + (47,5+47,5) x 2	(62+62) x 2
Oil pan resistor	W	(65-75) x 2	(65-75) x 2	(75-75) x 2	(75-130) x 2	(75-130) x 2	(75-130- 130-130) x 2	(130-130) x 2	(150-150) x 2	(150-150) x 2

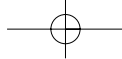

## Technical data

### Fans Electrical Data

VLH STD		504	554	604	704	804	904	1004	1104	1204
Power supply	V(%)·ph-Hz	400 (±10%)/3/50								
Number		2	2	2	3	3	4	4	4	4
Rated power	kW	1,4	1,4	1,4	2	2	2	2	2	2
Max. current FLA	A	2,7	2,7	2,7	4	4	4	4	4	4
Max. start-up current LRA	A	9,8	9,8	9,8	14,0	14,0	14,0	14,0	14,0	14,0

VLH LN		504	554	604	704	804	904	1004	1104	1204
Power supply	V(%)·ph-Hz	400 (±10%)/3/50								
Number		2	2	3	3	3	4	4	4	4
Rated power	kW	0,94	0,94	0,94	1,25	1,25	1,25	1,25	1,3	1,3
Corrente assorbita FLA	A	1,7	1,7	1,7	2,3	2,3	2,3	2,3	2,3	2,3
Max. start-up current LRA	A	3,3	3,3	3,3	4,7	4,7	4,7	4,7	4,7	4,7

VLH ELN		604	704	804	904	1004	1104	1204
Power supply	V(%)·ph-Hz	400 (±10%)/3/50						
Number		3	4	4	4	4	4	4
Rated power	kW	0,94	1,25	1,25	1,25	1,25	1,3	1,3
Max. current FLA	A	1,7	2,3	2,3	2,3	2,3	2,3	2,3
Max. start-up current LRA	A	3,3	4,7	4,7	4,7	4,7	4,7	4,7

VLH HE		504	554	604	704	804	904	1004
Power supply	V(%)·ph-Hz	400 (±10%)/3/50						
Number		3	3	3	4	4	4	4
Rated power	kW	1,4	1,4	1,4	2	2	2	2
Max. current FLA	A	2,7	2,7	2,7	4	4	4	4
Max. start-up current LRA	A	9,8	9,8	9,8	14,0	14,0	14,0	14,0

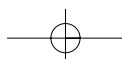

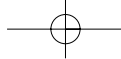

## Technical data

### 8.4 Position of shock absorbers and weight distribution on supports

#### VLS 504-604

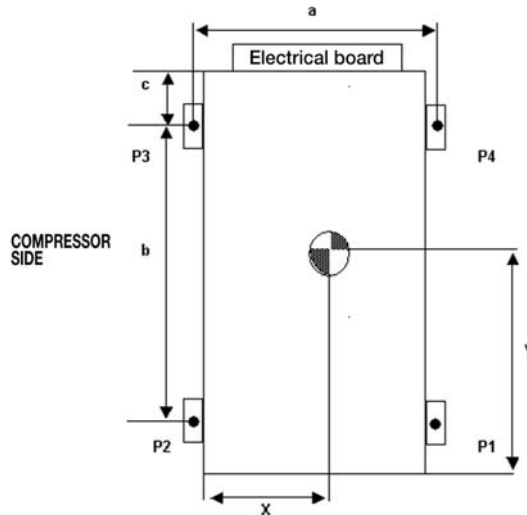

P1 - P4 Unit positions

#### VLS 504 - 604 Al/Cu Standard Version

VLS Al/Cu	Distribution Weights (kg)				Operating Weight (kg)	Shipping Weight (kg)	P1-P4 POSITIONS			CENTRE OF GRAVITY POSITIONS	
	F1 (kg)	F2 (kg)	F3 (kg)	F4 (kg)			a (mm)*	b (mm)	c (mm)	x (mm)	y (mm)
<b>504 STD</b>	214	269	393	338	1214	1204	1137	2174	410	512	1439
<b>554 STD</b>	231	276	393	348	1248	1238	1137	2174	410	512	1439
<b>604 STD</b>	233	283	402	352	1270	1258	1137	2174	410	512	1439

#### VLS 504 - 604 Al/Cu Low Noise Version

VLS Al/Cu	Distribution Weights (kg)				Operating Weight (kg)	Shipping Weight (kg)	P1-P4 POSITIONS			CENTRE OF GRAVITY POSITIONS	
	F1 (kg)	F2 (kg)	F3 (kg)	F4 (kg)			a (mm)*	b (mm)	c (mm)	x (mm)	y (mm)
<b>504 LN</b>	216	272	398	342	1229	1219	1137	2174	410	512	1439
<b>554 LN</b>	233	279	398	353	1263	1253	1137	2174	410	512	1439
<b>604 LN</b>	236	286	406	356	1285	1273	1137	2174	410	512	1439

#### VLS 504 - 604 Al/Cu Extra Low Noise Version

VLS Al/Cu	Distribution Weights (kg)				Operating Weight (kg)	Shipping Weight (kg)	P1-P4 POSITIONS			CENTRE OF GRAVITY POSITIONS	
	F1 (kg)	F2 (kg)	F3 (kg)	F4 (kg)			a (mm)*	b (mm)	c (mm)	x (mm)	y (mm)
<b>504 ELN</b>	221	278	406	349	1254	1244	1137	2174	410	524	1425
<b>554 ELN</b>	255	305	435	385	1380	1370	1137	2174	410	524	1425
<b>604 ELN</b>	258	312	443	389	1402	1390	1137	2174	410	524	1425

#### VLS 504 - 604 Al/Cu High Efficiency Version

VLS Al/Cu	Distribution Weights (kg)				Operating Weight (kg)	Shipping Weight (kg)	P1-P4 POSITIONS			CENTRE OF GRAVITY POSITIONS	
	F1 (kg)	F2 (kg)	F3 (kg)	F4 (kg)			a (mm)*	b (mm)	c (mm)	x (mm)	y (mm)
<b>504 HE</b>	226	284	416	358	1284	1274	1137	2174	410	524	1425
<b>554 HE</b>	260	311	444	394	1410	1400	1137	2174	410	524	1425
<b>604 HE</b>	263	319	453	397	1432	1420	1137	2174	410	524	1425

\* Dimensions are referred to unit with antivibration mounted isolators.

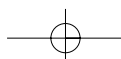

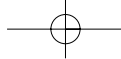

## Technical data

### VLS 504 - 604 Cu/Cu Standard Version

VLS Cu/Cu	Distribution Weights (kg)				Operating Weight (kg)	Shipping Weight (kg)	P1-P4 POSITIONS			CENTRE OF GRAVITY POSITIONS	
	F1 (kg)	F2 (kg)	F3 (kg)	F4 (kg)			a (mm)*	b (mm)	c (mm)	x (mm)	y (mm)
<b>504 STD</b>	266	334	489	421	1510	1500	1137	2174	410	560	1394
<b>554 STD</b>	285	341	487	431	1544	1534	1137	2174	410	560	1394
<b>604 STD</b>	288	349	495	434	1566	1554	1137	2174	410	560	1394

### VLS 504 - 604 Cu/Cu Low Noise Version

VLS Cu/Cu	Distribution Weights (kg)				Operating Weight (kg)	Shipping Weight (kg)	P1-P4 POSITIONS			CENTRE OF GRAVITY POSITIONS	
	F1 (kg)	F2 (kg)	F3 (kg)	F4 (kg)			a (mm)*	b (mm)	c (mm)	x (mm)	y (mm)
<b>504 LN</b>	268	338	494	425	1525	1515	1137	2174	410	560	1394
<b>554 LN</b>	288	344	491	435	1559	1549	1137	2174	410	560	1394
<b>604 LN</b>	305	369	524	459	1656	1644	1137	2174	410	560	1394

### VLS 504 - 604 Cu/Cu Extra Low Noise Version

VLS Cu/Cu	Distribution Weights (kg)				Operating Weight (kg)	Shipping Weight (kg)	P1-P4 POSITIONS			CENTRE OF GRAVITY POSITIONS	
	F1 (kg)	F2 (kg)	F3 (kg)	F4 (kg)			a (mm)*	b (mm)	c (mm)	x (mm)	y (mm)
<b>504 ELN</b>	273	343	502	432	1550	1540	1137	2174	410	579	1375
<b>554 ELN</b>	336	402	574	508	1820	1810	1137	2174	410	579	1375
<b>604 ELN</b>	339	410	582	511	1842	1830	1137	2174	410	579	1375

### VLS 504 - 604 Cu/Cu High Efficiency Version

VLS Cu/Cu	Distribution Weights (kg)				Operating Weight (kg)	Shipping Weight (kg)	P1-P4 POSITIONS			CENTRE OF GRAVITY POSITIONS	
	F1 (kg)	F2 (kg)	F3 (kg)	F4 (kg)			a (mm)*	b (mm)	c (mm)	x (mm)	y (mm)
<b>504 HE</b>	278	350	512	440	1580	1570	1137	2174	410	579	1375
<b>554 HE</b>	342	408	583	516	1850	1840	1137	2174	410	579	1375
<b>604 HE</b>	344	417	592	519	1872	1860	1137	2174	410	579	1375

\* Dimensions are referred to unit with antivibration mounted isolators.

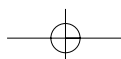

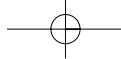

## Technical data

### VLS 704-1204

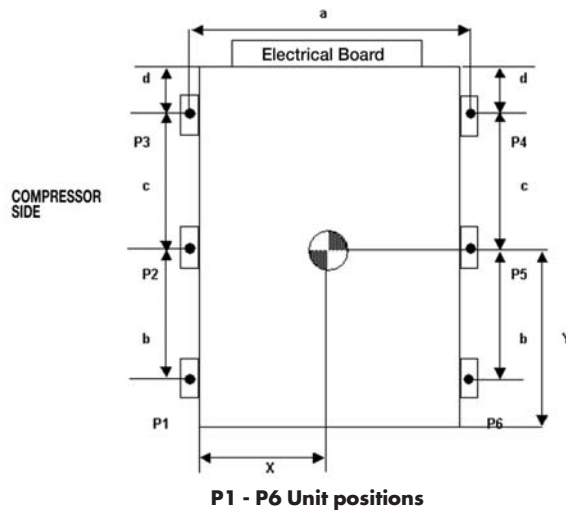

### VLS 704 - 1204 Al/Cu Standard Version

VLS Al/Cu	Distribution Weights (kg)						Operating Weights (kg)	Shipping Weights (kg)	P1-P6 POSITIONS				CENTRE OF GRAVITY POSITIONS	
	F1 (kg)	F2 (kg)	F3 (kg)	F4 (kg)	F5 (kg)	F6 (kg)			a (mm)*	b (mm)	c (mm)	d (mm)	x (mm)	y (mm)
<b>704 STD</b>	216	316	392	255	215	166	1560	1545	1137	1744	1744	250	460	2300
<b>804 STD</b>	234	340	423	275	233	180	1685	1670	1137	1744	1744	250	460	2300
<b>904 STD</b>	265	377	409	335	284	185	1855	1825	1137	1744	1744	250	460	2300
<b>1004 STD</b>	289	411	447	365	310	203	2025	1995	1137	1744	1744	250	460	2300
<b>1104 STD</b>	321	456	495	405	343	225	2245	2215	1137	1744	1744	250	470	2330
<b>1204 STD</b>	324	461	501	410	347	228	2270	2240	1137	1744	1744	250	470	2330

### VLS 704-1204 Al/Cu Low Noise Version

VLS Al/Cu	Distribution Weights (kg)						Operating Weights (kg)	Shipping Weights (kg)	P1-P6 POSITIONS				CENTRE OF GRAVITY POSITIONS	
	F1 (kg)	F2 (kg)	F3 (kg)	F4 (kg)	F5 (kg)	F6 (kg)			a (mm)*	b (mm)	c (mm)	d (mm)	x (mm)	y (mm)
<b>704 LN</b>	222	324	402	261	221	170	1600	1585	1137	1744	1744	250	460	2300
<b>804 LN</b>	239	348	433	282	238	184	1725	1710	1137	1744	1744	250	460	2300
<b>904 LN</b>	271	385	418	342	290	189	1895	1865	1137	1744	1744	250	460	2300
<b>1004 LN</b>	295	419	455	373	316	207	2065	2035	1137	1744	1744	250	460	2300
<b>1104 LN</b>	323	459	498	408	346	227	2260	2230	1137	1744	1744	250	470	2330
<b>1204 LN</b>	326	464	504	412	349	229	2285	2255	1137	1744	1744	250	470	2330

### VLS 704-1204 Al/Cu Extra Low Noise Version

VLS Al/Cu	Distribution Weights (kg)						Operating Weights (kg)	Shipping Weights (kg)	P1-P6 POSITIONS				CENTRE OF GRAVITY POSITIONS	
	F1 (kg)	F2 (kg)	F3 (kg)	F4 (kg)	F5 (kg)	F6 (kg)			a (mm)*	b (mm)	c (mm)	d (mm)	x (mm)	y (mm)
<b>704 ELN</b>	244	348	435	278	244	191	1740	1728	1137	1744	1744	250	485	2230
<b>804 ELN</b>	260	372	465	298	260	205	1860	1846	1137	1744	1744	250	485	2230
<b>904 ELN</b>	293	416	452	370	313	204	2050	2024	1137	1744	1744	250	485	2230
<b>1004 ELN</b>	307	436	474	388	329	214	2150	2124	1137	1744	1744	250	485	2230
<b>1104 ELN</b>	328	466	506	414	351	230	2295	2269	1137	1744	1744	250	470	2330
<b>1204 ELN</b>	331	471	512	419	355	233	2320	2294	1137	1744	1744	250	470	2330

\* Dimensions are referred to unit with antivibration mounted isolators.

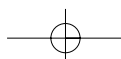

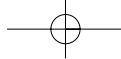

## Technical data

### VLS 704 - 1004 Al/Cu High Efficiency Version

VLS Al/Cu	Distribution Weights (kg)						Operating Weights (kg)	Shipping Weights (kg)	P1-P6 POSITIONS				CENTRE OF GRAVITY POSITIONS	
	F1 (kg)	F2 (kg)	F3 (kg)	F4 (kg)	F5 (kg)	F6 (kg)			a (mm)*	b (mm)	c (mm)	d (mm)	x (mm)	y (mm)
<b>704 HE</b>	248	354	443	283	248	195	1770	1758	1137	1744	1744	250	485	2230
<b>804 HE</b>	270	384	417	341	289	188	1890	1876	1137	1744	1744	250	485	2230
<b>904 HE</b>	297	422	459	375	318	207	2080	2054	1137	1744	1744	250	485	2230
<b>1004 HE</b>	311	443	481	393	333	219	2180	2154	1137	1744	1744	250	485	2230

### VLS 704 - 1204 Cu/Cu Standard Version

VLS Cu/Cu	Distribution Weights (kg)						Operating Weights (kg)	Shipping Weights (kg)	P1-P6 POSITIONS				CENTRE OF GRAVITY POSITIONS	
	F1 (kg)	F2 (kg)	F3 (kg)	F4 (kg)	F5 (kg)	F6 (kg)			a (mm)*	b (mm)	c (mm)	d (mm)	x (mm)	y (mm)
<b>704 STD</b>	255	365	456	297	254	197	1825	1810	1137	1744	1744	250	500	2250
<b>804 STD</b>	292	418	523	340	291	226	2090	2075	1137	1744	1744	250	500	2250
<b>904 STD</b>	321	457	502	409	344	228	2260	2230	1137	1744	1744	250	500	2250
<b>1004 STD</b>	373	531	584	476	400	266	2630	2600	1137	1744	1744	250	500	2250
<b>1104 STD</b>	438	624	685	558	470	311	3085	3055	1137	1744	1744	250	550	2250
<b>1204 STD</b>	441	628	691	563	473	315	3110	3080	1137	1744	1744	250	550	2250

### VLS 704-1204 Cu/Cu Low Noise Version

VLS Cu/Cu	Distribution Weights (kg)						Operating Weights (kg)	Shipping Weights (kg)	P1-P6 POSITIONS				CENTRE OF GRAVITY POSITIONS	
	F1 (kg)	F2 (kg)	F3 (kg)	F4 (kg)	F5 (kg)	F6 (kg)			a (mm)*	b (mm)	c (mm)	d (mm)	x (mm)	y (mm)
<b>704 LN</b>	257	368	460	299	256	199	1840	1825	1137	1744	1744	250	500	2250
<b>804 LN</b>	294	421	527	342	293	228	2105	2090	1137	1744	1744	250	500	2250
<b>904 LN</b>	323	460	505	412	346	230	2275	2245	1137	1744	1744	250	500	2250
<b>1004 LN</b>	375	534	587	479	402	268	2645	2615	1137	1744	1744	250	500	2250
<b>1104 LN</b>	440	627	689	561	472	313	3100	3070	1137	1744	1744	250	550	2250
<b>1204 LN</b>	443	631	694	566	475	316	3125	3095	1137	1744	1744	250	550	2250

### VLS 704-1204 Cu/Cu Extra Low Noise Version

VLS Cu/Cu	Distribution Weights (kg)						Operating Weights (kg)	Shipping Weights (kg)	P1-P6 POSITIONS				CENTRE OF GRAVITY POSITIONS	
	F1 (kg)	F2 (kg)	F3 (kg)	F4 (kg)	F5 (kg)	F6 (kg)			a (mm)*	b (mm)	c (mm)	d (mm)	x (mm)	y (mm)
<b>704 ELN</b>	280	398	432	354	300	195	1960	1948	1137	1744	1744	250	550	2250
<b>804 ELN</b>	309	440	477	391	331	216	2165	2151	1137	1744	1744	250	550	2250
<b>904 ELN</b>	350	498	541	443	375	246	2453	2427	1137	1744	1744	250	550	2250
<b>1004 ELN</b>	366	521	566	463	392	257	2565	2539	1137	1744	1744	250	550	2250
<b>1104 ELN</b>	448	636	691	566	479	314	3135	3109	1137	1744	1744	250	550	2250
<b>1204 ELN</b>	451	642	697	570	483	317	3160	3134	1137	1744	1744	250	550	2250

### VLS 704 - 1004 Cu/Cu High Efficiency Version

VLS Cu/Cu	Distribution Weights (kg)						Operating Weights (kg)	Shipping Weights (kg)	P1-P6 POSITIONS				POSIZIONE OF GRAVITY POSITIONS	
	F1 (kg)	F2 (kg)	F3 (kg)	F4 (kg)	F5 (kg)	F6 (kg)			a (mm)*	b (mm)	c (mm)	d (mm)	x (mm)	y (mm)
<b>704 HE</b>	281	402	503	322	281	221	2010	1998	1137	1744	1744	250	550	2250
<b>804 HE</b>	310	443	554	354	310	244	2215	2201	1137	1744	1744	250	550	2250
<b>904 HE</b>	358	508	552	452	383	250	2503	2477	1137	1744	1744	250	550	2250
<b>1004 HE</b>	374	531	577	472	400	261	2615	2589	1137	1744	1744	250	550	2250

\* Dimensions are referred to unit with antivibration mounted isolators.

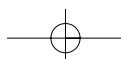

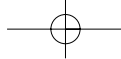

## Technical data

### VLC 504-604

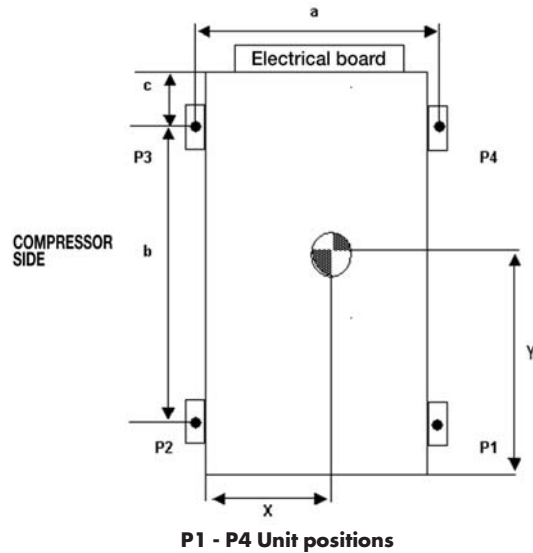

#### VLC 504 - 604 Al/Cu Standard Version

VLC Al/Cu	Distribution Weights (kg)				Shipping Weight (kg)	P1-P4 POSITIONS			CENTRE OF GRAVITY POSITIONS	
	F1 (kg)	F2 (kg)	F3 (kg)	F4 (kg)		a (mm)*	b (mm)	c (mm)	x (mm)	y (mm)
<b>504 STD</b>	196	246	360	310	1111	1137	2174	410	512	1439
<b>554 STD</b>	211	252	360	319	1142	1137	2174	410	512	1439
<b>604 STD</b>	210	255	361	317	1143	1137	2174	410	512	1439

#### VLC 504 - 604 Al/Cu Low Noise Version

VLC Al/Cu	Distribution Weights (kg)				Shipping Weight (kg)	P1-P4 POSITIONS			CENTRE OF GRAVITY POSITIONS	
	F1 (kg)	F2 (kg)	F3 (kg)	F4 (kg)		a (mm)*	b (mm)	c (mm)	x (mm)	y (mm)
<b>504 LN</b>	198	249	364	313	1125	1137	2174	410	512	1439
<b>554 LN</b>	213	254	363	322	1153	1137	2174	410	512	1439
<b>604 LN</b>	213	258	366	321	1157	1137	2174	410	512	1439

#### VLC 504 - 604 Al/Cu Extra Low Noise Version

VLC Al/Cu	Distribution Weights (kg)				Shipping Weight (kg)	P1-P4 POSITIONS			CENTRE OF GRAVITY POSITIONS	
	F1 (kg)	F2 (kg)	F3 (kg)	F4 (kg)		a (mm)*	b (mm)	c (mm)	x (mm)	y (mm)
<b>504 ELN</b>	202	254	372	320	1149	1137	2174	410	524	1425
<b>554 ELN</b>	233	279	398	353	1264	1137	2174	410	524	1425
<b>604 ELN</b>	234	284	403	353	1275	1137	2174	410	524	1425

#### VLC 504 - 604 Al/Cu High Efficiency Version

VLC Al/Cu	Distribution Weights (kg)				Shipping Weight (kg)	P1-P4 POSITIONS			CENTRE OF GRAVITY POSITIONS	
	F1 (kg)	F2 (kg)	F3 (kg)	F4 (kg)		a (mm)*	b (mm)	c (mm)	x (mm)	y (mm)
<b>504 ELN</b>	207	261	382	328	1179	1137	2174	410	524	1425
<b>554 ELN</b>	239	286	408	361	1294	1137	2174	410	524	1425
<b>604 ELN</b>	240	291	413	362	1305	1137	2174	410	524	1425

\* Dimensions are referred to unit with antivibration mounted isolators.

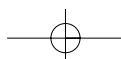

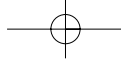

## Technical data

### VLC 504 - 604 Cu/Cu Standard Version

VLC Cu/Cu	Distribution Weights (kg)				Shipping Weight (kg)	P1-P4 POSITIONS			CENTRE OF GRAVITY POSITIONS	
	F1 (kg)	F2 (kg)	F3 (kg)	F4 (kg)		a (mm)*	b (mm)	c (mm)	x (mm)	y (mm)
<b>504 STD</b>	248	311	456	392	1407	1137	2174	410	560	1394
<b>554 STD</b>	266	317	453	401	1438	1137	2174	410	560	1394
<b>604 STD</b>	265	320	455	399	1439	1137	2174	410	560	1394

### VLC 504 - 604 Cu/Cu Low Noise Version

VLC Cu/Cu	Distribution Weights (kg)				Shipping Weight (kg)	P1-P4 POSITIONS			CENTRE OF GRAVITY POSITIONS	
	F1 (kg)	F2 (kg)	F3 (kg)	F4 (kg)		a (mm)*	b (mm)	c (mm)	x (mm)	y (mm)
<b>504 LN</b>	250	314	460	396	1421	1137	2174	410	560	1394
<b>554 LN</b>	268	320	457	404	1449	1137	2174	410	560	1394
<b>604 LN</b>	281	340	483	424	1528	1137	2174	410	560	1394

### VLC 504 - 604 Cu/Cu Extra Low Noise Version

VLC Cu/Cu	Distribution Weights (kg)				Shipping Weight (kg)	P1-P4 POSITIONS			CENTRE OF GRAVITY POSITIONS	
	F1 (kg)	F2 (kg)	F3 (kg)	F4 (kg)		a (mm)*	b (mm)	c (mm)	x (mm)	y (mm)
<b>504 ELN</b>	254	320	468	403	1445	1137	2174	410	579	1375
<b>554 ELN</b>	315	376	537	476	1704	1137	2174	410	579	1375
<b>604 ELN</b>	315	382	542	476	1715	1137	2174	410	579	1375

### VLC 504 - 604 Al/Cu High Efficiency Version

VLC Cu/Cu	Distribution Weights (kg)				Shipping Weight (kg)	P1-P4 POSITIONS			CENTRE OF GRAVITY POSITIONS	
	F1 (kg)	F2 (kg)	F3 (kg)	F4 (kg)		a (mm)*	b (mm)	c (mm)	x (mm)	y (mm)
<b>504 ELN</b>	260	326	478	411	1475	1137	2174	410	579	1375
<b>554 ELN</b>	320	383	546	484	1734	1137	2174	410	579	1375
<b>604 ELN</b>	321	389	552	484	1745	1137	2174	410	579	1375

\* Dimensions are referred to unit with antivibration mounted isolators.

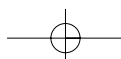



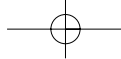

## Technical data

### VLC 704-1204

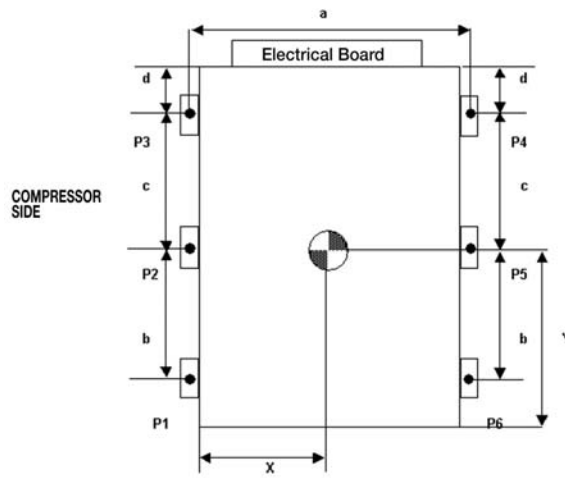

P1 - P6 Unit positions

### VLC 704 - 1204 Al/Cu Standard Version

VLC Al/Cu	Distribution Weights (kg)						Shipping Weights (kg)	P1-P6 POSITIONS				CENTRE OF GRAVITY POSITIONS	
	F1 (kg)	F2 (kg)	F3 (kg)	F4 (kg)	F5 (kg)	F6 (kg)		a (mm)*	b (mm)	c (mm)	d (mm)	x (mm)	y (mm)
<b>704 STD</b>	199	290	360	234	198	153	1433	1137	1744	1744	250	460	2300
<b>804 STD</b>	213	311	386	252	212	164	1540	1137	1744	1744	250	460	2300
<b>904 STD</b>	236	336	365	298	253	165	1653	1137	1744	1744	250	460	2300
<b>1004 STD</b>	260	369	401	328	278	182	1817	1137	1744	1744	250	460	2300
<b>1104 STD</b>	291	414	449	368	311	204	2037	1137	1744	1744	250	470	2330
<b>1204 STD</b>	295	419	455	372	315	207	2062	1137	1744	1744	250	470	2330

### VLC 704-1204 Al/Cu Low Noise Version

VLC Al/Cu	Distribution Weights (kg)						Shipping Weights (kg)	P1-P6 POSITIONS				CENTRE OF GRAVITY POSITIONS	
	F1 (kg)	F2 (kg)	F3 (kg)	F4 (kg)	F5 (kg)	F6 (kg)		a (mm)*	b (mm)	c (mm)	d (mm)	x (mm)	y (mm)
<b>704 LN</b>	204	299	370	241	203	157	1474	1137	1744	1744	250	460	2300
<b>804 LN</b>	219	318	396	258	218	168	1578	1137	1744	1744	250	460	2300
<b>904 LN</b>	242	344	373	306	259	169	1693	1137	1744	1744	250	460	2300
<b>1004 LN</b>	265	377	410	335	284	186	1857	1137	1744	1744	250	460	2300
<b>1104 LN</b>	293	417	453	370	314	206	2052	1137	1744	1744	250	470	2330
<b>1204 LN</b>	297	422	458	375	318	208	2077	1137	1744	1744	250	470	2330

### VLC 704-1204 Al/Cu Extra Low Noise Version

VLC Al/Cu	Distribution Weights (kg)						Shipping Weights (kg)	P1-P6 POSITIONS				CENTRE OF GRAVITY POSITIONS	
	F1 (kg)	F2 (kg)	F3 (kg)	F4 (kg)	F5 (kg)	F6 (kg)		a (mm)*	b (mm)	c (mm)	d (mm)	x (mm)	y (mm)
<b>704 ELN</b>	226	323	404	258	226	178	1615	1137	1744	1744	250	485	2230
<b>804 ELN</b>	239	342	427	273	239	188	1709	1137	1744	1744	250	485	2230
<b>904 ELN</b>	264	375	407	333	282	184	1847	1137	1744	1744	250	485	2230
<b>1004 ELN</b>	277	393	427	350	296	193	1938	1137	1744	1744	250	485	2230
<b>1104 ELN</b>	298	423	459	376	318	209	2083	1137	1744	1744	250	470	2330
<b>1204 ELN</b>	301	428	465	380	322	211	2108	1137	1744	1744	250	470	2330

\* Dimensions are referred to unit with antivibration mounted isolators.

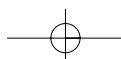

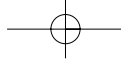

## Technical data

### VLC 704-1004 Al/Cu High Efficiency Version

VLC Al/Cu	Distribution Weights (kg)						Shipping Weights (kg)	P1-P6 POSITIONS				CENTRE OF GRAVITY POSITIONS	
	F1 (kg)	F2 (kg)	F3 (kg)	F4 (kg)	F5 (kg)	F6 (kg)		a (mm)*	b (mm)	c (mm)	d (mm)	x (mm)	y (mm)
<b>704 HE</b>	230	329	411	263	230	181	1645	1137	1744	1744	250	485	2230
<b>804 HE</b>	243	348	435	278	243	191	1739	1137	1744	1744	250	485	2230
<b>904 HE</b>	268	381	414	339	287	187	1877	1137	1744	1744	250	485	2230
<b>1004 HE</b>	281	400	434	355	301	196	1968	1137	1744	1744	250	485	2230

### VLC 704 - 1204 Cu/Cu Standard Version

VLC Cu/Cu	Distribution Weights (kg)						Shipping Weights (kg)	P1-P6 POSITIONS				CENTRE OF GRAVITY POSITIONS	
	F1 (kg)	F2 (kg)	F3 (kg)	F4 (kg)	F5 (kg)	F6 (kg)		a (mm)*	b (mm)	c (mm)	d (mm)	x (mm)	y (mm)
<b>704 STD</b>	237	340	424	276	236	183	1698	1137	1744	1744	250	500	2250
<b>804 STD</b>	272	389	487	316	271	210	1945	1137	1744	1744	250	500	2250
<b>904 STD</b>	292	416	457	372	313	208	2058	1137	1744	1744	250	500	2250
<b>1004 STD</b>	344	489	538	438	368	245	2422	1137	1744	1744	250	500	2250
<b>1104 STD</b>	409	582	639	521	438	290	2877	1137	1744	1744	250	550	2250
<b>1204 STD</b>	412	586	644	525	441	294	2902	1137	1744	1744	250	550	2250

### VLC 704-1204 Cu/Cu Low Noise Version

VLC Cu/Cu	Distribution Weights (kg)						Shipping Weights (kg)	P1-P6 POSITIONS				CENTRE OF GRAVITY POSITIONS	
	F1 (kg)	F2 (kg)	F3 (kg)	F4 (kg)	F5 (kg)	F6 (kg)		a (mm)*	b (mm)	c (mm)	d (mm)	x (mm)	y (mm)
<b>704 LN</b>	239	343	428	279	239	185	1714	1137	1744	1744	250	500	2250
<b>804 LN</b>	274	392	490	319	273	212	1958	1137	1744	1744	250	500	2250
<b>904 LN</b>	294	419	460	375	316	209	2073	1137	1744	1744	250	500	2250
<b>1004 LN</b>	346	492	541	441	371	246	2437	1137	1744	1744	250	500	2250
<b>1104 LN</b>	411	585	642	523	440	292	2892	1137	1744	1744	250	550	2250
<b>1204 LN</b>	414	589	648	528	444	295	2917	1137	1744	1744	250	550	2250

### VLC 704-1204 Cu/Cu Extra Low Noise Version

VLC Cu/Cu	Distribution Weights (kg)						Shipping Weights (kg)	P1-P6 POSITIONS				CENTRE OF GRAVITY POSITIONS	
	F1 (kg)	F2 (kg)	F3 (kg)	F4 (kg)	F5 (kg)	F6 (kg)		a (mm)*	b (mm)	c (mm)	d (mm)	x (mm)	y (mm)
<b>704 ELN</b>	257	367	459	294	257	202	1835	1137	1744	1744	250	550	2250
<b>804 ELN</b>	282	403	503	322	282	221	2014	1137	1744	1744	250	550	2250
<b>904 ELN</b>	321	457	496	406	344	224	2250	1137	1744	1744	250	550	2250
<b>1004 ELN</b>	336	478	519	425	360	235	2353	1137	1744	1744	250	550	2250
<b>1104 ELN</b>	418	593	645	527	447	293	2923	1137	1744	1744	250	550	2250
<b>1204 ELN</b>	421	598	650	532	451	296	2948	1137	1744	1744	250	550	2250

### VLC 704-1004 Cu/Cu High Efficiency Version

VLC Cu/Cu	Distribution Weights (kg)						Shipping Weights (kg)	P1-P6 POSITIONS				CENTRE OF GRAVITY POSITIONS	
	F1 (kg)	F2 (kg)	F3 (kg)	F4 (kg)	F5 (kg)	F6 (kg)		a (mm)*	b (mm)	c (mm)	d (mm)	x (mm)	y (mm)
<b>704 HE</b>	264	377	471	302	264	207	1885	1137	1744	1744	250	550	2250
<b>804 HE</b>	289	413	516	330	289	227	2063	1137	1744	1744	250	550	2250
<b>904 HE</b>	329	467	507	415	352	229	2300	1137	1744	1744	250	550	2250
<b>1004 HE</b>	343	488	530	434	367	240	2403	1137	1744	1744	250	550	2250

\* Dimensions are referred to unit with antivibration mounted isolators.

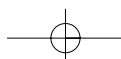

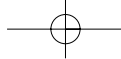

## Technical data

### VLH 504-604

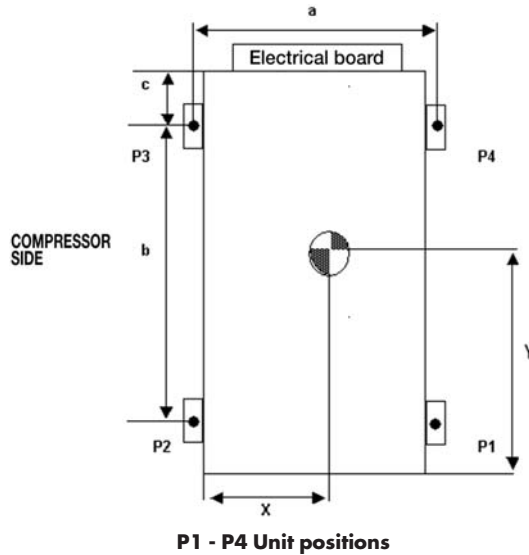

#### VLH 504 - 604 Al/Cu Standard Version

VLH Al/Cu	Distribution Weights (kg)				Operating Weight (kg)	Shipping Weight (kg)	P1-P4 POSITIONS			CENTRE OF GRAVITY POSITIONS	
	F1 (kg)	F2 (kg)	F3 (kg)	F4 (kg)			a (mm)*	b (mm)	c (mm)	x (mm)	y (mm)
<b>504 STD</b>	217	275	407	350	1249	1238	1137	2174	410	512	1439
<b>554 STD</b>	222	286	419	355	1283	1272	1137	2174	410	512	1439
<b>604 STD</b>	225	294	428	358	1304	1291	1137	2174	410	512	1439

#### VLH 504 - 604 Al/Cu Low Noise Version

VLH Al/Cu	Distribution Weights (kg)				Operating Weight (kg)	Shipping Weight (kg)	P1-P4 POSITIONS			CENTRE OF GRAVITY POSITIONS	
	F1 (kg)	F2 (kg)	F3 (kg)	F4 (kg)			a (mm)*	b (mm)	c (mm)	x (mm)	y (mm)
<b>504 LN</b>	220	278	412	354	1264	1254	1137	2174	410	512	1439
<b>554 LN</b>	225	290	424	359	1298	1288	1137	2174	410	512	1439
<b>604 LN</b>	234	305	438	368	1345	1333	1137	2174	410	512	1439

#### VLH 504 - 604 Al/Cu High Efficiency Version

VLH Al/Cu	Distribution Weights (kg)				Operating Weight (kg)	Shipping Weight (kg)	P1-P4 POSITIONS			CENTRE OF GRAVITY POSITIONS	
	F1 (kg)	F2 (kg)	F3 (kg)	F4 (kg)			a (mm)*	b (mm)	c (mm)	x (mm)	y (mm)
<b>504 HE</b>	219	277	410	353	1259	1249	1137	2174	410	524	1425
<b>554 HE</b>	240	309	453	383	1385	1375	1137	2174	410	524	1425
<b>604 HE</b>	243	318	462	387	1407	1395	1137	2174	410	524	1425

\* Dimensions are referred to unit with antivibration mounted isolators.

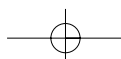

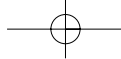

## Technical data

### VLH 504 - 604 Cu/Cu Standard Version

VLH Cu/Cu	Distribution Weights (kg)				Operating Weight (kg)	Shipping Weight (kg)	P1-P4 POSITIONS			CENTRE OF GRAVITY POSITIONS	
	F1 (kg)	F2 (kg)	F3 (kg)	F4 (kg)			a (mm)*	b (mm)	c (mm)	x (mm)	y (mm)
<b>504 STD</b>	269	340	503	432	1545	1534	1137	2174	410	560	1394
<b>554 STD</b>	273	353	516	437	1579	1568	1137	2174	410	560	1394
<b>604 STD</b>	276	362	526	440	1601	1589	1137	2174	410	560	1394

### VLH 504 - 604 Cu/Cu Low Noise Version

VLH Cu/Cu	Distribution Weights (kg)				Operating Weight (kg)	Shipping Weight (kg)	P1-P4 POSITIONS			CENTRE OF GRAVITY POSITIONS	
	F1 (kg)	F2 (kg)	F3 (kg)	F4 (kg)			a (mm)*	b (mm)	c (mm)	x (mm)	y (mm)
<b>504 LN</b>	272	343	508	437	1560	1550	1137	2174	410	560	1394
<b>554 LN</b>	276	356	521	441	1594	1584	1137	2174	410	560	1394
<b>604 LN</b>	234	305	438	368	1641	1629	1137	2174	410	560	1394

### VLH 504 - 604 Cu/Cu High Efficiency Version

VLH Cu/Cu	Distribution Weights (kg)				Operating Weight (kg)	Shipping Weight (kg)	P1-P4 POSITIONS			CENTRE OF GRAVITY POSITIONS	
	F1 (kg)	F2 (kg)	F3 (kg)	F4 (kg)			a (mm)*	b (mm)	c (mm)	x (mm)	y (mm)
<b>504 HE</b>	271	342	507	435	1555	1545	1137	2174	410	579	1375
<b>554 HE</b>	316	408	597	505	1825	1815	1137	2174	410	579	1375
<b>604 HE</b>	319	418	607	509	1850	1838	1137	2174	410	579	1375

\* Dimensions are referred to unit with antivibration mounted isolators.

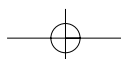

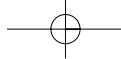

## Technical data

### VLH 704-1204

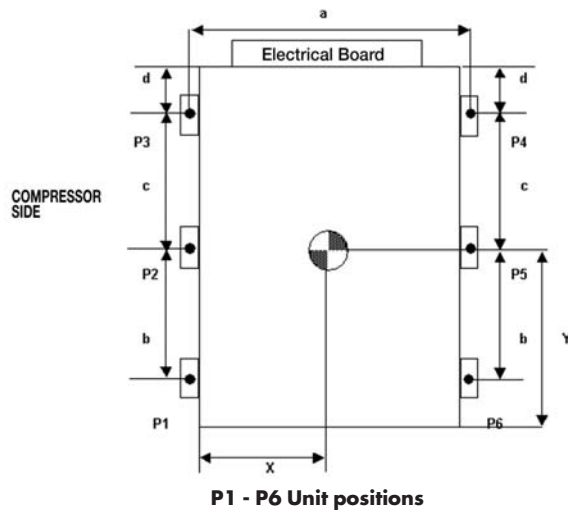

### VLH 704 - 1204 Al/Cu Standard Version

VLH Al/Cu	Distribution Weights (kg)						Operating Weights (kg)	Shipping Weights (kg)	P1-P6 POSITIONS				CENTRE OF GRAVITY POSITIONS	
	F1 (kg)	F2 (kg)	F3 (kg)	F4 (kg)	F5 (kg)	F6 (kg)			a (mm)*	b (mm)	c (mm)	d (mm)	x (mm)	y (mm)
<b>704 STD</b>	226	327	403	265	225	175	1620	1608	1137	1744	1744	250	460	2300
<b>804 STD</b>	243	351	434	285	242	189	1745	1731	1137	1744	1744	250	460	2300
<b>904 STD</b>	276	390	423	347	295	194	1925	1899	1137	1744	1744	250	460	2300
<b>1004 STD</b>	290	410	445	365	310	205	2025	1999	1137	1744	1744	250	460	2300
<b>1104 STD</b>	331	468	507	416	354	233	2310	2284	1137	1744	1744	250	470	2330
<b>1204 STD</b>	334	473	513	421	357	236	2335	2309	1137	1744	1744	250	470	2330

### VLH 704-1204 Al/Cu Low Noise Version

VLH Al/Cu	Distribution Weights (kg)						Operating Weights (kg)	Shipping Weights (kg)	P1-P6 POSITIONS				CENTRE OF GRAVITY POSITIONS	
	F1 (kg)	F2 (kg)	F3 (kg)	F4 (kg)	F5 (kg)	F6 (kg)			a (mm)*	b (mm)	c (mm)	d (mm)	x (mm)	y (mm)
<b>704 LN</b>	231	335	413	271	230	180	1660	1648	1137	1744	1744	250	460	2300
<b>804 LN</b>	249	359	444	292	248	193	1785	1771	1137	1744	1744	250	460	2300
<b>904 LN</b>	281	398	432	354	301	198	1965	1939	1137	1744	1744	250	460	2300
<b>1004 LN</b>	306	432	469	385	327	216	2135	2109	1137	1744	1744	250	460	2300
<b>1104 LN</b>	333	471	511	419	356	234	2325	2299	1137	1744	1744	250	470	2330
<b>1204 LN</b>	337	476	516	424	360	238	2350	2324	1137	1744	1744	250	470	2330

### VLH 604-1204 Al/Cu Extra Low Noise Version

VLH Al/Cu	Distribution Weights (kg)						Operating Weights (kg)	Shipping Weights (kg)	P1-P6 POSITIONS				CENTRE OF GRAVITY POSITIONS	
	F1 (kg)	F2 (kg)	F3 (kg)	F4 (kg)	F5 (kg)	F6 (kg)			a (mm)*	b (mm)	c (mm)	d (mm)	x (mm)	y (mm)
<b>604 ELN</b>	230	333	411	270	229	179	1650	1638	1137	1744	1744	250	485	2230
<b>704 ELN</b>	251	363	448	294	250	195	1800	1788	1137	1744	1744	250	485	2230
<b>804 ELN</b>	268	386	477	314	266	208	1920	1906	1137	1744	1744	250	485	2230
<b>904 ELN</b>	303	428	464	381	323	213	2112	2086	1137	1744	1744	250	485	2230
<b>1004 ELN</b>	318	449	488	400	340	225	2220	2194	1137	1744	1744	250	485	2230
<b>1104 ELN</b>	338	478	518	425	361	238	2360	2334	1137	1744	1744	250	470	2330
<b>1204 ELN</b>	342	483	524	430	365	241	2385	2359	1137	1744	1744	250	470	2330

\* Dimensions are referred to unit with antivibration mounted isolators.

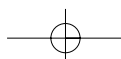

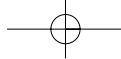

## Technical data

### VLH 704 - 1004 Al/Cu High Efficiency Version

VLH Al/Cu	Distribution Weights (kg)						Operating Weights (kg)	Shipping Weights (kg)	P1-P6 POSITIONS				CENTRE OF GRAVITY POSITIONS	
	F1 (kg)	F2 (kg)	F3 (kg)	F4 (kg)	F5 (kg)	F6 (kg)			a (mm)*	b (mm)	c (mm)	d (mm)	x (mm)	y (mm)
<b>704 HE</b>	244	353	436	286	243	189	1750	1738	1137	1744	1744	250	485	2230
<b>804 HE</b>	261	376	465	306	259	202	1870	1856	1137	1744	1744	250	485	2230
<b>904 HE</b>	295	417	453	372	316	208	2062	2036	1137	1744	1744	250	485	2230
<b>1004 HE</b>	311	439	477	391	332	220	2170	2144	1137	1744	1744	250	485	2230

### VLH 704 - 1204 Cu/Cu Standard Version

VLH Cu/Cu	Distribution Weights (kg)						Operating Weights (kg)	Shipping Weights (kg)	P1-P6 POSITIONS				CENTRE OF GRAVITY POSITIONS	
	F1 (kg)	F2 (kg)	F3 (kg)	F4 (kg)	F5 (kg)	F6 (kg)			a (mm)*	b (mm)	c (mm)	d (mm)	x (mm)	y (mm)
<b>704 STD</b>	245	354	437	287	244	190	1755	1743	1137	1744	1744	250	500	2250
<b>804 STD</b>	271	391	484	318	270	210	1945	1931	1137	1744	1744	250	500	2250
<b>904 STD</b>	304	430	467	383	325	214	2125	2099	1137	1744	1744	250	500	2250
<b>1004 STD</b>	344	486	527	433	367	243	2400	2374	1137	1744	1744	250	500	2250
<b>1104 STD</b>	390	552	599	491	417	275	2725	2699	1137	1744	1744	250	550	2250
<b>1204 STD</b>	394	557	604	496	421	278	2750	2724	1137	1744	1744	250	550	2250

### VLH 704-1204 Cu/Cu Low Noise Version

VLH Cu/Cu	Distribution Weights (kg)						Operating Weights (kg)	Shipping Weights (kg)	P1-P6 POSITIONS				CENTRE OF GRAVITY POSITIONS	
	F1 (kg)	F2 (kg)	F3 (kg)	F4 (kg)	F5 (kg)	F6 (kg)			a (mm)*	b (mm)	c (mm)	d (mm)	x (mm)	y (mm)
<b>704 LN</b>	250	362	447	293	249	194	1795	1783	1137	1744	1744	250	500	2250
<b>804 LN</b>	277	399	494	324	275	215	1985	1971	1137	1744	1744	250	500	2250
<b>904 LN</b>	310	438	476	390	331	218	2165	2139	1137	1744	1744	250	500	2250
<b>1004 LN</b>	349	494	536	440	374	247	2440	2414	1137	1744	1744	250	500	2250
<b>1104 LN</b>	392	555	602	494	419	276	2740	2714	1137	1744	1744	250	550	2250
<b>1204 LN</b>	396	560	608	498	423	280	2765	2739	1137	1744	1744	250	550	2250

### VLH 604-1204 Cu/Cu Extra Low Noise Version

VLH Cu/Cu	Distribution Weights (kg)						Operating Weights (kg)	Shipping Weights (kg)	P1-P6 POSITIONS				CENTRE OF GRAVITY POSITIONS	
	F1 (kg)	F2 (kg)	F3 (kg)	F4 (kg)	F5 (kg)	F6 (kg)			a (mm)*	b (mm)	c (mm)	d (mm)	x (mm)	y (mm)
<b>604 ELN</b>	262	379	468	307	261	203	1880	1868	1137	1744	1744	250	550	2250
<b>704 ELN</b>	282	407	503	330	280	219	2020	2008	1137	1744	1744	250	550	2250
<b>804 ELN</b>	310	447	553	364	309	241	2225	2211	1137	1744	1744	250	550	2250
<b>904 ELN</b>	360	509	553	453	385	254	2515	2489	1137	1744	1744	250	550	2250
<b>1004 ELN</b>	377	534	579	475	403	267	2635	2609	1137	1744	1744	250	550	2250
<b>1104 ELN</b>	397	562	610	500	425	280	2775	2749	1137	1744	1744	250	550	2250
<b>1204 ELN</b>	401	567	615	505	429	283	2800	2774	1137	1744	1744	250	550	2250

### VLH 704 - 1004 Cu/Cu High Efficiency Version

VLH Cu/Cu	Distribution Weights (kg)						Operating Weights (kg)	Shipping Weights (kg)	P1-P6 POSITIONS				CENTRE OF GRAVITY POSITIONS	
	F1 (kg)	F2 (kg)	F3 (kg)	F4 (kg)	F5 (kg)	F6 (kg)			a (mm)*	b (mm)	c (mm)	d (mm)	x (mm)	y (mm)
<b>704 HE</b>	275	397	490	322	273	213	1970	1958	1137	1744	1744	250	550	2250
<b>804 HE</b>	303	437	541	355	302	235	2175	2161	1137	1744	1744	250	550	2250
<b>904 HE</b>	353	499	542	444	377	248	2465	2439	1137	1744	1744	250	550	2250
<b>1004 HE</b>	370	523	568	466	396	262	2585	2559	1137	1744	1744	250	550	2250

\* Dimensions are referred to unit with antivibration mounted isolators.

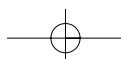

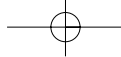

## Technical data

### 8.5 Overall dimensions

Units VLS 504-604 STD & VLS 504-554 LN  
VLH 504-604 STD & VLH 504-554 LN

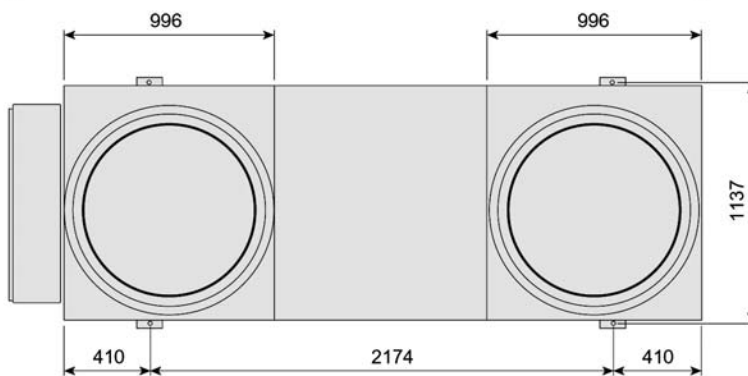
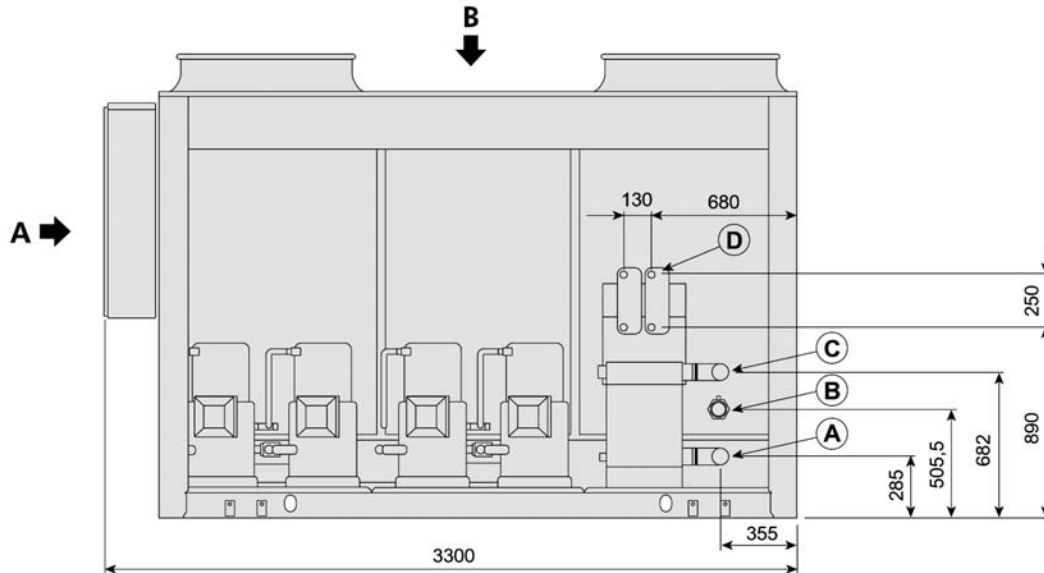

VIEW B

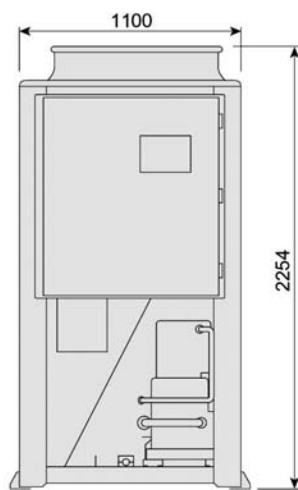

VIEW A

WATER CONNECTION	
WATER OUTLET "A"	2" 1/2 M
WATER INLET "B" (with pump)	2" 1/2 M
WATER INLET "C" (without pump)	2" 1/2 M
ESUPERHEATER IN/OUT "D"	4x1" F

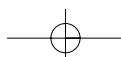

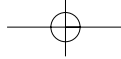

## Technical data

### Dimensions - Units VLS 504-604 HE/ELN & VLS 604 LN VLH 504-554 HE & VLH 604 LN/HE

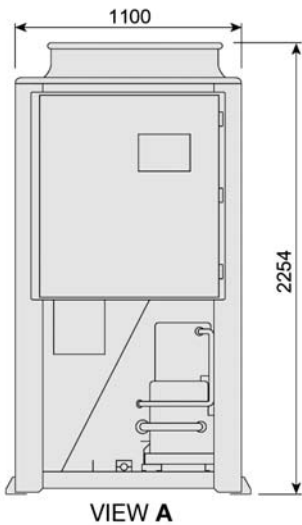
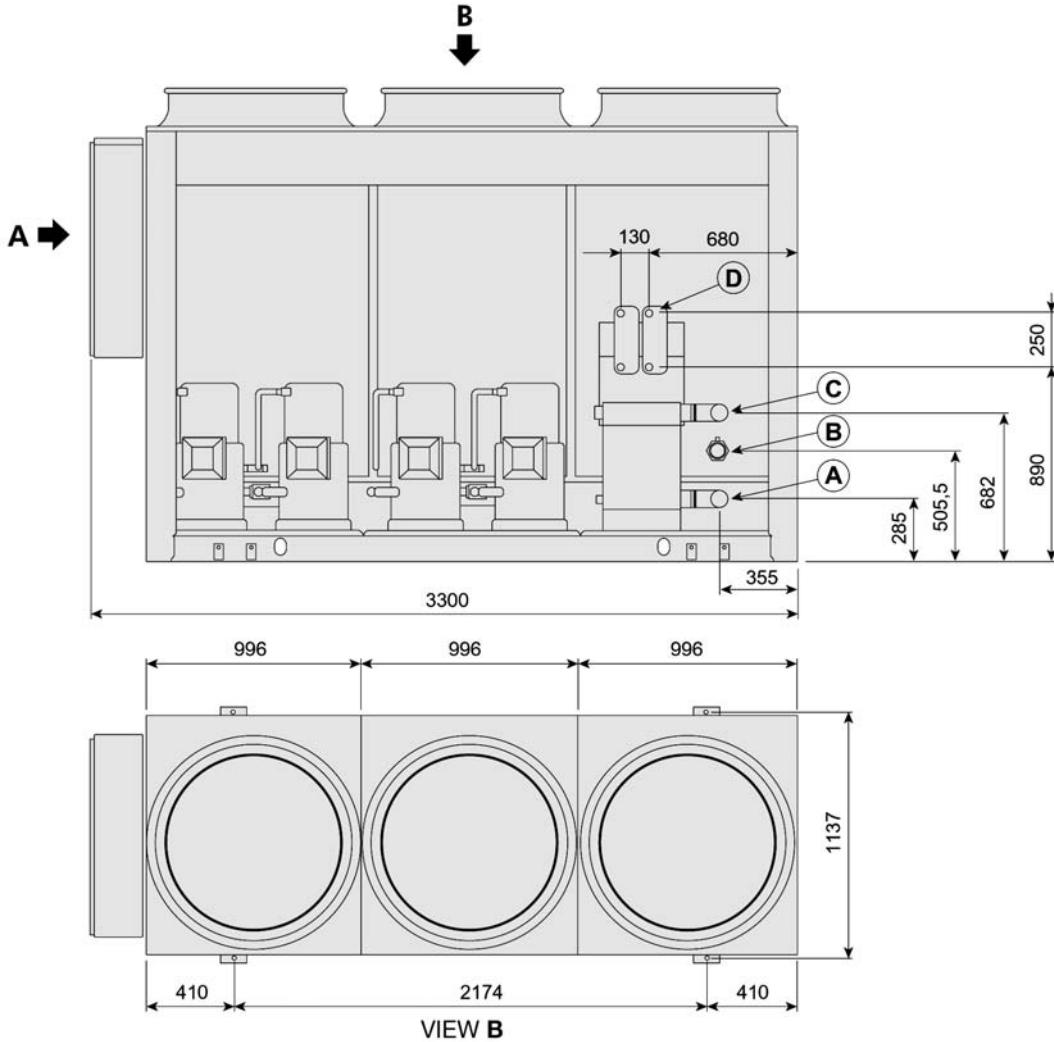

WATER CONNECTIONS	
WATER OUTLET "A"	2" 1/2 M
WATER INLET "B" (with pump)	2" 1/2 M
WATER INLET "C" (without pump)	2" 1/2 M
DESUPERHEATER IN/OUT "D"	4x1" F

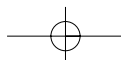



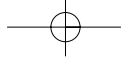

## Technical data

### Dimensions - Unit VLH 604 ELN

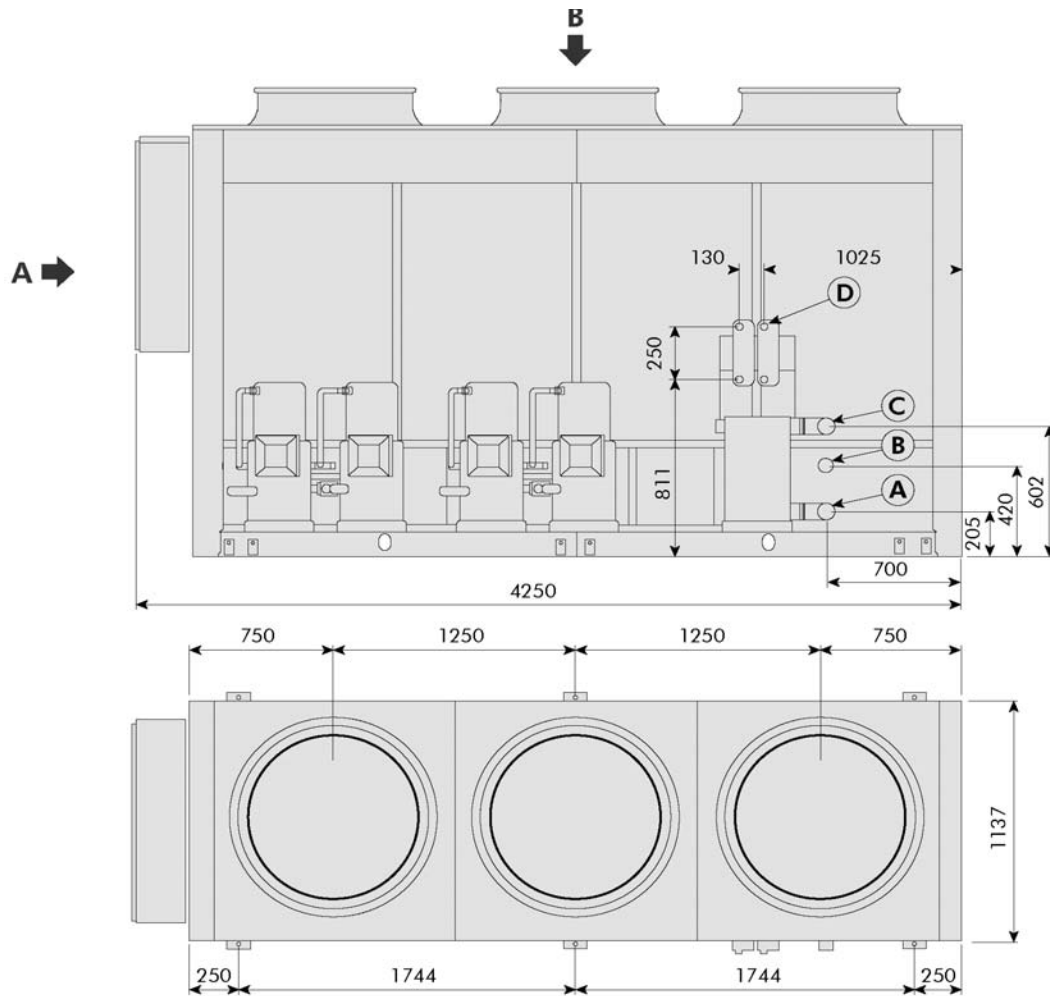

VIEW B

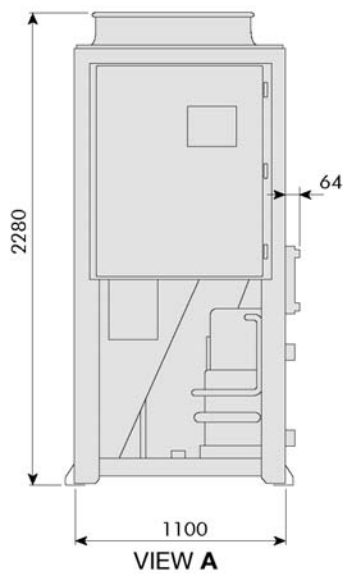

VIEW A

WATER CONNECTIONS	
WATER OUTLET "A"	2" 1/2 M
WATER INLET "B" (with pump)	2" 1/2 M
WATER INLET "C" (without pump)	2" 1/2 M
DESUPERHEATER IN/OUT "D"	4x1" F

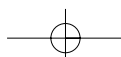

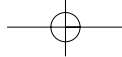

## Technical data

### Dimensions - Units VLS 704-804 STD/LN VLH 704-804 STD/LN

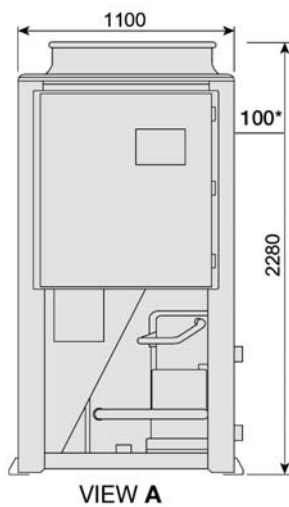
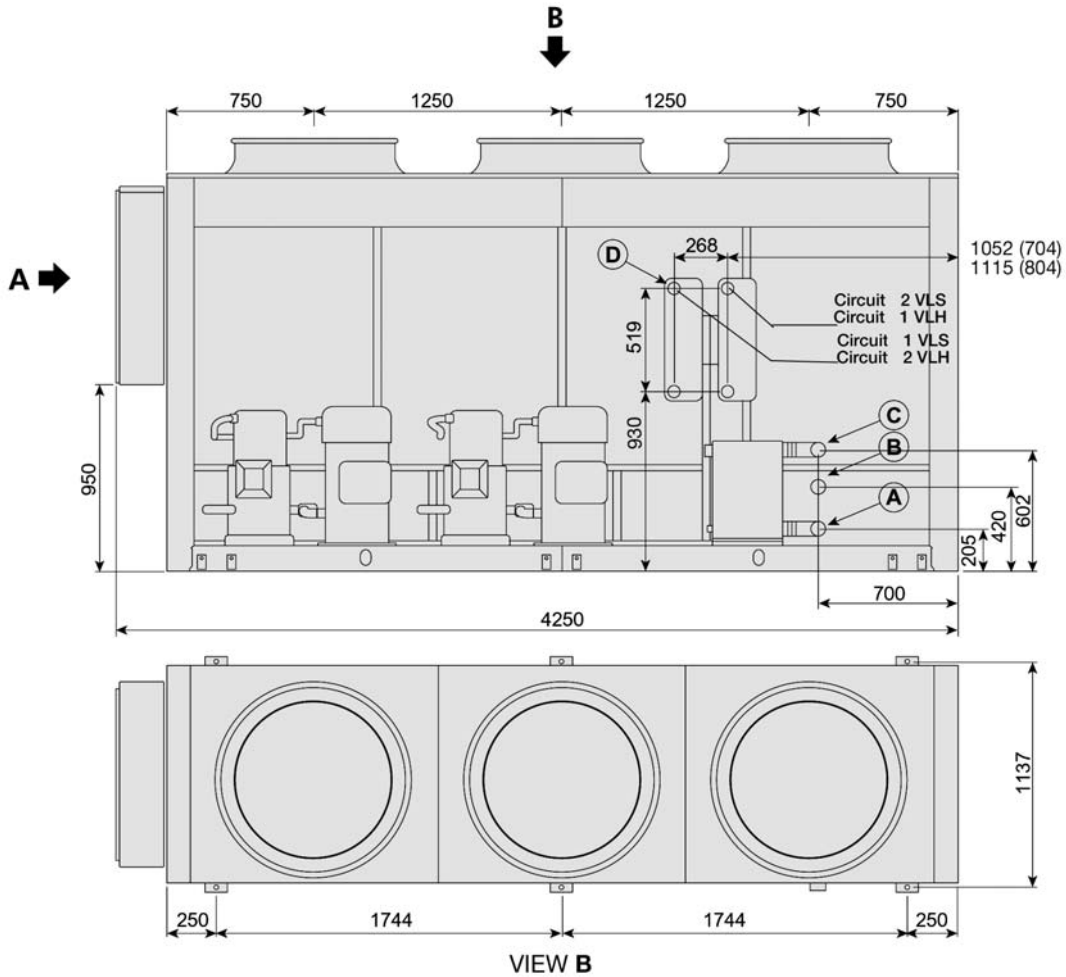

WATER CONNECTIONS	
WATER OUTLET "A"	2" 1/2 M
WATER INLET "B" (with pump)	2" 1/2 M
WATER INLET "C" (without pump)	2" 1/2 M
DESUPERHEATER IN/OUT "D"	4x2" F

(\* ) Measure with desuperheater.

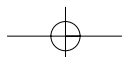

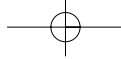

## Technical data

### Dimensions

Units VLS 704-804 HE/ELN & VLS 904-1004 STD/LN/HE/ELN & VLS 1 104-1204 STD/LN/ELN  
 VLH 704-804 HE/ELN & VLH 904-1004 STD/LN/HE/ELN & VLH 1 104-1204 STD/LN/ELN

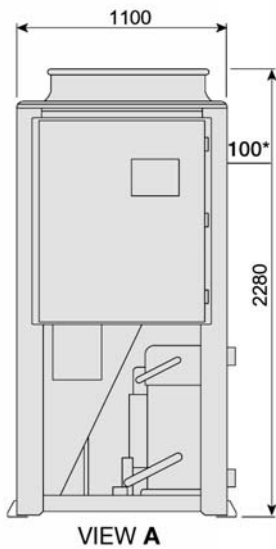
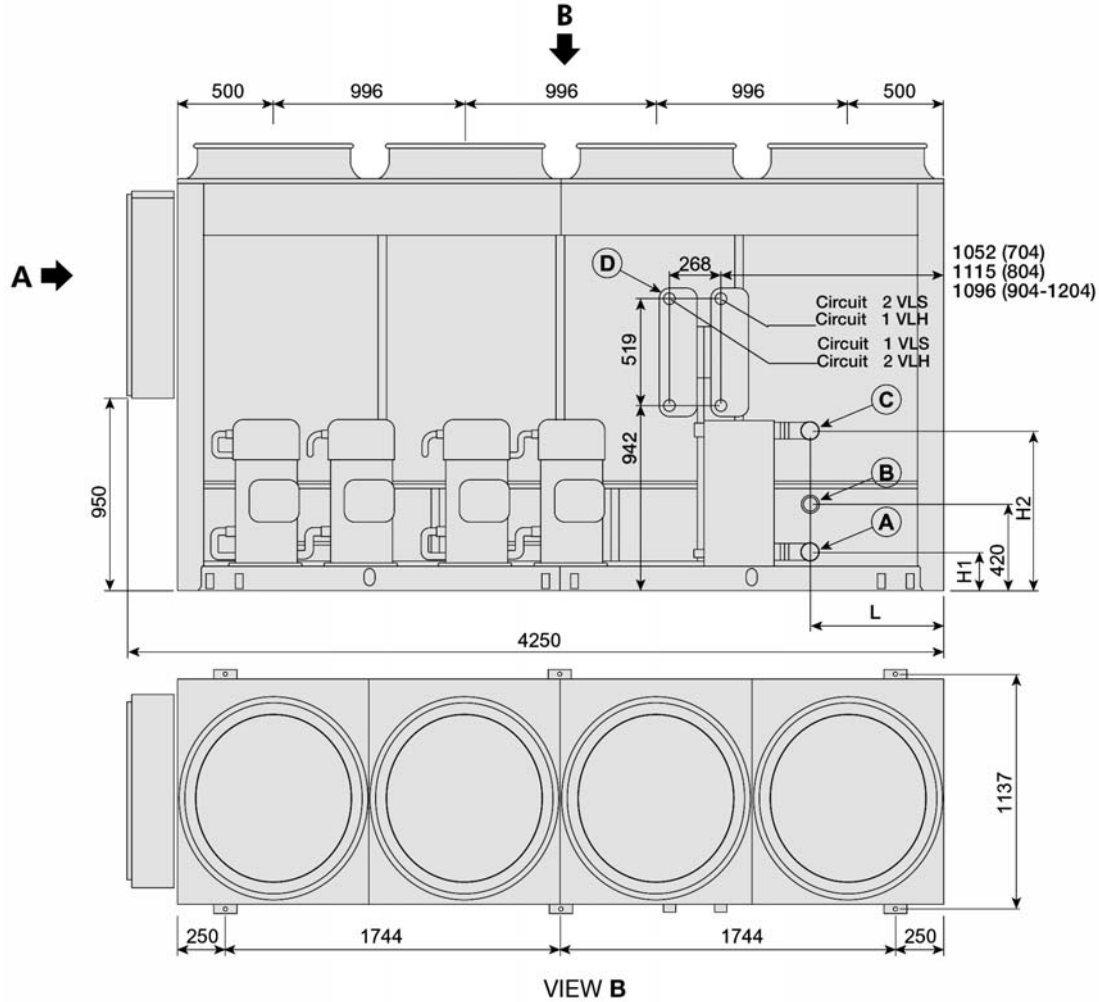

VIEW A

(\*) Measure with desuperheater.

Dimensions (mm)	704-804	904-1204
H1	205	213
H2	602	840
L	700	720

WATER CONNECTIONS	704-804	904-1204
WATER OUTLET "A"	2" 1/2 M	3" M
WATER INLET "B" (with pump)	2" 1/2 M	3" M
WATER INLET "C" (without pump)	2" 1/2 M	3" M
DESUPERHEATER IN/OUT "D"	4x2" F	4x2" F

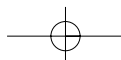

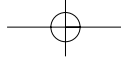

## Technical data

### Dimensions - Units VLC 504-554 STD/LN & VLC 604 STD

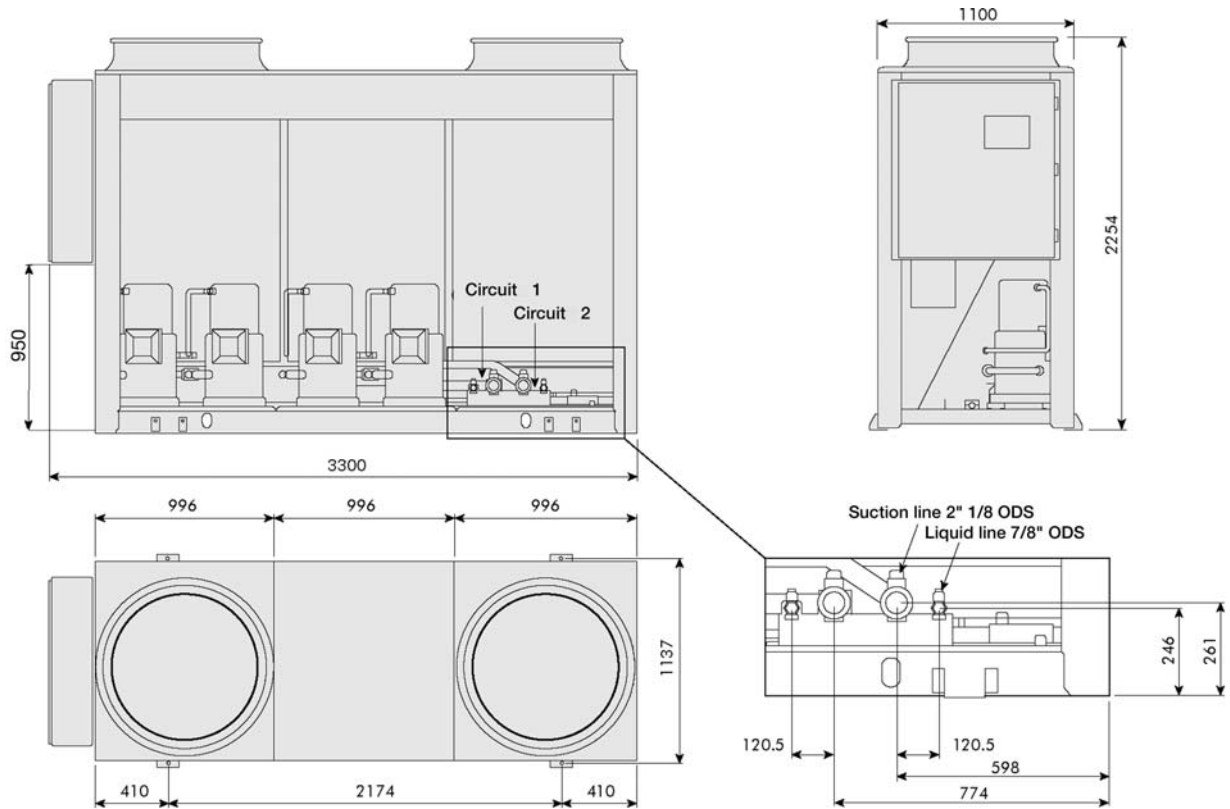

### Dimensions - Units VLC 504-554 ELN/HE & VLC 604 LN/ELN/HE

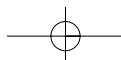
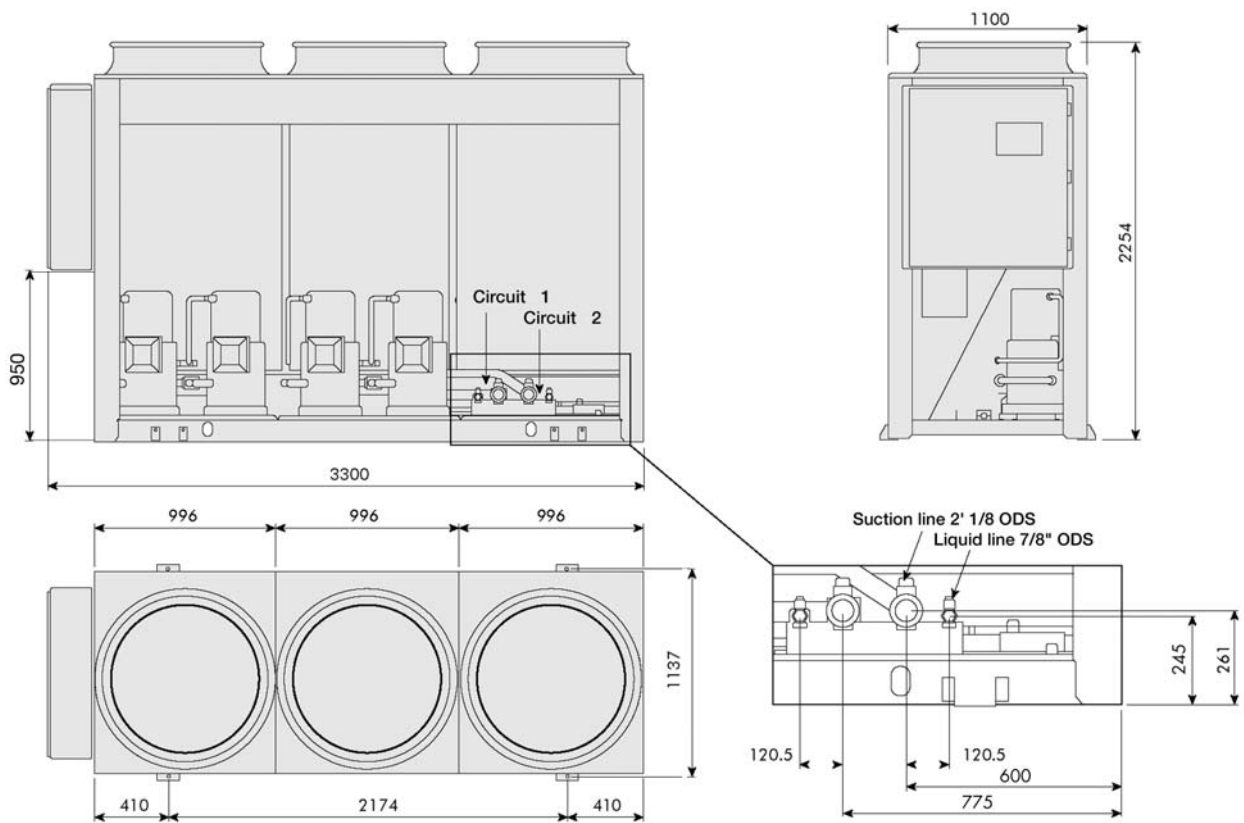

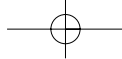

## Technical data

### Dimensions - Units VLC 704-804 STD/LN

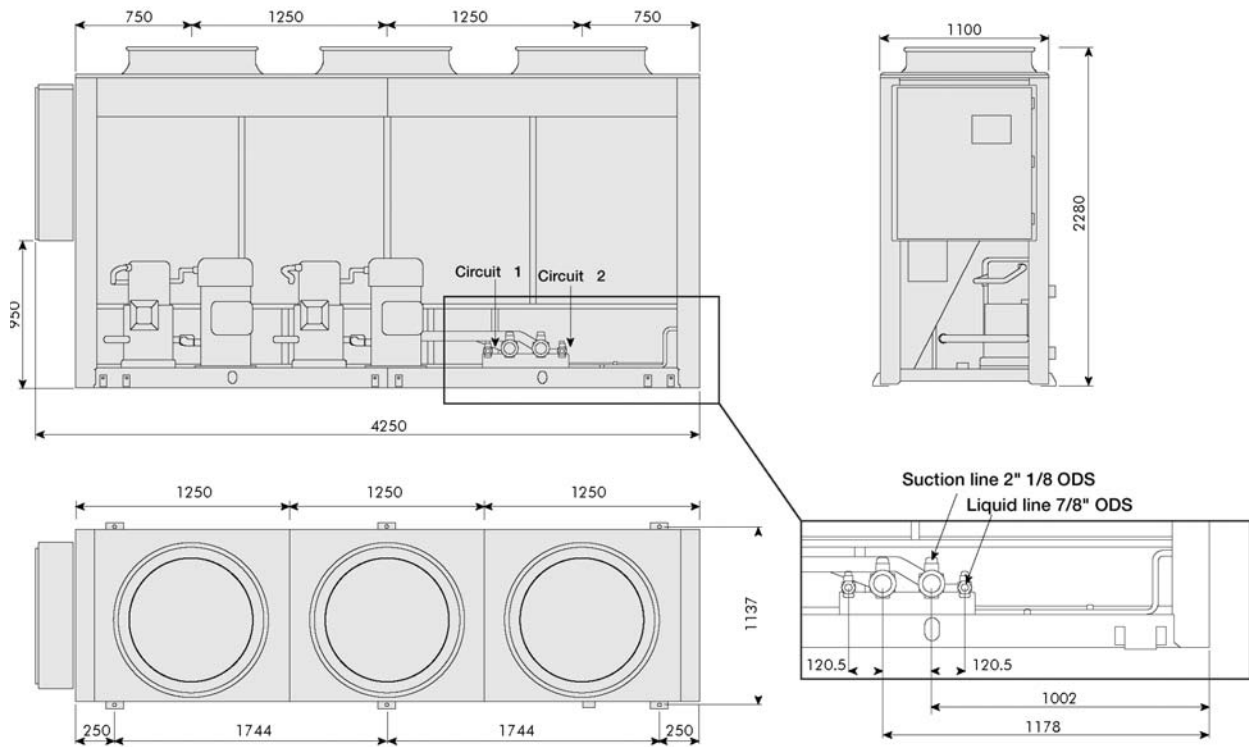

### Dimensions Units VLC 704-804 ELN/HE & VLC 904-1004 STD/LN/ELN/HE & VLC 1104-1204 STD/LN/ELN

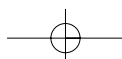
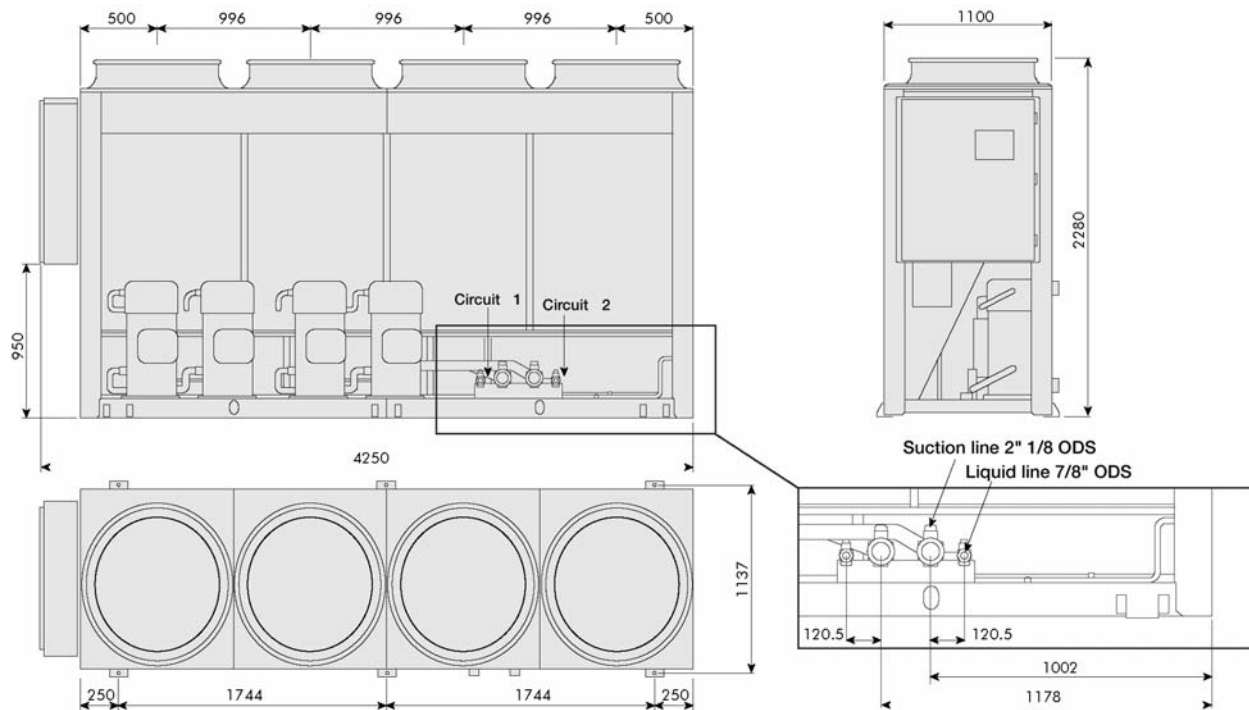

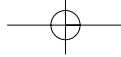

## Technical data

---

### Dimensions - Units with pumps VLS 504-604 STD/LN/ELN/HE VLH 504-604 STD/LN/HE

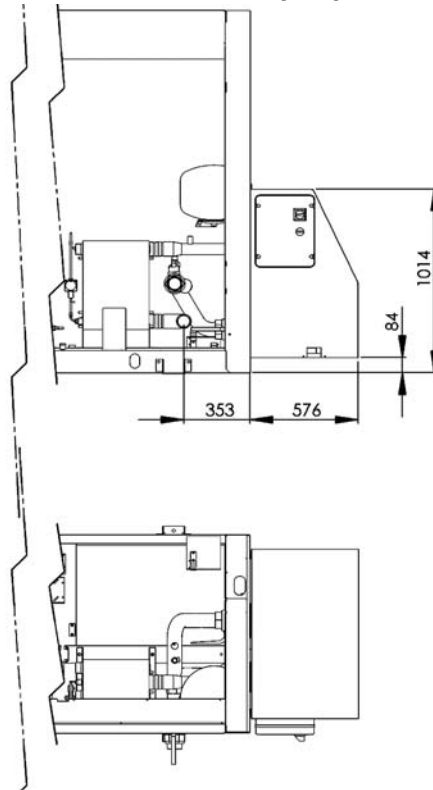

### Dimensions - Units with pumps VLS 704-1204 STD/LN/ELN & VLS 704-1004 HE VLH 604-1204 ELN & VLH 704-1204 STD/LN & VLH 704-1004 HE

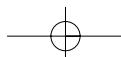
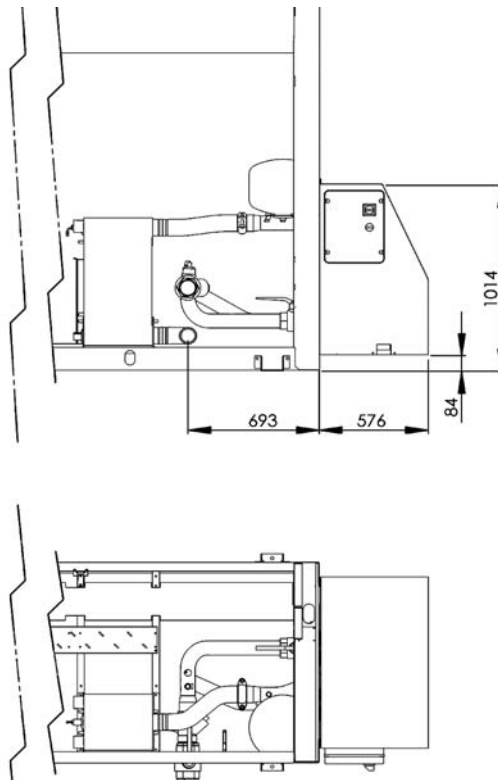

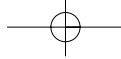

## Technical data

### 8.6 Service spaces

#### VLS/VLC/VLH All models

#### Installation of Single Units

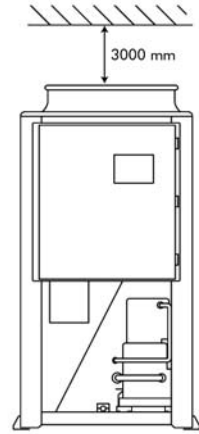
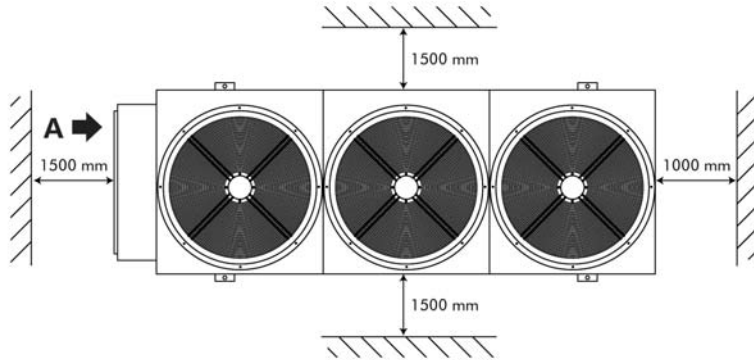

VIEW A

#### Installation of several Units

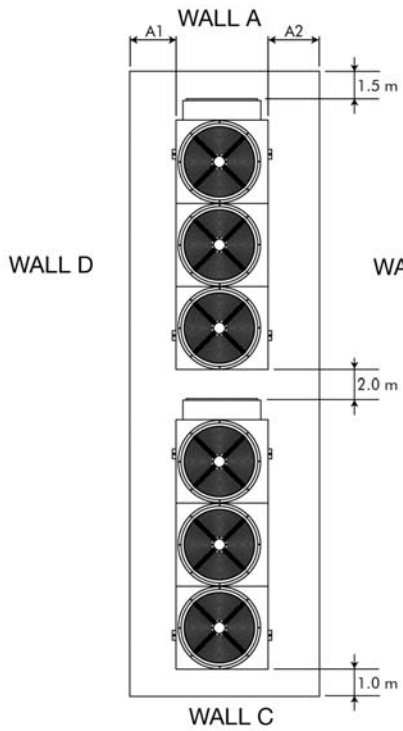

ARRANGEMENT 1

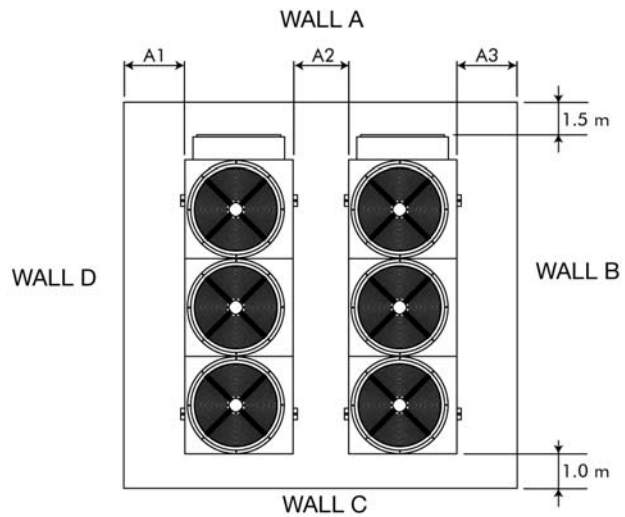

ARRANGEMENT 1

	A and C SCREENED B and D SOLID			A and B SOLID C and D SOLID			A and C SOLID B and D SCREENED			A and B SCREENED C and D SOLID			A and D SCREENED B and C SOLID		
	A1	A2	A3	A1	A2	A3	A1	A2	A3	A1	A2	A3	A1	A2	A3
Disposizione 1 (m)	1.5	1.5		1.5	1.5		1.0	1.0		1.5	1.0		1.0	1.5	
Disposizione 2 (m)	1.5	2.0	1.5	1.5	2.5	1.5	1.0	2.5	1.0	1.5	2.0	1.0	1.0	2.0	1.5

A wall only may be higher than the units.  
The area between the walls must be kept free from any obstacle which may hinder the free air inflow towards the unit(s).

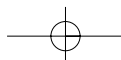

# Maintenance

## 9 MAINTENANCE

Carefully read the "Safety" section of this manual before carrying out any maintenance operations.



**Do not discharge the refrigerant into the atmosphere while the refrigeration circuits are being drained. Use appropriate recovery equipment. When the recovered refrigerant cannot be re-used, return it to the manufacturer.**



**Do not throw away the waste oil of the compressor, because it contains refrigerant in solution. The waste oil must be returned to the manufacturer.**

Unless otherwise specified, the operations described below may be carried out only by a trained maintenance operator.

### 9.1 General requirements

Itelco-Clima units have been designed for continuous operation, providing that they are subjected to regular maintenance, within the limits specified in this manual. Each unit must be serviced according to the programme by the User/Customer, and must be inspected at regular intervals by the personnel of one of Itelco-Clima's authorised Service Centers.

It is the responsibility of the User to meet these maintenance requirements and/or to enter into an agreement with one of Itelco-Clima's Service Centers, so as to properly safeguard the operation of the appliance.

During the warranty period, in case of damage or failures caused by improper maintenance, Itelco-Clima will not refund the costs incurred to repair the appliance in its original state.

The provisions of this section apply only to standard units; according to the order requirements, other documentation may be added, concerning any modifications or supplementary accessories.

### 9.2 Planned maintenance

Maintenance inspections must be carried out according to the program below, by a qualified person. As a general rule, units cannot be repaired directly by the user, who shall not try to service or repair any failures or anomalies identified during daily inspections. If you are in doubt, please contact Itelco-Clima Service Centre.

### Planned maintenance

Operations	Daily	Weekly	Monthly	Beginning of season	End of season
Check the temperature of the leaving fluid	●				
Check the pressure drops in the heat exchanger		●			
Check for electric absorption		●			
Check suction pressure and temperature		●			
Check delivery pressure and temperature		●			
Check the oil level in the compressor		●			
Check that there are no gas bubbles in the liquid line		●			
Check that the fins of the external coil are clean (if any)			●		
Check the operation of the oil heaters			●		
Check the remote control switches			●		
Check the operation of the LP pressure switch				●	
Check the operation of the HP pressure switch				●	
Check the insulation of the heat exchanger				●	
Check that terminals are tightened				●	
Check that the terminals' screws are tightened				●	
Clean the exterior of the unit with water and soap				●	
Check the density of the antifreeze (if any)				●	●
Check the operation of the flow switches				●	
Check the operation of the solenoid valve				●	●



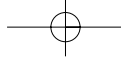

## Maintenance

### 9.3 Refrigerant charge



Do not inject refrigerant liquid into the LP side of the circuit. Be very careful, and charge the circuit properly. If the charge is insufficient, the efficiency of the unit will be lower than expected. In the worst of cases the LP pressure switch may be activated, resulting in the halting of the unit.

In the presence of an excess charge, the condensing pressure will rise (in the worst of cases, the HP pressure switch may be activated, resulting in the stop of the equipment), and the consumption will increase as well.



It is strictly forbidden to use the compressor as a vacuum pump to drain the plant.

Fill the refrigeration circuit after it has been drained for maintenance purposes (leaks, replacement of the compressor etc.). The amount of the charge is indicated on the plate affixed to the unit.

Before refilling, it is important to drain and de-hydrate the circuit, thus obtaining a minimum abs. pressure value of 50 Pa.

Inject the refrigerant fluid before removing the vacuum, then fill the circuit up to 90% of the total gas requirement (in liquid form). The appliance must be filled through the filling valve on the liquid line, on the outlet side of the condenser.

It is recommended to connect the refrigerant cylinder to the filling valve on the liquid line, and to arrange it in such a way as to inject only liquid refrigerant.

Then start the compressor and let the gas flow from the cylinder, up until the liquid flow, which can be observed through the sight glass, is limpid.

### 9.4 Compressor

Compressors are delivered with the necessary charge of lubricating oil. During normal operation, this charge is sufficient for the whole life of the unit, providing that the efficiency of the refrigeration circuit is satisfactory and if it has not been overhauled.

If the compressor needs to be replaced (following a mechanical failure or if burnt), contact one of Itelco-Clima's Service Centers.



Compressors use polyester oil, for both the versions manufactured for R134a and R407C. During maintenance operations on the compressor, or if you have to open the refrigerant circuit in any point, remember that this type of oil is highly hygroscopic, and accordingly it is important that it is not left exposed to the weather for prolonged periods, as this would require the replacement of the oil.

In a few cases, the polyester oil may be present also in R22 units (a refrigerant that can be used also in extra UE countries).

### 9.5 Condenser

The condenser's coils consist of copper pipes and aluminium fins. In the presence of leaks caused by any damage or shock, the coils shall be repaired or replaced by one of Itelco-Clima's authorised Service Centers. To ensure the effective and correct operation of the condenser coils, it is important to keep the condenser's surface perfectly clean, and to check that there is no foreign matter, such as leaves, wires, insects, waste etc. If the coil becomes dirty, there is an increase in the absorption of electric energy. Furthermore, the maximum pressure alarm may be activated and may halt the unit.



Be careful not to damage the aluminium fins during cleaning.

The condenser must be cleaned with a LP compressed air jet, parallel to the aluminium fins, in the direction opposite to the air circulation.

To clean the coil you can use also a vacuum cleaner, or a jet of water and soap.

### 9.6 Fans

The fans of the condenser, of axial type, are complete with impeller with aerodynamic profile blades and a cylindrical nozzle. The motor's bearings are lubricated forever.

Before starting the appliance, after any maintenance operations involving the disconnection of 3-phase connections, check that the direction of rotation of the fans is the one indicated by the arrow (upward air current). If the direction of rotation is wrong, invert two of the three supply phases to the motor.

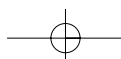

## Maintenance

### 9.7 Dehydrating filter

The refrigeration circuits are provided with dehydrating filters.

The filter clogging is marked by the presence of air bubbles in the sight glass, or by the difference between the temperatures measured downstream from and upstream of the drying filter. If, once the cartridge has been cleaned, there are still some air bubbles, the appliance has lost a part of the refrigerant charge in one or more points, that must be identified and serviced.

### 9.8 Sight glass

The sight glass is used for inspecting the refrigerant flow and the humidity % of the refrigerant. The presence of bubbles indicates that the dehydrating filter is clogged or the charge insufficient.

A colour indicator is positioned inside the sight glass. If you compare the colour of the indicator to the scale on the ring of the sight glass, you can calculate the percentage of humidity of the refrigerant. If it is excessive, replace the filter's cartridge, operate the appliance for 1 day and then check the humidity % again. When the humidity % is within the pre-determined range, no other operations are required. If the humidity % is still too high, replace the dehydrating filter again, start the unit and operate it for another day.

### 9.9 Thermostatic expansion valve

The circuit of the unit is equipped with a thermostatic expansion valve, with external equalizer  
The valve is shop-calibrated for an overheating of 5°C.

Procedure to check for overheating:

- Measure the suction pressure with the pressure gauges on the board of the unit or using a pressure gauge connected to the service valve on the suction side.
- From the pressure gauge's temperature scale, measure the saturated suction temperature (T<sub>sa</sub>) which corresponds to the pressure value.
- Using a contact pressure gauge affixed to the outlet fitting of the gas of the evaporator, measure the actual temperature (T<sub>se</sub>).

Overheating calculation (S):

$$S = T_{se} - T_{sa}$$

Overheating is regulated through the thermostatic expansion valve.

Make the adjusting screw follow a complete turn, and operate the appliance for five minutes.  
Check again and, if necessary, repeat the regulation.

If the expansion valve cannot be regulated, it is probably broken, and shall be replaced. The replacement must be carried out by a Service Centre.

### 9.10 Evaporator

Check at regular intervals that the water side of the heat exchanger is perfectly clean. To do this, measure the pressure drop, water side (see Section 8) or measure the temperature of the liquid leaving and entering the heat exchanger, and compare it to the evaporation temperature.

To obtain an effective heat exchange, the difference between the temperature of the leaving water and the saturated evaporating temperature must be in the 2 - 4°C range. A greater difference would indicate a low efficiency of the heat exchanger (i.e. the heat exchanger is dirty).

In this case, the heat exchanger must be subjected to chemical cleaning, an operation that shall be carried out by authorised engineers.

For other maintenance operations (extraordinary overhauling, replacement of the heat exchanger etc.), contact an authorised Service Centre.

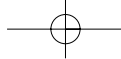

## Troubleshooting

### 10 TROUBLESHOOTING

The table below lists the anomalies of operation of the unit, the relevant causes and the corrective measures. For anomalies of any other type or not listed, contact one of Itelco-Clima's Service Centre for technical assistance.

Anomaly	Cause	Operation
The unit continues to work, but without cooling.	Insufficient charge of refrigerant.	Refill.
	The dehydrating filter is clogged.	Replace.
Ice on the suction line.	Wrong calibration of overheating.	Increase overheating.
		Check the charge.
Excessive noise.	Vibration of lines.	Check the clamping brackets, if any.
	Whistler emitted by the thermostatic expansion valve.	Refill.
		Check the dehydrating filter.
Noisy compressor.		Seized bearings; replace the compressor.
		Check that the compressor's locknuts are tightened.
Low oil level in the compressor.	One or more gas or oil leaks in the circuit.	Identify and remove leaks.
	Mechanical failure of the compressor.	Request the intervention of a Service Centre
	Anomaly of the oil heater of the compressor's base.	Check the electric circuit and the resistor of the heater of the motor base, and replace defective components.

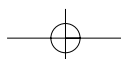

## Troubleshooting

Anomaly	Cause	Operation
One or both compressors are not working.	Breaking of the electric circuit.	Check the electric circuit and detect any ground dispersions and short circuits. Check fuses.
	Intervention of the HP pressure switch.	Reset the pressure switch and the control panel and restart the appliance. Identify and remove the cause that enabled the pressure switch.
	The fuse of the control circuit is broken.	Check for ground dispersions and short circuits. Replace fuses.
	Loosened terminals.	Check and tighten.
	Halt caused by thermal overload of the electric circuit.	Check the operation of check and safety devices. Identify and remove the cause.
	Wrong wiring.	Check wiring of check and safety devices.
	The line voltage is too low.	Check voltage. If problems regard the system, solve them. If they are caused by the distribution network, inform the Energy Distributor.
	Short-circuit of the compressor's motor.	Check the continuity of the winding.
	Seized compressor.	Replace the compressor.
Activation of the LP alarm, stop of the unit.	Gas leak.	Identify and remove the leak.
	Insufficient charge	Refill.
	Failure of the pressure switch.	Replace the pressure switch.
Activation of the HP alarm, stop of the unit.	Failure of the pressure switch.	Check the operation of the pressure switch, replace it if defective.
	The delivery valve is partially closed.	Open the valve and replace it, if faulty.
	Substances with condensable gases in the circuit.	Drain the circuit.
	The fan of the condenser is stopped.	Check cables and motor. If defective, repair or replace.
The liquid line is too hot.	Insufficient charge.	Identify and remove the cause of the loss of charge and refill.
Frosting of the liquid line.	The valve of the liquid line is partially closed.	Check that valves are open.
	The liquid filter is clogged.	Replace the cartridge or the filter.

## Spare parts

---

### 11 SPARE PARTS

#### 11.1 Spare part list

The table below shows the list of spare parts recommended during the first two years of operation.

Component	Number
HP pressure switch	1
LP pressure switch	1
Gas filter	2
Thermostatic valve	2
Auxiliary relays	2
Fan's fuses	6
Compressor's fuses	6
Auxiliary fuses	6
Set of compressor contactors	1
Fan's contactor	1
Water sensor	1
Air sensor	1
Electronic card	1
Keyboard	1
Compressor oil resistor	1

#### 11.2 Oil for compressors

The compressors are lubricated with polyester oil (P.O.E.).

#### 11.3 Wiring diagrams

The wiring diagrams are installed inside the doors of the electrical panels of the unit. Any request for wiring diagrams shall be forwarded to Itelco-Clima's Service Centre..

## Dismantling, Demolition and Scrapping

### 12 DISMANTLING, DEMOLITION AND SCRAPPING



**During the draining of the refrigeration circuits, do not let the refrigerant overflow in the surrounding atmosphere. The circuit must be drained using suitable recovery equipment.**



**Do not disperse the waste oil of the compressors in the environment, since it contains some dissolved refrigerant.**

**For the disposal, contact the competent authority for information.**

Unless otherwise specified, the maintenance operations listed below may be carried out by any trained maintenance operator.

#### 12.1 Generalities

Open each line that supplies the unit, including the ones of control circuits. Make sure that all disconnecting switches are secured in the off position. The power cables can be disconnected and disassembled. Refer to Chapter 4 for the position of connection points.

Remove all the refrigerant from the refrigeration circuits of the unit and store it in suitable containers, using a recovery unit. If its characteristics have remained the same, the refrigerant can be used again. Contact the competent authority to obtain information about disposal. In **NO** event shall the refrigerant be discharged into the atmosphere. The oil in each refrigeration circuit must be drained and collected into a suitable container; then it shall be disposed of in conformity with local regulations that apply to the disposal of waste lubricants. Any oil spillage must be recovered and disposed of in like manner.

Isolate the unit's heat exchangers from the external hydraulic circuits and drain the heat exchange sections of the plant.



**If no shutoff valves have been provided, it may be necessary to drain the whole plant. If a glycoled solution or a similar fluid has been used in the hydraulic circuits, or if chemical additives have been added to the circulating water, the circulating fluid MUST be drained in a proper way. For NO reason shall a circuit containing glycoled water or a similar solution be discharged directly into the drains or surface waters.**

After draining operations, the piping of the hydraulic networks can be disconnected and disassembled.

Once they have been disconnected as specified, the packaged units can be disassembled in a single piece. First of all, disassemble the anchoring screws and then lift the unit from the position of installation, and hook it to the lifting points provided, using suitable lifting equipment.

To this end, refer to Chapter 4 for the installation of these appliances, to Chapter 8 for their weights and Chapter 3 for handling.

The units that, once disconnected, cannot be removed in a single piece, must be dismantled on site; in this case, be very careful with the weight and handling of every single component.

It is always advisable to dismantle the units following the installation steps, but in reverse.



**Some residues of oil, glycoled water or similar solutions may remain in certain parts of the unit. These residues must be recovered and disposed of according to the procedures specified above.**

It is very important to ensure that, while a component of the unit is being removed, all the others are properly supported.



**Use only lifting means of adequate capacity.**

Once disassembled, the components of the unit can be disposed of in conformity with current regulations.



**Itelco Industry**

Via XXV Aprile, 29  
20030 Barlassina (MI) - Italy

☎ : +39 0362 6801

☎ : +39 0362 680281

[www.itelco-clima.com](http://www.itelco-clima.com)

---

*As part of our ongoing product improvement programme, our products are subject to change without prior notice. Non contractual photos.*

Your distributor :

