

## ▶ Rooftop - Cooling Only or Heat Pump

# RT4D

## 20 to 380



16.2 to 207.8 kW



13.1 to 166.8 kW



### Engineering Data Manual

EDM RT4D-W.1GB

Date : April 2007

Supersedes : None

# Technical Features

---

## General

---

- The RT4D is a pre-assembled weatherproof single package, designed to save energy with long life durability.
- The RT4D is an air to air double flow heat-pump combined with 2 blowers and 4 dampers.
- The quantities of return-, exhaust- and outdoor air are managed by the 4 dampers to provide comfort and efficiency.
- 10 sizes are available, from 15 to 200 kW cooling capacity handling up to 40 000 m<sup>3</sup>/h air volume.
- The RT4D will satisfy commercial and industrial applications with high ventilation requirements. It is built with a double wall cabinet made of aluminum and 50 mm insulation, which provides the best thermal and acoustical protection and prevent the insulation fibers from entering the building. It is cleanable from harmful bacteria build-up to protect the air supplied to the building from contaminants.
- More applied features such as, frequency-inverters on blowers, modulation using inverter on one compressor, plug fans with EC motors, high efficiency filtration (bag filters F7), additional heaters (electric, hot water coil or gas), communication (ModBus or LON talk) are available. For high summer outdoor temperatures, option with R134a is available. Design permits an installation inside the building. A full run test is performed at the factory before the shipment to save time at the job site and ease the commissioning. It will insure that the RT4D operates correctly.

## Cabinet

---

The RT4D is compact and made of ALUMINIUM to reduce the weight and prevent the cabinet from corrosion.

- The cabinet is watertight and airtight.
- It is designed for roof mounted- and indoor applications.
- The double wall in the air handling section eases cleaning and prevents from insulation damaging.
- The 50 mm insulation reduces the energy loss and the sound dispersion.
- The glass wool MO insulation is CE certified.
- All metal-to-metal removable surfaces, exposed to the weather, are sealed with closed cell neoprene gaskets.
- When RT4D is higher than 1.7 m (above size 100), the doors are hinged with a wind clamp to hold the door open.
- The doors are equipped with ¼ turn rotor locking fasteners to ensure a perfect air- and water-tightness.
- The hinges and "rotor" fasteners are made of non corrosive polyamide material.
- The hinged doors are earthed to the cabinet.
- Handles to open the rotor fastener are available.
- A 3 mm heavy gauge galvanized steel single base rail insures a high structural rigidity.
- The 4 lifting points of the base rail prevent from deflection during rigging.
- The base rail is designed to fit the optional roof mounting curb or any other field supplied supporting construction.

## Technical Section

---

- The compressors, most refrigeration-, electrical- and control devices are located in a weatherproof technical compartment divided from the airflow. The RT4D can be serviced without interfering to its operation.
- The control and electrical board is guarded by a independent hinged door.
- The compartment is insulated to reduce the noise disturbance of the compressors to the environment.
- The cables and wires are protected by flexible conduits.



## Refrigeration System

---

The RT4D is designed to satisfy applications with hygienic ventilation (fresh air) requirements. The thermodynamic process recovers the energy from air volume leaving the building (exhaust air).

- Tandem of two scroll compressors increases the seasonal efficiency (SEER) on part-load operation.
- The scroll compressors have higher efficiency, lesser vibration and better resistance to eventual slugging.
- Flexible conduits are placed on the discharge- and suction lines of the compressor to eliminate vibration transfer.
- All compressors have a crankcase heater (Rc1, Rc2) to insure a safe start up in winter and overload protection (OLC1, OLC2).
- Each circuit is equipped with one 4 way reversing valve (VH1).
- The reversible system has two thermostatic expansion valves per circuit (Tz1, Tz2), each valve is equipped with a by-pass and a check-valve (VR1, VR2).
- Each circuit is furnished with filter dryer, sight glass.
- Two glass manometers (MHP, MBP) for high and low pressures are placed on the outside of the casing.
- One suction accumulator (SL), protects the compressor from flooding on defrost cycle.
- One liquid receiver (RV) in the liquid line regulates the fluctuating refrigerant flow to the compressor.
- The outdoor coil (BCO) is divided in two vertical coils, V-formed, when the RT4Ds has two circuits. This unique feature eases the defrost of one circuit without disturbing the heating of the other circuit.
- There is one drain pan under both outdoor coils.

# Technical Features (continued)

- The drain pan is equipped with an electric heater (RE) to melt the ice during the defrost cycle.
- One refrigerant pressure transducer (TPH) monitors the pressure in the outdoor coil (on heating and cooling mode). It opens (or closes) the auxiliary outdoor air dampers (D4) to allow more (or less) outdoor air to mix with the exhaust air before the outdoor coil. This function insures a safe and efficient operation of the heat-pump.
- The indoor coil (BEV) allows for high dehumidification on cooling mode.
- The drain pan under the indoor coil is with positive slope, removable for hygienic cleaning.
- Most brazing, fittings and refrigerant devices are assembled in the technical compartment to ease service without disturbing the operation of the RT4D.
- Each refrigerant circuit is equipped with 3 pressure switches to protect the machine :
  - High pressure switch with automatic reset (pre-alarm),
  - High pressure switch with manual reset,
  - Low pressure switch with manual reset.
- On very hot summer days, the tandem Compressors avoids a total cooling cut-out. A refrigerant high-pressure safety valve (SV) is located on the liquid receiver.
- One compressor can be equipped with optional inverter (to be used with reciprocating compressor) to modulate the heating or cooling capacity from sizes 20 to 180.
- A G4 air filter protects the outdoor-coil.

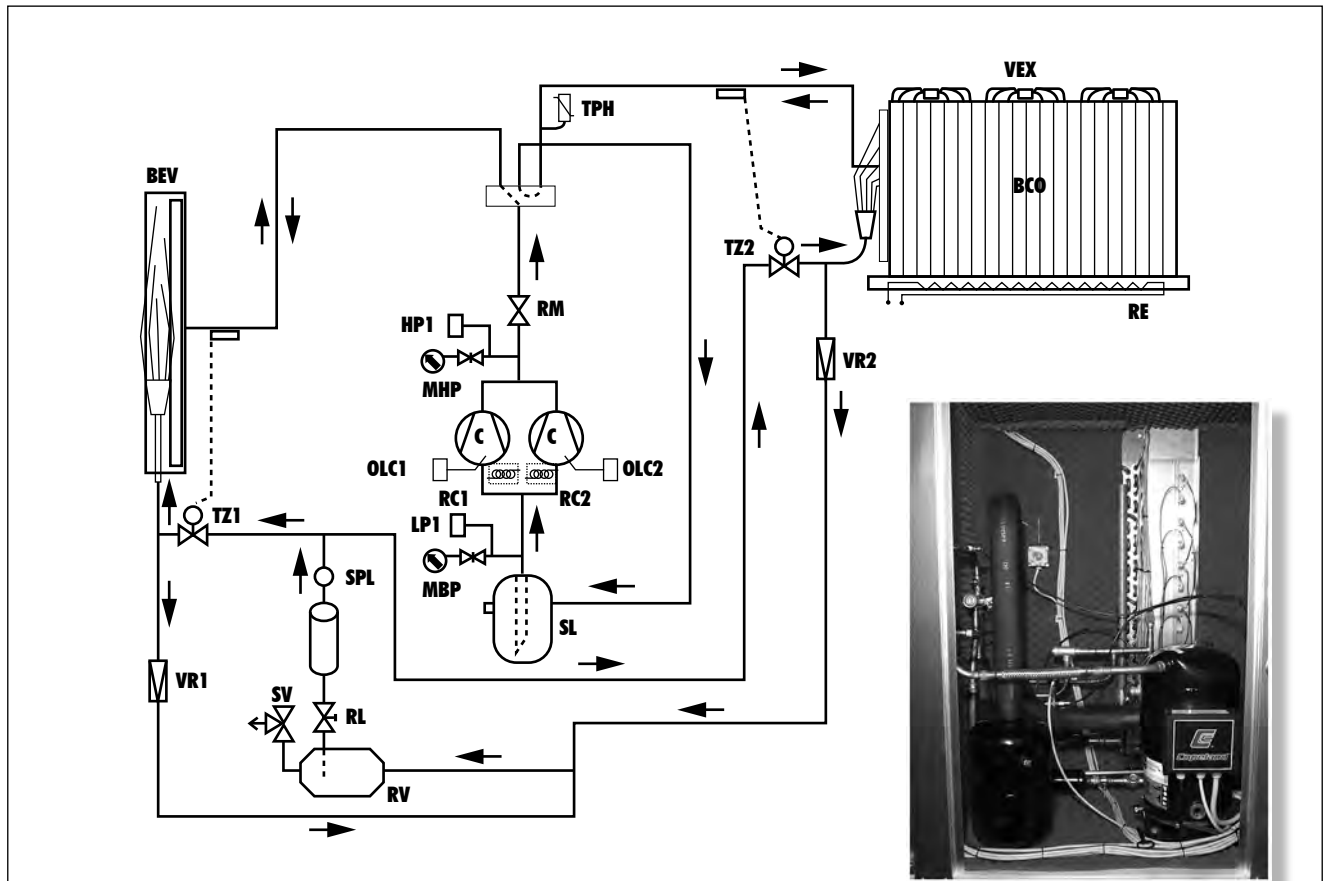

<b>C</b>	Scroll compressor	<b>SL</b>	Liquid separator in the suction line	<b>SPL</b>	Sight glass
<b>OLC1-OLC2</b>	Overload thermal protection	<b>VH1</b>	Four way valve for reverse cycle	<b>SV</b>	Refrigerant safety valve
<b>RC1-RC2</b>	Crankcase heater	<b>TPH</b>	Pressure transducer 4-20 ma/0-30 bar	<b>BEV</b>	Indoor coil
<b>LP1</b>	Low pressure switch	<b>TZ1-TZ2</b>	Dry expansion thermostatic valves	<b>VEX</b>	Outdoor axial fans
<b>HP1</b>	High pressure switch	<b>VR1-VR2</b>	Refrigerant check valves	<b>BCO</b>	Outdoor coil
<b>MBP</b>	Low pressure manometer	<b>RV</b>	Liquid receiver	<b>RE</b>	Electric heater for outdoor drain pan
<b>MHP</b>	High pressure manometer	<b>RL</b>	Liquid line check valve		
<b>RM</b>	Discharge line check valve	<b>FE</b>	Drier liquid filter		

# Technical Features (continued)

## Speed Defrost

In heating mode, particular attention has been given to shorten the time of defrost and reduce the un-comfort in the building and improve the overall efficiency. With two circuits, the RT4D allows one circuit at a time to defrost.

The unique design of the outdoor coil split in two vertical coils, placed side by side in a V-configuration, ease the defrost of one circuit without interfering with the heating of the other circuit. The exhaust fans of the 2-circuits RT4D, are divided in two sections with distinct air flows, so that each outdoor coil operates independently from the other.

## Four Damper Section

One blower extracts air through the outdoor coil to recover the energy leaving the building.

The air leaving the building is colder than the outdoor air in summer and warmer in winter. The air leaving the building is used to lower the condensation temperature in the outdoor coil in summer and higher the evaporating temperature in winter.

The energy recovered from the building improves the year-round efficiency of the heat-pump.

The second blower supplies the treated air to the building.

The RT4D is equipped with 4 air dampers (D1, D2, D3 and D4) designed to handle up to 100% of the nominal air volume.

Fresh air and exhaust air dampers (D2, D3) are mounted in the opposite way and will open or close to permit enough air to the outdoor coil .

The danger of uncomfortable over (or under) pressure in the building is eliminated. This feature insures real energy saving while controlling at the same time the air changes within the building.

- Each one of the 4 counteracting dampers is driven by one actuator. All of them are connected to the controller.
- The damper blades are made of aluminum profile to avoid corrosion. The blades are geared together to improve the transmission from the actuator.
- The two dampers in the outdoor air (D3 and D4) are hinged. They can be turned opened on one axis to ease the access to the inside of the RT4D.

- The economizer benefits from the 2 dampers D1 and D4, to utilize the greatest possible quantity of outdoor air (for free-cooling or free-heating ) without over pressurizing the building.
- The economizer improves the unit efficiency on cooling and heating.
- The sensible economizer is standard. It compares the outdoor air temperature to a reference ambient temperature setting.
- The outdoor air sensor is factory fitted and the discharge air sensor is field installed (in the supply air duct).
- The enthalpy economizer is an option. It compares the enthalpy of the outdoor-air to a reference setting. Undesired humidity will be detected before it enters the building.
- The night-free-cooling, to pre-cool the building at low cost during cooler Summer nights (when the outdoor air temperature is lower than the room setting on un-occupied mode) is optional.
- The minimum position of the outdoor air damper (D3) which serves the hygienic ventilation of the building, is adjustable at the controller.
- The ambient air quality control (VOC) traces high population densities in the building and provides sufficient new fresh air to the occupants. The quality controller is optional. It is not available with enthalpy economizer.
- Dampers D3 and D4 are closed on :
  - OFF periods to eliminate unwanted outdoor air.
  - Morning warm-up or start-up until the set-ambient temperature is satisfied.
  - Night-set-back modes, to save heating energy.
- The smoke detector is located downstream of the filter. This feature is optional.

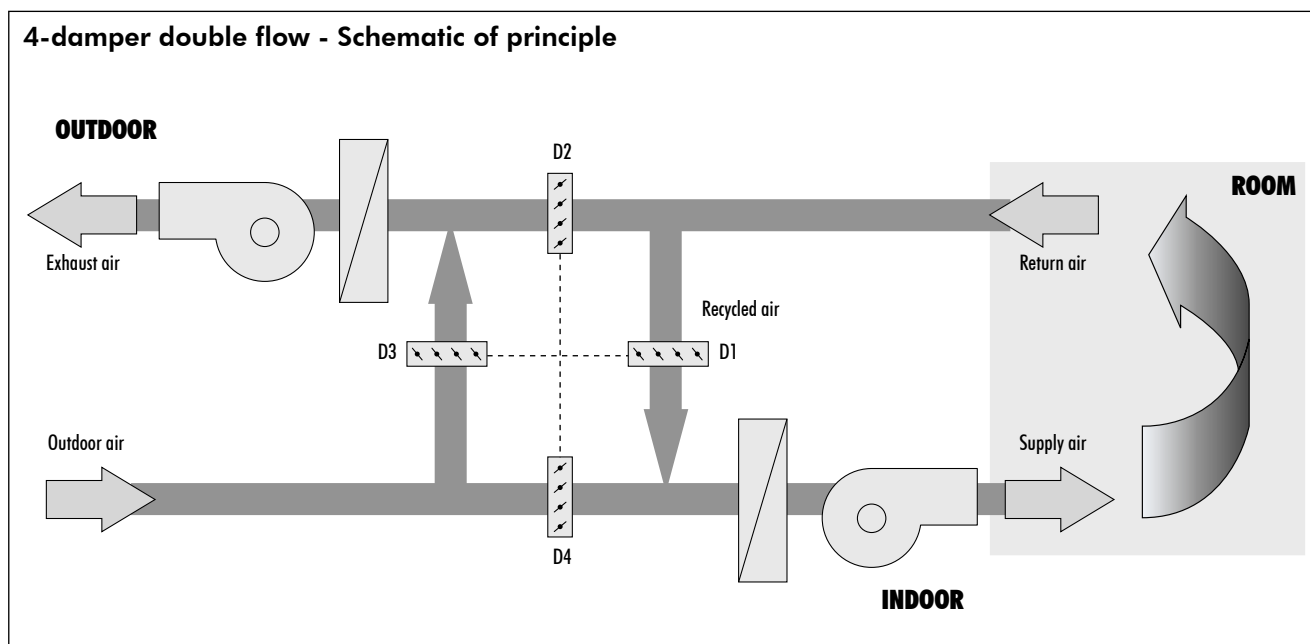

## Technical Features (continued)

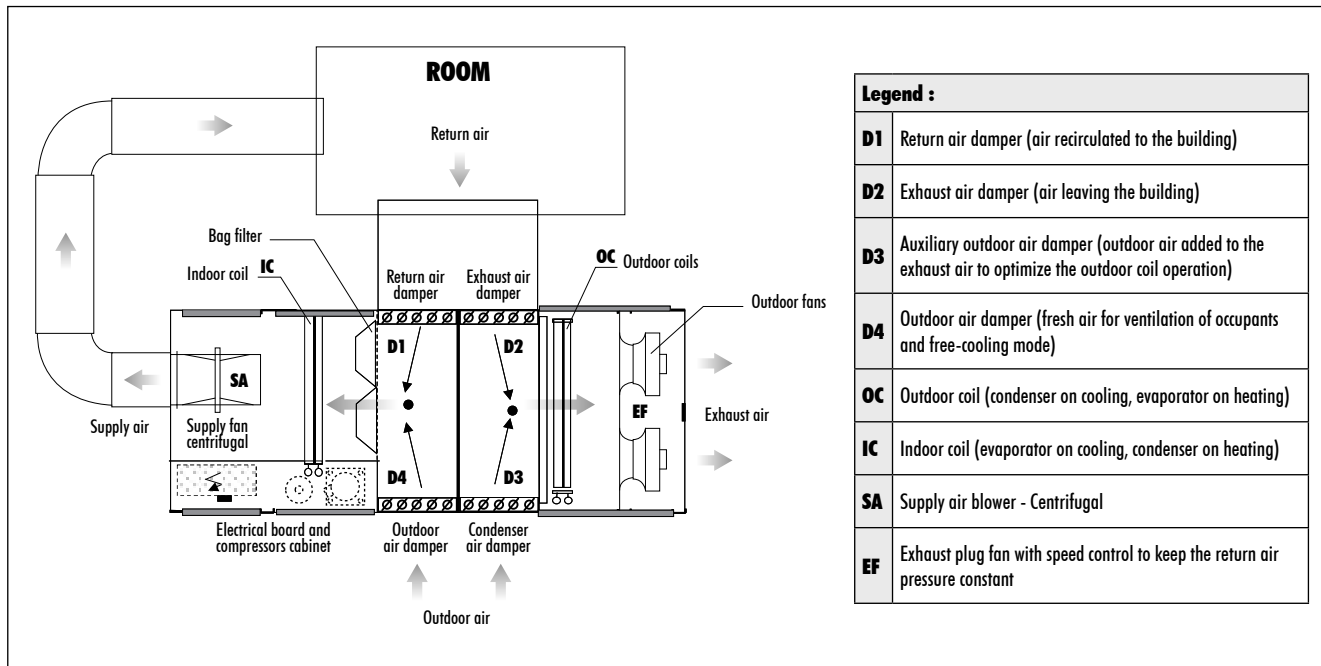

### Blowers and Drives

The double flow is accomplished by two blowers.

A unique constant pressure control in the return air duct, keeps the volume of air returning from the building to the RT4D constant. The specially designed software eliminates the uncomfortable under-and over pressure periods in the building, by reducing- or increasing the speed of the exhaust blower, when the 4 dampers are changing their position.

- Up to 4000 m<sup>3</sup>/h, the supply air blower is centrifugal belt driven forward curved type (sizes 20 and 40).
- Up to 40 000 m<sup>3</sup>/h, the supply air blower is centrifugal belt driven backward curved type with reinforced frame.
- Sizes 280 and 380 have two parallel centrifugal belt driven blowers in the supply air.
- Single speed motors with adjustable pitch pulleys are standard.
- Variable air volume (VAV) with variable frequency drive on the supply air blower motor is optional.
- The motors are mounted on an independent platform with adjusting spanner screw, to ease alignment and belt tension.
- The motor and the belt-driven pulleys are guarded from injuries by a perforated aluminum shield.
- The blowers are isolated and connected to the casing with flexible sleeves to eliminate vibration transfer to the cabinet.
- An air pressure switch communicates with the controller and monitors the presence of the supply air flow.
- The exhaust air blower is made of one- or several high performance radial direct driven plug fan(s).

- The exhaust air blower is equipped with a speed controller as standard.
- One return air pressure transducer controls the pressure in the return air duct. This unique feature keeps the return air pressure constant by modulating the speed of the exhaust blower. The RT4D keeps the air volume returning from the building to the RT4D constant, while the position of the air dampers are changing.
- A perforated aluminum guard at the exhaust air protects from injury.

### Air Flow Arrangements

- A choice of 6 air connections is available on the RT4D.
- The supply- and the return air connections can be downward, upward, or horizontal.

### Air Filters

- The air filters are mounted on sliding rails.
- The access to the filter is possible through one door with ¼ turn rotor lock fastener.
- The optional main filter is a F7 (bag filter) protected by a G4 pre-filter, compliant with EN 779.
- The outdoor coil is protected by a G4 filter.
- The quality of the filter is monitored by a clogged filter switch communicating with the controller.
- The length of the optional bag filter is 292 mm from sizes 20 to 140; 560 mm from sizes 180 to 380.

# Optional Features

## Hot Water Heat

- Hot water heat is an option, factory mounted down-stream of the indoor coil.
- The coil covers the entire surface of the indoor coil with low air velocity to reduce the blower energy consumption and the noise level. The coil is protected by a freeze stat.
- A factory fitted 3-way valve communicates with the controller. The valve is optional.
- A circulating pump (antifreeze) is optional with by-pass and check valve.
- The capillary freeze-stat is factory fitted. On danger of freezing, the blowers stops, the outdoor damper closes, the valve opens.

## Electric Heat

- Electric heaters are optional and factory mounted down stream of the indoor coil.
- The heater covers the entire surface of the indoor coil reducing the pressure drop.
- Electric heaters are made of smooth steel coils.
- 2 stage heat is standard. 3 stage heat is an option.
- A safety thermostat with manual reset senses the surface temperature of the heating elements to protect the elements from overheating. It switches the electric heater off, when the heater surface rises above 110 °C.

## Gas Heat

The RT4D offers an interesting energy alternative with the combination of, a gas heater and the air to air heat-pump.

The gas heater is located down stream of the blower insuring a safe over pressure around the heat exchanger.

- The tubular heat exchanger is made of stainless steel to insure an extensive durability.
- The tubular heat exchanger increases the surface exposed to the air flow and the heat transfer.
- The flue-gas collector and the flue exhaust pipe are made of stainless steel to be resistant to corrosion.
- The atmospheric burners are not influenced by any outdoor weather conditions.
- The burner is standard 2 stages heat. The modulation of the burner is optional.
- The ignition of the burner and the protection of the flame sensor are automatic.
- The gas control valve shuts down the burner on faulty ignition, low gas pressure, lack of combustion air.
- The overheating capillary thermostat is diligently located near the gas heater. It stops the burner on overheating and keeps the blower operating until the heat exchanger is free of heat.
- The gas pressure regulator ensures that a constant gas pressure enters the burner when the main gas pressure fluctuates.
- The gas heater has a CE Certification.

## Roof Mounting Curb

- The roof mounting curb is optional. The curb is shipped knocked-down for field assembling.
- The curb is made of 3.0 mm heavy gauge galvanized steel and is 400 mm high.
- A self adhesive gasket between the perimeter of the curb and the RT4D is supplied. It stops vibration transfer and thermal bridging.
- The insulation and the flashing of the curb to the roof are field furnished.

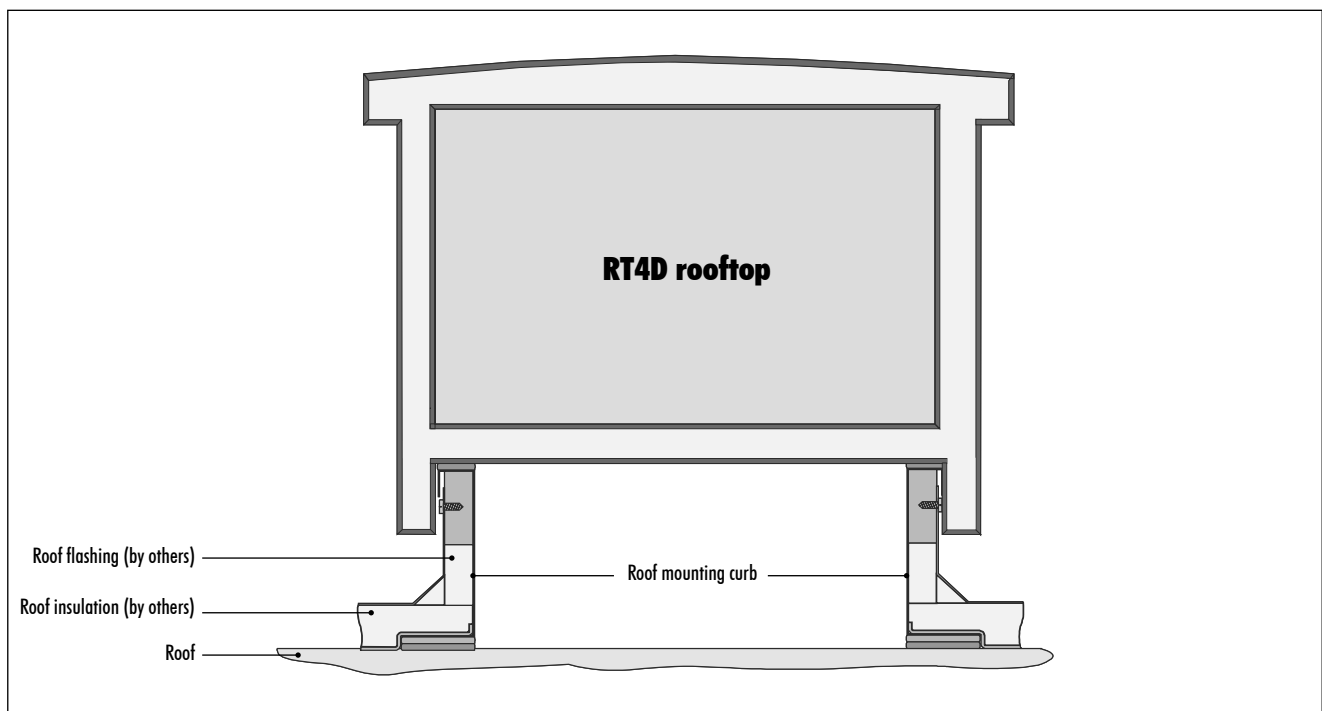

# Automation and Controls

---

The RT4D is assembled and wired at the factory with all the necessary automation and control devices.

It is fully tested at the factory and shipped READY-TO-START to ease the start-up and commissioning on site.

The electrical and control board is mounted in weatherproof cabinet with hinged door, separated from the air flow.

- The automation and the control devices mounted on the board are accessible without disturbing the operation of the unit.
- The electrical wiring complies with the CE standards and EN 60204-1.
- The cables and the wires are identified to ease trouble-shooting.
- One main lockable disconnect is accessible from outside without touching the cabinet.
- The main disconnect is sized for all electrical features supplied with the RT4D.
- There is one cable and wire inlet on the low side of the cabinet for field connection.
- A connection in the floor of the RT4D within the roof mounting curb is optional.
- A general alarm with dry-contact for field connection is optional.
- The Direct Digital Controller is programmed at the factory.
- All year-round operations, heating and cooling, with dedication to energy-saving and safety are programmed at the factory : staging of cooling and heating to satisfy ambient setting, ambient load monitoring, compressor cycling, defrost and overloading control.
- The electrical and control panel is equipped with an electric heater, controlled by an ambient thermostat to operate at low ambient temperature.
- The setting of the minimum outdoor air for the ventilation rate of the building to satisfy the hygienic requirements is done at the controller.
- The compensation of the winter/summer ambient temperatures is optional.
- The room sensor can be replaced by an optional return air duct sensor.
- The night set-back temperature or unoccupied mode, maintenance scheduling, the hours of operation, the history of the last 150 failures and alarms with the indication of day and hour of the failure, are optional with a time card.
- A user-interface is optional. The user interface has a LED semi-graphic 4 lines 20 columns screen, backlight for the edition of actual values, set-points, hours of operation and alarms with a 6 buttons key-pad for field-programming of set-points, proportional bands and alarm threshold.
- The user interface can be field installed remote (max. 200 m) or located at the RT4D in the panel. A second remote user interface is possible.
- A SMS warning via GSM is optional.
- A ModBus communication to a BMS is optional with a RS485 card.
- A LonWorks communication to a BMS is optional.
- An optional interface to MODEM is possible.

# Physical Data

RT4D SIZE		20	40	60	80	100	140	180	240	280	380
Cooling capacity (1)	kW	16.2	29.2	33.4	50.4	58.4	83.9	103.9	150.7	167.5	207.8
Sensible heat factor		0.65	0.6	0.61	0.61	0.63	0.64	0.64	0.64	0.64	0.64
Total power input	kW	5.3	9.81	12.2	17.5	20.9	30.6	37	57.6	61.2	80.8
Compressor power input	kW	3.85	6.91	7.8	11.6	14	19.7	24.1	35.8	39.4	49
Heating capacity (1)	kW	14.4	26.0	30.8	45.2	53.2	76.1	91.5	137.3	151.2	183.2
Total power input	kW	4.76	8.9	10.9	15.6	18.63	27.1	33.24	51.27	54.2	74.67
Compressor power input	kW	3.31	6.0	6.5	9.7	11.73	16.2	20.3	29.5	32.4	41.9
<b>REFRIGERANT</b>											
Type		R407C									
Number of circuit		1	1	1	1	1	1	1	2	2	2
<b>COMPRESSORS</b>											
Number of compressor	Nb	1	1	1	1	2	2	2	4	4	4
Assembly type		Single	Single	Single	Single	Tandem	Tandem	Tandem	Tandem	Tandem	Tandem
Compressor type		Scroll	Scroll	Scroll	Scroll	Scroll	Scroll	Scroll	Scroll	Scroll	Scroll
Capacity control	%	0-100	0-100	0-100	0-50-100	0-50-100	0-50-100	0-50-100	0-25-50-100	0-25-50-100	0-25-50-100
<b>INDOOR BLOWER</b>											
Type		Centrifugal									
Quantity		1	1	1	1	1	1	1	1	2	2
Nominal air volume	m <sup>3</sup> /h	2 000	4 000	6 000	8 000	10 000	14 000	18 000	24 000	28 000	38 000
Motor power	kW	0.75	1.5	2.2	3	4	5.5	7.5	11	2 x 5.5	2 x 11
Nominal ext. static pressure	Pa	250	250	250	250	250	250	250	250	250	250
<b>OUTDOOR BLOWER</b>											
Type		Plug fan									
Quantity		1	2	2	2	2	2	2	4	4	4
Nominal air volume	m <sup>3</sup> /h	4 600	8 600	11 200	15 600	19 400	26 400	31 800	44 000	59 000	64 800
Motor power	kW	0.7	2 x 0.7	2 x 1.1	2 x 1.45	2 x 1.45	2 x 2.7	2 x 2.7	4 x 2.7	4 x 2.7	4 x 2.7
Nominal ext. static pressure	Pa	220	170	250	240	250	220	175	185	240	180
<b>DIMENSIONS (2)</b>											
Length	mm.	3200	3200	3940	3940	5400	5400	6400	6400	7750	7750
Width	mm.	1280	1280	1750	1750	1960	1960	2420	2420	2420	2420
Height	mm.	1150	1150	1420	1420	1880	1880	2440	2440	2440	2440
Weight	kg	640	780	840	980	1480	1840	2660	2680	3380	3660

(1) Nominal heat-pump capacities at **40% outdoor air** (minimum ventilation rate) and nominal air volume.

Cooling conditions : Outdoor +35 °C 60% RH, Indoor returning air +26 °C 55% RH.

Heating conditions : Outdoor +7 °C 60% RH, Indoor returning air +20 °C 40% RH.

(2) The length and the weight of the RT4D will vary with a gas section and frontal or downward air pattern, please ask your sales representative.

## Accessories Weight (in kg)

RT4D models	20	40	60	80	100	140	180	240	280	380
2-row hot water coil	22	64	64	64	85	85	112	155	185	185
3-row hot water coil	29	82	82	82	116	116	162	212	270	270
Gas heat	32	45	70	90	90	120	150	205	205	232



# Electrical Data

## Unit without electric heater

RT4D models		20	40	60	80	100	140	180	240	280	380
Supply voltage		400 V / 3 Ph / 50 Hz									
Total running current	A	14.5	27	34	45.7	56.2	81.1	95	152.2	162.2	205.2
Maximum starting current	A	68	130	139	221	158	218	260	285	298	356

## Unit with electric heater

RT4D models		20	40	60	80	100	140	180	240	280	380
Supply voltage		400 V / 3 Ph / 50 Hz									
Total running current	A	30.2	48.0	65.4	82.4	98.1	130.0	157.9	215.1	235.6	289.0
Maximum starting current	A	84	151	170	258	200	267	323	348	371	440

## Optional electric heater data

RT4D models		20	40	60	80	100	140	180	240	280	380
Stage 1	kW	4.5	6	9	10.5	12	12	18	18	21	24
Stage 2	kW	4.5	6	9	10.5	12	16	18	18	21	24
Total capacity	kW	9	12	18	21	24	28	36	36	42	48

## Optional Gas Heat's Data

RT4D models		20	40	60	80	100	140	180	240	280	380
Nominal airflow	m <sup>3</sup> /h	2000	4000	6000	8000	10000	14000	18000	24000	28000	38000
Gas*		G20									
Supply pressure (min/max)	mbar	7.5 / 20									
Nominal capacity	kW	18	24	36	50	50	75	100	125	125	150
Number of stage		2									
Gas consumption	m <sup>3</sup> /h	2.1	2.79	4.2	5.92	5.92	8.73	11.45	14.63	14.63	17.44
Minimum heating output with modulation option	kW	5.2	6.9	10.4	14.4	14.4	21.6	28	36	36	43.2
Ø gas connection	inch	3/4"	3/4"	3/4"	1"	1"	1"	1" 1/2	1"1/2	1"1/2	1"1/2
Air Pressure drop	Pa	38	44	45	75	84	92	105	75	92	115

\* G25 and G30 upon request.

# Units Performance Data - RT4D 20

Summer performances		Size : RT4D 20					
Outdoor air percentage = 0%		Outdoor temperature (dry bulb °C)					
Indoor conditions (Dry bulb °C / Wet bulb °C)		25	30	32	35	38	40
24 °C / 18 °C	Cooling capacity (kW)	14.7	14.3	14.1	13.7	13.4	13.1
	Compressors power input (kW)	3.3	3.7	3.8	4.1	4.3	4.5
26 °C / 19.5 °C	Cooling capacity (kW)	15.5	15	14.8	14.4	14	13.7
	Compressors power input (kW)	3.4	3.7	3.9	4.1	4.4	4.5
29 °C / 22 °C	Cooling capacity (kW)	16.7	16.2	15.9	15.5	15.1	14.8
	compressors power input (kW)	3.5	3.8	4	4.2	4.5	4.6
31 °C / 24 °C	Cooling capacity (kW)	17.7	17.1	16.8	16.4	16	15.7
	Compressors power input (kW)	3.5	3.9	4.1	4.3	4.6	4.7
Winter performances		Size : RT4D 20					
Outdoor air percentage = 0%		Outdoor temperature (dry bulb °C)					
Indoor conditions (Dry bulb temp. °C / Relative humidity %)		-7	-3	0	3	7	10
16 °C / 40 %	Heating capacity (kW)	9.3	10.1	11	11.9	13.1	14.1
	Compressors power input (kW)	3.1	3.2	3.4	3.6	3.8	4
18 °C / 40 %	Heating capacity (kW)	9.3	10.1	11	11.8	13.1	14
	Compressors power input (kW)	3.2	3.4	3.5	3.7	4	4.2
20 °C / 40 %	Heating capacity (kW)	9.3	10.1	10.9	11.8	13	13.9
	Compressors power input (kW)	3.3	3.5	3.7	3.9	4.1	4.4
22 °C / 40 %	Heating capacity (kW)	9.3	10.1	10.9	11.8	12.9	13.8
	Compressors power input (kW)	3.5	3.6	3.8	4	4.3	4.5

Summer performances		Size : RT4D 20					
Outdoor air percentage = 25%		Outdoor temperature (dry bulb °C)					
Indoor conditions (Dry bulb °C / Wet bulb °C)		25	30	32	35	38	40
24 °C / 18 °C	Cooling capacity (kW)	15.9	15.5	15.3	14.8	14.5	14.2
	Compressors power input (kW)	3.10	3.47	3.57	3.85	4.04	4.23
26 °C / 19.5 °C	Cooling capacity (kW)	16.8	16.2	16.0	15.6	15.2	14.8
	Compressors power input (kW)	3.19	3.47	3.66	3.85	4.13	4.23
29 °C / 22 °C	Cooling capacity (kW)	18.1	17.5	17.2	16.8	16.4	16.0
	Compressors power input (kW)	3.29	3.57	3.76	3.94	4.23	4.32
31 °C / 24 °C	Cooling capacity (kW)	19.2	18.5	18.2	17.8	17.3	17.0
	Compressors power input (kW)	3.29	3.66	3.85	4.04	4.32	4.41
Winter performances		Size : RT4D 20					
Outdoor air percentage = 25%		Outdoor temperature (dry bulb °C)					
Indoor conditions (Dry bulb temp. °C / Relative humidity %)		-7	-3	0	3	7	10
16 °C / 40 %	Heating capacity (kW)	9.92	10.78	11.74	12.70	13.98	15.04
	Compressors power input (kW)	2.60	2.68	2.85	3.02	3.19	3.36
18 °C / 40 %	Heating capacity (kW)	9.92	10.78	11.74	12.59	13.98	14.94
	Compressors power input (kW)	2.68	2.85	2.94	3.10	3.36	3.52
20 °C / 40 %	Heating capacity (kW)	9.92	10.78	11.63	12.6	13.87	14.83
	Compressors power input (kW)	2.77	2.94	3.10	3.27	3.44	3.69
22 °C / 40 %	Heating capacity (kW)	9.92	10.78	11.63	12.59	13.76	14.72
	Compressors power input (kW)	2.94	3.02	3.19	3.36	3.61	3.78

# Units Performance Data - RT4D 20 (continued)

Summer performances		Size : RT4D 20					
Outdoor air percentage = 40%		Outdoor temperature (dry bulb °C)					
Indoor conditions (Dry bulb °C / Wet bulb °C)		25	30	32	35	38	40
24 °C / 18 °C	Cooling capacity (kW)	16.5	16.1	15.9	15.4	15.1	14.7
	Compressors power input (kW)	3.10	3.47	3.57	3.85	4.04	4.23
26 °C / 19.5 °C	Cooling capacity (kW)	17.4	16.9	16.7	<b>16.2</b>	15.8	15.4
	Compressors power input (kW)	3.19	3.47	3.66	<b>3.85</b>	4.13	4.23
29 °C / 22 °C	Cooling capacity (kW)	18.8	18.2	17.9	17.4	17.0	16.7
	compressors power input (kW)	3.29	3.57	3.76	3.94	4.23	4.32
31 °C / 24 °C	Cooling capacity (kW)	19.9	19.2	18.9	18.5	18.0	17.7
	Compressors power input (kW)	3.29	3.66	3.85	4.04	4.32	4.41
Winter performances		Size : RT4D 20					
Outdoor air percentage = 40%		Outdoor temperature (dry bulb °C)					
Indoor conditions (Dry bulb temp. °C / Relative humidity %)		-7	-3	0	3	7	10
16 °C / 40 %	Heating capacity (kW)	10.32	11.21	12.21	13.21	14.54	15.65
	Compressors power input (kW)	2.50	2.58	2.75	2.91	3.07	3.23
18 °C / 40 %	Heating capacity (kW)	10.32	11.21	12.21	13.10	14.54	15.54
	Compressors power input (kW)	2.58	2.75	2.83	2.99	3.23	3.39
20 °C / 40 %	Heating capacity (kW)	10.32	11.21	12.10	13.10	<b>14.43</b>	15.43
	Compressors power input (kW)	2.67	2.83	2.99	3.15	<b>3.31</b>	3.55
22 °C / 40 %	Heating capacity (kW)	10.32	11.21	12.10	13.10	14.32	15.32
	Compressors power input (kW)	2.83	2.91	3.07	3.23	3.47	3.63

Summer performances		Size : RT4D 20					
Outdoor air percentage = 60%		Outdoor temperature (dry bulb °C)					
Indoor conditions (Dry bulb °C / Wet bulb °C)		25	30	32	35	38	40
24 °C / 18 °C	Cooling capacity (kW)	17.6	17.1	16.8	16.4	16.0	15.6
	Compressors power input (kW)	3.10	3.47	3.57	3.85	4.04	4.23
26 °C / 19.5 °C	Cooling capacity (kW)	18.5	17.9	17.7	17.2	16.7	16.4
	Compressors power input (kW)	3.19	3.47	3.66	3.85	4.13	4.23
29 °C / 22 °C	Cooling capacity (kW)	19.9	19.3	19.0	18.5	18.0	17.7
	Compressors power input (kW)	3.29	3.57	3.76	3.94	4.23	4.32
31 °C / 24 °C	Cooling capacity (kW)	21.1	20.4	20.1	19.6	19.1	18.7
	Compressors power input (kW)	3.29	3.66	3.85	4.04	4.32	4.41
Winter performances		Size : RT4D 20					
Outdoor air percentage = 60%		Outdoor temperature (dry bulb °C)					
Indoor conditions (Dry bulb temp. °C / Relative humidity %)		-7	-3	0	3	7	10
16 °C / 40 %	Heating capacity (kW)	10.80	11.73	12.77	13.82	15.21	16.37
	Compressors power input (kW)	2.42	2.50	2.65	2.81	2.96	3.12
18 °C / 40 %	Heating capacity (kW)	10.80	11.73	12.77	13.70	15.21	16.25
	Compressors power input (kW)	2.50	2.65	2.73	2.89	3.12	3.28
20 °C / 40 %	Heating capacity (kW)	10.80	11.73	12.65	13.70	15.09	16.14
	Compressors power input (kW)	2.57	2.73	2.89	3.04	3.20	3.43
22 °C / 40 %	Heating capacity (kW)	10.80	11.73	12.65	13.70	14.98	16.02
	Compressors power input (kW)	2.73	2.81	2.96	3.12	3.35	3.51

# Units Performance Data - RT4D 40

Summer performances		Size : RT4D 40					
Outdoor air percentage = 0%		Outdoor temperature (dry bulb °C)					
Indoor conditions (Dry bulb °C / Wet bulb °C)		25	30	32	35	38	40
24 °C / 18 °C	Cooling capacity (kW)	26.2	25.4	25.1	24.5	24	23.6
	Compressors power input (kW)	5.4	6.1	6.4	7.2	7.4	7.7
26 °C / 19.5 °C	Cooling capacity (kW)	27.6	26.7	26.4	25.9	25.2	24.8
	Compressors power input (kW)	5.5	6.2	6.5	7.1	7.5	7.8
29 °C / 22 °C	Cooling capacity (kW)	29.9	29	28.6	28	27.4	26.9
	compressors power input (kW)	5.6	6.3	6.6	7.4	7.6	7.9
31 °C / 24 °C	Cooling capacity (kW)	31.7	30.8	30.4	29.7	29.1	28.6
	Compressors power input (kW)	5.6	6.3	6.7	7.4	7.6	8
Winter performances		Size : RT4D 40					
Outdoor air percentage = 0%		Outdoor temperature (dry bulb °C)					
Indoor conditions (Dry bulb temp. °C / Relative humidity %)		-7	-3	0	3	7	10
16 °C / 40 %	Heating capacity (kW)	17.4	18.6	20.1	21.8	24.1	26.1
	Compressors power input (kW)	5.2	5.3	5.6	5.8	6.1	6.4
18 °C / 40 %	Heating capacity (kW)	17.5	18.6	20.2	21.8	24.1	26.1
	Compressors power input (kW)	5.5	5.6	5.8	6.1	6.4	6.7
20 °C / 40 %	Heating capacity (kW)	17.5	18.6	20.2	21.9	24.1	26.1
	Compressors power input (kW)	5.7	5.9	6.1	6.4	6.8	7.1
22 °C / 40 %	Heating capacity (kW)	17.5	18.7	20.2	21.9	24.1	26.1
	Compressors power input (kW)	6	6.2	6.4	6.7	7.1	7.4

Summer performances		Size : RT4D 40					
Outdoor air percentage = 25%		Outdoor temperature (dry bulb °C)					
Indoor conditions (Dry bulb °C / Wet bulb °C)		25	30	32	35	38	40
24 °C / 18 °C	Cooling capacity (kW)	28.5	27.6	27.3	26.7	26.1	25.7
	Compressors power input (kW)	5.25	5.93	6.23	7.00	7.20	7.49
26 °C / 19.5 °C	Cooling capacity (kW)	30.0	29.0	28.7	28.2	27.4	27.0
	Compressors power input (kW)	5.35	6.03	6.32	6.91	7.30	7.59
29 °C / 22 °C	Cooling capacity (kW)	32.5	31.6	31.1	30.5	29.8	29.3
	Compressors power input (kW)	5.45	6.13	6.42	7.20	7.39	7.68
31 °C / 24 °C	Cooling capacity (kW)	34.5	33.5	33.1	32.3	31.7	31.1
	Compressors power input (kW)	5.45	6.13	6.52	7.20	7.39	7.78
Winter performances		Size : RT4D 40					
Outdoor air percentage = 25%		Outdoor temperature (dry bulb °C)					
Indoor conditions (Dry bulb temp. °C / Relative humidity %)		-7	-3	0	3	7	10
16 °C / 40 %	Heating capacity (kW)	18.18	19.44	21.00	22.78	25.18	27.27
	Compressors power input (kW)	4.75	4.84	5.12	5.30	5.58	5.85
18 °C / 40 %	Heating capacity (kW)	18.29	19.44	21.11	22.78	25.18	27.27
	Compressors power input (kW)	5.03	5.12	5.30	5.58	5.85	6.12
20 °C / 40 %	Heating capacity (kW)	18.29	19.44	21.11	22.9	25.18	27.27
	Compressors power input (kW)	5.21	5.39	5.58	5.85	6.22	6.49
22 °C / 40 %	Heating capacity (kW)	18.29	19.54	21.11	22.89	25.18	27.27
	Compressors power input (kW)	5.48	5.67	5.85	6.12	6.49	6.76

# Units Performance Data - RT4D 40 (continued)

Summer performances		Size : RT4D 40					
Outdoor air percentage = 40%		Outdoor temperature (dry bulb °C)					
Indoor conditions (Dry bulb °C / Wet bulb °C)		25	30	32	35	38	40
24 °C / 18 °C	Cooling capacity (kW)	29.5	28.6	28.3	27.6	27.0	26.6
	Compressors power input (kW)	5.25	5.93	6.23	7.00	7.20	7.49
26 °C / 19.5 °C	Cooling capacity (kW)	31.1	30.1	29.8	<b>29.2</b>	28.4	27.9
	Compressors power input (kW)	5.35	6.03	6.32	<b>6.91</b>	7.30	7.59
29 °C / 22 °C	Cooling capacity (kW)	33.7	32.7	32.2	31.6	30.9	30.3
	compressors power input (kW)	5.45	6.13	6.42	7.20	7.39	7.68
31 °C / 24 °C	Cooling capacity (kW)	35.7	34.7	34.3	33.5	32.8	32.2
	Compressors power input (kW)	5.45	6.13	6.52	7.20	7.39	7.78
Winter performances		Size : RT4D 40					
Outdoor air percentage = 40%		Outdoor temperature (dry bulb °C)					
Indoor conditions (Dry bulb temp. °C / Relative humidity %)		-7	-3	0	3	7	10
16 °C / 40 %	Heating capacity (kW)	18.74	20.03	21.65	23.48	25.96	28.11
	Compressors power input (kW)	4.57	4.66	4.92	5.10	5.36	5.62
18 °C / 40 %	Heating capacity (kW)	18.85	20.03	21.76	23.48	25.96	28.11
	Compressors power input (kW)	4.83	4.92	5.10	5.36	5.62	5.89
20 °C / 40 %	Heating capacity (kW)	18.85	20.03	21.76	23.59	<b>25.96</b>	28.11
	Compressors power input (kW)	5.01	5.18	5.36	5.62	<b>5.98</b>	6.24
22 °C / 40 %	Heating capacity (kW)	18.85	20.14	21.76	23.59	25.96	28.11
	Compressors power input (kW)	5.27	5.45	5.62	5.89	6.24	6.50

Summer performances		Size : RT4D 40					
Outdoor air percentage = 60%		Outdoor temperature (dry bulb °C)					
Indoor conditions (Dry bulb °C / Wet bulb °C)		25	30	32	35	38	40
24 °C / 18 °C	Cooling capacity (kW)	31.3	30.3	29.9	29.2	28.6	28.2
	Compressors power input (kW)	5.21	5.89	6.18	6.95	7.14	7.43
26 °C / 19.5 °C	Cooling capacity (kW)	32.9	31.9	31.5	30.9	30.1	29.6
	Compressors power input (kW)	5.31	5.98	6.27	6.85	7.24	7.53
29 °C / 22 °C	Cooling capacity (kW)	35.7	34.6	34.1	33.4	32.7	32.1
	Compressors power input (kW)	5.41	6.08	6.37	7.14	7.34	7.63
31 °C / 24 °C	Cooling capacity (kW)	37.8	36.7	36.3	35.4	34.7	34.1
	Compressors power input (kW)	5.41	6.08	6.47	7.14	7.34	7.72
Winter performances		Size : RT4D 40					
Outdoor air percentage = 60%		Outdoor temperature (dry bulb °C)					
Indoor conditions (Dry bulb temp. °C / Relative humidity %)		-7	-3	0	3	7	10
16 °C / 40 %	Heating capacity (kW)	19.45	20.79	22.47	24.37	26.94	29.18
	Compressors power input (kW)	4.37	4.45	4.70	4.87	5.12	5.37
18 °C / 40 %	Heating capacity (kW)	19.57	20.79	22.58	24.37	26.94	29.18
	Compressors power input (kW)	4.62	4.70	4.87	5.12	5.37	5.63
20 °C / 40 %	Heating capacity (kW)	19.57	20.79	22.58	24.5	26.94	29.18
	Compressors power input (kW)	4.79	4.95	5.12	5.37	5.71	5.96
22 °C / 40 %	Heating capacity (kW)	19.57	20.91	22.58	24.48	26.94	29.18
	Compressors power input (kW)	5.04	5.21	5.37	5.63	5.96	6.21

# Units Performance Data - RT4D 60

Summer performances		Size : RT4D 60					
Outdoor air percentage = 0%		Outdoor temperature (dry bulb °C)					
Indoor conditions (Dry bulb °C / Wet bulb °C)		25	30	32	35	38	40
24 °C / 18 °C	Cooling capacity (kW)	30.4	29.4	29	28.4	27.7	27.3
	Compressors power input (kW)	6.1	6.9	7.2	7.7	8.3	8.7
26 °C / 19.5 °C	Cooling capacity (kW)	32.1	31	30.6	29.9	29.2	28.8
	Compressors power input (kW)	6.2	6.9	7.3	7.95	8.4	8.8
29 °C / 22 °C	Cooling capacity (kW)	34.9	33.8	33.3	32.6	31.8	31.3
	compressors power input (kW)	6.3	7.1	7.4	7.9	8.5	8.9
31 °C / 24 °C	Cooling capacity (kW)	37.2	36	35.5	34.7	33.9	33.2
	Compressors power input (kW)	6.3	7.1	7.5	8	8.6	9
Winter performances		Size : RT4D 60					
Outdoor air percentage = 0%		Outdoor temperature (dry bulb °C)					
Indoor conditions (Dry bulb temp. °C / Relative humidity %)		-7	-3	0	3	7	10
16 °C / 40 %	Heating capacity (kW)	20.5	21.9	23.6	25.6	28.4	30.6
	Compressors power input (kW)	5.6	5.8	5.9	6.1	6.4	6.7
18 °C / 40 %	Heating capacity (kW)	20.5	21.9	23.6	25.6	28.3	30.5
	Compressors power input (kW)	5.9	6	6.2	6.4	6.8	7
20 °C / 40 %	Heating capacity (kW)	20.5	21.9	23.6	25.5	28.3	30.5
	Compressors power input (kW)	6.2	6.3	6.5	6.9	7.1	7.4
22 °C / 40 %	Heating capacity (kW)	20.6	21.9	23.6	25.5	28.3	30.4
	Compressors power input (kW)	6.5	6.6	6.8	7.1	7.4	7.7

Summer performances		Size : RT4D 60					
Outdoor air percentage = 25%		Outdoor temperature (dry bulb °C)					
Indoor conditions (Dry bulb °C / Wet bulb °C)		25	30	32	35	38	40
24 °C / 18 °C	Cooling capacity (kW)	32.4	31.3	30.9	30.3	29.5	29.1
	Compressors power input (kW)	5.99	6.78	7.07	7.56	8.15	8.55
26 °C / 19.5 °C	Cooling capacity (kW)	34.2	33.0	32.6	31.9	31.1	30.7
	Compressors power input (kW)	6.09	6.78	7.17	7.81	8.25	8.64
29 °C / 22 °C	Cooling capacity (kW)	37.2	36.0	35.5	34.8	33.9	33.4
	Compressors power input (kW)	6.19	6.97	7.27	7.76	8.35	8.74
31 °C / 24 °C	Cooling capacity (kW)	39.7	38.4	37.8	37.0	36.1	35.4
	Compressors power input (kW)	6.19	6.97	7.37	7.86	8.45	8.84
Winter performances		Size : RT4D 60					
Outdoor air percentage = 25%		Outdoor temperature (dry bulb °C)					
Indoor conditions (Dry bulb temp. °C / Relative humidity %)		-7	-3	0	3	7	10
16 °C / 40 %	Heating capacity (kW)	21.55	23.02	24.80	26.91	29.85	32.16
	Compressors power input (kW)	5.36	5.55	5.65	5.84	6.12	6.41
18 °C / 40 %	Heating capacity (kW)	21.55	23.02	24.80	26.91	29.74	32.06
	Compressors power input (kW)	5.65	5.74	5.93	6.12	6.51	6.70
20 °C / 40 %	Heating capacity (kW)	21.55	23.02	24.80	26.80	29.74	32.06
	Compressors power input (kW)	5.93	6.03	6.22	6.60	6.79	7.08
22 °C / 40 %	Heating capacity (kW)	21.65	23.02	24.80	26.80	29.74	31.95
	Compressors power input (kW)	6.22	6.32	6.51	6.79	7.08	7.37

# Units Performance Data - RT4D 60 (continued)

Summer performances		Size : RT4D 60					
Outdoor air percentage = 40%		Outdoor temperature (dry bulb °C)					
Indoor conditions (Dry bulb °C / Wet bulb °C)		25	30	32	35	38	40
24 °C / 18 °C	Cooling capacity (kW)	34.0	32.8	32.4	31.7	30.9	30.5
	Compressors power input (kW)	5.99	6.77	7.07	7.56	8.15	8.54
26 °C / 19.5 °C	Cooling capacity (kW)	35.9	34.6	34.2	<b>33.4</b>	32.6	32.2
	Compressors power input (kW)	6.08	6.77	7.16	<b>7.80</b>	8.24	8.64
29 °C / 22 °C	Cooling capacity (kW)	39.0	37.8	37.2	36.4	35.5	35.0
	compressors power input (kW)	6.18	6.97	7.26	7.75	8.34	8.73
31 °C / 24 °C	Cooling capacity (kW)	41.6	40.2	39.7	38.8	37.9	37.1
	Compressors power input (kW)	6.18	6.97	7.36	7.85	8.44	8.83
Winter performances		Size : RT4D 60					
Outdoor air percentage = 40%		Outdoor temperature (dry bulb °C)					
Indoor conditions (Dry bulb temp. °C / Relative humidity %)		-7	-3	0	3	7	10
16 °C / 40 %	Heating capacity (kW)	22.35	23.87	25.72	27.90	30.96	33.35
	Compressors power input (kW)	5.11	5.30	5.39	5.57	5.84	6.12
18 °C / 40 %	Heating capacity (kW)	22.35	23.87	25.72	27.90	30.85	33.25
	Compressors power input (kW)	5.39	5.48	5.66	5.84	6.21	6.39
20 °C / 40 %	Heating capacity (kW)	22.35	23.87	25.72	27.80	<b>30.85</b>	33.25
	Compressors power input (kW)	5.66	5.75	5.94	6.30	<b>6.48</b>	6.76
22 °C / 40 %	Heating capacity (kW)	22.45	23.87	25.72	27.80	30.85	33.14
	Compressors power input (kW)	5.94	6.03	6.21	6.48	6.76	7.03

Summer performances		Size : RT4D 60					
Outdoor air percentage = 60%		Outdoor temperature (dry bulb °C)					
Indoor conditions (Dry bulb °C / Wet bulb °C)		25	30	32	35	38	40
24 °C / 18 °C	Cooling capacity (kW)	36.0	34.8	34.3	33.6	32.8	32.3
	Compressors power input (kW)	5.91	6.69	6.98	7.46	8.04	8.43
26 °C / 19.5 °C	Cooling capacity (kW)	38.0	36.7	36.2	35.4	34.5	34.1
	Compressors power input (kW)	6.01	6.69	7.07	7.70	8.14	8.53
29 °C / 22 °C	Cooling capacity (kW)	41.3	40.0	39.4	38.6	37.6	37.0
	Compressors power input (kW)	6.10	6.88	7.17	7.66	8.24	8.62
31 °C / 24 °C	Cooling capacity (kW)	44.0	42.6	42.0	41.1	40.1	39.3
	Compressors power input (kW)	6.10	6.88	7.27	7.75	8.33	8.72
Winter performances		Size : RT4D 60					
Outdoor air percentage = 60%		Outdoor temperature (dry bulb °C)					
Indoor conditions (Dry bulb temp. °C / Relative humidity %)		-7	-3	0	3	7	10
16 °C / 40 %	Heating capacity (kW)	23.23	24.81	26.74	29.00	32.18	34.67
	Compressors power input (kW)	4.87	5.04	5.13	5.30	5.57	5.83
18 °C / 40 %	Heating capacity (kW)	23.23	24.81	26.74	29.00	32.06	34.56
	Compressors power input (kW)	5.13	5.22	5.39	5.57	5.91	6.09
20 °C / 40 %	Heating capacity (kW)	23.23	24.81	26.74	28.9	32.06	34.56
	Compressors power input (kW)	5.39	5.48	5.65	6.00	6.17	6.43
22 °C / 40 %	Heating capacity (kW)	23.34	24.81	26.74	28.89	32.06	34.44
	Compressors power input (kW)	5.65	5.74	5.91	6.17	6.43	6.70

# Units Performance Data - RT4D 80

Summer performances		Size : RT4D 80					
Outdoor air percentage = 0%		Outdoor temperature (dry bulb °C)					
Indoor conditions (Dry bulb °C / Wet bulb °C)		25	30	32	35	38	40
24 °C / 18 °C	Cooling capacity (kW)	45.4	44.1	43.6	42.7	41.8	41.2
	Compressors power input (kW)	10.1	11.3	11.7	12.5	13.4	13.9
26 °C / 19.5 °C	Cooling capacity (kW)	47.8	46.5	45.9	45.1	44.1	43.5
	Compressors power input (kW)	10.2	11.4	11.9	12.7	13.5	14.1
29 °C / 22 °C	Cooling capacity (kW)	52.1	50.7	50.1	49.1	48.1	47.4
	compressors power input (kW)	10.4	11.6	12.1	12.9	13.8	14.4
31 °C / 24 °C	Cooling capacity (kW)	55.6	54.1	53.5	52.5	51.4	50.7
	Compressors power input (kW)	10.6	11.8	12.3	13.1	14	14.6
Winter performances		Size : RT4D 80					
Outdoor air percentage = 0%		Outdoor temperature (dry bulb °C)					
Indoor conditions (Dry bulb temp. °C / Relative humidity %)		-7	-3	0	3	7	10
16 °C / 40 %	Heating capacity (kW)	31.8	33.4	35.6	38.2	42	45.2
	Compressors power input (kW)	9.6	9.8	10	10.3	10.7	11.1
18 °C / 40 %	Heating capacity (kW)	31.9	33.5	35.7	38.2	42	45.1
	Compressors power input (kW)	10	10.2	10.4	10.7	11.2	11.6
20 °C / 40 %	Heating capacity (kW)	32	33.6	35.7	38.2	42	45.1
	Compressors power input (kW)	10.4	10.6	10.8	11.1	11.6	12.1
22 °C / 40 %	Heating capacity (kW)	32.1	33.7	35.8	38.3	42	45
	Compressors power input (kW)	10.8	11	11.3	11.6	12.1	12.6

Summer performances		Size : RT4D 80					
Outdoor air percentage = 25%		Outdoor temperature (dry bulb °C)					
Indoor conditions (Dry bulb °C / Wet bulb °C)		25	30	32	35	38	40
24 °C / 18 °C	Cooling capacity (kW)	48.6	47.2	46.7	45.7	44.8	44.1
	Compressors power input (kW)	9.31	10.41	10.78	11.52	12.35	12.81
26 °C / 19.5 °C	Cooling capacity (kW)	51.2	49.8	49.2	48.3	47.2	46.6
	Compressors power input (kW)	9.40	10.51	10.97	11.7	12.44	13.00
29 °C / 22 °C	Cooling capacity (kW)	55.8	54.3	53.7	52.6	51.5	50.8
	Compressors power input (kW)	9.59	10.69	11.15	11.89	12.72	13.27
31 °C / 24 °C	Cooling capacity (kW)	59.5	57.9	57.3	56.2	55.0	54.3
	Compressors power input (kW)	9.77	10.88	11.34	12.07	12.90	13.46
Winter performances		Size : RT4D 80					
Outdoor air percentage = 25%		Outdoor temperature (dry bulb °C)					
Indoor conditions (Dry bulb temp. °C / Relative humidity %)		-7	-3	0	3	7	10
16 °C / 40 %	Heating capacity (kW)	33.22	34.89	37.18	39.90	43.87	47.21
	Compressors power input (kW)	8.39	8.56	8.74	9.00	9.35	9.70
18 °C / 40 %	Heating capacity (kW)	33.32	34.99	37.29	39.90	43.87	47.11
	Compressors power input (kW)	8.74	8.91	9.09	9.35	9.79	10.14
20 °C / 40 %	Heating capacity (kW)	33.42	35.10	37.29	39.90	43.87	47.11
	Compressors power input (kW)	9.09	9.26	9.44	9.70	10.14	10.57
22 °C / 40 %	Heating capacity (kW)	33.53	35.20	37.39	40.00	43.87	47.00
	Compressors power input (kW)	9.44	9.61	9.88	10.14	10.57	11.01



# Units Performance Data - RT4D 80 (continued)

Summer performances		Size : RT4D 80					
Outdoor air percentage = 40%		Outdoor temperature (dry bulb °C)					
Indoor conditions (Dry bulb °C / Wet bulb °C)		25	30	32	35	38	40
24 °C / 18 °C	Cooling capacity (kW)	50.7	49.3	48.7	47.7	46.7	46.0
	Compressors power input (kW)	9.23	10.32	10.69	11.42	12.24	12.70
26 °C / 19.5 °C	Cooling capacity (kW)	53.4	51.9	51.3	<b>50.4</b>	49.3	48.6
	Compressors power input (kW)	9.32	10.41	10.87	<b>11.60</b>	12.33	12.88
29 °C / 22 °C	Cooling capacity (kW)	58.2	56.6	56.0	54.8	53.7	52.9
	compressors power input (kW)	9.50	10.60	11.05	11.78	12.61	13.15
31 °C / 24 °C	Cooling capacity (kW)	62.1	60.4	59.8	58.6	57.4	56.6
	Compressors power input (kW)	9.68	10.78	11.23	11.97	12.79	13.34
Winter performances		Size : RT4D 80					
Outdoor air percentage = 40%		Outdoor temperature (dry bulb °C)					
Indoor conditions (Dry bulb temp. °C / Relative humidity %)		-7	-3	0	3	7	10
16 °C / 40 %	Heating capacity (kW)	34.22	35.94	38.31	41.10	45.19	48.64
	Compressors power input (kW)	8.05	8.21	8.38	8.63	8.97	9.30
18 °C / 40 %	Heating capacity (kW)	34.32	36.05	38.41	41.10	45.19	48.53
	Compressors power input (kW)	8.38	8.55	8.72	8.97	9.39	9.72
20 °C / 40 %	Heating capacity (kW)	34.43	36.15	38.41	41.10	<b>45.19</b>	48.53
	Compressors power input (kW)	8.72	8.89	9.05	9.30	<b>9.72</b>	10.14
22 °C / 40 %	Heating capacity (kW)	34.54	36.26	38.52	41.21	45.19	48.42
	Compressors power input (kW)	9.05	9.22	9.47	9.72	10.14	10.56

Summer performances		Size : RT4D 80					
Outdoor air percentage = 60%		Outdoor temperature (dry bulb °C)					
Indoor conditions (Dry bulb °C / Wet bulb °C)		25	30	32	35	38	40
24 °C / 18 °C	Cooling capacity (kW)	54.0	52.5	51.9	50.8	49.7	49.0
	Compressors power input (kW)	8.99	10.06	10.42	11.13	11.93	12.38
26 °C / 19.5 °C	Cooling capacity (kW)	56.9	55.3	54.6	53.7	52.5	51.8
	Compressors power input (kW)	9.08	10.15	10.60	11.3	12.02	12.56
29 °C / 22 °C	Cooling capacity (kW)	62.0	60.3	59.6	58.4	57.2	56.4
	Compressors power input (kW)	9.26	10.33	10.77	11.49	12.29	12.82
31 °C / 24 °C	Cooling capacity (kW)	66.2	64.4	63.7	62.5	61.2	60.3
	Compressors power input (kW)	9.44	10.51	10.95	11.67	12.47	13.00
Winter performances		Size : RT4D 80					
Outdoor air percentage = 60%		Outdoor temperature (dry bulb °C)					
Indoor conditions (Dry bulb temp. °C / Relative humidity %)		-7	-3	0	3	7	10
16 °C / 40 %	Heating capacity (kW)	35.46	37.24	39.69	42.59	46.83	50.40
	Compressors power input (kW)	7.61	7.77	7.93	8.17	8.49	8.80
18 °C / 40 %	Heating capacity (kW)	35.57	37.35	39.81	42.59	46.83	50.29
	Compressors power input (kW)	7.93	8.09	8.25	8.49	8.88	9.20
20 °C / 40 %	Heating capacity (kW)	35.68	37.46	39.81	42.6	46.83	50.29
	Compressors power input (kW)	8.25	8.41	8.56	8.80	9.20	9.60
22 °C / 40 %	Heating capacity (kW)	35.79	37.58	39.92	42.70	46.83	50.18
	Compressors power input (kW)	8.56	8.72	8.96	9.20	9.60	9.99

# Units Performance Data - RT4D 100

Summer performances		Size : RT4D 100					
Outdoor air percentage = 0%		Outdoor temperature (dry bulb °C)					
Indoor conditions (Dry bulb °C / Wet bulb °C)		25	30	32	35	38	40
24 °C / 18 °C	Cooling capacity (kW)	52.8	51	50.3	49.1	47.9	47
	Compressors power input (kW)	11.37	12.83	13.45	14.4	15.43	16.1
26 °C / 19.5 °C	Cooling capacity (kW)	55.5	53.6	52.7	51.5	50.3	49.5
	Compressors power input (kW)	11.47	12.93	13.56	14.5	15.5	16.27
29 °C / 22 °C	Cooling capacity (kW)	60.2	58	57.1	55.9	54.6	53.7
	compressors power input (kW)	11.58	13.03	13.66	14.7	15.75	16.48
31 °C / 24 °C	Cooling capacity (kW)	63.8	61.7	60.8	59.4	58	57
	Compressors power input (kW)	11.78	13.25	13.87	14.91	15.96	16.69
Winter performances		Size : RT4D 100					
Outdoor air percentage = 0%		Outdoor temperature (dry bulb °C)					
Indoor conditions (Dry bulb temp. °C / Relative humidity %)		-7	-3	0	3	7	10
16 °C / 40 %	Heating capacity (kW)	35.7	37.8	40.7	44.2	49.1	53
	Compressors power input (kW)	11.3	11.4	11.7	11.9	12.4	12.7
18 °C / 40 %	Heating capacity (kW)	35.7	37.8	40.7	44.1	49.1	52.9
	Compressors power input (kW)	11.7	11.9	12.1	12.4	12.9	13.2
20 °C / 40 %	Heating capacity (kW)	35.6	37.8	40.7	44.1	49	52.8
	Compressors power input (kW)	12.2	12.4	12.6	12.8	13.4	13.8
22 °C / 40 %	Heating capacity (kW)	35.7	37.8	40.7	44.1	48.9	52.7
	Compressors power input (kW)	12.7	12.9	13.2	13.5	14	14.4

Summer performances		Size : RT4D 100					
Outdoor air percentage = 25%		Outdoor temperature (dry bulb °C)					
Indoor conditions (Dry bulb °C / Wet bulb °C)		25	30	32	35	38	40
24 °C / 18 °C	Cooling capacity (kW)	57.2	55.2	54.5	53.2	51.9	50.9
	Compressors power input (kW)	11.06	12.48	13.08	14.01	15.01	15.66
26 °C / 19.5 °C	Cooling capacity (kW)	60.1	58.0	57.1	55.8	54.5	53.6
	Compressors power input (kW)	11.16	12.58	13.19	14.1	15.08	15.83
29 °C / 22 °C	Cooling capacity (kW)	65.2	62.8	61.8	60.5	59.1	58.2
	Compressors power input (kW)	11.26	12.68	13.29	14.30	15.32	16.03
31 °C / 24 °C	Cooling capacity (kW)	69.1	66.8	65.8	64.3	62.8	61.7
	Compressors power input (kW)	11.46	12.89	13.49	14.50	15.53	16.24
Winter performances		Size : RT4D 100					
Outdoor air percentage = 25%		Outdoor temperature (dry bulb °C)					
Indoor conditions (Dry bulb temp. °C / Relative humidity %)		-7	-3	0	3	7	10
16 °C / 40 %	Heating capacity (kW)	37.56	39.77	42.82	46.50	51.65	55.76
	Compressors power input (kW)	10.24	10.34	10.61	10.79	11.24	11.51
18 °C / 40 %	Heating capacity (kW)	37.56	39.77	42.82	46.39	51.65	55.65
	Compressors power input (kW)	10.61	10.79	10.97	11.24	11.70	11.97
20 °C / 40 %	Heating capacity (kW)	37.45	39.77	42.82	46.4	51.55	55.55
	Compressors power input (kW)	11.06	11.24	11.42	11.60	12.15	12.51
22 °C / 40 %	Heating capacity (kW)	37.56	39.77	42.82	46.39	51.44	55.44
	Compressors power input (kW)	11.51	11.70	11.97	12.24	12.69	13.06

# Units Performance Data - RT4D 100 (continued)

Summer performances		Size : RT4D 100					
Outdoor air percentage = 40%		Outdoor temperature (dry bulb °C)					
Indoor conditions (Dry bulb °C / Wet bulb °C)		25	30	32	35	38	40
24 °C / 18 °C	Cooling capacity (kW)	59.9	57.8	57.0	55.7	54.3	53.3
	Compressors power input (kW)	10.99	12.40	13.00	13.91	14.91	15.56
26 °C / 19.5 °C	Cooling capacity (kW)	62.9	60.8	59.8	<b>58.4</b>	57.0	56.1
	Compressors power input (kW)	11.08	12.49	13.10	<b>14.0</b>	14.98	15.72
29 °C / 22 °C	Cooling capacity (kW)	68.3	65.8	64.8	63.4	61.9	60.9
	compressors power input (kW)	11.19	12.59	13.20	14.20	15.22	15.92
31 °C / 24 °C	Cooling capacity (kW)	72.3	70.0	68.9	67.4	65.8	64.6
	Compressors power input (kW)	11.38	12.80	13.40	14.41	15.42	16.13
Winter performances		Size : RT4D 100					
Outdoor air percentage = 40%		Outdoor temperature (dry bulb °C)					
Indoor conditions (Dry bulb temp. °C / Relative humidity %)		-7	-3	0	3	7	10
16 °C / 40 %	Heating capacity (kW)	38.77	41.05	44.20	48.00	53.32	57.56
	Compressors power input (kW)	9.89	9.98	10.25	10.42	10.86	11.12
18 °C / 40 %	Heating capacity (kW)	38.77	41.05	44.20	47.89	53.32	57.45
	Compressors power input (kW)	10.25	10.42	10.60	10.86	11.30	11.56
20 °C / 40 %	Heating capacity (kW)	38.66	41.05	44.20	47.9	<b>53.21</b>	57.34
	Compressors power input (kW)	10.68	10.86	11.03	11.2	<b>11.73</b>	12.08
22 °C / 40 %	Heating capacity (kW)	38.77	41.05	44.20	47.89	53.11	57.23
	Compressors power input (kW)	11.12	11.30	11.56	11.82	12.26	12.61

Summer performances		Size : RT4D 100					
Outdoor air percentage = 60%		Outdoor temperature (dry bulb °C)					
Indoor conditions (Dry bulb °C / Wet bulb °C)		25	30	32	35	38	40
24 °C / 18 °C	Cooling capacity (kW)	63.4	61.2	60.4	58.9	57.5	56.4
	Compressors power input (kW)	10.83	12.22	12.81	13.71	14.70	15.33
26 °C / 19.5 °C	Cooling capacity (kW)	66.6	64.3	63.2	61.8	60.4	59.4
	Compressors power input (kW)	10.92	12.31	12.91	13.8	14.76	15.50
29 °C / 22 °C	Cooling capacity (kW)	72.2	69.6	68.5	67.1	65.5	64.4
	Compressors power input (kW)	11.03	12.41	13.01	14.00	15.00	15.70
31 °C / 24 °C	Cooling capacity (kW)	76.6	74.0	73.0	71.3	69.6	68.4
	Compressors power input (kW)	11.22	12.62	13.21	14.20	15.20	15.90
Winter performances		Size : RT4D 100					
Outdoor air percentage = 60%		Outdoor temperature (dry bulb °C)					
Indoor conditions (Dry bulb temp. °C / Relative humidity %)		-7	-3	0	3	7	10
16 °C / 40 %	Heating capacity (kW)	40.38	42.75	46.03	49.99	55.53	59.94
	Compressors power input (kW)	9.36	9.44	9.69	9.86	10.27	10.52
18 °C / 40 %	Heating capacity (kW)	40.38	42.75	46.03	49.88	55.53	59.83
	Compressors power input (kW)	9.69	9.86	10.02	10.27	10.69	10.94
20 °C / 40 %	Heating capacity (kW)	40.26	42.75	46.03	49.9	55.42	59.72
	Compressors power input (kW)	10.11	10.27	10.44	10.6	11.10	11.43
22 °C / 40 %	Heating capacity (kW)	40.38	42.75	46.03	49.88	55.31	59.60
	Compressors power input (kW)	10.52	10.69	10.94	11.18	11.60	11.93

# Units Performance Data - RT4D 140

Summer performances		Size : RT4D 140					
Outdoor air percentage = 0%		Outdoor temperature (dry bulb °C)					
Indoor conditions (Dry bulb °C / Wet bulb °C)		25	30	32	35	38	40
24 °C / 18 °C	Cooling capacity (kW)	75.1	72.7	71.7	70.2	68.4	67.1
	Compressors power input (kW)	16.3	18.3	19.2	20.6	22	23
26 °C / 19.5 °C	Cooling capacity (kW)	79.1	76.6	75.5	73.7	71.9	70.7
	Compressors power input (kW)	16.5	18.5	19.4	20.8	22.3	23.3
29 °C / 22 °C	Cooling capacity (kW)	85.8	82.9	81.7	79.8	77.9	76.6
	compressors power input (kW)	16.8	18.9	19.8	21.2	22.7	23.8
31 °C / 24 °C	Cooling capacity (kW)	91.1	88.1	86.8	84.9	82.8	81.4
	Compressors power input (kW)	17	19.2	20.1	21.5	23.1	24.1
Winter performances		Size : RT4D 140					
Outdoor air percentage = 0%		Outdoor temperature (dry bulb °C)					
Indoor conditions (Dry bulb temp. °C / Relative humidity %)		-7	-3	0	3	7	10
16 °C / 40 %	Heating capacity (kW)	51.9	54.4	58.1	63	70	75.6
	Compressors power input (kW)	14.9	15.1	15.4	15.9	16.6	17.2
18 °C / 40 %	Heating capacity (kW)	51.9	54.4	58.2	63	70	75.5
	Compressors power input (kW)	15.5	15.8	16.2	16.7	17.4	18
20 °C / 40 %	Heating capacity (kW)	51.9	54.4	58.2	63.0	70	75.4
	Compressors power input (kW)	16.3	16.5	16.9	17.4	18.2	18.9
22 °C / 40 %	Heating capacity (kW)	51.9	54.5	58.3	63	69.9	75.3
	Compressors power input (kW)	17	17.3	17.6	18.3	19.1	19.7

Summer performances		Size : RT4D 140					
Outdoor air percentage = 25%		Outdoor temperature (dry bulb °C)					
Indoor conditions (Dry bulb °C / Wet bulb °C)		25	30	32	35	38	40
24 °C / 18 °C	Cooling capacity (kW)	81.6	79.0	77.9	76.2	74.3	72.9
	Compressors power input (kW)	15.60	17.51	18.37	19.71	21.05	22.01
26 °C / 19.5 °C	Cooling capacity (kW)	85.9	83.2	82.0	80.0	78.1	76.8
	Compressors power input (kW)	15.79	17.70	18.56	19.9	21.34	22.30
29 °C / 22 °C	Cooling capacity (kW)	93.2	90.0	88.7	86.7	84.6	83.2
	Compressors power input (kW)	16.08	18.09	18.95	20.29	21.72	22.78
31 °C / 24 °C	Cooling capacity (kW)	98.9	95.7	94.3	92.2	89.9	88.4
	Compressors power input (kW)	16.27	18.37	19.23	20.57	22.11	23.06
Winter performances		Size : RT4D 140					
Outdoor air percentage = 25%		Outdoor temperature (dry bulb °C)					
Indoor conditions (Dry bulb temp. °C / Relative humidity %)		-7	-3	0	3	7	10
16 °C / 40 %	Heating capacity (kW)	54.60	57.23	61.12	66.28	73.64	79.53
	Compressors power input (kW)	13.96	14.15	14.43	14.90	15.56	16.12
18 °C / 40 %	Heating capacity (kW)	54.60	57.23	61.23	66.28	73.64	79.43
	Compressors power input (kW)	14.53	14.81	15.18	15.65	16.31	16.87
20 °C / 40 %	Heating capacity (kW)	54.60	57.23	61.23	66.3	73.64	79.32
	Compressors power input (kW)	15.28	15.46	15.84	16.3	17.06	17.71
22 °C / 40 %	Heating capacity (kW)	54.60	57.33	61.33	66.28	73.53	79.22
	Compressors power input (kW)	15.93	16.21	16.49	17.15	17.90	18.46

# Units Performance Data - RT4D 140 (continued)

Summer performances		Size : RT4D 140					
Outdoor air percentage = 40%		Outdoor temperature (dry bulb °C)					
Indoor conditions (Dry bulb °C / Wet bulb °C)		25	30	32	35	38	40
24 °C / 18 °C	Cooling capacity (kW)	85.5	82.7	81.6	79.9	77.8	76.4
	Compressors power input (kW)	15.44	17.33	18.18	19.51	20.83	21.78
26 °C / 19.5 °C	Cooling capacity (kW)	90.0	87.2	85.9	<b>83.9</b>	81.8	80.5
	Compressors power input (kW)	15.63	17.52	18.37	<b>19.7</b>	21.12	22.06
29 °C / 22 °C	Cooling capacity (kW)	97.6	94.3	93.0	90.8	88.7	87.2
	compressors power input (kW)	15.91	17.90	18.75	20.08	21.50	22.54
31 °C / 24 °C	Cooling capacity (kW)	103.7	100.3	98.8	96.6	94.2	92.6
	Compressors power input (kW)	16.10	18.18	19.03	20.36	21.88	22.82
Winter performances		Size : RT4D 140					
Outdoor air percentage = 40%		Outdoor temperature (dry bulb °C)					
Indoor conditions (Dry bulb temp. °C / Relative humidity %)		-7	-3	0	3	7	10
16 °C / 40 %	Heating capacity (kW)	56.42	59.13	63.15	68.48	76.09	82.18
	Compressors power input (kW)	13.28	13.46	13.73	14.17	14.80	15.33
18 °C / 40 %	Heating capacity (kW)	56.42	59.13	63.26	68.48	76.09	82.07
	Compressors power input (kW)	13.81	14.08	14.44	14.88	15.51	16.04
20 °C / 40 %	Heating capacity (kW)	56.42	59.13	63.26	68.5	<b>76.09</b>	81.96
	Compressors power input (kW)	14.53	14.71	15.06	15.5	<b>16.22</b>	16.84
22 °C / 40 %	Heating capacity (kW)	56.42	59.24	63.37	68.48	75.98	81.85
	Compressors power input (kW)	15.15	15.42	15.69	16.31	17.02	17.56

Summer performances		Size : RT4D 140					
Outdoor air percentage = 60%		Outdoor temperature (dry bulb °C)					
Indoor conditions (Dry bulb °C / Wet bulb °C)		25	30	32	35	38	40
24 °C / 18 °C	Cooling capacity (kW)	90.9	88.0	86.8	84.9	82.8	81.2
	Compressors power input (kW)	15.29	17.17	18.01	19.32	20.64	21.58
26 °C / 19.5 °C	Cooling capacity (kW)	95.7	92.7	91.4	89.2	87.0	85.5
	Compressors power input (kW)	15.48	17.35	18.20	19.5	20.92	21.86
29 °C / 22 °C	Cooling capacity (kW)	103.8	100.3	98.9	96.6	94.3	92.7
	Compressors power input (kW)	15.76	17.73	18.57	19.89	21.29	22.33
31 °C / 24 °C	Cooling capacity (kW)	110.2	106.6	105.0	102.7	100.2	98.5
	Compressors power input (kW)	15.95	18.01	18.86	20.17	21.67	22.61
Winter performances		Size : RT4D 140					
Outdoor air percentage = 60%		Outdoor temperature (dry bulb °C)					
Indoor conditions (Dry bulb temp. °C / Relative humidity %)		-7	-3	0	3	7	10
16 °C / 40 %	Heating capacity (kW)	58.70	61.53	65.71	71.25	79.17	85.50
	Compressors power input (kW)	12.60	12.76	13.02	13.44	14.03	14.54
18 °C / 40 %	Heating capacity (kW)	58.70	61.53	65.82	71.25	79.17	85.39
	Compressors power input (kW)	13.10	13.36	13.69	14.12	14.71	15.22
20 °C / 40 %	Heating capacity (kW)	58.70	61.53	65.82	71.3	79.17	85.28
	Compressors power input (kW)	13.78	13.95	14.29	14.7	15.38	15.98
22 °C / 40 %	Heating capacity (kW)	58.70	61.64	65.94	71.25	79.06	85.16
	Compressors power input (kW)	14.37	14.62	14.88	15.47	16.15	16.65

# Units Performance Data - RT4D 180

Summer performances		Size : RT4D 180					
Outdoor air percentage = 0%		Outdoor temperature (dry bulb °C)					
Indoor conditions (Dry bulb °C / Wet bulb °C)		25	30	32	35	38	40
24 °C / 18 °C	Cooling capacity (kW)	92.8	90	88.7	86.7	84.7	83.4
	Compressors power input (kW)	21.2	23.5	24.5	26.2	27.9	29.2
26 °C / 19.5 °C	Cooling capacity (kW)	97.7	94.6	93.3	91.3	89.3	87.8
	Compressors power input (kW)	21.4	23.8	24.9	26.5	28.3	29.6
29 °C / 22 °C	Cooling capacity (kW)	105.8	102.6	101.3	99.2	97	95.5
	compressors power input (kW)	21.9	24.3	25.4	27.1	29	30.3
31 °C / 24 °C	Cooling capacity (kW)	112.7	109.3	107.9	105.6	103.3	101.7
	Compressors power input (kW)	22.3	24.8	25.9	27.6	29.5	30.9
Winter performances		Size : RT4D 180					
Outdoor air percentage = 0%		Outdoor temperature (dry bulb °C)					
Indoor conditions (Dry bulb temp. °C / Relative humidity %)		-7	-3	0	3	7	10
16 °C / 40 %	Heating capacity (kW)	65.4	67.9	71.8	76.9	84.8	91.2
	Compressors power input (kW)	19.3	19.5	19.8	20.2	20.9	21.5
18 °C / 40 %	Heating capacity (kW)	65.6	68.1	71.9	77	84.8	91.2
	Compressors power input (kW)	20.1	20.3	20.6	21	21.7	22.4
20 °C / 40 %	Heating capacity (kW)	65.8	68.3	72.1	77.1	84.8	91.1
	Compressors power input (kW)	20.9	21.1	21.4	22	22.6	23.3
22 °C / 40 %	Heating capacity (kW)	66	68.4	72.2	77.2	84.8	91
	Compressors power input (kW)	21.7	21.9	22.3	22.7	23.6	24.3

Summer performances		Size : RT4D 180					
Outdoor air percentage = 25%		Outdoor temperature (dry bulb °C)					
Indoor conditions (Dry bulb °C / Wet bulb °C)		25	30	32	35	38	40
24 °C / 18 °C	Cooling capacity (kW)	100.8	97.7	96.3	94.2	92.0	90.6
	Compressors power input (kW)	19.45	21.56	22.48	24.04	25.60	26.79
26 °C / 19.5 °C	Cooling capacity (kW)	106.1	102.7	101.3	99.2	97.0	95.4
	Compressors power input (kW)	19.63	21.83	22.84	24.3	25.96	27.16
29 °C / 22 °C	Cooling capacity (kW)	114.9	111.4	110.0	107.7	105.3	103.7
	Compressors power input (kW)	20.09	22.29	23.30	24.86	26.61	27.80
31 °C / 24 °C	Cooling capacity (kW)	122.4	118.7	117.2	114.7	112.2	110.4
	Compressors power input (kW)	20.46	22.75	23.76	25.32	27.06	28.35
Winter performances		Size : RT4D 180					
Outdoor air percentage = 25%		Outdoor temperature (dry bulb °C)					
Indoor conditions (Dry bulb temp. °C / Relative humidity %)		-7	-3	0	3	7	10
16 °C / 40 %	Heating capacity (kW)	68.60	71.23	75.32	80.67	88.96	95.67
	Compressors power input (kW)	18.17	18.36	18.64	19.02	19.68	20.24
18 °C / 40 %	Heating capacity (kW)	68.81	71.44	75.42	80.77	88.96	95.67
	Compressors power input (kW)	18.93	19.11	19.40	19.77	20.43	21.09
20 °C / 40 %	Heating capacity (kW)	69.02	71.65	75.63	80.9	88.96	95.56
	Compressors power input (kW)	19.68	19.87	20.15	20.7	21.28	21.94
22 °C / 40 %	Heating capacity (kW)	69.23	71.75	75.74	80.98	88.96	95.46
	Compressors power input (kW)	20.43	20.62	21.00	21.37	22.22	22.88

# Units Performance Data - RT4D 180 (continued)

Summer performances		Size : RT4D 180					
Outdoor air percentage = 40%		Outdoor temperature (dry bulb °C)					
Indoor conditions (Dry bulb °C / Wet bulb °C)		25	30	32	35	38	40
24 °C / 18 °C	Cooling capacity (kW)	105.6	102.4	100.9	98.7	96.4	94.9
	Compressors power input (kW)	19.29	21.38	22.29	23.84	25.39	26.57
26 °C / 19.5 °C	Cooling capacity (kW)	111.2	107.7	106.2	<b>103.9</b>	101.6	99.9
	Compressors power input (kW)	19.47	21.66	22.66	<b>24.1</b>	25.75	26.93
29 °C / 22 °C	Cooling capacity (kW)	120.4	116.8	115.3	112.9	110.4	108.7
	compressors power input (kW)	19.93	22.11	23.11	24.66	26.39	27.57
31 °C / 24 °C	Cooling capacity (kW)	128.3	124.4	122.8	120.2	117.6	115.7
	Compressors power input (kW)	20.29	22.57	23.57	25.11	26.84	28.12
Winter performances		Size : RT4D 180					
Outdoor air percentage = 40%		Outdoor temperature (dry bulb °C)					
Indoor conditions (Dry bulb temp. °C / Relative humidity %)		-7	-3	0	3	7	10
16 °C / 40 %	Heating capacity (kW)	70.57	73.26	77.47	82.98	91.50	98.40
	Compressors power input (kW)	17.37	17.55	17.82	18.18	18.81	19.35
18 °C / 40 %	Heating capacity (kW)	70.78	73.48	77.58	83.08	91.50	98.40
	Compressors power input (kW)	18.09	18.27	18.54	18.90	19.53	20.16
20 °C / 40 %	Heating capacity (kW)	71.00	73.70	77.80	83.2	<b>91.50</b>	98.30
	Compressors power input (kW)	18.81	18.99	19.26	19.8	<b>20.34</b>	20.97
22 °C / 40 %	Heating capacity (kW)	71.21	73.80	77.90	83.30	91.50	98.19
	Compressors power input (kW)	19.53	19.71	20.07	20.43	21.24	21.87

Summer performances		Size : RT4D 180					
Outdoor air percentage = 60%		Outdoor temperature (dry bulb °C)					
Indoor conditions (Dry bulb °C / Wet bulb °C)		25	30	32	35	38	40
24 °C / 18 °C	Cooling capacity (kW)	112.1	108.7	107.1	104.7	102.3	100.7
	Compressors power input (kW)	19.20	21.29	22.19	23.73	25.27	26.45
26 °C / 19.5 °C	Cooling capacity (kW)	118.0	114.3	112.7	110.3	107.9	106.1
	Compressors power input (kW)	19.38	21.56	22.55	24.0	25.63	26.81
29 °C / 22 °C	Cooling capacity (kW)	127.8	123.9	122.4	119.8	117.2	115.4
	Compressors power input (kW)	19.84	22.01	23.01	24.55	26.27	27.45
31 °C / 24 °C	Cooling capacity (kW)	136.1	132.0	130.3	127.6	124.8	122.9
	Compressors power input (kW)	20.20	22.46	23.46	25.00	26.72	27.99
Winter performances		Size : RT4D 180					
Outdoor air percentage = 60%		Outdoor temperature (dry bulb °C)					
Indoor conditions (Dry bulb temp. °C / Relative humidity %)		-7	-3	0	3	7	10
16 °C / 40 %	Heating capacity (kW)	72.92	75.71	80.06	85.74	94.55	101.69
	Compressors power input (kW)	16.58	16.75	17.01	17.35	17.96	18.47
18 °C / 40 %	Heating capacity (kW)	73.14	75.93	80.17	85.86	94.55	101.69
	Compressors power input (kW)	17.27	17.44	17.70	18.04	18.64	19.24
20 °C / 40 %	Heating capacity (kW)	73.37	76.15	80.39	86.0	94.55	101.58
	Compressors power input (kW)	17.96	18.13	18.38	18.9	19.42	20.02
22 °C / 40 %	Heating capacity (kW)	73.59	76.27	80.50	86.08	94.55	101.47
	Compressors power input (kW)	18.64	18.81	19.16	19.50	20.27	20.88

# Units Performance Data - RT4D 240

Summer performances		Size : RT4D 240					
Outdoor air percentage = 0%		Outdoor temperature (dry bulb °C)					
Indoor conditions (Dry bulb °C / Wet bulb °C)		25	30	32	35	38	40
24 °C / 18 °C	Cooling capacity (kW)	135.80	131.4	129.5	126.3	122.9	120.9
	Compressors power input (kW)	29.2	32.8	34.4	36.9	39.4	41.2
26 °C / 19.5 °C	Cooling capacity (kW)	143	138.3	136.4	133	129.5	127.4
	Compressors power input (kW)	29.5	33.1	34.6	37	39.6	41.5
29 °C / 22 °C	Cooling capacity (kW)	154.9	149.5	147.3	144	140.5	138.2
	compressors power input (kW)	29.9	33.6	35.2	37.7	40.3	42.2
31 °C / 24 °C	Cooling capacity (kW)	164.2	158.7	156.4	152.9	149.3	146.7
	Compressors power input (kW)	30.3	34.1	35.7	38.2	40.9	42.8
Winter performances		Size : RT4D 240					
Outdoor air percentage = 0%		Outdoor temperature (dry bulb °C)					
Indoor conditions (Dry bulb temp. °C / Relative humidity %)		-7	-3	0	3	7	10
16 °C / 40 %	Heating capacity (kW)	92.2	97.8	105.1	113.9	126.6	136.6
	Compressors power input (kW)	27.4	27.9	28.5	29.3	30.5	31.4
18 °C / 40 %	Heating capacity (kW)	92.2	97.8	105.1	113.8	126.4	136.3
	Compressors power input (kW)	28.6	29.1	29.8	30.6	31.9	32.9
20 °C / 40 %	Heating capacity (kW)	92.2	97.8	105.2	113.8	126.2	136
	Compressors power input (kW)	29.9	30.5	31.1	32.1	33.3	34.4
22 °C / 40 %	Heating capacity (kW)	92.2	97.9	105.2	113.8	126.1	135.8
	Compressors power input (kW)	31.2	31.7	32.5	33.4	34.8	36

Summer performances		Size : RT4D 240					
Outdoor air percentage = 25%		Outdoor temperature (dry bulb °C)					
Indoor conditions (Dry bulb °C / Wet bulb °C)		25	30	32	35	38	40
24 °C / 18 °C	Cooling capacity (kW)	147.2	142.4	140.4	136.9	133.2	131.1
	Compressors power input (kW)	28.43	31.94	33.50	35.93	38.36	40.12
26 °C / 19.5 °C	Cooling capacity (kW)	155.0	149.9	147.9	144.2	140.4	138.1
	Compressors power input (kW)	28.72	32.23	33.69	36.0	38.56	40.41
29 °C / 22 °C	Cooling capacity (kW)	167.9	162.1	159.7	156.1	152.3	149.8
	Compressors power input (kW)	29.11	32.72	34.27	36.71	39.24	41.09
31 °C / 24 °C	Cooling capacity (kW)	178.0	172.0	169.5	165.7	161.8	159.0
	Compressors power input (kW)	29.50	33.20	34.76	37.20	39.82	41.67
Winter performances		Size : RT4D 240					
Outdoor air percentage = 25%		Outdoor temperature (dry bulb °C)					
Indoor conditions (Dry bulb temp. °C / Relative humidity %)		-7	-3	0	3	7	10
16 °C / 40 %	Heating capacity (kW)	97.18	103.08	110.78	120.05	133.44	143.98
	Compressors power input (kW)	25.28	25.74	26.29	27.03	28.14	28.97
18 °C / 40 %	Heating capacity (kW)	97.18	103.08	110.78	119.95	133.23	143.66
	Compressors power input (kW)	26.38	26.85	27.49	28.23	29.43	30.35
20 °C / 40 %	Heating capacity (kW)	97.18	103.08	110.88	120	133.01	143.34
	Compressors power input (kW)	27.58	28.14	28.69	29.6	30.72	31.73
22 °C / 40 %	Heating capacity (kW)	97.18	103.19	110.88	119.95	132.91	143.13
	Compressors power input (kW)	28.78	29.24	29.98	30.81	32.10	33.21



# Units Performance Data - RT4D 240 (continued)

Summer performances		Size : RT4D 240					
Outdoor air percentage = 40%		Outdoor temperature (dry bulb °C)					
Indoor conditions (Dry bulb °C / Wet bulb °C)		25	30	32	35	38	40
24 °C / 18 °C	Cooling capacity (kW)	153.9	148.9	146.7	143.1	139.2	137.0
	Compressors power input (kW)	28.24	31.72	33.27	35.69	38.10	39.85
26 °C / 19.5 °C	Cooling capacity (kW)	162.0	156.7	154.5	<b>150.7</b>	146.7	144.3
	Compressors power input (kW)	28.53	32.01	33.46	<b>35.8</b>	38.30	40.14
29 °C / 22 °C	Cooling capacity (kW)	175.5	169.4	166.9	163.2	159.2	156.6
	compressors power input (kW)	28.92	32.50	34.04	36.46	38.97	40.81
31 °C / 24 °C	Cooling capacity (kW)	186.0	179.8	177.2	173.2	169.2	166.2
	Compressors power input (kW)	29.30	32.98	34.53	36.94	39.56	41.39
Winter performances		Size : RT4D 240					
Outdoor air percentage = 40%		Outdoor temperature (dry bulb °C)					
Indoor conditions (Dry bulb temp. °C / Relative humidity %)		-7	-3	0	3	7	10
16 °C / 40 %	Heating capacity (kW)	100.31	106.41	114.35	123.92	137.74	148.62
	Compressors power input (kW)	24.25	24.69	25.22	25.93	26.99	27.79
18 °C / 40 %	Heating capacity (kW)	100.31	106.41	114.35	123.81	137.52	148.29
	Compressors power input (kW)	25.31	25.75	26.37	27.08	28.23	29.12
20 °C / 40 %	Heating capacity (kW)	100.31	106.41	114.46	123.8	<b>137.31</b>	147.97
	Compressors power input (kW)	26.46	26.99	27.52	28.4	<b>29.47</b>	30.44
22 °C / 40 %	Heating capacity (kW)	100.31	106.52	114.46	123.81	137.20	147.75
	Compressors power input (kW)	27.61	28.05	28.76	29.56	30.80	31.86

Summer performances		Size : RT4D 240					
Outdoor air percentage = 60%		Outdoor temperature (dry bulb °C)					
Indoor conditions (Dry bulb °C / Wet bulb °C)		25	30	32	35	38	40
24 °C / 18 °C	Cooling capacity (kW)	163.4	158.1	155.8	151.9	147.8	145.4
	Compressors power input (kW)	28.10	31.57	33.11	35.51	37.92	39.65
26 °C / 19.5 °C	Cooling capacity (kW)	172.0	166.4	164.1	160.0	155.8	153.3
	Compressors power input (kW)	28.39	31.86	33.30	35.6	38.11	39.94
29 °C / 22 °C	Cooling capacity (kW)	186.3	179.8	177.2	173.2	169.0	166.3
	Compressors power input (kW)	28.78	32.34	33.88	36.28	38.79	40.62
31 °C / 24 °C	Cooling capacity (kW)	197.5	190.9	188.1	183.9	179.6	176.5
	Compressors power input (kW)	29.16	32.82	34.36	36.77	39.36	41.19
Winter performances		Size : RT4D 240					
Outdoor air percentage = 60%		Outdoor temperature (dry bulb °C)					
Indoor conditions (Dry bulb temp. °C / Relative humidity %)		-7	-3	0	3	7	10
16 °C / 40 %	Heating capacity (kW)	104.55	110.91	119.18	129.16	143.56	154.90
	Compressors power input (kW)	22.89	23.31	23.81	24.48	25.48	26.23
18 °C / 40 %	Heating capacity (kW)	104.55	110.91	119.18	129.05	143.34	154.56
	Compressors power input (kW)	23.89	24.31	24.90	25.56	26.65	27.49
20 °C / 40 %	Heating capacity (kW)	104.55	110.91	119.30	129.0	143.11	154.22
	Compressors power input (kW)	24.98	25.48	25.98	26.8	27.82	28.74
22 °C / 40 %	Heating capacity (kW)	104.55	111.02	119.30	129.05	143.00	154.00
	Compressors power input (kW)	26.07	26.48	27.15	27.90	29.07	30.08

# Units Performance Data - RT4D 280

Summer performances		Size : RT4D 280					
Outdoor air percentage = 0%		Outdoor temperature (dry bulb °C)					
Indoor conditions (Dry bulb °C / Wet bulb °C)		25	30	32	35	38	40
24 °C / 18 °C	Cooling capacity (kW)	148.60	143.9	142	138.9	135.7	133.5
	Compressors power input (kW)	31.3	35.2	36.9	39.6	42.4	44.4
26 °C / 19.5 °C	Cooling capacity (kW)	156.5	151.5	149.4	146.2	142.8	140.4
	Compressors power input (kW)	31.6	35.6	37.3	40	42.8	44.8
29 °C / 22 °C	Cooling capacity (kW)	170.1	164.7	162.4	158.9	154.3	151.9
	compressors power input (kW)	32.2	36.2	37.9	40.6	43.5	45.4
31 °C / 24 °C	Cooling capacity (kW)	180.9	175.3	172.9	168.8	164.7	162
	Compressors power input (kW)	32.5	36.5	38.2	40.9	43.8	45.8
Winter performances		Size : RT4D 280					
Outdoor air percentage = 0%		Outdoor temperature (dry bulb °C)					
Indoor conditions (Dry bulb temp. °C / Relative humidity %)		-7	-3	0	3	7	10
16 °C / 40 %	Heating capacity (kW)	102.5	108.5	116.7	126.6	140.7	151.8
	Compressors power input (kW)	29.7	30.3	31	31.9	33.3	34.4
18 °C / 40 %	Heating capacity (kW)	102.5	108.4	116.7	126.5	140.5	151.4
	Compressors power input (kW)	31.1	31.6	32.4	33.4	34.9	36
20 °C / 40 %	Heating capacity (kW)	102.5	108.5	116.7	126.5	140.3	151.1
	Compressors power input (kW)	32.5	33.1	33.9	34.9	36.4	37.7
22 °C / 40 %	Heating capacity (kW)	102.5	108.5	116.8	126.5	140.2	150.9
	Compressors power input (kW)	33.9	34.6	35.4	36.5	38.1	39.4

Summer performances		Size : RT4D 280					
Outdoor air percentage = 25%		Outdoor temperature (dry bulb °C)					
Indoor conditions (Dry bulb °C / Wet bulb °C)		25	30	32	35	38	40
24 °C / 18 °C	Cooling capacity (kW)	162.6	157.4	155.3	152.0	148.5	146.0
	Compressors power input (kW)	31.14	35.02	36.72	39.40	42.19	44.18
26 °C / 19.5 °C	Cooling capacity (kW)	171.2	165.7	163.4	160	156.2	153.6
	Compressors power input (kW)	31.44	35.42	37.11	39.8	42.59	44.58
29 °C / 22 °C	Cooling capacity (kW)	186.1	180.2	177.7	173.8	168.8	166.2
	Compressors power input (kW)	32.04	36.02	37.71	40.40	43.28	45.17
31 °C / 24 °C	Cooling capacity (kW)	197.9	191.8	189.2	184.7	180.2	177.2
	Compressors power input (kW)	32.34	36.32	38.01	40.70	43.58	45.57
Winter performances		Size : RT4D 280					
Outdoor air percentage = 25%		Outdoor temperature (dry bulb °C)					
Indoor conditions (Dry bulb temp. °C / Relative humidity %)		-7	-3	0	3	7	10
16 °C / 40 %	Heating capacity (kW)	107.22	113.49	122.07	132.42	147.17	158.78
	Compressors power input (kW)	27.65	28.21	28.86	29.70	31.01	32.03
18 °C / 40 %	Heating capacity (kW)	107.22	113.39	122.07	132.32	146.96	158.36
	Compressors power input (kW)	28.96	29.42	30.17	31.10	32.50	33.52
20 °C / 40 %	Heating capacity (kW)	107.22	113.49	122.07	132.3	146.75	158.05
	Compressors power input (kW)	30.26	30.82	31.56	32.5	33.89	35.10
22 °C / 40 %	Heating capacity (kW)	107.22	113.49	122.17	132.32	146.65	157.84
	Compressors power input (kW)	31.56	32.22	32.96	33.99	35.47	36.69

# Units Performance Data - RT4D 280 (continued)

Summer performances		Size : RT4D 280					
Outdoor air percentage = 40%		Outdoor temperature (dry bulb °C)					
Indoor conditions (Dry bulb °C / Wet bulb °C)		25	30	32	35	38	40
24 °C / 18 °C	Cooling capacity (kW)	170.3	164.9	162.7	159.2	155.5	153.0
	Compressors power input (kW)	30.84	34.68	36.35	39.01	41.77	43.74
26 °C / 19.5 °C	Cooling capacity (kW)	179.3	173.6	171.2	<b>167.5</b>	163.6	160.9
	Compressors power input (kW)	31.13	35.07	36.75	<b>39.4</b>	42.17	44.14
29 °C / 22 °C	Cooling capacity (kW)	194.9	188.7	186.1	182.1	176.8	174.1
	compressors power input (kW)	31.72	35.67	37.34	40.00	42.86	44.73
31 °C / 24 °C	Cooling capacity (kW)	207.3	200.9	198.1	193.4	188.7	185.7
	Compressors power input (kW)	32.02	35.96	37.64	40.30	43.15	45.12
Winter performances		Size : RT4D 280					
Outdoor air percentage = 40%		Outdoor temperature (dry bulb °C)					
Indoor conditions (Dry bulb temp. °C / Relative humidity %)		-7	-3	0	3	7	10
16 °C / 40 %	Heating capacity (kW)	110.50	116.96	125.80	136.47	151.67	163.64
	Compressors power input (kW)	26.47	27.01	27.63	28.43	29.68	30.66
18 °C / 40 %	Heating capacity (kW)	110.50	116.86	125.80	136.37	151.46	163.21
	Compressors power input (kW)	27.72	28.16	28.88	29.77	31.11	32.09
20 °C / 40 %	Heating capacity (kW)	110.50	116.96	125.80	136.4	<b>151.24</b>	162.89
	Compressors power input (kW)	28.97	29.50	30.21	31.1	<b>32.44</b>	33.60
22 °C / 40 %	Heating capacity (kW)	110.50	116.96	125.91	136.37	151.14	162.67
	Compressors power input (kW)	30.21	30.84	31.55	32.53	33.96	35.12

Summer performances		Size : RT4D 280					
Outdoor air percentage = 60%		Outdoor temperature (dry bulb °C)					
Indoor conditions (Dry bulb °C / Wet bulb °C)		25	30	32	35	38	40
24 °C / 18 °C	Cooling capacity (kW)	180.3	174.6	172.2	168.5	164.6	161.9
	Compressors power input (kW)	30.45	34.24	35.89	38.52	41.25	43.19
26 °C / 19.5 °C	Cooling capacity (kW)	189.8	183.8	181.2	177.3	173.2	170.3
	Compressors power input (kW)	30.74	34.63	36.28	38.9	41.63	43.58
29 °C / 22 °C	Cooling capacity (kW)	206.3	199.8	197.0	192.7	187.2	184.3
	Compressors power input (kW)	31.32	35.21	36.87	39.49	42.32	44.16
31 °C / 24 °C	Cooling capacity (kW)	219.4	212.6	209.7	204.8	199.8	196.5
	Compressors power input (kW)	31.61	35.51	37.16	39.79	42.61	44.55
Winter performances		Size : RT4D 280					
Outdoor air percentage = 60%		Outdoor temperature (dry bulb °C)					
Indoor conditions (Dry bulb temp. °C / Relative humidity %)		-7	-3	0	3	7	10
16 °C / 40 %	Heating capacity (kW)	115.01	121.74	130.94	142.05	157.87	170.32
	Compressors power input (kW)	25.02	25.53	26.12	26.87	28.05	28.98
18 °C / 40 %	Heating capacity (kW)	115.01	121.62	130.94	141.93	157.64	169.87
	Compressors power input (kW)	26.20	26.62	27.30	28.14	29.40	30.33
20 °C / 40 %	Heating capacity (kW)	115.01	121.74	130.94	141.9	157.42	169.53
	Compressors power input (kW)	27.38	27.89	28.56	29.4	30.67	31.76
22 °C / 40 %	Heating capacity (kW)	115.01	121.74	131.05	141.93	157.30	169.31
	Compressors power input (kW)	28.56	29.15	29.82	30.75	32.10	33.19

# Units Performance Data - RT4D 380

Summer performances		Size : RT4D 380					
Outdoor air percentage = 0%		Outdoor temperature (dry bulb °C)					
Indoor conditions (Dry bulb °C / Wet bulb °C)		25	30	32	35	38	40
24 °C / 18 °C	Cooling capacity (kW)	182.70	177.8	175.7	172.4	168.9	166.5
	Compressors power input (kW)	40	44.5	46.4	49.5	52.7	55
26 °C / 19.5 °C	Cooling capacity (kW)	192.3	187.2	185.1	181.8	178	175.5
	Compressors power input (kW)	40.4	44.9	46.9	50	53.4	55.7
29 °C / 22 °C	Cooling capacity (kW)	209.3	203.8	201.5	197.8	193.9	191.2
	compressors power input (kW)	41.2	45.8	47.8	51	54.4	56.9
31 °C / 24 °C	Cooling capacity (kW)	223.5	217.7	215.2	211.3	207.2	204.3
	Compressors power input (kW)	41.8	46.4	48.5	51.7	55.2	57.7
Winter performances		Size : RT4D 380					
Outdoor air percentage = 0%		Outdoor temperature (dry bulb °C)					
Indoor conditions (Dry bulb temp. °C / Relative humidity %)		-7	-3	0	3	7	10
16 °C / 40 %	Heating capacity (kW)	129.1	135.6	144.4	154.9	170.3	182.9
	Compressors power input (kW)	39.9	40.6	41.6	42.9	45	46.8
18 °C / 40 %	Heating capacity (kW)	129.4	135.9	144.6	154.9	170.2	182.7
	Compressors power input (kW)	41.5	42.2	43.3	44.7	46.9	48.9
20 °C / 40 %	Heating capacity (kW)	129.7	136.1	144.7	154.9	170.1	182.5
	Compressors power input (kW)	43.1	43.9	45	46.5	48.9	51
22 °C / 40 %	Heating capacity (kW)	129.9	136.2	144.8	155	170	182.3
	Compressors power input (kW)	44.7	45.6	46.8	48.4	50.9	53.2

Summer performances		Size : RT4D 380					
Outdoor air percentage = 25%		Outdoor temperature (dry bulb °C)					
Indoor conditions (Dry bulb °C / Wet bulb °C)		25	30	32	35	38	40
24 °C / 18 °C	Cooling capacity (kW)	199.5	194.2	191.9	188.3	184.4	181.8
	Compressors power input (kW)	39.29	43.71	45.58	48.62	51.77	54.03
26 °C / 19.5 °C	Cooling capacity (kW)	210.0	204.4	202.1	198.5	194.4	191.6
	Compressors power input (kW)	39.69	44.11	46.07	49.1	52.46	54.72
29 °C / 22 °C	Cooling capacity (kW)	228.6	222.5	220.0	216.0	211.7	208.8
	Compressors power input (kW)	40.47	44.99	46.95	50.10	53.44	55.89
31 °C / 24 °C	Cooling capacity (kW)	244.1	237.7	235.0	230.7	226.3	223.1
	Compressors power input (kW)	41.06	45.58	47.64	50.79	54.22	56.68
Winter performances		Size : RT4D 380					
Outdoor air percentage = 25%		Outdoor temperature (dry bulb °C)					
Indoor conditions (Dry bulb temp. °C / Relative humidity %)		-7	-3	0	3	7	10
16 °C / 40 %	Heating capacity (kW)	135.30	142.11	151.33	162.34	178.47	191.68
	Compressors power input (kW)	35.53	36.15	37.04	38.20	40.07	41.67
18 °C / 40 %	Heating capacity (kW)	135.61	142.42	151.54	162.3	178.37	191.47
	Compressors power input (kW)	36.95	37.58	38.56	39.80	41.76	43.54
20 °C / 40 %	Heating capacity (kW)	135.93	142.63	151.65	162.3	178.26	191.26
	Compressors power input (kW)	38.38	39.09	40.07	41.4	43.54	45.41
22 °C / 40 %	Heating capacity (kW)	136.14	142.74	151.75	162.44	178.16	191.05
	Compressors power input (kW)	39.80	40.61	41.67	43.10	45.33	47.37

# Units Performance Data - RT4D 380 (continued)

Summer performances		Size : RT4D 380					
Outdoor air percentage = 40%		Outdoor temperature (dry bulb °C)					
Indoor conditions (Dry bulb °C / Wet bulb °C)		25	30	32	35	38	40
24 °C / 18 °C	Cooling capacity (kW)	208.8	203.2	200.8	197.1	193.1	190.3
	Compressors power input (kW)	39.22	43.63	45.49	48.53	51.67	53.92
26 °C / 19.5 °C	Cooling capacity (kW)	219.8	214.0	211.6	<b>207.8</b>	203.5	200.6
	Compressors power input (kW)	39.61	44.02	45.98	<b>49.0</b>	52.35	54.61
29 °C / 22 °C	Cooling capacity (kW)	239.2	232.9	230.3	226.1	221.6	218.5
	compressors power input (kW)	40.39	44.90	46.86	50.00	53.33	55.78
31 °C / 24 °C	Cooling capacity (kW)	255.5	248.8	246.0	241.5	236.8	233.5
	Compressors power input (kW)	40.98	45.49	47.55	50.69	54.12	56.57
Winter performances		Size : RT4D 380					
Outdoor air percentage = 40%		Outdoor temperature (dry bulb °C)					
Indoor conditions (Dry bulb temp. °C / Relative humidity %)		-7	-3	0	3	7	10
16 °C / 40 %	Heating capacity (kW)	139.04	146.04	155.52	166.83	183.41	196.98
	Compressors power input (kW)	34.16	34.76	35.62	36.73	38.53	40.07
18 °C / 40 %	Heating capacity (kW)	139.36	146.36	155.73	166.83	183.31	196.77
	Compressors power input (kW)	35.53	36.13	37.07	38.27	40.15	41.87
20 °C / 40 %	Heating capacity (kW)	139.69	146.58	155.84	166.8	<b>183.20</b>	196.55
	Compressors power input (kW)	36.90	37.59	38.53	39.8	<b>41.87</b>	43.66
22 °C / 40 %	Heating capacity (kW)	139.90	146.69	155.95	166.94	183.09	196.34
	Compressors power input (kW)	38.27	39.04	40.07	41.44	43.58	45.55

Summer performances		Size : RT4D 380					
Outdoor air percentage = 60%		Outdoor temperature (dry bulb °C)					
Indoor conditions (Dry bulb °C / Wet bulb °C)		25	30	32	35	38	40
24 °C / 18 °C	Cooling capacity (kW)	222.2	216.2	213.7	209.6	205.4	202.5
	Compressors power input (kW)	39.06	43.46	45.31	48.34	51.46	53.71
26 °C / 19.5 °C	Cooling capacity (kW)	233.8	227.6	225.1	221.1	216.4	213.4
	Compressors power input (kW)	39.45	43.85	45.80	48.8	52.15	54.39
29 °C / 22 °C	Cooling capacity (kW)	254.5	247.8	245.0	240.5	235.8	232.5
	Compressors power input (kW)	40.23	44.73	46.68	49.80	53.13	55.57
31 °C / 24 °C	Cooling capacity (kW)	271.8	264.7	261.7	256.9	252.0	248.4
	Compressors power input (kW)	40.82	45.31	47.36	50.49	53.91	56.35
Winter performances		Size : RT4D 380					
Outdoor air percentage = 60%		Outdoor temperature (dry bulb °C)					
Indoor conditions (Dry bulb temp. °C / Relative humidity %)		-7	-3	0	3	7	10
16 °C / 40 %	Heating capacity (kW)	144.08	151.33	161.15	172.87	190.05	204.12
	Compressors power input (kW)	32.52	33.09	33.90	34.96	36.67	38.14
18 °C / 40 %	Heating capacity (kW)	144.41	151.66	161.37	172.87	189.94	203.89
	Compressors power input (kW)	33.82	34.39	35.29	36.43	38.22	39.85
20 °C / 40 %	Heating capacity (kW)	144.75	151.89	161.49	172.9	189.83	203.67
	Compressors power input (kW)	35.13	35.78	36.67	37.9	39.85	41.56
22 °C / 40 %	Heating capacity (kW)	144.97	152.00	161.60	172.98	189.72	203.45
	Compressors power input (kW)	36.43	37.16	38.14	39.45	41.48	43.36

# Hot Water Coils Performance Data (Option)

Number of rows : 2

RT4D 20 Nominal air flow = 2 000 m <sup>3</sup> /h Water temperature in-out = 70 °C - 60 °C					
Outdoor temp. °C	Outdoor air % volume	Supply temp. °C	Heating capacity kW	Water flow rate m <sup>3</sup> /h.	Water pressure drop kPa
7	40%	43.3	17.7	1.6	18
3		41.1	19.2	1.7	21
-3		37.8	21.5	1.9	25
-7		35.4	23	2.1	28
RT4D 20 Nominal air flow = 2 000 m <sup>3</sup> /h Water temperature in-out = 60 °C - 50 °C					
Outdoor temp. °C	Outdoor air % volume	Supply temp. °C	Heating capacity kW	Water flow rate m <sup>3</sup> /h.	Water pressure drop kPa
7	40%	37.5	13.8	1.2	12
3		35.4	15.3	1.35	14
-3		32.1	17.6	1.55	18
-7		29.9	19.1	1.67	21

RT4D 80 Nominal air flow = 8 000 m <sup>3</sup> /h Water temperature in-out = 70 °C - 60 °C					
Outdoor temp. °C	Outdoor air % volume	Supply temp. °C	Heating capacity kW	Water flow rate m <sup>3</sup> /h.	Water pressure drop kPa
7	40%	37.5	55.2	4.9	12
3		35	60.1	5.3	14
-3		31.2	67.5	6	18
-7		28.5	72.5	6.4	20
RT4D 80 Nominal air flow = 8 000 m <sup>3</sup> /h Water temperature in-out = 60 °C - 50 °C					
Outdoor temp. °C	Outdoor air % volume	Supply temp. °C	Heating capacity kW	Water flow rate m <sup>3</sup> /h.	Water pressure drop kPa
7	40%	32.8	42.6	3.8	8
3		30.4	47.5	4.2	10
-3		26.6	54.9	4.8	12.5
-7		24.1	59.8	5.3	15

RT4D 40 Nominal air flow = 4 000 m <sup>3</sup> /h Water temperature in-out = 70 °C - 60 °C					
Outdoor temp. °C	Outdoor air % volume	Supply temp. °C	Heating capacity kW	Water flow rate m <sup>3</sup> /h.	Water pressure drop kPa
7	40%	36.7	26.5	2.4	12
3		34.1	28.8	2.55	14
-3		30.2	32.4	2.85	18
-7		27.5	34.8	3.1	20
RT4D 40 Nominal air flow = 4 000 m <sup>3</sup> /h. Water temperature in-out = 60 °C - 50 °C					
Outdoor temp. °C	Outdoor air % volume	Supply temp. °C	Heating capacity kW	Water flow rate m <sup>3</sup> /h.	Water pressure drop kPa
7	40%	32.1	20.3	1.78	8
3		29.6	22.7	2	10
-3		25.8	26.2	2.3	12
-7		23.2	28.7	2.55	14.5

RT4D 100 Nominal air flow = 10 000 m <sup>3</sup> /h Water temperature in-out = 70 °C - 60 °C					
Outdoor temp. °C	Outdoor air % volume	Supply temp. °C	Heating capacity kW	Water flow rate m <sup>3</sup> /h.	Water pressure drop kPa
7	40%	40.5	79	7	16
3		38.1	85.9	7.6	18
-3		34.5	96.2	8.5	23
-7		32.1	103	9.1	25
RT4D 100 Nominal air flow = 10 000 m <sup>3</sup> /h. Water temperature in-out = 60 °C - 50 °C					
Outdoor temp. °C	Outdoor air % volume	Supply temp. °C	Heating capacity kW	Water flow rate m <sup>3</sup> /h.	Water pressure drop kPa
7	40%	35.2	61.3	5.4	10
3		33	68.3	6	13
-3		29.5	78.6	6.9	16
-7		27.1	85.5	7.5	19

RT4D 60 Nominal air flow = 6 000 m <sup>3</sup> /h Water temperature in-out = 70 °C - 60 °C					
Outdoor temp. °C	Outdoor air % volume	Supply temp. °C	Heating capacity kW	Water flow rate m <sup>3</sup> /h.	Water pressure drop kPa
7	40%	40.2	46.9	4.2	15
3		37.9	51	4.5	17
-3		34.3	57.2	5.1	21
-7		31.8	61.3	5.4	24
RT4D 60 Nominal air flow = 6 000 m <sup>3</sup> /h. Water temperature in-out = 60 °C - 50 °C					
Outdoor temp. °C	Outdoor air % volume	Supply temp. °C	Heating capacity kW	Water flow rate m <sup>3</sup> /h.	Water pressure drop kPa
7	40%	35	36.4	3.2	10
3		32.8	40.5	3.6	12
-3		29.3	46.7	4.1	15
-7		26.8	50.8	4.5	17

RT4D 140 Nominal air flow = 14 000 m <sup>3</sup> /h Water temperature in-out = 70 °C - 60 °C					
Outdoor temp. °C	Outdoor air % volume	Supply temp. °C	Heating capacity kW	Water flow rate m <sup>3</sup> /h.	Water pressure drop kPa
7	40%	37.5	96.3	8.5	17
3		34.9	105	9.3	20
-3		31.1	118	10.5	24
-7		28.4	126	11.2	27
RT4D 140 Nominal air flow = 14 000 m <sup>3</sup> /h. Water temperature in-out = 60 °C - 50 °C					
Outdoor temp. °C	Outdoor air % volume	Supply temp. °C	Heating capacity kW	Water flow rate m <sup>3</sup> /h.	Water pressure drop kPa
7	40%	32.8	74.5	6.6	11
3		30.4	83	7.3	13
-3		26.6	95.8	8.5	17
-7		24	104	9.2	20

# Hot Water Coils Performance Data (Option) (continued)

Number of rows : 2

RT4D 180 Nominal air flow = 18 000 m <sup>3</sup> /h Water temperature in-out = 70 °C - 60 °C					
Outdoor temp. °C	Outdoor air % volume	Supply temp. °C	Heating capacity kW	Water flow rate m <sup>3</sup> /h.	Water pressure drop kPa
7	40%	37.6	125	11	15.5
3		35	135	12	18
-3		31.1	151	13.5	22
-7		28.4	162	14.5	25
RT4D 180 Nominal air flow = 18 000 m <sup>3</sup> /h Water temperature in-out = 60 °C - 50 °C					
Outdoor temp. °C	Outdoor air % volume	Supply temp. °C	Heating capacity kW	Water flow rate m <sup>3</sup> /h.	Water pressure drop kPa
7	40%	33.1	97.3	8.6	10.5
3		30.6	108	9.5	12.5
-3		26.7	124	11	16
-7		24.1	135	11.9	19

RT4D 280 Nominal air flow = 28 000 m <sup>3</sup> /h Water temperature in-out = 70 °C - 60 °C					
Outdoor temp. °C	Outdoor air % volume	Supply temp. °C	Heating capacity kW	Water flow rate m <sup>3</sup> /h.	Water pressure drop kPa
7	40%	39.2	209	18.4	14.5
3		36.7	227	20	17
-3		32.9	253	22.4	21
-7		30.3	271	24	23
RT4D 280 Nominal air flow = 28 000 m <sup>3</sup> /h. Water temperature in-out = 60 °C - 50 °C					
Outdoor temp. °C	Outdoor air % volume	Supply temp. °C	Heating capacity kW	Water flow rate m <sup>3</sup> /h.	Water pressure drop kPa
7	40%	34.4	163	14.5	10
3		32	181	16	12
-3		28.3	208	18.3	15
-7		25.7	226	20	17

RT4D 240 Nominal air flow = 24 000 m <sup>3</sup> /h Water temperature in-out = 70 °C - 60 °C					
Outdoor temp. °C	Outdoor air % volume	Supply temp. °C	Heating capacity kW	Water flow rate m <sup>3</sup> /h.	Water pressure drop kPa
7	40%	37.5	166	14.6	12
3		34.9	180	15.9	14
-3		31	201	17.8	17
-7		28.3	216	19	20
RT4D 240 Nominal air flow = 24 000 m <sup>3</sup> /h. Water temperature in-out = 60 °C - 50 °C					
Outdoor temp. °C	Outdoor air % volume	Supply temp. °C	Heating capacity kW	Water flow rate m <sup>3</sup> /h.	Water pressure drop kPa
7	40%	33	129	11.4	8
3		30.5	144	12.6	10
-3		26.7	165	14.5	13
-7		24.1	179	15.8	14.5

RT4D 380 Nominal air flow = 38 000 m <sup>3</sup> /h Water temperature in-out = 70 °C - 60 °C					
Outdoor temp. °C	Outdoor air % volume	Supply temp. °C	Heating capacity kW	Water flow rate m <sup>3</sup> /h.	Water pressure drop kPa
7	40%	36.4	248	21.9	18
3		33.8	270	23.8	21
-3		29.7	302	26.6	25
-7		27	323	28.5	28
RT4D 380 Nominal air flow = 38 000 m <sup>3</sup> /h Water temperature in-out = 60 °C - 50 °C					
Outdoor temp. °C	Outdoor air % volume	Supply temp. °C	Heating capacity kW	Water flow rate m <sup>3</sup> /h.	Water pressure drop kPa
7	40%	32.2	194	17	12
3		29.6	215	18.9	14
-3		25.6	247	21.7	18
-7		22.9	269	23.6	21

# Hot Water Coils Performance Data (Option) (continued)

Number of rows : 3

RT4D 20 Nominal air flow = 2 000 m <sup>3</sup> /h Water temperature in-out = 70 °C - 60 °C					
Outdoor temp. °C	Outdoor air % volume	Supply temp. °C	Heating capacity kW	Water flow rate m <sup>3</sup> /h.	Water pressure drop kPa
7	40%	51.1	22.9	2	13.5
3		49.4	24.9	2.2	16
-3		46.8	27.8	2.5	19
-7		44.9	29.8	2.65	21.5
RT4D 20 Nominal air flow = 2 000 m <sup>3</sup> /h Water temperature in-out = 60 °C - 50 °C					
Outdoor temp. °C	Outdoor air % volume	Supply temp. °C	Heating capacity kW	Water flow rate m <sup>3</sup> /h.	Water pressure drop kPa
7	40%	44.3	1834	1.6	9
3		42.1	19.9	1.75	11
-3		39.6	22.8	2	14
-7		37.9	24.8	2.2	16

RT4D 80 Nominal air flow = 8 000 m <sup>3</sup> /h Water temperature in-out = 70 °C - 60 °C					
Outdoor temp. °C	Outdoor air % volume	Supply temp. °C	Heating capacity kW	Water flow rate m <sup>3</sup> /h.	Water pressure drop kPa
7	40%	44.8	74.7	6.6	14
3		42.7	81.3	7.2	16
-3		39.6	91.1	8.1	20
-7		37.4	97.7	8.6	22
RT4D 80 Nominal air flow = 8 000 m <sup>3</sup> /h Water temperature in-out = 60 °C - 50 °C					
Outdoor temp. °C	Outdoor air % volume	Supply temp. °C	Heating capacity kW	Water flow rate m <sup>3</sup> /h.	Water pressure drop kPa
7	40%	38.6	58	5.1	9
3		36.6	64.5	5.7	11
-3		33.6	74.3	6.6	14
-7		31.5	80.9	7.1	16

RT4D 40 Nominal air flow = 4 000 m <sup>3</sup> /h Water temperature in-out = 70 °C - 60 °C					
Outdoor temp. °C	Outdoor air % volume	Supply temp. °C	Heating capacity kW	Water flow rate m <sup>3</sup> /h.	Water pressure drop kPa
7	40%	43.8	36	3.2	14
3		41.7	39.2	3.5	16
-3		38.4	44	3.9	20
-7		36.2	47.1	4.2	23
RT4D 40 Nominal air flow = 4 000 m <sup>3</sup> /h. Water temperature in-out = 60 °C - 50 °C					
Outdoor temp. °C	Outdoor air % volume	Supply temp. °C	Heating capacity kW	Water flow rate m <sup>3</sup> /h.	Water pressure drop kPa
7	40%	37.7	27.9	2.5	9
3		35.7	31	2.75	11
-3		32.6	35.8	3.15	14
-7		30.5	39	3.45	17

RT4D 100 Nominal air flow = 10 000 m <sup>3</sup> /h Water temperature in-out = 70 °C - 60 °C					
Outdoor temp. °C	Outdoor air % volume	Supply temp. °C	Heating capacity kW	Water flow rate m <sup>3</sup> /h.	Water pressure drop kPa
7	40%	48	104	9.2	13
3		46.1	113	10	15
-3		43.2	127	11.2	18
-7		41.2	136	12	20
RT4D 100 Nominal air flow = 10 000 m <sup>3</sup> /h. Water temperature in-out = 60 °C - 50 °C					
Outdoor temp. °C	Outdoor air % volume	Supply temp. °C	Heating capacity kW	Water flow rate m <sup>3</sup> /h.	Water pressure drop kPa
7	40%	41.2	81.2	7.2	8
3		39.4	90.2	8	10
-3		36.7	104	9.1	13
-7		34.8	113	10	15

RT4D 60 Nominal air flow = 6 000 m <sup>3</sup> /h Water temperature in-out = 70 °C - 60 °C					
Outdoor temp. °C	Outdoor air % volume	Supply temp. °C	Heating capacity kW	Water flow rate m <sup>3</sup> /h.	Water pressure drop kPa
7	40%	47.6	61.7	5.5	10
3		45.7	67.1	5.9	11
-3		42.8	75.1	6.6	14
-7		40.8	80.5	7.1	16
RT4D 60 Nominal air flow = 6 000 m <sup>3</sup> /h. Water temperature in-out = 60 °C - 50 °C					
Outdoor temp. °C	Outdoor air % volume	Supply temp. °C	Heating capacity kW	Water flow rate m <sup>3</sup> /h.	Water pressure drop kPa
7	40%	40.8	48	4.2	6.5
3		39	53.3	4.7	8
-3		36.3	61.4	5.4	10
-7		34.3	66.7	5.9	11.5

RT4D 140 Nominal air flow = 14 000 m <sup>3</sup> /h Water temperature in-out = 70 °C - 60 °C					
Outdoor temp. °C	Outdoor air % volume	Supply temp. °C	Heating capacity kW	Water flow rate m <sup>3</sup> /h.	Water pressure drop kPa
7	40%	44.7	130	11.5	19
3		42.7	142	12.5	22
-3		39.5	159	14	27
-7		37.3	170	15	30
RT4D 140 Nominal air flow = 14 000 m <sup>3</sup> /h. Water temperature in-out = 60 °C - 50 °C					
Outdoor temp. °C	Outdoor air % volume	Supply temp. °C	Heating capacity kW	Water flow rate m <sup>3</sup> /h.	Water pressure drop kPa
7	40%	38.6	101	8.9	12
3		36.6	113	10	15
-3		33.5	130	11.5	19
-7		31.4	141	12.5	22



# Hot Water Coils Performance Data (Option) (continued)

Number of rows : 3

RT4D 180 Nominal air flow = 18 000 m <sup>3</sup> /h Water temperature in-out = 70 °C - 60 °C					
Outdoor temp. °C	Outdoor air % volume	Supply temp. °C	Heating capacity kW	Water flow rate m <sup>3</sup> /h.	Water pressure drop kPa
7	40%	44.2	165	14.5	15
3		42	179	16	17
-3		38.7	200	17.6	21
-7		36.4	214	18.9	23
RT4D 180 Nominal air flow = 18 000 m <sup>3</sup> /h Water temperature in-out = 60 °C - 50 °C					
Outdoor temp. °C	Outdoor air % volume	Supply temp. °C	Heating capacity kW	Water flow rate m <sup>3</sup> /h.	Water pressure drop kPa
7	40%	38.3	129	11.4	10
3		36.3	143	12.6	12
-3		33.1	164	14.5	15
-7		30.9	178	15.7	17

RT4D 280 Nominal air flow = 28 000 m <sup>3</sup> /h Water temperature in-out = 70 °C - 60 °C					
Outdoor temp. °C	Outdoor air % volume	Supply temp. °C	Heating capacity kW	Water flow rate m <sup>3</sup> /h.	Water pressure drop kPa
7	40%	46.1	274	24.1	17
3		44	297	26.1	20
-3		40.8	331	29.2	24
-7		38.7	354	31.2	27
RT4D 280 Nominal air flow = 28 000 m <sup>3</sup> /h. Water temperature in-out = 60 °C - 50 °C					
Outdoor temp. °C	Outdoor air % volume	Supply temp. °C	Heating capacity kW	Water flow rate m <sup>3</sup> /h.	Water pressure drop kPa
7	40%	39.9	215	18.9	11
3		37.9	238	20.9	14
-3		34.9	273	24	17
-7		32.8	296	26	20

RT4D 240 Nominal air flow = 24 000 m <sup>3</sup> /h Water temperature in-out = 70 °C - 60 °C					
Outdoor temp. °C	Outdoor air % volume	Supply temp. °C	Heating capacity kW	Water flow rate m <sup>3</sup> /h.	Water pressure drop kPa
7	40%	44.3	220	19.4	17
3		42.1	239	21.1	20
-3		38.8	267	23.5	24
-7		36.5	285	25.1	27
RT4D 240 Nominal air flow = 24 000 m <sup>3</sup> /h. Water temperature in-out = 60 °C - 50 °C					
Outdoor temp. °C	Outdoor air % volume	Supply temp. °C	Heating capacity kW	Water flow rate m <sup>3</sup> /h.	Water pressure drop kPa
7	40%	38.4	173	15.2	12
3		36.4	191	16.8	14
-3		33.2	220	19.3	17
-7		31	238	20.9	20

RT4D 380 Nominal air flow = 38 000 m <sup>3</sup> /h Water temperature in-out = 70 °C - 60 °C					
Outdoor temp. °C	Outdoor air % volume	Supply temp. °C	Heating capacity kW	Water flow rate m <sup>3</sup> /h.	Water pressure drop kPa
7	40%	42.9	331	29.2	17
3		40.7	360	31.7	20
-3		37.3	402	35.4	24
-7		34.9	430	37.9	27
RT4D 380 Nominal air flow = 38 000 m <sup>3</sup> /h Water temperature in-out = 60 °C - 50 °C					
Outdoor temp. °C	Outdoor air % volume	Supply temp. °C	Heating capacity kW	Water flow rate m <sup>3</sup> /h.	Water pressure drop kPa
7	40%	37.3	260	22.8	11
3		35.2	288	25.3	14
-3		31.9	330	29	17
-7		29.6	359	31.5	20

# Supply Fan Curves

## RT4D 20

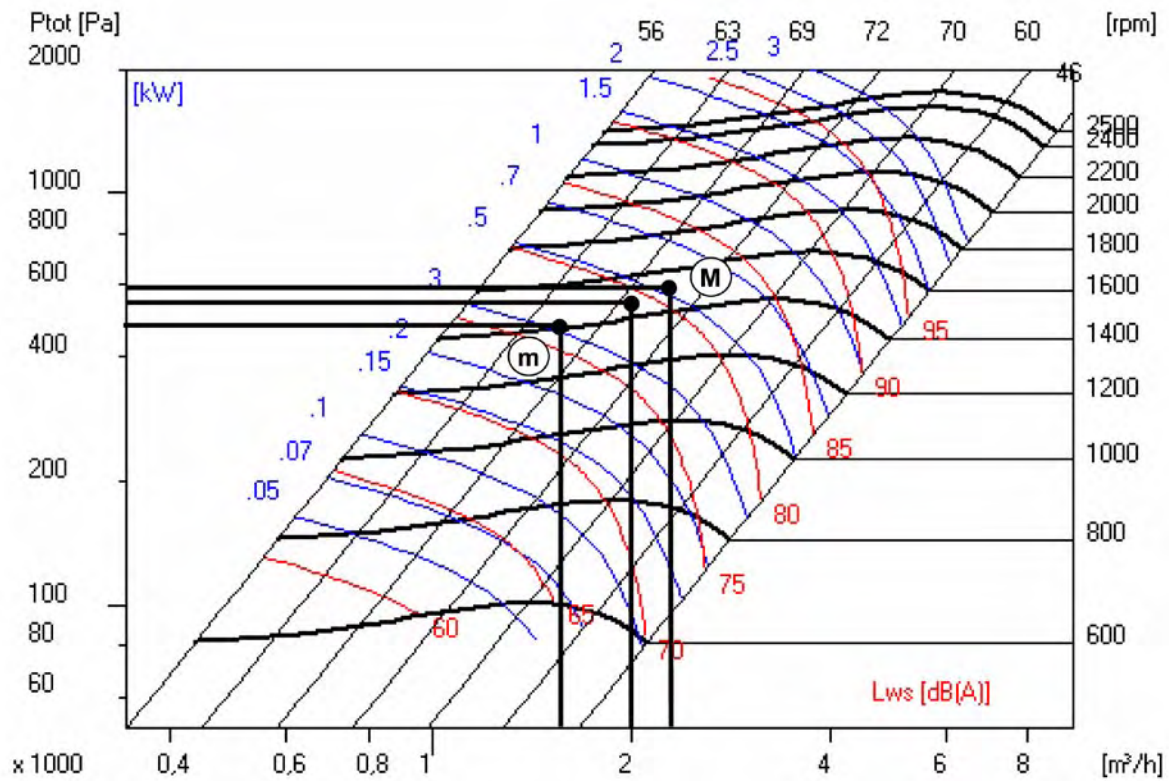

## RT4D 40

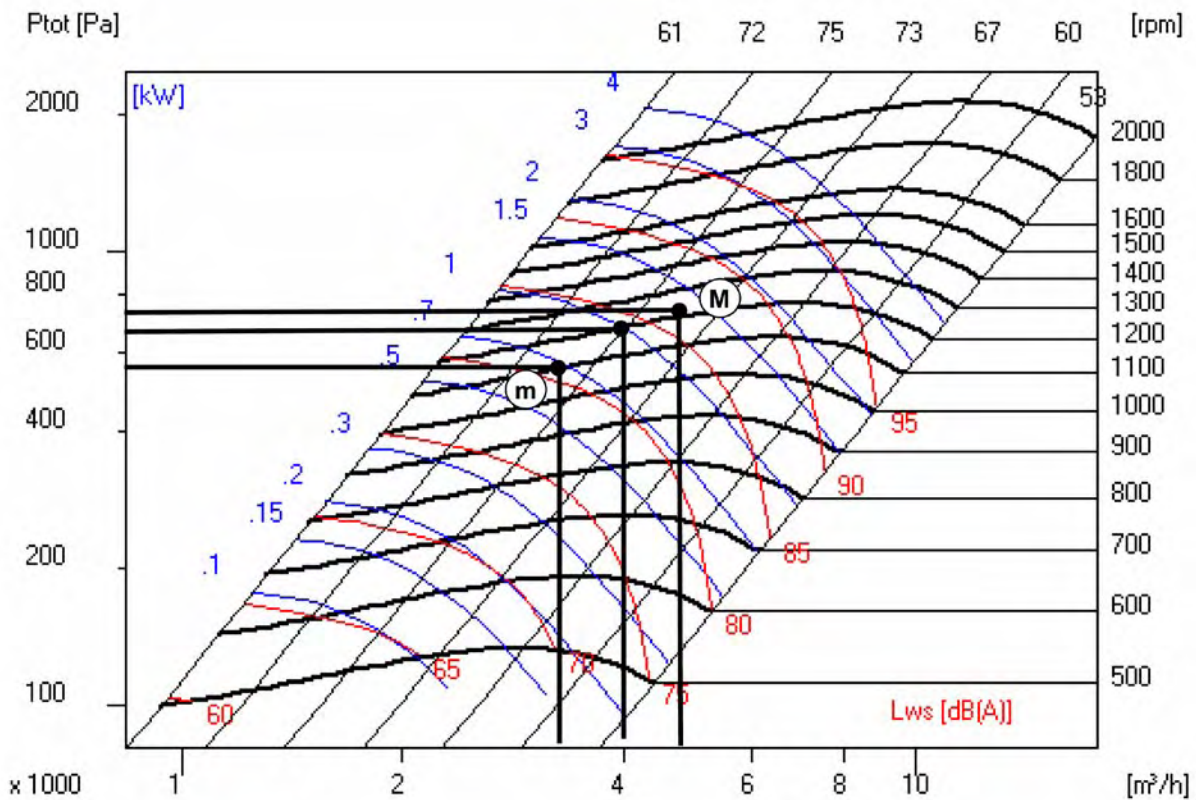

# Supply Fan Curves (continued)

## RT4D 60

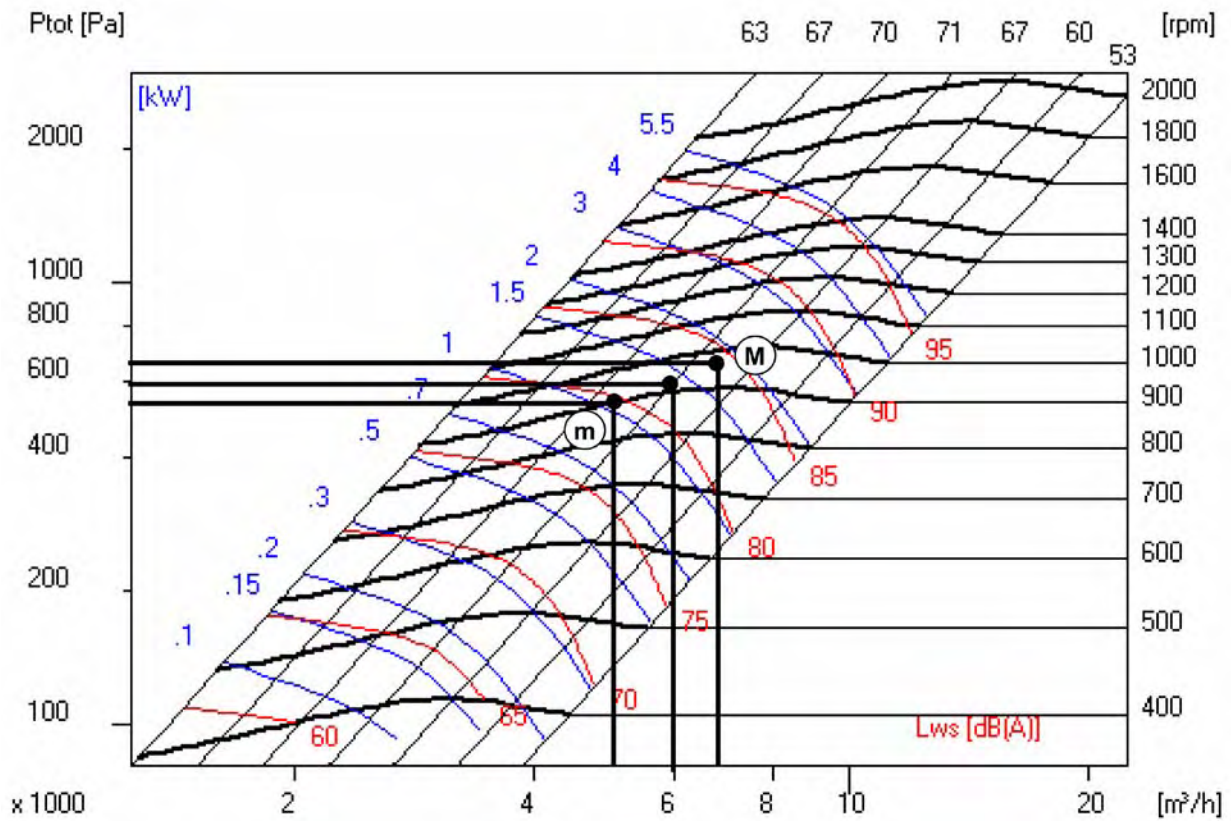

## RT4D 80

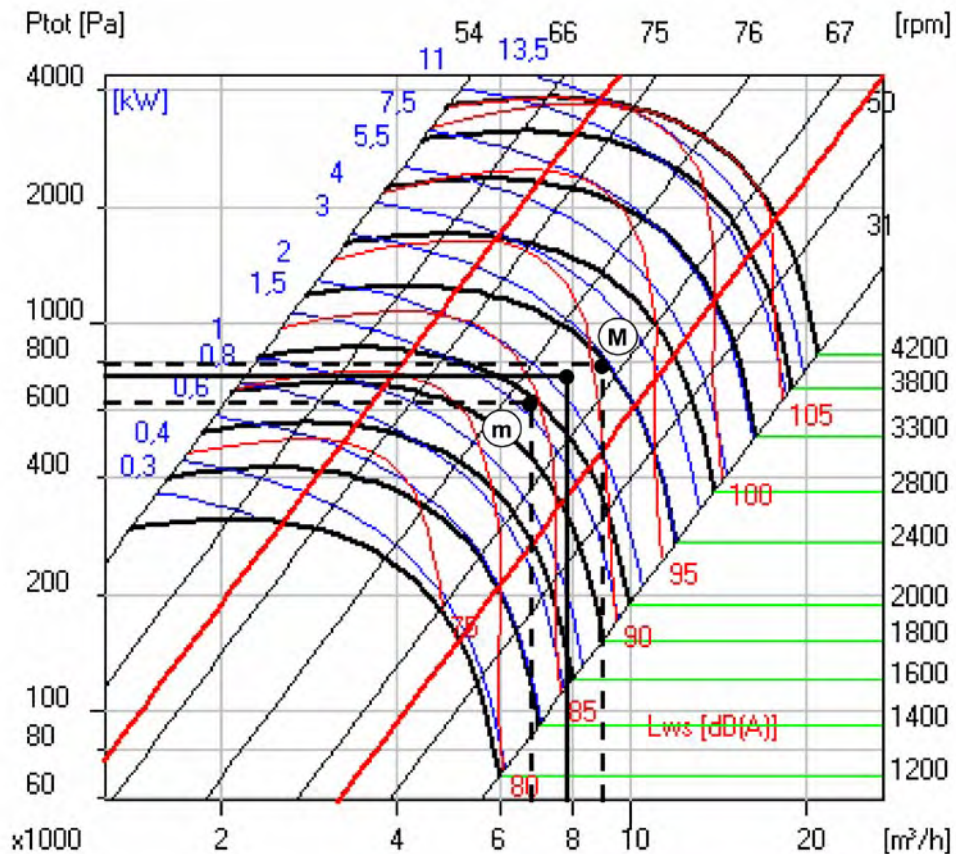

# Supply Fan Curves (continued)

## RT4D 100

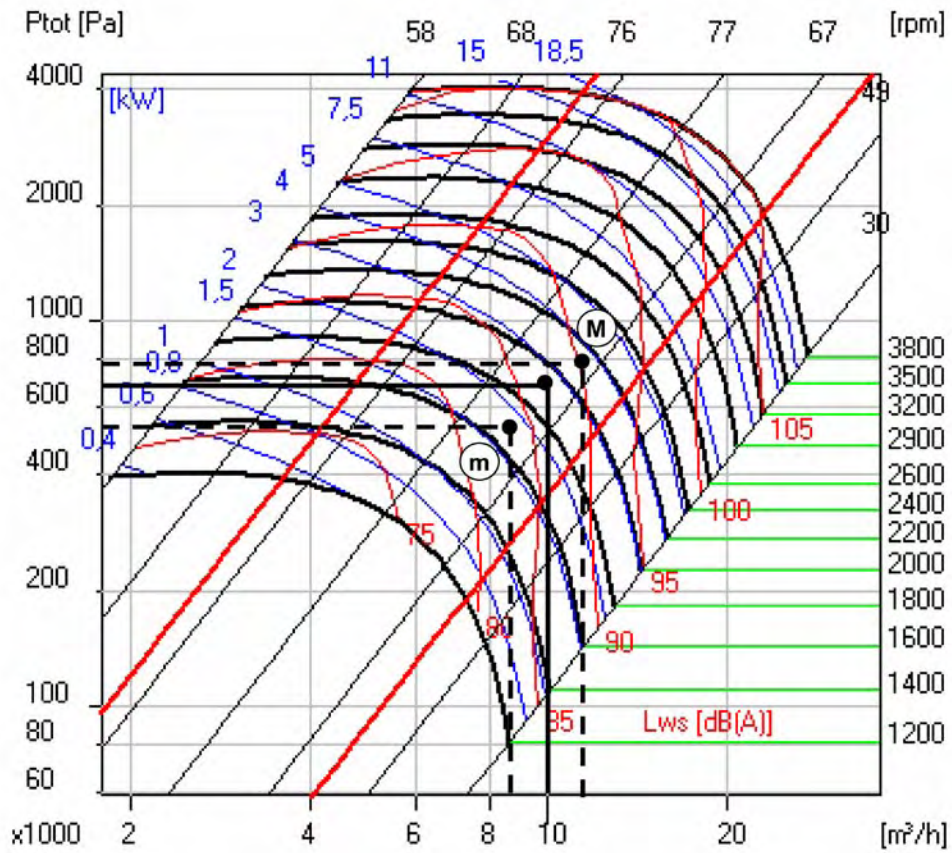

## RT4D 140

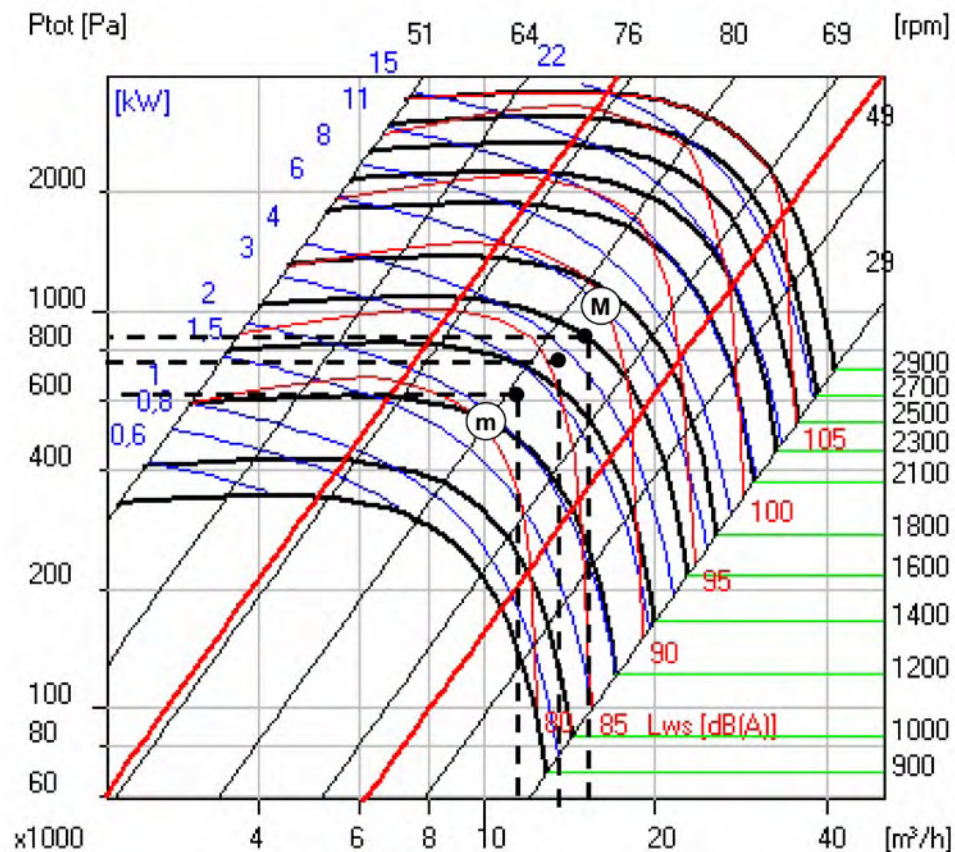

# Supply Fan Curves (continued)

## RT4D 180

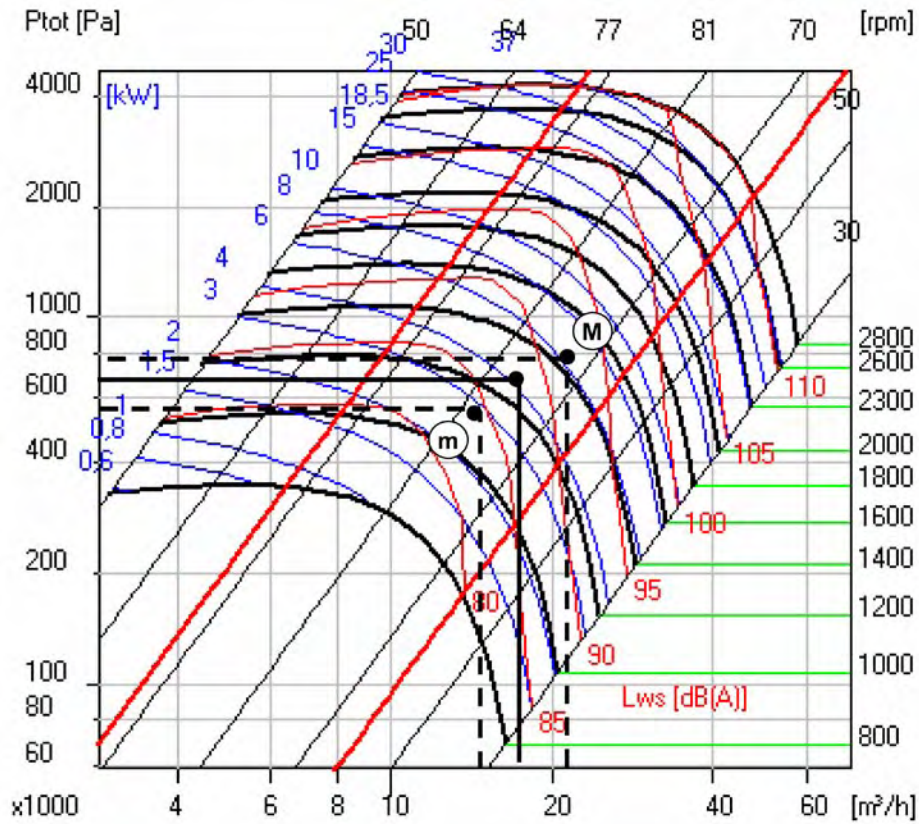

## RT4D 240

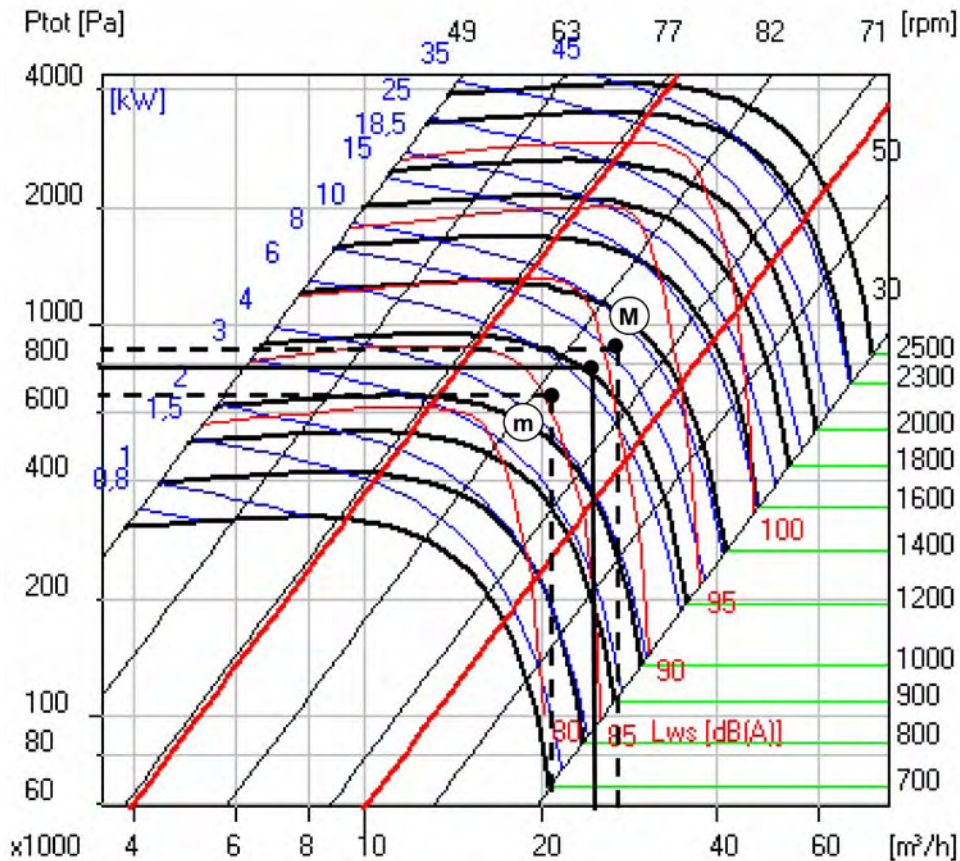

# Supply Fan Curves (continued)

**RT4D 280 (2 fans coupled in parallel)**

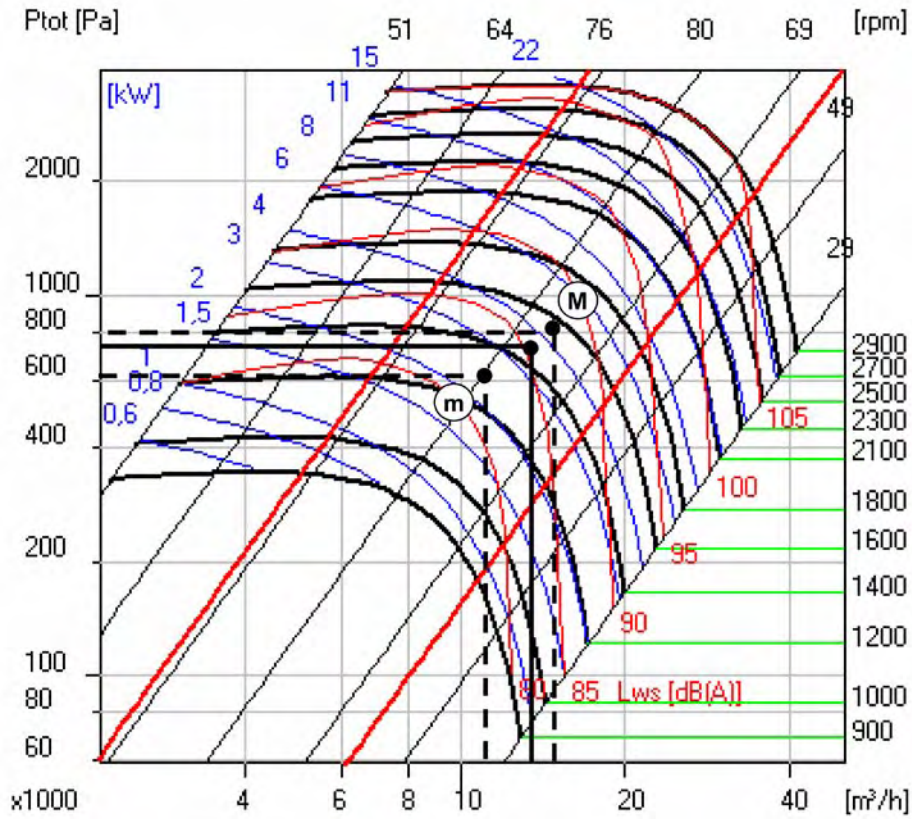

**RT4D 380 (2 fans coupled in parallel)**

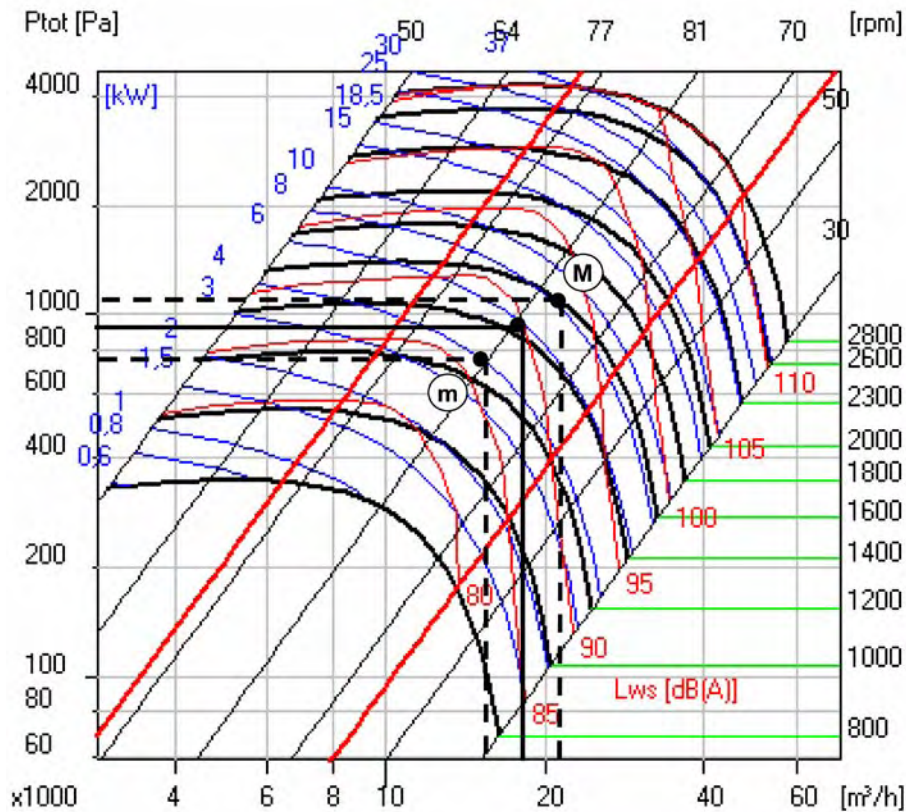

# Outdoor Fan Curves

## RT4D 20 and 40

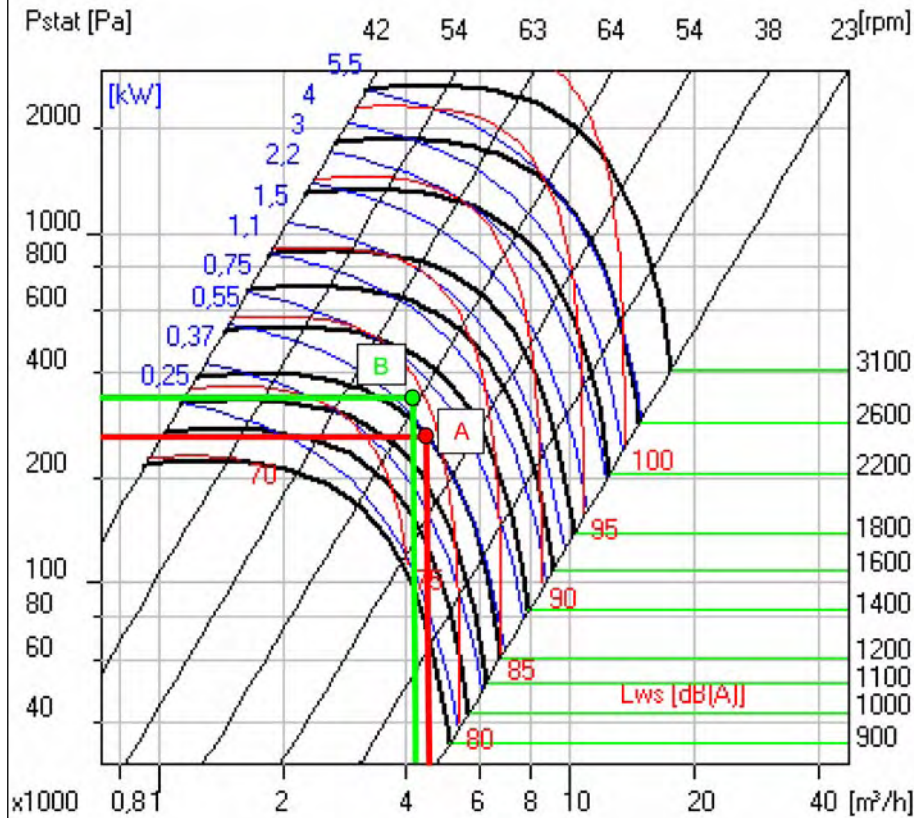

Size 20
1 x D.450 plugfan
Working point : 4600 m³/h / Pt = 260 Pa (point A)
Size 40
2 x D.450 plugfan
Working point : 4300 m³/h / Pt = 360 Pa (point B)

## RT4D 60

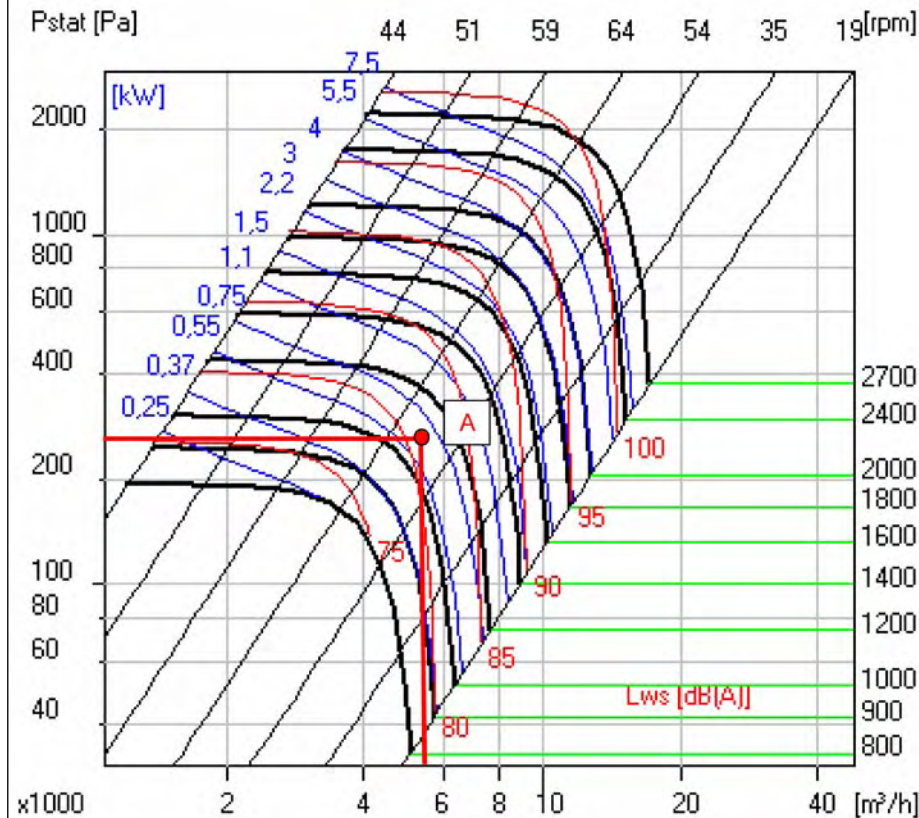

Size 60
2 x D.500 plugfan
Working point : 5600 m³/h / Pt = 270 Pa (point A)

# Outdoor Fan Curves (continued)

## RT4D 80 and 100

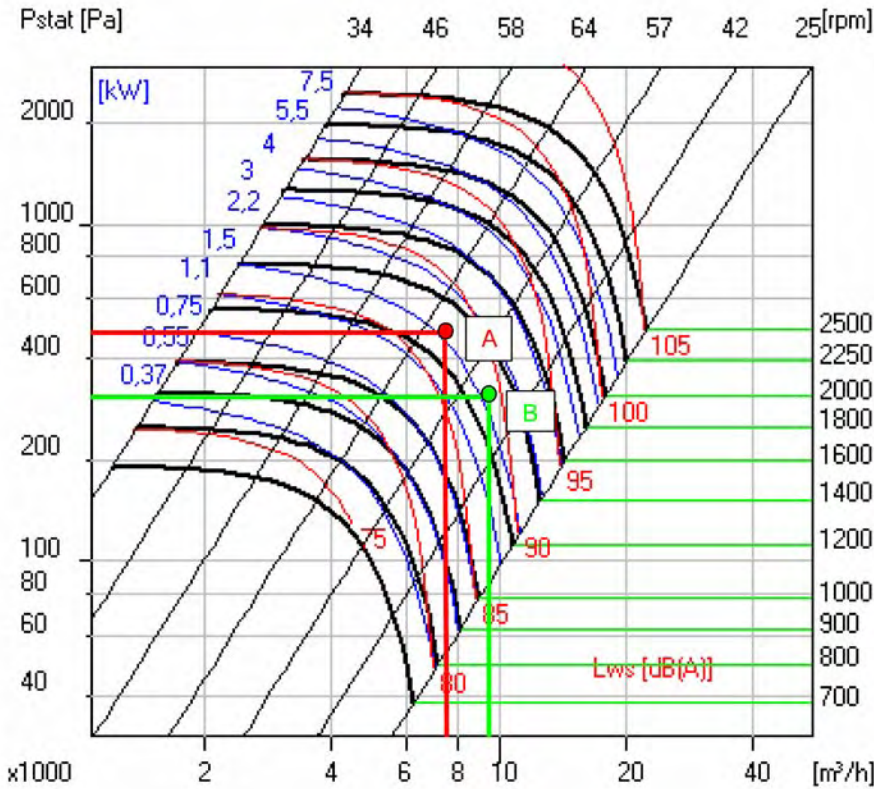

Size 80
2 x D.560 plugfan
Working point : 7800 m <sup>3</sup> /h / Pt = 465 Pa (point A)
Size 100
2 x D.560 plugfan
Working point : 9700 m <sup>3</sup> /h / Pt = 300 Pa (point B)

## RT4D 140 and 180

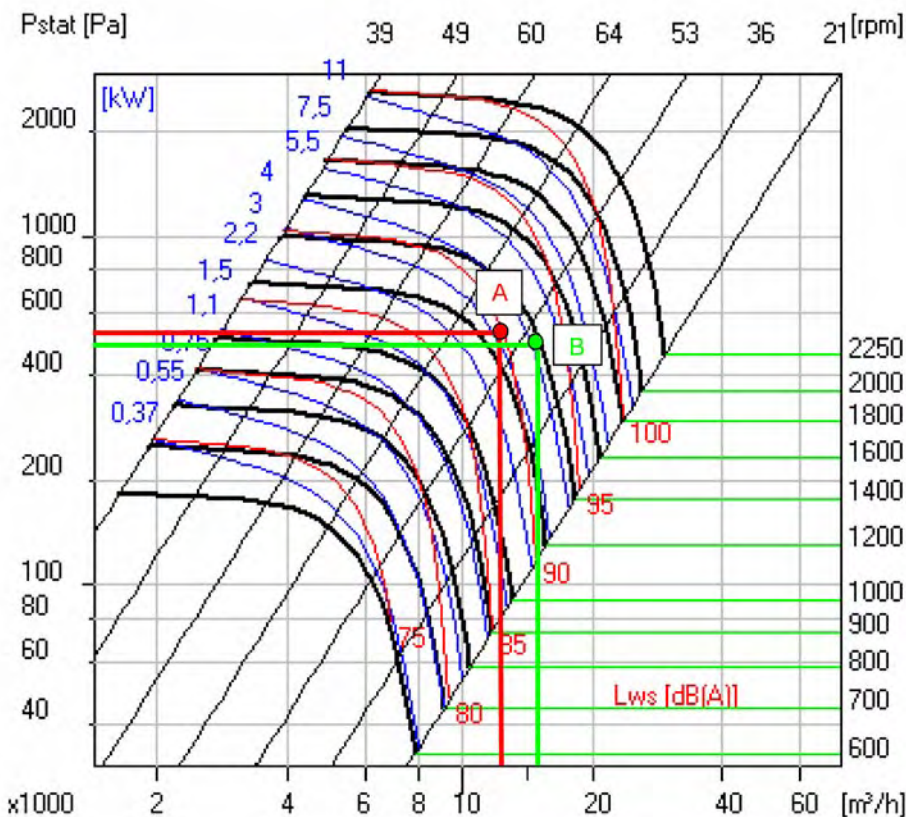

Size 140
2 x D.630 plugfan
Working point : 13200 m <sup>3</sup> /h / Pt = 570 Pa (point A)
Size 180
2 x D.630 plugfan
Working point : 15900 m <sup>3</sup> /h / Pt = 510 Pa (point B)



# Outdoor Fan Curves (continued)

## RT4D 240, 280 and 380

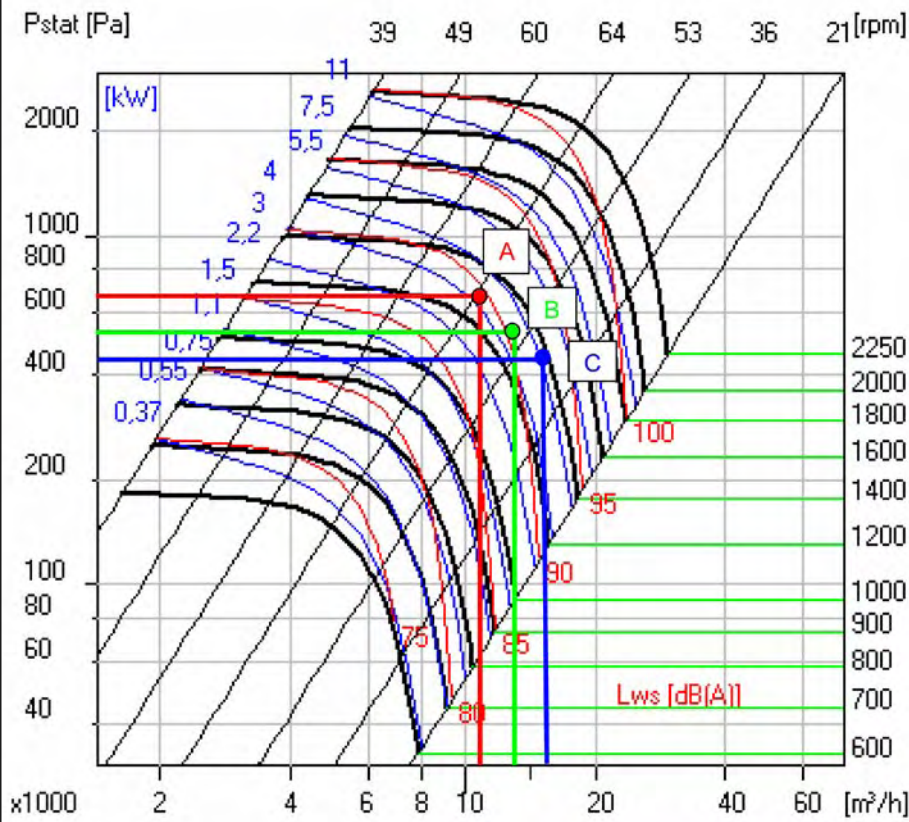

Size 240
4 x D.630 plugfan
Working point : 11000 m³/h / Pt = 630 Pa (point A)
Size 280
4 x D.630 plugfan
Working point : 14500 m³/h / Pt = 540 Pa (point B)
Size 380
4 x D.630 plugfan
Working point : 16200 m³/h / Pt = 420 Pa (point C)

# Component Air Pressure Drops

## Indoor G4 filter

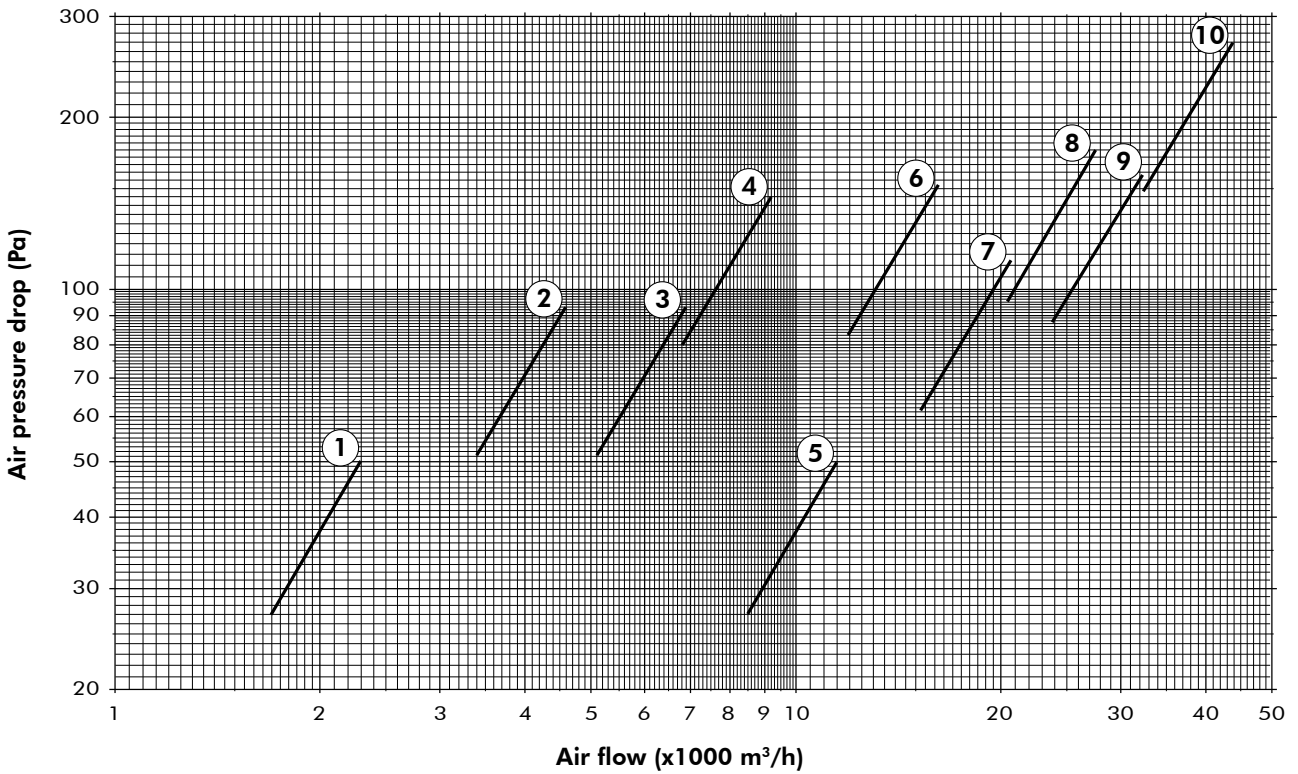

1	RT4D 20	6	RT4D 140
2	RT4D 40	7	RT4D 180
3	RT4D 60	8	RT4D 240
4	RT4D 80	9	RT4D 280
5	RT4D 100	10	RT4D 380

## Exhaust G4 filter

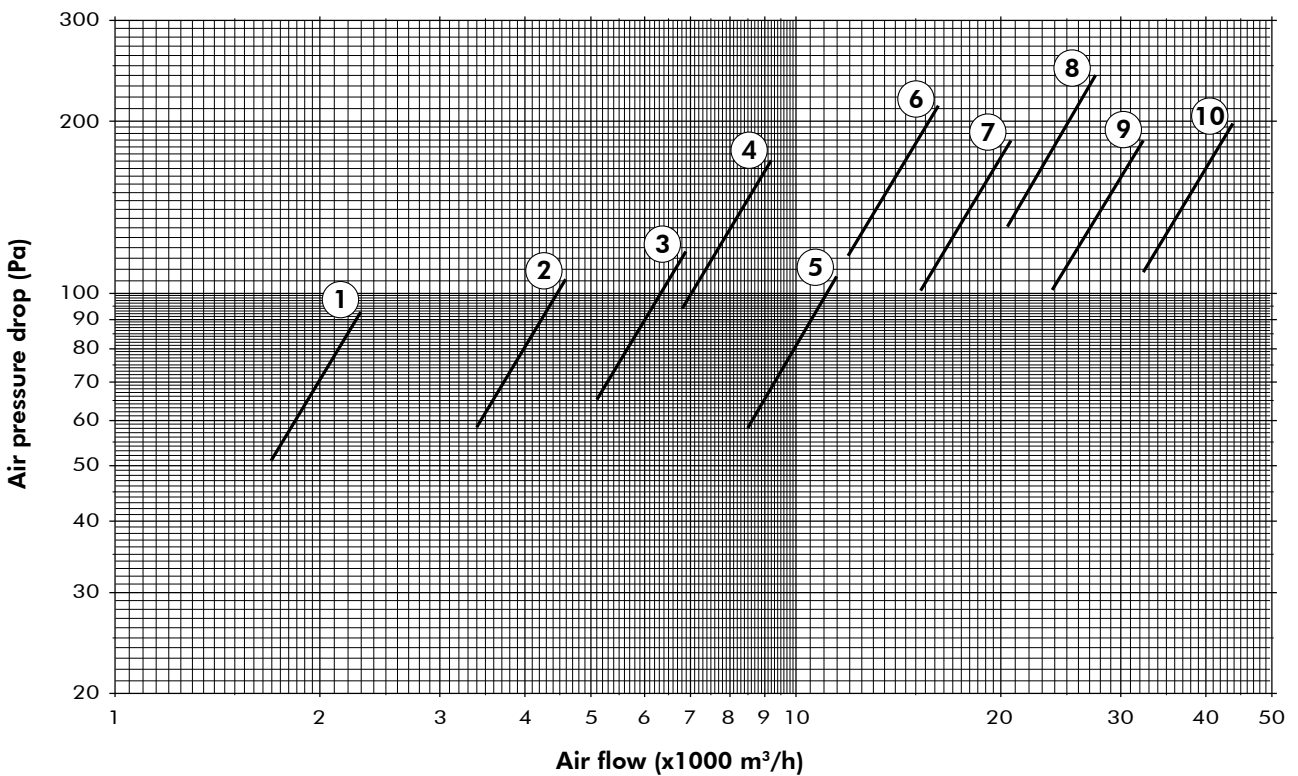

# Component Air Pressure Drops (continued)

## Indoor F7 bag filter

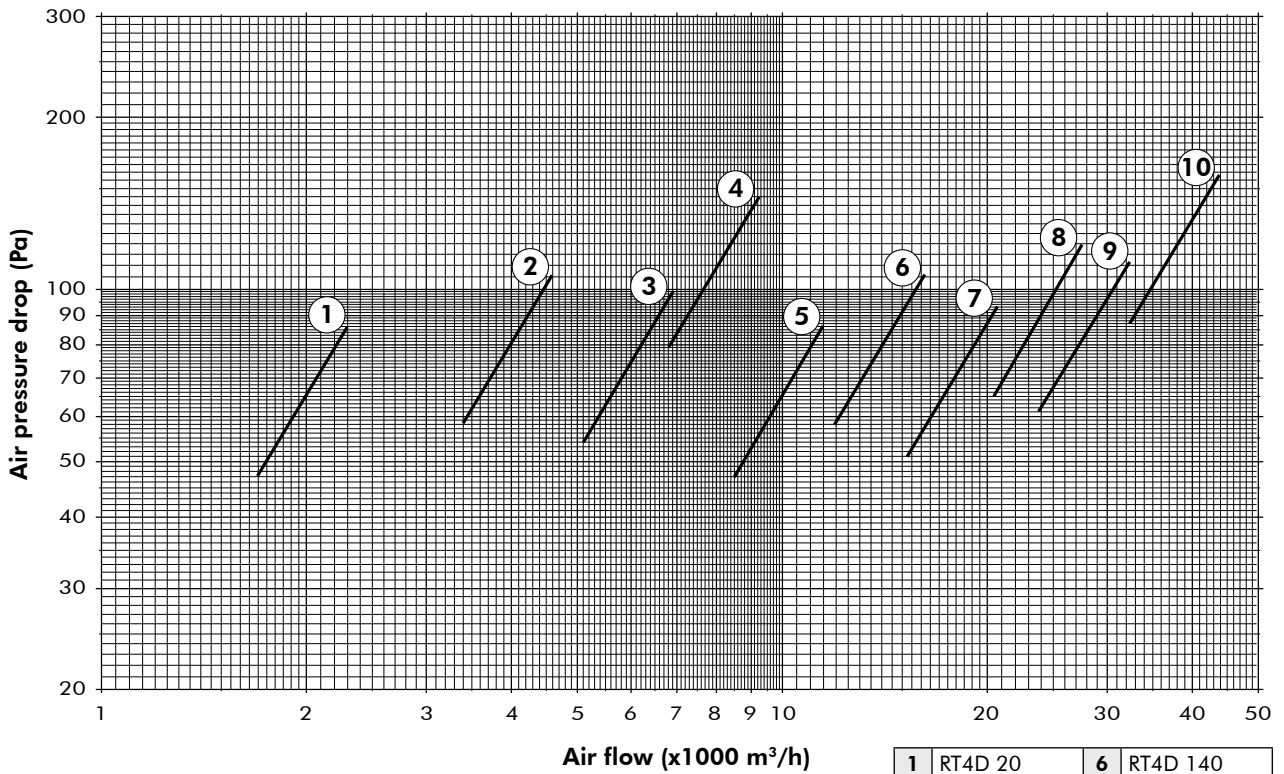

## 2-row hot water coil

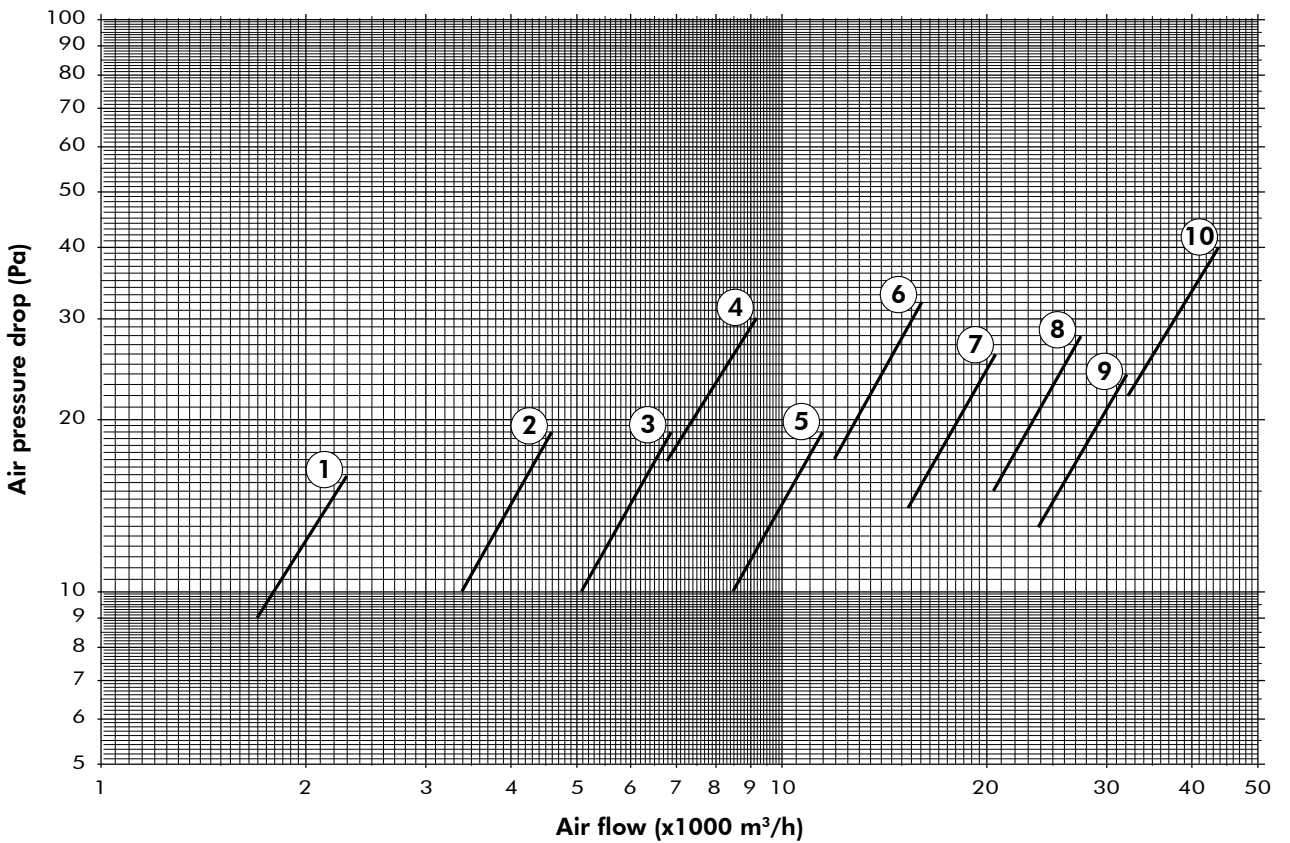

# Component Air Pressure Drops (continued)

## 3-row hot water coil

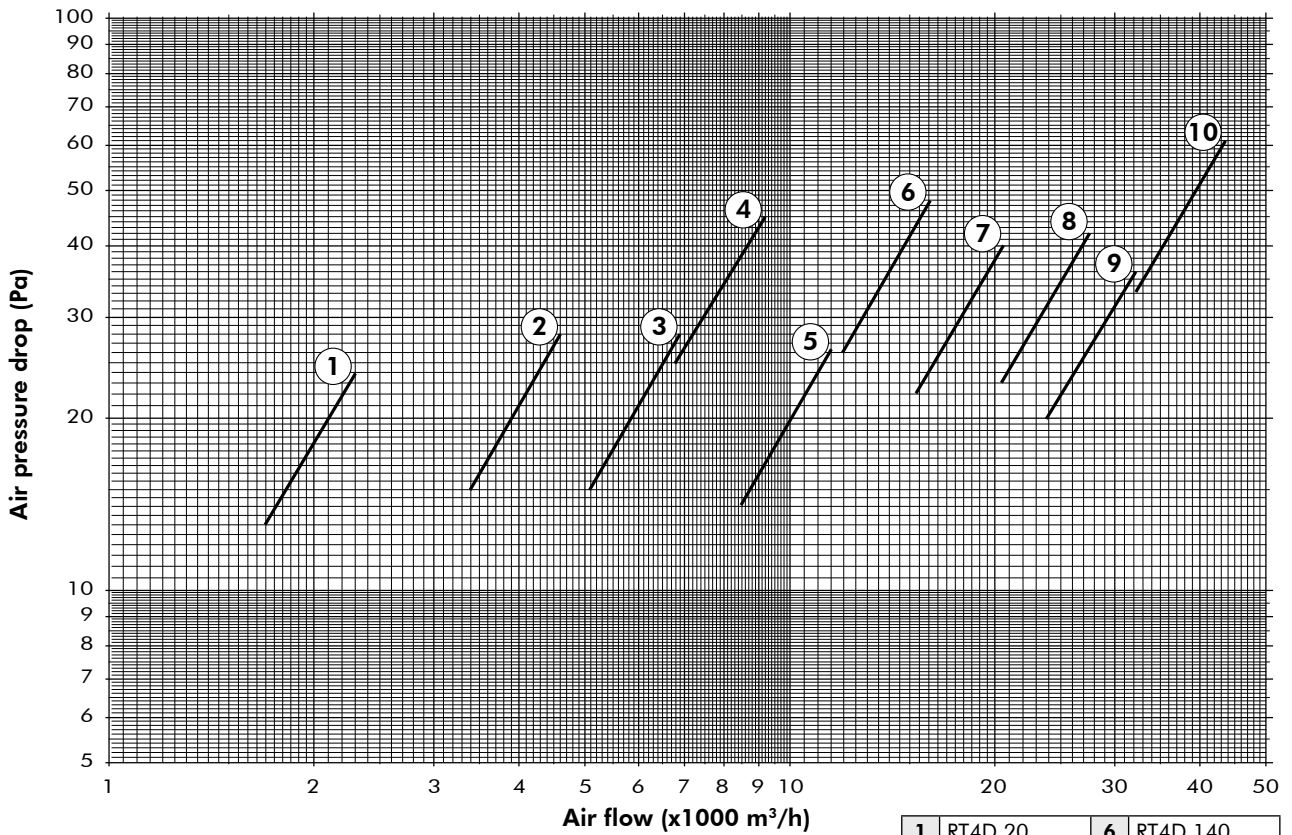

1	RT4D 20	6	RT4D 140
2	RT4D 40	7	RT4D 180
3	RT4D 60	8	RT4D 240
4	RT4D 80	9	RT4D 280
5	RT4D 100	10	RT4D 380

## Gas heat

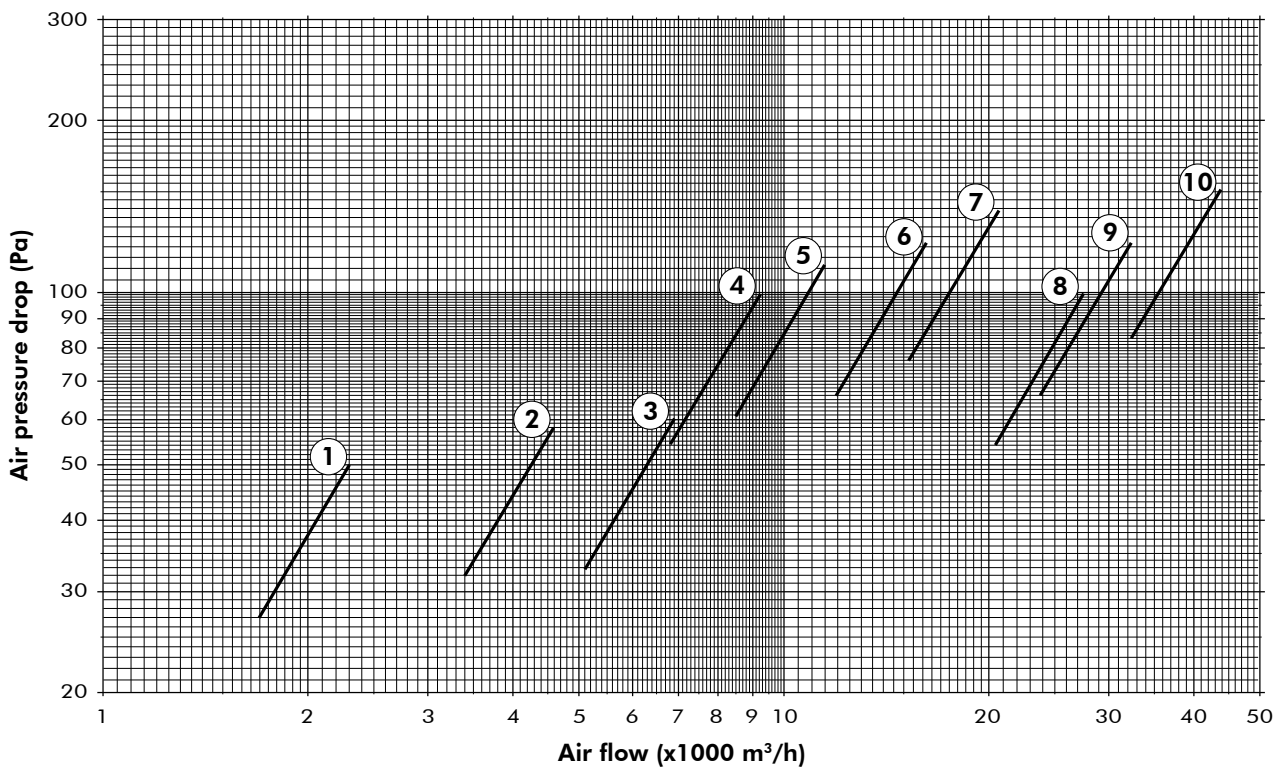

# Dimensions (mm) - RT4D 20 & 40

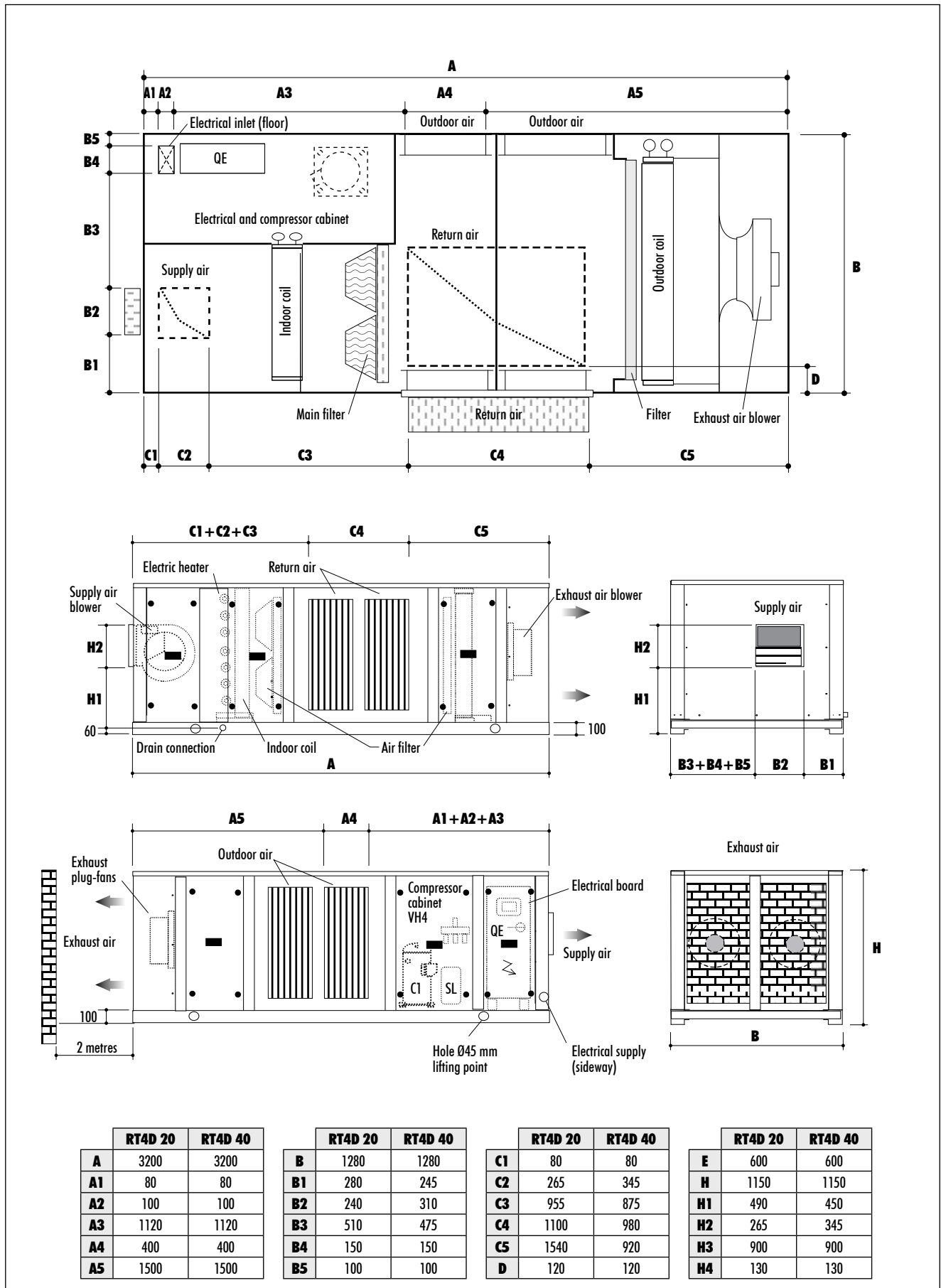

	RT4D 20	RT4D 40
<b>A</b>	3200	3200
<b>A1</b>	80	80
<b>A2</b>	100	100
<b>A3</b>	1120	1120
<b>A4</b>	400	400
<b>A5</b>	1500	1500

	RT4D 20	RT4D 40
<b>B</b>	1280	1280
<b>B1</b>	280	245
<b>B2</b>	240	310
<b>B3</b>	510	475
<b>B4</b>	150	150
<b>B5</b>	100	100

	RT4D 20	RT4D 40
<b>C1</b>	80	80
<b>C2</b>	265	345
<b>C3</b>	955	875
<b>C4</b>	1100	980
<b>C5</b>	1540	920
<b>D</b>	120	120

	RT4D 20	RT4D 40
<b>E</b>	600	600
<b>H</b>	1150	1150
<b>H1</b>	490	450
<b>H2</b>	265	345
<b>H3</b>	900	900
<b>H4</b>	130	130

# Dimensions - RT4D 60 & 80

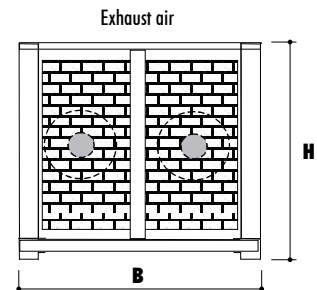
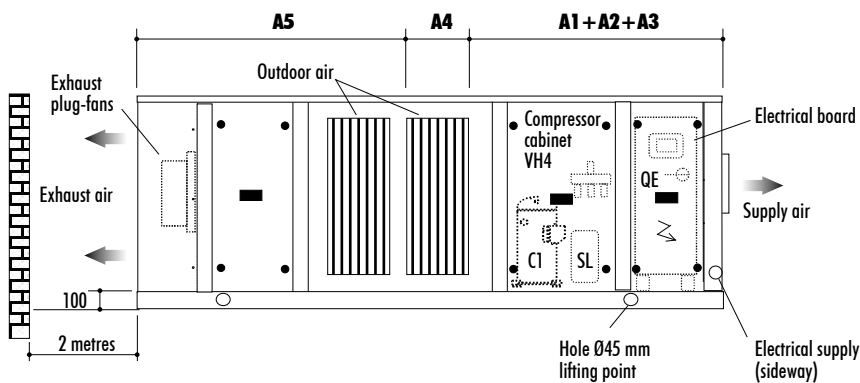
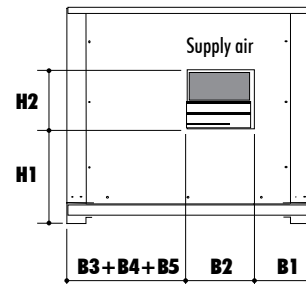
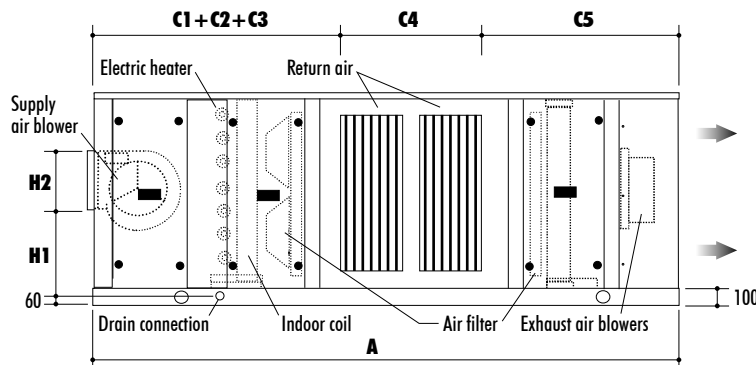
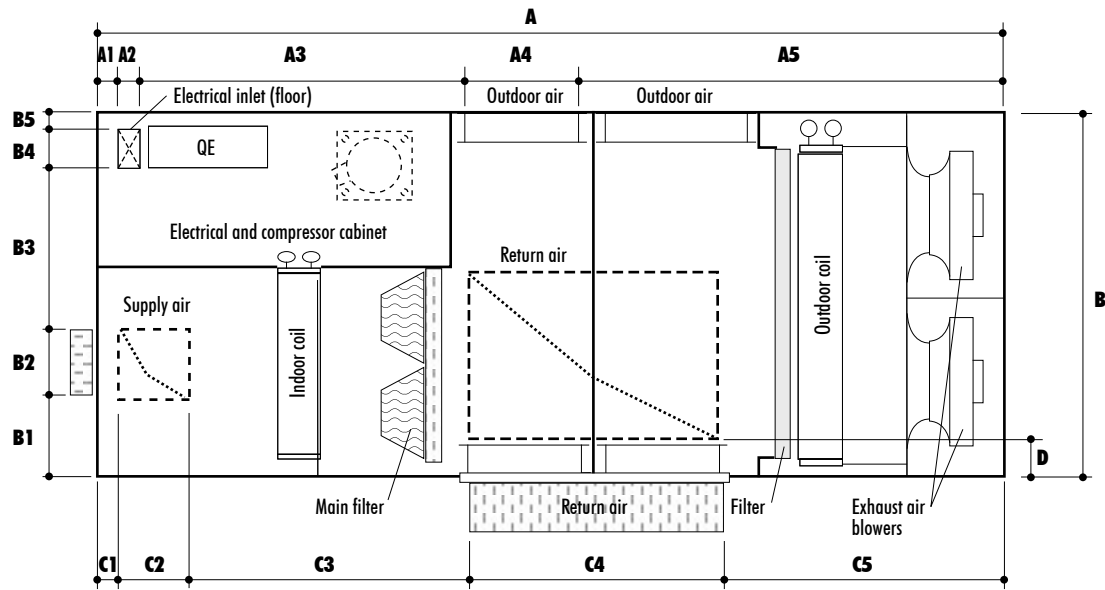

	RT4D 60	RT4D 80
<b>A</b>	3940	3940
<b>A1</b>	80	80
<b>A2</b>	100	100
<b>A3</b>	1380	1380
<b>A4</b>	500	500
<b>A5</b>	1880	1880

	RT4D 60	RT4D 80
<b>B</b>	1750	1750
<b>B1</b>	405	375
<b>B2</b>	375	430
<b>B3</b>	720	695
<b>B4</b>	200	150
<b>B5</b>	100	100

	RT4D 60	RT4D 80
<b>C1</b>	80	80
<b>C2</b>	405	480
<b>C3</b>	1215	1140
<b>C4</b>	1080	1080
<b>C5</b>	1160	1160
<b>D</b>	120	120

	RT4D 60	RT4D 80
<b>E</b>	950	950
<b>H</b>	1420	1420
<b>H1</b>	660	620
<b>H2</b>	405	480
<b>H3</b>	1100	1100
<b>H4</b>	160	160

# Dimensions - RT4D 100 & 140

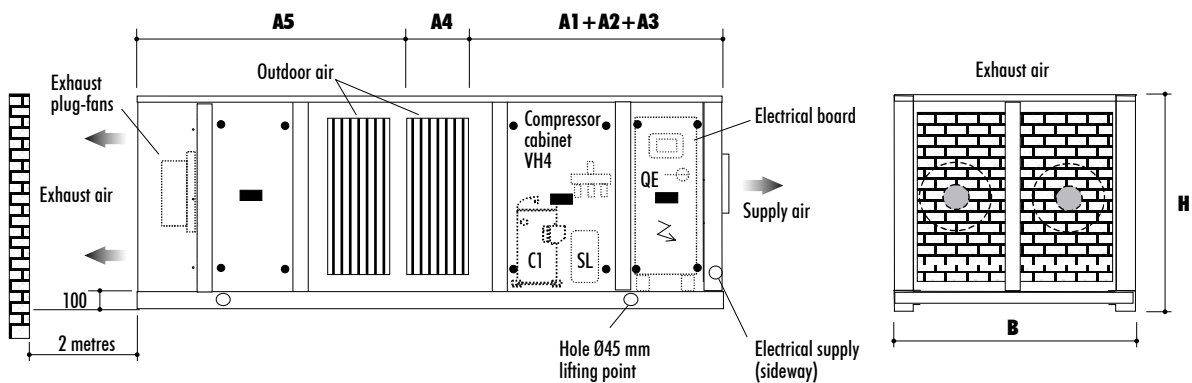
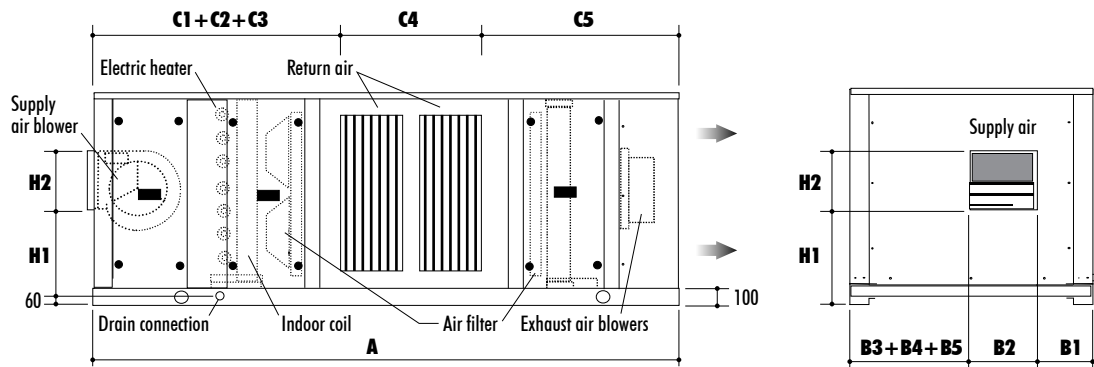
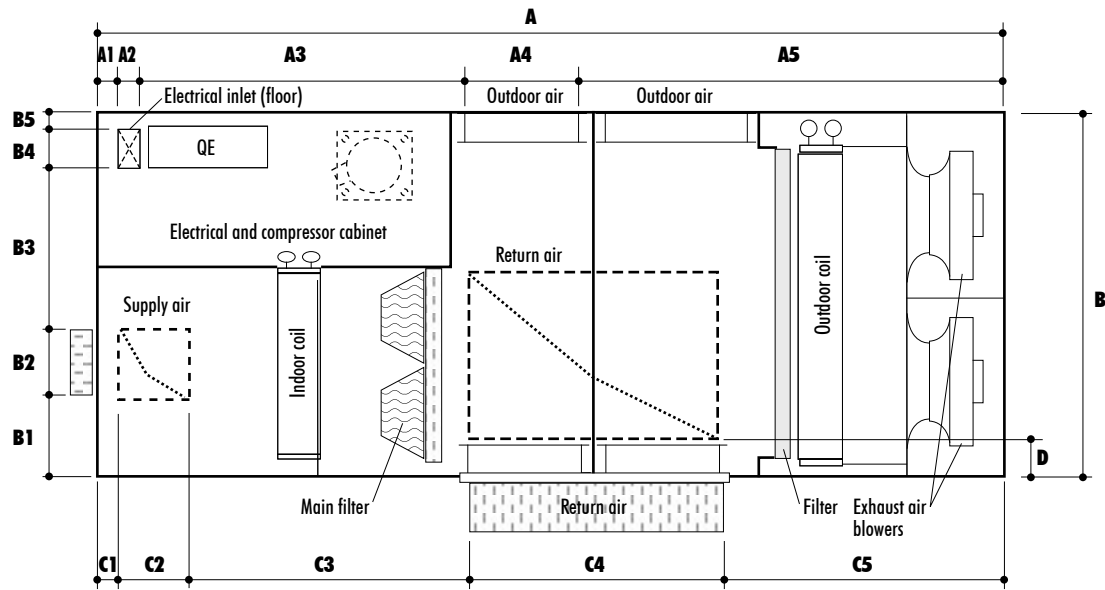

	RT4D 100	RT4D 140
<b>A</b>	5400	5400
<b>A1</b>	80	80
<b>A2</b>	150	150
<b>A3</b>	1785	1785
<b>A4</b>	800	800
<b>A5</b>	2585	2585

	RT4D 100	RT4D 140
<b>B</b>	1960	1960
<b>B1</b>	390	350
<b>B2</b>	560	640
<b>B3</b>	710	670
<b>B4</b>	200	200
<b>B5</b>	100	100

	RT4D 100	RT4D 140
<b>C1</b>	80	80
<b>C2</b>	480	640
<b>C3</b>	1455	1295
<b>C4</b>	1680	1080
<b>C5</b>	1705	1160
<b>D</b>	120	120

	RT4D 100	RT4D 140
<b>E</b>	1100	1100
<b>H</b>	1880	1880
<b>H1</b>	690	610
<b>H2</b>	480	640
<b>H3</b>	1400	1400
<b>H4</b>	220	220

# Dimensions - RT4D 180 & 240

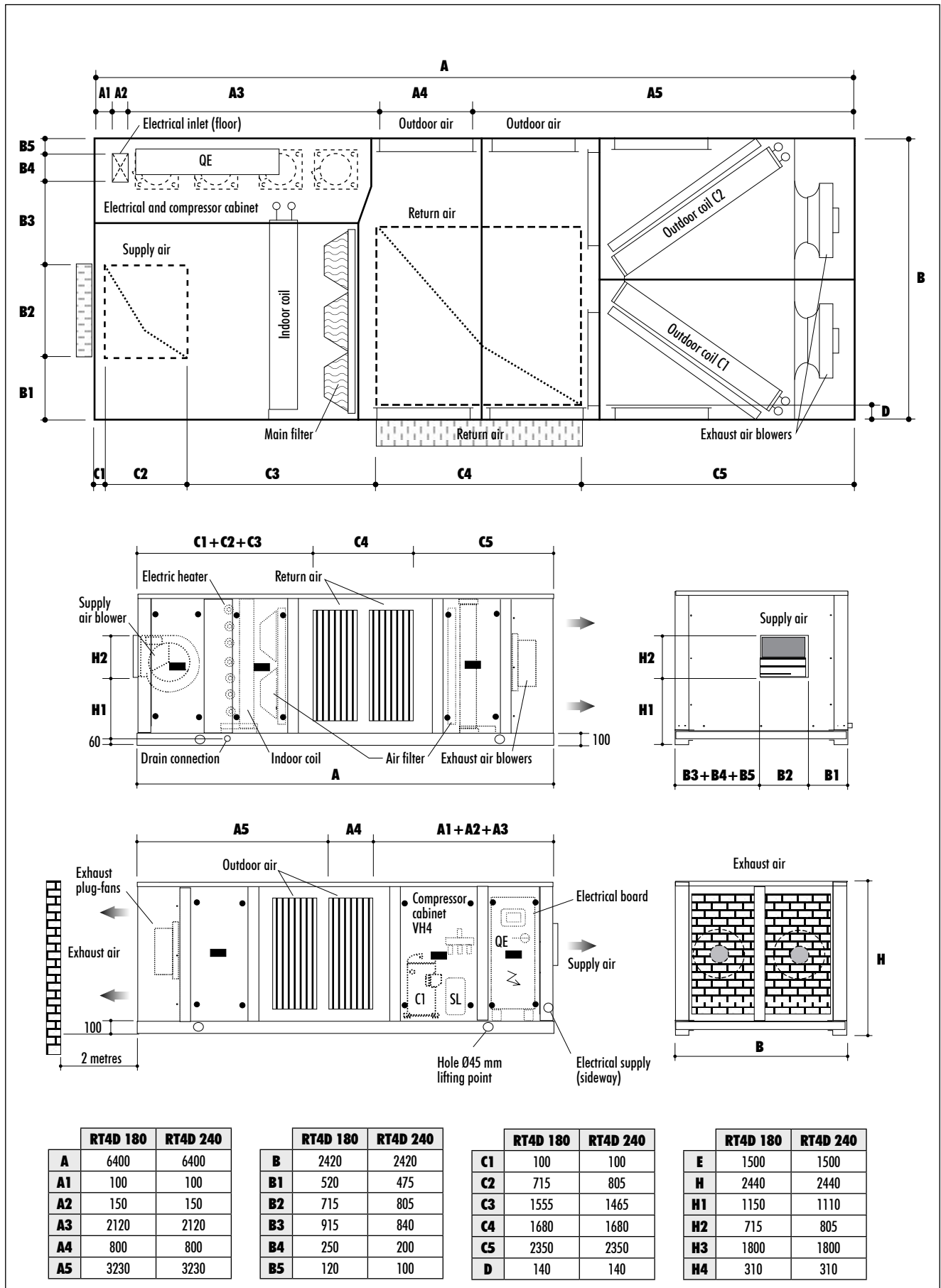



# Dimensions - RT4D 280 & 380

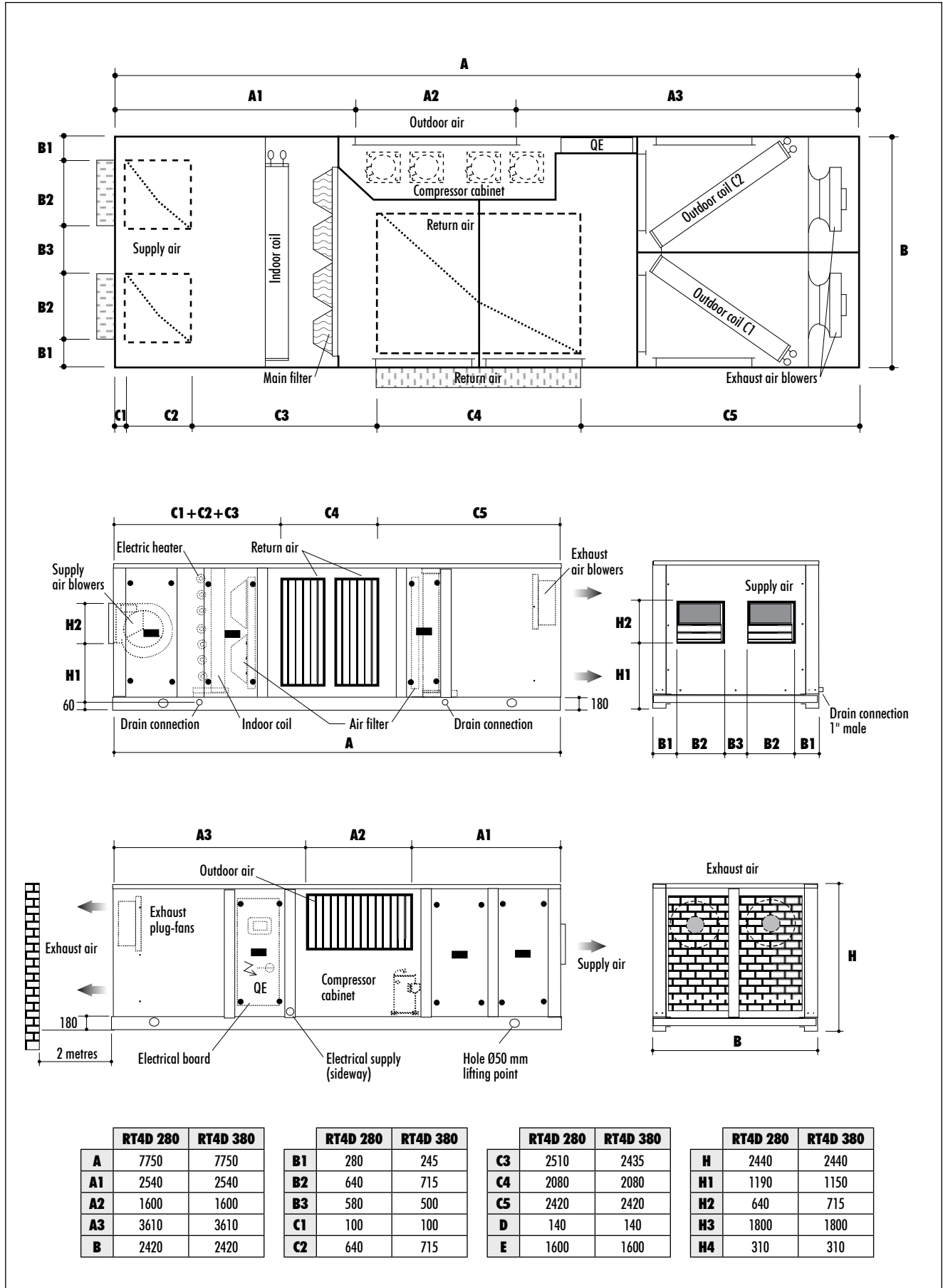

	RT4D 280	RT4D 380
<b>A</b>	7750	7750
<b>A1</b>	2540	2540
<b>A2</b>	1600	1600
<b>A3</b>	3610	3610
<b>B</b>	2420	2420

	RT4D 280	RT4D 380
<b>B1</b>	280	245
<b>B2</b>	640	715
<b>B3</b>	580	500
<b>C1</b>	100	100
<b>C2</b>	640	715

	RT4D 280	RT4D 380
<b>C3</b>	2510	2435
<b>C4</b>	2080	2080
<b>C5</b>	2420	2420
<b>D</b>	140	140
<b>E</b>	1600	1600

	RT4D 280	RT4D 380
<b>H</b>	2440	2440
<b>H1</b>	1190	1150
<b>H2</b>	640	715
<b>H3</b>	1800	1800
<b>H4</b>	310	310

# Guide Specification - RT4D

---

## GENERAL SCOPE

---

- The ROOFTOP shall be RT4D type, factory assembled with weatherproof construction. It will be a single package unit including wired electrical Automation and Controls, with charged refrigerant system, air handling and heating section tested on the factory.
- The ROOFTOP shall be a double flow system with two blowers combined with 4 air dampers.
- One blower shall be placed in the exhaust air downstream of the outdoor coil to recover the energy leaving the building in winter and summer.
- One blower shall be placed downstream of the indoor coil to supply treated- and renewed air to the building.
- Four air dampers shall balance the air flows between outdoor and indoor coils, exhaust- and outdoor air, return- and supply air.
- The manufacturer shall pressure test each refrigerant circuit, evacuate and charge them with refrigerant and oil. The unit shall undergo a run test on all features and a quality inspection prior to shipment.
- The Digital Controller shall be configured by the manufacturer at the factory.

## CABINET

---

- The casing exposed to the weather shall be completely made of polished aluminium.
- The roof, side panels and the doors shall be double wall, inside and outside aluminium with 50 mm MO inflammable 32 kg/m<sup>3</sup> CE certified glass wool.
- The floor shall be double wall, inside and outside aluminium with 40 mm MO insulation.
- The inside wall of the air channel shall be cleanable from contaminants.
- All access and service doors shall open with 2 piano-type hinges, locking with ¼ turn progressive rotor fasteners.
- Hinges and rotor fasteners shall be made of non-corrosive polyamide.
- All fasteners and screws penetrating inside the air channel will not be dangerously exposed.
- The rail base shall be made of 3 mm painted galvanized steel with 4 lifting points.

## TECHNICAL COMPARTMENT

---

- The cabinet shall have a technical compartment separated from the air treatment by a dividing wall.
- The compressors, reversing valves, refrigerant service ports, electrical panel with automation and control devices shall be factory mounted in the technical compartment.
- The noise disturbance from the compressors to the environment and the danger of condensation inside the technical compartment shall be reduced by a 30 mm insulation.
- All work done from the technical compartment shall not affect the operation of the unit.
- The IP 54 electrical panel shall be located inside the technical compartment.
- The electrical panel shall be accessible through an individual hinged door.

## REFRIGERATION SECTION

---

- The Refrigerant system shall be air cooled direct expansion type leak tested, evacuated and fully charged with R407C and oil at the factory.
- The refrigerant circuit shall be reversible.
- Each circuit shall have one liquid separator in the suction line, one liquid receiver in the liquid line, one reversing valve, two expansion valves, two check valves, two by-pass, one sight glass, one filter dryer, high and low pressure ports, mounted and brazed at the factory.
- Two glass manometers per circuit, high and low pressure are visible from outside the casing.
- Each circuit shall have an automatic reset high-pressure switch (pre-alarm), a manual reset high pressure switch and a manual reset low pressure switch.
- The outdoor coil shall be divided vertically in two independent circuits (two circuits only) placed in one drain pan to permit undisturbed defrost of one circuit at a time.
- The outdoor drain pan shall be equipped with an electric heater to melt the ice.
- Each circuit will have two compressors in tandem.
- The compressors shall be scroll hermetic type with crankcase heater.
- Each compressor shall have flexible conduits in the suction- and discharge lines to avoid vibration.
- The compressors shall be from over-current and over-temperature protected.
- The Controller shall unload one compressor per refrigerant circuit on high head-pressure to prevent from total cut-off on very hot summer days (tandem only).
- The Controller shall unload one compressor per refrigerant circuit on seasonal partial-load to benefit from the oversized outdoor coils and increase the EER (tandem only).
- The outdoor coils shall be protected with perforated aluminium sheet metal grid.
- The outdoor coil shall be protected from entering dirt by a G4 filter.
- The outdoor air damper shall be controlled by a refrigerant pressure transducer located in the outdoor coil.
- The transducer shall maintain the condensing temperature constant in winter and the evaporating temperature constant in summer, by modulating the quantity of outdoor air over the outdoor coil.
- The drain pan under the indoor coil shall be sloped and removable.
- One compressor shall be equipped with a frequency inverter to modulate the refrigerant flow.
- The defrost shall take place after 30 min. low evaporative temperature in the outdoor coil while heating.
- The outdoor air damper shall close and the exhaust blower of the defrosting circuit will stop. Only one circuit at a time shall be permitted to defrost.
- After defrost, the exhaust blower shall purge the outdoor coil from condensate 90 sec., before reversing back to heating.

# Guide Specification - RT4D (continued)

---

## BLOWER AND DRIVE SECTION

---

### THE SUPPLY BLOWER SECTION

---

- The blower(s) shall be belt driven, centrifugal with two inlets, vibration isolated, mounted in a reinforced frame and attached to the cabinet with a flexible connection.
- The blower shall have backward curved blades for airflows from 6000 to 38000 m<sup>3</sup>/h.
- The motor shall be mounted on an independent platform with adjusting screw-spanner for alignment and belt tension.
- The blower and the motor drive shall be accessible through a service hinged door.
- The belt drive shall have rotor-lock pulleys.
- The blower motor shall be frequency modulated for variable air volume. The inverters shall mount in a divided electrical panel in the technical compartment.
- A discharge sensor shall maintain a constant supply air temperature.
- An air flow switch shall be factory mounted to sense the pressure difference between the blower entering-and leaving.

### THE EXHAUST AIR BLOWER (RETURN AIR BLOWER) SECTION

---

- The blower(s) shall be of the plug fan type direct driven.
- Each plug fan shall be cased-in to the outdoor coil to avoid short circuiting.
- Each circuit has one or two plug fan(s).
- The exhaust blower shall be speed controlled.
- One air pressure sensor in the return air duct shall control the speed of the exhaust air blower and keep the static air pressure in the duct leaving the building constant, regardless of the position of the 4 dampers.

## AIR FLOW ARRANGEMENTS

---

The supply air and return air shall be connected :

- Down flow , within the floor of the ROOFTOP.
- Up flow in the roof of the ROOFTOP.
- Horizontal at the front and on the side of the ROOFTOP.

## AIR FILTERS

---

- The air filters shall be mounted on sliding rails upstream from the indoor coil with a hinged service door.
- The filter shall be F7 bag filters with a G4 pre-filter compliant with EN 779.
- The bag-filter shall be F7 with low leakage tensioning clamps on the rack.
- The clogged filter-switch shall be factory fitted and wired to the Controller.

## FOUR DAMPER

---

- The ROOFTOP shall be supplied with four air dampers, each one of them shall handle up to 100% of the air flow.
- Each one of the four dampers is independently actuated by a motor.

- Two dampers shall be located in the outdoor air, one to the outdoor coil and one to the indoor coil. Both outdoor air dampers shall be hinged to permit the service inside the unit.
- A third damper shall be in the recirculated air and the fourth damper shall be in the exhaust air.
- The dampers shall be made of profile aluminium.
- In summer the outdoor air damper shall open to 100% and the ROOFTOP shall operate less compressor when the outdoor temperature is lower than the indoor temperature (free-cooling).
- On free-cooling the outdoor air damper shall modulate in correlation with the exhaust air damper.
- The economizing function shall be monitored by the sensible heat of the outdoor- and indoor air.
- The economizing function shall be monitored by the enthalpy of the outdoor- and indoor air.
- A quality sensor shall monitor the quantity of outdoor air to ventilate the building.
- The minimum outdoor air volume for the hygienic ventilation of the occupants shall be adjustable at the Controller.
- The outdoor- and exhaust air dampers shall close on start-up, non occupied and morning warm-up.
- A smoke detector shall be factory installed in the ROOFTOP.

## HEATING SECTION

---

### GAS HEAT (CONDENSATION BURNER AS OPTIONAL)

---

- The direct gas heat section shall have a pre-mix condensing power burner using latent heat from gas to save energy.
- The gas burner shall be pre-adjusted at the factory for 0 ppm CO and less than 35 ppm NOx. The gas-burner shall need no adjustment on field start-up.
- The efficiency of the gas heater shall be approximately 105 % at 30% of the maximal heating capacity.
- The heat exchanger shall be made of Stainless-steel, capable of handling entering outdoor air down to -20 °C.
- The combustion-air blower shall have a variable speed driven proportionally to the heat demand.
- The heat-exchanger and the flue vent shall be equipped with one common condensate drain leading outside the unit.
- The combination gas burner / heat-exchanger shall have a common CE certificate.
- The gas burner shall have 2 stage heat.
- The gas burner shall be modulating from 30 to 100 %.
- A condensate neutralisator shall be supplied with the unit for field installation at the condensate drain.

### GAS HEAT (ATMOSPHERIC BURNERS AS STANDARD)

---

- The direct fired tubular heat exchanger shall be equipped with atmospheric burners.
- The efficiency of the combustion shall be not less than 92%.
- The heat exchanger shall be made of stainless steel. It will have an induced blower to exhaust the fumes without outdoor interference.

# Guide Specification - RT4D (continued)

---

- The ignition and the control of the flame shall be automatic.
- The burner shall be for two stages heat.
- The burner shall be modulating.

## HOT WATER

---

- The hot water coil shall be factory fitted downstream from the DX indoor coil.
- The hot water coil shall cover the entire face area of the DX indoor coil to insure low air velocity and low air pressure drop.
- The hot water coil shall be accessible through an hinged double wall hinged door with 50 mm insulation.
- A modulating 3-way valve shall be factory fitted, wired to the Controller.
- A capillary 2-stage freeze-stat shall be factory fitted upstream from the hot-water coil and wired to the Controller.
- The modulating 3-way valve shall be assembled in a compartment divided from the air flow.
- The water connections shall be made from the floor of the unit.
- The hot water circuit shall be protected by a circulating pump with by-pass.

## ELECTRIC HEAT

---

- The electric heater shall be factory fitted downstream from the DX indoor coil.
- The electric heater shall cover the entire face area of the DX indoor coil.
- The electric heaters shall be made of smooth steel tubes wired for two stages heat to the controller.
- The disconnect switch and the circuit breakers of the electric heat shall be sized for sized and cabled for a single inlet power connection.
- The electric heater shall be protected from overheating with factory-fitted safety thermostats wired to the circuit-breakers and Controller.
- The electric heater shall have 2 (3) stage heat.

## ROOF MOUNTING CURB

---

- The roof-mounting-curb shall be supplied knocked-down with bolts and screws for field- assembling.
- The roof-mounting curb shall be made of a 3.0 mm heavy gauge galvanized steel.
- A one side adhesive neoprene gasket shall be supplied by the manufacturer to join the roof mounting curb to the unit base and stop vibration and thermal bridge.
- The roof-mounting-curb shall be designed with recessed profile to allow for a field supplied weather tight flashing in the roof insulation.

## AUTOMATION AND CONTROL

---

- The ROOFTOP shall be factory wired and cabled to the automation- and electric devices, controls- and safety devices, and Controller ready-to-start.
- All electric devices and controls shall be mounted in a control panel with hinged door and electric heater with thermostat to eliminate condensation.

- The wiring shall comply with CE standards and EN 60204-1.
- All cables and wires shall be individually identified.
- The unit shall be equipped with one single power inlet connection, sized to the total current draw of the unit scheduled in this specification.
- The unit shall be furnished with one lockable main disconnect, sized to the total current draw of the unit, accessible from outside the cabinet.
- The Controller shall be a Direct Digital Microprocessor, configured at the factory by the manufacturer for all functions specified here above and run-tested.
- The manufacturer software shall offer field adaptive heating and cooling staging algorithms, dedicated to optimisation of energy consumption, to satisfy ambient set conditions.
- The monitoring of the ambient load, overheating and overloading, the compressor cycling, dampering, phase and pressure-control, shall be managed by the controller to insure safe and automatic year-round operation.
- A dry-contact for general alarm shall be available for field connection.
- The standard Direct Digital Controller shall be furnished with a RS 485 card to permit user to extend the communication of the ROOFTOP by sending and retrieving binary and analog flexible informations to read and write via ModBUS.
- The DD Controller shall communicate via LONWORKS.
- The DD Controller shall communicate via Modem.
- The DDC shall be furnished with a time card for field indexing of unoccupied and occupied modes, day-week and maintenance scheduling, operation hours, history of the last 150 failures and alarms with indication of time and day.
- The monitoring of the ambient load shall be achieved by a field mounted room sensor.
- The monitoring of the ambient load shall be achieved by a field mounted return air duct sensor.
- The DDC shall be supplied with a User-Interface. The User Interface shall have a 6 buttons key-pad for field programming of set-points, proportional bands, alarm threshold and permit resetting of alarms. The User Interface shall have a LED semi-graphic 4 lines 20 columns screen with backlight. It shall be field installed outside the ROOFTOP within 200 m Bus distance from the Controller.
- The user-interface shall be factory mounted on the ROOFTOP.
- The user-interface shall be mounted remote from the ROOFTOP.
- The software shall be suitable for field indexing of a winter-summer sliding ambient temperature, with min.-max. setting.
- The software shall allow for field setting of a night set-back winter ambient temperature.
- The software shall permit the field adjustment of the minimum hygienic ventilation requirement in % of the nominal air volume of the ROOFTOP.
- The software shall be field programmable for Variable Air Volume operation when using Inverters on the blower motors.
- The DDC shall hold the desired air pressure in the return air ductwork constant.
- The outdoor air damper shall be controlled by the refrigerant pressure in the outdoor coil.

# Guide Specification - RT4D (continued)

## Technical Data

<b>Nominal cooling capacity</b>	kW	
Summer outdoor temperature	°C	
Summer indoor temperature dry bulb	°C	
Summer indoor temperature wet bulb	°C	
S/T ratio		
<b>Nominal heating capacity</b>	kW	
Heat-pump winter outdoor	°C	
Winter return air to outdoor coil	°C	
<b>Total supply air volume</b>	m <sup>3</sup> /h	
<b>Minimum outdoor air volume</b>	m <sup>3</sup> /h	
External static pressure supply air	Pa	
Supply air blower motor power input	kW	
Supply air blower speed	rpm	
Supply air blower power sound level	dB(A)	
<b>Total return air volume</b>	m <sup>3</sup> /h	
External static pressure return air	Pa	
Number of exhaust air blowers		
Exhaust air blower motor power input	kW	
<b>Gas</b>		
Entering gas pressure	mbar	
Burner pressure	mbar	
Minimum efficiency	%	
Gas quality		<b>G20</b>

<b>Hot water</b>		
Entering water temperature	°C	
Leaving water temperature	°C	
Water flow rate	m <sup>3</sup> /h	
Water pressure drop	bar	
<b>Electric heat</b>		
Number of stages		
Heating capacity	kW	
<b>Refrigeration</b>		
Number of compressors		
Number of circuits		
Power input per compressor	kW	
Refrigerant		<b>R407C</b>
<b>Filter classification</b>		
Filter face area	m <sup>2</sup>	
Filter size	mm x mm	
Number of filters		
<b>Electrical characteristics</b>		
Voltage / Ph / Hz		
Total power input	kW	
Full load amperage	A	
Locked rotor amperage	A	
<b>Manufacturer</b>		
<b>Model and size</b>		
<b>Plant position</b>		
<b>Quantity</b>		

# Notes

---

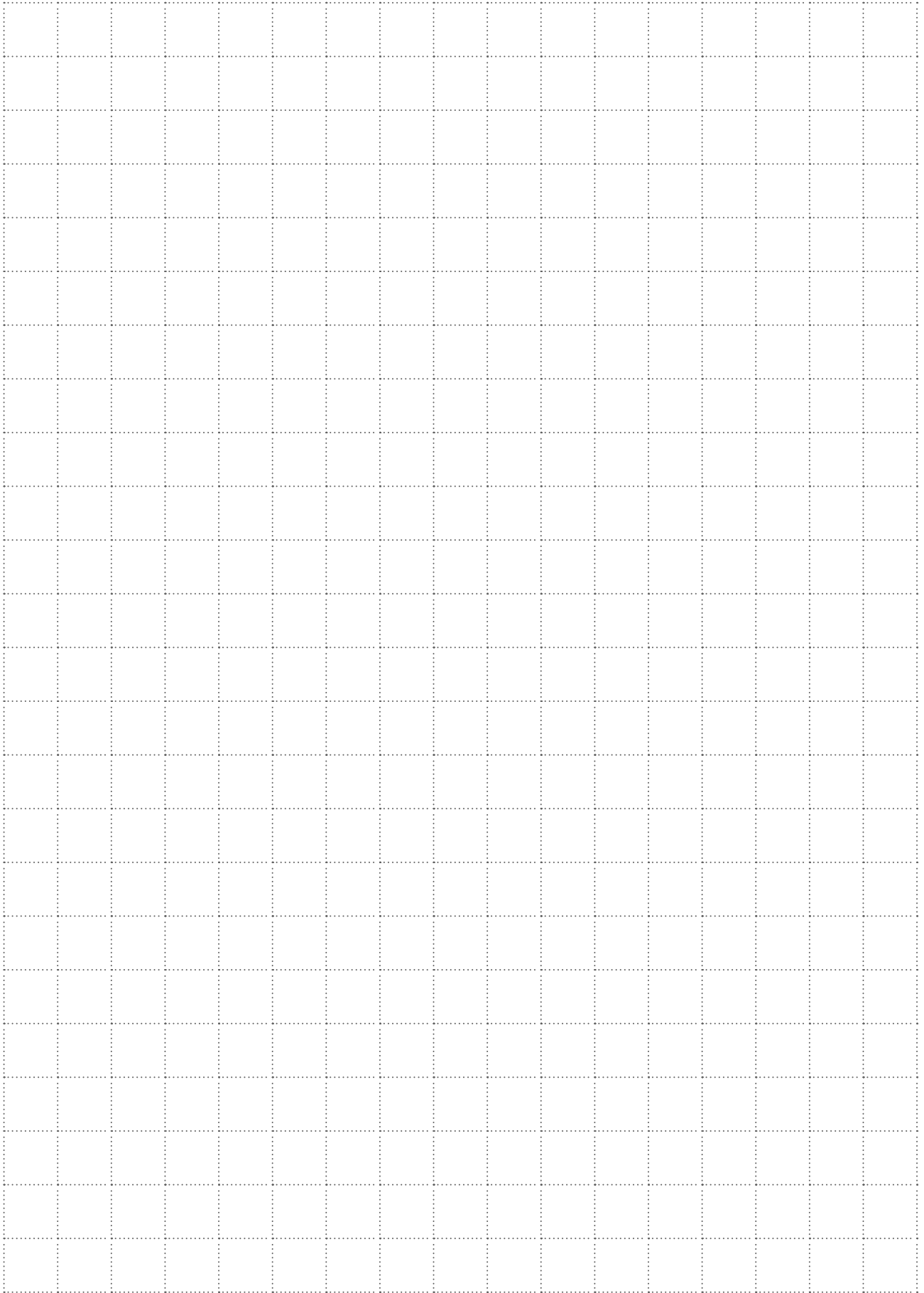

# Notes

---

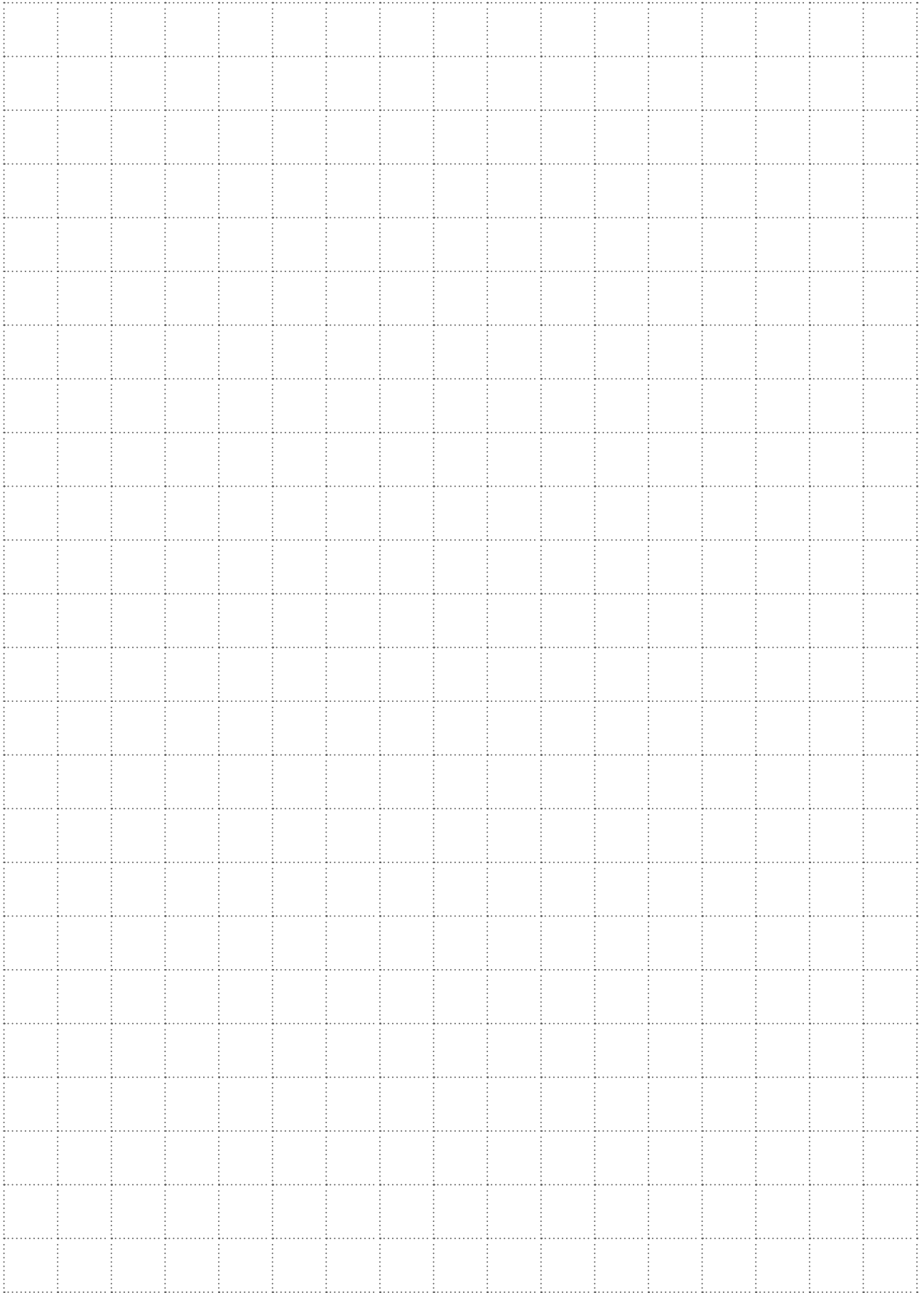

As par☐



CAC Export Department  
42 cours Jean-Jaurès  
17800 Pons - France  
Tel. : +33 (0)5 46 92 33 33 - Fax : +33 (0)5 46 91 26 44

Your distributor :

--

