



Authorised User No. 00007



INSTALLATION, OPERATING & MAINTENANCE MANUAL

Ultima Remote Air Cooled Air Cooled Chiller 75kW - 450kW



ISO 14001
EM552086



ISO 9001
FM00542

About Airedale Products & Customer Services

WARRANTY, COMMISSIONING & MAINTENANCE

The equipment carries Airedale's standard **Parts** (non consumable) & **Labour** warranty for a period of **12 months** from the date of commissioning or **18 months** from the date of despatch, whichever is the sooner. (Excludes the cost of any specialist access or lifting equipment.) Commissioning will be carried out by Airedale International Air Conditioning Ltd or an approved Airedale commissioning company.

To further protect your investment in Airedale products, we have introduced Airedale Service, who can provide full commissioning services, comprehensive maintenance packages and service cover 24 hours a day, 365 days a year (UK mainland). For a free quotation contact our Airedale Service or your local Sales Engineer.

All Airedale products are designed in accordance with EU Directives regarding prevention of build up of water, associated with the risk of contaminants such as Legionella.

Where applicable, effective removal of condensate is achieved by gradient drainage to outlets and where used, humidification systems produce sterile, non-toxic steam during normal operation.

For effective prevention of such risk it is necessary that the equipment is maintained in accordance with Airedale recommendations.

CAUTION

Warranty cover is not a substitute for Maintenance. Warranty cover is conditional to maintenance being carried out in accordance with the recommendations provided during the warranty period. Failure to have the maintenance procedures carried out will invalidate the warranty and any liabilities by Airedale International Air Conditioning Ltd.

SPARES

A spares list for 1, 3 and 5 years will be supplied with every unit and is also available from our Spares department on request.

TRAINING

As well as our comprehensive range of products, Airedale offers a modular range of Refrigeration and Air Conditioning Training courses, for further information please contact Airedale.

AIAC Ltd endeavours to ensure that the information in this document is correct and fairly stated, but none of the statements are to be relied upon as a statement or representation of fact. AIAC Ltd does not accept liability for any error or omission, or for any reliance placed on the information contained in this document.

The development of Airedale products and services is continuous and the information in this document may not be up to date. It is important to check the current position with AIAC Ltd at the address stated. This document is not part of a contract or licence unless expressly agreed.

No part of this document may be reproduced or transmitted in any form or by any means, electronic or mechanical, including photocopying, recording, or information storage and retrieval systems, for any purpose other than the purchaser's personal use, without the express written permission of AIAC Ltd.

© 2004 Airedale International Air Conditioning Limited. All rights reserved. Printed in the UK.

CUSTOMER SERVICES

For further assistance, please e-mail: enquiries@airedale.com or telephone:

| | | |
|--------------------------------|-----------------------|--|
| UK Sales Enquiries | + 44 (0) 113 238 7789 | uk.sales@airedale.com |
| International Enquiries | + 44 (0) 113 239 1000 | enquiries@airedale.com |
| Spares Hot Line | + 44 (0) 113 238 7878 | spares@airedale.com |
| Airedale Service | + 44 (0) 113 239 1000 | service@airedale.com |
| Technical Support | + 44 (0) 113 239 1000 | tech.support@airedale.com |
| Training Enquiries | + 44 (0) 113 239 1000 | marketing@airedale.com |

For information, visit us at our Web Site: www.airedale.com

Contents

| | |
|--|-----------|
| GENERAL STATEMENT | 4 |
| WARRANTY | 5 |
| GENERAL DESCRIPTION | 6 |
| Unit Identification | 6 |
| Introduction | 6 |
| Standard Features | 6 |
| Optional Extras – Energy Saving | 7 |
| Optional Extras – General | 8 |
| INSTALLATION DATA | 9 |
| Dimensions | 9 |
| Point Loadings, Weights & Centre of Gravity (C of G) | 10 |
| Unit Lifting | 11 |
| Anti Vibration Mounting - Optional | 12 |
| Positioning | 13 |
| Refrigeration System | 14 |
| Pipework Installation - Good Practices | 15 |
| Water System | 16 |
| Glycol Data | 18 |
| Interconnecting Wiring | 19 |
| Electrical Data | 20 |
| CONTROLS | 23 |
| Control Scheme Features | 23 |
| Operation | 24 |
| Setting up | 25 |
| Viewing Unit Operating Status | 26 |
| Alarms | 27 |
| COMMISSIONING DATA | 28 |
| Operating Limits | 28 |
| Mechanical Data | 28 |
| Waterside Pressure Drops | 29 |
| Operational Sequence | 30 |
| COMMISSIONING PROCEDURE | 31 |
| Pre Commissioning Checklist | 31 |
| Commissioning Checklist | 33 |
| MAINTENANCE | 34 |
| General Maintenance | 34 |
| Compressor Maintenance | 35 |
| Shut Down Periods | 35 |
| PARTS IDENTIFICATION | 36 |
| Spares | 36 |



General Statement

IMPORTANT

The information contained in this manual is critical to the correct operation and maintenance of the unit and should be read by all persons responsible for the installation, commissioning and maintenance of this Airedale unit.

SAFETY

The equipment has been designed and manufactured to meet international safety standards but, like any mechanical/electrical equipment, care must be taken if you are to obtain the best results.

- CAUTION**  1 **Service and maintenance of Airedale equipment should only be carried out by Technically trained competent personnel.**
- CAUTION**  2 **When working with any air conditioning units ensure that the electrical isolator is switched off prior to servicing or repair work and that there is no power to any part of the equipment.**
- 3 Also ensure that there are no other power feeds to the unit such as fire alarm circuits, BMS circuits etc
- 4 Electrical installation commissioning and maintenance work on this equipment should be undertaken by competent and trained personnel in accordance with local relevant standards and codes of practice.
- 5 Refrigerant used in this range of products is classified under the COSHH regulations as an irritant, with set Occupational Exposure Levels (OEL) for consideration if this plant is installed in confined or poorly ventilated areas.
- 6 A full hazard data sheet in accordance with COSHH regulations is available should this be required.

Warranty

GENERAL

To be read in conjunction with Airedale International Air Conditioning Ltd standard Conditions of Sale and any related quotation.

The equipment carries Airedale's standard **Parts** (non consumable) & **Labour** warranty for a period of **12 months** from the date of commissioning or **18 months** from the date of despatch, whichever is the sooner. Commissioning must be carried out by Airedale or an approved Airedale company.

WARRANTY IS ONLY VALID IN THE EVENT THAT:

- 1 In the period between delivery and commissioning the equipment:
 - o is properly protected & serviced
 - o water flow safety devices are in place and fully operational
- 2 The equipment is serviced & maintained by Airedale or an approved Airedale company in accordance with the Installation & Maintenance manual provided, during the Warranty Period.

In the event of a problem being reported, Airedale will cover the full cost of rectification (excluding costs for any specialist access or lifting equipment) if warranty is valid under these conditions.

Any spare part supplied by Airedale under the warranty shall be warranted for the unexpired period of the warranty or 3 months from delivery whichever period is the longer, with the exception of compressors on which a further 12 months warranty is granted.

PROCEDURE

- The on site contractor or service company place an official order on Airedale for the replacement part including site labour if required. Airedale will acknowledge this order with detailed prices for components, travel and labour rates.
- Should warranty be accepted, following inspection of the faulty component, a credit note will be issued against the invoice raised in line with the acknowledgement.
- Should warranty be refused the invoice raised against the acknowledgement becomes payable on normal terms.
- Airedale reserves the right to carry out site warranty labour work using their own direct labour or by sub contracting to an approved company of their choice.

EXCLUSIONS

Warranty may be refused for the following reasons:

- Misapplication of product or component.
- Incorrect site installation.
- Incomplete commissioning documentation.
- Inadequate site installation.
- Inadequate site maintenance.
- Damage caused by mishandling.
- Replaced part being returned damaged without explanation.
- Unnecessary delays incurred in return of defective component.

GENERAL

Dead on arrival or manufacturing defects are the responsibility of Airedale and should be reported immediately.

In the event of a warranty failure, dead on arrival or manufacturing defect, the Airedale Service department should be contacted and on receipt of an order, an Airedale engineer (or representative) will be directed to site as soon as possible.

RETURNS ANALYSIS

All faulty components returned under warranty are analysed on a monthly basis as a means of verifying component and product reliability as well as supplier performance. It is important that all component failures are reported correctly.

General Description

UNIT IDENTIFICATION

| REMOTE AIR COOLED LIQUID CHILLER | |
|----------------------------------|---|
| URAC | Ultima Remote Air Cooled Chiller |
| 75 – 450 | Model Size (Expressed as Nominal Cooling in kW) |
| D | Double Circuit - Standard Chiller |
| DQ | Double Circuit - Quiet Chiller |
| DSQ | Double Circuit - Super Quiet Chiller |
| Example | URAC250DQ |

INTRODUCTION

The Airedale range of Ultima Remote Air Cooled liquid chillers covers the nominal capacity range 75kW to 450kW in 45 model sizes incorporating Standard **D**, Quiet **DQ** and Super Quiet **DSQ** variations.

Attention has been placed on maximising the unit's performance while keeping the sound and vibration levels and footprint to an absolute minimum.

The range has been specifically designed for plant room installations.

A matching range of Air Cooled Condensers is available to complement the Remote Air Cooled Liquid Chiller, please refer to Airedale.

CE DIRECTIVE

Airedale certify that the equipment detailed in this manual conforms with the following EC Directives:

| | |
|---|---|
| Electromagnetic Compatibility Directive (EMC) | 89/336/EEC |
| Low Voltage Directive (LVD) | 73/23/EEC |
| Machinery Directive (MD) | 89/392/EEC in the version 98/37/EC |
| Pressure Equipment Directive (PED) | 97/23/EC |

To comply with these directives appropriate national & harmonised standards have been applied. These are listed on the Declaration of Conformity, supplied with each product.

REFRIGERANTS

The range has been designed and optimised for operation with the ozone benign R407C refrigerant.

STANDARD FEATURES

Standard Chiller - D

The Standard Ultima Air Cooled Remote Chiller comes complete with:

- **AIRET**ronix Microprocessor Control
- Evaporator Pad Heater
- Multiple Scroll Compressors
- Plate Evaporator
- Connections to Remote Condenser
- Dual Independent Refrigeration Circuits
- Electronic Expansion Valve(s)
- Connections for External Trace Heating (240V/500W available)
- A set of 4 M24 collared eye bolts to BS4278

Quiet Chiller - DQ

With the benefits of the Standard range, the Quiet chiller is supplied with an acoustic package, which incorporates:

- Compressor enclosure lined with Acoustic material

Super Quiet Chiller - DSQ

With the benefits of the Standard range, the Super Quiet chiller is supplied with a Quiet acoustic package, which incorporates the following to become one of the quietest chillers available:

- Compressor enclosure lined with 40mm Acoustic material

General Description

STANDARD FEATURES

Refrigeration

Each refrigeration circuit is supplied with the following:

- Holding charge of nitrogen
- Electronic expansion valve
- Liquid line ball valve
- Discharge line ball valve
- Large capacity filter drier with replaceable cores
- Liquid line sight glass
- Low pressure switch with manual reset via microprocessor controller
- High pressure switch with manual reset
- Suction and liquid pressure transducers
- Pressure relief valve with integral rupture disc and indicator gauge

Controls

As standard, the **AIRETrix** microprocessor controller can provide 4 or 6 stages of capacity control, dependent upon model type.

Optionally, the controller is designed to provide capabilities for;

- Building Management Systems
- Networking
- Sequencing (Master/Slave and Run/Standby)

to meet all your system requirements, please confirm at time of order.

Unit initial set up details can be found in the **Controls** section.

Electrical

Dedicated weatherproof electrical power and controls panels are situated at the end of the unit and contain:

- Separate, fully accessible, controls compartment, allowing adjustment of control set points whilst the unit is operational
- Circuit breakers for protection of all major unit components
- Separate, permanent supply for controls/trace heating, 230v/50Hz/1ph
- The electrical power and control panel is wired to the latest European standards and codes of practice
- Separate door locking electrical isolation for each mains compartment

OPTIONAL EXTRAS – ENERGY SAVING

Power Factor Correction

When applied to the motors of each compressor, the compressor power factor is controlled to a minimum operating value of 0.95 at the full operating capacity. This satisfies many supply authorities that may impose surcharges on equipment with power factor less than 0.95.

General Description

OPTIONAL EXTRAS – GENERAL

Loose Item

- Anti Vibration Mounts
- Victaulic Counterpipe Kit
- Flow Switch
- Water Filter

} Loose Parts Instructions provided

Factory Fitted

- Sequence Control

(CAUTION ▼ : It is only possible to set up sequencing following completion of interconnecting communication wiring. Airedale Service can arrange Sequence setup on request.)

- BMS Interface Card
- Dual Pressure Relief Valve
- Leak Detection Kit (DQ & DSQ Only)
- Electronic Soft Start
- Alternative Refrigerant (Outside EU)

OPTIONAL UNIT COVER

- Commissioning
- Chillerguard® Maintenance

} For details and a competitive quotation, contact Airedale Service.

Installation Data

DIMENSIONS

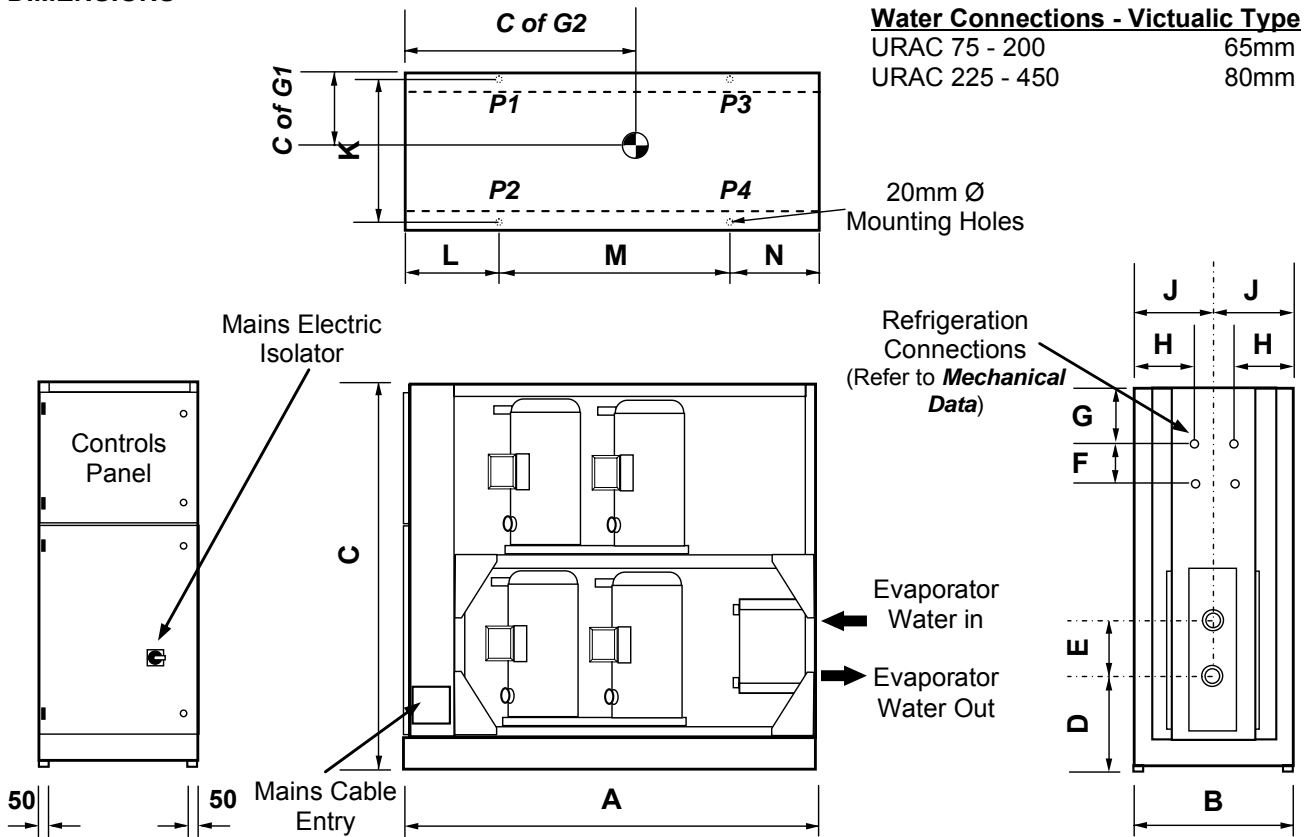

| Model Size | | A | B | C | D | E | F | G | H | J | K | L | M | N |
|------------|----|------|-----|------|-----|-----|-----|-----|-----|-----|-----|-----|------|-----|
| URAC75 | mm | 1800 | 760 | 1850 | 383 | 397 | 200 | 220 | 280 | 380 | 710 | 462 | 876 | 462 |
| URAC100 | mm | 1800 | 760 | 1850 | 383 | 397 | 200 | 220 | 280 | 380 | 710 | 462 | 876 | 462 |
| URAC125 | mm | 1800 | 760 | 1850 | 383 | 397 | 200 | 220 | 280 | 380 | 710 | 462 | 876 | 462 |
| URAC150 | mm | 2000 | 760 | 1850 | 380 | 397 | 200 | 220 | 280 | 380 | 710 | 462 | 1076 | 462 |
| URAC175 | mm | 2000 | 760 | 1850 | 380 | 397 | 200 | 220 | 280 | 380 | 710 | 462 | 1076 | 462 |
| URAC200 | mm | 2000 | 760 | 1850 | 380 | 397 | 200 | 220 | 280 | 380 | 710 | 462 | 1076 | 462 |
| URAC225 | mm | 2000 | 760 | 1850 | 268 | 628 | 200 | 220 | 280 | 380 | 710 | 462 | 1076 | 462 |
| URAC240 | mm | 3200 | 900 | 1900 | 256 | 628 | 500 | 250 | 250 | 450 | 850 | 970 | 1730 | 500 |
| URAC250 | mm | 2000 | 760 | 1850 | 268 | 628 | 200 | 220 | 280 | 380 | 710 | 462 | 1076 | 462 |
| URAC300 | mm | 3200 | 900 | 1900 | 256 | 628 | 500 | 250 | 250 | 450 | 850 | 970 | 1730 | 500 |
| URAC330 | mm | 3200 | 900 | 1900 | 256 | 628 | 500 | 250 | 250 | 450 | 850 | 970 | 1730 | 500 |
| URAC360 | mm | 3200 | 900 | 1900 | 256 | 628 | 500 | 250 | 250 | 450 | 850 | 970 | 1730 | 500 |
| URAC400 | mm | 3200 | 900 | 1900 | 256 | 628 | 500 | 250 | 250 | 450 | 850 | 970 | 1730 | 500 |
| URAC450 | mm | 3200 | 900 | 1900 | 256 | 628 | 500 | 250 | 250 | 450 | 850 | 970 | 1730 | 500 |

VICTAULIC TYPE FITTING

The unit water services are designed to accept a Victaulic type fitting as illustrated.

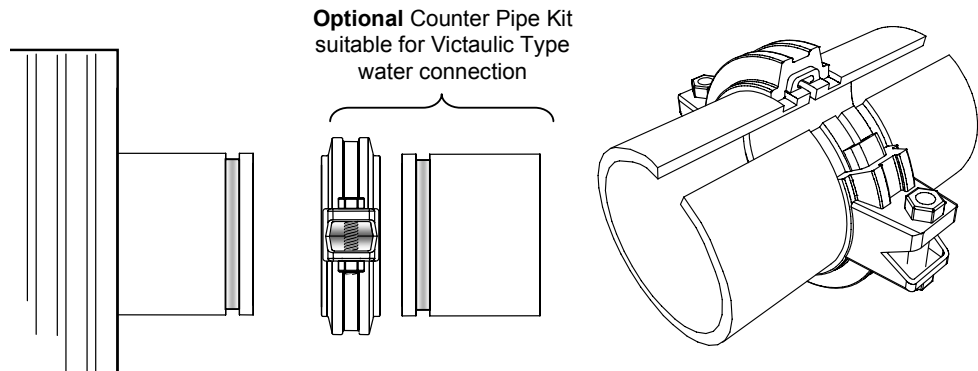

Installation Data

POINT LOADINGS, WEIGHTS & CENTRE OF GRAVITY (C OF G)

| Model D | | P1 | P2 | P3 | P4 | Operating Weight | C of G1 (mm) | C of G2 (mm) |
|----------|----|-----|-----|-----|-----|------------------|--------------|--------------|
| URAC75D | kg | 165 | 165 | 230 | 230 | 790 | 380 | 710 |
| URAC100D | kg | 175 | 175 | 240 | 240 | 830 | 380 | 710 |
| URAC125D | kg | 180 | 180 | 250 | 250 | 860 | 380 | 710 |
| URAC150D | kg | 255 | 255 | 340 | 340 | 1190 | 380 | 820 |
| URAC175D | kg | 275 | 275 | 370 | 370 | 1290 | 380 | 820 |
| URAC200D | kg | 300 | 300 | 390 | 390 | 1380 | 380 | 820 |
| URAC225D | kg | 315 | 315 | 410 | 410 | 1450 | 380 | 820 |
| URAC240D | kg | 560 | 560 | 210 | 210 | 1540 | 450 | 1442 |
| URAC250D | kg | 330 | 330 | 430 | 430 | 1520 | 380 | 820 |
| URAC270D | kg | 610 | 610 | 230 | 230 | 1680 | 450 | 1444 |
| URAC300D | kg | 660 | 660 | 250 | 250 | 1820 | 450 | 1445 |
| URAC330D | kg | 680 | 680 | 270 | 270 | 1900 | 450 | 1462 |
| URAC360D | kg | 710 | 710 | 280 | 280 | 1980 | 450 | 1459 |
| URAC400D | kg | 750 | 750 | 310 | 310 | 2120 | 450 | 1476 |
| URAC450D | kg | 800 | 800 | 340 | 340 | 2280 | 450 | 1486 |

| Model DQ | | P1 | P2 | P3 | P4 | Operating Weight | C of G1 (mm) | C of G2 (mm) |
|-----------|----|-----|-----|-----|-----|------------------|--------------|--------------|
| URAC75DQ | kg | 170 | 170 | 235 | 235 | 810 | 380 | 360 |
| URAC100DQ | kg | 180 | 180 | 248 | 248 | 855 | 380 | 710 |
| URAC125DQ | kg | 190 | 190 | 250 | 250 | 880 | 380 | 360 |
| URAC150DQ | kg | 260 | 260 | 355 | 355 | 1230 | 380 | 420 |
| URAC175DQ | kg | 285 | 285 | 378 | 378 | 1325 | 380 | 420 |
| URAC200DQ | kg | 305 | 305 | 405 | 405 | 1420 | 380 | 820 |
| URAC225DQ | kg | 325 | 325 | 420 | 420 | 1490 | 380 | 420 |
| URAC240DQ | kg | 580 | 580 | 230 | 230 | 1620 | 450 | 1461 |
| URAC250DQ | kg | 340 | 340 | 438 | 438 | 1555 | 380 | 820 |
| URAC270DQ | kg | 630 | 630 | 250 | 250 | 1760 | 450 | 1461 |
| URAC300DQ | kg | 680 | 680 | 270 | 270 | 1900 | 450 | 1462 |
| URAC330DQ | kg | 700 | 700 | 280 | 280 | 1960 | 450 | 1464 |
| URAC360DQ | kg | 730 | 730 | 300 | 300 | 2060 | 450 | 1474 |
| URAC400DQ | kg | 770 | 770 | 320 | 320 | 2180 | 450 | 1478 |
| URAC450DQ | kg | 820 | 820 | 350 | 350 | 2340 | 450 | 1488 |

| Model DSQ | | P1 | P2 | P3 | P4 | Operating Weight | C of G1 (mm) | C of G2 (mm) |
|------------|----|-----|-----|-----|-----|------------------|--------------|--------------|
| URAC75DSQ | kg | 175 | 175 | 248 | 248 | 845 | 380 | 710 |
| URAC100DSQ | kg | 190 | 190 | 255 | 255 | 890 | 380 | 700 |
| URAC125DSQ | kg | 195 | 195 | 263 | 263 | 915 | 380 | 710 |
| URAC150DSQ | kg | 270 | 270 | 363 | 363 | 1265 | 380 | 820 |
| URAC175DSQ | kg | 290 | 290 | 390 | 390 | 1360 | 380 | 820 |
| URAC200DSQ | kg | 310 | 310 | 418 | 418 | 1455 | 380 | 820 |
| URAC225DSQ | kg | 330 | 330 | 433 | 433 | 1525 | 380 | 820 |
| URAC240DSQ | kg | 580 | 580 | 230 | 230 | 1620 | 450 | 1461 |
| URAC250DSQ | kg | 345 | 345 | 450 | 450 | 1590 | 380 | 820 |
| URAC270DSQ | kg | 630 | 630 | 260 | 260 | 1780 | 450 | 1475 |
| URAC300DSQ | kg | 680 | 680 | 270 | 270 | 1900 | 450 | 1462 |
| URAC330DSQ | kg | 710 | 710 | 290 | 290 | 2000 | 450 | 1472 |
| URAC360DSQ | kg | 730 | 730 | 300 | 300 | 2060 | 450 | 1474 |
| URAC400DSQ | kg | 780 | 780 | 330 | 330 | 2220 | 450 | 1484 |
| URAC450DSQ | kg | 820 | 820 | 360 | 360 | 2360 | 450 | 1498 |

1 For C of G diagram refer to **Unit Lifting**.

Installation Data

UNIT LIFTING

- Employ lifting specialists.
- Local codes and regulations relating to the lifting of this type of equipment should be observed.
- Use the lifting eye bolts/lifting lugs provided.
- Attach lifting chains to the 4 lifting eye bolts/lifting lugs provided, each chain and eye bolt must be capable of lifting the whole chiller.
- Use the appropriate spreader bars/lifting slings with the holes/lugs provided.
- Lift the unit slowly and evenly.
- If the unit is dropped, it should immediately be checked for damage and reported to Airedale Service.

CAUTION  Only use lifting points provided.

The unit should be lifted from the base and where possible, with all packing and protection in position. If any other type of slinging is used, due care should be taken to ensure that the slings do not crush the casework or coil.

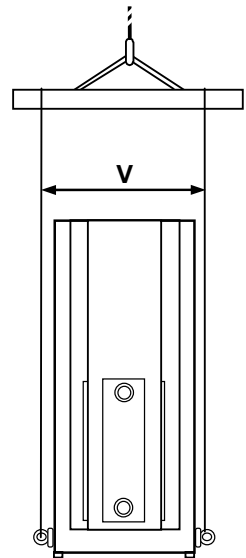
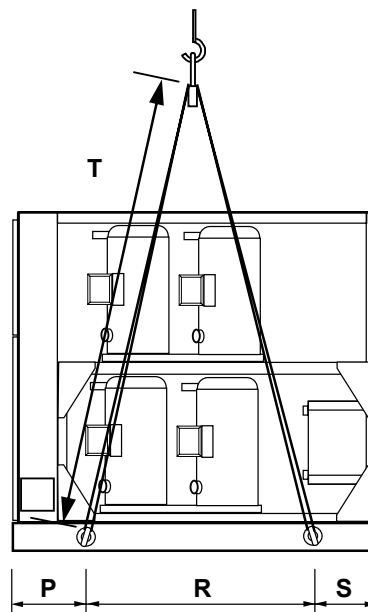
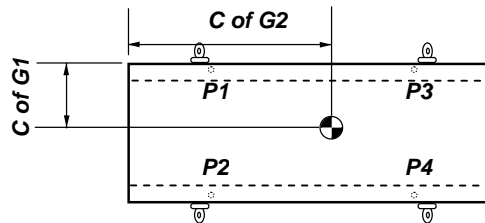

LIFTING DIMENSIONS

| | | P | R | S | T | V |
|----------------|----|-----|------|-----|------|-----|
| URAC 75 - 125 | mm | 370 | 1060 | 370 | 2100 | 850 |
| URAC 150 - 250 | mm | 370 | 1260 | 370 | 2100 | 850 |
| URAC 240 - 450 | mm | 885 | 1900 | 415 | 2100 | 990 |

Date: 18/10/05

MANUAL AFFECTED: TECHNICAL & INSTALLATION

ULTIMA: UCC/UCCU 30-450
UCFC/URAC/UWC75-450
UFC/USC200-750

MANUAL PART NO: 901-108 TM E 02/05/A

CHANGE:

ANTI-VIBRATION MOUNT (SPRING TYPE) SPECIFICATION & INSTALLATION INSTRUCTIONS:

COMPONENTS:

- 1 Locating Screw
- 2 Retaining Nut & Washer
- 3 Levelling Screw
- 4 Levelling Lock Nut
- 5 Retaining Studs
- 6a Upper Retaining Nuts
- 6b Lower Retaining Nuts
- 7 Spring assembly
- 8 Pressure Plate
- 9 Top Plate
- 10 Bolting-down holes

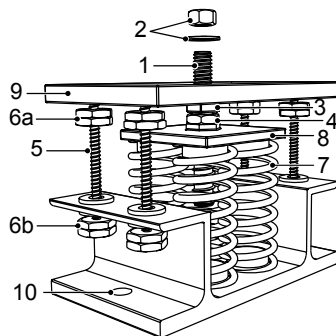

DIMENSIONS:

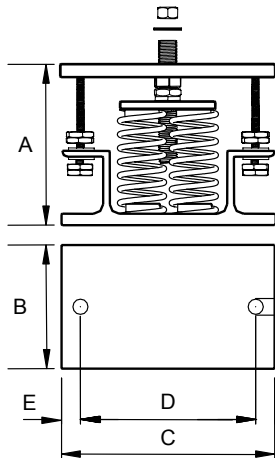

| | | A ⁽¹⁾ | B | C | D | E | FØ |
|----------------------------|----------|------------------|-----|-----|-----|----|----|
| UCC30-70 | 2 SPRING | 136 | 110 | 180 | 148 | 16 | 11 |
| UCC75, 80, 100, 125 & 150 | | | | | | | |
| UCCU30-70 | | | | | | | |
| UCCU75, 80, 100, 125 & 150 | | | | | | | |
| UCFC75-150 | | | | | | | |
| UCC110, 130, 160-450 | 4 SPRING | 180 | 130 | 225 | 186 | 20 | 16 |
| UCCU110, 130, 160-450 | | | | | | | |
| UCFC160-450 | | | | | | | |
| UFC200-750 | | | | | | | |
| URAC75-450 | | | | | | | |
| USC200-750 | | | | | | | |
| UWC75-450 | | | | | | | |

(1) Unloaded dimension

(2) Refer to relevant **Loose Parts Instructions** sheet for positioning of each mount.

INSTALLATION

- 1 Locate and secure mount using bolting down holes (10) in base plate.
- 2 Ensure mounts are located in line with the unit base.
- 3 If applicable, remove compressor enclosure covers to allow access to mount fixing holes in the unit base.
- 4 Lock the upper retaining nuts (6a) to the underside of the top plate (9) before a load is applied.
- 5 Remove retaining nut and washer (2), lower the unit onto the mounts and replace retaining nut and washer.
- 6 Beginning with the mount with the largest deflection, adjust the height of each mount using the levelling screw (3).

CAUTION **Mountings must be adjusted incrementally in turn. Do not fully adjust 1 mount at a time as this may overload and damage springs.**

7 When all mounts are level, lock each into place using the levelling lock nut (4).

8 Lock all retaining nuts (6a and 6b) to the extreme ends of the retaining studs (5).

CAUTION **Do not connect any services until all anti vibration mounts have been fully adjusted.**

Installation Data

ANTI VIBRATION MOUNTING - OPTIONAL

Spring Type (CLS)

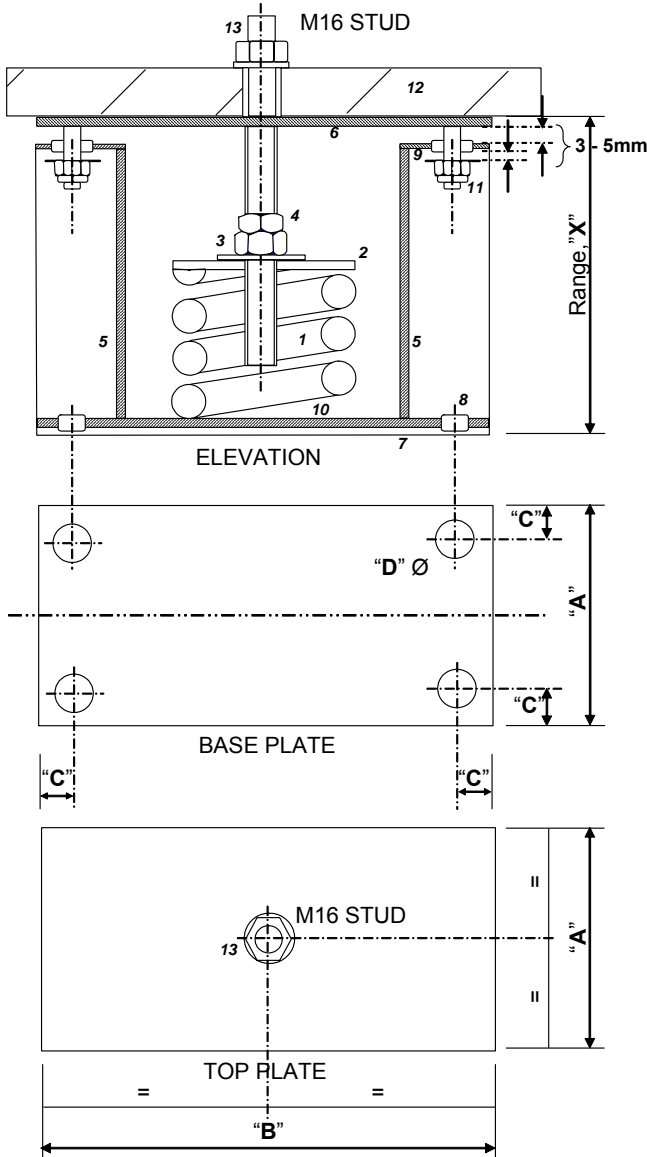

- 1 High deflection steel spring.
- 2 Spring pressure plate.
- 3 Height adjusting nut.
- 4 Locking nut.
- 5 Load bearing supports.
- 6 Load bearing top plate.
- 7 High frequency isolation pad.
- 8 10 dia holding down bolt holes.
- 9 High frequency isolation grommets.
- 10 Steel spring location rings.
- 11 Transportation/restraining bolts.
- 12 Machine frame.
- 13 Machine holding stud/nuts.

Selection:

| Model Size | A | B | C | D | Range, X |
|-----------------------|-----|-----|----|----|-----------|
| 75 - 250 (ex 240) mm | 75 | 150 | 15 | 10 | 120 - 150 |
| 240 - 450 (ex 250) mm | 100 | 200 | 20 | 14 | 180 - 210 |

Installation:

- 1 Locate and secure mount using bolting down holes provided in base plate.
- 2 Ensure mounts are located in line with the chiller base.
- 3 Position the machine using the centrally located stud, which allows the machine to be bolted down securely.
- 4 Loosen transit bolts and turn nut 3 clockwise until top plate 6 lifts clear of support posts. Tighten lock nut 4 when machine is at desired height and level.
- 5 Adjust and lock nuts on transit bolts such that a small (3-5mm) gap is left between washer and grommet. Refer to diagram.

CAUTION

Mountings must be adjusted in increments of no more than 1mm in turn. Do not adjust 1 mount completely at a time as this may overload and damage springs.

Do not connect any services until all anti vibration mounts have been fully adjusted.

FINALLY, recheck/adjust mounts following unit connection to services and system is filled with water.

Pad Type

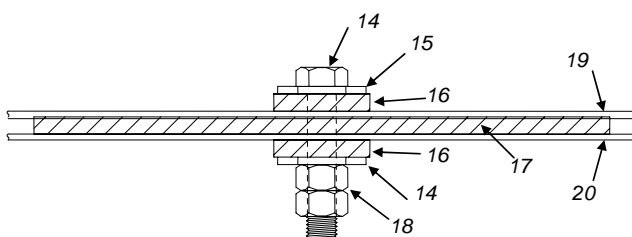

- 14 M16 Bolt (Not Supplied)
- 15 Washer (Not Supplied)
- 16 Fixing Pad 506-063
- 17 A V Pad 506-062
- 18 2 x M16 Nut (Not Supplied)
- 19 Unit Base
- 20 Unit Mounting Plinth

Installation Data

POSITIONING

The installation position should be selected with the following points in mind:

- Position on a stable and even base, levelled to ensure that the compressor operates correctly.
- Levelling should be to +/- 5mm
- Where vibration transmission to the building structure is possible, fit spring anti-vibration mounts and flexible water connections.
- Observe airflow and maintenance clearances.
- Pipework and electrical connections are readily accessible.
- Where multiple units are installed, due care should be taken to avoid the discharge air from each unit adversely affecting other units in the vicinity.

CAUTION  Prior to connecting services, ensure that the equipment is installed and completely level.

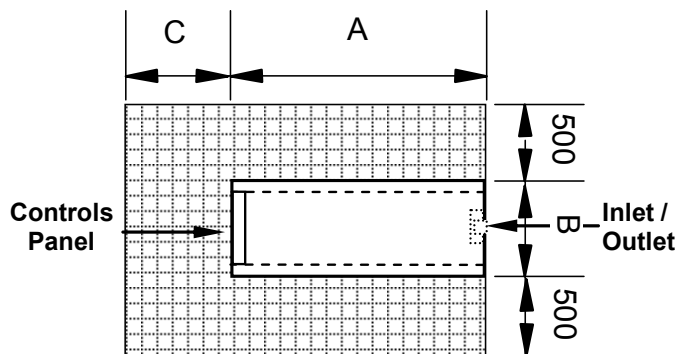

| Model Size | | A | B | C |
|-----------------------------|----|------|-----|-----|
| URAC75 – URAC125 | mm | 1800 | 760 | 760 |
| URAC150 – URAC250 (Ex. 240) | mm | 2000 | 760 | 760 |
| URAC240 – URAC450 (Ex. 250) | mm | 3200 | 900 | 900 |

Installation Data

REFRIGERATION SYSTEM

Pressure Testing

When installation is complete, fill the system with dry nitrogen to the required PED pressure, (Airedale recommends **27/40 bar**). Record the pressure over a period of time. If there is any reduction in pressure, trace the leak and repair before conducting a further pressure test.

Evacuation

Evacuation for systems operating on R407C(or optional R22) refrigerant should be carried out as follows (for other refrigerants refer to Airedale for advice):

- 1 The procedure should be carried out using a high vacuum pump. The pump should be connected to the high and low pressure sides of the system via a gauge manifold fitted with compound gauges. A high vacuum gauge should be fitted to the system at the furthest point from the vacuum pump.
- 2 Triple evacuation should be used to ensure that all contaminants are removed or at least reduced to significantly low proportions.
- 3 The vacuum pump should be operated until a pressure of 1.5 torr (200 Pa) absolute pressure is reached, at which time the vacuum pump should be stopped and the vacuum broken with oxygen free Nitrogen until the pressure rises above zero.
- 4 The above operation should be repeated a second time.
- 5 The system should then be evacuated a third time but this time to 0.5 torr absolute pressure and broken with the correct refrigerant, until pressures equalise between the charging bottle and the System.

Installation Data

PIPEWORK INSTALLATION - GOOD PRACTICES

Oil Traps

For long vertical rises in discharge lines, it is essential that oil traps are located every 6m to ensure proper oil movement / entrapment. In addition there should be an oil trap at the exit of the chiller before a vertical riser is applied (see example below).

Pipe Supports

The following table identifies the maximum distance between pipe supports on vertical and horizontal pipe runs.

| Pipe O/D (inches) | Support distance (m) |
|-------------------|----------------------|
| 3/8 - 5/8 | 2.0 |
| 7/8 - 1 1/8 | 2.5 |
| 1 3/8 - 2.0 | 3.0 |

Horizontal Sections

It is good practice to ensure a slight gradient toward the compressor in the direction of the refrigerant flow for suction lines running horizontal. This assists oil return to the compressor. A gradient of approximately 1:200 (0.5%) shall be used.

Condenser above Chiller

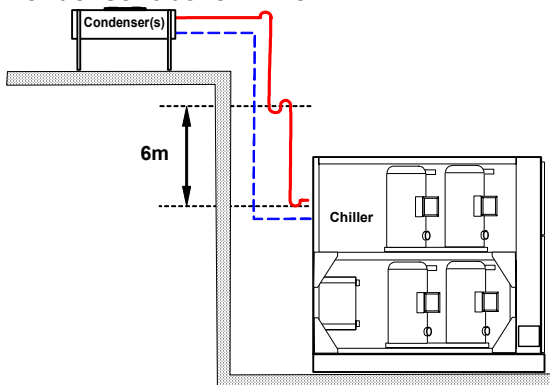

Condenser below Chiller

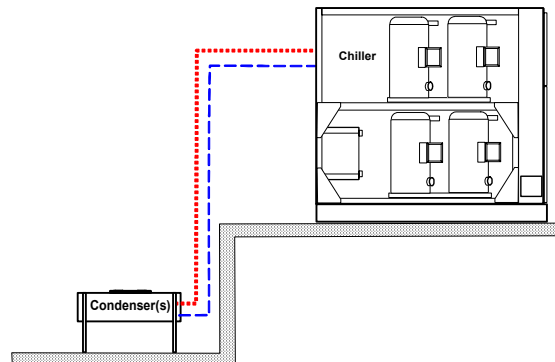

— Discharge Line Liquid

- 1 'U' oil traps to be installed at 6m intervals on suction line only.
- 2 Diagrams show 1 circuit only.



It is the responsibility of the installing contractor/site engineer to check the pipe sizes/refrigerant charge is correct for each system installation and application.

Split systems may require additional oil which should be added to the low side of each compressor.

Design should be in accordance with accepted refrigeration practice to ensure good oil return to the compressor(s) under all normal operating conditions.

Installation Data

WATER SYSTEM

Water pipework and ancillary components must be installed in accordance with:

- National and Local Water supply company standards.
- The manufacturer's instructions are followed when fitting ancillary components.
- The system water is treated to prevent corrosion and algae forming.
- In ambients of 0°C and below and when water supply temperatures of +5°C are required, the necessary concentration of Glycol or use of an electrical trace heater is added where static water can be expected.
- The schematic is referred to as a guide to ancillary recommendations.

CAUTION ▼ **The unit water connections are NOT designed to support external pipework, pipework should be supported during installation.**

The water flow commissioning valve set is not shown in the diagram, as the valve can be fitted elsewhere within the chilled water circuit.

Component Recommended Requirements

The recommended requirements to allow commissioning to be carried out correctly are:

- The inclusion of Binder Points adjacent to the flow and return connections, to allow temperature and pressure readings.
- A flow switch or equivalent, fitted adjacent to the water outlet side of the Chiller.

CAUTION ▼ **The correct operation of the flow switch is critical if the chiller warranty is to be valid.**

- A 20 mesh strainer fitted prior to the evaporator inlet.
- A water-flow commissioning valve set fitted to the system.
- In multiple chiller installations, 1 commissioning valve set is required per chiller
- Air vents are to be installed at all high points and where air is likely to be trapped at intermediate points.
- Drain points are to be installed at all low points in the system and in particular adjacent to the unit for maintenance to be carried out.
- Isolating valves should be installed adjacent to all major items of equipment for ease of maintenance.
- Balancing valves can be installed if required to aid correct system balancing.
- All chilled water pipework must be insulated and vapour sealed to avoid condensation.
- If several units are installed in parallel adjacent to each other, reverse return should be applied to avoid unnecessary balancing valves.

Standard Recommended Installation (Parts Supplied By Others)

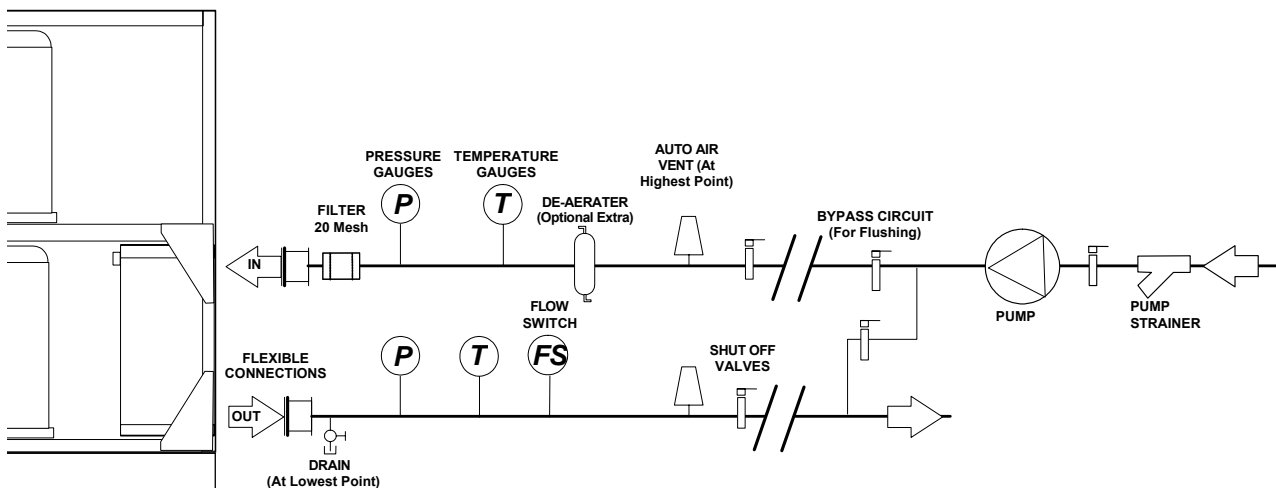

CAUTION ▼ **Constant water flow MUST be maintained. Variable water volume is NOT recommended.**

Installation Data

WATER SYSTEM

Pressure Testing

When all the pipework has been connected in the system, proceed as follows:

- Ensure all shut off and control valves are fully open.
- Pressurise system to the operating pressure, hold for 1 hour (a gradual fall in pressure shown on the gauge indicates a leak).
- Leaks should be found and repaired and the unit pressure tested for a further hour.

When the pressure remains at the operating pressure for 1 hour, the system can be considered leak free.

CAUTION  Although a pressure of 1.5 x working pressure is adequate for testing purposes, most local water authorities require 2 x working pressure.

Filling

CAUTION  The whole system **MUST** be flushed prior to filling to remove debris left in the water pipework by using a flushing bypass as shown to avoid serious damage to the plate evaporator.

During filling the system should be vented at all high points.

Once the system has been completely vented all vents should be closed.

To prevent air locking in the system it is advisable to fill the systems from the lowest point, ie drain point on pipework.

If auto air vents are used then we strongly recommend an auto pressurisation unit be fitted to the system.

| | | URAC75 | URAC100 | URAC125 | URAC150 | URAC175 |
|----------------------------------|-----------|---|-------------|-------------|-------------|-------------|
| Connections - Evaporator | | Suits "Victaulic" type Coupling & Pipe Assembly | | | | |
| Water Inlet / Outlet | mm / (in) | 65 (2 1/2") | 65 (2 1/2") | 65 (2 1/2") | 65 (2 1/2") | 65 (2 1/2") |
| Connections - Condenser | | | | | | |
| Discharge Line (brazed) | in | 1 1/8 | 1 1/8 | 1 3/8 | 1 5/8 | 1 5/8 |
| Liquid Line (brazed) | in | 7/8 | 7/8 | 1 1/8 | 1 3/8 | 1 3/8 |
| Water System - Evaporator | | | | | | |
| Min. System Water Volume (1) | l | 358 | 489 | 625 | 755 | 696 |
| Max. System Press | Bar | 10 | 10 | 10 | 10 | 10 |

| | | URAC200 | URAC225 | URAC240 | URAC250 | URAC270 |
|---------------------------------------|-----------|---|---------|---------|---------|---------|
| Connections - Evaporator | | Suits "Victaulic" type Coupling & Pipe Assembly | | | | |
| Water Inlet / Outlet | mm / (in) | 80 (3") | 80 (3") | 80 (3") | 80 (3") | 80 (3") |
| Connections - Condenser - CCT1 | | | | | | |
| Discharge Line (Brazed) | in | 1 5/8 | 1 5/8 | 1 5/8 | 1 5/8 | 1 5/8 |
| Liquid Line (Brazed) | in | 1 3/8 | 1 3/8 | 1 3/8 | 1 3/8 | 1 3/8 |
| Connections - Condenser - CCT2 | | | | | | |
| Discharge Line (Brazed) | in | N/A | N/A | 1 5/8 | N/A | 1 5/8 |
| Liquid Line (Brazed) | in | N/A | N/A | 1 3/8 | N/A | 1 3/8 |
| Water System - Evaporator | | | | | | |
| Min. System Water Volume (1) | l | 991 | 890 | 763 | 1235 | 995 |
| Max. System Press | Bar | 10 | 10 | 10 | 10 | 10 |

| | | URAC300 | URAC330 | URAC360 | URAC400 | URAC450 |
|---------------------------------------|-----------|---|---------|---------|---------|---------|
| Connections - Evaporator | | Suits "Victaulic" type Coupling & Pipe Assembly | | | | |
| Water Inlet / Outlet | mm / (in) | 80 (3") | 80 (3") | 80 (3") | 80 (3") | 80 (3") |
| Connections - Condenser - CCT1 | | | | | | |
| Discharge Line (Brazed) | in | 1 5/8 | 2 1/8 | 2 1/8 | 2 1/8 | 2 1/8 |
| Liquid Line (Brazed) | in | 1 3/8 | 1 5/8 | 1 5/8 | 1 5/8 | 1 5/8 |
| Connections - Condenser - CCT2 | | | | | | |
| Discharge Line (Brazed) | in | 1 5/8 | 1 5/8 | 2 1/8 | 2 1/8 | 2 1/8 |
| Liquid Line (Brazed) | in | 1 3/8 | 1 3/8 | 1 5/8 | 1 5/8 | 1 5/8 |
| Water System - Evaporator | | | | | | |
| Min. System Water Volume (1) | l | 1029 | 1289 | 1286 | 1498 | 1539 |
| Max. System Press | Bar | 10 | 10 | 10 | 10 | 10 |

(1) For minimum system volume, refer to the **Technical Manual**.

Installation Data

GLYCOL DATA

Glycol is recommended when a supply water temperature of +5°C or below is required or when static water can be exposed to freezing temperatures.

Ethylene Glycol Nominal Correction Factors

| Glycol in System / Freezing Point °C | 10% / -4°C | 20% / -9°C | 30% / -15°C | 40% / -23°C |
|--------------------------------------|------------|------------|-------------|-------------|
| Cooling Duty | 0.98 | 0.97 | 0.95 | 0.93 |
| Input Power | 0.99 | 0.98 | 0.96 | 0.95 |
| Water Flow | 0.99 | 1.02 | 1.04 | 1.07 |
| Pressure Drop | 1.05 | 1.20 | 1.38 | 1.57 |

Propylene Glycol Nominal Correction Factors

| Glycol in System / Freezing Point °C | 10% / -2°C | 20% / -6°C | 30% / -12°C | 40% / -20°C |
|--------------------------------------|------------|------------|-------------|-------------|
| Cooling Duty | 0.97 | 0.95 | 0.91 | 0.88 |
| Input Power | 0.99 | 0.98 | 0.96 | 0.95 |
| Water Flow | 0.98 | 0.97 | 0.95 | 0.95 |
| Pressure Drop | 1.08 | 1.17 | 1.31 | 1.45 |

Example URAC250D operating at 7/12°C water temperature & 45°C dew point, 20% Ethylene Glycol

| | | | | |
|-------------------|---|--------|-----------------------|----------|
| Cooling kW | (287.3) (refer to <i>Technical Data</i>) | x 0.97 | 20% Ethylene Glycol = | 278.7 kW |
| Input kW | (77.2) (refer to <i>Technical Data</i>) | x 0.98 | | 75.7 kW |
| Flow l/s | (13.7) (calculated: $\frac{\text{DX Cooling kW}}{\Delta T \times 4.19}$) | x 1.02 | | 14.0 l/s |
| Pressure Drop kPa | (47.0) (refer to <i>Waterside Pressure Drops</i>) | x 1.20 | | 56.4 kPa |

CAUTION  Waste glycol needs to be handled responsibly, recycled or turned over to professional personnel for correct disposal. Most anti-freeze manufacturers recommend that used anti-freeze be collected and disposed according to Local Legislation. Waste glycol should NOT be drained onto the ground, rainwater drainage system or natural waters.

If the glycol contains heavy metals or other contaminants from gas or oil, the level of hazard posed by the glycol is increased and could be characterised as hazardous waste.

STEPS IF GLYCOL IS RELEASED/SPILLED

Small spill - soak up with absorbent material.

Large spill - contain spill and pump to suitable container for disposal.

Installation Data

ELECTRICAL DATA

General

- As standard the equipment is designed for 400V, 3 phase, 3 wire 50Hz and a separate permanent 230V, 1 phase, 50Hz supply, to all relevant IEE regulations, British standards and IEC requirements.
- A fused and isolated electrical supply of the appropriate phase, frequency and voltage should be installed.
- The control voltage to the interlocks is 24V. Always size the low voltage interlock and protection cabling for a maximum voltage drop of 2V.

CAUTION  **Wires should be capable of carrying the maximum load current under non-fault conditions at the stipulated voltage.**

- Avoid large voltage drops on cable runs, particularly low voltage wiring.
- Once the connecting pipework is complete the electrical supply can be connected by routing the cable through the appropriate casing hole and connecting the cables, refer to the **Wiring Diagram** supplied with each unit.

CAUTION  **A separately fused, locally isolated, permanent single phase and neutral supply MUST BE FITTED for the compressor sump heater, evaporator trace heating and control circuits, FAILURE to do so could INVALIDATE WARRANTY.**

Interlocks & Protection

Always electrically interlock the operation of the chiller with the pump controls and water flow switch.

These safety devices prevent the chiller operating with low water flow which can cause serious damage.

CAUTION  **Failure to install both safety devices will invalidate the chiller warranty.**

CAUTION  **Do not rely solely on the BMS to protect the chiller against low flow conditions.**

An evaporator pump interlock and flow switch **MUST** be directly wired to the chiller, refer to **Interconnecting Wiring** diagram.

INTERCONNECTING WIRING

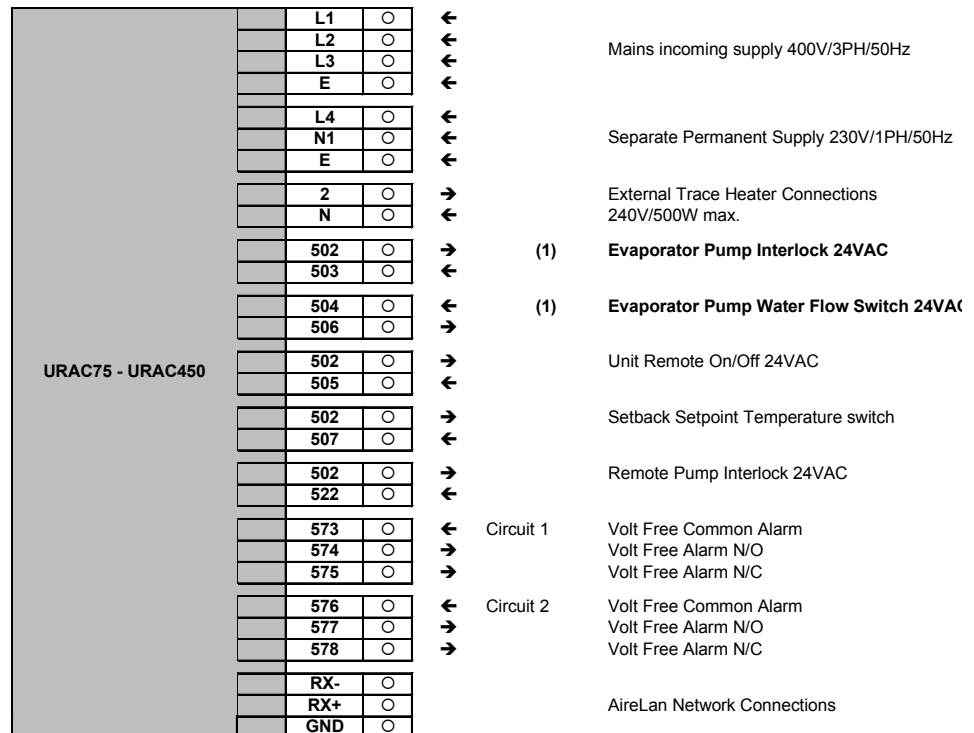

CAUTION  **(1) MUST be directly wired to the chiller to validate warranty.**

Installation Data

| ELECTRICAL DATA | | | URAC75 | URAC100 | URAC125 | URAC150 | URAC175 |
|--|-----|-----------------|--------|---------|-----------------------------|---------|------------|
| Unit Data | | | | | | | |
| Nominal Run Amps | (1) | A | 46 | 57 | 65 | 80 | 90 |
| Maximum Start Amps | (2) | A | 134 | 170 | 216 | 258 | 290 |
| Permanent Supply | | VAC | | | 230V 1PH 50Hz | | |
| Mains Supply | | VAC | | | 400V 3PH 50Hz | | |
| Rec Permanent Fuse Size | | A | 16 | 16 | 16 | 16 | 16 |
| Rec Mains Fuse Size | | A | 63 | 80 | 100 | 125 | 125 |
| Max Permanent Incoming Cable Size | | mm ² | | | 4 mm ² terminals | | |
| Max Mains Incoming Cable Size | | mm ² | | | 70 (direct to MCCB) | | |
| Control Circuit | | VAC | | | 24V/230VAC | | |
| Evaporator | | | | | | | |
| Pad Heater Rating | | W | 40 | 40 | 40 | 80 | 100 |
| External Trace Heating | | | | | | | |
| Available (fitted by others) | | W | 500 | 500 | 500 | 500 | 500 |
| Compressor - Per Compressor | | | | | | | |
| Quantity | | | 4 | 4 | 4 | 4 | 2+2 |
| Motor Rating | | kW | 5.3 | 7.3 | 9.1 | 10.9 | 10.9/14.4 |
| Nominal Run Amps | (1) | A | 11.5 | 14.2 | 16.3 | 20.0 | 20.0/25.2 |
| Crankcase Heater Rating | | W | 70.0 | 70.0 | 70.0 | 70.0 | 70.0/120.0 |
| Start Amps | (2) | | 99 | 127 | 167 | 198 | 198/225 |
| Type Of Start | | | | | Direct on line | | |
| OPTIONAL EXTRAS | | | | | | | |
| Power Factor Correction | | | | | | | |
| Nominal Run Amps | (1) | A | 41 | 51 | 58 | 72 | 81 |
| Maximum Start Amps | (2) | A | 130 | 165 | 211 | 252 | 283 |
| Recommended Mains Fuse | | A | 63 | 80 | 100 | 100 | 125 |
| Compressor Nominal Run Amps - Per Compressor | | A | 10.3 | 12.7 | 14.6 | 17.9 | 17.9/22.5 |
| Electronic Soft-Start | | | | | | | |
| Nominal Run Amps | (1) | A | 46 | 57 | 65 | 80 | 90 |
| Maximum Start Amps | (2) | A | 90 | 119 | 149 | 179 | 200 |
| Recommended Mains Fuse | | A | 63 | 80 | 100 | 125 | 125 |

- (1) Based at 12/7°C water and 45°C dew point
 (2) Starting amps refers to the direct on line connections.

Installation Data

| ELECTRICAL DATA | | | URAC200 | URAC225 | UWC240 | URAC250 | UWC270 |
|--|-----|-----------------|---------|-------------|-----------------------------|---------|------------|
| Unit Data | | | | | | | |
| Nominal Run Amps | (1) | A | 101 | 115 | 120 | 129 | 141 |
| Maximum Start Amps | (2) | A | 301 | 355 | 298 | 369 | 314 |
| Permanent Supply | | VAC | | | 230V 1PH 50Hz | | |
| Mains Supply | | VAC | | | 400V 3PH 50Hz | | |
| Rec Permanent Fuse Size | | A | 16 | 16 | 16 | 16 | 16 |
| Rec Mains Fuse Size | | A | 160 | 160 | 160 | 200 | 200 |
| Max Permanent Incoming Cable Size | | mm ² | | | 4 mm ² terminals | | |
| Max Mains Incoming Cable Size | | mm ² | | | 70 (direct to MCCB) | | |
| Control Circuit | | VAC | | | 24V/230VAC | | |
| Evaporator | | | | | | | |
| Pad Heater Rating | | W | 100 | 100 | 100 | 100 | 100 |
| External Trace Heating | | | | | | | |
| Available (fitted by others) | | W | 500 | 500 | 500 | 500 | 500 |
| Compressor - Per Compressor | | | | | | | |
| Quantity | | | 4 | 2+2 | 3+3 | 4 | 3+3 |
| Motor Rating | | kW | 14.4 | 14.4/17.9 | 10.9/10.9 | 17.9 | 10.9/14.4 |
| Nominal Run Amps | (1) | A | 25.2 | 25.2/32.2 | 20.0/20.0 | 32.2 | 20.0/25.2 |
| Crankcase Heater Rating | | W | 120.0 | 120.0/150.0 | 70.0/70.0 | 150.0 | 70.0/120.0 |
| Start Amps | (2) | | 225 | 225/272 | 198/198 | 272 | 198/225 |
| Type Of Start | | | | | Direct on line | | |
| OPTIONAL EXTRAS | | | | | | | |
| Power Factor Correction | | | | | | | |
| Nominal Run Amps | (1) | A | 90 | 103 | 112 | 115 | 126 |
| Maximum Start Amps | (2) | A | 293 | 346 | 288 | 358 | 301 |
| Recommended Mains Fuse | | A | 125 | 160 | 125 | 160 | 160 |
| Compressor Nominal Run Amps - Per Compressor | | A | 22.5 | 22.5/28.8 | 17.9/17.9 | 28.8 | 17.9/22.5 |
| Electronic Soft-Start | | | | | | | |
| Nominal Run Amps | (1) | A | 101 | 115 | 120 | 129 | 141 |
| Maximum Start Amps | (2) | A | 211 | 246 | 219 | 260 | 234 |
| Recommended Mains Fuse | | A | 160 | 160 | 160 | 200 | 200 |

- (1) Based at 12/7°C water and 45°C dew point
 (2) Starting amps refers to the direct on line connections.

Installation Data

| ELECTRICAL DATA | | | URAC300 | URAC330 | URAC360 | URAC400 | URAC450 |
|--|-----|-----------------|-------------|-------------|-----------------------------|-------------|-------------|
| Unit Data | | | | | | | |
| Nominal Run Amps | (1) | A | 158 | 180 | 201 | 228 | 252 |
| Maximum Start Amps | (2) | A | 376 | 412 | 433 | 497 | 522 |
| Permanent Supply | | VAC | | | 230V 1PH 50Hz | | |
| Mains Supply | | VAC | | | 400V 3PH 50Hz | | |
| Rec Permanent Fuse Size | | A | 16 | 16 | 16 | 16 | 16 |
| Rec Mains Fuse Size | | A | 200 | 250 | 250 | 315 | 315 |
| Max Permanent Incoming Cable Size | | mm ² | | | 4 mm ² terminals | | |
| Max Mains Incoming Cable Size | | mm ² | | | 70 (direct to MCCB) | | |
| Control Circuit | | VAC | | | 24V/230VAC | | |
| Evaporator | | | | | | | |
| Pad Heater Rating | | W | 100 | 100 | 100 | 100 | 100 |
| External Trace Heating | | | | | | | |
| Available (fitted by others) | | W | 500 | 500 | 500 | 500 | 500 |
| Compressor - Per Compressor | | | | | | | |
| Quantity | | | 3+3 | 3+3 | 3+3 | 3+3 | 3+3 |
| Motor Rating | | kW | 14.4/14.4 | 17.9/14.4 | 17.9/17.9 | 22.5/17.9 | 22.5/22.5 |
| Nominal Run Amps | (1) | A | 25.2/25.2 | 32.2/25.2 | 32.2/32.2 | 40.3/32.2 | 40.3/40.3 |
| Crankcase Heater Rating | | W | 120.0/120.0 | 150.0/120.0 | 150.0/150.0 | 150.0/150.0 | 150.0/150.0 |
| Start Amps | (2) | | 225/225 | 272/225 | 272/272 | 320/272 | 320/320 |
| Type Of Start | | | | | Direct on line | | |
| OPTIONAL EXTRAS | | | | | | | |
| Power Factor Correction | | | | | | | |
| Nominal Run Amps | (1) | A | 141 | 161 | 180 | 204 | 226 |
| Maximum Start Amps | (2) | A | 363 | 397 | 416 | 479 | 501 |
| Recommended Mains Fuse | | A | 200 | 200 | 200 | 250 | 315 |
| Compressor Nominal Run Amps - Per Compressor | | A | 22.5/22.5 | 28.8/22.5 | 28.8/28.8 | 36.1/28.8 | 36.1/36.1 |
| Electronic Soft-Start | | | | | | | |
| Nominal Run Amps | (1) | A | 158 | 180 | 201 | 228 | 252 |
| Maximum Start Amps | (2) | A | 276 | 303 | 324 | 369 | 394 |
| Recommended Mains Fuse | | A | 200 | 250 | 250 | 315 | 315 |

- (1) Based at 12/7°C water and 45°C dew point
 (2) Starting amps refers to the direct on line connections.

AIRETronix - Controls

CONTROL SCHEME FEATURES

Airedale recognises that all chiller applications are different but fall mainly into 2 application categories; Variable Supply Temperature and Constant Supply Temperature.

The onboard microprocessor has the capability of satisfying either control requirement as illustrated below. Using the Airedale Variable Supply Temperature control scheme, energy savings are available when compared with previous schemes and that of the Constant Supply Temperature application.

Variable Supply Temperature control schemes offer energy savings where the supply water temperature is not critical to its operation.

Selection of the best application control scheme can be made via a soft switch in the microprocessor during initial commissioning.

Examples based on Models URAC200D having 6 Stages of Cooling

Variable Supply Temperature Control

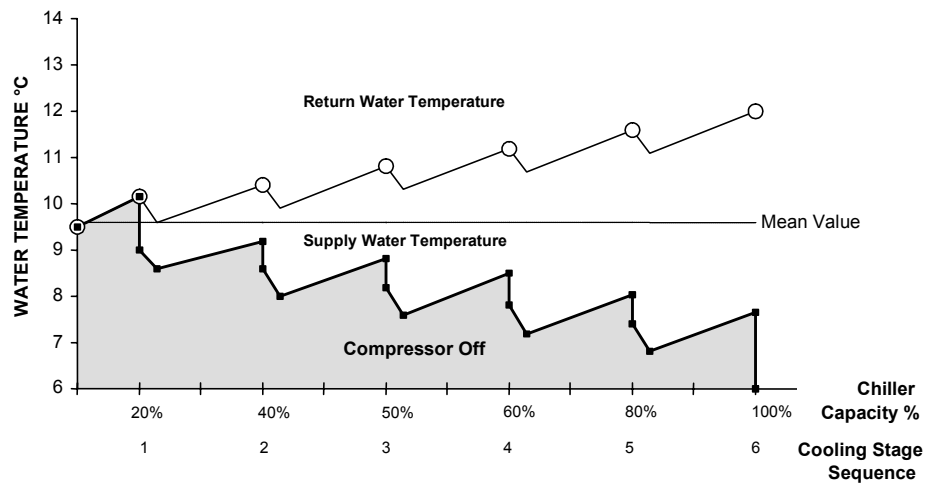

Constant Supply Temperature Control

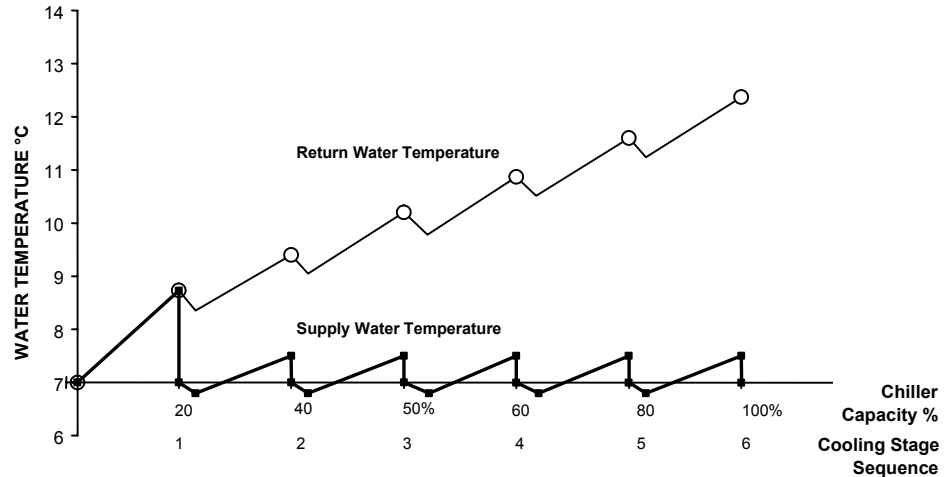

CAUTION Factory set to Variable Supply Temperature Control unless otherwise stated at order.

Only when the mode selection has been set can the unit be enabled.

AIRETronix - Controls

GENERAL

The microprocessor controller offers powerful analogue and digital control to meet a wide range of monitoring and control features including a real time clock and Industry standard communication port and network connections.

The controller's inbuilt display is used for viewing the unit operating status and making adjustments to control parameters by allowing the operator access to a series of display pages.

OPERATION

Standard Keypad /Display

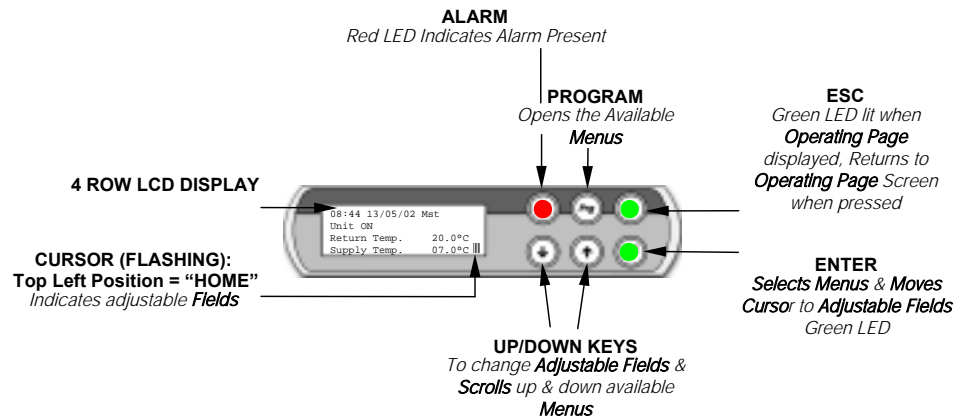

Navigation

The display is used for **Viewing Unit Operating Status** and **Adjusting Customer Control Settings** by allowing the operator access to a series of **Menus & sub-menus**. Viewing information is unrestricted, however set up and adjustment requires password entry, refer to **Password Protection**.

Initially, use the **Prg** key to **access Menus**, the symbol ← will appear top right and the first menu will appear in CAPITALS, these **indicators** shows which menu is selected.

Use the **↓** **↑** keys to **move the indicator ←** to the desired menu and press **↩** to **open the menu**.

Use the **↩** key to **move the flashing cursor █** to adjustable **fields** and the **↓** **↑** keys to change the values.

Press the **↩** key to **move the cursor to the next field or Home**.

When the cursor is **Home** either use the **↓** **↑** keys to scroll to next **sub-menu** or the **Esc** to **exit and return to the Standard Operating page**.

Standard Operating Page

The **Operating Page** will appear and remain present following start up of the controller as illustrated:

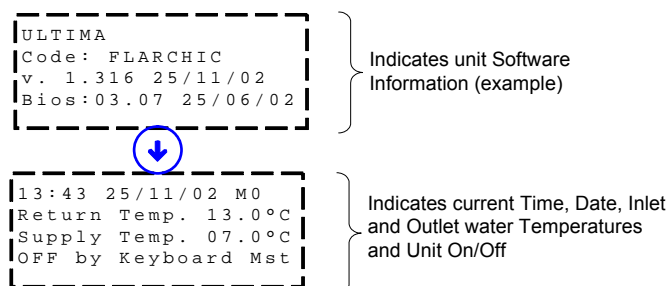

AIRETronix - Controls

OPERATION (CONT..)

Standard Operating Page cont.

The following **Menus** can be accessed from the **Operating Page**, it is recommended that the display is always returned to the **Operating Page** by using the  key

Password Protection

To guard against unauthorised adjustments, a password is required to gain access to certain menus as defined below.

FACTORY SET PASSWORD PIN NUMBER: 4648 (or Customer chosen number).



When a password is requested use the   keys to enter the number and  to access the page.

Menus (Listed in Sequence)

| Menu | Description | Password |
|----------------------|--|----------------------|
| Switch On/Off | Enable or Disable the unit | Open Access |
| Service | Allows selection of setpoint limits, enables unit on/off from display, remote on/off and remote pump on/off. | Default 4648 |
| Setpoint | Allows setpoint adjustment, includes supply temperature setpoint and unit temperature differential. | Default 4648 |
| Status | Displays current status on digital and analogue inputs and outputs. | Open Access |
| Maintenance | Displays hours run for compressors and pumps (if fitted). Also includes Electronic Expansion Valves (if fitted). | Default 4648 |
| Clock | Allows adjustment of real time clock, time zones | Default 4648 |
| Alarm Log | Display last 100 alarms in chronological order. | Open Access |
| Manufacturer | Factory use only. | Airedale Only |

SETTING UP

Unit ON/OFF

By pressing the  and  simultaneously for approximately 5 seconds, the unit operation will stop or start. The unit can also be enabled through the Switch On/Off menu.

Real Time Clock

The units leave the factory set, however follow the **Navigation** instructions if necessary.

Time Zones

The programme provides 3 On/Off periods per day, 7 days per week. The unit is factory set for continuous operation.

Technical Support

For further details, please contact Airedale.

AIRETronix - Controls

VIEWING UNIT OPERATING STATUS

Status Menu

Allows access to view operating status of Digital and Analogue Inputs and Outputs.

Using the **Navigation** instructions, the following **Sub-Menus** shown in sequence can be accessed:

| Digital Inputs | |
|-----------------------|---|
| ID1 | Phase Rotation (Optional) or MCCB status |
| ID2 | Emergency Stop |
| ID3 | Evaporator Flow Switch |
| ID4 | Remote On/Off (Optional) |
| ID5 | Compressor 1 Contactor Status |
| ID6 | Compressor 2 Contactor Status |
| ID7 | Compressor 3 Contactor Status |
| ID8 | Compressor 4 Contactor Status |
| ID9 | Circuit 1 Low Pressure Switch |
| ID10 | Circuit 2 Low Pressure Switch |
| ID11 | Pump 1 Contactor Status (Optional) or Remote Pump Interlock |
| ID12 | Pump 2 Contactor Status (Optional) |
| ID13 | Remote Pump On/Off (Optional) |
| ID14 | Remote Summer/Winter Or Night Setback (Optional) |
| ID15 | Not Used |
| ID16 | Not Used |
| ID17 | Compressor 5 Contactor Status |
| ID18 | Compressor 6 Contactor Status |

| Analogue Inputs Standard | |
|---------------------------------|---|
| B1 | Circuit 1 Liquid Pressure |
| B2 | Circuit 2 Liquid Pressure |
| B3 | Circuit 1 Suction Pressure (Not connected with EEV option) or Leak Detector |
| B4 | Return Water Temperature |
| B5 | Supply Water Temperature |
| B6 | Circuit 2 Suction Pressure (Not connected with EEV option) or Leak Detector |
| B7 | Chilled Water Differential Pressure (Optional) |
| B8 | Remote Setpoint Adjustment or Condenser Water Inlet |
| B9 | Evaporator Inlet Water or Coil 1 Temperature |
| B10 | Ambient or Coil 2 Temperature |

| Analogue Inputs Fitted with Electronic Expansion Valve Option (EEV) | |
|--|---|
| B1 | Circuit 1 & Circuit 2 Suction Temperature |
| B3 | Circuit 1 & Circuit 2 Suction Pressure |

| Digital Outputs | |
|------------------------|----------------------------------|
| NO1 | Compressor Contactor 1 |
| NO2 | Compressor Contactor 2 |
| NO3 | Pump 1 Contactor (Optional) |
| NO4 | Compressor Contactor 3 |
| NO5 | Compressor Contactor 4 |
| NO6 | Pump 2 Contactor (Optional) |
| NO7 | Circuit 1 Condenser Coil Valve 1 |
| NO8 | Circuit 1 Condenser Coil Valve 2 |
| NO9 | Circuit 2 Condenser Coil Valve 1 |
| NO10 | Circuit 2 Condenser Coil Valve 2 |
| NO11 | Not Used |
| NO12 | Alarm Circuit 1 |
| NO13 | Alarm Circuit 2 |
| NO14 | Circuit 1 Reversing Valve |
| NO15 | Circuit 2 Reversing Valve |
| NO16 | Supplementary Heat |
| NO17 | Compressor 5 Contactor |
| NO18 | Compressor 6 Contactor |

| Analogue Outputs | |
|-------------------------|--|
| Y1 | Not Used |
| Y2 | Circuit 1 & 2 Condenser Fan Speed Controller (Modulated Head Pressure Control) |
| Y3 | Circuit 2 Condenser Fan Speed Controller (Modulated Head Pressure Control) |

AIRETronix - Controls







ALARMS

The controller logs and allows viewing of the last 100 conditions recorded in descending chronological order.

```

13/05/02      11:32
Event number   001
Alarm Active
37-Diff Pressr Evap
    
```

Alarm Handling

- 1 A **Red LED** behind the **Alarm**  key will light in the event of an alarm. To view the alarms, simply press the  key and the   keys to scroll through.
- 2 Auto reset alarms will clear following this first depression of the **Alarm**  key. If however the **Red LED** behind the **Alarm**  key remains illuminated, the unit requires some form of manual reset.
- 3 For manual reset alarms, isolate the affected circuits before further investigation.
- 4 To reset or delete the alarms displayed in the alarm screen, simply press  again.

COMMON ALARMS

Outlined below is a selection of Common Alarms, a full list is available, please contact Airedale.

Phase Rotation

A normally closed contact. When Phase Rotation is incorrect all controller outputs are de-activated.

Emergency Stop

A normally open contact. On closing, all controller outputs are de-activated.

Evaporator Flow Failure

A normally closed contact. On opening, all controller outputs are de-activated.

Low Supply Temperature

Supply Water Temperature Low Limit alarm is generated when the supply water temperature falls below the low limit value set. All controller outputs are de-activated.

INDIVIDUAL CIRCUIT ALARMS

Outlined below is a selection of Individual Circuit Alarms, a full list is available, please contact Airedale.

Electronic Expansion Valve Failure

This indicates that the electronic expansion valve controller has detected an operating problem.

Low Suction Pressure

When the suction pressure sensor value falls below the value set by the low suction level for a period exceeding 1 minute (or 3 minutes on compressor start-up), a visual alarm will be generated at the in-built display and the relevant compressor will be de-activated. On units with tandem compressors, both compressors from the same circuit will be switched off.

High Liquid Pressure

When the liquid pressure reaches 25 BarG, the relevant circuit will be switched off and an alarm activated, this can only be rectified by manual reset via the microprocessor.

Compressor Status

A normally closed contact when the compressor is operating. If this contact remains open for a period of 3 seconds during operation of the compressor, a visual alarm is generated and the relevant compressor will be de-activated. This alarm comprises of compressor motor protection module, discharge gas thermostat and safety high pressure switch.

Commissioning Data

OPERATING LIMITS (For 100% Water)

| | |
|--------------------------------------|----------------------------------|
| Minimum Ambient Air DB °C | -5°C |
| Maximum Ambient Air DB °C | Refer to <i>Technical Manual</i> |
| Minimum Leaving Water Temperature °C | +6°C |
| Maximum Return Water Temperature °C | +20°C |

- 1 Temperatures lower than those stated can be obtained with the addition of glycol.
 2 For conditions outside those quoted, please refer to Airedale.

MECHANICAL DATA

| Oil & Refrigerant Charges | URAC75 | URAC100 | URAC125 | URAC150 | URAC175 |
|---------------------------|----------------------------|---------|---------|---------|---------------|
| Compressor | Tandem Scroll – Hermetic | | | | |
| Quantity | 4 | 4 | 4 | 4 | 4 |
| Oil Charge Volume (Total) | 4 x 4.1 | 4 x 4.1 | 4 x 4.1 | 4 x 4.1 | 2 x 4.7 + 4.1 |
| Oil Type | Polyol Ester | | | | |
| Refrigeration | Dual Circuit | | | | |
| Refrigerant Control | Electronic Expansion Valve | | | | |
| Refrigerant Type | R407C | | | | |
| Holding Charge | Dry Nitrogen | | | | |

| | URAC200 | URAC225 | URAC240 | URAC250 | URAC270 |
|---------------------------|----------------------------|---------------|------------------------|--------------------------|------------------------|
| Compressor | Tandem Scroll - Hermetic | | Trio Scroll – Hermetic | Tandem Scroll - Hermetic | Trio Scroll – Hermetic |
| Quantity | 4 | 4 | 6 | 4 | 6 |
| Oil Charge Volume (Total) | 4 x 4.7 | 2 x 6.3 + 4.7 | 6 x 4.1 | 4 x 6.3 | 3 x 4.7 & 3 x 4.1 |
| Oil Type | Polyol Ester | | | | |
| Refrigeration | Dual Circuit | | | | |
| Refrigerant Control | Electronic Expansion Valve | | | | |
| Refrigerant Type | R407C | | | | |
| Holding Charge | Dry Nitrogen | | | | |

| | URAC300 | URAC330 | URAC360 | URAC400 | URAC450 |
|---------------------------|----------------------------|---------------|---------|-------------------|---------|
| Compressor | Trio Scroll - Hermetic | | | | |
| Quantity | 6 | 6 | 6 | 6 | 6 |
| Oil Charge Volume (Total) | 6 x 4.7 | 2 x 6.3 + 4.7 | 6 x 6.3 | 3 x 5.9 & 3 x 6.3 | 6 x 5.9 |
| Oil Type | Polyol Ester | | | | |
| Refrigeration | Dual Circuit | | | | |
| Refrigerant Control | Electronic Expansion Valve | | | | |
| Refrigerant Type | R407C | | | | |
| Holding Charge | Dry Nitrogen | | | | |

Commissioning Data

WATERSIDE PRESSURE DROPS

CAUTION  Constant water flow **MUST** be maintained. Variable water volume is **NOT** recommended.

UWC75 – UWC250
(Except UWC240)

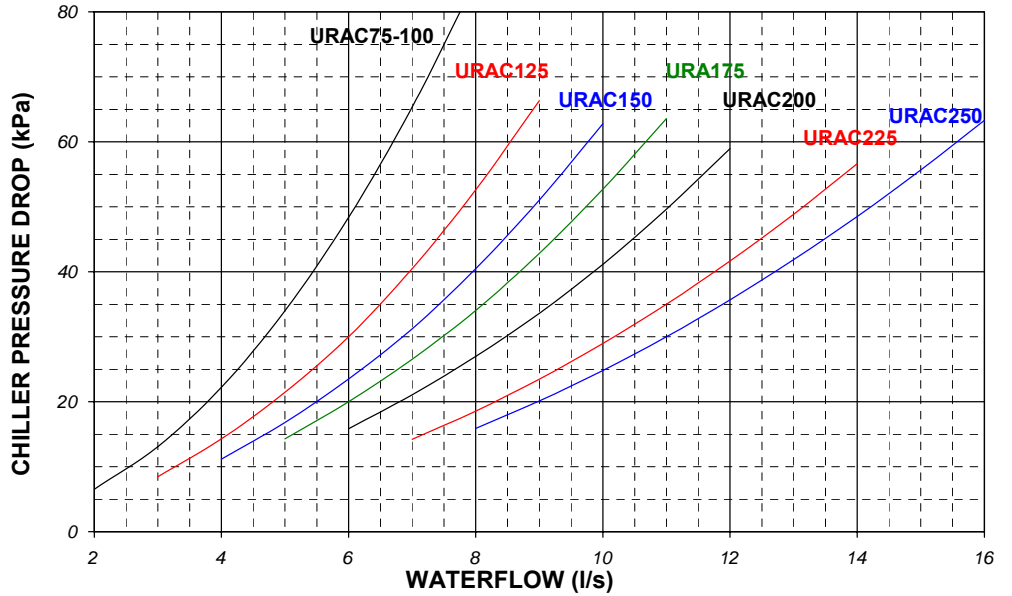

URAC240 – URAC450
(Except URAC250)

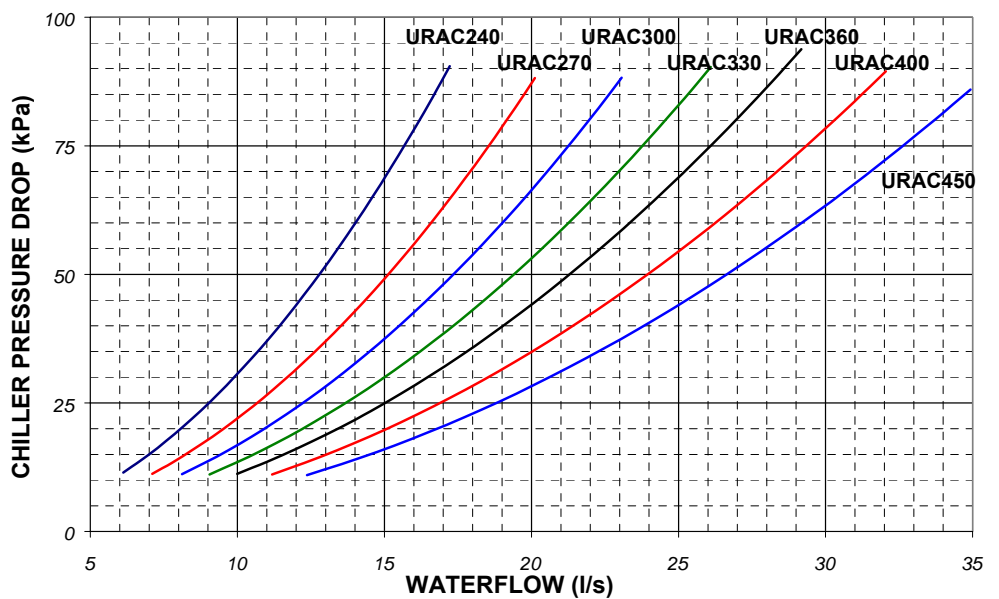

(1) For glycol solutions, please refer to [Glycol Data](#).

Commissioning Data

OPERATIONAL SEQUENCE

Refrigerant Charge Check for the presence of a refrigerant charge in the condenser side.

Crankcase Heater (If fitted) The mains supply to the crankcase (oil) heater should be switched on at least 8 hours prior to compressor starting to avoid refrigerant migration.

CAUTION  **A separately fused, locally isolated, permanent single phase and neutral supply MUST BE FITTED for the compressor sump heater, evaporator trace heating and control circuits, FAILURE to do so could INVALIDATE WARRANTY.**

Pre-Start-Up Check Before compressor start-up, make sure that an oil level is showing in the compressor sight glass, and that all refrigerant ball valves are opened.

CAUTION  **Check phase rotation by connecting pressure gauges to the suction and discharge ports, if no differential pressure occurs, isolate immediately.**

Adding Refrigerant Additional refrigerant should be added to the system via 1/4" schrader connection on the expansion line if required.

Pump Down Never pump down without the low pressure trip and high discharge temperature switches being operative.

UNLOADING PROTECTION

Head Pressure The microprocessor has inbuilt protection against nuisance trips. If the head pressure rises above 23BarG the system will unload 1 compressor and remain unloaded until the head pressure drops below 21BarG.

Low Pressure If low pressure drops below the microprocessor setting, the compressor will unload to 1 compressor, if low pressure persists for 1 minute, the circuit will be switched off and sound an alarm.

Commissioning Procedure

GENERAL

To be read in conjunction with the commissioning sheets provided, items highlighted should be recorded.

CAUTION  Please ensure all documents have been completed correctly and return to Airedale Service immediately to validate warranty.

PRE COMMISSIONING CHECKLIST

CAUTION  ALL work **MUST** be carried out by Technically Trained competent personnel.

The equipment contains live electrical and moving parts, **ISOLATE** prior to maintenance or repair work.

The door interlocking MCCB should be in the **OFF** position and the auxiliary alarm contact from the MCCB should be linked out.

Ensure all items listed in the Pre commissioning section are complete.

RECORD  The unit should be visually inspected and any damage noted.





- Secure commissioning gauges to the high side of the system, check for a positive charge.
- Check tightness of electrical components.
- Check that the remote on/off switch (if fitted) is in the off position.
- With the MCBs in the off position measure the incoming voltage.
- Check Phase Rotation.
- Check voltage at permanent supply.
- Measure and record the primary (230V) and secondary (24V) voltages at each of the transformers, adjust tapping if necessary and record on the commissioning document.
- Check all timer settings are correct.
- Check Sump Heater.
- Check oil level.
- Check water filter is fitted.
- Check design water flow is available.
- Check flow switch and pump interlocks are fitted to the water system and wired directly to the chiller.
- Switch on the controls and individual circuits, primary and secondary, MCBs to the ON position. At this stage the control display panel should be illuminated.
- Record Optional Extras.
- Record Controller Data.

CAUTION  Disable remote ON/OFF to ensure the unit does not start unintentionally.

The chiller will not start until microprocessor control SWITCH 1 is in the ON position. **DO NOT SWITCH TO ON AT THIS STAGE**

- Adjust the water temperature supply and return set points (if necessary) to call for 100% cooling (refer to the **Controls** section).
- Ensure all KNOBS and SWITCHES are adjusted to suit the design requirements (refer to the **Controls** section).

To switch the unit ON, use the microprocessor keypad as follows:

Press  , press  , press  , press  & finally .

CAUTION  There will always be a delay between the enabling of the unit and the energising of the compressor contactors, anything between 1 to 2 minutes. Be patient.

Commissioning Procedure





PRE COMMISSIONING CHECKLIST (CONT..)

- Check that each circuit trips on low pressure. The alarm should appear within 3 minutes.
- The alarm will be recognised at the display circuit trip, to clear the alarms refer to **Alarm Handling**.

RECORD ▼

- Reduce the flow rate to 75% of design and ensure that the evaporator pressure or flow protection switch trips at this flow rate, adjust as necessary.
- With compressors off, ensure this alarm is recognised as “**Water Flow Fail**” at the display and disengages the circuits operation immediately. Restore flow rate to the design and check the alarm has self-cleared.

To switch the unit OFF, use the microprocessor keypad as follows:

Press , press , press , press  & finally .

Fully open all liquid line and discharge service ball valves on each circuit.





Commissioning Procedure

COMMISSIONING CHECKLIST

The following should be carried out with a load on the system, otherwise the unit is likely to short cycle. The following tests are to be carried out on 1 circuit at a time.

- Switch the door interlocking MCCB to the ON position but again only on the circuit which is to be tested.
- Adjust the water temperature supply and return set points to match the system requirements.

To switch the unit ON, use the microprocessor keypad as follows:

Press , press , press , press  & finally .

- Check pressures at suction and discharge ports for correct phase rotation.

CAUTION  **If no differential pressure occurs, isolate immediately.**





RECORD 

- Measure and record the compressor amps once the compressors are fully loaded and at the unloading stage.
- Measure and record full speed amps of each condenser.

CAUTION  **The microprocessor LP setting is adjustable via the micro display. It is recommended that this setting be 0.6Bar below the equipment freezing point of the cooling medium ie for water (no glycol) LP micro settings is 3.2BarG.**

- Ensure that the low water temperature safety cuts out at the correct setting +/- 0.5°C, to clear the alarms refer to **Alarm Handling** section.
For water (no glycol) application the recommended setting is 3°C or 3°C below the design supply water temperature.

RECORD 

- Check the liquid line sight glass is clear and dry.
- Check the superheat setting adjusts the expansion valve to maintain a superheat setting of 5 – 8°C at all operating loads.
- Check and record the following:
Suction and discharge pressures
Liquid, discharge and suction line temperature
Water inlet and outlet temperature
- Ensure the above are all within the design parameters.
- Repeat as follows for each circuit:
- **To switch the unit OFF**, use the microprocessor keypad as follows:
Press , press , press , press  & finally .
- **To switch the unit ON**, repeat above.

The unit is now commissioned and will provide many years of trouble free operation providing the following maintenance schedule is followed.

Maintenance

CAUTION  ALL work **MUST** be carried out by Technically Trained competent personnel.

The equipment contains live electrical and moving parts, **ISOLATE** prior to maintenance or repair work.

GENERAL MAINTENANCE

The maintenance schedule indicates the time period between maintenance operations.

| 3 MONTHS | ACTION | NOTES |
|----------------------|--|---|
| REFRIGERATION | Check the following and compare results with commissioning records. <ul style="list-style-type: none"> • Suction and discharge readings. • Head pressure control is maintained. • Pressure relief indicator gauge. • Check each circuit sight glass for dryness and bubbles for indication of leaks. • Check compressor oil level and shell/sump temperature. • Visually inspect the unit for oil patches. | Investigate and rectify variations. Remember to re-cap the Schraeder connections! |
| SYSTEM | Check the following against the commissioning records. <ul style="list-style-type: none"> • Control settings. • Alarm log for unusual occurrences. • Chilled water control maintains design temperature. • Chilled water flow is within design limits of zero to plus 10%. • Concurrently ensure chilled water pump and flow switch operate efficiently, and that interlocks function correctly. • Operation of waterflow switch and pump interlock. | Investigate and adjust as necessary. |
| Finally! | Record operating conditions. | |
| FABRIC | Visually inspect the unit for general wear and tear, treat metalwork. Visually inspect pipe and pipework insulation. Clean evaporator water strainer. Visually check the following: <ul style="list-style-type: none"> • Pipework clamps are secure. • Tightness and condition of fan and compressor mounts. • Anti-Vibration mounts fixings (if fitted). | Rust should be inhibited, primed and touched up with matching paint (available from Airedale or your Distributor). Repair/rectify as necessary. At first maintenance visit and then as frequently as necessary (12 months). Secure/tighten as necessary. |
| Finally! | Ensure control panel lids and access panels have been correctly replaced and securely fastened in position. | |

Maintenance

GENERAL MAINTENANCE (CONT..)

| 6 MONTHS | ACTION | NOTES |
|---------------|--|---|
| | Repeat 3 month checks plus the following: | |
| SYSTEM | Check evaporator trace heating and low ambient thermostat are set to activate at 4.0°C. | Remember to re-cap the Schraeder connections! |
| 12 MONTHS | ACTION | NOTES |
| | Repeat 6 month checks plus the following: | |
| SYSTEM | Check safety devices cut out the compressor at the correct settings. | |
| REFRIGERATION | Check glycol concentration if appropriate. | Adjust as necessary. |
| | Leak test all R407C joints and inspect all water connections. | Rectify as necessary. |
| | Check superheats with chiller running on full load (the height of summer is recommended). Recheck the charge following major adjustment of the superheats. | Adjust as necessary. A period of 30 minutes should be allowed between each resetting of the valve to allow pressures to stabilise. Thermostatic expansion valve only. |
| ELECTRICAL | Tighten all electrical terminals. | |

COMPRESSOR MAINTENANCE Periodic maintenance and inspection of this equipment is necessary to prevent premature failure, the following periodic inspections should be carried out by period or hourly use which ever is sooner.

1 Year Measure compressor motor insulation.

7,500 Hours or 4 Years Inspect compressor oil.

SHUT DOWN PERIODS For periods of winter shut down the following precautions are recommended:

- Close the liquid and discharge ball valve
- Cap service ports
- Turn off electrical circuits
- Drain the water from the chiller evaporator via the evaporator drain plug.

Parts Identification

SPARES

For ease of identification when ordering spares or contacting Airedale about your unit, please quote the unit type, unit serial number and the date of manufacture, which can be found on the unit serial plate.

A spares list for 1, 3 and 5 years will be supplied with every unit and is also available from our Spares department on request.

The serial plate can be located inside Item 9.

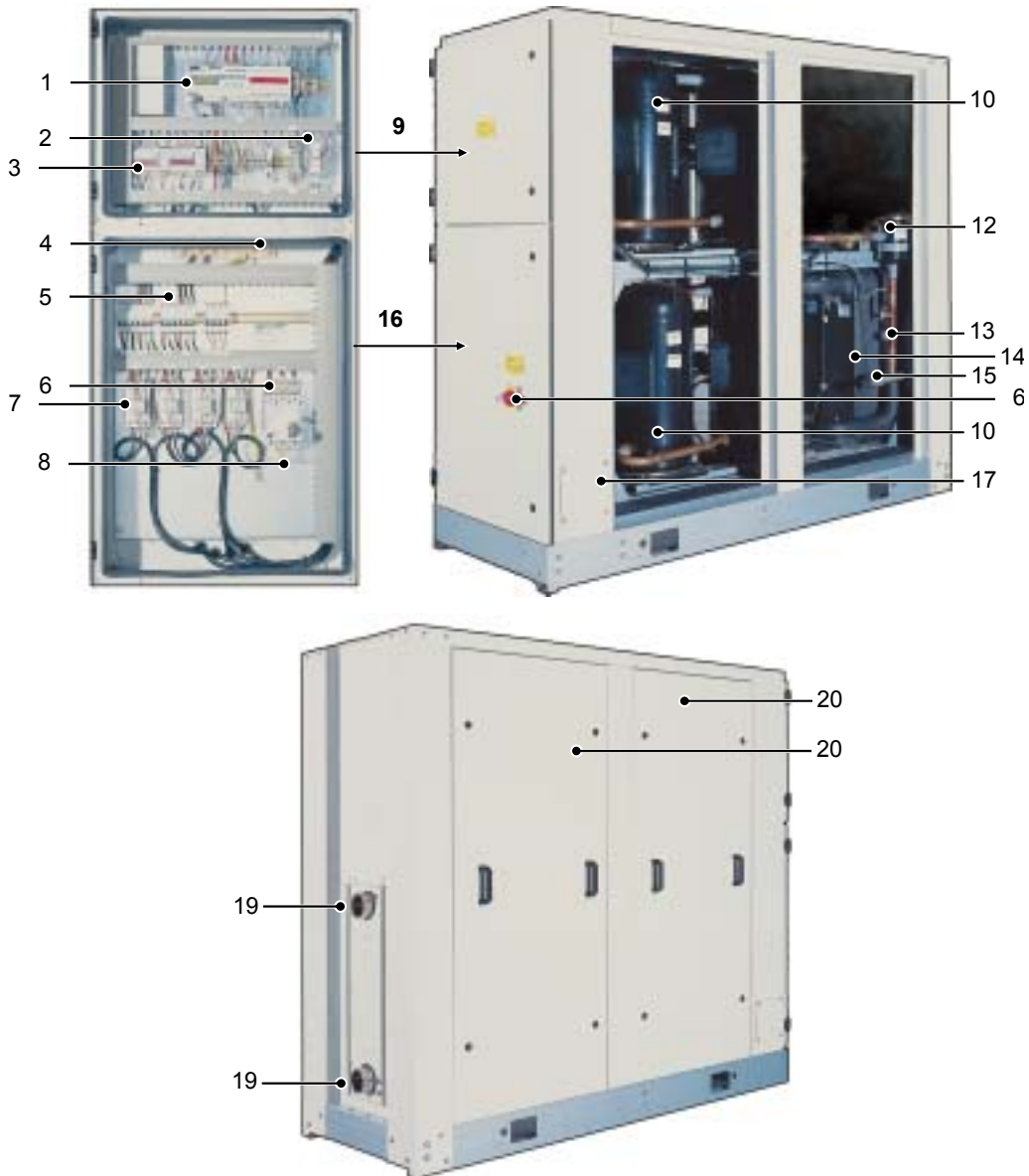

- | | | | |
|----------|--------------------------------------|-----------|--------------------------------------|
| 1 | AireTronix Microprocessor Controller | 11 | N/A |
| 2 | Controls Transformer | 12 | Filter Drier |
| 3 | Electronic Expansion Valve drives | 13 | Sight Glass |
| 4 | Earth | 14 | Evaporator |
| 5 | Compressor MCBs | 15 | Electronic Expansion Valve |
| 6 | Door Interlocking Isolator | 16 | Mains Panel |
| 7 | Compressor Contactors | 17 | Incoming Customer Mains Access Point |
| 8 | Mains Incoming | 18 | N/A |
| 9 | Controls Panel | 19 | Evaporator Water Connections |
| 10 | Compressor | 20 | Acoustic Panels (Optional) |

Notes:

Notes:

Notes:



Head Office:

Airedale International Air Conditioning Ltd

Leeds Road
Rawdon
Leeds LS19 6JY
United Kingdom

Tel: +44 (0) 113 239 1000

Fax: +44 (0) 113 250 7219

e-mail: enquiries@airedale.com

website: www.airedale.com



| PART NO: | ISSUE | DATE |
|-----------------|--------------|-------------|
| 903-127 IM E | A | 01/10/04 |

Airedale Departmental Contact Details:

CUSTOMER SERVICES For further assistance, please e-mail: enquiries@airedale.com or telephone:

| | | |
|--------------------------------|-----------------------|--|
| UK Sales Enquiries | + 44 (0) 113 238 7789 | uk.sales@airedale.com |
| International Enquiries | + 44 (0) 113 239 1000 | enquiries@airedale.com |
| Spares Hot Line | + 44 (0) 113 238 7878 | spares@airedale.com |
| Airedale Service | + 44 (0) 113 239 1000 | service@airedale.com |
| Technical Support | + 44 (0) 113 239 1000 | tech.support@airedale.com |
| Training Enquiries | + 44 (0) 113 239 1000 | marketing@airedale.com |

For information, visit us at our Web Site: www.airedale.com