



**Scambiatori: tabella compatibilità - *Heat exchangers: compatibility list***



**WHEN QUALITY COMES FIRST**





## indice | *index*

<b>ARCA*</b>	4
<b>ARISTON* - MTS*</b>	5
<b>ATAG*</b>	6
<b>BAXI* - OCEAN*</b>	7
<b>BERETTA*</b>	8
<b>BIASI* - SAVIO* - BSG*</b>	9
<b>BOSCH*</b>	10
<b>BROTJE*</b>	10
<b>CHAFFOTEAUX*</b>	11
<b>ECOFLAM*</b>	13
<b>ELM LEBLANC*</b>	13
<b>FAGOR*</b>	14
<b>FERROLI*</b>	15
<b>FONDERIE SIME*</b>	16
<b>FONDITAL*</b>	17
<b>FONTECAL*</b>	18
<b>GRANT*</b>	18
<b>GRUPPO IMAR*</b>	19
<b>HERMANN*</b>	19
<b>IMMERGAS*</b>	20
<b>JUNKERS*</b>	22
<b>LAMBORGHINI*</b>	23
<b>RADIANT*</b>	23
<b>RAVENHEAT*</b>	24
<b>RIELLO*</b>	24
<b>SAUNIER DUVAL*</b>	25
<b>SILE*</b>	25
<b>TURK DEMIR DUKUM*</b>	26
<b>UNICAL*</b>	27
<b>VAILLANT*</b>	28

\* i marchi menzionati nel presente opuscolo appartengono ai legittimi proprietari e sono utilizzati al solo ed esclusivo scopo di descrivere l'applicazione e la compatibilità degli scambiatori inseriti

*\* trademarks mentioned in this publication belong to their respective owners and are used for the sole and exclusive purpose of describing the application and compatibility of the heat exchangers included*



## ZB 190

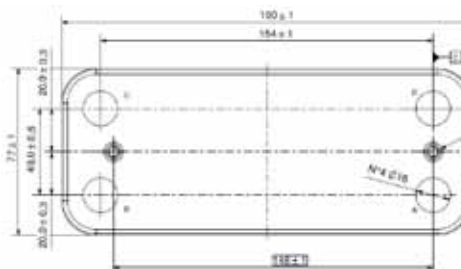

Applicazione tipo - *Typical application*

**ARCA**

Tipo attacco - *Way of connection*

O-RING

Caratteristiche - *Features*

Interasse fori - *Holes distance*: 154 x 40 mm

Interasse prigionieri - *Studs distance*: 148 mm

N° piastre <i>Nr. of plates</i>	Codice generico <i>General code</i>	Imballo singolo <i>Individual packaging</i>	Imballo 5 pz <i>5-piece packaging</i>
12	17B1901200	17S1901200	17M1901200
14	17B1901400	17S1901400	17M1901400
16	17B1901600	17S1901600	17M1901600

## ZB 190

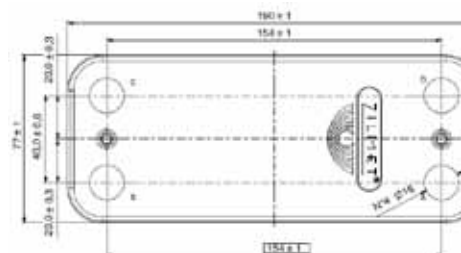

Applicazione tipo - *Typical application*

**ARCA**

Tipo attacco - *Way of connection*

O-RING

Caratteristiche - *Features*

Interasse fori - *Holes distance*: 154 x 40 mm

Interasse prigionieri - *Studs distance*: 154 mm

N° piastre <i>Nr. of plates</i>	Codice generico <i>General code</i>	Imballo singolo <i>Individual packaging</i>	Imballo 5 pz <i>5-piece packaging</i>
12	17B1901206	17S1901206	17M1901206
14	17B1901406	17S1901406	17M1901406



Scambiatori a piastre: tabella compatibilità  
Heat exchangers: compatibility list



# ZB 190

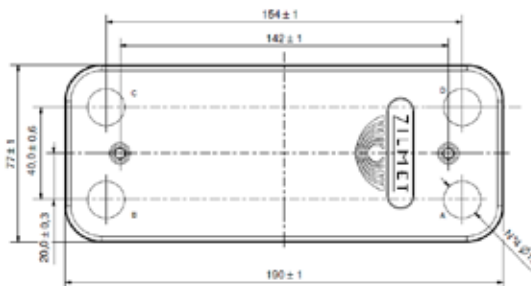

Applicazione tipo - *Typical application*

**ARISTON**

Tipo attacco - *Way of connection*

O-RING

Caratteristiche - *Features*

Interasse fori - *Holes distance*: 154 x 40 mm

Interasse prigionieri - *Studs distance*: 142 mm

N° piastre <i>Nr. of plates</i>	Codice generico <i>General code</i>	Imballo singolo <i>Individual packaging</i>	Imballo 5 pz <i>5-piece packaging</i>
12	17B1901244	17S1901244	17M1901244
14	17B1901444	17S1901444	17M1901444
16	17B1901644	17S1901644	17M1901644

# ZB 207

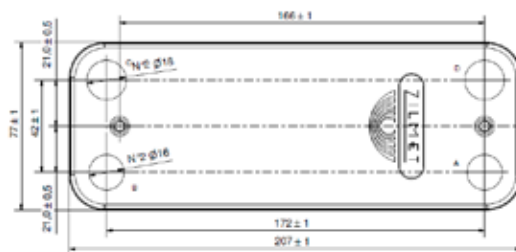

Applicazione tipo - *Typical application*

**ARISTON-MTS**

Tipo attacco - *Way of connection*

O-RING

Caratteristiche - *Features*

Interasse fori - *Holes distance*: 172 x 42 mm

Interasse prigionieri - *Studs distance*: 166 mm

N° piastre <i>Nr. of plates</i>	Codice generico <i>General code</i>	Imballo singolo <i>Individual packaging</i>	Imballo 5 pz <i>5-piece packaging</i>
12	17B2071206	17S2071206	17M2071206
14	17B2071406	17S2071406	17M2071406
16	17B2071606	17S2071606	17M2071606



Scambiatori a piastre: tabella compatibilità  
Heat exchangers: compatibility list



## ZB 315

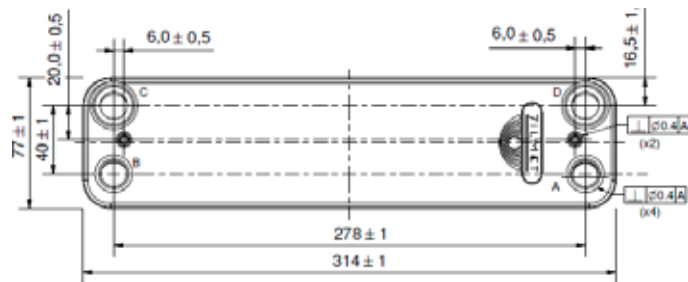

Applicazione tipo - *Typical application*

**ATAG**

Tipo attacco - *Way of connection*

Innesto - *Quick connection*

Caratteristiche - *Features*

Interasse fori - *Holes distance*: 278 x 40 mm  
Interasse prigionieri - *Studs distance*: 266 mm

N° piastre <i>Nr. of plates</i>	Codice generico <i>General code</i>	Imballo 3 pz <i>3-piece packaging</i>	
12	17B3151203	17M3151203	
18	17B3151803	17M3151803	

## ZB 207

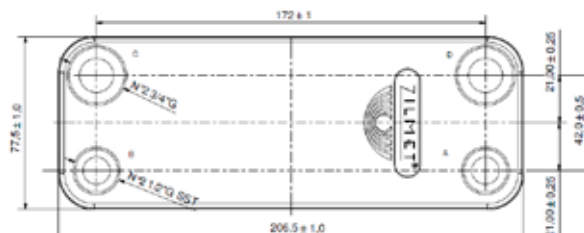

Applicazione tipo - *Typical application*



**ATAG**

Tipo attacco - *Way of connection*

Filettato - *Threaded*

Caratteristiche - *Features*

Interasse fori - *Holes distance*: 172 x 42 mm  
Raccordi - *Connections*: 2 x 3/4" + 2 x 1/2"

N° piastre <i>Nr. of plates</i>	Codice generico <i>General code</i>	Imballo singolo <i>Individual packaging</i>		Imballo 5 pz <i>5-piece packaging</i>	
16	17B2071607	17S2071607		17M2071607	



Scambiatori a piastre: tabella compatibilità  
Heat exchangers: compatibility list



# ZB 207

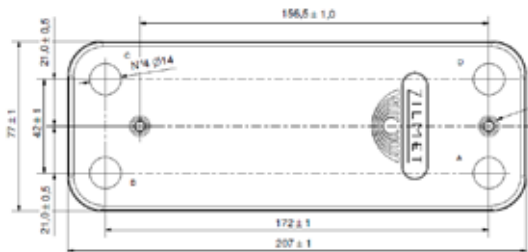

Applicazione tipo - *Typical application*

**BAXI**

Tipo attacco - *Way of connection*

O-RING

Caratteristiche - *Features*

Interasse fori - *Holes distance*: 172 x 42 mm  
Interasse prigionieri - *Studs distance*: 156,5 mm

N° piastre <i>Nr. of plates</i>	Codice generico <i>General code</i>	Imballo singolo <i>Individual packaging</i>	Imballo 5 pz <i>5-piece packaging</i>
10	17T2071000	17ST071000	17MT071000
12	17T2071200	17ST071200	17MT071200
14	17T2071400	17ST071400	17MT071400
20	17T2072000	17ST072000	17MT072000

# ZB 207

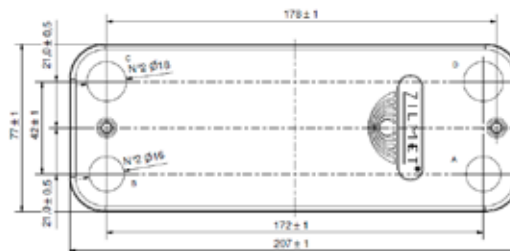

Applicazione tipo - *Typical application*

**BAXI (OCEAN)**

Tipo attacco - *Way of connection*

O-RING

Caratteristiche - *Features*

Interasse fori - *Holes distance*: 172 x 42 mm  
Interasse prigionieri - *Studs distance*: 178 mm

N° piastre <i>Nr. of plates</i>	Codice generico <i>General code</i>	Imballo singolo <i>Individual packaging</i>	Imballo 5 pz <i>5-piece packaging</i>
12	17B2071201	17S2071201	17M2071201
14	17B2071401	17S2071401	17M2071401
16	17B2071601	17S2071601	17M2071601



Scambiatori a piastre: tabella compatibilità  
Heat exchangers: compatibility list



# ZB 207

NEW

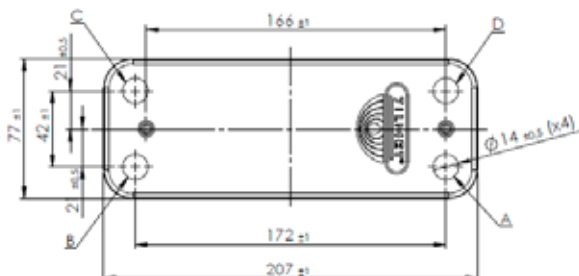

Applicazione tipo - *Typical application*

**BAXI**

Tipo attacco - *Way of connection*

O-RING

Caratteristiche - *Features*

Interasse fori - *Holes distance*: 172 x 42 mm

Interasse prigionieri - *Studs distance*: 166 mm

N° piastre <i>Nr. of plates</i>	Codice generico <i>General code</i>	Imballo singolo <i>Individual packaging</i>	Imballo 5 pz <i>5-piece packaging</i>
10	17T2071006	17ST071006	17MT071006
12	17T2071206	17ST071206	17MT071206
14	17T2071406	17ST071406	17MT071406
20	17T2072006	17ST072006	17MT072006

# ZB 190

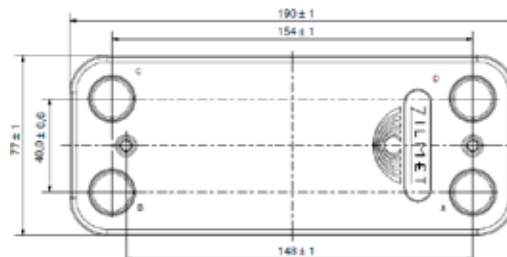

Applicazione tipo - *Typical application*

**BERETTA**

Tipo attacco - *Way of connection*

O-RING

Caratteristiche - *Features*

Interasse fori - *Holes distance*: 154 x 40 mm

Interasse prigionieri - *Studs distance*: 148 mm

N° piastre <i>Nr. of plates</i>	Codice generico <i>General code</i>	Imballo singolo <i>Individual packaging</i>	Imballo 5 pz <i>5-piece packaging</i>
12	17B1901201	17S1901201	17M1901201
14	17B1901401	17S1901401	17M1901401
16	17B1901601	17S1901601	17M1901601



Scambiatori a piastre: tabella compatibilità  
Heat exchangers: compatibility list





# ZB 190

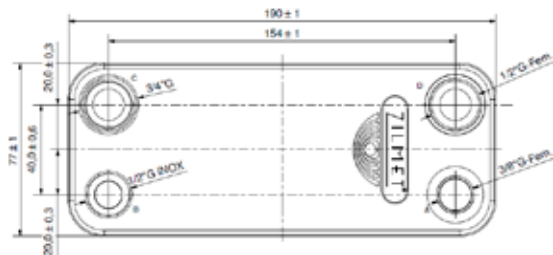

Applicazione tipo - *Typical application*

**BERETTA**

Tipo attacco - *Way of connection*

Filettato - *Threaded*

Caratteristiche - *Features*

Interasse fori - *Holes distance*: 154 x 40 mm  
Raccordi - *Connections*:

N° piastre <i>Nr. of plates</i>	Codice generico <i>General code</i>	Imballo singolo <i>Individual packaging</i>	Imballo 5 pz <i>5-piece packaging</i>
12	17B1901203	17S1901203	17M1901203
14	17B1901403	17S1901403	17M1901403
16	17B1901603	17S1901603	17M1901603

# ZB 190

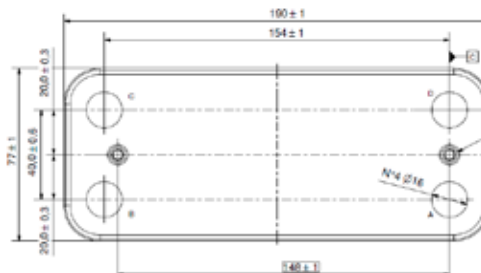

Applicazione tipo - *Typical application*

**BIASI-SAVIO (BSG)**

Tipo attacco - *Way of connection*

O-RING

Caratteristiche - *Features*

Interasse fori - *Holes distance*: 154 x 40 mm  
Interasse prigionieri - *Studs distance*: 148 mm

N° piastre <i>Nr. of plates</i>	Codice generico <i>General code</i>	Imballo singolo <i>Individual packaging</i>	Imballo 5 pz <i>5-piece packaging</i>
12	17B1901200	17S1901200	17M1901200
14	17B1901400	17S1901400	17M1901400
16	17B1901600	17S1901600	17M1901600



Scambiatori a piastre: tabella compatibilità  
Heat exchangers: compatibility list



## ZB 207

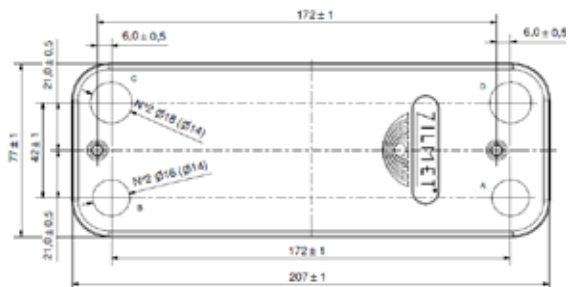

Applicazione tipo - *Typical application*

**BOSCH**

Tipo attacco - *Way of connection*

O-RING

Caratteristiche - *Features*

Interasse fori - *Holes distance*: 72 x 42 mm  
Interasse prigionieri - *Studs distance*: 172 mm

N° piastre <i>Nr. of plates</i>	Codice generico <i>General code</i>	Imballo singolo <i>Individual packaging</i>	Imballo 5 pz <i>5-piece packaging</i>
14	17B2071432	17S2071432	17M2071432

## ZB 207

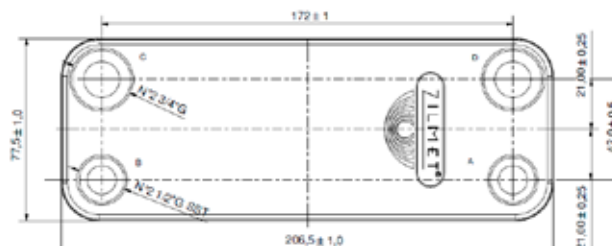

Applicazione tipo - *Typical application*

**BROTJE**

Tipo attacco - *Way of connection*

Filettato - *Threaded*

Caratteristiche - *Features*

Interasse fori - *Holes distance*: 172 x 42 mm  
Raccordi - *Connections*: 2 x 3/4" + 2 x 1/2"

N° piastre <i>Nr. of plates</i>	Codice generico <i>General code</i>	Imballo singolo <i>Individual packaging</i>	Imballo 5 pz <i>5-piece packaging</i>
20	17B2072007	17S2072007	17M2072007



Scambiatori a piastre: tabella compatibilità  
Heat exchangers: compatibility list



# ZB 195

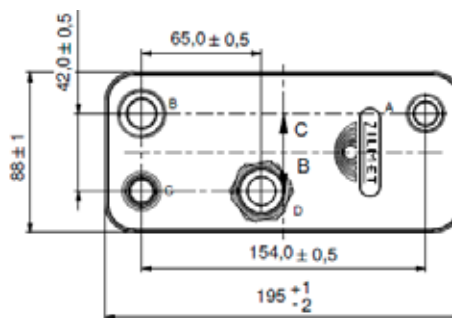

Applicazione tipo - *Typical application*

**BROTJE**

Tipo attacco - *Way of connection*

Filettato - *Threaded*

Caratteristiche - *Features*

Interasse fori - *Holes distance*: 154 x 42 mm

Raccordi - *Connections*: 2 x 3/4" + 1 x 1/2" + 1 quick c.

N° piastre <i>Nr. of plates</i>	Codice generico <i>General code</i>	Imballo singolo <i>Individual packaging</i>	Imballo 4 pz <i>4-piece packaging</i>
15	17B1951501	17S1951501	17M1951501

# ZB 207

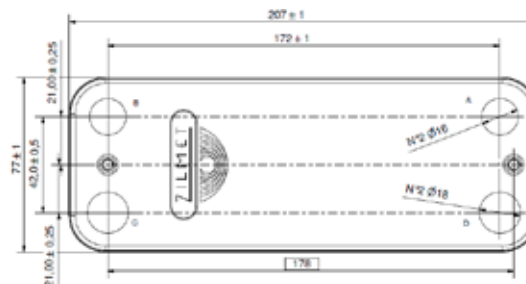

Applicazione tipo - *Typical application*

**CHAFFOTEAUX**

Tipo attacco - *Way of connection*

O-RING

Caratteristiche - *Features*

Interasse fori - *Holes distance*: 172 x 42 mm

Interasse prigionieri - *Studs distance*: 178 mm

N° piastre <i>Nr. of plates</i>	Codice generico <i>General code</i>	Imballo singolo <i>Individual packaging</i>	Imballo 5 pz <i>5-piece packaging</i>
12	17B2071210	17S2071210	17M2071210
14	17B2071410	17S2071410	17M2071410
16	17B2071610	17S2071610	17M2071610



Scambiatori a piastre: tabella compatibilità  
Heat exchangers: compatibility list



# ZB 190

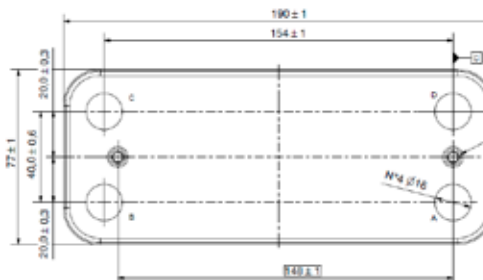

Applicazione tipo - *Typical application*

**CHAFFOTEAUX**

Tipo attacco - *Way of connection*

O-RING

Caratteristiche - *Features*

Interasse fori - *Holes distance*: 154 x 40 mm  
Interasse prigionieri - *Studs distance*: 148 mm

N° piastre <i>Nr. of plates</i>	Codice generico <i>General code</i>	Imballo singolo <i>Individual packaging</i>	Imballo 5 pz <i>5-piece packaging</i>
14	17B1901400	17S1901400	17M1901400

# ZB 190

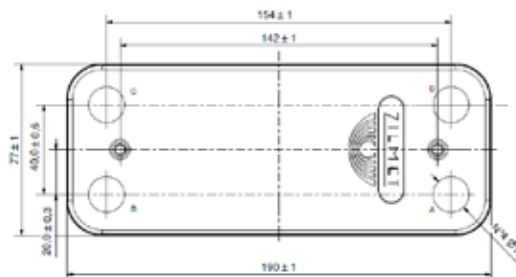

Applicazione tipo - *Typical application*

**CHAFFOTEAUX**

Tipo attacco - *Way of connection*

O-RING

Caratteristiche - *Features*

Interasse fori - *Holes distance*: 154 x 40 mm  
Interasse prigionieri - *Studs distance*: 142 mm

N° piastre <i>Nr. of plates</i>	Codice generico <i>General code</i>	Imballo singolo <i>Individual packaging</i>	Imballo 5 pz <i>5-piece packaging</i>
14	17B1901444	17S1901444	17M1901444
16	17B1901644	17S1901644	17M1901644



Scambiatori a piastre: tabella compatibilità  
Heat exchangers: compatibility list



# ZB 207

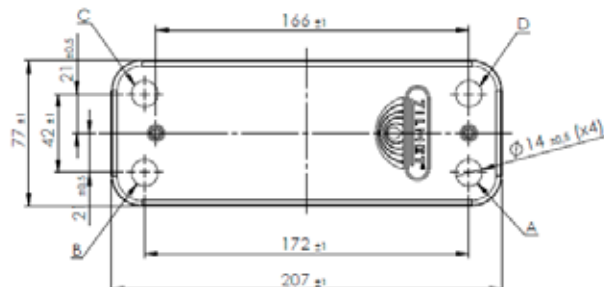

<b>Applicazione tipo - Typical application</b>		<b>ECOFLAM</b>	
<b>Tipo attacco - Way of connection</b>		O-RING	
<b>Caratteristiche - Features</b>		<b>Interasse fori - Holes distance:</b> 172 x 42 mm <b>Interasse prigionieri - Studs distance:</b> 166 mm	
N° piastre Nr. of plates	Codice generico General code	Imballo singolo Individual packaging	Imballo 5 pz 5-piece packaging
16	17T2071606	17ST071606	17MT071606

# ZB 190

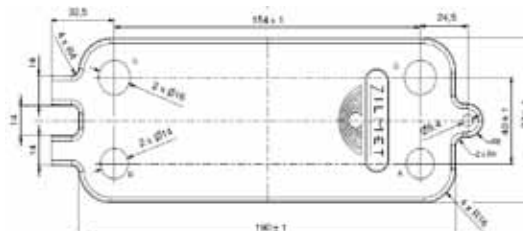

<b>Applicazione tipo - Typical application</b>		<b>E.L.M. LEBLANC</b>	
<b>Tipo attacco - Way of connection</b>		O-RING	
<b>Caratteristiche - Features</b>		<b>Interasse fori - Holes distance:</b> 154 x 40 mm <b>Interasse prigionieri - Studs distance:</b> -----	
N° piastre Nr. of plates	Codice generico General code	Imballo singolo Individual packaging	Imballo 5 pz 5-piece packaging
24	17B1902433	17S1902433	17M1902433



Scambiatori a piastre: tabella compatibilità  
Heat exchangers: compatibility list



# ZB 207

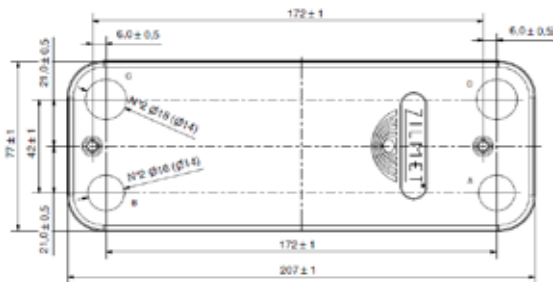

Applicazione tipo - *Typical application*

**E.L.M. LEBLANC**

Tipo attacco - *Way of connection*

O-RING

Caratteristiche - *Features*

Interasse fori - *Holes distance*: 172 x 42 mm  
Interasse prigionieri - *Studs distance*: 172 mm

N° piastre <i>Nr. of plates</i>	Codice generico <i>General code</i>	Imballo singolo <i>Individual packaging</i>	Imballo 5 pz <i>5-piece packaging</i>
14	17B2071432	17S2071432	17M2071432

# ZB 195

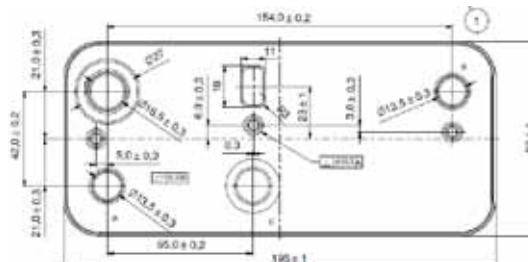

Applicazione tipo - *Typical application*

**FAGOR**

Tipo attacco - *Way of connection*

O-RING

Caratteristiche - *Features*

Interasse fori - *Holes distance*: 154 x 42 mm  
Interasse prigionieri - *Studs distance*: 159 / 65 mm

N° piastre <i>Nr. of plates</i>	Codice generico <i>General code</i>	Imballo singolo <i>Individual packaging</i>	Imballo 4 pz <i>4-piece packaging</i>
13	17B1951321	17S1951321	17M1951321



Scambiatori a piastre: tabella compatibilità  
Heat exchangers: compatibility list



# ZB 190

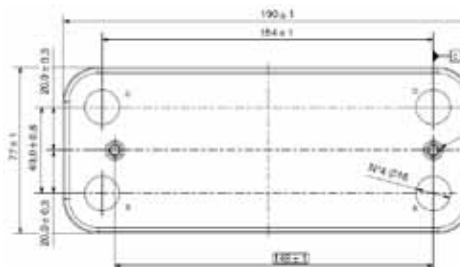

Applicazione tipo - *Typical application*

**FERROLI**

Tipo attacco - *Way of connection*

O-RING

Caratteristiche - *Features*

Interasse fori - *Holes distance*: 154 x 40 mm

Interasse prigionieri - *Studs distance*: 148 mm

N° piastre <i>Nr. of plates</i>	Codice generico <i>General code</i>	Imballo singolo <i>Individual packaging</i>	Imballo 5 pz <i>5-piece packaging</i>
16	17B1901600	17S1901600	17M1901600
20	17B1902000	17S1902000	17M1902000

# ZB 190

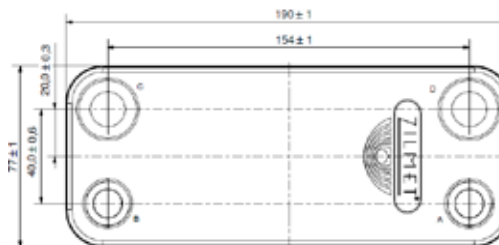

Applicazione tipo - *Typical application*

**FERROLI**

Tipo attacco - *Way of connection*

Filettato - *Threaded*

Caratteristiche - *Features*

Interasse fori - *Holes distance*: 154 x 40 mm

Raccordi - *Connections*: 2 x 3/4" + 2 x 1/2"

N° piastre <i>Nr. of plates</i>	Codice generico <i>General code</i>	Imballo singolo <i>Individual packaging</i>	Imballo 5 pz <i>5-piece packaging</i>
16	17B1901605	17S1901605	17M1901605
20	17B1902005	17S1902005	17M1902005



Scambiatori a piastre: tabella compatibilità  
Heat exchangers: compatibility list



# ZB 195

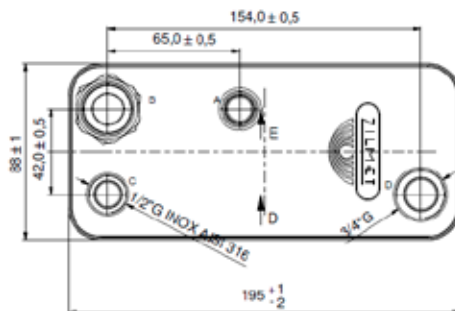

Applicazione tipo - *Typical application*

**FONDERIE SIME**

Tipo attacco - *Way of connection*

Filettato - *Threaded*

Caratteristiche - *Features*

Interasse fori - *Holes distance*: 154 x 42 mm  
Raccordi - *Connections*: 2 x 3/4" + 1 x 1/2" + 1 quick c.

N° piastre <i>Nr. of plates</i>	Codice generico <i>General code</i>	Imballo singolo <i>Individual packaging</i>	Imballo 4 pz <i>4-piece packaging</i>
14	17B1951400	17S1951400	17M1951400

# ZB 195

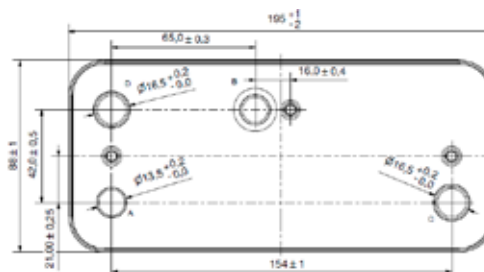

Applicazione tipo - *Typical application*

**FONDERIE SIME**

Tipo attacco - *Way of connection*

O-RING

Caratteristiche - *Features*

Interasse fori - *Holes distance*: 154 x 42 mm  
Interasse prigionieri - *Studs distance*: 154 / 71 mm

N° piastre <i>Nr. of plates</i>	Codice generico <i>General code</i>	Imballo singolo <i>Individual packaging</i>	Imballo 4 pz <i>4-piece packaging</i>
14	17B1951409	17S1951409	17M1951409



Scambiatori a piastre: tabella compatibilità  
Heat exchangers: compatibility list





# ZA 190

NEW

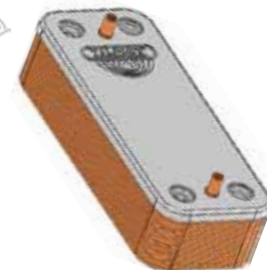
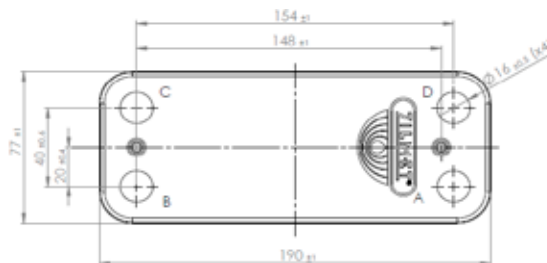

Applicazione tipo - *Typical application*

**FONDERIE SIME**

Tipo attacco - *Way of connection*

O-RING

Caratteristiche - *Features*

Interasse fori - *Holes distance*: 154 x 40 mm  
Interasse prigionieri - *Studs distance*: 148 mm

N° piastre <i>Nr. of plates</i>	Codice generico <i>General code</i>	Imballo singolo <i>Individual packaging</i>	Imballo 5 pz <i>5-piece packaging</i>
12	17A1901210	17SA901210	17MA901210
14	17A1901410	17SA901410	17MA901410
16	17A1901610	17SA901610	17MA901610

# ZB 207

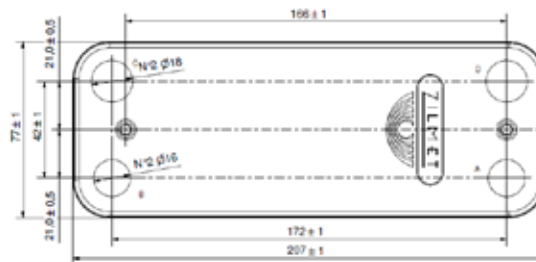

Applicazione tipo - *Typical application*

**FONDITAL**

Tipo attacco - *Way of connection*

O-RING

Caratteristiche - *Features*

Interasse fori - *Holes distance*: 172 x 42 mm  
Interasse prigionieri - *Studs distance*: 166 mm

N° piastre <i>Nr. of plates</i>	Codice generico <i>General code</i>	Imballo singolo <i>Individual packaging</i>	Imballo 5 pz <i>5-piece packaging</i>
14	17B2071406	17S2071406	17M2071406



Scambiatori a piastre: tabella compatibilità  
Heat exchangers: compatibility list



## ZB 190

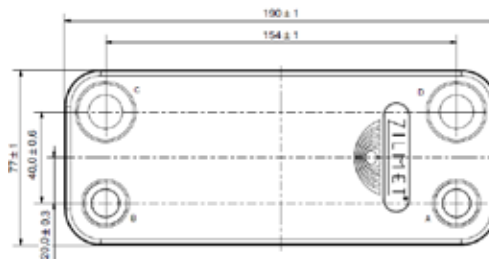

Applicazione tipo - *Typical application*

**FONTECAL**

Tipo attacco - *Way of connection*

Filettato - *Threaded*

Caratteristiche - *Features*

Interasse fori - *Holes distance*: 154 x 40 mm

Raccordi - *Connections*: 2 x 3/4" + 2 x 1/2"

N° piastre <i>Nr. of plates</i>	Codice generico <i>General code</i>	Imballo singolo <i>Individual packaging</i>	Imballo 5 pz <i>5-piece packaging</i>
14	17B1901402	17S1901402	17M1901402

## ZB 195

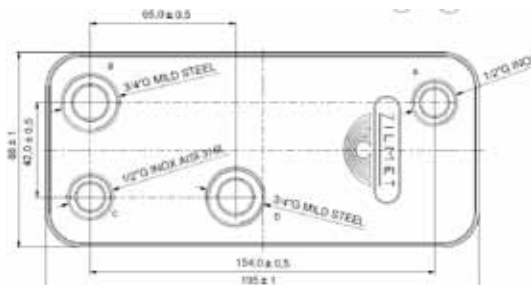

Applicazione tipo - *Typical application*

**GRANT**

Tipo attacco - *Way of connection*

Filettato - *Threaded*

Caratteristiche - *Features*

Interasse fori - *Holes distance*: 154 x 42 mm

Raccordi - *Connections*: 2 x 3/4" + 2 x 1/2"

N° piastre <i>Nr. of plates</i>	Codice generico <i>General code</i>	Imballo singolo <i>Individual packaging</i>	Imballo 4 pz <i>4-piece packaging</i>
35	17B1953553	17S1953553	17M1953553



Scambiatori a piastre: tabella compatibilità  
Heat exchangers: compatibility list



# ZB 315

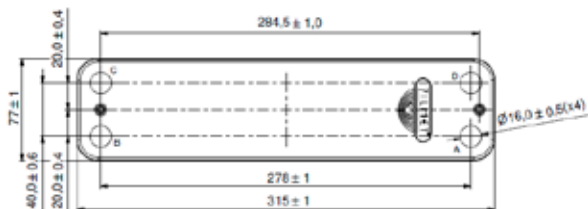

Applicazione tipo - <i>Typical application</i>		<b>GRUPPO IMAR</b>	
Tipo attacco - <i>Way of connection</i>		Filettato - <i>Threaded</i>	
Caratteristiche - <i>Features</i>		Interasse fori - <i>Holes distance</i> : 278 x 40 mm Interasse prigionieri - <i>Studs distance</i> : 284,5 mm	
N° piastre <i>Nr. of plates</i>	Codice generico <i>General code</i>	Imballo 3 pz <i>3-piece packaging</i>	
12	17B3151200	17M3151200	
16	17B3151600	17M3151600	

# ZB 195

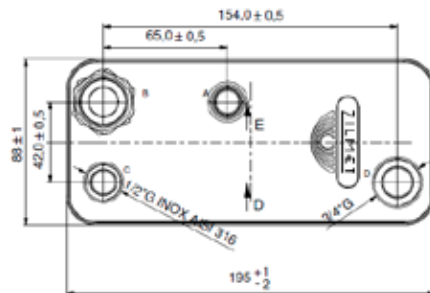

Applicazione tipo - <i>Typical application</i>		<b>HERMANN</b>	
Tipo attacco - <i>Way of connection</i>		Filettato - <i>Threaded</i>	
Caratteristiche - <i>Features</i>		Interasse fori - <i>Holes distance</i> : 154 x 42 mm Raccordi - <i>Connections</i> : 2 x 3/4" + 1 x 1/2" + 1 quick c.	
N° piastre <i>Nr. of plates</i>	Codice generico <i>General code</i>	Imballo singolo <i>Individual packaging</i>	Imballo 4 pz <i>4-piece packaging</i>
12	17B1951200	17S1951200	17M1951200
14	17B1951400	17S1951400	17M1951400



Scambiatori a piastre: tabella compatibilità  
Heat exchangers: compatibility list



# ZB 195

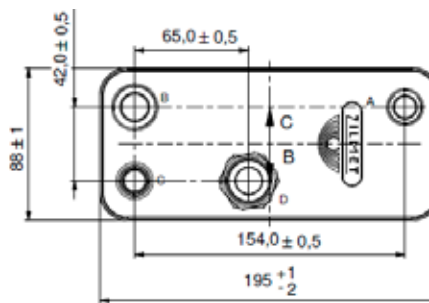

Applicazione tipo - *Typical application*

**IMMERGAS**

Tipo attacco - *Way of connection*

Filettato - *Threaded*

Caratteristiche - *Features*

Interasse fori - *Holes distance*: 154 x 42 mm  
Raccordi - *Connections*: 2 x 3/4" + 1 x 1/2" + 1 quick c.

N° piastre <i>Nr. of plates</i>	Codice generico <i>General code</i>	Imballo singolo <i>Individual packaging</i>	Imballo 4 pz <i>4-piece packaging</i>
15	17B1951501	17S1951501	17M1951501

# ZB 195

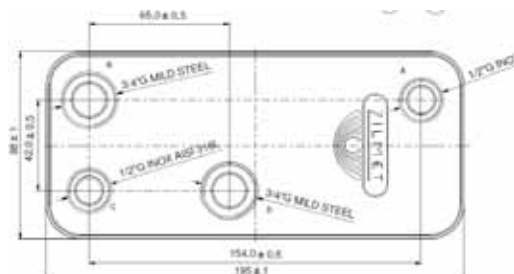

Applicazione tipo - *Typical application*

**IMMERGAS**

Tipo attacco - *Way of connection*

Filettato - *Threaded*

Caratteristiche - *Features*

Interasse fori - *Holes distance*: 154 x 42 mm  
Raccordi - *Connections*: 2 x 3/4" + 2 x 1/2"

N° piastre <i>Nr. of plates</i>	Codice generico <i>General code</i>	Imballo singolo <i>Individual packaging</i>	Imballo 4 pz <i>4-piece packaging</i>
13	17B1951302	17S1951302	17M1951302
15	17B1951502	17S1951502	17M1951502
17	17B1951702	17S1951702	17M1951702



Scambiatori a piastre: tabella compatibilità  
Heat exchangers: compatibility list



## ZB 200

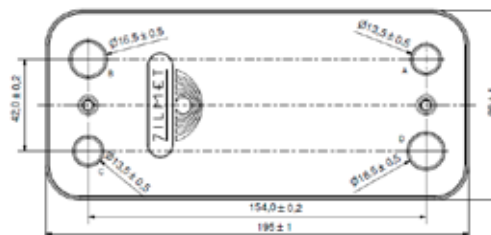

Applicazione tipo - *Typical application*

**IMMERGAS**

Tipo attacco - *Way of connection*

O-RING

Caratteristiche - *Features*

Interasse fori - *Holes distance*: 154 x 42 mm  
Interasse prigionieri - *Studs distance*: 154 mm

N° piastre <i>Nr. of plates</i>	Codice generico <i>General code</i>	Imballo singolo <i>Individual packaging</i>	Imballo 4 pz <i>4-piece packaging</i>
16	17B2001600	17S2001600	17M2001600
20	17B2002000	17S2002000	17M2002000

## ZB 190

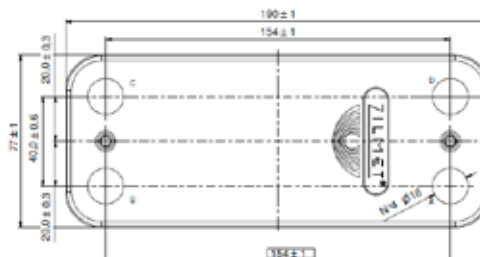

Applicazione tipo - *Typical application*

**IMMERGAS**

Tipo attacco - *Way of connection*

O-RING

Caratteristiche - *Features*

Interasse fori - *Holes distance*: 154 x 40 mm  
Interasse prigionieri - *Studs distance*: 154 mm

N° piastre <i>Nr. of plates</i>	Codice generico <i>General code</i>	Imballo singolo <i>Individual packaging</i>	Imballo 4 pz <i>4-piece packaging</i>
12	17B1901206	17S1901206	17M1901206
16	17B1901606	17S1901606	17M1901606
20	17B1902006	17S1902006	17M1902006



Scambiatori a piastre: tabella compatibilità  
Heat exchangers: compatibility list



## ZB 190

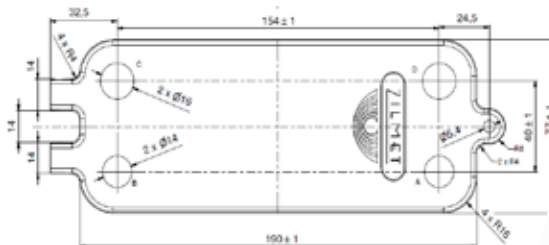

<b>Applicazione tipo - Typical application</b>		<b>JUNKERS</b>	
<b>Tipo attacco - Way of connection</b>		O-RING	
<b>Caratteristiche - Features</b>		Interasse fori - <i>Holes distance</i> : 154 x 40 mm Interasse prigionieri - <i>Studs distance</i> : -----	
N° piastre <i>Nr. of plates</i>	Codice generico <i>General code</i>	Imballo singolo <i>Individual packaging</i>	Imballo 5 pz <i>5-piece packaging</i>
24	17B1902433	17S1902433	17M1902433

## ZB 190

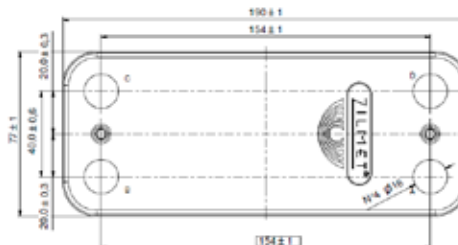

<b>Applicazione tipo - Typical application</b>		<b>JUNKERS</b>	
<b>Tipo attacco - Way of connection</b>		O-RING	
<b>Caratteristiche - Features</b>		Interasse fori - <i>Holes distance</i> : 154 x 40 mm Interasse prigionieri - <i>Studs distance</i> : 154 mm	
N° piastre <i>Nr. of plates</i>	Codice generico <i>General code</i>	Imballo singolo <i>Individual packaging</i>	Imballo 5 pz <i>5-piece packaging</i>
12	17B1901206	17S1901206	17M1901206



Scambiatori a piastre: tabella compatibilità  
Heat exchangers: compatibility list



# ZB 195

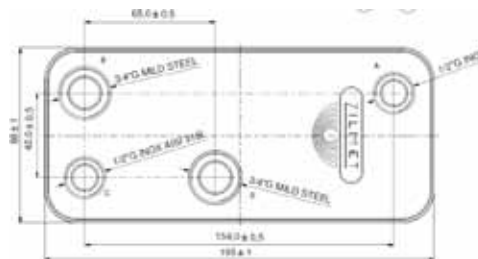

Applicazione tipo - *Typical application*

**LAMBORGHINI**

Tipo attacco - *Way of connection*

Filettato - *Threaded*

Caratteristiche - *Features*

Interasse fori - *Holes distance*: 154 x 42 mm

Raccordi - *Connections*: 2 x 3/4" + 2 x 1/2"

N° piastre Nr. of plates	Codice generico General code	Imballo singolo Individual packaging	Imballo 4 pz 4-piece packaging
15	17B1951502	17S1951502	17M1951502
17	17B1951702	17S1951702	17M1951702
19	17B1951902	17S1951902	17M1951902

# ZB 190

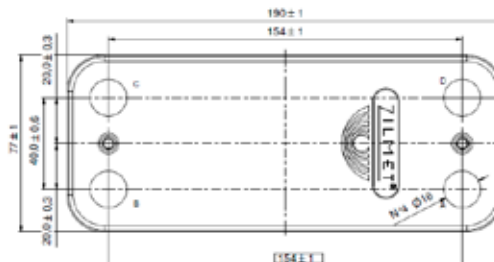

Applicazione tipo - *Typical application*

**RADIANT**

Tipo attacco - *Way of connection*

O-RING

Caratteristiche - *Features*

Interasse fori - *Holes distance*: 154 x 40 mm

Interasse prigionieri - *Studs distance*: 154 mm

N° piastre Nr. of plates	Codice generico General code	Imballo singolo Individual packaging	Imballo 5 pz 5-piece packaging
14	17B1901406	17S1901406	17M1901406
16	17B1901606	17S1901606	17M1901606
20	17B1902006	17S1902006	17M1902006



Scambiatori a piastre: tabella compatibilità  
Heat exchangers: compatibility list



## ZB 207

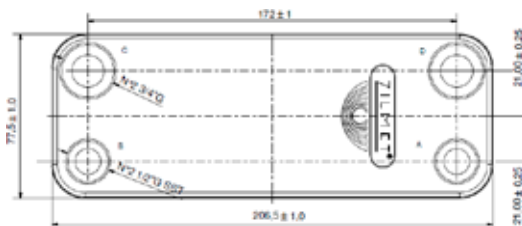

Applicazione tipo - *Typical application*

**RAVENHEAT**

Tipo attacco - *Way of connection*

Filettato - *Threaded*

Caratteristiche - *Features*

Interasse fori - *Holes distance*: 172 x 42 mm

Raccordi - *Connections*: 2 x 3/4" + 2 x 1/2"

N° piastre Nr. of plates	Codice generico General code	Imballo singolo Individual packaging	Imballo 5 pz 5-piece packaging
20	17B2072007	17S2072007	17M2072007

## ZB 190



Applicazione tipo - *Typical application*

**RIELLO**

Tipo attacco - *Way of connection*

Filettato - *Threaded*

Caratteristiche - *Features*

Interasse fori - *Holes distance*: 154 x 40 mm

Raccordi - *Connections*: 1 x 3/4" + 1 x 1/2" + 1 x 3/8" + 1 x M30

N° piastre Nr. of plates	Codice generico General code	Imballo singolo Individual packaging	Imballo 5 pz 5-piece packaging
12	17B1901208	17S1901208	17M1901208
14	17B1901408	17S1901408	17M1901408
16	17B1901608	17S1901608	17M1901608



Scambiatori a piastre: tabella compatibilità  
Heat exchangers: compatibility list





# ZB 207

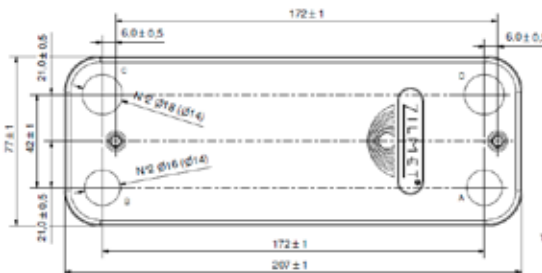

Applicazione tipo - *Typical application*

**SAUNIER DUVAL**

Tipo attacco - *Way of connection*

O-RING

Caratteristiche - *Features*

Interasse fori - *Holes distance*: 172 x 42 mm  
Interasse prigionieri - *Studs distance*: 172 mm

N° piastre Nr. of plates	Codice generico General code	Imballo singolo Individual packaging	Imballo 5 pz 5-piece packaging
12	17B2071213	17S2071213	17M2071213
16	17B2071613	17S2071613	17M2071613

# ZB 195

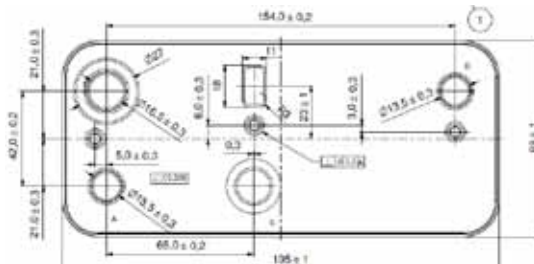

Applicazione tipo - *Typical application*

**SILE**

Tipo attacco - *Way of connection*

O-RING

Caratteristiche - *Features*

Interasse fori - *Holes distance*: 154 x 42 mm  
Interasse prigionieri - *Studs distance*: 159 / 65 mm

N° piastre Nr. of plates	Codice generico General code	Imballo singolo Individual packaging	Imballo 4 pz 4-piece packaging
17	17B1951721	17S1951721	17M1951721



Scambiatori a piastre: tabella compatibilità  
Heat exchangers: compatibility list



## ZB 195

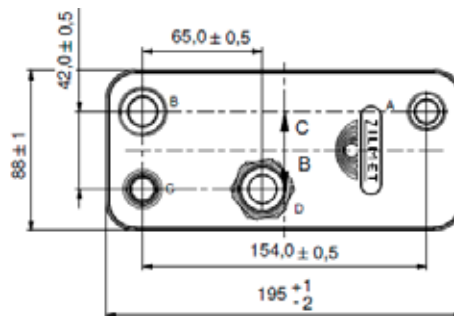

Applicazione tipo - *Typical application*

**SILE**

Tipo attacco - *Way of connection*

Filettato - *Threaded*

Caratteristiche - *Features*

Interasse fori - *Holes distance*: 172 x 42 mm  
Raccordi - *Connections*: 2 x 3/4" + 1 x 1/2" + 1 quick c.

N° piastre <i>Nr. of plates</i>	Codice generico <i>General code</i>	Imballo singolo <i>Individual packaging</i>	Imballo 4 pz <i>4-piece packaging</i>
15	17B1951501	17S1951501	17M1951501

## ZB 207

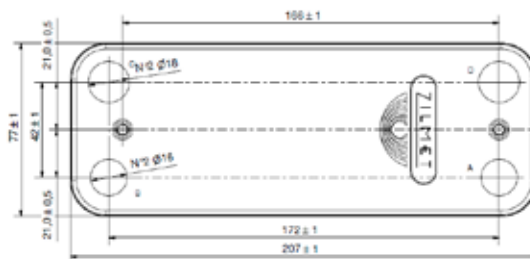

Applicazione tipo - *Typical application*

**TURK DEMIR DOKUM**

Tipo attacco - *Way of connection*

O-RING

Caratteristiche - *Features*

Interasse fori - *Holes distance*: 172 x 42 mm  
Interasse prigionieri - *Studs distance*: 166 mm

N° piastre <i>Nr. of plates</i>	Codice generico <i>General code</i>	Imballo singolo <i>Individual packaging</i>	Imballo 4 pz <i>4-piece packaging</i>
10	17T2071006	17ST071006	17MT071006
12	17T2071206	17ST071206	17MT071206
14	17T2071406	17ST071406	17MT071406



Scambiatori a piastre: tabella compatibilità  
Heat exchangers: compatibility list



# ZB 190



<b>Applicazione tipo - Typical application</b>		<b>UNICAL</b>	
<b>Tipo attacco - Way of connection</b>		O-RING	
<b>Caratteristiche - Features</b>		Interasse fori - <i>Holes distance</i> : 154 x 40 mm Interasse prigionieri - <i>Studs distance</i> : 154 mm	
N° piastre Nr. of plates	Codice generico General code	Imballo singolo Individual packaging	Imballo 5 pz 5-piece packaging
16	17B1901621	17S1901621	17M1901621
20	17B1902021	17S1902021	17M1902021
24	17B1902421	17S1902421	17M1902421

# ZB 207

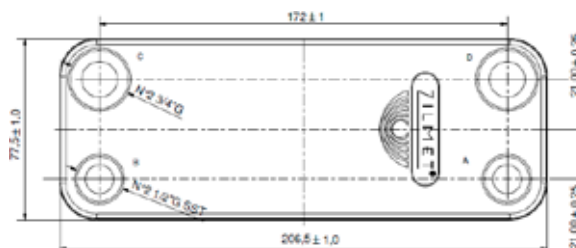

<b>Applicazione tipo - Typical application</b>		<b>UNICAL</b>	
<b>Tipo attacco - Way of connection</b>		Filettato - <i>Threaded</i>	
<b>Caratteristiche - Features</b>		Interasse fori - <i>Holes distance</i> : 172 x 42 mm Raccordi - <i>Connections</i> : 2 x 3/4" + 2 x 1/2"	
N° piastre Nr. of plates	Codice generico General code	Imballo singolo Individual packaging	Imballo 5 pz 5-piece packaging
14	17B2071407	17S2071407	17M2071407



Scambiatori a piastre: tabella compatibilità  
Heat exchangers: compatibility list



## ZB 190

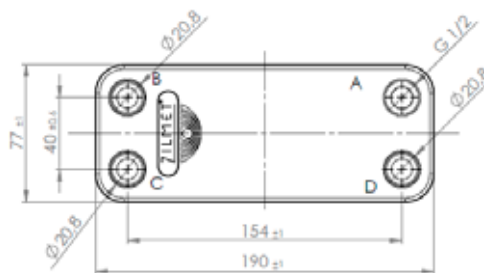

Applicazione tipo - *Typical application*

**VAILLANT**

Tipo attacco - *Way of connection*

Innesto - *Quick connection*

Caratteristiche - *Features*

Interasse fori - *Holes distance*: 154 x 40 mm

Raccordi - *Connections*: 1 x 1/2" + 3 x quick

N° piastre Nr. of plates	Codice generico General code	Imballo singolo Individual packaging	Imballo 5 pz 5-piece packaging
12	17B1901215	17S1901215	17M1901215
14	17B1901415	17S1901415	17M1901415
20	17B1902015	17S1902015	17M1902015

## ZB 207

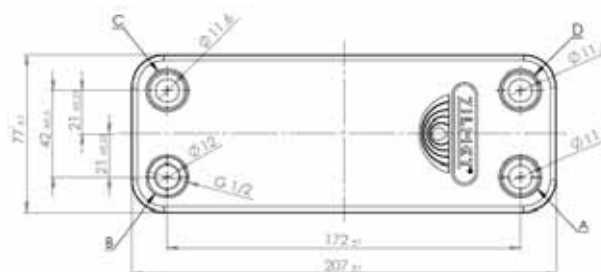

Applicazione tipo - *Typical application*

**VAILLANT**

Tipo attacco - *Way of connection*

Innesto - *Quick connection*

Caratteristiche - *Features*

Interasse fori - *Holes distance*: 172 x 42 mm

Raccordi - *Connections*: 1 x 1/2" + 3 x quick

N° piastre Nr. of plates	Codice generico General code	Imballo singolo Individual packaging	Imballo 5 pz 5-piece packaging
12	17B2071220	17S2071220	17M2071220



Scambiatori a piastre: tabella compatibilità  
Heat exchangers: compatibility list



# ZB 207

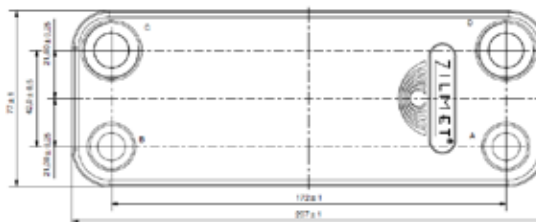

Applicazione tipo - *Typical application*

**VAILLANT**

Tipo attacco - *Way of connection*

Filettato - *Threaded*

Caratteristiche - *Features*

Interasse fori - *Holes distance*: 172 x 42 mm  
Raccordi - *Connections*: 2 x 3/4" + 2 x 1/2"

N° piastre <i>Nr. of plates</i>	Codice generico <i>General code</i>	Imballo singolo <i>Individual packaging</i>	Imballo 5 pz <i>5-piece packaging</i>
14	17B2071416	17S2071416	17M2071416

# ZB 207

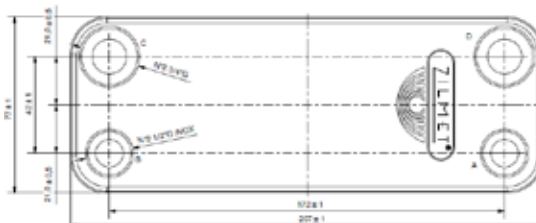

Applicazione tipo - *Typical application*

**VAILLANT**

Tipo attacco - *Way of connection*

Filettato - *Threaded*

Caratteristiche - *Features*

Interasse fori - *Holes distance*: 172 x 42 mm  
Raccordi - *Connections*: 2 x 1/2" + 2 x 3/4"

N° piastre <i>Nr. of plates</i>	Codice generico <i>General code</i>	Imballo singolo <i>Individual packaging</i>	Imballo 5 pz <i>5-piece packaging</i>
14	17B2071402	17S2071402	17M2071402



Scambiatori a piastre: tabella compatibilità  
Heat exchangers: compatibility list



# ZB 207

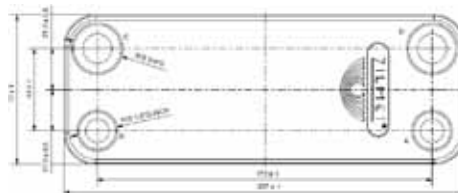

**Applicazione tipo - Typical application**

**VAILLANT**

**Tipo attacco - Way of connection**

Filettato - Threaded

**Caratteristiche - Features**

**Interasse fori - Holes distance:** 172 x 42 mm  
**Raccordi - Connections:** 2 x 3/4" + 2 x 1/2"

N° piastre Nr. of plates	Codice generico General code	Imballo singolo Individual packaging
14	17B2071493	17S2071493 



Scambiatori a piastre: tabella compatibilità  
 Heat exchangers: compatibility list





**Headquarters**

Via del Santo, 242 - 35010 Limena (PD) - Italy  
Tel. +39 049 7664901 • Fax +39 049 767321  
[www.zilmet.com](http://www.zilmet.com)  
[zilmet@zilmet.it](mailto:zilmet@zilmet.it)

**Production plants - Italy**

Limena (PD) Via del Santo, 242  
Via Visco, 2 • Via Colpi, 30  
Via Tamburin, 15/17  
Bagnoli di Sopra (PD) - Via V Strada, 21/23

**Branches**

Zilmet Deutschland GmbH  
[www.zilmet.de](http://www.zilmet.de)  
Zilmet USA  
[www.zilmetusa.com](http://www.zilmetusa.com)