

# VitroA

PRO Nature



**PRO**  
Nature



# PRO

VitrA further enriched its VitrA PRO Ceramic Tile Collection featuring numerous products, colours, patterns, materials, surface textures and solutions, which aims to inspire architects and interior designers and to help the professionals materialize their dream designs.

VitrA PRO Ceramic Tile Collection is composed of PRO Nature; material options inspired by nature, PRO Residence; tiles developed for domestic living spaces, PRO Technic; colour diversity, different surfaces and durability options, and PRO Solutions which are solution specific portfolios for pools and facades compiled from other lines.

VitrA, mimarlara ve iç mimarlara ilham verecek, profesyonellerin hayallerini tasarlamalarına yardımcı olacak, sayısız ürün, renk, desen, malzeme, yüzey özelliği ve çözüm barındıran VitrA PRO Karo Seramik Koleksiyonu'nu daha da zenginleştirdi.

VitrA PRO Karo Seramik Koleksiyonu'nda; doğadan ilham alan malzeme seçenekleri ile PRO Nature, ev yaşam alanları için geliştirilen karolar ile PRO Residence, renk çeşitliliği, farklı yüzeyler ve dayanıklılıkta alternatifler sunan PRO Technic ve diğerlerinden seçilmiş ürünlerle, kullanım yerine özel havuz ve dış cephe çözümlerini bir araya getiren PRO Solutions bulunuyor.

## PRO Nature

Natural material textured tiles  
Doğal malzeme dokulu karolar

Concrete / Beton  
Stone / Taş  
Wood / Ahşap  
Marble / Mermer  
Ceramic / Seramik

## PRO Residence

Specially designed collections for domestic living spaces.

Özellikle ev yaşam alanları için geliştirilen koleksiyonlar.

## PRO Technic

Colours, surfaces, fullbody  
porcelains and technic tiles

Renkler, yüzeyler, fullbody porselenler ve teknik karolar

Color  
Function

## PRO Pool

Pool tiles and complementary parts developed for the requirements of different pool design systems and styles.

Farklı havuz tasarım sistemleri ve tarzlarının gereksinimleri için geliştirilmiş havuz karoları ve tamamlayıcı parçalar.

# PRO

## Nature

### Index 1

#### İçindekiler 1

<b>Pure concrete</b>	<b>32</b>	<b>Wood obsession</b>	<b>286</b>
Beton sadeliği		Ahşap tutkusu	
★ Sense	34	Craft	288
CementMix	42	Oakland	294
Cementine	54	Urbanwood	300
Softcrete	62	Aspenwood	306
BetonX	68	Samba	312
Urbancrete	78		
Metalcrete	86	<b>Marble dream</b>	<b>318</b>
Ultra 2.0	92	Mermer rüyası	
Ash & Burn	98	★ MarmoMix	320
Newcon	104	Marble - X	326
Ice & Smoke	114	Nuvola	332
Metro	120	Marmori	338
Vado	130	Calacatta	348
Essence	134		
Beton	142	<b>Ceramic culture</b>	<b>354</b>
Ilot	150	Seramik kültürü	
Iron	156	miniworx	356
Terre	162	Color Line	380
Truva	168		
Scale	172	<b>Technical information</b>	<b>384</b>
		Teknik bilgiler	
<b>Stone code</b>	<b>178</b>		
Taş zamanı			
★ Flakestone	180		
★ Canyon	188		
Urban Travertino	194		
Marmostone	200		
Boscstone	210		
Cardostone	216		
Ceppostone	206		
Stonelevel	224		
Tech-Slate	232		
British Stone	240		
Lombardy	254		
Meridien	262		
Pietra Pienza	268		
Quarzite	274		
Stoneway	280		

### Index 2

#### İçindekiler 2

Ash & Burn	98	Meridien	262
Aspenwood	306	Metalcrete	86
Beton	142	Metro	120
BetonX	68	miniworx	356
Boscstone	210	Newcon	104
British Stone	246	Nuvola	332
Calacatta	348	Oakland	294
★ Canyon	188	Pietra Pienza	268
Cardostone	216	Quarzite	274
Cementine	54	Samba	312
CementMix	42	Scale	172
Ceppostone	224	★ Sense	34
Color Line	380	Softcrete	62
Craft	288	Stonelevel	232
Essence	136	Stoneway	280
★ Flakestone	180	Tech-Slate	240
Ice & Smoke	114	Terre	162
Ilot	150	Truva	168
Iron	156	Ultra 2.0	92
Lombardy	254	Urban Travertino	194
Marble - X	326	Urbancrete	78
★ MarmoMix	320	Urbanwood	300
Marmori	338	Vado	130
Marmostone	200		



	<b>Wall tiles</b> Duvar karoları	<b>Colorbody porcelain</b> Colorbody porselen	<b>Glazed porcelain</b> Sırlı porselen	<b>Ceramic floor tiles</b> Seramik yer karoları	<b>Double charge porcelain</b> Double charge porselen	<b>20 mm</b> 20 mm
<b>Pure concrete</b> Beton sadeliği	BetonX Cementine Flakestone Metro Sense Urbancrete	Ash & Burn Beton BetonX CementMix Cementine Ice & Smoke Ilot Iron Metalcrete Metro Newcon Scale Sense Ultra 2.0 Urbancrete	Ash & Burn Beton Cementine Ice & Smoke Ilot Iron Softcrete Terre Ultra 2.0 Urbancrete Vado	Terre Truva	Essence	Metro Ultra 2.0 Urbancrete
<b>Stone code</b> Taş zamanı	British Stone Lombardy Stonelevel	British Stone Boscstone Cardostone Ceppostone Flakestone Lombardy Marmostone Urban Travertino Pietra Pienza Quarzite Stonelevel Tech-Slate	Canyon Cardostone Marmostone Meridien Stoneway			British Stone Cardostone Ceppostone Flakestone Sense
<b>Wood obsession</b> Ahşap tutkusu			Aspenwood Craft Oakland Samba Urbanwood			Aspenwood Craft
<b>Marble dream</b> Mermer rüyası	Marmori	Calacatta	Calacatta Marble - X MarmoMix Marmori Nuvola			
<b>Ceramic culture</b> Seramik kültürü			miniworx	Color Line miniworx		

**Wall tiles**

Duvar karoları

**30x60**

BetonX  
British Stone  
Cementine  
Lombardy  
Marmorì  
Metro  
Sense  
Stonelevel  
Urbancrete

**Porcelain tiles**

Porselen karolar

**60x120**

Calacatta  
Cardostone  
Cementine  
Ceppostone  
Flakestone  
Marble - X  
MarmoMix  
Marmorì  
Marmostone  
Newcon  
Nuvola  
Urban Travertino  
Ultra 2.0  
Urbancrete  
Sense  
Softcrete

**30x120**

Craft

**20x120**

Aspenwood  
Craft  
Calacatta  
Oakland  
Samba  
Urbanwood

**40x120**

Aspenwood  
Craft

**45x90**

Metro  
Tech-Slate

**80x80**

Ash & Burn  
Calacatta  
Cardostone  
CementMix  
Ceppostone  
Flakestone  
Ice & Smoke  
Marmostone  
Metalcrete  
Newcon  
Stonelevel  
Urban Travertino  
Urbancrete

**40x80**

Ash & Burn  
Calacatta  
Cardostone  
Ceppostone  
Ice & Smoke  
Stonelevel  
Urbancrete

**60x60**

Ash & Burn  
Beton  
BetonX  
British Stone  
Boscoston  
Calacatta  
Canyon  
Cardostone  
Cementine  
CementMix  
Ceppostone  
Essence  
Flakestone  
Ice & Smoke  
Ilot  
Iron  
Lombardy

MarmoMix  
Marmorì  
Marmostone  
Meridien  
Metro  
Metalcrete  
Newcon  
Pietra Pienza  
Sense  
Softcrete  
Stonelevel  
Tech-Slate  
Urban Travertino  
Ultra 2.0  
Urbancrete

**30x60**

Ash & Burn  
Beton  
BetonX  
British Stone  
Boscoston  
Canyon  
Cardostone  
Cementine  
Ceppostone  
Essence  
Flakestone  
Ice & Smoke  
Lombardy  
MarmoMix  
Marmorì  
Meridien  
Metalcrete  
Metro  
Newcon  
Pietra Pienza  
Quarzite  
Sense  
Softcrete  
Stonelevel  
Tech-Slate  
Ultra 2.0  
Urbancrete

**45x45**

Beton  
Ilot  
Iron  
Lombardy  
Metro  
Newcon  
Stoneway  
Terre  
Ultra 2.0  
Urbancrete  
Vado

**30x30**

Beton  
BetonX  
Cardostone  
Cementine  
Ceppostone  
Essence  
Flakestone  
MarmoMix  
Marmorì  
Metro  
Newcon  
Urbancrete

**15x60**

MarmoMix  
Marmorì

**10x80**

Ash&Burn  
Cardostone  
Ceppostone  
Flakestone  
Ice&Smoke  
Marmostone  
Newcon  
Urbancrete  
Stonelevel

**8,5x60**

Ash&Burn  
Beton  
BetonX  
British Stone  
Cardostone  
Cementine  
Ceppostone  
Flakestone  
Marmostone  
Metro  
Newcon  
Sense  
Stonelevel  
Pietra Pienza  
Ultra 2.0  
Urbancrete

**7,5x60**

MarmoMix  
Marmorì  
**15x15**  
BetonX  
Cementine  
Ceppostone  
**5x5**  
Ash&Burn  
BetonX  
British Stone  
Cardostone  
Cementine  
Ceppostone  
Color Line  
Essence  
Meridien  
Metalcrete  
Metro  
Newcon  
Sense  
Stonelevel  
Tech-Slate  
Urbancrete  
**3.7x20**  
Urbanwood  
**100x300**  
Scale

**Ceramic floor tiles**

Seramik yer karoları

**33x33**

Ilot  
Iron  
Lombardy  
Terre  
Truva  
Vado

**5x5**

Color Line  
miniworx



# PRO

---

## Nature

### Dreams designed with nature

VitrA Tiles' designs let the structures breath. They create living spaces where people can feel as part of the nature which circulates in the building's veins, breathes through its walls and wander about on its floors. VitrA derived the textures in PRO Nature Tiles from the nature and developed innovative solutions for different needs and expectations. It blended the eco-friendly technologies with unique and creative designs, in the light of mind and experience. It prepared series in line with trends, enriching the basic building materials such as marble, stone, wood, metal, concrete and ceramic with different sizes, colours and patterns. In PRO Nature Collection, VitrA gathered the tips of creating living spaces and durable solutions to buildings where thousands of people can enjoy all day long.

### Doğa ile tasarlanan hayaller

VitrA Karo'dan yapının nefes almasına izin veren, doğanın içine sızdığı, damarlarında dolaştığı, duvarlarında soluk aldığı ve zeminlerinde gezindiği tasarımlar. VitrA, PRO Nature Karo Seramikleri dokularını doğadan aldı, farklı ihtiyaç ve beklentiler için yenilikçi çözümler geliştirdi. Akıl ve tecrübenin ışığında çevre dostu teknolojileri, özgün ve yaratıcı tasarımlarla harmanladı. Mermer, taş, ahşap, metal, beton ve seramik gibi temel yapı malzemelerini, farklı ebat, renk ve desenlerle zenginleştirerek trendlerle paralel seriler hazırladı. Yaşayan mekânlar yaratmanın ipuçlarını da, binlerce insanın gün boyu kullanacağı mekânların dayanıklı çözümünü de PRO Nature Koleksiyonu'nda topladı.

Pure concrete  
Beton sadeliği

Stone code  
Taş zamanı

Wood obsession  
Ahşap tutkusu

Marble dream  
Mermer rüyasi

Ceramic culture  
Seramik kültürü



# PRO

Nature

## Creates warm spaces.

VitrA PRO Nature porcelain tiles offer freedom in designing vivid and amiable residential and public spaces such as restaurant, café, hotel etc. , with atmospheres warm as much as the natural material can provide.

## Sıcak mekânlar yaratır.

VitrA PRO Nature porselen karolar kendine özgü doğal dokusuyla; konut, restoran, kafe, otel ve benzeri tüm mekânlarda ancak doğal malzemenin sağlayabileceği sıcaklıkta atmosfere sahip, canlı ve samimi tasarımlar yaratma özgürlüğü sunar.



# PRO

Nature

## **Durable, scratch-proof.**

One of the most remarkable features of Vitra PRO Nature porcelain tiles is paramount strength, durability and the performance they provide. Porcelain tiles do not get scratched by hard surfaces, unlike the natural materials and are resistant against shocks and overloads. Therefore, they can be safely preferred in high-traffic areas such as shopping centres, cafes, restaurants and offices as well as in spaces where surface-scratching items such as chairs and tables are heavily used.

## **Dayanıklıdır, çizilmez.**

Vitra PRO Nature porselen karolarının en önemli özelliklerinden biri üstün sağlamlık ve dayanıklılık performansıdır. Porselen karolar doğal malzemelerin aksine sert yüzeylerle çizilmez, darbeye ve aşırı yüke dayanıklıdır; bu nedenle alışveriş merkezi, kafe, restoran ve ofis gibi insan trafiğinin, ayrıca sandalye ve masa gibi yüzey çizilen eşyaların yoğun olduğu mekânlarda güvenle tercih edilebilir.



# PRO

Nature

## Hygienic, easy to clean.

VitrA PRO Nature porcelain tiles are extremely easy to clean and resistant against cleaning chemicals when compared with many natural materials. Therefore, thanks to their hygienic feature, they can safely be used in educational establishments, hospitals and in high-traffic areas which require frequent cleaning.

## Hijyeniktir, kolay temizlenir.

VitrA PRO Nature porselen karolarda temizlik son derece kolaydır, pek çok doğal malzemenin aksine temizlik kimyasallarına karşı dayanıklıdır. Bu nedenle konutlar, eğitim kurumları, hastaneler ve sık temizlik gerektiren yoğun trafikli mekânlar için hijyen özelliği ile güvenle kullanılabilir.





# PRO

## Nature

### Long-lasting, colour-fast.

VitrA PRO Nature porcelain tiles are quite sun friendly, not affected by the sun as the natural materials such as wood might have both in floor and wall applications. They maintain their brilliant brand-new appearance under all conditions. Hence, they are used hassle-freely in indoor areas such as homes, offices and shops as well as in outdoor areas such as balconies and terraces without losing their textural properties.

### Uzun ömürlüdür, rengi solmaz.

VitrA PRO Nature porselen karolar tam bir güneş dostudur, hem yer hem de duvar kullanımında ahşap gibi doğal malzemelerde olabileceği gibi güneşten etkilenmez, her koşulda ilk günkü göz alıcı halini korur. Bu nedenle ev, ofis, mağaza gibi iç mekânlar ile balkon ve teras gibi dış alanlarda sorunsuzca döşenir ve uzun yıllar yeni görünümünü kaybetmez.



# PRO

Nature

## Safe to use in outdoors.

VitrA PRO Nature porcelain tile is a product which can be used hassle-freely in outdoors for many years, as it is strong and durable. It is not affected by hot and cold temperature changes, resistant against rain, snow and frost. It is ideal for outdoor spaces such as courts and terraces.

## Dış mekânlarda güvenle kullanılır.

VitrA PRO Nature porselen karo sağlam ve dayanıklı olma özelliğiyle dış mekânlarda uzun yıllar problemsiz kullanılacak bir üründür. Sıcak ve soğuk ısı değişimlerinden etkilenmez; yağmur, kar ve dona dayanıklıdır. Bahçe ve teras gibi dış mekânlar için idealdir.



# VitrA Life Solutions

The design raised with functionality  
İşlevselliği yaşam ile birleştiren tasarımlar



## V-Safe



Guaranteed safety with anti-slip & soft-touch surface technology

Yumuşak dokunuşlu ve kaymayan özelliğiyle güvenli adımlar sağlayan yüzey teknolojisi



### V-Safe Mini

Anti-slip, soft-touch and hygienic surface technology providing safe living areas for babies and children  
Bebekler ve çocuklar için güvenli yaşam alanları sağlayan, kaydırmaz, yumuşak dokunuşlu ve hijyenik yüzey teknolojisi



### V-Safe Wet

Anti-slip, easy to clean and hygienic surface technology for wet areas  
Islak alanlar için özel tasarlanmış kaydırmaz, kolay temizlenebilir ve hijyenik özellikli yüzey teknolojisi



### V-Safe Out

High anti-slip performance with wear resistant and weatherproof technology designed for outdoor areas  
Dış mekanlar için özel tasarlanmış, yüksek derecede kaydırmazlık sağlayan, aşınmaya ve hava koşullarına dayanıklı yüzey teknolojisi



### V-Safe Industrial

High level of slip resistance for industrial areas  
Endüstriyel alanlar için en yüksek seviyede kaydırmazlık sağlayan yüzey teknolojisi

## V-Hygiene



Smart surface technologies for hygienic living spaces

Hijyenik yaşam alanları için akıllı yüzey teknolojileri



### V-Agent

No room for viruses  
V-Agent ile yaşam alanlarınızda virüslere yer yok



### VitrA Shield

Self-cleaning technology that inhibits the growth of harmful bacteria  
Zararlı bakterilerin gelişimini engelleyen ve kendi kendini temizleyen karo teknolojisi



### VitrA Clean

Ultra-easy to clean floor and wall tiles  
Kolay temizlenebilirlik özelliğine sahip yer ve duvar karo teknolojisi

## VitrA Glowsafe



Glow in the dark for a safe walk in all living areas

Tüm yaşam alanlarında gece ve gündüz güvenli adımlar için karanlıkta parlayan teknoloji

Stair tiles that harvest the day light and reflect its energy in the night for a safe walk both in indoor and outdoor areas  
Hem iç hem de dış mekanlarda güvenli adımlar için gün boyunca ışığı toplayan ve gece ışığın enerjisini yansıtarak parlayan merdiven karoları

## VitrA reaLook



The most refined state of design to living spaces for ever-lasting look

Yaşam alanlarında en doğal ve kalıcı görünüm sağlayan tasarım teknolojisi

Pure concrete - Combining the simplicity, architectural profoundness and endurance  
Beton sadeliği - Mimari derinlik, dayanıklılık ve sadeliği birleştiren görünüm

Stone code - The secret of nature, which will never fade away  
Taş zamanı - Doğanın hep canlı kalan sırrı

Marble dream - Nature's most precious treasure that combines modern life passion with prominent classical taste  
Mermer rüyası - Modern yaşamı seçkin ve klasik öğelerle harmanlayan, doğanın en değerli hazinesi

Wood obsession - Warm and light-weighted lifelike texture  
Ahşap tutkusu - Sıcak ve doğal ahşap dokular

## VitrA Solid



Long-lasting performance and quality

Uzun ömürlü kalite ve performans



### VitrA Protect+

Very fine glaze application against abrasion and colour fading  
Aşınma ve renk solmasına karşı çok ince sır uygulaması



### VitrA Block

Like the first day: Protection against yellowing  
Sararmaya karşı koruma sağlayan, daima ilk günkü gibi görünüm teknolojisi



### VitrA Professional

Fullbody and colorbody tiles that are extra resistant to harsh conditions in industrial and commercial areas  
Endüstriyel ve ticari alanlardaki zorlu koşullara ekstra dayanıklı full body ve color body karolar.



Brochures in English



Türkçe broşürler



# V-Agent



V-Agent technology is a smart surface technology that **reduces the effect of human coronaviruses and bacteria both on floor and wall tiles by 99.99%**, through a special technique applied to the tile surfaces during the production phase.

\*V-Agent technology is effective against human coronaviruses (Human Coronavirus 229E and OC43) and bacteria (E. coli ve S. aureus) and its effect on these viruses and bacteria has been proven through the tests conducted at **TCNA - North American Ceramic Council** laboratories.

V-Agent, üretim aşamasında karo yüzeylerine uygulanan özel bir teknoloji sayesinde **hem yer hem de duvar karolarında korona virüslerinin ve bakterilerin etkisini %99.99 oranında azaltan** akıllı bir yüzey teknolojisidir.

\*V-Agent teknolojisi, korona virüslerine (Human Coronavirus 229E ve OC43) ve bakterilere (E. coli ve S. aureus) karşı etkili olup, virüs üzerindeki etkisi **TCNA - Kuzey Amerika Seramik Konseyi** laboratuvarlarında yapılan testler ışığında kanıtlanmıştır.

## Hygiene in living spaces

Yaşam alanlarında hijyen

V-Agent provides hygienic protection on both wall and floor tiles with via its technology.

Duvar ve yer karolarında virüs ve bakterilerin etkisini azaltan teknolojisi sayesinde yaşam alanlarında hijyenik etki sağlar.

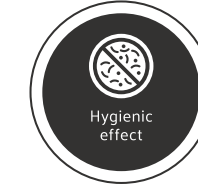

Hygienic effect



Hijyenik etki

## Safety in all living spaces

Tüm yaşam alanlarında güven hissi

Thanks to V-Agent, you will feel the **comfort of hygiene and safety in domestic areas** such as bathrooms, kitchens, living rooms, halls, and terraces; and in **public areas** such as schools, hospitals, restaurants, hotels, shopping malls, gyms and SPAs.

**V-Agent** sayesinde yalnızca banyo, mutfak, salon, koridor, teras gibi **ev içi alanlarda** değil, aynı zamanda okullar, hastaneler, restoranlar, oteller, alışveriş merkezleri, spor salonları, SPA'lar gibi **toplu kullanım alanlarında da** güvende hissedersiniz.



Safe to touch



Güvenli dokunuş

## Environmentally friendly and reliable technology

Çevre dostu ve güvenilir teknoloji

V-Agent technology is **environmentally friendly**. Since it provides easy-to-clean surfaces, it **reduces the effort, the amount of water, energy, chemical cleaning agents and labour** required for cleaning indoor and outdoor surfaces.

V-Agent teknolojisi **çevreye duyarlıdır**. Yüzeyle kolay temizlenebilme özelliği kazandırdığı için iç ve dış mekân yüzeyinin temizlenmesinde gereken **eforu ve suyu, enerjiyi ve kimyasal temizlik maddesi kullanımını azaltır**.



Easy care and cleaning



Saving money and time



Environmental protection



Kolay temizlik



Para ve zaman tasarrufu



Çevre korumaya



<https://vitraglobal.com/explore/v-agent/>



<https://www.vitra.com.tr/kesfet/v-agent/>



# VitrA Shield

Hygienic surface tiles  
with thoughtful technologies

Akıllı teknolojilerle  
hijyenik yüzeyli karolar



## Hygienic effect

VitrA Shield tiles prevent the growth of harmful bacteria thanks to their nano technology. Thus, it provides long-term and continuous hygiene in living spaces.

\*Tests performed in nationally and internationally accredited laboratories show that VitrA Shield provides 99.9% hygienic protection.

## Hijyenik etki

VitrA Shield karolar, sahip oldukları nano teknoloji sayesinde zararlı bakterilerin gelişimini engeller. Böylelikle yaşam alanlarında uzun süreli ve sürekli hijyen sağlar.

\*Ulusal ve uluslararası akredite laboratuvarlarda yapılan testler, VitrA Shield'in %99,9 oranında hijyenik koruma sağladığını göstermektedir.

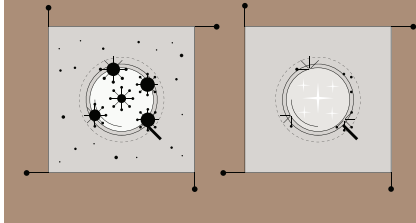

## Bad odours & dirt reduction

Thanks to its strong photocatalytic effect, VitrA Shield reduces bad odours and the negative effects of airborne dirt. Thus, it provides a clean and fresh air.

## Kir ve kötü kokuları azaltma

VitrA Shield güçlü fotokatalitik etkisi sayesinde mekânlardaki kötü kokuları ve havadaki kirlerin olumsuz etkisini azaltır. Böylelikle temiz ve ferah bir hava sağlar.

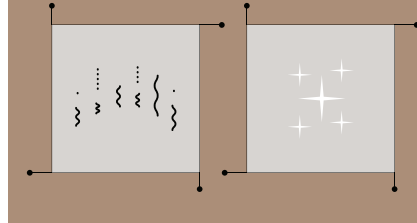

## Self-cleaning technology

VitrA Shield decomposes and eliminates, organic stains and dirt on the surface of the tiles, on contact with the help of light and humidity. Thus, it reduces the amount of water, energy, and chemical agents used while cleaning.

## Kendi kendini temizleme teknolojisi

VitrA Shield, karo yüzeyine gelen organik leke ve kirleri ışık ve nem yardımıyla ayrıştırır ve ortadan kaldırır. Böylelikle temizlikte kullanılan su, enerji ve kimyasal temizlik malzeme kullanımını azaltır.

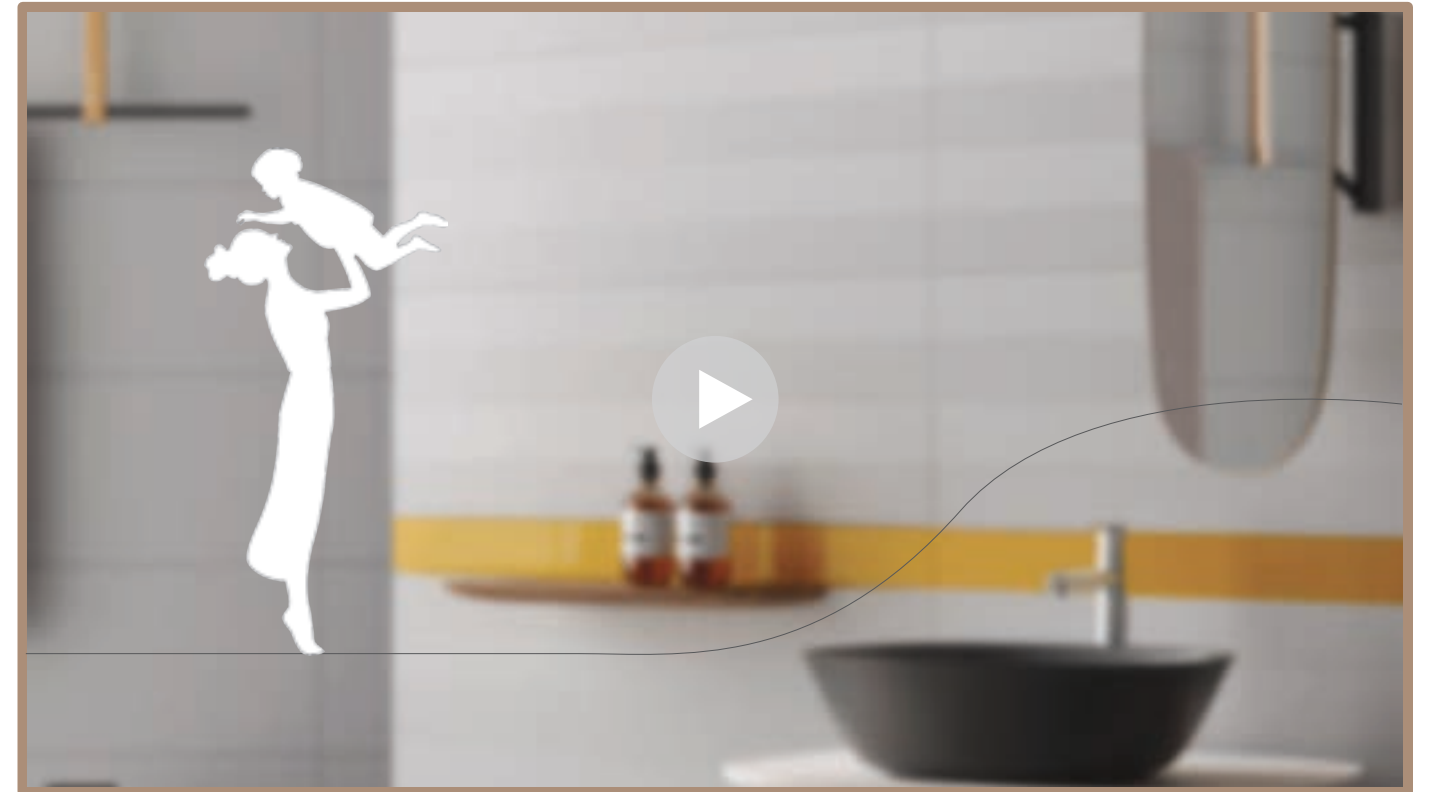
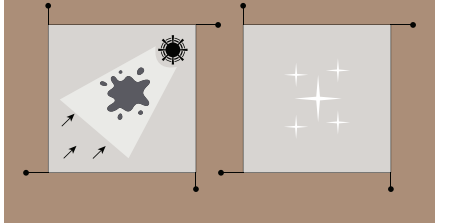

[www.vitraglobal.com/explore/vitra-shield](http://www.vitraglobal.com/explore/vitra-shield)

[www.vitra.com.tr/kesfet/vitra-shield](http://www.vitra.com.tr/kesfet/vitra-shield)



# Virtual Exhibition / Dijital Fuar

Close-up  
product images  
Yakın çekim  
ürün görselleri

Detailed  
information  
about collections  
Koleksiyonlar  
hakkında  
detaylı bilgiler

Digital leaflets  
Dijital föyler

Lifestyle display settings  
Canlı mekân kurulumları

Audio narrations  
Sesli anlatımlar

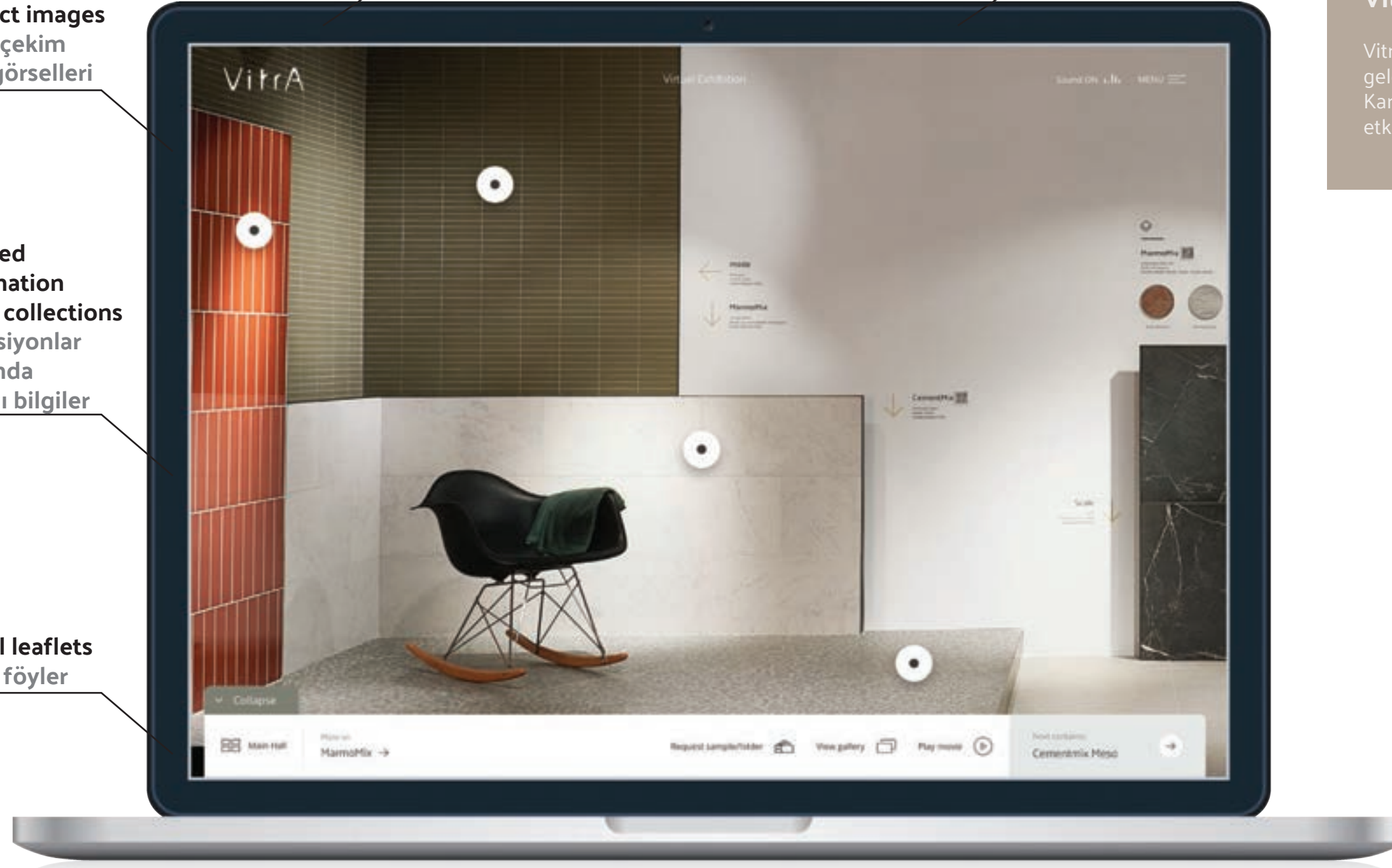

## Vitra Tiles novelties

Vitra Tiles ensures a traditional exhibition experience through a digital platform. In the digital fair, Vitra Tiles' brand-new collections are presented to the visitors in an interactive approach with all the details.

## Vitra Karo yenilikleri

Vitra Karo, Dijital Fuar ile ziyaretçilerine dijital platformda geleneksel fuar deneyimi yaşıyor. Dijital Fuar'da Vitra Karo'nun en yeni koleksiyonları tüm detaylarıyla ve etkileşimli anlatımlarla ziyaretçiler ile buluşuyor.



[digitile.vitraglobal.com](https://digitile.vitraglobal.com)



[digitile.vitra.com.tr](https://digitile.vitra.com.tr)



# VitrAFix

VitrAFix Building Chemicals offers reliable solutions containing all chemicals that may be needed during tile laying and usage, with a wide product portfolio consisting of advanced technical products.

VitrAFix Yapı Kimyasalları, gelişmiş teknik ürünlerden oluşan geniş bir ürün portföyüyle karo döşeme ve kullanım sırasında ihtiyaç duyulabilecek tüm kimyasalları içeren güvenilir çözümler sunar.



## Tile adhesives

Seramik yapıştırma harçları

## Performance improving additives and primers

Performans artırıcı astar ve katkı

## Floor products

Zemin ürünleri

## Waterproofing materials

Su yalıtım malzemeleri

## Joint fillers

Derz dolgu malzemeleri

## Surface cleaning and treatment materials

Temizlik ve koruyucu bakım malzemeleri

## Repair and grout mortar

Tamir ve grout harçları

## Sealants

Sızdırmazlık ve genleşme mastikleri

## VitrAFix solutions VitrAFix çözümleri



### Commercial Ticari alanlar

In large-size porcelain tile and granite ceramic applications on floors subject to heavy pedestrian-load traffic such as shopping malls, schools, hospitals, hotels: VitrAFix Floor Plus Tile Adhesive, VitrAFix Flex Joint Filler

Alışveriş merkezi, okul, hastane, otel gibi yoğun yaya-yük trafiğine maruz zeminlere, büyük ebatlı porselen karo, granit seramik uygulamalarında: VitrAFix Floor Plus Yapıştırma Harcı, VitrAFix Flex Derz Dolgu



### Pool and Spa Havuz çevresi ve Spa

For tile applications in wet areas such as pools, water tanks, Turkish baths: VitrAFix Pool Tile Adhesive, VitrAFix Pool G Joint Filler

Havuz, su deposu, hamam gibi ıslak hacimli mekânlara karo uygulamalarında: VitrAFix Pool Yapıştırma Harcı, VitrAFix Pool G Derz Dolgu



### Facade Dış cephe

For facade porcelain tile and granite ceramic applications: VitrAFix Flex Ultra Tile Adhesive, VitrAFix Flex Joint Filler

Dış cephelere porselen karo, granit seramik uygulamalarında: VitrAFix Flex Ultra Yapıştırma Harcı, VitrAFix Flex Derz Dolgu



### Thermal resistance Isı farkına dayanıklı

In tile applications in places with high temperature changes such as underfloor heating and terraces: VitrAFix Flex Porcelain Tile Adhesive, VitrAFix Flex Joint Filler

Alttan ısıtılmalı zemin, teras gibi sıcaklık değişimlerinin yüksek olduğu mekanlardaki karo uygulamalarında: VitrAFix Flex Porselen Yapıştırma Harcı, VitrAFix Flex Derz Dolgu

VitrA **FIX**

<https://vitrafix.com.tr>





# Pure concrete

## Beton sadeliđi

Concrete is the spirit of structures, the purest state of the architecture. Combining the simplicity, architectural profoundness and endurance, the concrete takes the most refined state of design to your living spaces.

Beton, yapıların ruhu, mimarinin en saf hali. Sadeliđi, mimari derinliđi ve dayanıklılıđı harmanlayan beton, tasarımın en rafine halini yařam alanlarınıza tařıyor.



# Sense



A ceramic series which combines the natural texture of travertine stone with a modern concrete surface. It reinterprets the lines from ancient buildings with industrial design trends of contemporary architecture both in warm and cold colour groups. The collection has matching wall tile, cut decors, and complementary pieces such as step and plinth.

Traverten taşının doğal dokusunu modern beton yüzeyle birleştiren seramik serisi. Antik yapılardan gelen çizgileri, çağdaş mimarinin endüstriyel tasarım trendleriyle hem sıcak hem de soğuk renk gruplarında yeniden yorumluyor. Koleksiyonda uyumlu duvar karoları, kesme dekorlar, basamak ve süpürgelik gibi tamamlayıcı parçalar bulunuyor.



Wall tiles / Duvar karoları :  
K951544R0001VTE0 30x60 Sense Anthracite / Antrasit  
Floor tiles / Yer karoları :  
K951522R0001VTSP 60x120 Solidcrete Anthracite / Antrasit



Wall tiles / Duvar karoları :  
K951545R0001VTE0 30x60 Sense Grey / Gri  
K9515498R001VTE0 5x5 Sense Mosaic decor, grey / Mozaik dekor gri  
Floor tiles / Yer karoları :  
K951542R0001VTE0 30x60 Sense Grey / Gri



# Sense

Colorbody porcelain  
Colorbody porselen



**Product standard / Ürün standardı**  
EN14411 Group Bla

**Footnotes / Dip notlar**  
F H R S

## Base Tiles / Fonlar



Cream / Krem



Light grey / Açık gri



Vizon / Mink

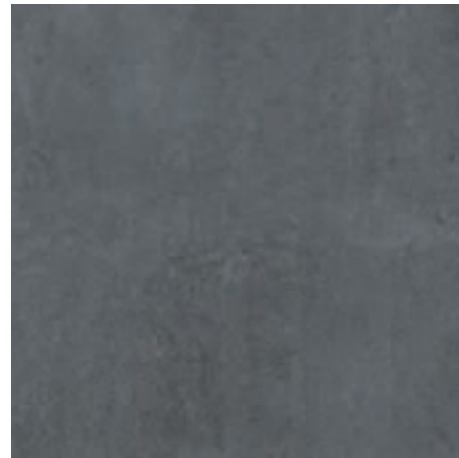

Grey / Gri

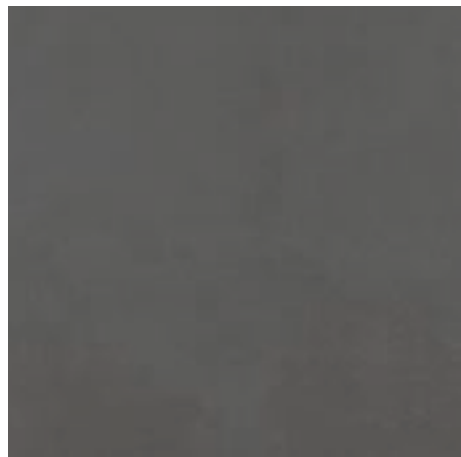

Greige / Grej

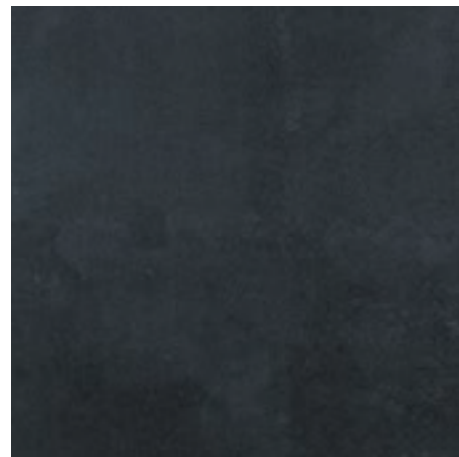

Anthracite / Antrasit

## Decors / Dekorlar

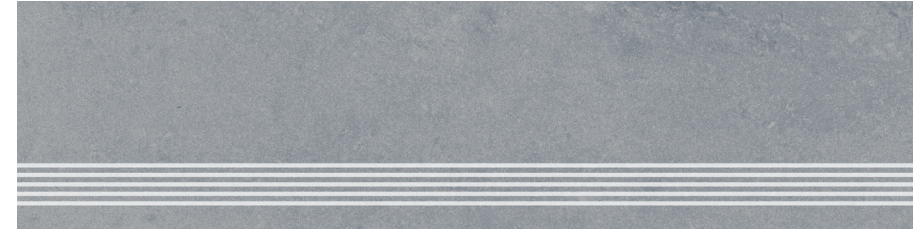

Tread / Basamak  
Light grey / Açık gri



Tread / Basamak  
Light grey / Açık gri



Combi decor / Kombi dekor  
Light grey / Açık gri

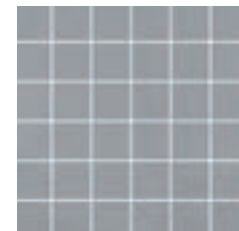

Cut decor / Keme dekor  
Light grey / Açık gri



Plinth / Süpügelik  
Light grey / Açık gri

## Wall tiles Duvar karoları

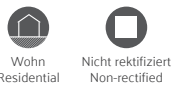

**Produktstandard / Product standard**  
EN14411 Gruppe Bla

**Anmerkungen / Footnotes**  
H R



Warm / Sıcak

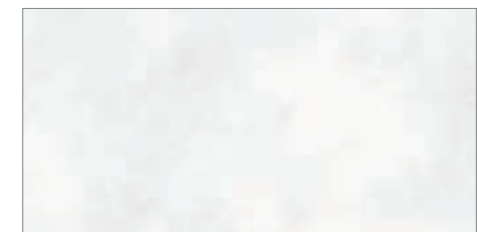

Cold / Soğuk



# Sense



60x60 Mink / Vizon



60x60 Grey / Gri



Colorbody porcelain Colorbody porselen	Surface Yüzey	Thickness Kalınlık	60x120 (24"x48") R 597x1197	60x60 (24"x24") R 597x597	30x60 (12"x24") R 297x597
Cream Krem	R10B	9 mm	K951524R0001VTSP	K951543R0001VTE0	K951546R0001VTE0
Mink Vizon	R10B	9 mm	K951526R0001VTSP	K951516R0001VTE0	K951519R0001VTE0
Greige Grej	R10B	9 mm	K951527R0001VTSP	K951517R0001VTE0	K951520R0001VTE0
Light grey Açık gri	R10B	9 mm	K951528R0001VTSP	K951518R0001VTE0	K951521R0001VTE0
Grey Gri	R10B	9 mm	K951525R0001VTSP	K951542R0001VTE0	K951545R0001VTE0
Anthracite Antrasit	R10B	9 mm	K951522R0001VTSP	K951541R0001VTE0	K951544R0001VTE0



Colorbody porcelain Colorbody porselen	Surface Yüzey	Thickness Kalınlık	30x120 (12"x48") R 397x1197	30x60 (12"x24") R 297x597	30x60 (12"x24") R 297x597
Cream Krem	R10B	9 mm	K951647R0001VTET	K951463R0001VTE0	K9514718R0001VTE0
Mink Vizon	R10B	9 mm	K951648R0001VTET	K951464R0001VTE0	K9514728R0001VTE0
Greige Grej	R10B	9 mm	K951649R0001VTET	K951465R0001VTE0	K9514738R0001VTE0
Light grey Açık gri	R10B	9 mm	K951650R0001VTET	K951466R0001VTE0	K9514748R0001VTE0
Grey Gri	R10B	9 mm	K951651R0001VTET	K951515R0001VTE0	K9514758R0001VTE0
Anthracite Antrasit	R10B	9 mm	K951646R0001VTET	K951547R0001VTE0	K9514708R0001VTE0



# Sense

Plinth /  
Süpürgelik



Mosaic decor /  
Mozaik dekor

Colorbody porcelain Colorbody porselen	Surface Yüzey	Thickness Kalınlık	8,5x60 (3,4"x24") R 82x597	5x5 (2"x2") R 47x47
Cream Krem	R10B	9 mm	K945736R0001VTE0	K9515508R001VTE0
Greige Grej	R10B	9 mm	K951449R0001VTE0	K9514678R001VTE0
Mink Vizon	R10B	9 mm	K951775R0001VTE0	K9514698R001VTE0
Light grey Açık gri	R10B	9 mm	K951450R0001VTE0	K9514688R001VTE0
Grey Gri	R10B	9 mm	K945735R0001VTE0	K9515498R001VTE0
Anthracite Antrasit	R10B	9 mm	K945738R0001VTE0	K9515488R001VTE0

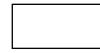

Wall tiles Duvar karosu	Surface Yüzey	Thickness Kalınlık	30x60 (12"x24") 298x598
Warm Sıcak	Matt / Mat	9 mm	K95153100001VTE0
Cold Soğuk	Matt / Mat	9 mm	K95153000001VTE0

Sizes Ebatlar	Thickness Kalınlık (mm)	Box Kutu			Pallet Palet		
		Pcs Adet	m <sup>2</sup>	kg	Box Kutu	m <sup>2</sup>	kg
<b>Colorbody porcelain / Colorbody porselen</b>							
60x120 Rectified / Rektifiyeli	9	2	1,44	29,52	36	51,84	1098
60x60 Rectified / Rektifiyeli	9	4	1,44	26,90	30	43,20	832
30x60 Rectified / Rektifiyeli	9	6	1,08	20,20	40	43,20	807
30x120 Tread / Basamak	9	3	1,08	22,3	44	47,52	1035
30x60 Tread / Basamak	9	6	1,08	20,2	40	43,20	807
30x60 Combi decor / Kombi dekor	9	6	1,08	20,2	40	43,20	807
8,5x60 Plinth / Süpürgelik	9	10	0,51	9,40	98	50,00	950
5x5 Mosaic decor / Mozaik dekor	9	8	0,72	12,24	78	56,16	980
<b>Wall tiles / Duvar karosu</b>							
30x60 Non-Rectified / Rektifiyesiz	9	6	1,08	15,9	48	51,84	764,60



Wall tiles / Duvar karoları :  
K951545R0001VTE0 30x60 Sense Grey / Gri  
K9515498R001VTE0 5x5 Sense Mosaic decor, grey / Mozaik dekor gri  
Floor tiles / Yer karoları :  
K951542R0001VTE0 30x60 Sense Grey / Gri



# CementMix

VitrA creates a tile system based upon cement as one of the fundamental elements of modern urban architecture. Inspired by warm minimalism trend CementMix softens the traditional brutalist look of cement with variety of earthy warm hues. Through its systematic approach, it offers harmonised colour tones and calm texture options for users. In addition to its calm relief appearance, it re-interprets terrazzo appearance from the past to the present by using modern geometric speckles, natural stone and marble chips patterns.

VitrA, modern şehir mimarisinin temel unsurlarından beton üstüne kurulu bir karo sistemi oluşturuyor. Sıcak minimalizm trendinden ilham alan CementMix, modern toprak renkleri kullanarak betonun geleneksel soğuk gri rengini kırıyor ve yeni renk paletiyle ona sofistike bir görünüm kazandırıyor. Sistemsel yaklaşım ile kullanıcılara birbiriyle uyumlu renk tonları ve sakin doku seçenekleri sunuyor. Rölyefli sakin görünüme ek olarak, geçmişten günümüze gelen terrazzo görünümünü, modern geometrik şekiller, çakıl taşı ve mermer parçaları kullanarak yeniden yorumluyor.

## Compatible collections / Uyumlu koleksiyonlar

Ceppostone	Metalcrete
Urban Travertino	mode
Urbancrete	miniworx
Urbanwood	

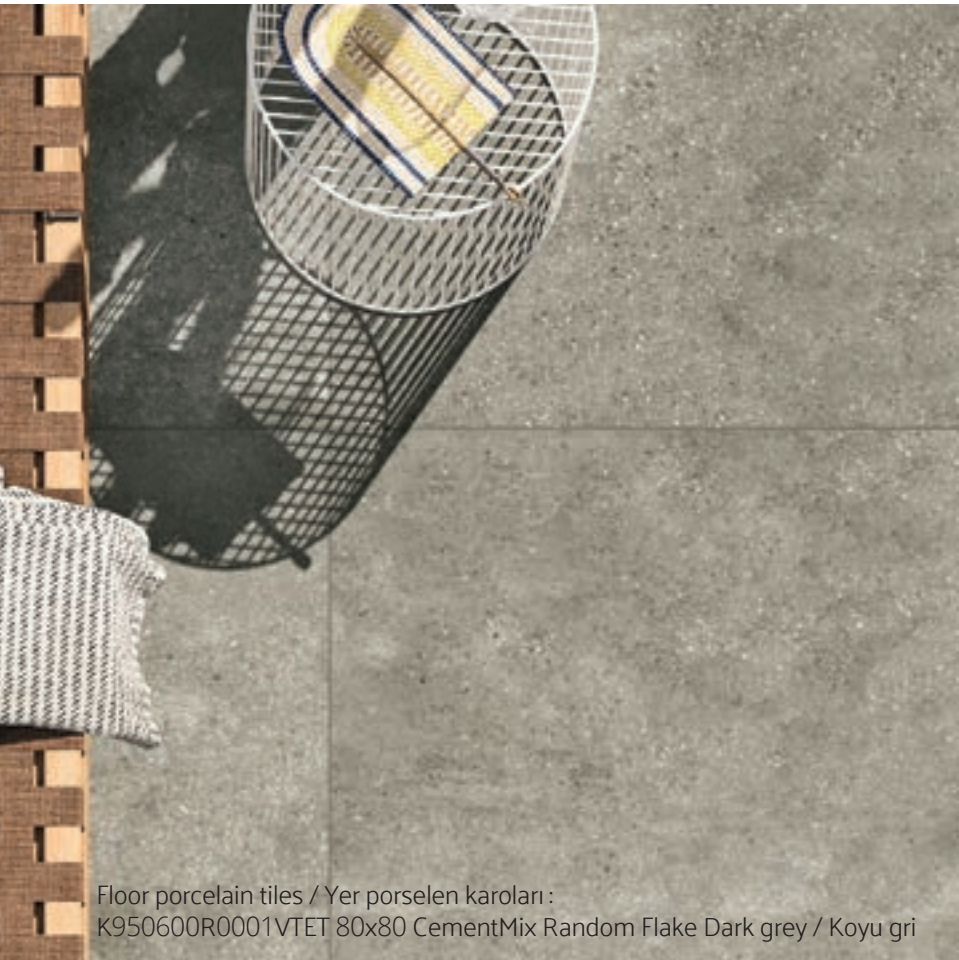

Floor porcelain tiles / Yer porselen karoları :  
K950600R0001VTET 80x80 CementMix Random Flake Dark grey / Koyu gri



Wall tiles / Duvar karoları :  
K950101R0001VTE0 60x60 CementMix Random Flake Light greige / Açık grej



# CementMix Fine Random

Fullbody porcelain  
Fullbody porselen

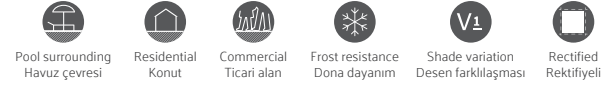

**Product standard / Ürün standardı**  
EN14411 Group Bla

**Footnotes / Dip notlar**  
F H R

## Base Tiles / Fonlar



Light greige / Açık grej



Light grey / Açık gri

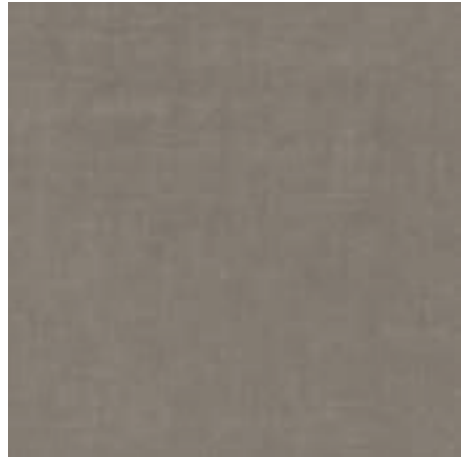

Greige / Grej



Grey / Gri



Dark greige / Koyu grej



Dark grey / Koyu gri

# CementMix Fine Geo

Fullbody porcelain  
Fullbody porselen

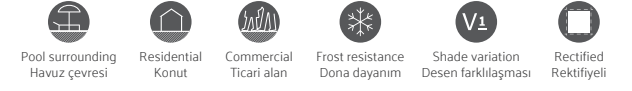

**Product standard / Ürün standardı**  
EN14411 Group Bla

**Footnotes / Dip notlar**  
F H R

## Base Tiles / Fonlar



Light greige / Açık grej



Light grey / Açık gri



Greige / Grej

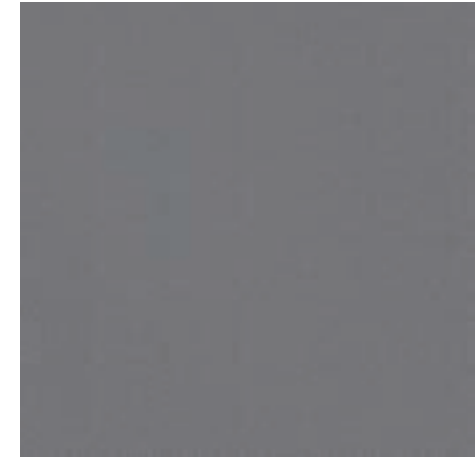

Grey / Gri



Dark greige / Koyu grej



Dark grey / Koyu gri



# CementMix Micro

Colorbody porcelain  
Colorbody porselen

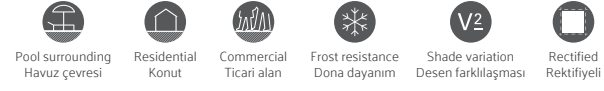

**Product standard / Ürün standardı**  
EN14411 Group Bla

**Footnotes / Dip notlar**  
F H R

## Base Tiles / Fonlar



Light greige / Açık grej



Light grey / Açık gri

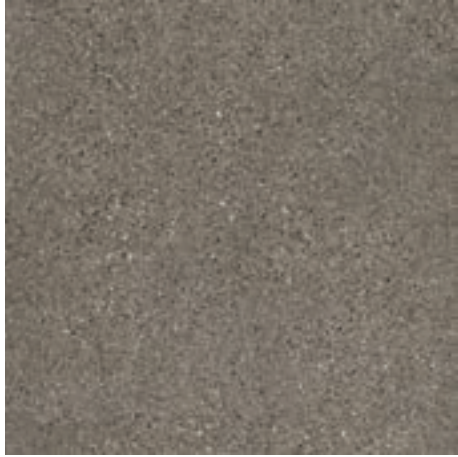

Greige / Grej



Grey / Gri

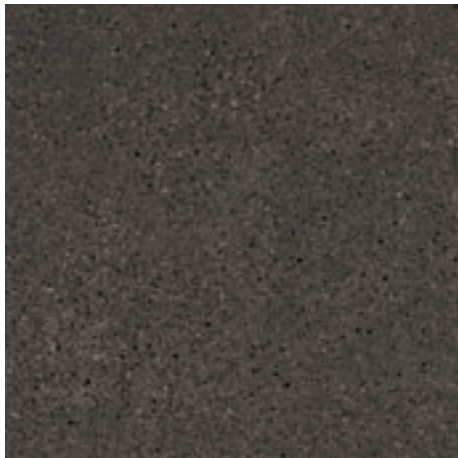

Dark greige / Koyu grej

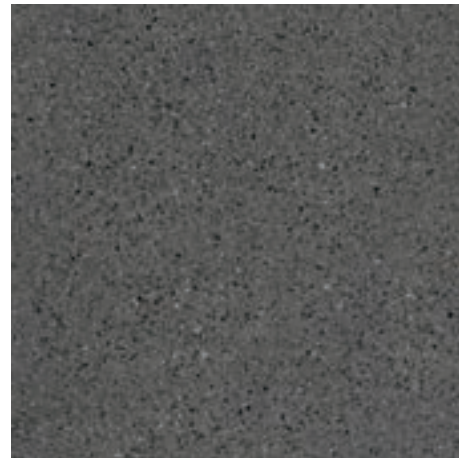

Dark grey / Koyu gri

# CementMix Meso

Colorbody porcelain  
Colorbody porselen



**Product standard / Ürün standardı**  
EN14411 Group Bla

**Footnotes / Dip notlar**  
F H R

## Base Tiles / Fonlar

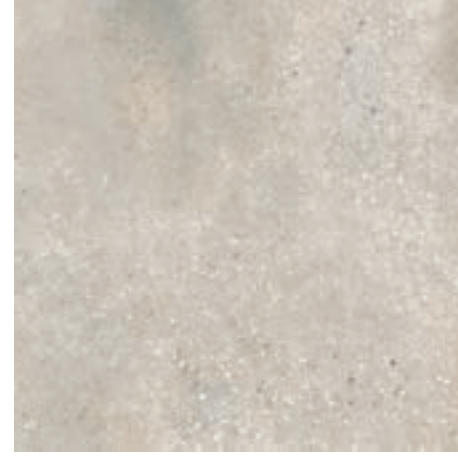

Light greige / Açık grej



Light grey / Açık gri



Greige / Grej



Grey / Gri



Dark greige / Koyu grej



Dark grey / Koyu gri



# CementMix Flake

Colorbody porcelain  
Colorbody porselen

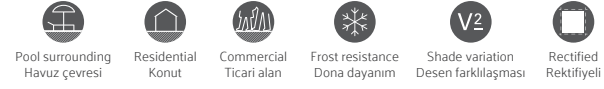

Product standard / Ürün standardı  
EN14411 Group Bla

Footnotes / Dip notlar  
F H R

## Base Tiles / Fonlar

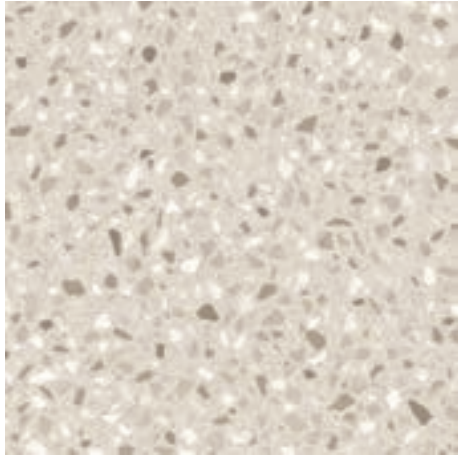

Light greige / Açık grej

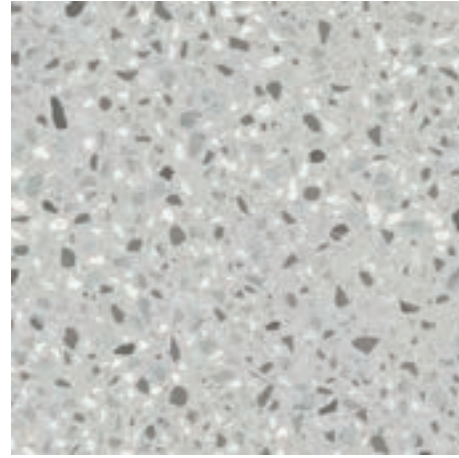

Light grey / Açık gri

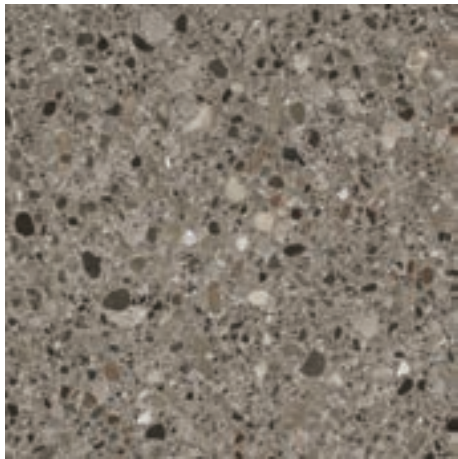

Greige / Grej

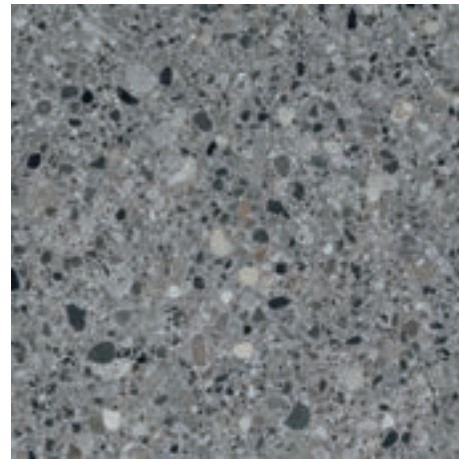

Grey / Gri



Dark greige / Koyu grej

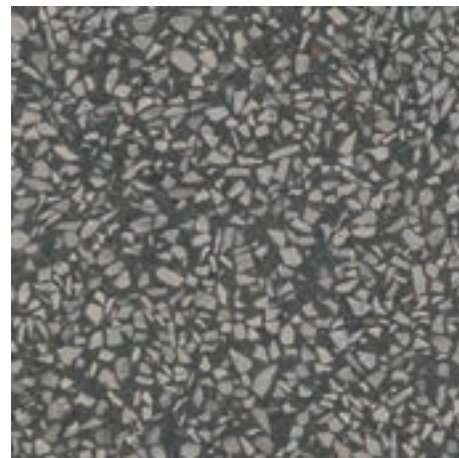

Dark grey / Koyu gri



Wall tiles / Duvar karoları :  
K948790R0001VTET 80x80 CementMix Micro Grey / Gri  
K948789R0001VTET 80x80 CementMix Fine Random Grey / Gri  
Floor porcelain tiles / Yer porselen karoları :  
K948791R0001VTET 80x80 CementMix Flake Grey / Gri



# CementMix



80x80 Light greige / Açık grej

6 Faces / Yüzey görünümü (88x88)



80x80 Dark grey / Koyu gri

6 Faces / Yüzey görünümü (88x88)

## Fine Random

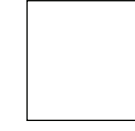

Fullbody porcelain Fullbody porselen	Surface Yüzey	Thickness Kalınlık	80x80 (32"x32") R 797x797	60x60 (24"x24") R 597x597
Light greige Açık grej	R10A	9 mm	K948769R0001VTET	K948799R0001VTE0
Greige Grej	R10A	9 mm	K948774R0001VTET	K948804R0001VTE0
Dark greige Koyu grej	R10A	9 mm	K948779R0001VTET	K948809R0001VTE0
Light grey Açık gri	R10A	9 mm	K948784R0001VTET	K948814R0001VTE0
Grey Gri	R10A	9 mm	K948789R0001VTET	K948819R0001VTE0
Dark grey Koyu gri	R10A	9 mm	K948794R0001VTET	K948824R0001VTE0

## Fine Geo

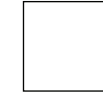
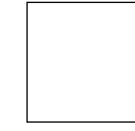

Fullbody porcelain Fullbody porselen	Surface Yüzey	Thickness Kalınlık	80x80 (32"x32") R 797x797	60x60 (24"x24") R 597x597
Light greige Açık grej	R11B	9 mm	K948768R0001VTET	K948798R0001VTE0
Greige Grej	R11B	9 mm	K948773R0001VTET	K948803R0001VTE0
Dark greige Koyu grej	R11B	9 mm	K948778R0001VTET	K948808R0001VTE0
Light grey Açık gri	R11B	9 mm	K948783R0001VTET	K948813R0001VTE0
Grey Gri	R11B	9 mm	K948788R0001VTET	K948818R0001VTE0
Dark grey Koyu gri	R11B	9 mm	K948793R0001VTET	K948823R0001VTE0



# CementMix

## Micro

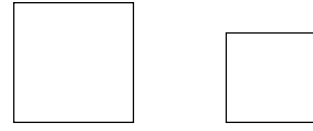

Colorbody porcelain Colorbody porselen	Surface Yüzey	Thickness Kalınlık	80x80 (32"x32") R 797x797	60x60 (24"x24") R 597x597
 Light greige Açık grej	R10A	9 mm	K948770R0001VTET	K948800R0001VTE0
 Greige Grej	R10A	9 mm	K948775R0001VTET	K948805R0001VTE0
 Dark greige Koyu grej	R10A	9 mm	K948780R0001VTET	K948810R0001VTE0
 Light grey Açık gri	R10A	9 mm	K948785R0001VTET	K948815R0001VTE0
 Grey Gri	R10A	9 mm	K948790R0001VTET	K948820R0001VTE0
 Dark grey Koyu gri	R10A	9 mm	K948795R0001VTET	K948825R0001VTE0

## Meso

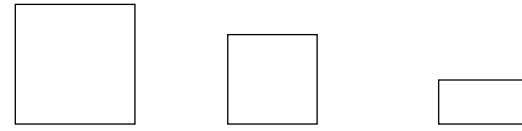

Colorbody porcelain Colorbody porselen	Surface Yüzey	Thickness Kalınlık	80x80 (32"x32") R 797x797	60x60 (24"x24") R 597x597	30x60 (12"x24") R 297x597
 Light greige Açık grej	R10B	9 mm	K950601R0001VTET	K950101R0001VTE0	K950107R0001VTE0
 Greige Grej	R10B	9 mm	K950602R0001VTET	K950102R0001VTE0	K950108R0001VTE0
 Dark greige Koyu grej	R10B	9 mm	K950603R0001VTET	K950103R0001VTE0	K950109R0001VTE0
 Light grey Açık gri	R10B	9 mm	K950598R0001VTET	K950110R0001VTE0	K950104R0001VTE0
 Grey Gri	R10B	9 mm	K950599R0001VTET	K950099R0001VTE0	K950105R0001VTE0
 Dark grey Koyu gri	R10B	9 mm	K950600R0001VTET	K950100R0001VTE0	K950106R0001VTE0

## Flake

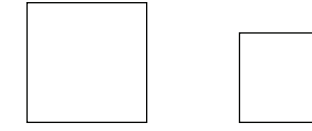

Colorbody porcelain Colorbody porselen	Surface Yüzey	Thickness Kalınlık	80x80 (32"x32") R 797x797	60x60 (24"x24") R 597x597
 Light greige Açık grej	R10A	9 mm	K948771R0001VTET	K948801R0001VTE0
 Greige Grej	R10A	9 mm	K948776R0001VTET	K948806R0001VTE0
 Dark greige Koyu grej	R10A	9 mm	K948781R0001VTET	K948811R0001VTE0
 Light grey Açık gri	R10A	9 mm	K948786R0001VTET	K948816R0001VTE0
 Grey Gri	R10A	9 mm	K948791R0001VTET	K948821R0001VTE0
 Dark grey Koyu gri	R10A	9 mm	K948796R0001VTET	K948826R0001VTE0

Sizes Ebatlar	Thickness Kalınlık (mm)	Box Kutu			Pallet Palet		
		Pcs Adet	m <sup>2</sup>	kg	Box Kutu	m <sup>2</sup>	kg
<b>Fullbody porcelain / Fullbody porselen</b>							
80x80 Rectified / Rektifiyeli	9	2	1,28	24,50	44	56,32	1.103
60x60 Rectified / Rektifiyeli	9	4	1,44	26,64	30	43,20	824
<b>Colorbody porcelain / Colorbody porselen</b>							
80x80 Rectified / Rektifiyeli	9	2	1,28	24,50	44	56,32	1.103
60x60 Rectified / Rektifiyeli	9	4	1,44	26,93	30	43,20	833
30x60 Rectified / Rektifiyeli	9	6	1,08	20,20	40	43,20	833



# Cementine

Cementine porcelain collection softens the bold look of exposed concrete through a mixture of cement and marble dust. Its decors, inspired by the early 20th century houses of Italy's Tuscan region, are a reinterpretation of vintage decors through a modern design aesthetic. A representation of perfect harmony between the old and the new, the collection offers a broad range of options in 4 sizes, 5 different colours, and 15x15 cm sized decors that can be used together with all of the five colours.

Cementine porselen koleksiyonu, yalın beton estetiğini çimento ve mermer tozu karışımıyla harmanlıyor. Beton dokusunun en yumuşak halini yansıtan Cementine'da, ilhamını 20.yüzyıl başı İtalyan Toskana evlerinden alan vintage dekorlar modern bir estetik yaklaşımıyla yeniden yorumlanıyor. Seri, eskiyle yeninin mükemmel uyumunu 4 ebat, 5 farklı renk ve her renk ile uyum içerisinde olan 15x15 ebatlı dekorlarıyla geniş bir seçenek yelpazesinde yansıtıyor.



Wall tiles / Duvar karoları :  
K95021500001VTE0 15x15 Cementine Mix decor / Mix dekor  
K9504818R001VTE0 30x60 Multi-cut decor, cream / Çoklu kesme dekor, krem  
Floor porcelain tiles / Yer porselen karoları :  
K950213R0001VTE0 60x60 Cementine Cream / Krem



Wall tiles / Duvar karoları :  
K95021500001VTE0 15x15 Cementine Mix decor / Mix dekor  
K9504818R001VTE0 30x60 Multi-cut decor, cream / Çoklu kesme dekor, krem  
Floor porcelain tiles / Yer porselen karoları :  
K950213R0001VTE0 60x60 Cementine Cream / Krem



# Cementine

Colorbody porcelain  
Colorbody porselen

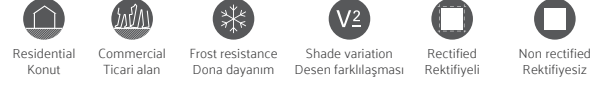

**Product standard / Ürün standardı**  
EN14411 Group Bla

**Footnotes / Dip notlar**  
F H R

## Base Tiles / Fonlar



Cream / Krem

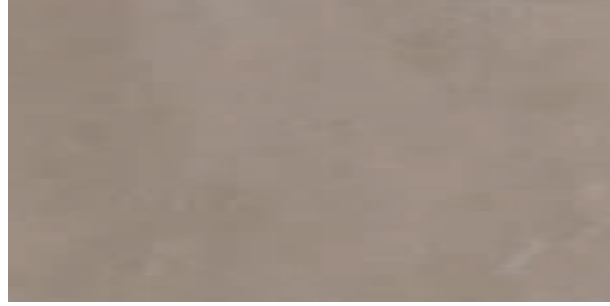

Mink / Vizon



Grey / Gri

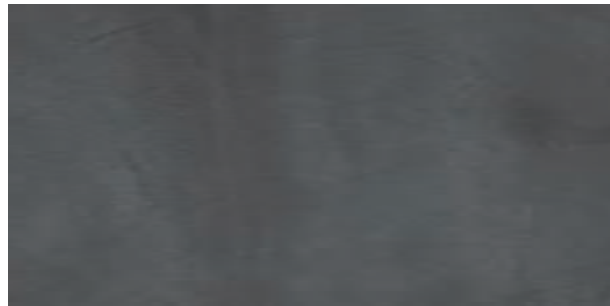

Anthracite / Antrasit

## Decors / Dekorlar

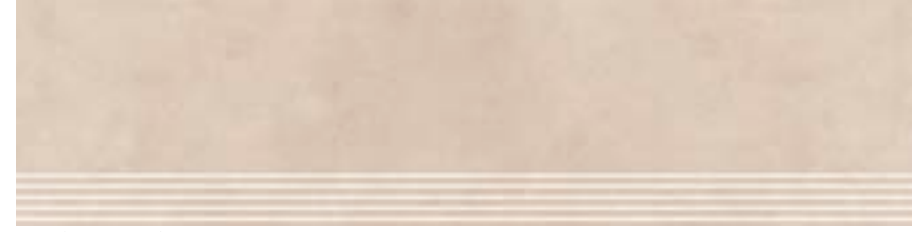

Tread / Basamak  
Cream / Krem



Multi cut decor / Çoklu kesme dekor  
Cream / Krem

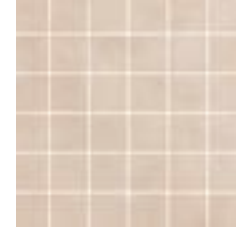

Cut decor / Kesme dekor  
Cream / Krem



Plinth / Süpürgelik  
Cream / Krem

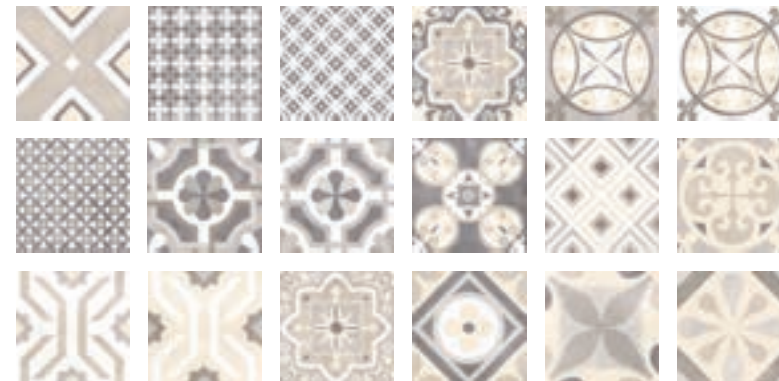

Mix decor / Mix dekor

Cementine mix decor variations are packed in a random mix and can be used together in harmony.  
Cementine mix dekor çeşitleri, birlikte uyum içinde kullanılacak şekilde karışık olarak paketlenir.



# Cementine

Wall tiles  
Duvar karoları



Product standard / Ürün standardı  
EN14411 Group BIII

Footnotes / Dip notlar  
B U

Base Tiles / Fonlar



White / Beyaz



Grey / Gri



60x60 Cream / Krem

7 Faces / Yüzey görünümü (88x88)



Wall tiles / Duvar karoları :  
K950738LPR01VTE0 30x60 Cementine Grey / Gri  
Floor porcelain tiles / Yer porselen karoları :  
K950211R0001VTE0 60x60 Cementine Grey / Gri



60x60 Anthracite / Antrasit

7 Faces / Yüzey görünümü (88x88)





# Cementine

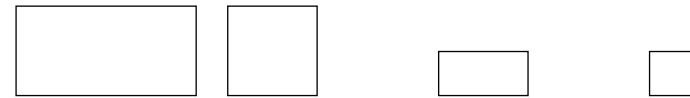

Wall tiles Duvar karoları	Surface Yüzey	Thickness Kalınlık	30x60 (12"x24") R 297x597
 White Beyaz	Matt / Mat	9 mm	K95023900001VTE0
 Grey Gri	Matt / Mat	9 mm	K950738LPR01VTE0



Colorbody porcelain Colorbody porselen	Surface Yüzey	Thickness Kalınlık	60x120 (24"x48") R 597x1197	60x60 (24"x24") R 597x597	30x60 (12"x24") R 297x597	30x30 (12"x12") 298x298
 Cream Krem	LPR	9 mm	K950706LPR01VTSP	K950213LPR01VTE0	K950740LPR01VTE0	
	R10B	9 mm	K950706R0001VTSP	K950213R0001VTE0	K950740R0001VTE0	
	R10B	7 mm				K95037900001VTE0
 Mink Vizon	LPR	9 mm	K950707LPR01VTSP	K950212LPR01VTE0	K950739LPR01VTE0	
	R10B	9 mm	K950707R0001VTSP	K950212R0001VTE0	K950739R0001VTE0	
	R10B	7 mm				K95037800001VTE0
 Grey Gri	LPR	9 mm	K950705LPR01VTSP	K950211LPR01VTE0	K950738LPR01VTE0	
	R10B	9 mm	K950705R0001VTSP	K950211R0001VTE0	K950738R0001VTE0	
	R10B	7 mm				K95037700001VTE0
 Anthracite Antrasit	LPR	9 mm	K950695LPR01VTSP	K950210LPR01VTE0	K950737LPR01VTE0	
	R10B	9 mm	K950695R0001VTSP	K950210R0001VTE0	K950737R0001VTE0	
	R10B	7 mm				K95037600001VTE0



Decors Dekorlar	Surface Yüzey	Thickness Kalınlık	30x120 (12"x48") R 397x1197	30x60 (12"x24") R 297x597	5x5 (2"x2") R 47x47	8,5x60 (3,4"x24") R 82x597
 Cream Krem	Matt / Mat	9 mm		K9504818R001VTE0		
	R10B	9 mm	K950730R0001VTET		K9507548R001VTE0	K950753R0001VTE0
 Mink Vizon	Matt / Mat	9 mm		K9504578R001VTE0		
	R10B	9 mm	K950732R0001VTET		K9507578R001VTE0	K950752R0001VTE0
 Grey Gri	Matt / Mat	9 mm		K9504568R001VTE0		
	R10B	9 mm	K950731R0001VTET		K9507568R001VTE0	K950750R0001VTE0
 Anthracite Antrasit	Matt / Mat	9 mm		K9504558R001VTE0		
	R10B	9 mm	K950729R0001VTET		K9507558R001VTE0	K950751R0001VTE0



Mix decor /  
Mix dekor

Decors Dekorlar	Surface Yüzey	Thickness Kalınlık	15x15 (6"x6") R 147x147
 Mix Mix	R10B	9 mm	K95021500001VTE0

Sizes Ebatlar	Thickness Kalınlık (mm)	Box Kutu			Pallet Palet		
		Pcs Adet	m <sup>2</sup>	kg	Box Kutu	m <sup>2</sup>	kg
<b>Wall tiles / Duvar karoları</b>							
30x60 Non-rectified / Rektifiyesiz	9	6	1,08	15,93	48	51,84	790
<b>Colorbody porcelain / Colorbody porselen</b>							
60x120 Rectified / Rektifiyeli	9	2	1,44	29,52	36	51,84	1.098
60x60 Rectified / Rektifiyeli	9	4	1,44	26,93	30	43,20	833
30x60 Rectified / Rektifiyeli	9	6	1,08	20,20	40	43,20	833
30x120 Tread / Basamak	9	3	1,08	22,30	44	47,52	1.035
8.5x60 Plinth / Süpürgelik	9	10	0,51	9,40	98	50,00	950
5x5 Cut decor / Kesme dekor	9	8	0,72	12,24	78	56,16	980
<b>Glazed porcelain / Sırlı porselen</b>							
30x30 Non-rectified / Rektifiyesiz	7	11	1,00	18,00	72	72,00	1.321
15x15 Decor / Dekor	9	29	0,65	11,96	80	52,00	982



# Softcrete

Softcrete, a glazed porcelain collection that reflects the calm look of exposed concrete to ceramic tiles in warm and cold colour tones with five different colour options. Through the concrete relief surface it adds depth to the spaces and through the matt surface it ensures ease of cleaning. It is modular with 30x60, 60x60, and 60x120 size options and provides options for users to create timeless spaces.

Softcrete, sıcak ve soğuk tonlardan oluşan beş farklı renk seçeneği ile sizin brüt beton görünümünü karo yüzeyine yansıtan sırlı porselen koleksiyonu. Beton rölyefli yapısı sayesinde derinlik algısı yaratırken aynı zamanda kolay temizlenebilir mat yüzeyi rezidansiyel alanlarda uzun yıllar kullanımına olanak sağlıyor. 30x60, 60x60 ve 60x120 ebat seçenekleri ile modüler dönebiliyor ve tasarımıyla zamana meydan okuyan mekânlar yaratıyor.



Wall tiles / Duvar karoları :  
K949851R0001VTE0 30x60 Softcrete Cream / Krem  
Floor porcelain tiles / Yer porselen karoları :  
K949845R0001VTE0 60x60 Softcrete Light grey / Açık gri



Wall tiles / Duvar karoları :  
K949851R0001VTE0 30x60 Softcrete Cream / Krem  
K949846R0001VTE0 60x60 Softcrete Cream / Krem  
K949850R0001VTE0 30x60 Softcrete Light grey / Açık gri  
Floor porcelain tiles / Yer porselen karoları :  
K949845R0001VTE0 60x60 Softcrete Light grey / Açık gri



# Softcrete

Glazed porcelain  
Sırlı porselen

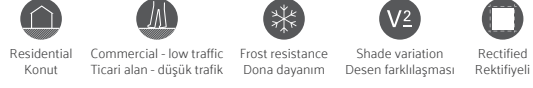

**Product standard / Ürün standardı**  
EN14411 Group B1a

**Footnotes / Dip notlar**  
H R

## Base Tiles / Fonlar



Light grey / Açık gri



Cream / Krem



Dark grey / Koyu gri



Taupe / Taupe



Anthracite / Antrasit

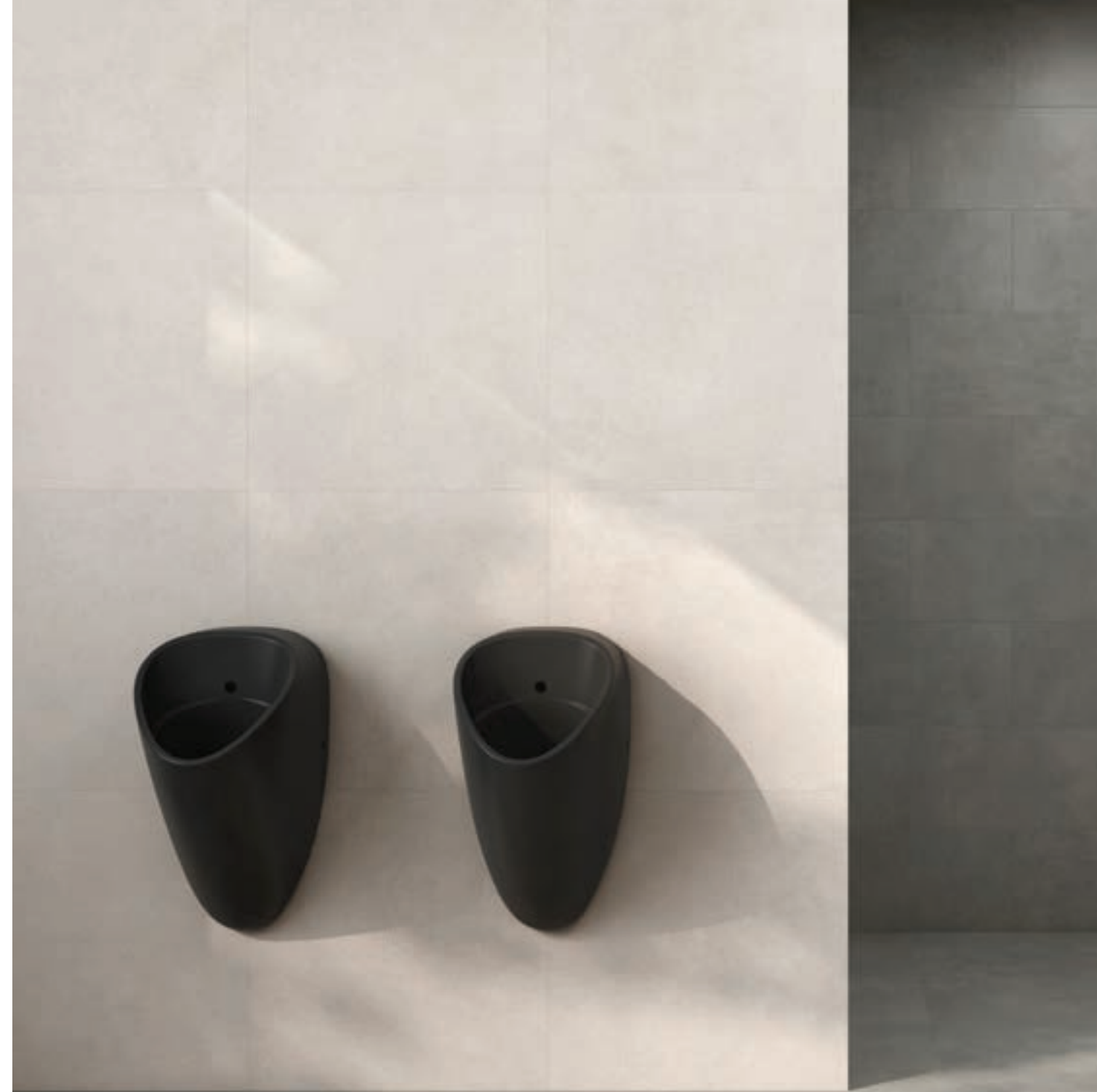

Wall tiles / Duvar karoları :  
K949851R0001VTE0 30x60 Softcrete Cream / Krem  
K949846R0001VTE0 60x60 Softcrete Cream / Krem  
K949850R0001VTE0 30x60 Softcrete Light grey / Açık gri  
Floor porcelain tiles / Yer porselen karoları :  
K949845R0001VTE0 60x60 Softcrete Light grey / Açık gri



# Softcrete



60x120 Light grey / Açık gri

7 Faces / Yüzey görünümü (34x130)



60x120 Anthracite / Antrasit

7 Faces / Yüzey görünümü (34x130)

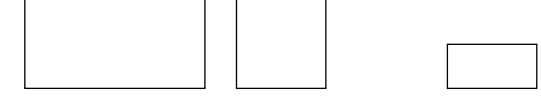

Glazed porcelain Sırlı porselen	Surface Yüzey	Thickness Kalınlık	60x120 (24"x48") R 597x1197	60x60 (24"x24") R 597x597	30x60 (12"x24") R 297x597
Light grey Açık gri	R9	9 mm	K950064R0001VTSP	K949845R0001VTE0	K949850R0001VTE0
Dark grey Koyu gri	R9	9 mm	K950062R0001VTSP	K949843R0001VTE0	K949848R0001VTE0
Anthracite Antrasit	R9	9 mm	K950063R0001VTSP	K949844R0001VTE0	K949849R0001VTE0
Cream Krem	R9	9 mm	K950065R0001VTSP	K949846R0001VTE0	K949851R0001VTE0
Taupe Taupe	R9	9 mm	K950066R0001VTSP	K949847R0001VTE0	K949852R0001VTE0

Sizes Ebatlar	Thickness Kalınlık (mm)	Box Kutu			Pallet Palet		
		Pcs Adet	m <sup>2</sup>	kg	Box Kutu	m <sup>2</sup>	kg
<b>Glazed porcelain / Sırlı porselen</b>							
60x120 Rectified / Rektifiyeli	9	2	1,44	29,52	36	51,84	1.098
60x60 Rectified / Rektifiyeli	9	4	1,44	26,90	30	43,20	832
30x60 Rectified / Rektifiyeli	9	6	1,08	20,09	40	43,20	829



# BetonX

BetonX, a colorbody porcelain collection which reflects the simplicity of concrete in warm and cold colour tones with five different colour options. The collection makes a sophisticated approach to spaces with its ethnical print decors. Through its 30x60 and 60x60 size modularity, it further enriches options for users and through its high anti-slip surface properties, it enables usage for many years in high traffic areas.

BetonX colorbody porselen koleksiyonu, betonun yalın dokusunu sıcak ve soğuk tonlardan oluşan beş farklı renk seçeneği ile karo yüzeyine yansıtıyor. Koleksiyon, etnik baskı dekorları ve kesme bordürleri ile mekanlara sofistike bir yaklaşım getiriyor ve 30x60, 60x60 ebatlı karoların modüler kullanımı ile döşeme zenginliği sunuyor. Dayanıklı yapısı ve yüksek kaydırmazlık özelliği sayesinde BetonX, insan trafiğinin yoğun olduğu alanlarda uzun yıllar kullanım sağlıyor.



Floor porcelain tiles / Yer porselen karoları :  
K949840R0001VTE0 60x60 BetonX Decor / Dekor Light grey / Açık gri



Wall tiles / Duvar karoları :  
K949830R0001VTE0 30x60 BetonX Light grey / Açık gri  
K9498258R001VTE0 30x60 BetonX Combi decor, dark grey / Combi dekor, koyu gri  
Floor porcelain tiles / Yer porselen karoları :  
K949840R0001VTE0 60x60 BetonX Decor / Dekor Light grey / Açık gri



# BetonX

Colorbody porcelain  
Colorbody porselen



**Product standard / Ürün standardı**  
EN14411 Group Bla

**Footnotes / Dip notlar**  
H K R

## Base Tiles / Fonlar

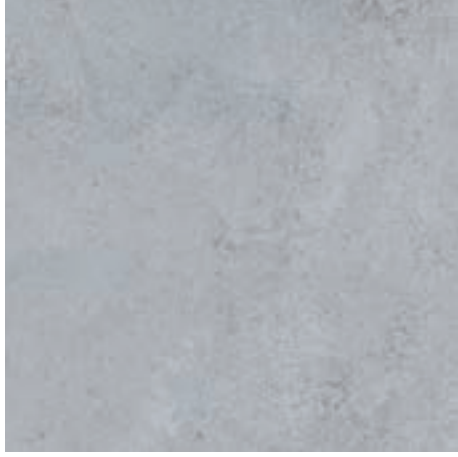

Light grey / Açık gri



Cream / Krem



Dark grey / Koyu gri

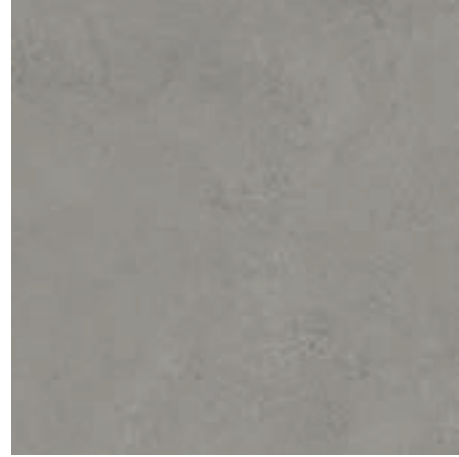

Taupe / Taupe



Anthracite / Antrasit

## Decors / Dekorlar



Combi decor / Kombi dekor  
Light grey / Açık gri

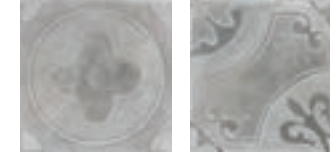

Decor / Dekor  
Light grey / Açık gri

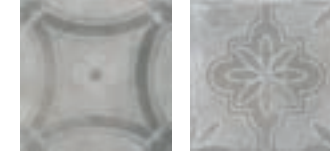

Cut decor / Kesme dekor  
Light grey / Açık gri



Tread / Basamak  
Light grey / Açık gri



Plinth / Süpürgelik  
Light grey / Açık gri



# BetonX

Glazed porcelain  
Sırlı porselen



Product standard / Ürün standardı  
EN14411 Group Bla

## Base Tiles / Fonlar

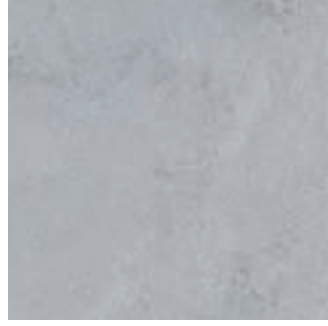

Light grey / Açık gri

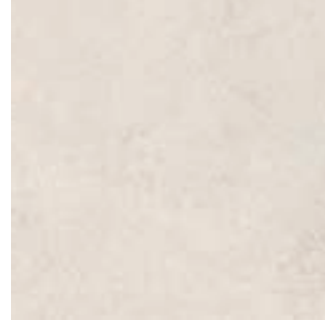

Cream / Krem



Dark grey / Koyu gri

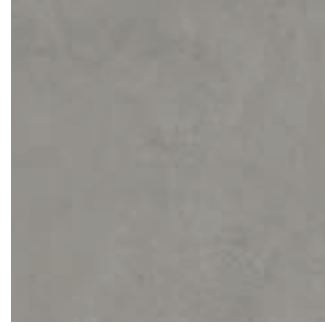

Taupe / Taupe



Anthracite / Antrasit

## Decors / Dekorlar

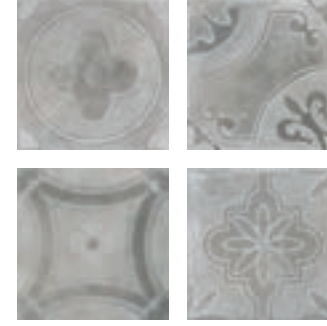

Decor / Dekor  
Light grey / Açık gri

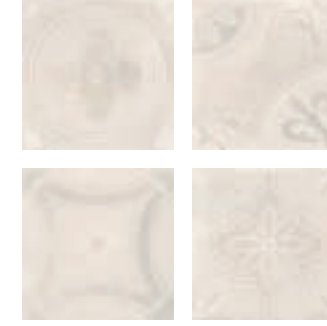

Decor / Dekor  
Cream / Krem

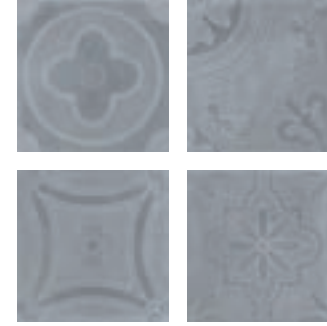

Decor / Dekor  
Dark grey / Koyu gri

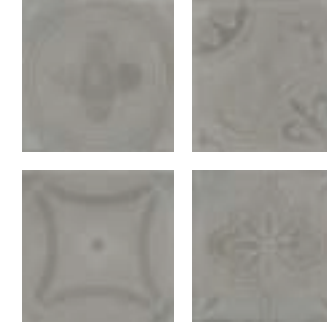

Decor / Dekor  
Taupe / Taupe

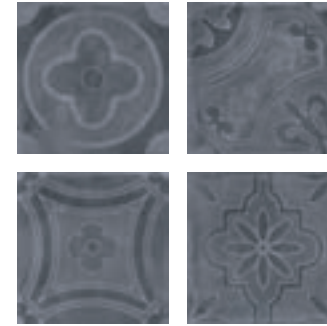

Decor / Dekor  
Anthracite / Antrasit



# BetonX

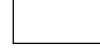

Colorbody porcelain Colorbody porselen	Surface Yüzey	Thickness Kalınlık	60x60 (24"x24") R 597x597	30x60 (12"x24") R 297x597
Light grey Açık gri	R10B	9 mm	K949835R0001VTE0	K949830R0001VTE0
Dark grey Koyu gri	R10B	9 mm	K949833R0001VTE0	K949828R0001VTE0
Anthracite Antrasit	R10B	9 mm	K949834R0001VTE0	K949829R0001VTE0
Cream Krem	R10B	9 mm	K949836R0001VTE0	K949831R0001VTE0
Taupe Taupe	R10B	9 mm	K949837R0001VTE0	K949832R0001VTE0



Decor Dekor	Surface Yüzey	Thickness Kalınlık	30x60 (12"x24") R 297x597	30x60 (12"x24") R 297x597	8,5x60 (3,4"x24") R 82x597	5x5 (2"x2") R 47x47
Light grey Açık gri	R10B	9 mm	K9498258R001VTE0	K949981R0001VTE0	K950044R0001VTE1	K9498688R001VTE0
Dark grey Koyu gri	R10B	9 mm	K9498718R001VTE0	K949979R0001VTE0	K950042R0001VTE1	K9498668R001VTE0
Anthracite Antrasit	R10B	9 mm	K9498728R001VTE0	K949980R0001VTE0	K950043R0001VTE1	K9498678R001VTE0
Cream Krem	R10B	9 mm	K9498268R001VTE0	K949982R0001VTE0	K950045R0001VTE1	K9498698R001VTE0
Taupe Taupe	R10B	9 mm	K9498278R001VTE0	K949983R0001VTE0	K950046R0001VTE1	K9498708R001VTE0



Decor Dekor	Surface Yüzey	Thickness Kalınlık	60x60 (24"x24") R 597x597
Light grey Açık gri	R10B	9 mm	K949840R0001VTE0
Dark grey Koyu gri	R10B	9 mm	K949838R0001VTE0
Anthracite Antrasit	R10B	9 mm	K949839R0001VTE0
Cream Krem	R10B	9 mm	K949841R0001VTE0
Taupe Taupe	R10B	9 mm	K949842R0001VTE0



Glazed porcelain Sırlı porselen	Surface Yüzey	Thickness Kalınlık	30x30 (12"x12") 298x298
Light grey Açık gri	R10B	7 mm	K94982200001VTE0
Dark grey Koyu gri	R10B	7 mm	K94982000001VTE0
Anthracite Antrasit	R10B	7 mm	K94982100001VTE0
Cream Krem	R10B	7 mm	K94982300001VTE0
Taupe Taupe	R10B	7 mm	K94982400001VTE0



Decor Dekor	Surface Yüzey	Thickness Kalınlık	15x15 (6"x6") R 147x147
Light grey Açık gri	R10B	9 mm	K94987500001VTE0
Dark grey Koyu gri	R10B	9 mm	K94987300001VTE0
Anthracite Antrasit	R10B	9 mm	K94987400001VTE0
Cream Krem	R10B	9 mm	K94987600001VTE0
Taupe Taupe	R10B	9 mm	K94987700001VTE0



# BetonX

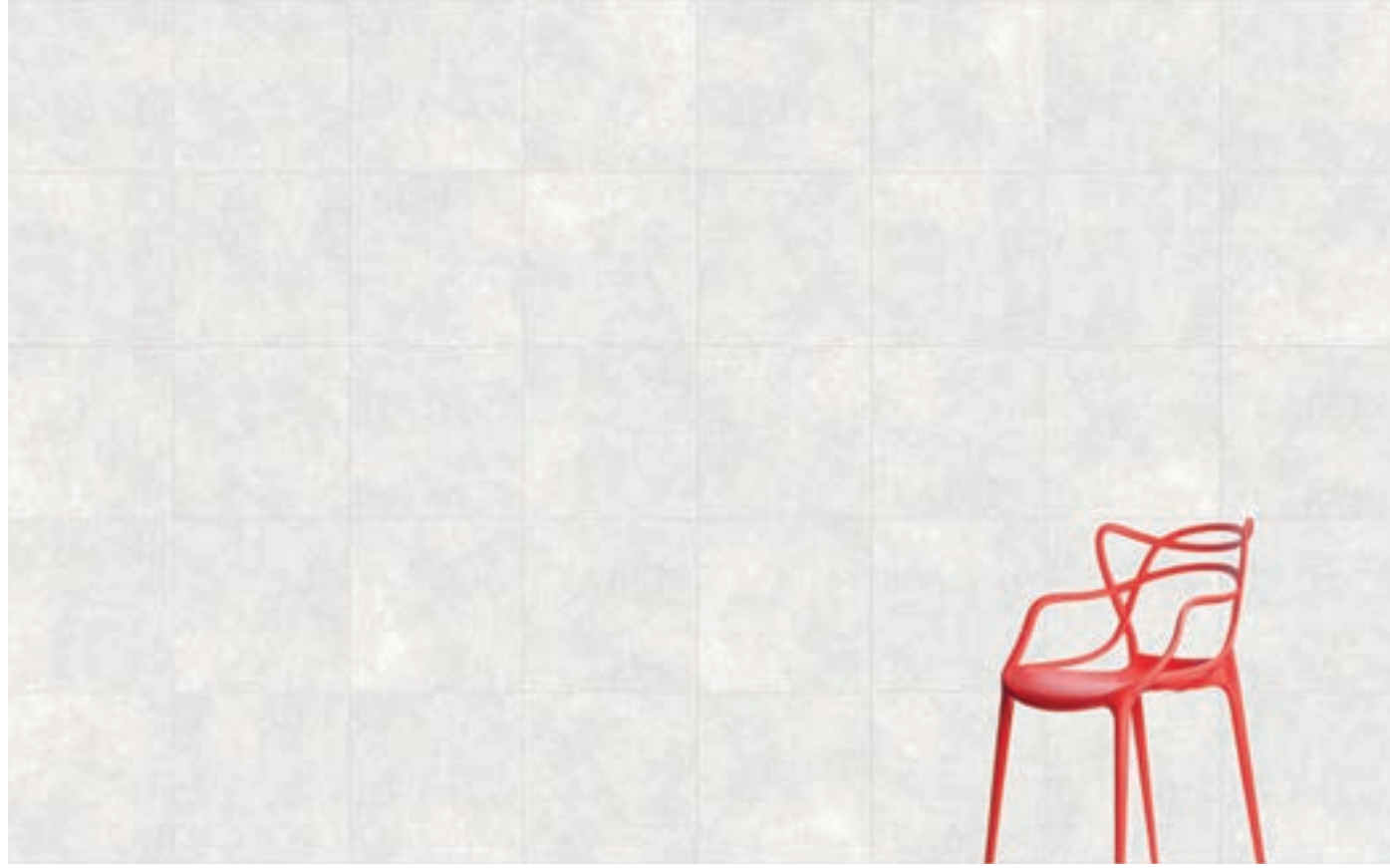

60x60 White / Beyaz

7 Faces / Yüze görünümü (88x88)



60x60 Grey / Gri

7 Faces / Yüze görünümü (88x88)

Sizes Ebatlar	Thickness Kalınlık (mm)	Box Kutu			Pallet Palet		
		Pcs Adet	m <sup>2</sup>	kg	Box Kutu	m <sup>2</sup>	kg
<b>Colorbody porcelain / Colorbody porselen</b>							
60x60 Rectified / Rektifiyeli	9	4	1,44	26,78	30	43,20	829
30x60 Rectified / Rektifiyeli	9	6	1,08	20,09	40	43,20	829
60x60 Decor / Dekor	9	4	1,44	26,78	30	43,20	829
30x60 Combi decor / Kombi dekor	9	4	0,72	13,54	30	21,60	431
30x60 Tread / Basamak	9	6	1,08	20,20			
5x5 Cut decor / Kesme dekor	9	8	0,72	12,24	78	56,16	980
8,5x60 Plinth / Süpürgelik	9	10	0,51	9,40	98	50,00	950
<b>Glazed porcelain / Sırlı porselen</b>							
15x15 Decor / Dekor	9	11	0,25	4,63	165	41,25	788
30x30 Non-rectified / Rektifiyesiz	7	11	1,00	14,40	72	72,00	1.062
<b>Wall tiles / Duvar karoları</b>							
30x60 Non-rectified / Rektifiyesiz	9	6	1,08	16,31	48	51,84	808



Floor porcelain tiles / Yer porselen karoları :  
K949840R0001VTE0 60x60 BetonX Decor / Dekor Light grey / Açık gri



# Urbancrete

A colorbody porcelain collection that infuses a modern, architectural look into the timeless and robust character of exposed concrete. Urbancrete completes the sophisticated mix of warm and cold colours of the ColorCode approach with ethnic and geometric hexagonal decorative tiles. Highly durable, with a powerful anti-slip surface that is easy to clean, the Urbancrete Porcelain Collection can be used in high traffic areas for many years.

Brüt betonun güçlü ve zamana karşı duran karakterini çağdaş mimariye katan colorbody porselen koleksiyonu. Urbancrete, sofistike bir karma sunan ColorCode yaklaşımının sıcak ve soğuk renklerini, etnik ve geometrik altıgen dekorlarla tamamlıyor. Urbancrete, dayanıklı colobody bünyesi, güçlü kaydırmazlık özelliği ve temizlenme kolaylığı ile yüksek trafikli genel kullanım alanlarında uzun yıllar kullanım sağlıyor.

## Compatible collections / Uyumlu koleksiyonlar

Urbancrete	Urban Travertino
Ceppostone	retromix
Urbanwood	CementMix
Metalcrete	



Wall tiles / Duvar karoları :  
K947084R0001VTET 80x80 Urbancrete Mink / Vizon



Wall tiles / Duvar karoları :  
K9472558R001VTE0 30x60 Urbancrete Mink / Vizon  
K947084R0001VTET 80x80 Urbancrete Mink / Vizon  
Floor porcelain tiles / Yer porselen karoları :  
K947488R0001VTE0 20x120 Urbanwood Mink / Vizon



# Urbancrete

Colorbody porcelain  
Colorbody porselen



**Product standard / Ürün standardı**  
EN14411 Group Bla

**Footnotes / Dip notlar**  
F H R

## Base Tiles / Fonlar



White / Beyaz

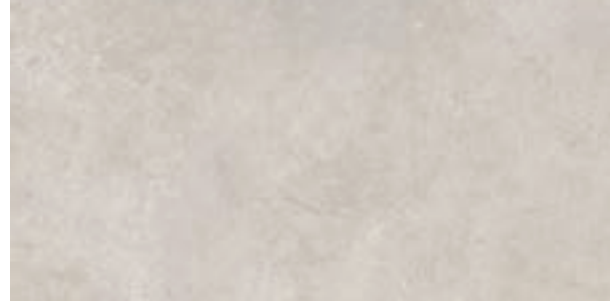

Mink / Vizon

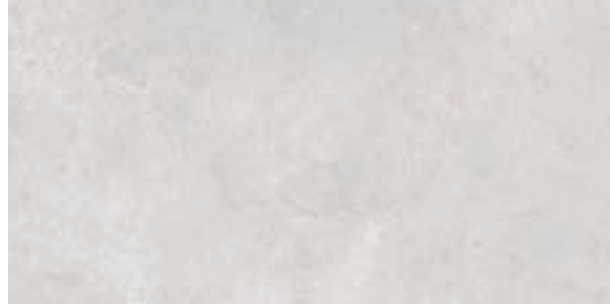

Grey / Gri

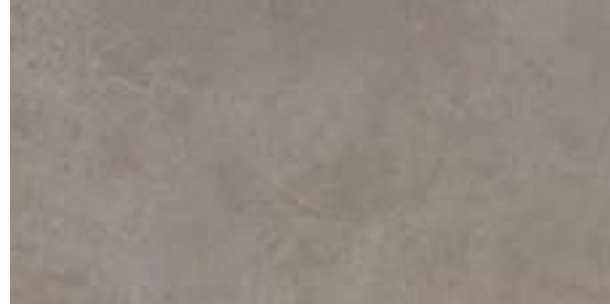

Dark greige / Koyu grej

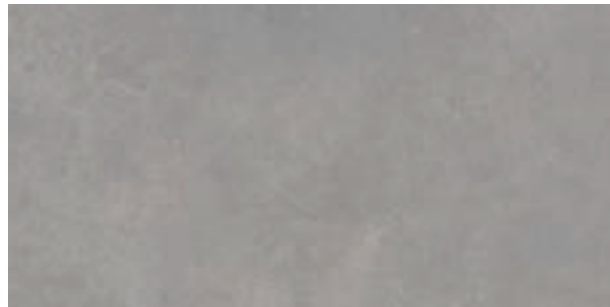

Dark grey / Koyu gri

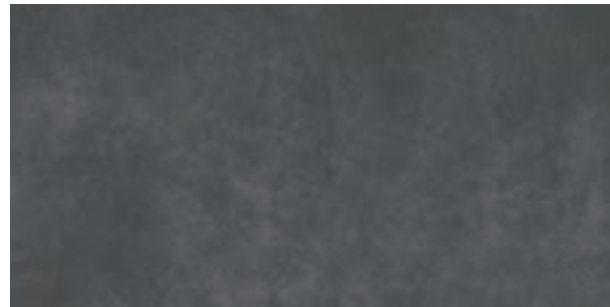

Anthracite / Antrasit

## Decors / Dekorlar

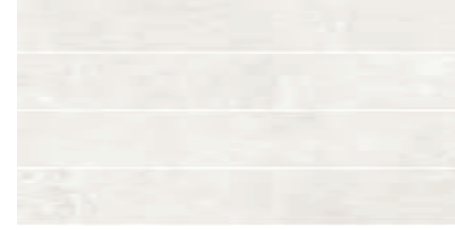

Brick cut decor / Tuğla kesme dekor

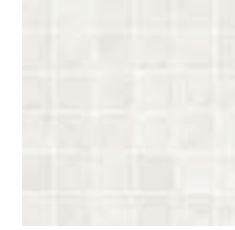

Cut decor / Kesme dekor

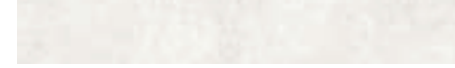

Plinth / Süpürgelik

## Wall tiles Duvar karoları



**Product standard / Ürün standardı**  
EN14411 Group BIII

**Footnotes / Dip notlar**  
H

## Base Tiles / Fonlar

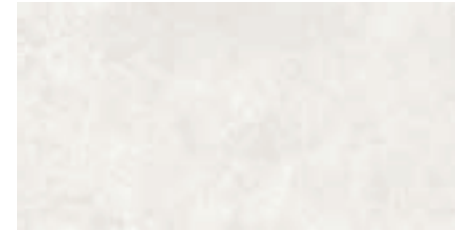

Cold / Soğuk



Warm / Sıcak



# Urbancrete



80x80 Grey / Gri

12 Faces / Yüzey görünümü (88x88)



80x80 Dark grey / Koyu gri

12 Faces / Yüzey görünümü (88x88)

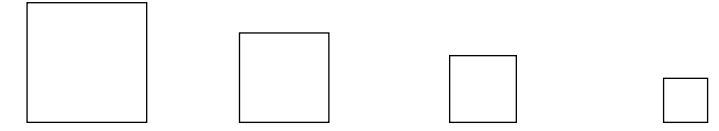

Colorbody porcelain Colorbody porselen	Surface Yüzey	Thickness Kalınlık	80x80 (32"x32") R 797x797	60x60 (24"x24") R 597x597	45x45 (18"x18") R 447x447	30x30 (12"x12") R 297x297
White Beyaz	R9 LPR	9 mm	K947182LPR01VTET	K947085LPR01VTE0		
	R10A	9 mm	K947182R0001VTET	K947085R0001VTE0	K94838900001VTE0	K950563R0001VTE0
	R11	20 mm		K950461R0001VTE1		
Grey Gri	R9 LPR	9 mm	K947083LPR01VTET	K947186LPR01VTE0		
	R10A	9 mm	K947083R0001VTET	K947186R0001VTE0	K94838700001VTE0	K950560R0001VTE0
	R11	20 mm		K950459R0001VTE1		
Dark grey Koyu gri	R9 LPR	9 mm	K947183LPR01VTET	K947086LPR01VTE0		
	R10A	9 mm	K947183R0001VTET	K947086R0001VTE0	K94838600001VTE0	K950561R0001VTE0
	R11	20 mm		K950462R0001VTE1		
Mink Vizon	R9 LPR	9 mm	K947084LPR01VTET	K947187LPR01VTE0		
	R10A	9 mm	K947084R0001VTET	K947187R0001VTE0	K94838800001VTE0	K950476R0001VTE0
	R11	20 mm		K950460R0001VTE1		
Dark greige Koyu grej	R9 LPR	9 mm	K947185LPR01VTET	K947089LPR01VTE0		
	R10A	9 mm	K947185R0001VTET	K947089R0001VTE0	K94838500001VTE0	K950559R0001VTE0
	R11	20 mm		K950464R0001VTE1		
Anthracite Antrasit	R9 LPR	9 mm	K948958LPR01VTET	K947087LPR01VTE0		
	R10A	9 mm	K948958R0001VTET	K947087R0001VTE0		K950562R0001VTE0
	R11	20 mm		K950463R0001VTE1		

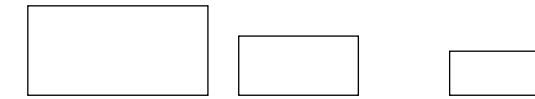

Colorbody porcelain Colorbody porselen	Surface Yüzey	Thickness Kalınlık	60x120 (24"x48") R 597x1197	40x80 (16"x32") R 397x797	30x60 (12"x24") R 297x597
White Beyaz	R9 LPR	9 mm		K947190LPR01VTET	K947237LPR01VTE0
	R10A	9 mm	K947465R0001VTSP	K947190R0001VTET	K947237R0001VTE0
Grey Gri	R9 LPR	9 mm		K947188LPR01VTET	K947235LPR01VTE0
	R10A	9 mm	K947468R0001VTSP	K947188R0001VTET	K947235R0001VTE0
Dark grey Koyu gri	R9 LPR	9 mm		K947191LPR01VTET	K947238LPR01VTE0
	R10A	9 mm	K947466R0001VTSP	K947191R0001VTET	K947238R0001VTE0
Mink Vizon	R9 LPR	9 mm		K947189LPR01VTET	K947236LPR01VTE0
	R10A	9 mm	K947469R0001VTSP	K947189R0001VTET	K947236R0001VTE0
Dark greige Koyu grej	R9 LPR	9 mm		K947193LPR01VTET	K947239LPR01VTE0
	R10A	9 mm	K947467R0001VTSP	K947193R0001VTET	K947239R0001VTE0
Anthracite Antrasit	R9 LPR	9 mm		K948959LPR01VTET	K948961LPR01VTE0
	R10A	9 mm	K948957R0001VTSP	K948959R0001VTET	K948961R0001VTE0



# Urbancrete



Brick cut decor /  
Tuğla kesme dekor



Cut decor /  
Kesme dekor

Decors Dekorlar	Surface Yüzey	Thickness Kalınlık	30x60 (12"x24") R 297x597	5x5 (2"x2") R 47x47
White Beyaz	Matt / Mat	9 mm	K9472468R001VTE0	
	R10B	9 mm		K9473768R001VTE0
Grey Gri	Matt / Mat	9 mm	K9472498R001VTE0	
	R10B	9 mm		K9473788R001VTE0
Dark grey Koyu gri	Matt / Mat	9 mm	K9472528R001VTE0	
	R10B	9 mm		K9473808R001VTE0
Mink Vizon	Matt / Mat	9 mm	K9472558R001VTE0	
	R10B	9 mm		K9473828R001VTE0
Dark greige Koyu grej	Matt / Mat	9 mm	K9472588R001VTE0	
	R10B	9 mm		K9473848R001VTE0
Anthracite Antrasit	Matt / Mat	9 mm	K948964R0001VTE0	
	R10B	9 mm		K9489728R001VTE0

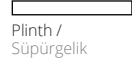

Plinth /  
Süpürgelik



Plinth /  
Süpürgelik



Plinth /  
Süpürgelik

Decors Dekorlar	Surface Yüzey	Thickness Kalınlık	10x80 (4"x32") R 97x797	8,5x60 (3,4"x24") R 82x597	8,5x45 (3,4"x18") R 82x447
White Beyaz	R10A	9 mm	K947387R0001VTET	K947392R0001VTE1	K95046600001VTE1
	R10A	9 mm	K947385R0001VTET	K947390R0001VTE1	K95047300001VTE1
Dark grey Koyu gri	R10A	9 mm	K947388R0001VTET	K947393R0001VTE1	K95046800001VTE1
	R10A	9 mm	K947386R0001VTET	K947391R0001VTE1	K95046900001VTE1
Dark greige Koyu grej	R10A	9 mm	K947389R0001VTET	K947394R0001VTE1	K95046700001VTE1
	R10A	9 mm	K948966R0001VTET	K948965R0001VTE1	



Wall tiles Duvar karoları	Surface Yüzey	Thickness Kalınlık	30x60 (12"x24") 298x298
Cold Soğuk	Matt / Mat	9 mm	K94744800001VTE0
	Matt / Mat	9 mm	K94744700001VTE0



Wall tiles / Duvar karoları :  
K947467R0001VTSP 60x120 Urbancrete Dark greige / Koyu grej  
Floor porcelain tiles / Yer porselen karoları :  
K947430R0001VTSP 60x120 Ceppostone Mink / Vizon

Sizes Ebatlar	Thickness Kalınlık (mm)	Box Kutu			Pallet Palet		
		Pcs Adet	m <sup>2</sup>	kg	Box Kutu	m <sup>2</sup>	kg
Colorbody porcelain / Colorbody porselen							
60x120 Rectified / Rektifiyeli	9	2	1,44	29,52	36	51,84	1.098
80x80 Rectified / Rektifiyeli	9	2	1,28	24,50	44	56,32	1.103
60x60 Rectified / Rektifiyeli	20	2	0,72	31,68	30	21,60	975
60x60 Rectified / Rektifiyeli	9	4	1,44	27,72	30	43,20	857
40x80 Rectified / Rektifiyeli	9	4	1,28	26,24	25	32,00	681
40x80 Rectified / Rektifiyeli	9	4	1,28	24,06	27	34,56	675
30x60 Rectified / Rektifiyeli	9	6	1,08	20,10	40	43,20	829
45x45 Rectified / Rektifiyeli	9	7	1,42	26,20	20	36,92	706
30x30 Rectified / Rektifiyeli	9	11	1,00	18,35	60	60,00	1.115
10x80 Plinth / Süpürgelik	9	9	0,72	13,68	40	28,80	550
8,5x60 Plinth / Süpürgelik	9	10	0,51	9,40	98	50,00	950
8,5x45 Plinth / Süpürgelik	9	10	0,38	7,08	140	53,6	1.016
5x5 Cut decor / Kesme dekor	9	8	0,72	12,24	78	56,16	980
Wall tiles / Duvar karoları							
30x60 Non-rectified / Rektifiyesiz	9	6	1,08	15,93	48	51,84	790



# Metalcrete

A porcelain collection that reinterprets the concrete through the fusion of metal. In the Metalcrete Collection, the large size and shine of metal sheets – basic to industrial design – add an attractive touch to the cool calm of porcelain. The collection offers iron and bronze colours in modular sizes to create a rich variety of tiling options and patterns.

Metali betonla yeniden yorumlayan porselen koleksiyonu. Metalcrete Koleksiyonunda endüstriyel tasarımın temel malzemesi metal levhalar, büyük boyutu ve ışıltısıyla porselenin sakinliğine göz alıcı bir dokunuş katıyor. Koleksiyon siyah, bronz, gümüş ve vizon renklerini modüler ebatlarla sunarak döşeme çeşitliliği sağlıyor.

## Compatible collections / Uyumlu koleksiyonlar

Ceppostone      Urbanwood  
Urban Travertino      miniworx  
Urbancrete



Wall tiles / Duvar karoları :  
K947534LPR01VTET 80x80 Metalcrete Iron / Demir



Wall tiles / Duvar karoları :  
K947533LPR01VTET 80x80 Metalcrete Copper / Bakır



# Metalcrete

Colorbody porcelain  
Colorbody porselen

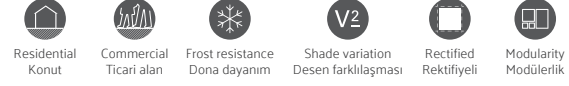

Product standard / Ürün standardı  
EN14411 Group Bla

Footnotes / Dip notlar  
F H R

## Base Tiles / Fonlar



Copper / Bakır



Silver grey / Gümüş gri



Iron / Demir

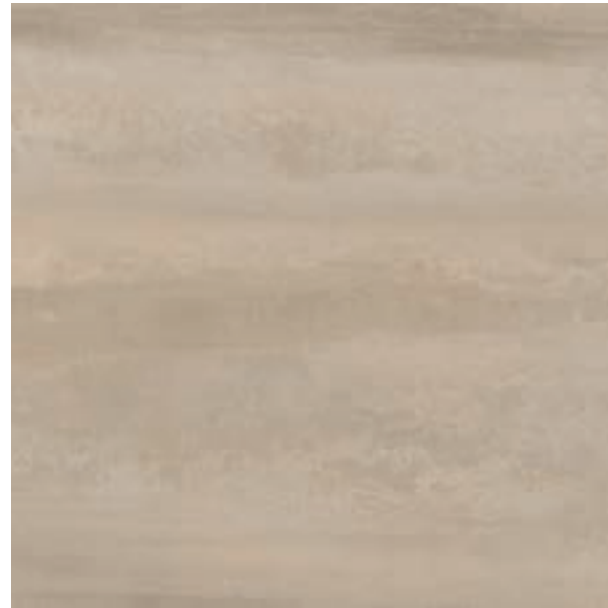

Mink / Vizon

## Decors / Dekorlar

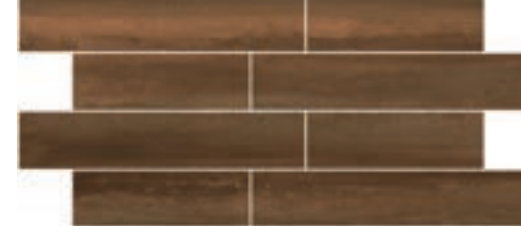

Cut decor / Kesme dekor  
Copper / Bakır

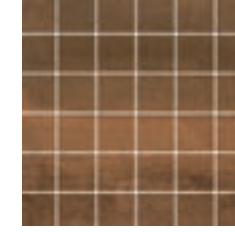

Cut mosaic decor / Kesme mozaik dekor  
Copper / Bakır

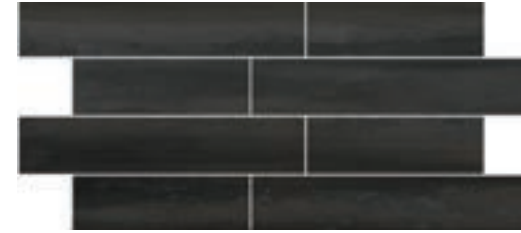

Cut decor / Kesme dekor  
Iron / Demir

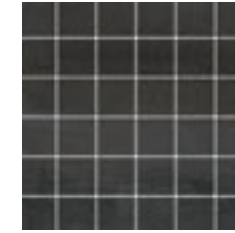

Cut mosaic decor / Kesme mozaik dekor  
Iron / Demir



Cut decor / Kesme dekor  
Silver grey / Gümüş gri

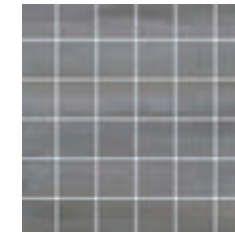

Cut mosaic decor / Kesme mozaik dekor  
Silver grey / Gümüş gri

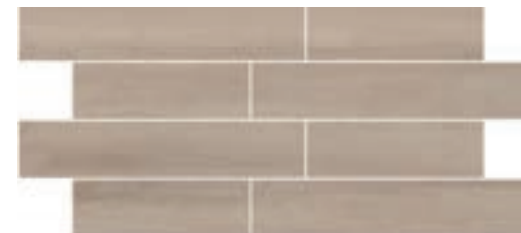

Cut decor / Kesme dekor  
Mink / Vizon



Cut mosaic decor / Kesme mozaik dekor  
Mink / Vizon



# Metalcrete



80x80 Copper / Bakır

300x100 1 Canvases / Kanvas (3 m<sup>2</sup>)



80x80 Iron / Demir

300x100 1 Canvases / Kanvas (3 m<sup>2</sup>)

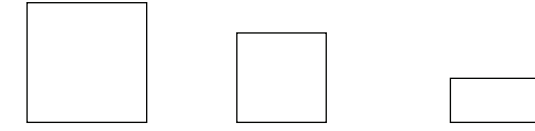

Colorbody porcelain Colorbody porselen	Surface Yüzey	Thickness Kalınlık	80x80 (32"x32") R 797x797	60x60 (24"x24") R 597x597	30x60 (12"x24") R 297x597
Copper Bakır	R9 LPR	9 mm	K947533LPR01VTET	K948876LPR01VTE0	K948942LPR01VTE0
Iron Demir	R9 LPR	9 mm	K947534LPR01VTET	K948877LPR01VTE0	K948943LPR01VTE0
Silver grey Gümüş gri	R9 LPR	9 mm	K947536LPR01VTET	K948874LPR01VTE0	K948940LPR01VTE0
Mink Vizon	R9 LPR	9 mm	K947535LPR01VTET	K948875LPR01VTE0	K948941LPR01VTE0



Cut decor /  
Kesme dekor



Cut mosaic decor /  
Kesme mozaik dekor

Decors Dekorlar	Surface Yüzey	Thickness Kalınlık	30x60 (12"x24") R 297x597	5x5 (2"x2") R 47x47
Copper Bakır	R9 LPR	9 mm	K9489468LPR1VTE0	K9489508LPR1VTE0
Iron Demir	R9 LPR	9 mm	K9489478LPR1VTE0	K9489518LPR1VTE0
Silver grey Gümüş gri	R9 LPR	9 mm	K9489448LPR1VTE0	K9489488LPR1VTE0
Mink Vizon	R9 LPR	9 mm	K9489458LPR1VTE0	K9489498LPR1VTE0

Sizes Ebatlar	Thickness Kalınlık (mm)	Box Kutu			Pallet Palet		
		Pcs Adet	m <sup>2</sup>	kg	Box Kutu	m <sup>2</sup>	kg
<b>Colorbody porcelain / Colorbody porselen</b>							
80x80 Rectified / Rektifiyeli	9	2	1,28	24,50	44	56,32	1.103
60x60 Rectified / Rektifiyeli	9	4	1,44	26,50	30	43,20	820
30x60 Rectified / Rektifiyeli	9	6	1,08	20,10	40	43,20	829
30x60 Cut decor / Kesme dekor	9	4	0,72	13,54	30	21,60	431
5x5 Cut decor / Kesme dekor	9	8	0,72	12,24	78	56,16	980



# Ultra 2.0

A ceramic series adding bright reflections to the cement looking stone texture which is highly popular recently. Ultra 2.0 helps to create privileged spaces and blows a new life into modern urban residences with its glossy surface alternative.

Son yılların en çok tercih edilen çimento görünümlü taş dokusunu, parlak yansımalarıyla devam ettiren seramik serisi. Ultra 2.0, mekânlara ayrıcalıklı bir hava katıyor ve ışıklı yüzey alternatifleriyle modern şehir evlerine yepyeni bir soluk getiriyor.

## Compatible collections / Uyumlu koleksiyonlar

Stonelevel mode #02  
Metalcrete mode #04  
Urbancrete



Wall tiles / Duvar karoları :  
K947618R0001VTE0 30x60 Ultra 2.0 Cream / Krem  
Floor porcelain tiles / Yer porselen karoları :  
K947664R0001VTE0 60x60 Ultra 2.0 Mink / Vizon



Wall tiles / Duvar karoları :  
K947656R0001VTE0 60x60 Ultra 2.0 Silver grey / Gümüş gri  
Floor porcelain tiles / Yer porselen karoları :  
K947656R0001VTE0 60x60 Ultra 2.0 Silver grey / Gümüş gri



# Ultra 2.0

Colorbody porcelain  
Colorbody porselen



**Product standard / Ürün standardı**  
EN14411 Group Bla

**Footnotes / Dip notlar**  
K R

## Base Tiles / Fonlar

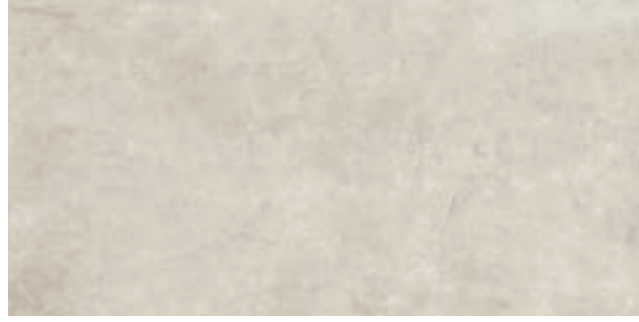

White / Beyaz

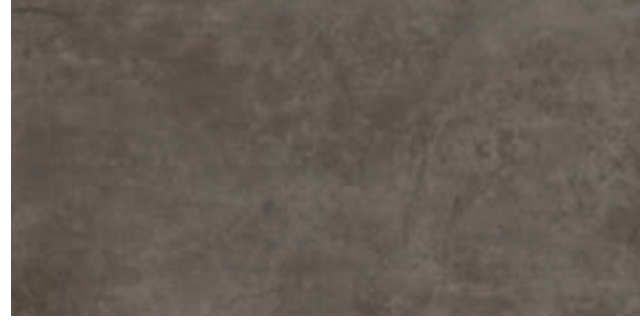

Mocha / Moka



Cream / Krem



Silver grey / Gümüş gri



Beige / Bej



Anthracite / Antrasit

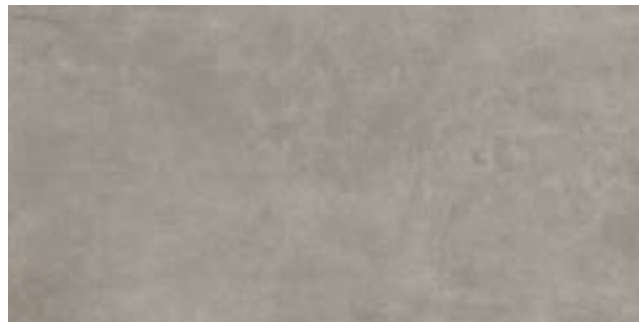

Mink / Vizon

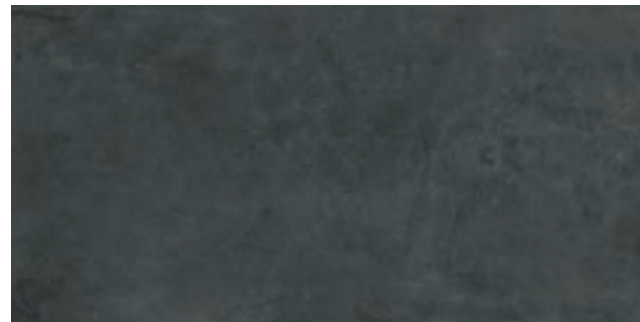

Black / Siyah



60x60 White / Beyaz

2 Canvases / Kanvas (144x90)



60x60 Anthracite / Antrasit

2 Canvases / Kanvas (144x90)



# Ultra 2.0



Colorbody porcelain Colorbody porselen	Surface Yüzey	Thickness Kalınlık	60x120 (24"x48") R 597x1197	60x60 (24"x24") R 597x597	45x45 (18"x18") 442x442	30x60 (12"x24") R 297x597
White Beyaz	R9 LPR	9 mm	K947638LPR01VTSP	K947654LPR01VTE0		K947614LPR01VTE0
	R9 FM	9 mm	K947639R0001VTSP	K947655R0001VTE0	K94762800001VTE0	K947615R0001VTE0
	R10A	9 mm	K947638R0001VTSP	K947654R0001VTE0		K947614R0001VTE0
	R10B	9 mm		K950004R0001VTE0		K950011R0001VTE0
Cream Krem	R9 LPR	9 mm	K947642LPR01VTSP	K947658LPR01VTE0		K947618LPR01VTE0
	R9 FM	9 mm	K947643R0001VTSP	K947659R0001VTE0	K94763000001VTE0	K947619R0001VTE0
	R10A	9 mm	K947642R0001VTSP	K947658R0001VTE0		K947618R0001VTE0
	R10B	9 mm		K950005R0001VTE0		K950013R0001VTE0
Beige Bej	R11	20 mm		K950205R0001VTE1		
	R9 LPR	9 mm	K947636LPR01VTSP	K947652LPR01VTE0		K947612LPR01VTE0
	R9 FM	9 mm	K947637R0001VTSP	K947653R0001VTE0	K94762700001VTE0	K947613R0001VTE0
	R10A	9 mm	K947636R0001VTSP	K947652R0001VTE0		K947612R0001VTE0
Mink Vizon	R10B	9 mm		K950003R0001VTE0		K950010R0001VTE0
	R9 LPR	9 mm	K947648LPR01VTSP	K947664LPR01VTE0		K947624LPR01VTE0
	R9 FM	9 mm	K947649R0001VTSP	K947665R0001VTE0	K94763300001VTE0	K947625R0001VTE0
	R10A	9 mm	K947648R0001VTSP	K947664R0001VTE0		K947624R0001VTE0
Mocha Moka	R10B	9 mm		K950008R0001VTE0		K950016R0001VTE0
	R11	20 mm		K950206R0001VTE1		
	R9 LPR	9 mm	K947644LPR01VTSP	K947660LPR01VTE0		K947620LPR01VTE0
	R9 FM	9 mm	K947645R0001VTSP	K947661R0001VTE0	K94763100001VTE0	K947621R0001VTE0
Silver grey Gümüş gri	R10A	9 mm	K947644R0001VTSP	K947660R0001VTE0		K947620R0001VTE0
	R10B	9 mm		K950006R0001VTE0		K950014R0001VTE0
	R9 LPR	9 mm	K947640LPR01VTSP	K947656LPR01VTE0		K947616LPR01VTE0
	R9 FM	9 mm	K947641R0001VTSP	K947657R0001VTE0	K94762900001VTE0	K947617R0001VTE0
Anthracite Antrasit	R10A	9 mm	K947640R0001VTSP	K947656R0001VTE0		K947616R0001VTE0
	R10B	9 mm		K950017R0001VTE0		K950012R0001VTE0
	R11	20 mm		K950207R0001VTE1		
	R9 LPR	9 mm	K947634LPR01VTSP	K947650LPR01VTE0		K947610LPR01VTE0
Black Siyah	R9 FM	9 mm	K947635R0001VTSP	K947651R0001VTE0	K94762600001VTE0	K947611R0001VTE0
	R10A	9 mm	K947634R0001VTSP	K947650R0001VTE0		K947610R0001VTE0
	R10B	9 mm		K950002R0001VTE0		K950009R0001VTE0
	R11	20 mm		K950208R0001VTE1		
Black Siyah	R9 LPR	9 mm	K947646LPR01VTSP	K947662LPR01VTE0		K947622LPR01VTE0
	R9 FM	9 mm	K947647R0001VTSP	K947663R0001VTE0	K94763200001VTE0	K947623R0001VTE0
	R10A	9 mm	K947646R0001VTSP	K947662R0001VTE0		K947622R0001VTE0
	R10B	9 mm		K950007R0001VTE0		K950015R0001VTE0

Decors Dekorlar	Surface Yüzey	Thickness Kalınlık	8,5x60 (3,4"x24") R 82x597	8,5x45 (3,4"x18") R 82x447
White Beyaz	R9 LPR	9 mm	K947678LPR01VTE1	
	R9 FM	9 mm	K947679R0001VTE1	K94766800001VTE1
	R10A	9 mm	K947678R0001VTE1	
Cream Krem	R9 LPR	9 mm	K947682LPR01VTE1	
	R9 FM	9 mm	K947683R0001VTE1	K94767000001VTE1
	R10A	9 mm	K947682R0001VTE1	
Beige Bej	R9 LPR	9 mm	K947676LPR01VTE1	
	R9 FM	9 mm	K947677R0001VTE1	K94766700001VTE1
	R10A	9 mm	K947676R0001VTE1	
Mink Vizon	R9 LPR	9 mm	K947688LPR01VTE1	
	R9 FM	9 mm	K947689R0001VTE1	K94767300001VTE1
	R10A	9 mm	K947688R0001VTE1	
Mocha Moka	R9 LPR	9 mm	K947684LPR01VTE1	
	R9 FM	9 mm	K947685R0001VTE1	K94767100001VTE1
	R10A	9 mm	K947684R0001VTE1	
Silver grey Gümüş gri	R9 LPR	9 mm	K947680LPR01VTE1	
	R9 FM	9 mm	K947681R0001VTE1	K94766900001VTE1
	R10A	9 mm	K947680R0001VTE1	
Anthracite Antrasit	R9 LPR	9 mm	K947674LPR01VTE1	
	R9 FM	9 mm	K947675R0001VTE1	K94766600001VTE1
	R10A	9 mm	K947674R0001VTE1	
Black Siyah	R9 LPR	9 mm	K947686LPR01VTE1	
	R9 FM	9 mm	K947687R0001VTE1	K94767200001VTE1
	R10A	9 mm	K947686R0001VTE1	

Sizes Ebatlar	Thickness Kalınlık (mm)	Box Kutu			Pallet Palet		
		Pcs Adet	m <sup>2</sup>	kg	Box Kutu	m <sup>2</sup>	kg
Colorbody porcelain / Colorbody porselen							
60x120 Rectified / Rektifiyeli	9	2	1,44	29,52	36	51,84	1.098
60x60 Rectified / Rektifiyeli	20	2	0,72	31,68	30	21,60	975
60x60 Rectified / Rektifiyeli	9	4	1,44	26,90	30	43,20	832
30x60 Rectified / Rektifiyeli	9	6	1,08	20,13	40	43,20	830
45x45 Non-rectified / Rektifiyesiz	9	7	1,42	26,20	26	36,92	706
8,5x45 Plinth / Süpürgelik	9	10	0,38	7,08	140	53,60	1.016
8,5x60 Plinth / Süpürgelik	9	10	0,51	9,40	98	50,00	950



# Ash & Burn

A ceramic series which offers a warm new interpretation of industrial concrete look with sophisticated colour tones and attractive textures. The collection warms the timeless simplicity of concrete with natural warm colour shades, hexagonal tile options, brick sizes that can be used on the walls and small square decors.

Sofistike renk tonları ve etkileyici dokusu ile endüstriyel beton görünümüne sınırsız bir yeni yorum kazandıran seramik serisi. Betonun zamana karşı duran sadeliğini doğanın sıcak tonlarıyla ısıtan koleksiyonda; altıgen karo seçenekleri, duvarda da kullanılabilen tuğla ebat ve küçük kare dekorlar yer alıyor.

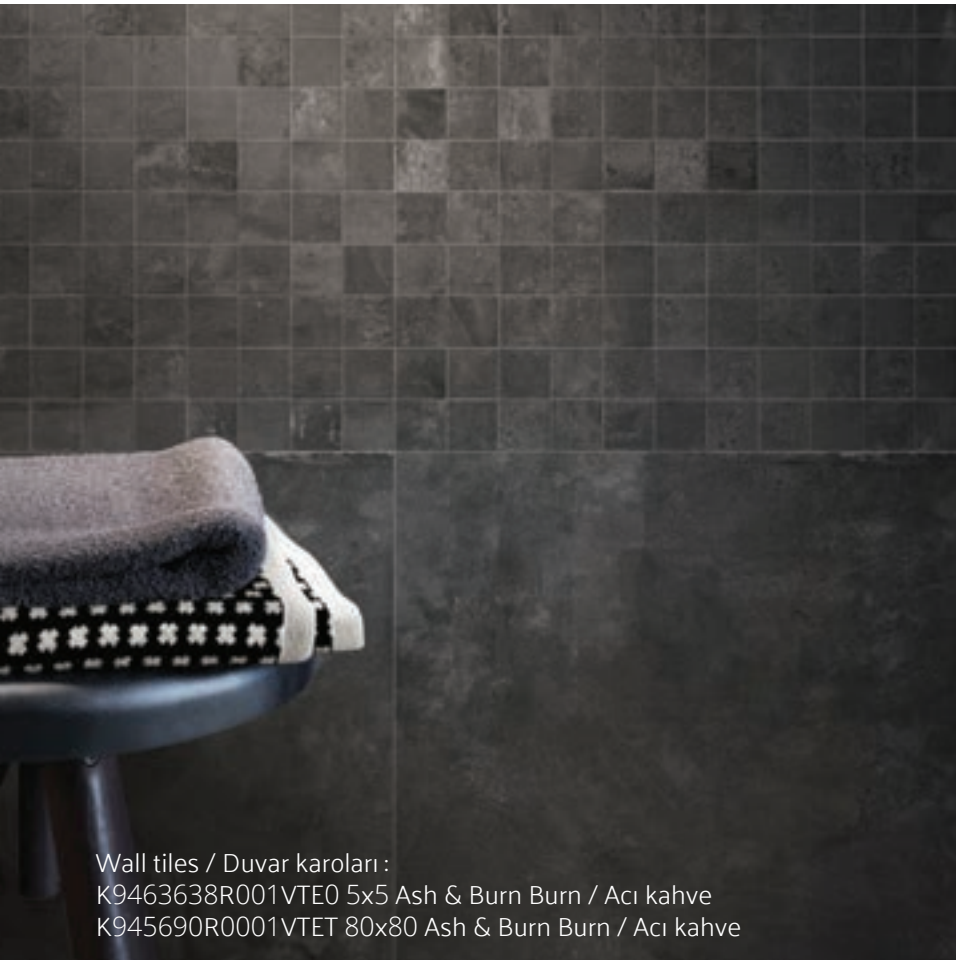

Wall tiles / Duvar karoları :  
K9463638R001VTE0 5x5 Ash & Burn Burn / Acı kahve  
K945690R0001VTET 80x80 Ash & Burn Burn / Acı kahve



Wall tiles / Duvar karoları :  
K945678R0001VTE0 30x60 Ash & Burn Ash / Kemik  
Floor porcelain tiles / Yer porselen karoları :  
K945690R0001VTET 80x80 Ash & Burn Burn / Acı kahve



# Ash & Burn

Colorbody porcelain  
Colorbody porselen

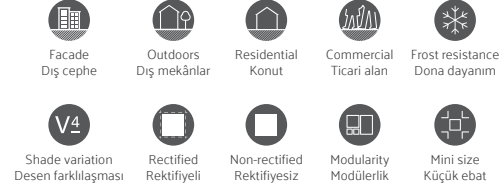

**Product standard / Ürün standardı**  
EN14411 Group Bla

**Footnotes / Dip notlar**  
F H R

## Base Tiles / Fonlar



Ash / Kemik



Burn / Acı kahve

## Decors / Dekorlar

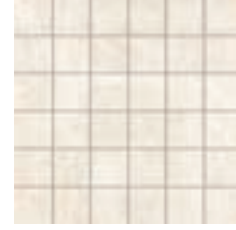

Cut mosaic decor / Kesme mozaik dekor  
Ash / Kemik



Cut mosaic decor / Kesme mozaik dekor  
Burn / Acı kahve



Plinth / Süpügelik  
Ash / Kemik

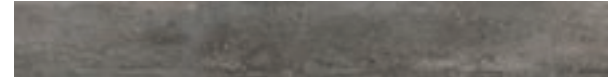

Plinth / Süpügelik  
Burn / Acı kahve



# Ash & Burn



80x80 Ash / Kemik

14 Faces / Yüzey görünümü (88x88)



80x80 Burn / Acı kahve

14 Faces / Yüzey görünümü (88x88)

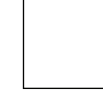

Colorbody porcelain Colorbody porselen	Surface Yüzey	Thickness Kalınlık	80x80 (32"x32") R 797x797	60x60 (24"x24") R 597x597
Ash Kemik	R9	9 mm	K945689R0001VTET	K945684R0001VTE0
Burn Acı kahve	R9	9 mm	K945690R0001VTET	K945683R0001VTE0

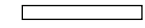

Colorbody porcelain Colorbody porselen	Surface Yüzey	Thickness Kalınlık	40x80 (16"x32") R 397x797	30x60 (12"x24") 298x598	10x80 (4"x32") R 97x797
Ash Kemik	R9	9 mm	K945680R0001VTET	K945678R0001VTE0	K946053R0001VTET
Burn Acı kahve	R9	9 mm	K945679R0001VTET	K945677R0001VTE0	K946054R0001VTET



Cut mosaic decor /  
Kesme mozaik dekor

Decors Dekorlar	Surface Yüzey	Thickness Kalınlık	10x80 (4"x32") R 97x797	8,5x60 (3,4"x24") R 82x597	5x5 (2"x2") R 47x47
Ash Kemik	R9	9 mm	K945676R0001VTET	K945687R0001VTE1	
	R10B	9 mm	K946053R0001VTET		K9463628R001VTE0
Burn Acı kahve	R9	9 mm	K945675R0001VTET	K945688R0001VTE1	
	R10B	9 mm			K9463638R001VTE0

Sizes Ebatlar	Thickness Kalınlık (mm)	Box Kutu			Pallet Palet		
		Pcs Adet	m <sup>2</sup>	kg	Box Kutu	m <sup>2</sup>	kg
<b>Colorbody porcelain / Colorbody porselen</b>							
80x80 Rectified / Rektifiyeli	9	2	1,28	24,50	44	56,32	1.103
40x80 Rectified / Rektifiyeli	9	4	1,28	24,06	27	34,56	675
60x60 Rectified / Rektifiyeli	9	4	1,44	26,90	30	43,20	832
30x60 Rectified / Rektifiyeli	9	6	1,08	20,10	40	43,20	829
10x80 Plinth / Süpürgelik	9	9	0,72	13,68	75	54,00	1.051
8,5x60 Plinth / Süpürgelik	9	10	0,51	9,40	98	50,00	950
5x5 Cut decor / Kesme dekor	9	8	0,72	12,24	78	56,16	980



# Newcon

A concrete textured ceramic series which creates stylish and functional spaces with its cool surface texture and natural colour tones. The collection offers integrated solutions for residential and commercial buildings with compatible colour alternatives, modular dimensions and 60x120 porcelain sizes for exterior cladding applications.

Sakin yüzey dokusu ve doğal renk tonlarıyla şık ve fonksiyonel mekânlar yaratabilen beton görünümlü seramik serisi. Koleksiyon, birbiriyle uyumlu renk alternatifleri, modüler ebatları ve dış cephe için de kullanılacak 60x120 porselenleri ile konutlar ve ticari yapılar için bütünsel çözümler sunuyor.



Wall tiles / Duvar karoları :  
K945786LPR01VTE0 60x60 Newcon White / Beyaz  
K945754LPR01VTE0 30x60 Newcon White / Beyaz



Wall tiles / Duvar karoları :  
K945772LPR01VTSP 60x120 Newcon Dark grey / Koyu gri  
Floor porcelain tiles / Yer porselen karoları :  
K945785R0001VTE0 60x60 Newcon Silver grey / Gümüş gri



# Newcon

Colorbody porcelain  
Colorbody porselen



**Product standard / Ürün standardı**  
EN14411 Group Bla

**Footnotes / Dip notlar**  
F H R S

## Base Tiles / Fonlar

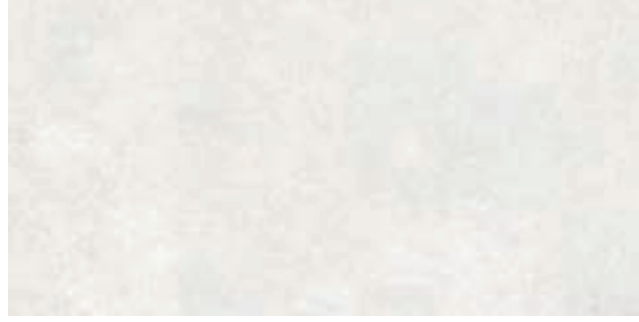

White / Beyaz

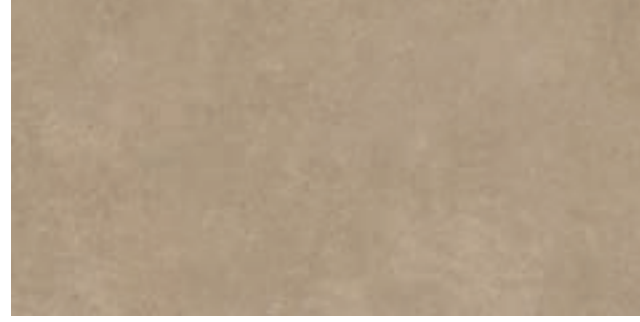

Taupe / Taupe

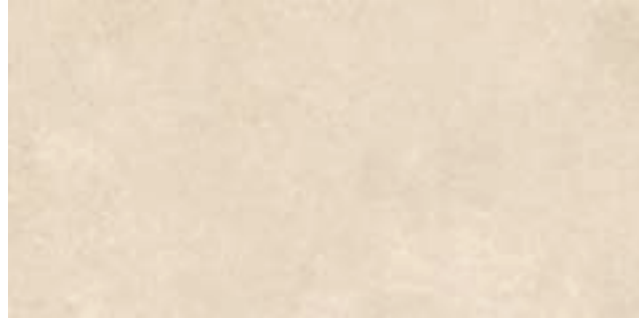

Cream / Krem



Dark grey / Koyu gri



Silver grey / Gümüş gri

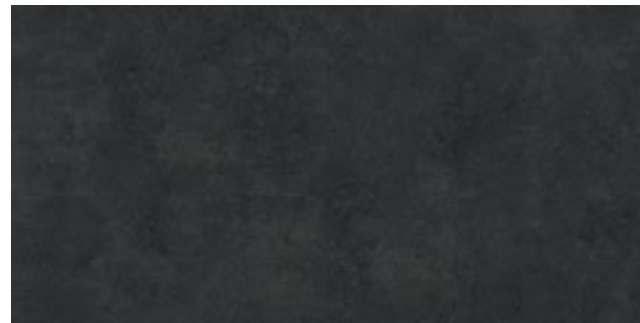

Anthracite / Antrasit

## Decors / Dekorlar



Pressed mosaic decor / Kalıptan mozaik dekor  
White / Beyaz



Cut mosaic decor / Kesme mozaik dekor  
White / Beyaz



Combi decor / Kombi dekor  
White / Beyaz



Tread / Basamak  
White / Beyaz

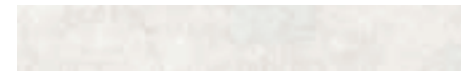

Plinth / Süpürgelik  
White / Beyaz



# Newcon

Glazed porcelain  
Sırlı porselen



**Product standard / Ürün standardı**  
EN14411 Group Bla

**Footnotes / Dip notlar**  
F H R S

## Base Tiles / Fonlar

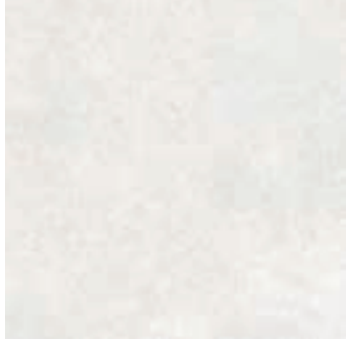

White / Beyaz

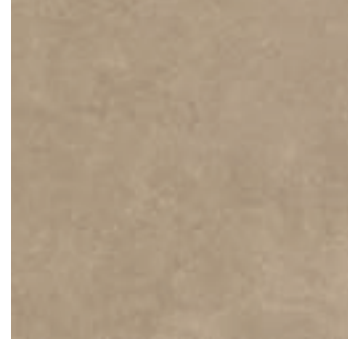

Taupe / Taupe



Cream / Krem



Dark grey / Koyu gri



Silver grey / Gümüş gri

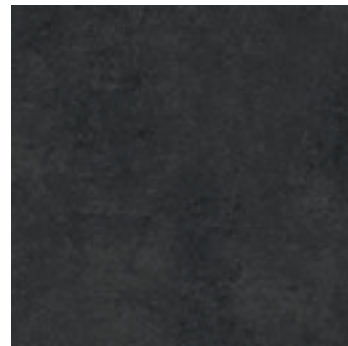

Anthracite / Antrasit



Floor porcelain tiles / Yer porselen karoları :  
K945783LPR01VTE0 60x60 Newcon Dark grey / Koyu gri



# Newcon



60x60 White / Beyaz

265x68 1 Canvases / Kanvas (1,80 m<sup>2</sup>)



60x60 Dark grey / Koyu gri

265x68 1 Canvases / Kanvas (1,80 m<sup>2</sup>)

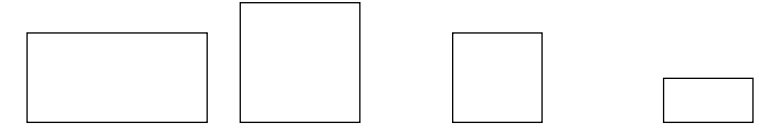

Colorbody porcelain Colorbody porselen	Surface Yüzey	Thickness Kalınlık	60x120 (24"x48") R 597x1197	80x80 (32"x32") R 797x797	60x60 (24"x24") R 597x597	30x60 (12"x24") R 297x597
White Beyaz	R9 LPR	9 mm	K945773LPR01VTSP	K946177LPR01VTET	K945786LPR01VTE0	K945754LPR01VTE0
	R10A	9 mm	K945773R0001VTSP	K946177R0001VTET	K945786R0001VTE0	K945754R0001VTE0
	R11B	9 mm			K945790R0001VTE0	K946171R0001VTE0
Cream Krem	R9 LPR	9 mm	K945775LPR01VTSP	K946173LPR01VTET	K945781LPR01VTE0	K945746LPR01VTE0
	R10A	9 mm	K945775R0001VTSP	K946173R0001VTET	K945781R0001VTE0	K945746R0001VTE0
	R11B	9 mm			K945782R0001VTE0	K946167R0001VTE0
Silver grey Gümüş gri	R9 LPR	9 mm	K945778LPR01VTSP	K946175LPR01VTET	K945785LPR01VTE0	K945752LPR01VTE0
	R10A	9 mm	K945778R0001VTSP	K946175R0001VTET	K945785R0001VTE0	K945752R0001VTE0
	R11B	9 mm			K945789R0001VTE0	K946169R0001VTE0
Taupe Taupe	R9 LPR	9 mm	K945774LPR01VTSP	K946176LPR01VTET	K945784LPR01VTE0	K945753LPR01VTE0
	R10A	9 mm	K945774R0001VTSP	K946176R0001VTET	K945784R0001VTE0	K945753R0001VTE0
	R11B	9 mm			K945788R0001VTE0	K946170R0001VTE0
Dark grey Koyu gri	R9 LPR	9 mm	K945772LPR01VTSP	K946174LPR01VTET	K945783LPR01VTE0	K945751LPR01VTE0
	R10A	9 mm	K945772R0001VTSP	K946174R0001VTET	K945783R0001VTE0	K945751R0001VTE0
	R11B	9 mm			K945787R0001VTE0	K946168R0001VTE0
Anthracite Antrasit	R9 LPR	9 mm	K945776LPR01VTSP	K946172LPR01VTET	K945779LPR01VTE0	K945745LPR01VTE0
	R10A	9 mm	K945776R0001VTSP	K946172R0001VTET	K945779R0001VTE0	K945745R0001VTE0
	R11B	9 mm			K945780R0001VTE0	K946166R0001VTE0



Glazed porcelain Sırlı porselen	Surface Yüzey	Thickness Kalınlık	45x45 (18"x18") 447x447	30x30 (12"x12") 297x297
White Beyaz	Matt / Mat	9 mm	K94576500001VTE0	
	R10A	7 mm	K94645600001VTE0	
Cream Krem	Matt / Mat	9 mm	K94576600001VTE0	
	R10A	7 mm	K94645700001VTE0	
Silver grey Gümüş gri	Matt / Mat	9 mm	K94576300001VTE0	
	R10A	7 mm	K94645400001VTE0	
Taupe Taupe	Matt / Mat	9 mm	K94576200001VTE0	
	R10A	7 mm	K94645300001VTE0	
Dark grey Koyu gri	Matt / Mat	9 mm	K94576100001VTE0	
	R10A	7 mm	K94645200001VTE0	
Anthracite Antrasit	Matt / Mat	9 mm	K94576400001VTE0	
	R10A	7 mm	K94645500001VTE0	



# Newcon



Decors Dekorlar	Surface Yüzeý	Thickness Kalınlık	30x120 (12"x48") R 397x1197	30x60 (12"x24") R 297x597	30x60 (12"x24") R 297x597	5x5 (2"x2") R 47x47
White Beyaz	R9 LPR	9 mm		K9464628LPR1VTE0		K9457718LPR1VTE0
	R10A	9 mm	K946505R0001VTET		K946189R0001VTE0	
	R10B	9 mm		K9464628R001VTE0		K9494028R001VTE0
Cream Krem	R9 LPR	9 mm		K9464638LPR1VTE0		K9457678LPR1VTE0
	R10A	9 mm	K946501R0001VTET		K946185R0001VTE0	
	R10B	9 mm		K9464638R001VTE0		K9494008R001VTE0
Silver grey Gümüş gri	R9 LPR	9 mm		K9464608LPR1VTE0		K9457698LPR1VTE0
	R10A	9 mm	K946503R0001VTET		K946187GR001VTE0	
	R10B	9 mm		K946187R0001VTE0		K9493998R001VTE0
Taupe Taupe	R9 LPR	9 mm		K9464598LPR1VTE0		K9457708LPR1VTE0
	R10A	9 mm	K946504R0001VTET		K946188R0001VTE0	
	R10B	9 mm		K9464598R001VTE0		K9494018R001VTE0
Dark grey Koyu gri	R9 LPR	9 mm		K9464588LPR1VTE0		K9457688LPR1VTE0
	R10A	9 mm	K946502R0001VTET		K946186R0001VTE0	
	R10B	9 mm		K9464588R001VTE0		K9457688R001VTE0
Anthracite Antrasit	R9 LPR	9 mm		K9464618LPR1VTE0		K9457668LPR1VTE0
	R10A	9 mm	K946500R0001VTET		K946184R0001VTE0	
	R10B	9 mm		K9464618R001VTE0		K9457668R001VTE0



Wall tiles / Duvar karoları :  
 K945790R0001VTE0 60x60 Newcon White / Beyaz  
 K947185R0001VTET 80x80 Urbancrete Dark greige / Koyu grej  
 Floor porcelain tiles / Yer porselen karoları :  
 K945782R0001VTE0 60x60 Newcon Cream / Krem



Decors Dekorlar	Surface Yüzeý	Thickness Kalınlık	10x80 (4"x32") R 97x797	8,5x60 (3,4"x24") R 82x597	8,5x45 (3,4"x18") R 82x447
White Beyaz	R10A	9 mm	K946183R0001VTET	K945750R0001VTE1	
	Matt / Mat	9 mm			K94579600001VTE1
Cream Krem	R10A	9 mm	K946179R0001VTET	K945749R0001VTE1	
	Matt / Mat	9 mm			K94579500001VTE1
Silver grey Gümüş gri	R10A	9 mm	K946181R0001VTET	K945743R0001VTE1	
	Matt / Mat	9 mm			K94579300001VTE1
Taupe Taupe	R10A	9 mm	K946182R0001VTET	K945744R0001VTE1	
	Matt / Mat	9 mm			K94579200001VTE1
Dark grey Koyu gri	R10A	9 mm	K946180R0001VTET	K945742R0001VTE1	
	Matt / Mat	9 mm			K94579100001VTE1
Anthracite Antrasit	R10A	9 mm	K946178R0001VTET	K945741R0001VTE1	
	Matt / Mat	9 mm			K94579400001VTE1

Sizes Ebatlar	Thickness Kalınlık (mm)	Box Kutu			Pallet Palet		
		Pcs Adet	m²	kg	Box Kutu	m²	kg
<b>Colorbody porcelain / Colorbody porselen</b>							
60x120 Rectified / Rektifiyeli	9	2	1,44	29,52	36	51,84	1.098
80x80 Rectified / Rektifiyeli	9	2	1,28	24,50	44	56,32	1.103
60x60 Rectified / Rektifiyeli	9	4	1,44	28,37	30	43,20	876
30x60 Rectified / Rektifiyeli	9	6	1,08	21,17	40	43,20	872
30x60 Combi decor / Kombi dekor	9	4	0,72	12,49	30	21,6	400
30x60 Combi decor / Kombi dekor	9	4	0,72	15,12	30	21,6	479
30x120 Tread / Basamak	9	3	1,08	22,30			
30x60 Tread / Basamak	9	6	1,08	21,00			
10x80 Plinth / Süpürgelik	9	9	0,72	13,68			
8,5x60 Plinth / Süpürgelik	9	10	0,51	9,40	98	50,00	950
5x5 Cut decor / Kesme dekor	9	8	0,72	12,24	78	56,16	980
<b>Glazed porcelain / Sırlı porselen</b>							
45x45 Non-rectified / Rektifiyesiz	9	7	1,42	26,20	26	36,92	706
30x30 Non-rectified / Rektifiyesiz	7	11	1,00	14,40	72	72,00	1.062
8,5x45 Plinth / Süpürgelik	9	10	0,38	7,08	140	53,60	1.016
<b>Floor tile / Yer karosu</b>							
5x5 Cut decor / Kesme dekor	6	11	1,00	11,70	78	78,00	938



# Ice & Smoke

A porcelain ceramic collection based predominantly on basic construction materials. Named after ice and smoke hues, Ice & Smoke comes in several size options to create spaces with its natural outlook and geometrical decors.

Temel yapı malzemelerinin baskın olarak kullanıldığı porselen seramik serisi. Seriyeye ismini veren buz ve duman renkleri, doğal görünümlü dokusu ve geometrik dekorlarıyla ferah bir mekân yaratmaya olanak sağlayan Ice & Smoke, çeşitli ebat alternatifleri de sunuyor.



Wall tiles / Duvar karoları :  
K937065R0001VTET 40x80 Ice & Smoke Smoke grey / Duman gri



Wall tiles / Duvar karoları :  
K937054R0001VTET 80x80 Ice & Smoke Ice grey / Buz gri  
K937076R0001VTET 40x80 Ice & Smoke Ice grey / Buz gri  
K937124R0001VTET 40x80 Ice & Smoke Geometric mix decor / Geometrik mix dekor  
Floor porcelain tiles / Yer porselen karoları :  
K937054R0001VTET 80x80 Ice & Smoke Ice grey / Buz gri



# Ice & Smoke

Colorbody porcelain  
Colorbody porselen



**Product standard / Ürün standardı**  
EN14411 Group B

**Footnotes / Dip notlar**  
H R

## Base Tiles / Fonlar



Ice grey / Buz gri



Smoke grey / Duman gri

## Decors / Dekorlar



Geometric mix decor / Geometrik mix dekor



Tread / Basamak  
Ice grey / Buz gri



Tread / Basamak  
Smoke grey / Duman gri



Plinth / Süpürgelik  
Ice grey / Buz gri



Plinth / Süpürgelik  
Smoke grey / Duman gri



# Ice & Smoke



80x80 Ice grey / Buz gri

16 Faces / Yüzey görünümü (88x88)



80x80 Smoke grey / Duman gri

16 Faces / Yüzey görünümü (88x88)

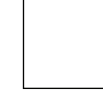

Colorbody porcelain Colorbody porselen	Surface Yüzey	Thickness Kalınlık	80x80 (32"x32") R 797x797	60x60 (24"x24") R 597x597
Ice grey Buz gri	R9	9 mm	K937054R0001VTET	K937651R0001VTE0
Smoke grey Duman gri	R9	9 mm	K937043R0001VTET	K937640R0001VTE0



Colorbody porcelain Colorbody porselen	Surface Yüzey	Thickness Kalınlık	40x80 (16"x32") R 397x797	30x60 (12"x24") R 297x597	10x80 (4"x32") R 97x797
Ice grey Buz gri	R9	9 mm	K937076R0001VTET	K946313R0001VTE0	K937496R0001VTET
Smoke grey Duman gri	R9	9 mm	K937065R0001VTET	K946312R0001VTE0	K937485R0001VTET

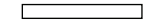

Decors Dekorlar	Surface Yüzey	Thickness Kalınlık	40x80 (16"x32") R 397x797	40x80 (16"x32") R 397x797	10x80 (4"x32") R 97x797
Ice grey Buz gri	R9	9 mm		K944365R0001VTET	K943516R0001VTET
Smoke grey Duman gri	R9	9 mm			K943520R0001VTET
Mix Mix	R9	9 mm	K937124R0001VTET		

Geometric mix decor /  
Geometrik mix dekor

Tread /  
Basamak

Plinth /  
Süpürgelik

Sizes Ebatlar	Thickness Kalınlık (mm)	Box Kutu			Pallet Palet		
		Pcs Adet	m <sup>2</sup>	kg	Box Kutu	m <sup>2</sup>	kg
Colorbody porcelain / Colorbody porselen							
80x80 Rectified / Rektifiyeli	9	2	1,28	24,50	44	56,32	1.103
60x60 Rectified / Rektifiyeli	9	4	1,44	26,86	30	43,20	831
40x80 Rectified / Rektifiyeli	9	4	1,28	24,06	27	34,56	675
30x60 Rectified / Rektifiyeli	9	6	1,08	20,09	40	43,20	829
10x80 Rectified / Rektifiyeli	9	9	0,72	13,68	75	54,00	1.051
40x80 Tread / Basamak	9						
40x80 Decor / Dekor	9	4	1,28	24,06	27	34,56	675
10x80 Plinth / Süpürgelik	9	9	0,72	13,68			



# Metro

A ceramic series bringing a sense of tranquilly to spaces. The concrete texture Metro Porcelain tiles offer a wide range of colour, surface and size options to architects for the creation of modern buildings.

Stil sahibi bir dinamizmle çarpıcı tasarımlar yaratma imkânı sunan seramik serisi. Ebat, renk ve yüzey zenginliğiyle Metro Serisi, modern atmosferler tasarlamak için mükemmel bir seçim.



Wall tiles / Duvar karoları :  
K944689R0001VTS1 45x90 Metro Light grey / Açık gri  
K9463948R001VTE0 1,5x15 Metro Cut border, grey / Kesme bordür, gri  
Floor porcelain tiles / Yer porselen karoları :  
K943308R0001VTE0 60x60 Metro Anthracite / Antrasit



Wall tiles / Duvar karoları :  
K943326R0001VTE0 30x60 Metro Beige / Bej  
K943328R0001VTE0 30x60 Metro Brown / Kahve  
Floor porcelain tiles / Yer porselen karoları :  
K943326R0001VTE0 30x60 Metro Beige / Bej



# Metro

Colorbody porcelain  
Colorbody porselen



Product standard / Ürün standardı  
EN14411 Group Bla

Footnotes / Dip notlar  
H R

## Base Tiles / Fonlar



Beige / Bej



Grey / Gri



Schlamm / Açık kahve



Basalt / Bazalt



Brown / Kahve

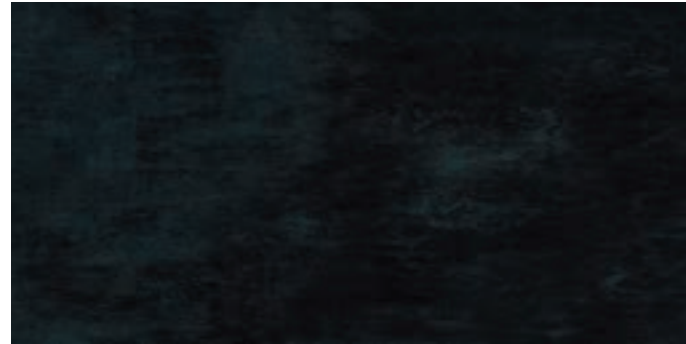

Anthracite / Antrasit



Light grey / Açık gri

## Decors / Dekorlar

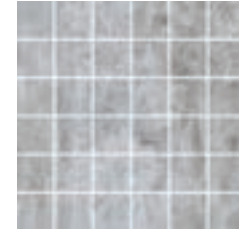

Cut decor / Kesme dekor  
Grey / Gri



Cut border / Kesme bordür  
Grey / Gri



Mix 1 cut mosaic decor /  
Mix 1 kesme mozaik dekor



Mix 2 mosaic decor /  
Mix 2 mozaik dekor



Plinth / Süpügelik  
Light grey / Açık gri



# Metro

Glazed porcelain  
Sırlı porselen



**Product standard / Ürün standardı**  
EN14411 Group BII

**Footnotes / Dip notlar**  
H R

## Base Tiles / Fonlar

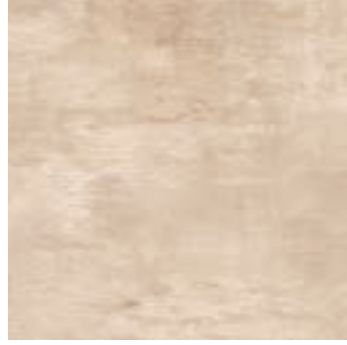

Beige / Bej



Grey / Gri



Schlamm / Açık kahve

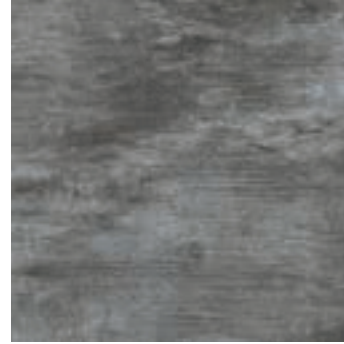

Basalt / Bazalt



Brown / Kahve

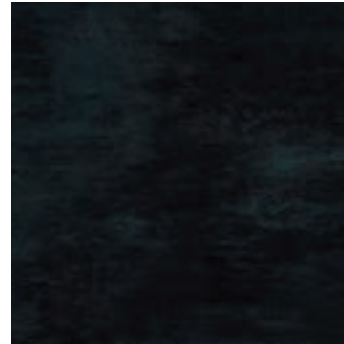

Anthracite / Antrasit



Light grey / Açık gri

Wall tiles  
Duvar karoları



**Product standard / Ürün standardı**  
EN14411 Group BIII

**Footnotes / Dip notlar**  
H R

## Base Tiles / Fonlar



White / Beyaz

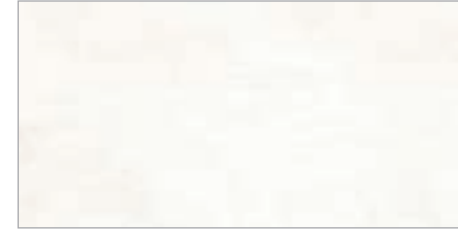

Cream / Krem



Grey / Gri



# Metro



60x60 Light grey / Açık gri

4 Faces / Yüzey görünümü (66x66)



60x60 Grey / Gri

4 Faces / Yüzey görünümü (66x66)



Glazed porcelain Sırlı porselen	Surface Yüzey	Thickness Kalınlık	45x45 (18"x18") R 447x447	30x30 (12"x12") R 297x297
Beige Bej	Matt / Mat	9 mm	K94436000001VTE0	
	R10A	7 mm		K94376800001VTE0
Schlamm Açık kahve	Matt / Mat	9 mm	K94436100001VTE0	
	R10A	7 mm		K54168700001VTE0
Brown Kahve	Matt / Mat	9 mm	K94436200001VTE0	
	R10A	7 mm		K54168900001VTE0
Light grey Açık gri	Matt / Mat	9 mm	K94456900001VTE0	
	R10A	7 mm		K94468800001VTE0
Grey Gri	Matt / Mat	9 mm	K94436300001VTE0	
	R10A	7 mm		K54169100001VTE0
Basalt Bazalt	Matt / Mat	9 mm	K94435900001VTE0	
	R10A	7 mm		K54168500001VTE0
Anthracite Antrasit	Matt / Mat	9 mm	K94435800001VTE0	
	R10A	7 mm		K94376700001VTE0



Colorbody porcelain Colorbody porselen	Surface Yüzey	Thickness Kalınlık	60x60 (24"x24") R 597x597	45x90 (18"x36") R 447x897	30x60 (12"x24") R 297x597
Beige Bej	LPR	9 mm	K943309LPR01VTE0		K943326LPR01VTE0
	LPR	10 mm		K943316LPR01VTS1	
	R10A	9 mm	K943309R0001VTE0		K943326R0001VTE0
	R10A	10 mm		K943316R0001VTS1	
	R11	20 mm	K943791R0001VTE1		
Schlamm Açık kahve	LPR	9 mm	K943311LPR01VTE0		K943327LPR01VTE0
	LPR	10 mm		K943316R0001VTS1	
	R10A	9 mm	K943311R0001VTE0		K943327R0001VTE0
	R10A	10 mm		K943317R0001VTS1	
	R11	20 mm	K944036R0001VTE1		
Brown Kahve	LPR	9 mm	K943312LPR01VTE0		K943328LPR01VTE0
	LPR	10 mm		K943318LPR01VTS1	
	R10A	9 mm	K943312R0001VTE0		K943328R0001VTE0
	R10A	10 mm		K943318R0001VTS1	
	R11	20 mm	K944037R0001VTE1		
Light grey Açık gri	LPR	9 mm	K944414LPR01VTE0		K944406LPR01VTE0
	LPR	10 mm		K944689LPR01VTS1	
	R10A	9 mm	K944414R0001VTE0		K944406R0001VTE0
	R10A	10 mm		K944689R0001VTS1	
	R11	20 mm	K945307R0001VTE1		
Grey Gri	LPR	9 mm	K943305LPR01VTE0		K943304LPR01VTE0
	LPR	10 mm		K943313LPR01VTS1	
	R10A	9 mm	K943305R0001VTE0		K943304R0001VTE0
	R10A	10 mm		K943313R0001VTS1	
	R11	20 mm	K943859R0001VTE1		
Basalt Bazalt	LPR	9 mm	K943307LPR01VTE0		K943325LPR01VTE0
	LPR	10 mm		K943314LPR01VTS1	
	R10A	9 mm	K943307R0001VTE0		K943325R0001VTE0
	R10A	10 mm		K943314R0001VTS1	
	R11	20 mm	K944035R0001VTE1		
Anthracite Antrasit	LPR	9 mm	K943308LPR01VTE0		K943324LPR01VTE0
	LPR	10 mm		K943315LPR01VTS1	
	R10A	9 mm	K943308R0001VTE0		K943324R0001VTE0
	R10A	10 mm		K943315R0001VTS1	
	R11	20 mm	K944038R0001VTE1		



# Metro









Cut border /  
Kesme bordür



Cut decor /  
Kesme dekor





Plinth /  
Süpürgelik



Decors Dekorlar	Surface Yüzeý	Thickness Kalınlık	1,5x15 R 47x47	5x5 (2"x2") R 47x47	8,5x60 (3,4"x24") R 82x597
 Beige Bej	R9 LPR	9 mm		K0862278LPR1VTE0	
	Matt / Mat	9 mm	K9463958R001VTE0		K943899R0001VTE1
 Schlamm Açık kahve	R9 LPR	9 mm		K0861758R001VTE0	
	Matt / Mat	9 mm		K0862308LPR1VTE0	K943900R0001VTE1
 Brown Kahve	R9 LPR	9 mm		K0861768R001VTE0	
	Matt / Mat	9 mm		K0862318LPR1VTE0	K943901R0001VTE1
 Light grey Açık gri	R9 LPR	9 mm		K0861778R001VTE0	
	Matt / Mat	9 mm		K0862268LPR1VTE0	K945119R0001VTE1
 Grey Gri	R9 LPR	9 mm		K0862258LPR1VTE0	
	Matt / Mat	9 mm	K9463948R001VTE0		K943896R0001VTE1
 Basalt Bazalt	R9 LPR	9 mm		K0861748R001VTE0	
	Matt / Mat	9 mm	K9463938R001VTE0		K943897R0001VTE1
 Anthracite Antrasit	R9 LPR	9 mm		K0862288LPR1VTE0	
	Matt / Mat	9 mm	K9463928R001VTE0		K943898R0001VTE1
	R10B	9 mm		K0861738R001VTE0	



Mosaic decor /  
Mozaik dekor

Decors Dekorlar	Surface Yüzeý	Thickness Kalınlık	5x5 (2"x2") R 47x47
 Mix 1 Mix 1	R10B	9 mm	K5416938R001VTE0
 Mix 2 Mix 2	R10B	9 mm	K5416948R001VTE0



Wall tiles Duvar karoları	Surface Yüzeý	Thickness Kalınlık	30x60 (12"x24") R 297x597
 White Beyaz	Matt / Mat	9 mm	K945145R0001VTE0
	Glossy / Parlak	9 mm	K945155R0001VTE0
 Cream Krem	Matt / Mat	9 mm	K945123R0001VTE0
	Glossy / Parlak	9 mm	K945156R0001VTE0
 Grey Gri	Matt / Mat	9 mm	K945124R0001VTE0
	Glossy / Parlak	9 mm	K945154R0001VTE0



Sizes Ebatlar	Thickness Kalınlık (mm)	Box Kutu			Pallet Palet		
		Pcs Adet	m <sup>2</sup>	kg	Box Kutu	m <sup>2</sup>	kg
<b>Colorbody porcelain / Colorbody porselen</b>							
45x90 Rectified / Rektifiyeli	10	3	1,215	26,55	36	43,74	986
60x60 Rectified / Rektifiyeli	20	2	0,72	31,68	30	21,60	975
60x60 Rectified / Rektifiyeli	9	4	1,44	26,90	30	43,20	832
30x60 Rectified / Rektifiyeli	9	6	1,08	20,10	40	43,20	829
8,5x60 Plinth / Süpürgelik	9	10	0,51	9,40	98	50,00	950
5x5 Cut decor / Kesme dekor	9	8	0,72	12,24	78	56,16	980
1,5x15 Cut border / Kesme bordür	9	8	0,72	9,00	35	25,20	340
<b>Glazed porcelain / Sırlı porselen</b>							
45x45 Non-rectified / Rektifiyesiz	9	7	1,42	26,20	26	36,92	706
30x30 Non-rectified / Rektifiyesiz	7	11	1,00	14,40	72	72,00	1.062
<b>Wall tiles / Duvar karoları</b>							
30x60 Rectified / Rektifiyeli	9	6	1,08	16,47	48	51,84	816



# Vado

A ceramic series makes it possible to create elegant and magnificent residential spaces. It appeals to all tastes thanks to its rich colour palette.

Yaşam alanları ve konutlar için en pratik şekilde sadeliği şıklıkla bir araya getiren seramik serisi. Basit bir dokunuşla evlerde ferah ve görkemli mekânlar yaratmaya imkân sağlıyor. Zengin renk paletiyle tüm ihtiyaçlara ve beğenilere hizmet ediyor.



Wall tiles / Duvar karoları :  
K90164300001VTE0 45x45 Vado Grey / Gri



Floor porcelain tiles / Yer porselen karoları :  
K90164300001VTE0 45x45 Vado Grey / Gri



# Vado

Glazed porcelain  
Sırlı porselen

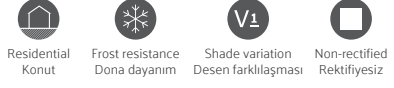

**Product standard / Ürün standardı**  
EN14411 Group Bla

**Footnotes / Dip notlar**  
H I

## Base Tiles / Fonlar



White / Beyaz

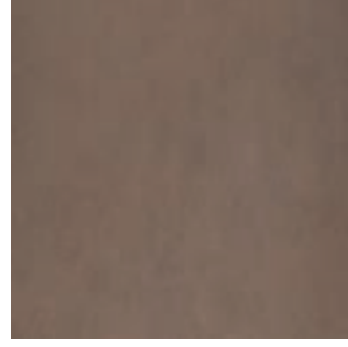

Soft brown / Soft kahve



Beige / Bej

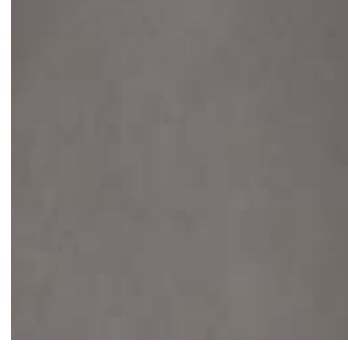

Grey / Gri

Floor tiles  
Yer karoları



**Product standard / Ürün standardı**  
EN14411 Group Blb

**Footnotes / Dip notlar**  
H I

## Base Tiles / Fonlar



White / Beyaz

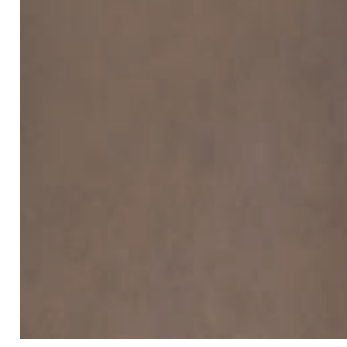

Soft brown / Soft kahve

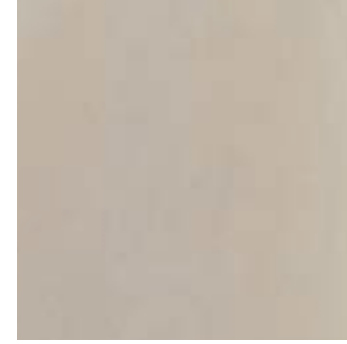

Beige / Bej

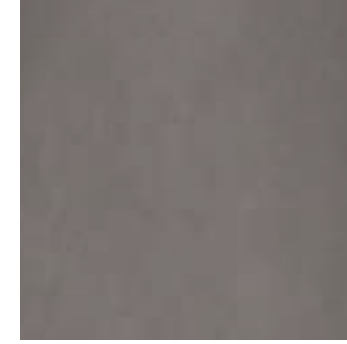

Grey / Gri



# Vado



45x45 Beige / Bej

1 Canvases / Kanvas (72x144)



45x45 Grey / Gri

1 Canvases / Kanvas (72x144)



Glazed porcelain Sırlı porselen	Surface Yüzeý	Thickness Kalınlık	45x45 (18"x18") 447x447
White Beyaz	Matt / Mat	9 mm	K90165400001VTE0
	R10B	9 mm	K94315300001VTE0
Beige Bej	Matt / Mat	9 mm	K90168000001VTE0
	R10B	9 mm	K94331900001VTE0
Grey Gri	Matt / Mat	9 mm	K90164300001VTE0
	R10B	9 mm	K94331900001VTE0
Soft brown Soft kahve	Matt / Mat	9 mm	K90167600001VTE0
	R10B	9 mm	K93742600001VTE0



Floor tiles Yer karoları	Surface Yüzeý	Thickness Kalınlık	33x33 (13,2"x13,2") 327x327
White Beyaz	Matt / Mat	7 mm	K91852600001VTE0
	R10B	7 mm	K91854100001VTE0
Beige Bej	Matt / Mat	7 mm	K91854100001VTE0
	R10B	7 mm	K91851500001VTE0
Grey Gri	Matt / Mat	7 mm	K91851500001VTE0
	R10B	7 mm	K91853000001VTE0
Soft brown Soft kahve	Matt / Mat	7 mm	K91853000001VTE0
	R10B	7 mm	K91853000001VTE0

Sizes Ebatlar	Thickness Kalınlık (mm)	Box Kutu			Pallet Palet		
		Pcs Adet	m <sup>2</sup>	kg	Box Kutu	m <sup>2</sup>	kg
<b>Glazed porcelain / Sırlı porselen</b>							
45x45 Non-rectified / Rektifiyesiz	9	7	1,42	26,20	26	36,92	706
<b>Floor tile / Yer karosu</b>							
33x33 Non-rectified / Rektifiyesiz	7	9	1,00	14,60	74	74,00	1.105



# Essence

A concrete textured ceramic series allowing lean designs for both commercial and residential buildings. Thanks to extra wear resistance of its double charge body, Essence can be safely used on floorings with heavy traffic and exterior cladding applications. Besides the glossy and matte surface options, the R12C non-slip alternative is suitable for use in wet areas and around pools.

Beton görünümüyle, ticari yapılar yanında konutlar için de modası hiç geçmeyecek yalın tasarımlara olanak sağlayan seramik serisi. Double charge bünyesinin kazandırdığı ekstra aşınma dayanıklılığı sayesinde Essence yoğun trafiği olan zeminlerde ve dış cephe uygulamalarında güvenle tercih edilebilir. Parlak ve mat yüzey seçenekleri yanında sunulan R12C kaymazlık alternatifi, ıslak alanlar ve havuz çevresinde kullanıma uygundur.



Floor porcelain tiles / Yer porselen karoları :  
K944470R0001VTE0 60x60 Essence Light grey / Açık gri



Wall tiles / Duvar karoları :  
K944452R0001VTE0 30x60 Essence Cream / Krem  
K944461R0001VTE0 30x60 Essence Dark grey / Koyu gri  
Floor porcelain tiles / Yer porselen karoları :  
K944473R0001VTE0 60x60 Essence Dark grey / Koyu gri



# Essence

Double charge porcelain  
Double charge porselen



**Product standard / Ürün standardı**  
EN14411 Group B1a

**Footnotes / Dip notlar**  
H R

## Base Tiles / Fonlar



White / Beyaz



Dark grey / Koyu gri



Cream / Krem

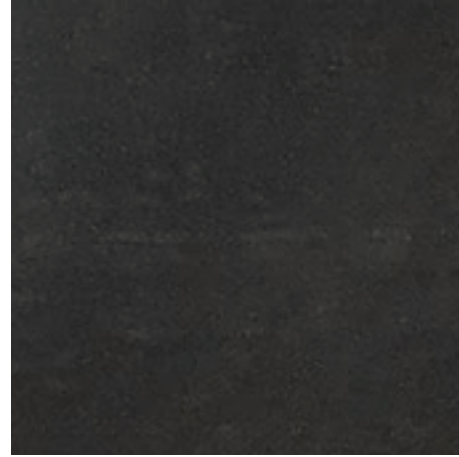

Anthracite / Antrasit



Light grey / Açık gri

## Decors / Dekorlar



Cut mosaic / Kesme mozaik  
White / Beyaz



Cut mosaic / Kesme mozaik  
Dark grey / Koyu gri



Cut mosaic / Kesme mozaik  
Cream / Krem

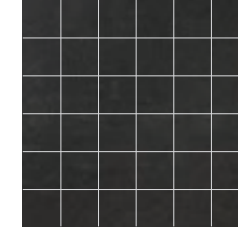

Cut mosaic / Kesme mozaik  
Anthracite / Antrasit

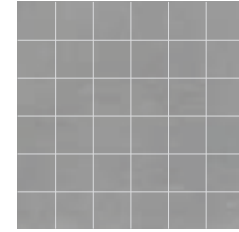

Cut mosaic / Kesme mozaik  
Light grey / Açık gri



# Essence



Double charge porcelain Double charge porselen		Surface Yüzey	Thickness Kalınlık	60x60 (24"x24") R 597x597	30x60 (12"x24") R 297x597
White Beyaz	Polished / Parlak	9 mm	K945162PR001VTE0		
	Polished / Parlak	9 mm	K945163PR001VTE0		
	R10	10 mm	K945855R0001VTE0	K945850R0001VTE0	
Cream Krem	Polished / Parlak	9 mm	K945233PR001VTE0		
	Polished / Parlak	9 mm	K945230PR001VTE0		
	R10	10 mm	K944464R0001VTE0	K944452R0001VTE0	
Light grey Açık gri	Polished / Parlak	9 mm	K945231PR001VTE0		
	Polished / Parlak	9 mm	K945228PR001VTE0		
	R10	10 mm	K944470R0001VTE0	K944458R0001VTE0	
Dark grey Koyu gri	Polished / Parlak	9 mm	K945232PR001VTE0		
	Polished / Parlak	9 mm	K945229PR001VTE0		
	R10	10 mm	K944473R0001VTE0	K944461R0001VTE0	
Anthracite Antrasit	Polished / Parlak	9 mm	K945849PR001VTE0		
	Polished / Parlak	9 mm	K945848PR001VTE0		
	R10	10 mm	K945853R0001VTE0	K945852R0001VTE0	



Cut decor /  
Kesme dekor

Decors Dekorlar		Surface Yüzey	Thickness Kalınlık	5x5 (2"x2") R 47x47
White Beyaz	R10	10 mm	K9460068R001VTE0	
Cream Krem	R10	10 mm	K9460078R001VTE0	
Light grey Açık gri	R10	10 mm	K9460088R001VTE0	
Dark grey Koyu gri	R10	10 mm	K9460098R001VTE0	
Anthracite Antrasit	R10	10 mm	K9460108R001VTE0	

Sizes Ebatlar	Thickness Kalınlık (mm)	Box Kutu			Pallet Palet		
		Pcs Adet	m <sup>2</sup>	kg	Box Kutu	m <sup>2</sup>	kg
Double charge porcelain / Double charge porselen							
60x60 Rectified / Rektifiyeli	10	4	1,44	30,74	30	43,20	947
60x60 Rectified / Rektifiyeli	9	4	1,44	27,94	30	43,20	863
60x60 Rectified / Rektifiyeli (Polished / Parlak)	9	4	1,44	27,90	30	43,20	863
30x60 Rectified / Rektifiyeli	10	6	1,08	23,06	40	43,20	947
30x60 Rectified / Rektifiyeli (Polished / Parlak)	9	6	1,08	22,50	40	43,2	925
5x5 Cut decor / Kesme dekor	10	7	0,63	9,51	78	49,14	767



Wall tiles / Duvar karoları :  
K944461R0001VTE0 30x60 Essence Dark grey / Koyu gri  
Floor porcelain tiles / Yer porselen karoları :  
K944473R0001VTE0 60x60 Essence Dark grey / Koyu gri



# Beton

Beton porcelain tiles, included in VitrA's library of concrete textured tiles, offer options both for indoor and outdoor applications. Beton collection is ideal for the walls and floors of both residential and commercial spaces with its rich size options in cold and warm colours.

VitrA'nın beton dokulu karo kütüphanesi içinde yer alan porselen koleksiyonu Beton, hem iç hem de dış mekân kullanımına uygun seçenekler sunuyor. Sıcak ve soğuk tonlardaki renkleri ve geniş ebat seçenekleriyle Beton koleksiyonu ev içi yaşam alanları yanında ticari alan yer ve duvar kullanımları için de tercih edilebilir.



Wall tiles / Duvar karoları :  
K93021600001VTE0 30x60 Beton White / Beyaz  
K93022000001VTE0 30x60 Beton Grey / Gri



Wall tiles / Duvar karoları :  
K93021600001VTE0 30x60 Beton White / Beyaz  
K93022000001VTE0 30x60 Beton Grey / Gri  
Floor porcelain tiles / Yer porselen karoları :  
K930275R0001VTE0 60x60 Beton White / Beyaz



# Beton

Colorbody porcelain  
Colorbody porselen

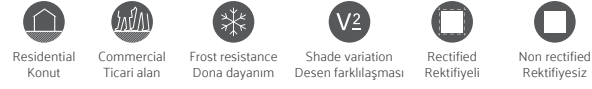

**Product standard / Ürün standardı**  
EN14411 Group Bla

**Footnotes / Dip notlar**  
F H R

## Base Tiles / Fonlar



White / Beyaz



Grey / Gri



Beige / Bej



Soft mocha / Soft moka

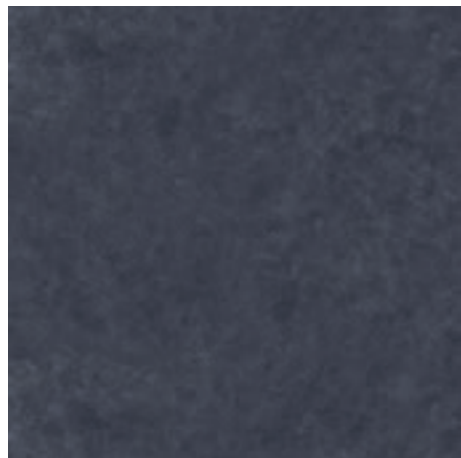

Anthracite / Antrasit

Glazed porcelain  
Sırlı porselen



**Product standard / Ürün standardı**  
EN14411 Group Bla

**Footnotes / Dip notlar**  
F H R

## Base Tiles / Fonlar



White / Beyaz



Grey / Gri



Beige / Bej



Soft mocha / Soft moka

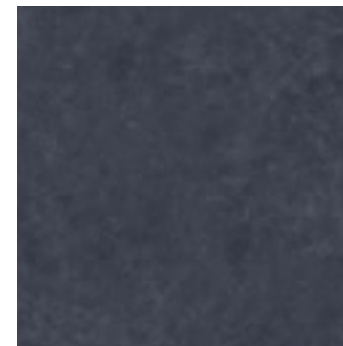

Anthracite / Antrasit



# Beton

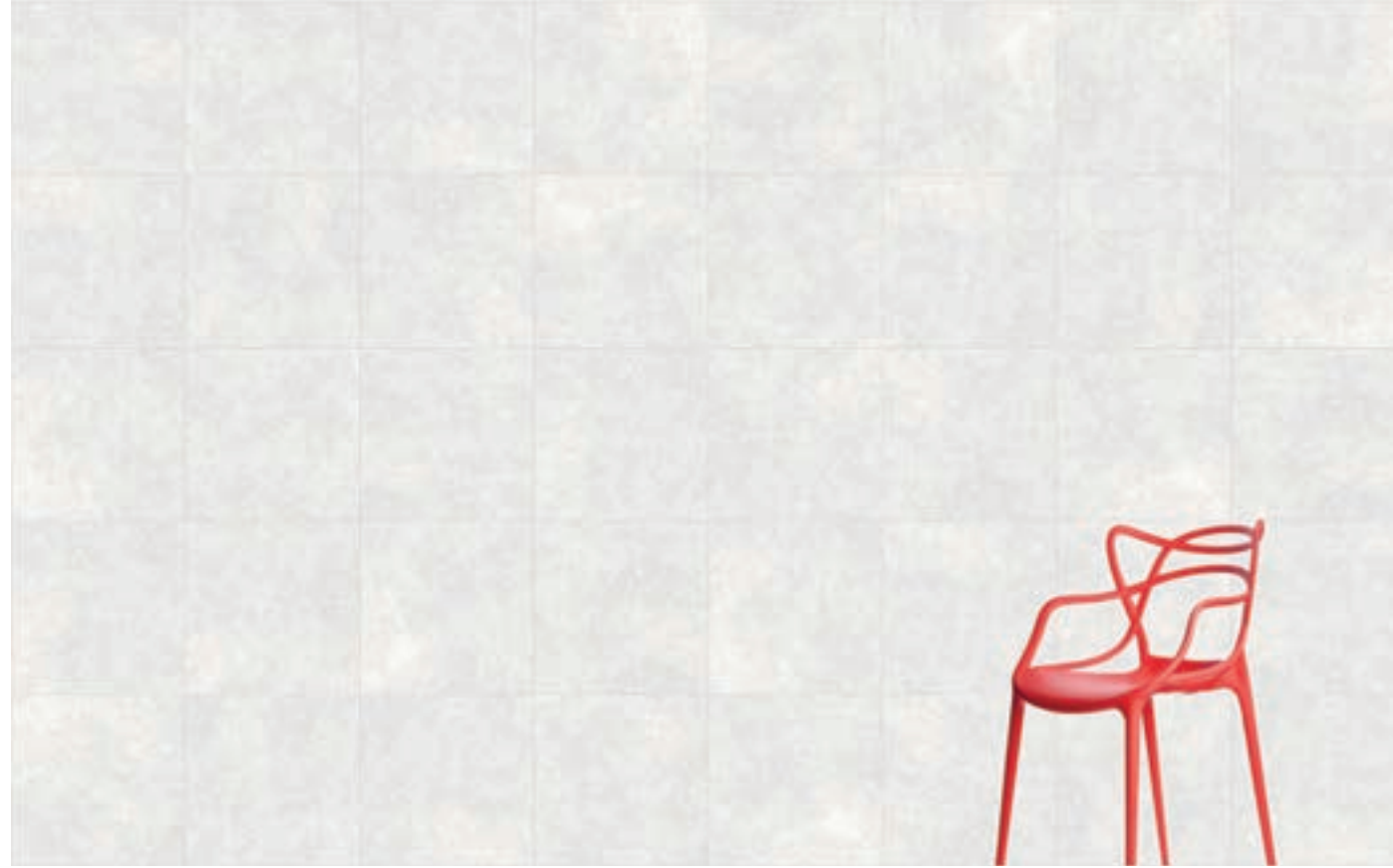

60x60 Light grey / Açık gri

1 Canvases / Kanvas (144x90)



60x60 Grey / Gri

1 Canvases / Kanvas (144x90)

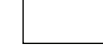
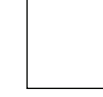

Colorbody porcelain Colorbody porselen	Surface Yüzey	Thickness Kalinlık	60x60 (24"x24") R 597x597	30x60 (12"x24") R 297x597
White Beyaz	Matt / Mat	9 mm	K93027500001VTE0	K93021600001VTE0
	Matt / Mat	9 mm	K930275R0001VTE0	
Beige Bej	Matt / Mat	9 mm	K93029000001VTE0	K93023100001VTE0
	Matt / Mat	9 mm	K930290R0001VTE0	
Anthracite Antrasit	Matt / Mat	9 mm	K93031200001VTE0	K93025300001VTE0
	Matt / Mat	9 mm	K930312R0001VTE0	
Grey Gri	Matt / Mat	9 mm	K93028600001VTE0	K93022000001VTE0
	Matt / Mat	9 mm	K930286R0001VTE0	
Soft mocha Soft moka	Matt / Mat	9 mm	K93032300001VTE0	K93026400001VTE0
	Matt / Mat	9 mm	K930323R0001VTE0	



Plinth /  
Süpürgelik

Decors Dekorlar	Surface Yüzey	Thickness Kalinlık	8,5x60 (3,4"x24") R 82x597
White Beyaz	Matt / Mat	9 mm	K94096300001VTE1
Beige Bej	Matt / Mat	9 mm	K94093000001VTE1
Anthracite Antrasit	Matt / Mat	9 mm	K94095200001VTE1
Grey Gri	Matt / Mat	9 mm	K94097400001VTE1
Soft mocha Soft moka	Matt / Mat	9 mm	K94098500001VTE1



# Beton



Glazed porcelain Sırlı porselen	Surface Yüzey	Thickness Kalınlık	45x45 (18"x18") R 447x447	30x30 (12"x12") R 297x297
White Beyaz	Matt / Mat	9 mm	K93403300001VTE0	K94399700001VTE0
Beige Bej	Matt / Mat	9 mm	K93405500001VTE0	K94400100001VTE0
Anthracite Antrasit	Matt / Mat	9 mm	K93407000001VTE0	K94422500001VTE0
Grey Gri	Matt / Mat	9 mm	K93404400001VTE0	K94400000001VTE0
Soft mocha Soft moka	Matt / Mat	9 mm	K93408100001VTE0	K94375300001VTE0



Decors Dekorlar	Surface Yüzey	Thickness Kalınlık	8,5x45 (3.4"x18") R 82x447
White Beyaz	Matt / Mat	9 mm	K94329500001VTE1
Beige Bej	Matt / Mat	9 mm	K94328400001VTE1
Anthracite Antrasit	Matt / Mat	9 mm	K94327300001VTE1
Grey Gri	Matt / Mat	9 mm	K94330600001VTE1
Soft mocha Soft moka	Matt / Mat	9 mm	K94331000001VTE1

Sizes Ebatlar	Thickness Kalınlık (mm)	Box Kutu			Pallet Palet		
		Pcs Adet	m <sup>2</sup>	kg	Box Kutu	m <sup>2</sup>	kg
<b>Colorbody porcelain / Colorbody porselen</b>							
60x60 Rectified / Rektifiyeli	9	4	1,44	26,90	30	43,20	832
30x60 Non-rectified / Rektifiyesiz	9	6	1,08	20,30	40	43,20	837
8,5x60 Plinth / Süpürgelik	9	10	0,51	9,40	98	50,00	950
<b>Glazed porcelain / Sırlı porselen</b>							
45x45 Non-rectified / Rektifiyesiz	9	7	1,42	26,20	26	36,92	706
30x30 Non-rectified / Rektifiyesiz	7	11	1,00	14,40	72	72,00	1.062
8.5x45 Plinth / Süpürgelik	9	10	0,38	7,08	140	53,60	1.016



Wall tiles / Duvar karoları :  
K93021600001VTE0 30x60 Beton White / Beyaz  
Floor porcelain tiles / Yer porselen karoları :  
K930275R0001VTE0 60x60 Beton White / Beyaz



# Ilot

Ilot porcelain tile collection with its industrial texture comes both in rectified and non-rectified options for wide range of applications. The concrete look of Ilot can be used on the floors and walls of both indoor and outdoor areas.

Endüstriyel dokusu ve geniş kullanım alanlarıyla Ilot porselen koleksiyonu, rektifiye ve rektifiyesiz ürün alternatifleri ile sunuluyor. Ilot, beton görünümüyle hem yer hem de duvar kullanımı için uygun olması yanında ev dışı alanlarda da güvenle kullanılabilir.



Porcelain floor tiles / Porselen yer karoları :  
K95011900001VTE0 45x45 Ilot Grey / Gri



Wall tiles / Duvar karoları :  
K95011900001VTE0 45x45 Ilot Grey / Gri  
Porcelain floor tiles / Porselen yer karoları :  
K95011900001VTE0 45x45 Ilot Grey / Gri



# Ilot

Colorbody porcelain  
Colorbody porselen

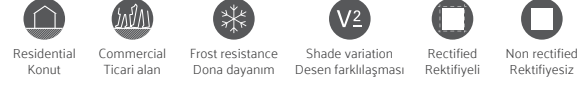

**Product standard / Ürün standardı**  
EN14411 Group Bla

**Footnotes / Dip notlar**  
F H R

## Base Tiles / Fonlar



Beige / Bej



Grey / Gri

Glazed porcelain  
Sırlı porselen



**Product standard / Ürün standardı**  
EN14411 Group Bla

**Footnotes / Dip notlar**  
F H R

## Base Tiles / Fonlar

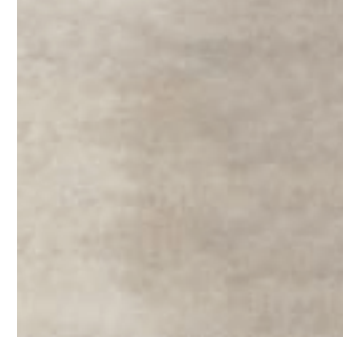

Beige / Bej



Grey / Gri

Floor tiles  
Yer karoları



**Product standard / Ürün standardı**  
EN14411 Group Blb

**Footnotes / Dip notlar**  
F H R

## Base Tiles / Fonlar

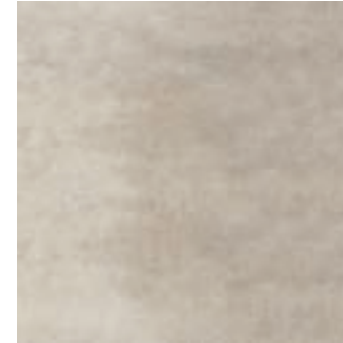

Beige / Bej



Grey / Gri



# Ilot



60x60 Beige / Bej

1 Faces / Yüzey görünümü (66x66)



60x60 Grey / Gri

1 Faces / Yüzey görünümü (66x66)

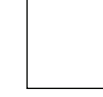

Colorbody porcelain Colorbody porselen	Surface Yüzey	Thickness Kalınlık	60x60 (24"x24") R 597x597
Beige Bej	Matt / Mat	9 mm	K949722R0001VTE0
Grey Gri	Matt / Mat	9 mm	K949721R0001VTE0



Glazed porcelain Sırlı porselen	Surface Yüzey	Thickness Kalınlık	45x45 (18"x18") 447x447
Beige Bej	Matt / Mat	9 mm	K94970500001VTE0
Grey Gri	Matt / Mat	9 mm	K95011900001VTE0



Floor tiles Yer karoları	Surface Yüzey	Thickness Kalınlık	33x33 (13,2"x13,2") 327x327
Beige Bej	Matt / Mat	7 mm	K94971800001VTE0
Grey Gri	Matt / Mat	7 mm	K94971700001VTE0

Sizes Ebatlar	Thickness Kalınlık (mm)	Box Kutu			Pallet Palet		
		Pcs Adet	m <sup>2</sup>	kg	Box Kutu	m <sup>2</sup>	kg
<b>Colorbody porcelain / Colorbody porselen</b>							
60x60 Rectified / Rektifiyeli	9	4	1,44	27,72	30	43,20	857
<b>Glazed porcelain / Sırlı porselen</b>							
45x45 Non-rectified / Rektifiyesiz	9	7	1,42	26,20	26	36,92	706
<b>Floor tiles / Yer karoları</b>							
33x33 Non-rectified / Rektifiyesiz	7	9	1,00	14,60	74	74,00	1.105



# Iron

Iron presents the strong and durable structure of concrete in a minimalistic concrete texture. The realistic concrete texture, created with Vitra ReaLook technology, is preserved for years under the most demanding conditions which makes Iron ideal for both residential and commercial applications.

Iron, betonun güçlü ve dayanıklı yapısını minimal yüzey dokusunda sunuyor. Vitra ReaLook teknolojisiyle üretilen karolar, en zorlu kullanım koşullarında bile gerçekçi beton dokusunu çok uzun yıllar koruyor ve hem ev içi hem de ticari alan kullanımı için ideal bir seçenek oluşturuyor.



Porcelain floor tiles / Porselen yer karoları :  
K94970600001VTE0 45x45 Iron Grey / Gri



Wall tiles / Duvar karoları :  
K94970600001VTE0 45x45 Iron Grey / Gri  
Porcelain floor tiles / Porselen yer karoları :  
K94970600001VTE0 45x45 Iron Grey / Gri



# Iron

Colorbody porcelain  
Colorbody porselen

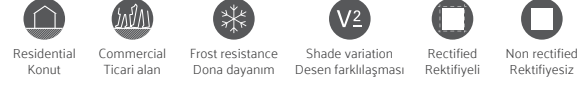

**Product standard / Ürün standardı**  
EN14411 Group Bla

**Footnotes / Dip notlar**  
F H R

## Base Tiles / Fonlar



Light grey / Açık gri



Grey / Gri

Glazed porcelain  
Sırlı porselen



**Product standard / Ürün standardı**  
EN14411 Group Bla

**Footnotes / Dip notlar**  
F H R

## Base Tiles / Fonlar

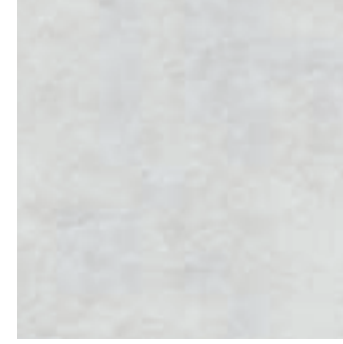

Light grey / Açık gri

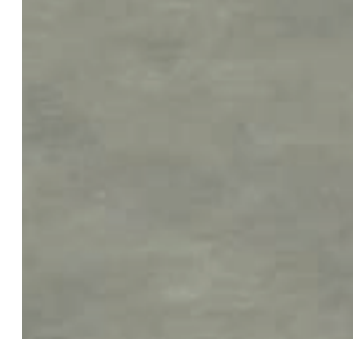

Grey / Gri

Floor tiles  
Yer karoları



**Product standard / Ürün standardı**  
EN14411 Group Blb

**Footnotes / Dip notlar**  
F H R

## Base Tiles / Fonlar

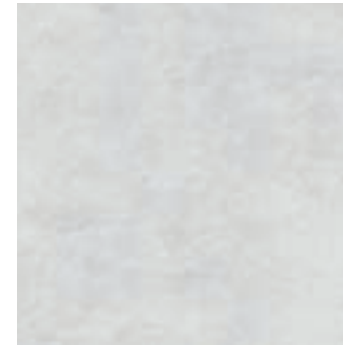

Light grey / Açık gri

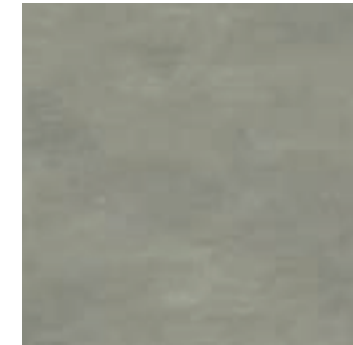

Grey / Gri



# Iron



60x60 Light grey / Açık gri

1 Faces / Yüzey görünümü (66x66)



60x60 Grey / Gri

1 Faces / Yüzey görünümü (66x66)

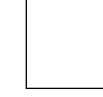

Colorbody porcelain Colorbody porselen	Surface Yüzey	Thickness Kalınlık	60x60 (24"x24") R 597x597
Light grey Açık gri	Matt / Mat	9 mm	K949723R0001VTE0
Grey Gri	Matt / Mat	9 mm	K949724R0001VTE0



Glazed porcelain Sırlı porselen	Surface Yüzey	Thickness Kalınlık	45x45 (18"x18") 447x447
Light grey Açık gri	Matt / Mat	9 mm	K94970300001VTE0
Grey Gri	Matt / Mat	9 mm	K94970600001VTE0



Floor tiles Yer karoları	Surface Yüzey	Thickness Kalınlık	33x33 (13,2"x13,2") 327x327
Light grey Açık gri	Matt / Mat	7 mm	K94971900001VTE0
Grey Gri	Matt / Mat	7 mm	K94972000001VTE0

Sizes Ebatlar	Thickness Kalınlık (mm)	Box Kutu			Pallet Palet		
		Pcs Adet	m <sup>2</sup>	kg	Box Kutu	m <sup>2</sup>	kg
<b>Colorbody porcelain / Colorbody porselen</b>							
60x60 Rectified / Rektifiyeli	9	4	1,44	27,72	30	43,20	857
<b>Glazed porcelain / Sırlı porselen</b>							
45x45 Non-rectified / Rektifiyesiz	9	7	1,42	26,20	26	36,92	706
<b>Floor tiles / Yer karoları</b>							
33x33 Non-rectified / Rektifiyesiz	7	9	1,00	14,60	74	74,00	1.105



# Terre

A ceramic series that reinterprets classic cotto look and blends it with concrete texture. The modern design of the collection brings a natural living experience to the places where it is used.

Klasik cotto görünümünü beton dokusuyla harmanlayarak yeniden yorumlayan seramik serisi. Koleksiyonun modern görünümü kullanıldığı mekânlara doğal bir yaşanmışlık kazandırıyor.



Floor tiles / Yer karoları :  
K94462700001VTE0 45x45 Terre Light grey / Açık gri



Floor tiles / Yer karoları :  
K94462700001VTE0 45x45 Terre Light grey / Açık gri



# Terre

Glazed porcelain  
Sırlı porselen



Product standard / Ürün standardı  
EN14411 Group B1a

Footnotes / Dip notlar  
H R

## Base Tiles / Fonlar



Mink / Vizon

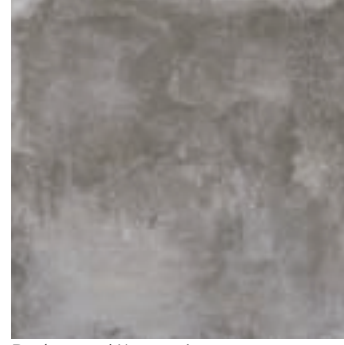

Dark grey / Koyu gri



Light grey / Açık gri



White / Beyaz



Grey / Gri



45x45 White / Beyaz

5 Canvases / Kanvas (66x66)



45x45 Grey / Gri

5 Canvases / Kanvas (66x66)



# Terre



Glazed porcelain Sırlı porselen	Surface Yüzey	Thickness Kalınlık	45x45 (18"x18") 442x442
Mink Vizon	Matt / Mat	9 mm	K94462900001VTE0
Light grey Açık gri	Matt / Mat	9 mm	K94462700001VTE0
Grey Gri	Matt / Mat	9 mm	K94462800001VTE0
Dark grey Koyu gri	Matt / Mat	9 mm	K94463000001VTE0
White Beyaz	Matt / Mat	9 mm	K94467100001VTE0

Sizes Ebatlar	Thickness Kalınlık (mm)	Box Kutu			Pallet Palet		
		Pcs Adet	m <sup>2</sup>	kg	Box Kutu	m <sup>2</sup>	kg
Glazed porcelain / Sırlı porselen							
45x45 Non-rectified / Rektifiyesiz	9	7	1,42	26,20	26	36,92	706



Floor tiles / Yer karoları :  
K94462700001VTE0 45x45 Terre Light grey / Açık gri



# Truva

Carrying traces of Troy that is considered to have been one of the most beautiful and extraordinary cities in hellenistic period, the series blends the high culture of the ancient times with our modern world. Reflecting the comforting effects of cotto style with warm hues, the series is produced in tobacco, beige, cream, white and grey colour options. Truva Ceramic floor tiles come in 33x33 cm.

Helenistik dönemde tüm antik dünyadaki çağdaşları arasında en güzel ve sıra dışı kentlerden biri olarak kabul edilen Truva'dan izler taşıyan seri, yüksek düzeyde bir kültürel yaşantıyı günümüzle harmanlıyor. Cotto tarzının rahatlatıcı etkilerini sıcak tonlarla mekânlara yansıtan seride taba, krem, bej, beyaz ve gri renkleri bulunuyor. Truva Seramik yer karoları 33x33 cm ölçülerine sahip.



Floor tiles / Yer karoları :  
K94462700001VTE0 45x45 Terre Light grey / Açık gri



Floor tiles / Yer karoları :  
K76685000001VTE0 33x33 Truva White / Beyaz



# Truva

Floor tiles  
Yer karoları

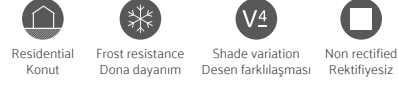

Product standard / Ürün standardı  
EN14411 Group B1b

Footnotes / Dip notlar  
H R

## Base Tiles / Fonlar

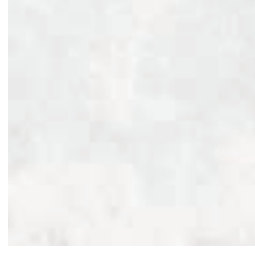

White / Beyaz



Grey / Gri



Floor tiles Yer karoları	Surface Yüzey	Thickness Kalınlık	33x33 (13,2"x13,2") 327x327
White Beyaz	Matt / Mat	7 mm	K76685000001VTE0
Grey Gri	Matt / Mat	7 mm	K76178400001VTE0

Sizes Ebatlar	Thickness Kalınlık (mm)	Box Kutu			Pallet Palet		
		Pcs Adet	m <sup>2</sup>	kg	Box Kutu	m <sup>2</sup>	kg
Floor tile / Yer karosu							
33x33 Non-rectified / Rektifiyesiz	7	9	1,00	14,60	74	74,00	1.105

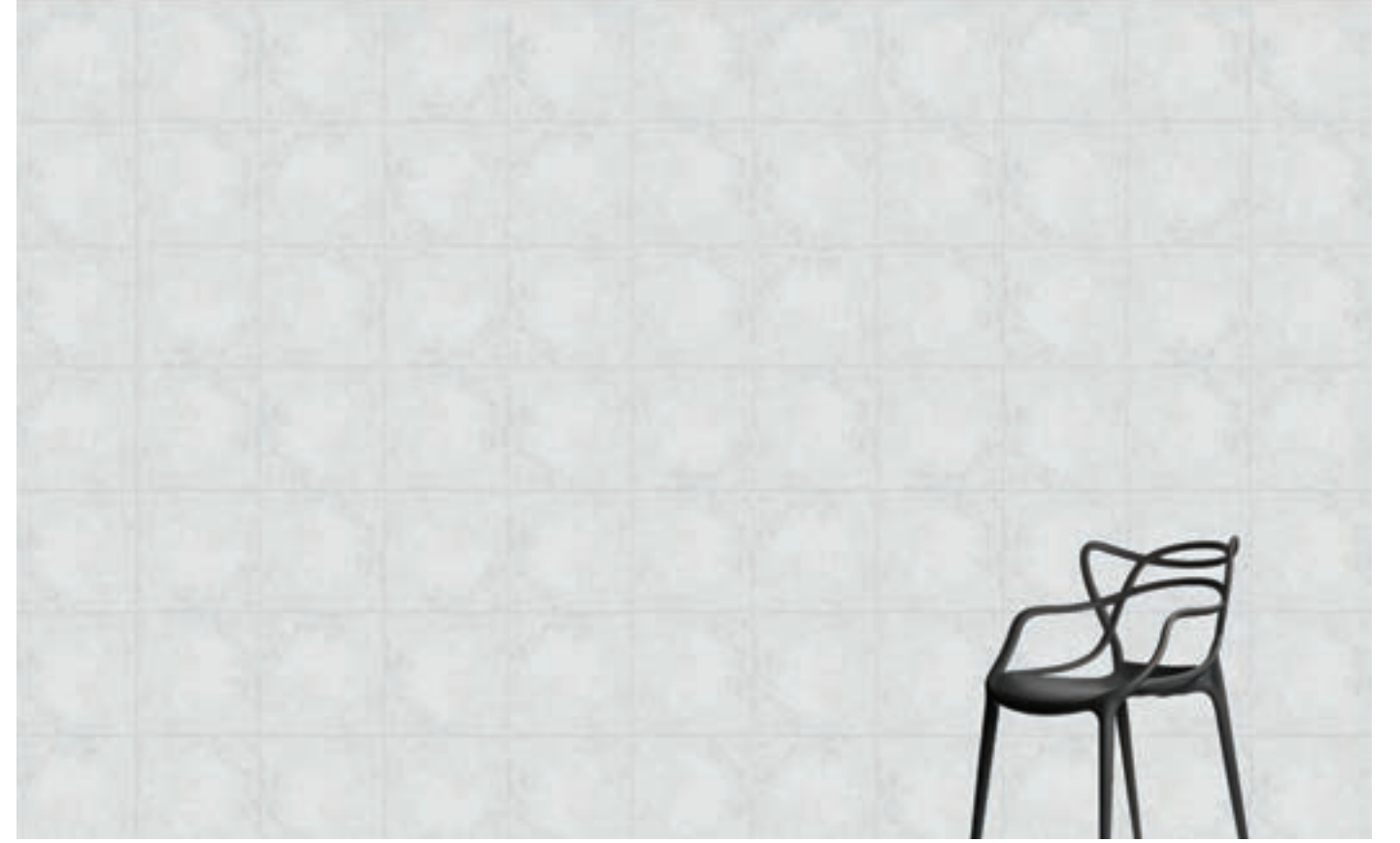

33x33 White / Beyaz

1 Canvases / Kanvas (70x130)



33x33 Grey / Gri

1 Canvases / Kanvas (70x130)



# Scale

A porcelain collection that brings to the fore the architectural value of large size. The Scale Collection creates a monochrome look that is compatible with the full range of warm and cold colours in the ColorCode approach. Thanks to its flexibility and durability, Scale offers architects a wide range of solutions for interiors and exteriors.

Büyük boyutun mimari değerini ortaya çıkaran porselen koleksiyonu. Scale Koleksiyonu, bütünsel bir monokrom görüntü ve ColorCode yaklaşımının tüm sıcak ve soğuk renkleriyle uyum sağlıyor. Esnek ve dayanıklı yapısıyla Scale, mimarlar için iç ve dış mekân uygulamalarında geniş çözümler sunuyor.



Wall tiles / Duvar karoları :  
K947479R0001VTS0 100x300 Scale Grey / Gri



Wall tiles / Duvar karoları :  
K947481R0001VTS0 100x300 Scale Dark grey / Koyu gri  
K947479R0001VTS0 100x300 Scale Grey / Gri



# Scale

Slab  
Slab

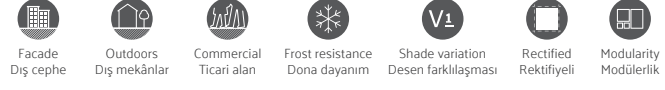

**Product standard / Ürün standardı**  
EN14411 Group BIII

**Footnotes / Dip notlar**  
M

## Base Tiles / Fonlar



White / Beyaz



Dark grey / Koyu gri



Dark greige / Koyu grej

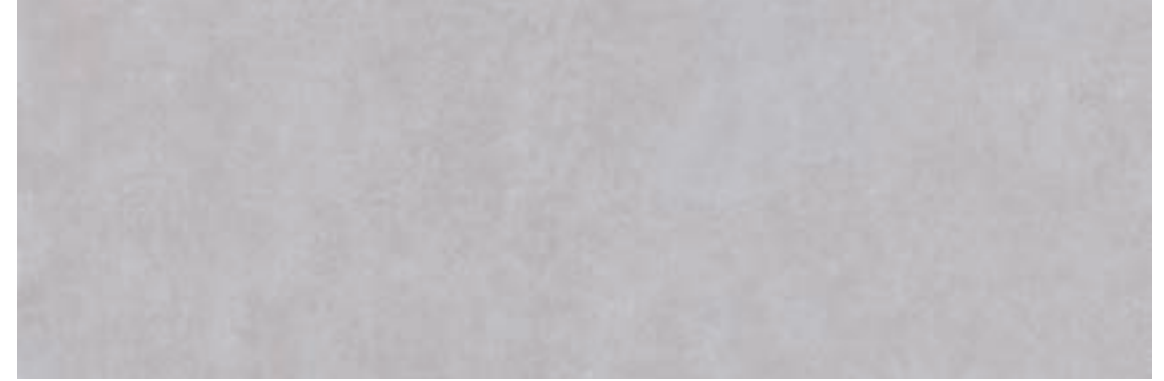

Grey / Gri



Mink / Vizon



# Scale



Colorbody porcelain Colorbody porselen	Surface Yüzey	Thickness Kalınlık	100x300 (40"x120") R 997x2997
	White Beyaz	Matt / Mat	5,5 mm K949043R0001VTS0
		Matt / Mat	3,5 mm K949042R0001VTS0
	Dark greige Koyu grej	Matt / Mat	5,5 mm K947480R0001VTS0
		Matt / Mat	3,5 mm K947476R0001VTS0
	Mink Vizon	Matt / Mat	5,5 mm K947482R0001VTS0
		Matt / Mat	3,5 mm K947478R0001VTS0
	Dark grey Koyu gri	Matt / Mat	5,5 mm K947481R0001VTS0
		Matt / Mat	3,5 mm K947477R0001VTS0
	Grey Gri	Matt / Mat	5,5 mm K947479R0001VTS0
		Matt / Mat	3,5 mm K947475R0001VTS0

Sizes Ebatlar	Thickness Kalınlık (mm)	Box Kutu			Pallet Palet		
		Pcs Adet	m <sup>2</sup>	kg	Box Kutu	m <sup>2</sup>	kg
Colorbody porcelain / Colorbody porselen							
100x300 Rectified / Rektifiyeli	3,5	1	3,00	34,50	20	60,00	715
100x300 Rectified / Rektifiyeli	5,5	1	3,00	34,50	13	39,00	474

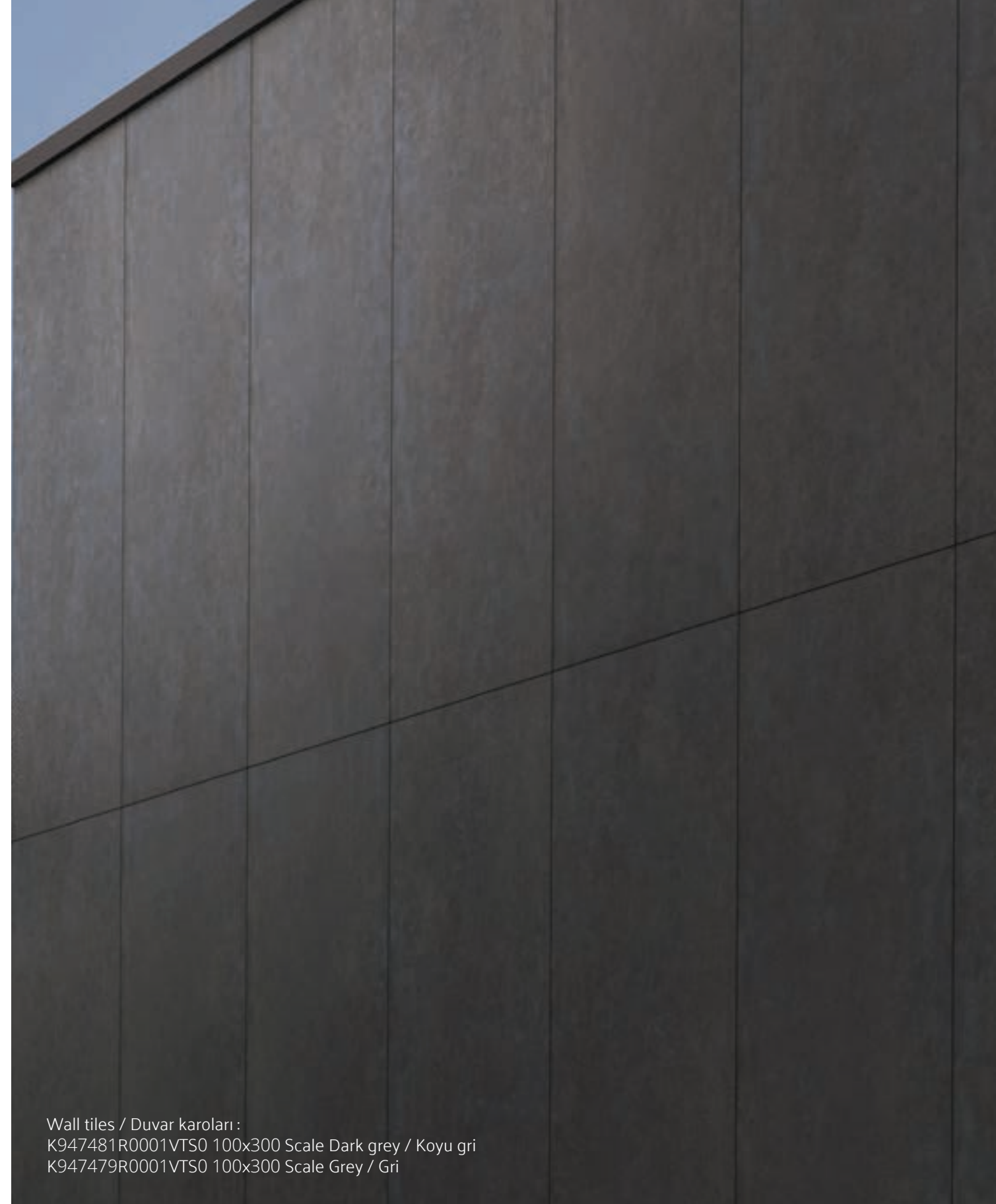

Wall tiles / Duvar karoları :  
K947481R0001VTS0 100x300 Scale Dark grey / Koyu gri  
K947479R0001VTS0 100x300 Scale Grey / Gri



# Stone code

## Taş zamanı

The stone is the secret of nature, which will never fade away. It offers the power of simplicity, with its durability and ever-lasting face.

Taş, doğanın hiçbir zaman eskimeyecek sırrı. Dayanıklılığı ve yıllara meydan okuyan yüzüyle size sadeliğin gücünü sunuyor.



# Flakestone



Flakestone porcelain collection reflects the calm character of natural stone to the spaces where it is used. The hybrid stone appearance, designed with the balanced combination of different textures, show traces of fossils created by nature over the years. The surface texture containing sparse flakes is the most distinctive feature of this collection. While the pure natural stone appearance adds an architectural value to the living spaces where it is used, it manages to do this in the most subtle way. The collection inspires creative designs with its colour options in warm and cold shades.

Flakestone porselen koleksiyonu, doğal taşın sakin karakterini kullandığı mekânlara yansıtıyor. Farklı dokuların dengeli birlikteliğiyle tasarlanan hibrit taş görünümü, içinde doğanın yıllar içinde oluşturduğu fosillerden izler taşıyor. Seyrek ince taş parçaları içeren yüzey dokusu, bu koleksiyonun en ayırt edici özelliği. Göz yormayan doğal taş görünümü, kullandığı yaşam alanlarına mimari olarak bir değer katarken bunu en sade şekilde yapmayı başarıyor. Koleksiyon, sıcak ve soğuk tonlardaki renk seçenekleriyle yaratıcı tasarımlar için ilham veriyor.



Wall tiles / Duvar karoları :  
K951140R0001VTE0 30x60 Flakestone Dark grey / Koyu gri  
K951111R0001VTE0 60x60 Flakestone Anthracite / Antrasit  
Floor porcelain tiles / Yer porselen karoları :  
K951111R0001VTE0 60x60 Flakestone Anthracite / Antrasit



Wall tiles / Duvar karoları :  
K951119R0001VTET 80x80 Flakestone Greige / Grej  
Floor porcelain tiles / Yer porselen karoları :  
K951119R0001VTET 80x80 Flakestone Greige / Grej



# Flakestone

Colorbody porcelain  
Colorbody porselen



**Product standard / Ürün standardı**  
EN14411 Group Bla

**Footnotes / Dip notlar**  
F H R

## Base Tiles / Fonlar



Light greige / Açık grej



Grey / Gri

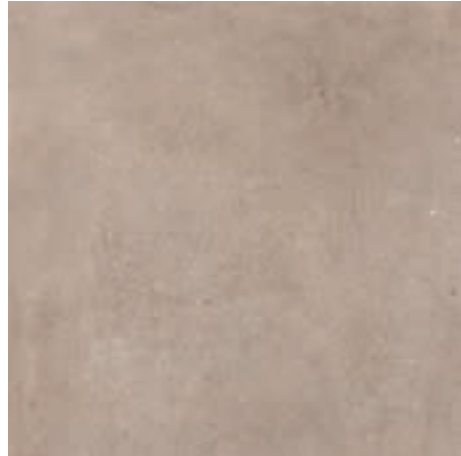

Greige / Grej

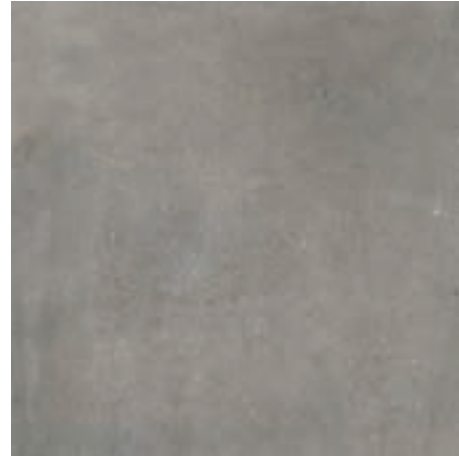

Dark grey / Koyu gri



Anthracite / Antrasit

## Decors / Dekorlar



Tread / Basamak  
Light greige / Açık grej



Plinth / Süpügelik  
Light greige / Açık grej



Plinth / Süpügelik  
Light greige / Açık grej



# Flakestone



80x80 Light greige / Açık grej



80x80 Dark grey / Koyu gri

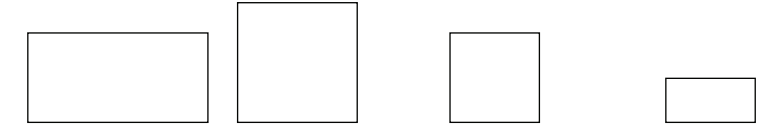

Colorbody porcelain Colorbody porselen	Surface Yüzey	Thickness Kalınlık	60x120 (24"x48") R 597x1197	80x80 (32"x32") R 797x797	60x60 (24"x24") R 597x597	30x60 (12"x24") R 297x597
Light greige Açık grej	R10B	9 mm	K951092R0001VTET	K951120R0001VTET	K951115R0001VTE0	K951142R0001VTE0
	R11B	20 mm	K951053R0001VTE0			
Greige Grej	R10B	9 mm	K951091R0001VTET	K951119R0001VTET	K951113R0001VTE0	K951141R0001VTE0
	R11B	20 mm	K951054R0001VTE0			
Grey Gri	R10B	9 mm	K951090R0001VTET	K951118R0001VTET	K951114R0001VTE0	K951139R0001VTE0
	R11B	20 mm	K951052R0001VTE0			
Dark grey Koyu gri	R10B	9 mm	K951089R0001VTET	K951116R0001VTET	K951112R0001VTE0	K951140R0001VTE0
	R11B	20 mm	K951050R0001VTE0			
Anthracite Antrasit	R10B	9 mm	K951088R0001VTET	K951117R0001VTET	K951111R0001VTE0	K951138R0001VTE0
	R11B	20 mm	K951051R0001VTE0			



Colorbody porcelain Colorbody porselen	Surface Yüzey	Thickness Kalınlık	30x30 (12"x12") R 297x297
Light greige Açık grej	R10B	7 mm	K95113600001VTE0
Greige Grej	R10B	7 mm	K95113700001VTE0
Grey Gri	R10B	7 mm	K95113500001VTE0
Dark grey Koyu gri	R10B	7 mm	K95113400001VTE0
Anthracite Antrasit	R10B	7 mm	K95113300001VTE0



# Flakestone



Tread /  
Basamak

Tread /  
Basamak

Decors Dekorlar	Surface Yüzeý	Thickness Kalınlık	30x120 (12"x48") R 297x1197	30x60 (12"x24") R 297x597
Light greige Açık grej	R10B	9 mm	K951166R0001VTET	K951157R0001VTE0
Greige Grej	R10B	9 mm	K951167R0001VTET	K951156R0001VTE0
Grey Gri	R10B	9 mm	K951165R0001VTET	K951154R0001VTE0
Dark grey Koyu gri	R10B	9 mm	K951164R0001VTET	K951155R0001VTE0
Anthracite Antrasit	R10B	9 mm	K951163R0001VTET	K951153R0001VTE0



Plinth /  
Süpürgelik

Plinth /  
Süpürgelik

Cut decor /  
Kesme dekor

Decors Dekorlar	Surface Yüzeý	Thickness Kalınlık	10x80 (4"x32") R 97x797	8,5x60 (3,4"x24") R 82x597	5x5 (2"x2") R 47x47
Light greige Açık grej	R10B	9 mm	K951162R0001VTET	K951147R0001VTE0	K9511528R001VTE0
Greige Grej	R10B	9 mm	K951161R0001VTET	K951146R0001VTE0	K9511518R001VTE0
Grey Gri	R10B	9 mm	K951160R0001VTET	K951145R0001VTE0	K9511508R001VTE0
Dark grey Koyu gri	R10B	9 mm	K951159R0001VTET	K951143R0001VTE0	K9511488R001VTE0
Anthracite Antrasit	R10B	9 mm	K951158R0001VTET	K951144R0001VTE0	K9511498R001VTE0

Sizes Ebatlar	Thickness Kalınlık (mm)	Box Kutu			Pallet Palet		
		Pcs Adet	m <sup>2</sup>	kg	Box Kutu	m <sup>2</sup>	kg
<b>Colorbody porcelain / Colorbody porselen</b>							
60x120 Rectified / Rektifiyeli	9	2	1,44	30,24	32	46,08	1.005
60x120 Rectified / Rektifiyeli	20	2	1,44	30,24	32	46,08	1.005
80x80 Rectified / Rektifiyeli	9	2	1,28	24,50	44	56,32	1.103
60x60 Rectified / Rektifiyeli	9	4	1,44	26,90	30	43,2	807
30x30 Rectified / Rektifiyeli	7	11	1,00	18,0	72	72,0	1.321
30x120 Tread / Basamak	9	3	1,08	22,3	44	47,52	1035
30x60 Tread / Basamak	9	6	1,08	15,9	48	51,84	764,6
10x80 Plinth / Süpürgelik	9	9	0,72	13,68	40	28,80	550
8,5x60 Plinth / Süpürgelik	9	10	0,51	9,40	98	50,00	950
5x5 Cut decor / Kesme dekor	9	8	0,72	12,20	78	56,16	954,7



Floor porcelain tiles / Yer porselen karoları:  
K951051R0001VTE0 60x120 Flakestone Anthracite / Antrasit 20 mm



# Canyon



Canyon porcelain collection is designed creating a harmonious combination of grey coloured English stone with white long veins and Italian Valmalenco stone which has a gold shade. The combination of these two rich natural stones creates a typology enriched with details. Canyon offers an excellent covering solution for floors and walls in all living spaces, whether classical or modern, and defines the classic of the future today.

Canyon porselen koleksiyonu, beyaz uzun damarlara ve yeşil gölgeli gri bir renge sahip İngiliz doğal taşıyla, altın etkisiyle zenginleştirilmiş İtalyan Valmalenco taşının uyumlu birlikteliğiyle tasarlandı. Bu iki zengin karakterli doğal taşın bir araya gelmesi, detaylarla zenginleşmiş bir tipoloji oluşturuyor. Canyon, ister klasik ister modern tasarımlı olsun tüm yaşam alanlarında zemin ve duvar kaplamaları için mükemmel bir kaplama çözümü sunuyor ve geleceğin klasiğini bugünden tanımlıyor.



Wall tiles / Duvar karoları :  
K951497R0001VTE0 30x60 Canyon Beige / Bej  
Floor tiles / Yer karoları :  
K951490R0001VTE0 60x60 Canyon Anthracite / Antrasit

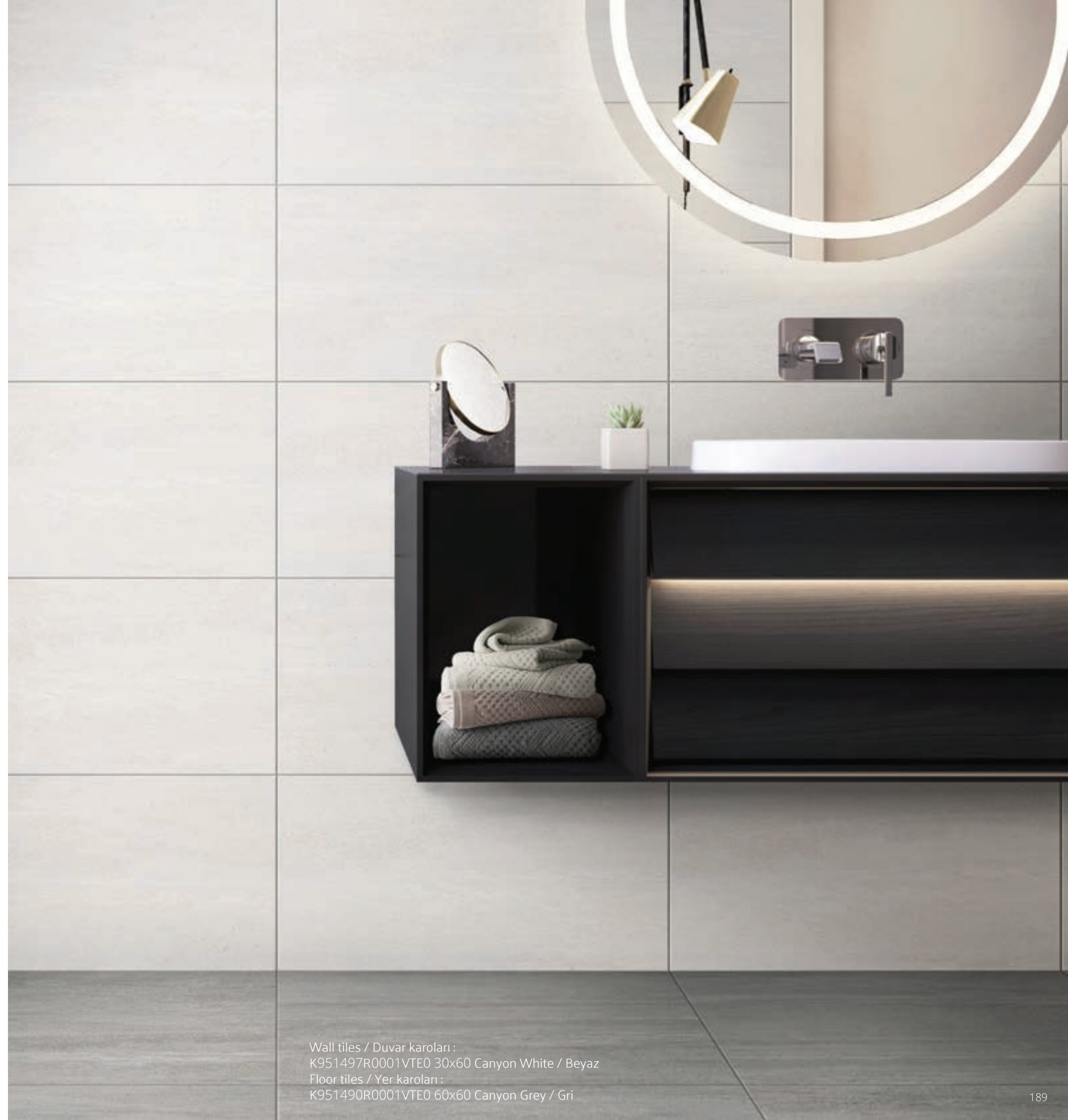

Wall tiles / Duvar karoları :  
K951497R0001VTE0 30x60 Canyon White / Beyaz  
Floor tiles / Yer karoları :  
K951490R0001VTE0 60x60 Canyon Grey / Gri



# Canyon

Glazed porcelain  
Sırlı porselen

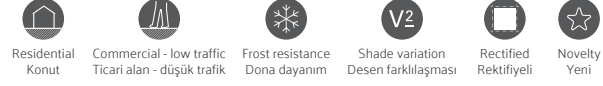

**Product standard / Ürün standardı**  
EN14411 Group Bla

**Footnotes / Dip notlar**  
H R

## Base Tiles / Fonlar



White / Beyaz



Grey / Gri



Beige / Bej



Anthracite / Antrasit



60x60 Beige / Bej



60x60 Grey / Gri



# Canyon



Glazed porcelain Sırlı porselen	Surface Yüzey	Thickness Kalınlık	60x60 (24"x24") R 597x597	30x60 (12"x24") R 297x597
 White Beyaz	PTV36+	9 mm	K951477R0001VTE0	K95148100001VTE0
 Beige Bej	PTV36+	9 mm	K951478R0001VTE0	K95148200001VTE0
 Grey Gri	PTV36+	9 mm	K951479R0001VTE0	K95148300001VTE0
 Anthracite Antrasit	PTV36+	9 mm	K951480R0001VTE0	K95148400001VTE0

Sizes Ebatlar	Thickness Kalınlık (mm)	Box Kutu			Pallet Palet		
		Pcs Adet	m <sup>2</sup>	kg	Box Kutu	m <sup>2</sup>	kg
<b>Glazed porcelain / Sırlı porselen</b>							
60x60 Rectified / Rektifiyeli	9	4	1,44	26,9	30	43,2	807,0
30x60 Rectified / Rektifiyeli	9	6	1,08	20,2	40	43,2	807,0



Wall tiles / Duvar karoları :  
K951497R0001VTE0 30x60 Canyon White / Beyaz  
Floor tiles / Yer karoları :  
K951490R0001VTE0 60x60 Canyon Grey / Gri



Wall tiles / Duvar karoları :  
K951497R0001VTE0 30x60 Canyon White / Beyaz  
Floor tiles / Yer karoları :  
K951490R0001VTE0 60x60 Canyon Grey / Gri



# Urban Travertino

Urban Travertino porcelain collection combines the strength and durability of porcelain with travertine, a natural stone which is widely-used in architecture and interior design. One of the oldest building materials travertine is re-interpreted by VitrA to find a new life in urban and contemporary spaces. Urban Travertino is developed in align with the VitrA's ColorCode system, which is a sophisticated mix of different materials and formats in cold and warm colour tones. Urban Travertino adds another variety to the system via its linear stone structure.

Urban Travertino porselen koleksiyonu, mimaride ve iç mimaride en çok tercih edilen doğal taş dokularından biri olan traverteni, porselenin gücü ve dayanıklılığıyla yüzeylere taşıyor. En eski yapı malzemelerinden biri olan traverten, VitrA'nın Urban Travertino serisi ile çağdaş ve şehirli mekân tasarımları için yeniden yorumlanıyor. Farklı malzeme ve formatların sofistike bir karması olan VitrA ColorCode sistemi ile uyumlu geliştirilen Urban Travertino, sistemin sıcak ve soğuk renklerine lineer yapısıyla bir çeşitlilik daha katıyor.

## Compatible collections / Uyumlu koleksiyonlar

Ceppostone	Metalcrete
Urbancrete	mode
Urbanwood	



Wall tiles / Duvar karoları :  
K950629R0001VTSP 60x120 Urban Travertino Light grey / Açık gri  
Floor porcelain tiles / Yer porselen karoları :  
K950630R0001VTSP 60x120 Urban Travertino Dark grey / Koyu gri



Wall tiles / Duvar karoları :  
K950605R0001VTET 80x80 Urban Travertino Light grey / Açık gri  
K950130R0001VTE0 45x90 Lambri Black / Siyah  
Floor porcelain tiles / Yer porselen karoları :  
K950605R0001VTET 80x80 Urban Travertino Light grey / Açık gri



# Urban Travertino

Colorbody porcelain  
Colorbody porselen

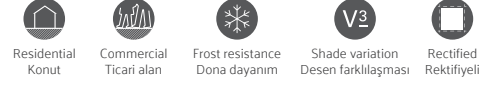

**Product standard / Ürün standardı**  
EN14411 Group Bla

**Footnotes / Dip notlar**  
F H R

## Base Tiles / Fonlar



Mink / Vizon



Light grey / Açık gri



Dark greige / Koyu grej



Dark grey / Koyu gri



Wall tiles / Duvar karoları :  
K947184R0001VTET 80x80 Ceppostone Mink/Vizon  
Floor porcelain tiles / Yer porselen karoları :  
K950607R0001VTET 80x80 Urban Travertino Mink / Vizon



# Urban Travertino



60x120 Light grey / Açık gri

240x120 5 Canvases / Kanvas (14,4 m<sup>2</sup>)



60x120 Dark grey / Koyu gri

240x120 5 Canvases / Kanvas (14,4 m<sup>2</sup>)

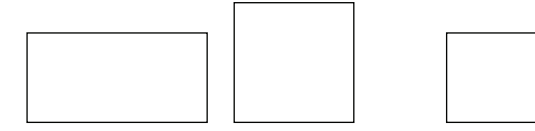

Colorbody porcelain Colorbody porselen	Surface Yüzey	Thickness Kalınlık	60x120 (24"x48") R 597x1197	80x80 (32"x32") R 797x797	60x60 (24"x24") R 597x597
Mink Vizon	R10A	9 mm	K950631R0001VTSP	K950607R0001VTET	K950604R0001VTE0
Dark greige Koyu grej	R10A	9 mm	K950632R0001VTSP	K950608R0001VTET	K950682R0001VTE0
Light grey Açık gri	R10A	9 mm	K950629R0001VTSP	K950605R0001VTET	K950609R0001VTE0
Dark grey Koyu gri	R10A	9 mm	K950630R0001VTSP	K950606R0001VTET	K950610R0001VTE0

Sizes Ebatlar	Thickness Kalınlık (mm)	Box Kutu			Pallet Palet		
		Pcs Adet	m <sup>2</sup>	kg	Box Kutu	m <sup>2</sup>	kg
Colorbody porcelain / Colorbody porselen							
60x120 Rectified / Rektifiyeli	9	2	1,44	29,52	36	51,84	1.098
80x80 Rectified / Rektifiyeli	9	2	1,28	24,50	44	56,32	1.103
60x60 Rectified / Rektifiyeli	9	4	1,44	24,48	32	46,08	808



# Marmostone

Marmostone porcelain collection leverages the veined structure of marble on a natural stone texture and creates a hybrid surface effect. The collection comes in two different surface options; one in matt with a dominant natural stone character, other in glossy with a marble effect. Inspired by the well-known white veined marble; the Amazing Grey marble of Italy, the collection offers a variety of size and natural colour options both for indoor and outdoor use.

Marmostone porselen koleksiyonu, doğal taş görünümüyle mermerin damarlı yapısını hibrit yüzey dokusunda bir araya getiriyor. Mat ve parlak olmak üzere iki farklı yüzeye sahip olan Marmostone Koleksiyonu'nda mat yüzey ile doğal taş karakteri daha baskın hale gelirken, parlak yüzey ile ise mermer etkisi artıyor. Mermerdeki ilhamını ince beyaz damarlı yapısıyla İtalya'nın meşhur Amazing Gri mermerinden alan, doğal renk tonlarıyla hem iç hem de dış mekân kullanımına uygun seçeneklere sahip koleksiyonda; farklı ebat ve renk seçenekleri bulunuyor.

## Compatible collections / Uyumlu koleksiyonlar

Ceppostone	Metalcrete
Urban Travertino	Craft
Urbancrete	mode
Urbanwood	miniworx

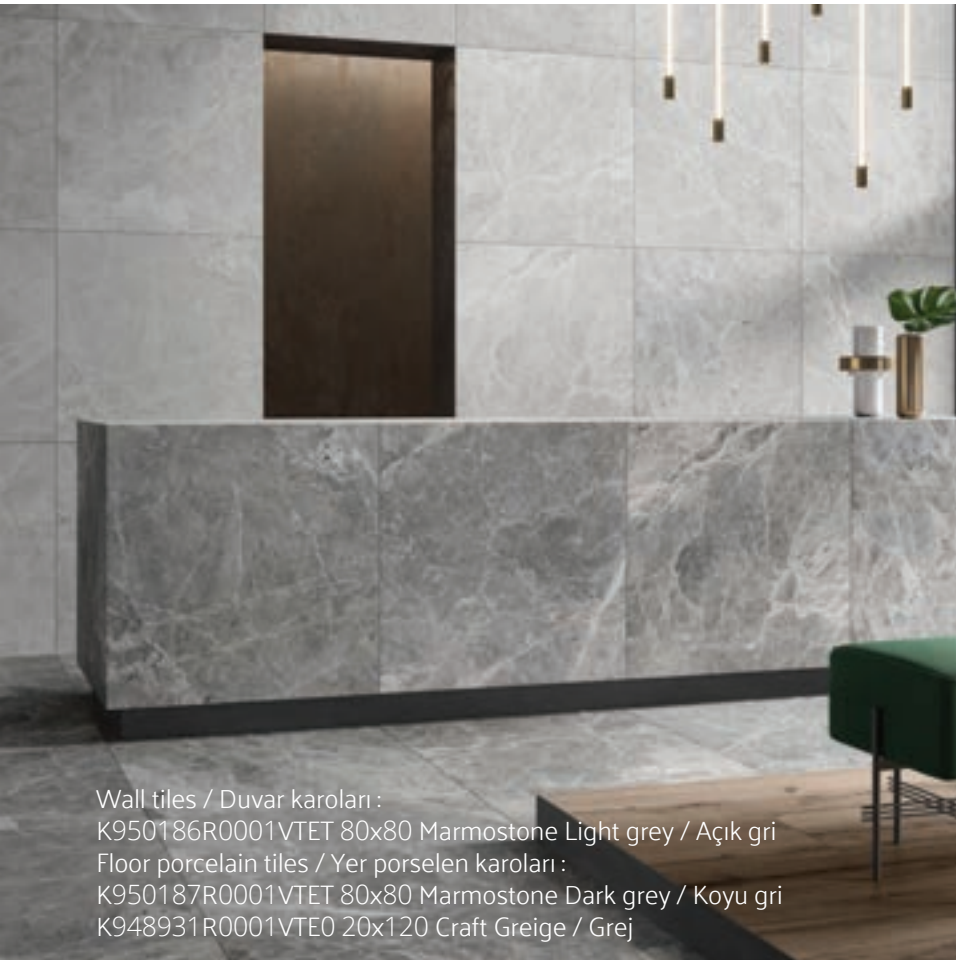

Wall tiles / Duvar karoları :  
K950186R0001VTET 80x80 Marmostone Light grey / Açık gri  
Floor porcelain tiles / Yer porselen karoları :  
K950187R0001VTET 80x80 Marmostone Dark grey / Koyu gri  
K948931R0001VTE0 20x120 Craft Greige / Grej



Wall tiles / Duvar karoları :  
K9504938R001VTE0 30x60 Marmostone Cut decor, light grey / Kesme dekor, açık gri  
Floor porcelain tiles / Yer porselen karoları :  
K950613R0001VTSP 60x120 Marmostone Light grey / Açık gri



# Marmostone

Colorbody porcelain  
Colorbody porselen



**Product standard / Ürün standardı**  
EN14411 Group Bla

**Footnotes / Dip notlar**  
F H R

## Base Tiles / Fonlar



Mink / Vizon

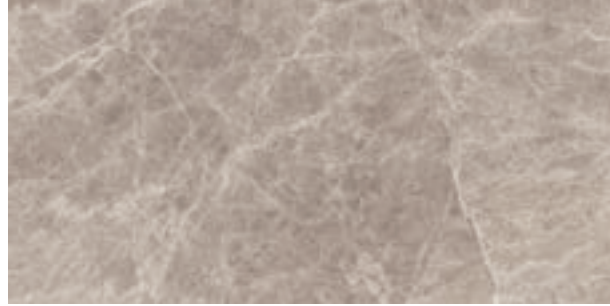

Dark greige / Koyu grej



Light grey / Açık gri

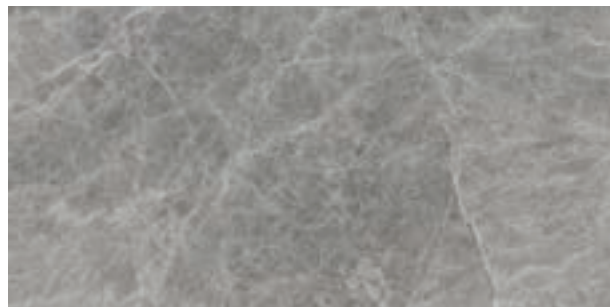

Dark grey / Koyu gri

## Decors / Dekorlar



Cut decor / Kesme dekor  
Mink / Vizon

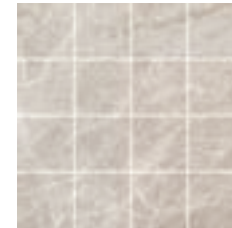

Cut decor / Kesme dekor  
Mink / Vizon



Plinth / Süpügelik  
Mink / Vizon

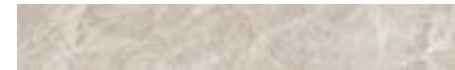

Plinth / Süpügelik  
Mink / Vizon

\* 30x60 cut decors come out of the box in 2 different versions with or without profile and with matt & glossy surfaces.  
\* 30x60 ebatlı kesme dekorlar kutudan profilli ve profilsiz 2 farklı versiyonda mat ve parlak yüzeyde karışık çıkmaktadır.



# Marmostone

Glazed porcelain  
Sırlı porselen

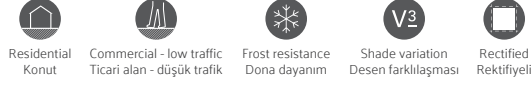

**Product standard / Ürün standardı**  
EN14411 Group Bla

**Footnotes / Dip notlar**  
F H R

## Base Tiles / Fonlar



Mink / Vizon

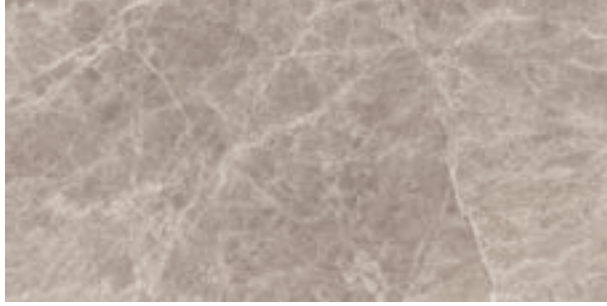

Dark greige / Koyu grej



Light grey / Açık gri



Dark grey / Koyu gri



Floor porcelain tiles / Yer porselen karoları :  
K950189R0001VTET 80x80 Urban Marmostone Dark greige / Koyu grej



# Marmostone



80x80 Light grey / Açık gri

165x87 5 Canvases / Kanvas (7,2 m²)



80x80 Dark grey / Koyu gri

165x87 5 Canvases / Kanvas (7,2 m²)

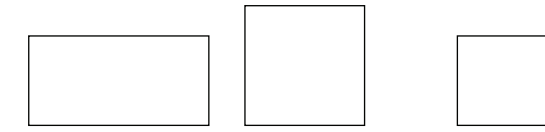

Colorbody porcelain Colorbody porselen	Surface Yüzey	Thickness Kalınlık	60x120 (24"x48") R 597x1197	80x80 (32"x32") R 797x797	60x60 (24"x24") R 597x597
Mink Vizon	R10B	9 mm	K950615R0001VTSP	K950188R0001VTET	K950334R0001VTE0
Dark greige Koyu grej	R10B	9 mm	K950616R0001VTSP	K950189R0001VTET	K950335R0001VTE0
Light grey Açık gri	R10B	9 mm	K950613R0001VTSP	K950186R0001VTET	K950332R0001VTE0
Dark grey Koyu gri	R10B	9 mm	K950614R0001VTSP	K950187R0001VTET	K950333R0001VTE0



Cut decor /  
Kesme dekor



Plinth /  
Süpürgelik



Plinth /  
Süpürgelik



Cut decor /  
Kesme dekor

Decors Dekorlar	Surface Yüzey	Thickness Kalınlık	30x60 (12"x24") R 297x597	10x80 (4"x32") R 97x797	8,5x60 (3,4"x24") R 82x597	7,5x7,5 (3"x3") R 72x72
Mink Vizon	Matt, glossy mix Mat, parlak mix	9 mm	K9504958R001VTE0			
	Matt / Mat	9 mm		K950654R0001VTET	K950352R0001VTE0	
	R10B	9 mm				K9504538R001VTE0
Dark greige Koyu grej	Matt, glossy mix Mat, parlak mix	9 mm	K9504968R001VTE0			
	Matt / Mat	9 mm		K950655R0001VTET	K950353R0001VTE0	
	R10B	9 mm				K9504548R001VTE0
Light grey Açık gri	Matt, glossy mix Mat, parlak mix	9 mm	K9504938R001VTE0			
	Matt / Mat	9 mm		K950652R0001VTET	K950350R0001VTE0	
	R10B	9 mm				K9504518R001VTE0
Dark grey Koyu gri	Matt, glossy mix Mat, parlak mix	9 mm	K9504948R001VTE0			
	Matt / Mat	9 mm		K950653R0001VTET	K950351R0001VTE0	
	R10B	9 mm				K9504528R001VTE0



Glazed porcelain Sırlı porselen	Surface Yüzey	Thickness Kalınlık	60x120 (24"x48") R 597x1197
Mink Vizon	FLPR	9 mm	K950178FLPR1VTSP
Dark greige Koyu grej	FLPR	9 mm	K950179FLPR1VTSP
Light grey Açık gri	FLPR	9 mm	K950176FLPR1VTSP
Dark grey Koyu gri	FLPR	9 mm	K950177FLPR1VTSP



# Marmostone

Sizes Ebatlar	Thickness Kalınlık (mm)	Box Kutu			Pallet Palet		
		Pcs Adet	m <sup>2</sup>	kg	Box Kutu	m <sup>2</sup>	kg
<b>Colorbody porcelain / Colorbody porselen</b>							
60x120 Rectified / Rektifiyeli	9	2	1,44	29,52	36	51,84	1.098
80x80 Rectified / Rektifiyeli	9	2	1,28	24,50	44	56,32	1.103
60x60 Rectified / Rektifiyeli	9	4	1,44	26,5	30	43,20	835
30x60 Decor / Dekor	9	6	1,08	20,25	144	25,92	520
10x80 Plinth / Süpürgelik	9	9	0,72	13,50	40	28,80	550
8,5x60 Plinth / Süpürgelik	9	10	0,51	9,40	98	50,00	950
7,5x7,5 Decor / Dekor	9	8	0,72	12,46	78	56,16	972
<b>Glazed porcelain / Sırlı porselen</b>							
60x120 Rectified / Rektifiyeli	9	2	1,44	30,24	32	46,08	1.005



Wall tiles / Duvar karoları :  
K9504938R001VTE0 30x60 Marmostone Cut decor, light grey / Kesme dekor, açık gri  
Floor porcelain tiles / Yer porselen karoları :  
K950613R0001VTSP 60x120 Marmostone Light grey / Açık gri



# Boscostone

The Boscostone porcelain collection blends the beauty of Italian Fior di Bosco and Spanish Emperador marbles on a matt surface of stone texture. These two marbles, which have been associated with design and quality throughout the ages, are re-interpreted on a natural stone texture to form a bridge between classical Hellenistic style and contemporary modern designs.

Boscostone porselen koleksiyonu, İtalyan Fior di Bosco ve İspanyol Emperador mermerlerinin estetik güzelliğini doğal taşın mat yüzey dokusuna yansıtıyor. Çağlar boyunca isimleri tasarım ve kalite ile özdeşen bu iki mermer, Helenistik dönemin klasik çizgileri ile günümüzün modern tasarımları arasında bağ kuran bir tasarım anlayışı ile taş dokusunda yeniden yorumlanıyor.

## Compatible collections / Uyumlu koleksiyonlar

Oakland  
Urbancrete



Wall tiles / Duvar karoları :  
K950384R0001VTE0 30x60 Boscostone Cream / Krem  
Floor porcelain tiles / Yer porselen karoları :  
K950384R0001VTE0 60x60 Boscostone Cream / Krem



Wall tiles / Duvar karoları :  
K950385R0001VTE0 30x60 Boscostone Anthracite / Antrasit  
Floor porcelain tiles / Yer porselen karoları :  
K950382R0001VTE0 60x60 Boscostone Grey / Gri



# Boscostone

Colorbody porcelain  
Colorbody porselen

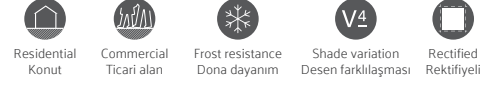

**Product standard / Ürün standardı**  
EN14411 Group Bla

**Footnotes / Dip notlar**  
F H R



Cream / Krem



Grey / Gri



Mink / Vizon



Anthracite / Antrasit



Wall tiles / Duvar karoları :  
K950386R0001VTE0 30x60 Boscostone Grey / Gri  
Floor porcelain tiles / Yer porselen karoları :  
K950381R0001VTE0 60x60 Boscostone Anthracite / Antrasit



# Boscostone



60x60 Cream / Krem





165x88 5 Canvases / Kanvas (7,2 m<sup>2</sup>)



80x80 Dark grey / Koyu gri

165x88 5 Canvases / Kanvas (7,2 m<sup>2</sup>)



Colorbody porcelain Colorbody porselen	Surface Yüzeý	Thickness Kalınlık	60x60 (24"x24") R 597x597	30x60 (12"x24") R 297x597
 Cream Krem	R10B	9 mm	K950384R0001VTE0	K950388R0001VTE0
 Mink Vizon	R10B	9 mm	K950383R0001VTE0	K950387R0001VTE0
 Grey Gri	R10B	9 mm	K950382R0001VTE0	K950386R0001VTE0
 Anthracite Antrasit	R10B	9 mm	K950381R0001VTE0	K950385R0001VTE0

Sizes Ebatlar	Thickness Kalınlık (mm)	Box Kutu			Pallet Palet		
		Pcs Adet	m <sup>2</sup>	kg	Box Kutu	m <sup>2</sup>	kg
<b>Colorbody porcelain / Colorbody porselen</b>							
60x60 Rectified / Rektifiyeli	9	4	1,44	27,04	30	43,20	836
30x60 Rectified / Rektifiyeli	9	6	1,08	19,76	40	43,20	816



Wall tiles / Duvar karoları :  
K950384R0001VTE0 30x60 Boscostone Cream / Krem  
Floor porcelain tiles / Yer porselen karoları :  
K950384R0001VTE0 60x60 Boscostone Cream / Krem



# Cardostone

A colorbody porcelain collection inspired by the durable Cardoso stone of the Italian Alps. Cardostone offers the quintessential white veins of Cardoso stone in natural grey and anthracite colours as well as in a cooler beige and white colour choices. The relief surface option, which creates the most realistic appearance of the original stone's texture, reflects Cardostone's powerful nature. Highly anti-slip, easy to clean, and available in a thickness particularly suitable for exteriors, Cardostone perfectly complements all contemporary venues.

İtalyan Alpleri'nin sağlam taşı Cardoso'dan esinlenen colorbody porselen koleksiyonu. Cardostone, Cardoso taşının doğal yapısındaki beyaz damarlar, taşın doğal rengi gri ve antrasitin yanında bej ve beyaz renk seçenekleri ile hafif soğuk bir seçki sunuyor. Taş dokusunu en gerçekçi haliyle yansıtan rölyefli yüzey seçeneği ise taşın güçlü doğasını yansıtıyor. Cardostone yüksek kaydırmazlık özelliği, temizlenme kolaylığı ve iç mekânda yaratılan estetiği dış mekâna taşımaya sağlayan özel kalınlık alternatifleriyle çağdaş mekânlara uyum sağlıyor.



Wall tiles / Duvar karoları :  
K947096R0001VTE0 60x60 Cardostone Anthracite / Antrasit  
K9472758R001VTE0 30x60 Cardostone Multi cut decor, anthracite /  
Multi kesme dekor, antrasit



Wall tiles / Duvar karoları :  
K947414R0001VTSP 60x120 Cardostone Anthracite / Antrasit  
Floor porcelain tiles / Yer porselen karoları :  
K947547R0001VTE1 20mm 60x60 Cardostone Grey / Gri



# Cardostone

Colorbody porcelain  
Colorbody porselen



**Product standard / Ürün standardı**  
EN14411 Group Bla

**Footnotes / Dip notlar**  
F H R

## Base Tiles / Fonlar

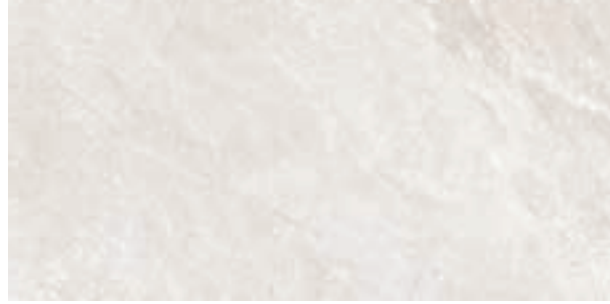

White / Beyaz



Beige / Bej



Grey / Gri



Anthracite / Antrasit

## Decors / Dekorlar

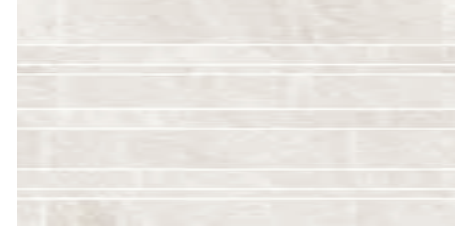

Multi cut decor / Multi kesme dekor  
White / Beyaz



Cut decor / Kesme dekor  
White / Beyaz



Plinth / Süpügelik  
White / Beyaz



Plinth / Süpügelik  
White / Beyaz



# Cardostone



60x120 White / Beyaz

126x88 8 Canvases / Kanvas (8,8 m<sup>2</sup>)



60x120 Anthracite / Antrasit

126x88 8 Canvases / Kanvas (8,8 m<sup>2</sup>)

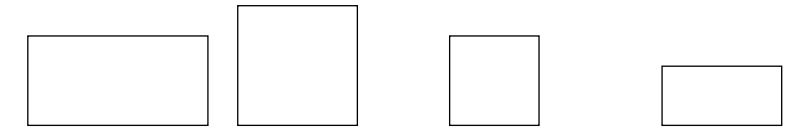

Colorbody porcelain Colorbody porselen	Surface Yüzey	Thickness Kalınlık	60x120 (24"x48") R 597x1197	80x80 (32"x32") R 797x797	60x60 (24"x24") R 597x597	40x80 (16"x32") R 397x797
White Beyaz	R10A	9 mm	K947412R0001VTSP	K947260R0001VTET	K947094R0001VTE0	K947277R0001VTET
	R10B	9 mm			K950857R0001VTE0	
	R11C	9 mm			K947356R0001VTE0	
	R11	20 mm			K947548R0001VTE1	
Beige Bej	R10A	9 mm	K947413R0001VTSP	K947261R0001VTET	K947095R0001VTE0	K947278R0001VTET
	R10B	9 mm			K950854R0001VTE0	
	R11C	9 mm			K947357R0001VTE0	
	R11	20 mm			K947549R0001VTE1	
Grey Gri	R10A	9 mm	K947411R0001VTSP	K947093R0001VTET	K947263R0001VTE0	K947276R0001VTET
	R10B	9 mm			K950855R0001VTE0	
	R11C	9 mm			K947359R0001VTE0	
	R11	20 mm			K947547R0001VTE1	
Anthracite Antrasit	R10A	9 mm	K947414R0001VTSP	K947262R0001VTET	K947096R0001VTE0	K947279R0001VTET
	R10B	9 mm			K950853R0001VTE0	
	R11C	9 mm			K947358R0001VTE0	
	R11	20 mm			K947550R0001VTE1	



Colorbody porcelain Colorbody porselen	Surface Yüzey	Thickness Kalınlık	30x60 (12"x24") R 297x597	30x30 (12"x12") R 297x297
White Beyaz	R10A	9 mm	K949111R0001VTE0	K950864R0001VTE0
	R10B	9 mm	K949969R0001VTE0	K950869R0001VTE0
	R11C	9 mm	K950858R0001VTE0	K950870R0001VTE0
Beige Bej	R10A	9 mm	K949755R0001VTE0	K950865R0001VTE0
	R10B	9 mm	K949967R0001VTE0	K950867R0001VTE0
	R11C	9 mm	K950859R0001VTE0	K950871R0001VTE0
Grey Gri	R10A	9 mm	K949102R0001VTE0	K950862R0001VTE0
	R10B	9 mm	K949968R0001VTE0	K950868R0001VTE0
	R11C	9 mm	K950861R0001VTE0	K950873R0001VTE0
Anthracite Antrasit	R10A	9 mm	K949110R0001VTE0	K950863R0001VTE0
	R10B	9 mm	K949966R0001VTE0	K950866R0001VTE0
	R11C	9 mm	K950860R0001VTE0	K950872R0001VTE0



Decors Dekorlar	Surface Yüzey	Thickness Kalınlık	30x60 (12"x24") R 297x597	5x5 (2"x2") R 47x47	10x80 (4"x32") R 97x797	8,5x60 (3,4"x24") R 82x597
White Beyaz	Matt / Mat	9 mm	K9472698R0001VTE0	K9474078R0001VTE0		
	R10A	9 mm			K947396R0001VTET	K947400R0001VTE1
Beige Bej	Matt / Mat	9 mm	K9472718R0001VTE0	K9474088R0001VTE0		
	R10A	9 mm			K947397R0001VTET	K947401R0001VTE1
Grey Gri	Matt / Mat	9 mm	K9472738R0001VTE0	K9474098R0001VTE0		
	R10A	9 mm			K947395R0001VTET	K947399R0001VTE1
Anthracite Antrasit	Matt / Mat	9 mm	K9472758R0001VTE0	K9474108R0001VTE0		
	R10A	9 mm			K947398R0001VTET	K947402R0001VTE1



# Cardostone

Sizes Ebatlar	Thickness Kalınlık (mm)	Box Kutu			Pallet Palet		
		Pcs Adet	m <sup>2</sup>	kg	Box Kutu	m <sup>2</sup>	kg
Colorbody porcelain / Colorbody porselen							
60x120 Rectified / Rektifiyeli	9	2	1,44	29,52	36	51,84	1.098
80x80 Rectified / Rektifiyeli	9	2	1,28	24,50	44	56,32	1.103
60x60 Rectified / Rektifiyeli	9	4	1,44	26,90	30	43,20	832
60x60 Rectified / Rektifiyeli	20	2	0,72	31,68	30	21,60	975
40x80 Rectified / Rektifiyeli	9	4	1,28	24,06	27	34,56	675
30x60 Rectified / Rektifiyeli	9	6	1,08	18,60	40	43,20	829
30x30 Rectified / Rektifiyeli	9	11	1,00	18,35	60	60,00	1.115
30x60 Multi cut decor / Multi kesme dekor	9	6	1,08	18,36	40	43,20	759
10x80 Plinth / Süpürgelik	9	9	0,72	13,50	40	28,80	550
8.5x60 Plinth / Süpürgelik	9	10	0,51	9,40			
5x5 Cut decor / Kesme dekor	9	8	0,72	12,24	78	56,16	980



Wall tiles / Duvar karoları :  
K947411R0001VTSP 60x120 Cardostone Grey / Gri  
Floor porcelain tiles / Yer porselen karoları :  
K947412R0001VTSP 60x120 Cardostone White / Beyaz



# Ceppostone

A colorbody porcelain collection that interprets the elegant Ceppo di Gré of Italy. Ceppostone reinvents the large, granular texture of Ceppo di Gré, a special stone valued for its beauty and strength since ancient times. The collection brings together the grey and mink of the ColorCode approach with modular sizes and offers a high degree of durability that makes it suitable for all usage conditions.

İtalyan Ceppo di Gré'yi yorumlayan colorbody porselen koleksiyonu. Ceppostone, antik çağlardan bugüne iri taneli çakıl taşı dokusuyla karakteristik bir kullanım sağlayan özel taşı yeninden yorumluyor. ColorCode yaklaşımındaki gri ve vizonu, modüler ebatlarla bir araya getiren koleksiyon, colorbody bünyesinin dayanıklılığı sayesinde tüm kullanım koşullarına uyum sağlıyor.

## Compatible collections / Uyumlu koleksiyonlar

Urban Travertino    Metalcrete  
Urbancrete        mode  
Urbanwood        miniworx



Wall tiles / Duvar karoları :  
K947430R0001VTSP 60x120 Ceppostone Mink / Vizon  
Floor porcelain tiles / Yer porselen karoları :  
K947488R0001VTE0 20x120 Urbanwood Mink / Vizon



Wall tiles / Duvar karoları :  
K947434R0001VTSP 60x120 Ceppostone Grey / Gri  
K947186R0001VTE0 60x60 Urbancrete Grey / Gri  
Floor porcelain tiles / Yer porselen karoları :  
K947485R0001VTE0 20x120 Urbanwood Grey / Gri



# Ceppostone

Colorbody porcelain  
Colorbody porselen

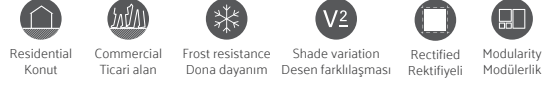

**Product standard / Ürün standardı**  
EN14411 Group Bla

**Footnotes / Dip notlar**  
F H R

## Base Tiles / Fonlar

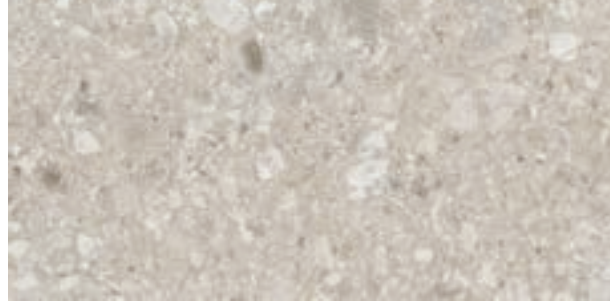

Mink / Vizon



Dark greige / Koyu grej



Grey / Gri



Dark grey / Koyu gri

## Decors / Dekorlar



Multi cut decor / Multi kesme dekor  
Mink / Vizon



Cut decor / Kesme dekor  
Mink / Vizon



Plinth / Süpügelik  
Mink / Vizon



# Ceppostone



80x80 Grey / Gri

11 Faces / Yüzey görünümü (88x88)



80x80 Dark grey / Koyu gri

11 Faces / Yüzey görünümü (88x88)

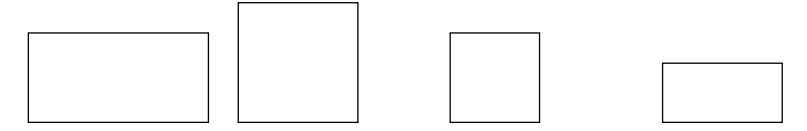

Colorbody porcelain Colorbody porselen	Surface Yüzey	Thickness Kalınlık	60x120 (24"x48") R 597x1197	80x80 (32"x32") R 797x797	60x60 (24"x24") R 597x597	40x80 (16"x32") R 397x797
Mink Vizon	R9	9 mm	K947430R0001VTSP	K947184R0001VTET	K947307R0001VTE0	K947192R0001VTET
	R11C	9 mm			K947361R0001VTE0	
	R11	20 mm			K947470R0001VTE1	
Dark greige Koyu grej	R9	9 mm	K947520R0001VTSP	K947464R0001VTET	K947320R0001VTE0	K947506R0001VTET
	R11C	9 mm			K947522R0001VTE0	
	R11	20 mm			K947523R0001VTE1	
Grey Gri	R9	9 mm	K947434R0001VTSP	K947198R0001VTET	K947316R0001VTE0	K947204R0001VTET
	R11C	9 mm			K947363R0001VTE0	
	R11	20 mm			K947472R0001VTE1	
Dark grey Koyu gri	R9	9 mm	K947521R0001VTSP	K947463R0001VTET	K947524R0001VTE0	K947507R0001VTET
	R11C	9 mm			K947362R0001VTE0	
	R11	20 mm			K947471R0001VTE1	

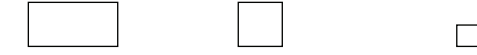

Colorbody porcelain Colorbody porselen	Surface Yüzey	Thickness Kalınlık	30x60 (12"x24") R 297x597	30x30 (12"x12") R 297x297	15x15 (6"x6") R 147x147
Mink Vizon	R9	9 mm	K948561R0001VTE0	K948565R0001VTE0	K949115R0001VTE0
Dark greige Koyu grej	R9	9 mm	K948558R0001VTE0	K948560R0001VTE0	K949247R0001VTE0
Grey Gri	R9	9 mm	K948562R0001VTE0	K948564R0001VTE0	K949116R0001VTE0
Dark grey Koyu gri	R9	9 mm	K948559R0001VTE0	K948563R0001VTE0	K949248R0001VTE0



Decors Dekorlar	Surface Yüzey	Thickness Kalınlık	30x60 (12"x24") R 297x597	5x5 (2"x2") R 47x47	10x80 (4"x32") R 97x797	8,5x60 (3,4"x24") R 84x597
Mink Vizon	R9	9 mm	K9473118R001VTE0	K9474298R001VTE0	K947427R0001VTET	K947428R0001VTE1
Dark greige Koyu grej	R9	9 mm	K9474978R001VTE0	K9475128R001VTE0	K947483R0001VTET	K947528R0001VTE1
Light grey Açık gri	R9	9 mm	K9473188R001VTE0	K9474338R001VTE0	K947431R0001VTET	K947432R0001VTE1
Dark grey Koyu gri	R9	9 mm	K9474988R001VTE0	K9475138R001VTE0	K947484R0001VTET	K947529R0001VTE1



# Ceppostone

Sizes Ebatlar	Thickness Kalınlık (mm)	Box Kutu			Pallet Palet		
		Pcs Adet	m <sup>2</sup>	kg	Box Kutu	m <sup>2</sup>	kg
Colorbody porcelain / Colorbody porselen							
60x120 Rectified / Rektifiyeli	9	2	1,44	29,52	36	51,84	1.098
80x80 Rectified / Rektifiyeli	9	2	1,28	24,50	44	56,32	1.103
60x60 Rectified / Rektifiyeli	20	2	0,72	31,68	30	21,60	975
60x60 Rectified / Rektifiyeli	9	4	1,44	26,90	30	43,20	832
40x80 Rectified / Rektifiyeli	9	4	1,28	24,06	27	34,56	675
30x60 Rectified / Rektifiyeli	9	6	1,08	20,10	40	43,20	829
30x30 Rectified / Rektifiyeli	9	11	1,00	16,14	60	60,00	993
15x15 Rectified / Rektifiyeli	9	29	0,65	11,96	80	52,00	980
10x80 Plinth / Süpürgelik	9	9	0,72	13,50	40	28,80	550
8.5x60 Plinth / Süpürgelik	9	10	0,51	9,40			
5x5 Cut decor / Kesme dekor	9	8	0,72	12,24	78	56,16	980



Wall tiles / Duvar karoları :  
K9473188R001VTE0 30x60 Ceppostone Grey / Gri Multi cut border / Multi kesme bordür  
Floor porcelain tiles / Yer porselen karoları :  
K947198R0001VTET 80x80 Ceppostone Grey / Gri



# Stonelevel

A colorbody porcelain collection combining the look and feel of concrete and stone. Stonelevel merges the granulated structure of natural stone into the texture of exposed concrete and adds warm natural colours to create a one-of-a-kind natural stone collection. The collection's modular sizes and decorative tiles with organic relief patterns can be mixed and matched to create a wide variety of tiling solutions.

Beton ve taşı bir yüzde birleştiren colorbody porselen koleksiyonu. Stonelevel, doğal taşın tanecikli yapısı ve brüt beton dokusunu, doğal sıcak tonlarla buluşturarak diğer doğal taş görünümlü koleksiyonlardan ayırıyor. Modüler ebatları ve organik çizgilerden oluşan rölyef dekorlarıyla Stonelevel, döşeme çeşitliliğine imkân tanıyor.

## Compatible collections / Uyumlu koleksiyonlar

Urbancrete  
Mode #02



Wall tiles / Duvar karoları :  
K947292R0001VTET 40x80 Stonelevel 3D relief / 3D rölyef Basalt / Bazalt  
Floor porcelain tiles / Yer porselen karoları :  
K947282R0001VTET 80x80 Stonelevel Basalt / Bazalt



Wall tiles / Duvar karoları :  
K947285R0001VTET 40x80 Stonelevel Greige / Grej  
Floor porcelain tiles / Yer porselen karoları :  
K947281R0001VTET 80x80 Stonelevel Ivory / Fildişi



# Stonelevel

Colorbody porcelain  
Colorbody porselen



**Product standard / Ürün standardı**  
EN14411 Group Bla

**Footnotes / Dip notlar**  
F H R

## Base Tiles / Fonlar

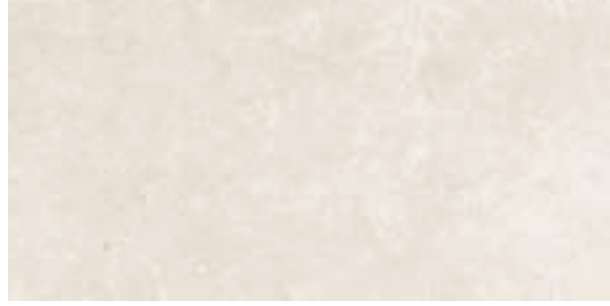

Ivory / Fildişi

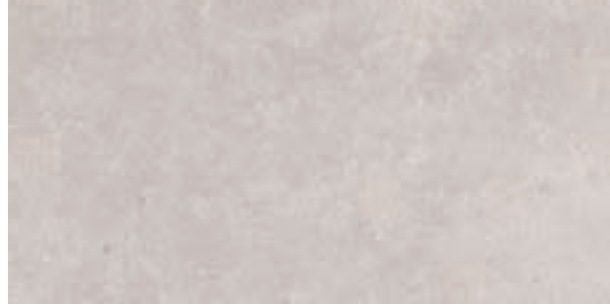

Greige / Grej

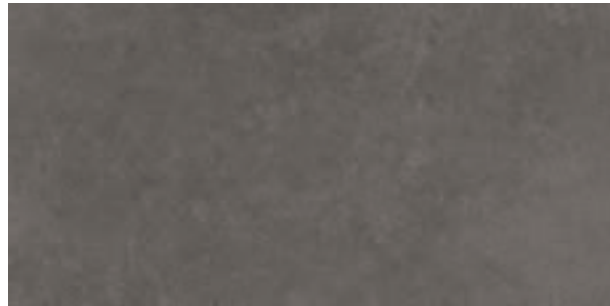

Basalt / Bazalt

## Decors / Dekorlar



3D relief / 3D rölyef  
Ivory / Fildişi



3D relief / 3D rölyef  
Greige / Grej



3D relief / 3D rölyef  
Basalt / Bazalt



Slim cut decor / Slim kesme dekor  
Basalt / Bazalt



Plinth / Süpürgelik  
Basalt / Bazalt

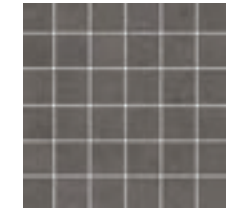

Cut decor / Kesme dekor  
Basalt / Bazalt

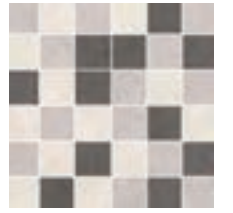

Cut decor mix / Kesme dekor mix

## Wall tiles Duvar karoları



**Product standard / Ürün standardı**  
EN14411 Group Bill

**Footnotes / Dip notlar**  
H R

## Base Tiles / Fonlar

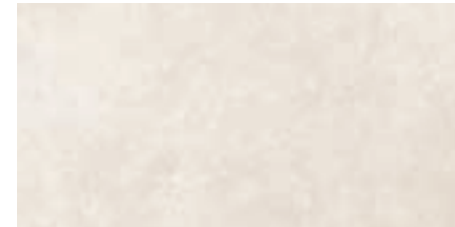

Cream / Krem



# Stonelevel



80x80 Cream / Krem

9 Faces / Yüzey görünümü (88x88)

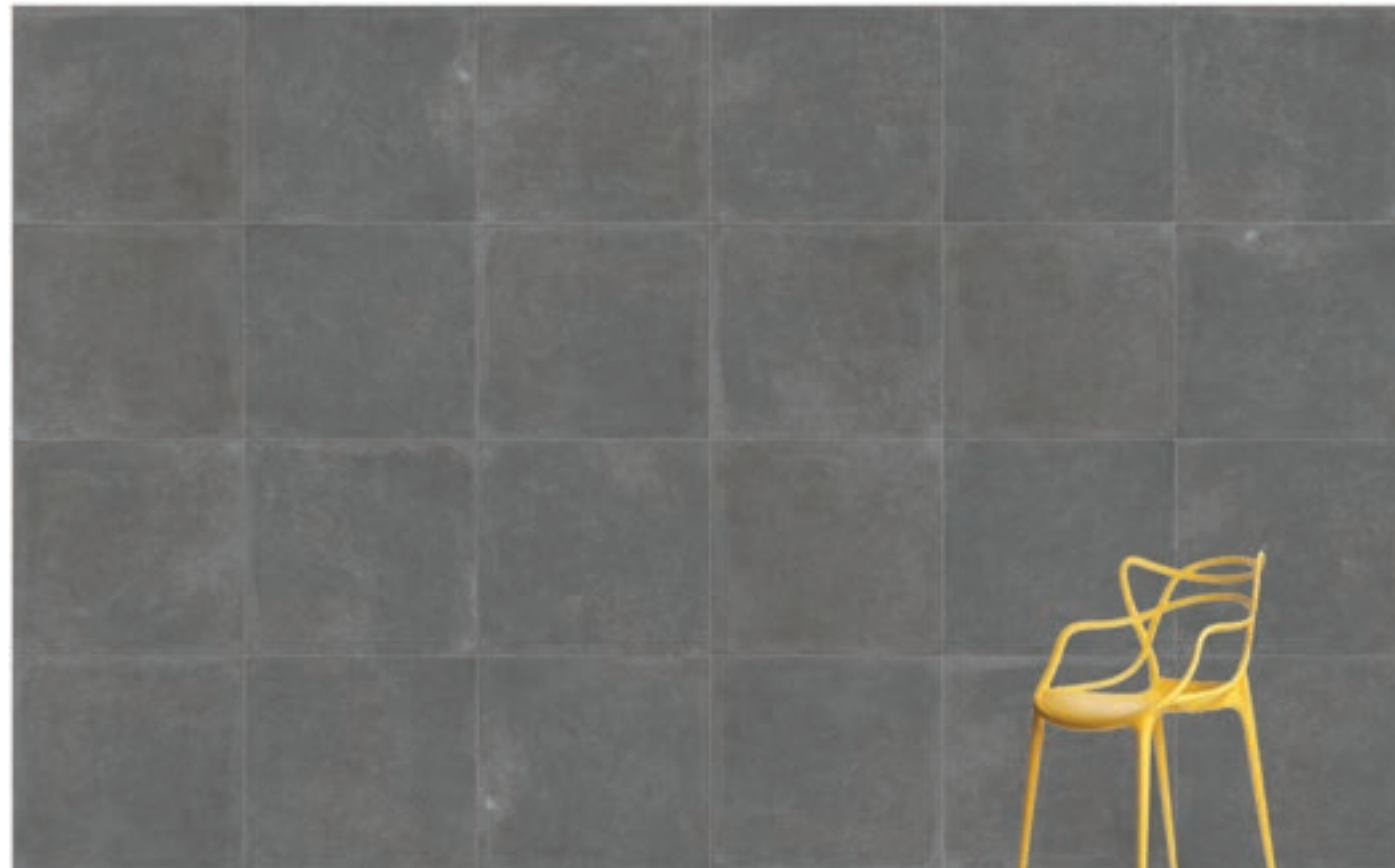

80x80 Basalt / Bazalt

9 Faces / Yüzey görünümü (88x88)

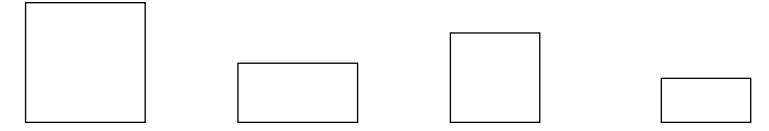

Colorbody porcelain Colorbody porselen	Surface Yüzey	Thickness Kalınlık	80x80 (32"x32") R 797x797	40x80 (16"x32") R 397x797	60x60 (24"x24") R 597x597	30x60 (12"x24") R 297x597
Ivory Fildişi	R9 LPR	9 mm	K947281LPR01VTET	K947287LPR01VTET	K947099LPR01VTE0	K947804LPR01VTE0
	R10A	9 mm	K947281R0001VTET	K947287R0001VTET	K947099R0001VTE0	K947295R0001VTE0
Greige Grej	R9 LPR	9 mm	K947097LPR01VTET	K947285LPR01VTET	K947293LPR01VTE0	K947803LPR01VTE0
	R10A	9 mm	K947097R0001VTET	K947285R0001VTET	K947293R0001VTE0	K947415R0001VTE0
Basalt Bazalt	R9 LPR	9 mm	K947282LPR01VTET	K947288LPR01VTET	K947100LPR01VTE0	K947802LPR01VTE0
	R10A	9 mm	K947282R0001VTET	K947288R0001VTET	K947100R0001VTE0	K947296R0001VTE0



Decors Dekorlar	Surface Yüzey	Thickness Kalınlık	40x80 (16"x32") R 397x797	10x80 (4"x32") R 97x797	8,5x60 (3,4"x24") R 82x597	5x15
Ivory Fildişi	Matt / Mat	9 mm	K947291R0001VTET	K947420R0001VTET	K947416R0001VTE1	
	R10A	9 mm				K9473708R001VTE0
Greige Grej	Matt / Mat	9 mm	K947289R0001VTET	K947419R0001VTET	K947418R0001VTE1	
	R10A	9 mm				K9473668R001VTE0
Basalt Bazalt	Matt / Mat	9 mm	K947292R0001VTET	K947421R0001VTET	K947417R0001VTE1	
	R10A	9 mm				K9475058R001VTE0



Decors Dekorlar	Surface Yüzey	Thickness Kalınlık	5x5 (2"x2") R 47x47
Ivory Fildişi	Matt / Mat	9 mm	K9475188R001VTE0
Greige Grej	Matt / Mat	9 mm	K9475198R001VTE0
Basalt Bazalt	Matt / Mat	9 mm	K9475178R001VTE0
Mix Mix	Matt / Mat	9 mm	K9474268R001VTE0



Wall tiles Duvar	Surface Yüzey	Thickness Kalınlık	30x60 (12"x24") R 297x597
White Beyaz	Matt / Mat	9	K94771200001VTE0



# Stonelevel

Sizes Ebatlar	Thickness Kalınlık (mm)	Box Kutu			Pallet Palet		
		Pcs Adet	m <sup>2</sup>	kg	Box Kutu	m <sup>2</sup>	kg
<b>Colorbody porcelain / Colorbody porselen</b>							
80x80 Rectified / Rektifiyeli	9	2	1,28	24,50	44	56,32	1.103
60x60 Rectified / Rektifiyeli	9	4	1,44	26,90	30	43,20	832
40x80 Rectified / Rektifiyeli	9	4	1,28	24,06	27	34,56	675
30x60 Rectified / Rektifiyeli	9	6	1,08	20,13	40	43,20	830
10x80 Plinth / Süpürgelik	9	9	0,72	13,50	40	28,80	550
8,5x60 Plinth / Süpürgelik	9	10	0,51	9,40	98	50,00	950
5x15 Slim cut decor / Slim kesme dekor	9	20	0,72	13,40	42	30,24	588
5x5 Cut decor / Kesme dekor	9	8	0,72	12,24	78	56,16	980
<b>Wall tiles / Duvar karoları</b>							
30x60 Non-rectified / Rektifiyesiz	9	6	1,08	15,93	48	51,84	790



Wall tiles / Duvar karoları :  
K947285R0001VTET 40x80 Stonelevel Greige / Grej  
Floor porcelain tiles / Yer porselen karoları :  
K947281R0001VTET 80x80 Stonelevel Ivory / Fildişi



# Tech-Slate

A stone textured ceramic tiles collection offering the opportunity to use rich shades of anthracite and gray with striking surface textures. The collection is also enriched with shapes and diagonal cuts inspired by the natural look of ardesia stone.

Zengin antrasit ve gri renk tonlarını çarpıcı yüzey dokuları ile birlikte kullanma fırsatları sunan taş dokulu seramik serisi. Koleksiyon aynı zamanda Ardesia taşının doğal görünümünden ilham alan farklı yüzey ve kesimde dekorlarla zenginleştirilmiştir.

## Compatible collections / Uyumlu koleksiyonlar

Futura  
Plain Colors



Wall tiles / Duvar karoları :  
K944554R0001VTS1 45x90 Tech-Slate White / Beyaz



Wall tiles / Duvar karoları :  
K944553R0001VTE0 60x60 Tech-Slate Anthracite / Antrasit  
K944549R0001VTE0 30x60 Tech-Slate Anthracite / Antrasit  
K944893R0001VTE0 60x60 Tech-Slate Hexagon decor, anthracite / Altigen dekor, antrasit  
Floor porcelain tiles / Yer porselen karoları :  
K944552R0001VTE0 60x60 Tech-Slate Dark grey / Koyu gri



# Tech-Slate

Colorbody porcelain  
Colorbody porselen



**Product standard / Ürün standardı**  
EN14411 Group Bla

**Footnotes / Dip notlar**  
H R

## Base Tiles / Fonlar



White / Beyaz



Dark grey / Koyu gri

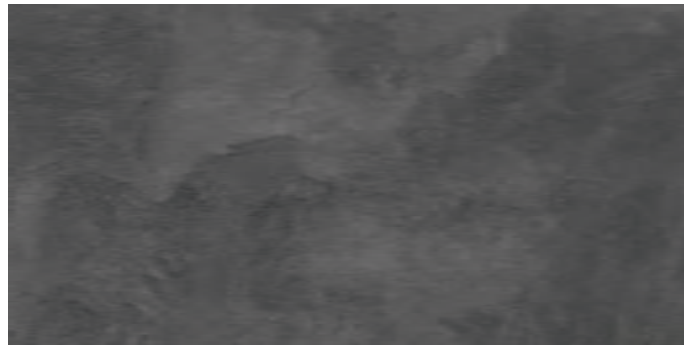

Anthracite / Antrasit

## Decors / Dekorlar



Hexagon decor / Altigen dekor  
White / Beyaz



Cut decor / Kesme dekor  
White / Beyaz

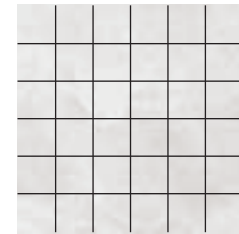

Cut mosaic / Kesme mozaik  
White / Beyaz



# Tech-Slate



45x90 White / Beyaz

132x66 9 Canvases / Kanvas (7,84 m<sup>2</sup>)



45x90 Dark grey / Koyu gri

132x66 9 Canvases / Kanvas (7,84 m<sup>2</sup>)

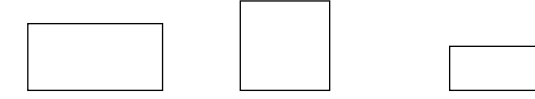

Colorbody porcelain Colorbody porselen	Surface Yüzey	Thickness Kalınlık	45x90 (18"x36") R 447x897	60x60 (24"x24") R 597x597	30x60 (12"x24") R 297x597
White Beyaz	R10A	9 mm		K944550R0001VTE0	K944546R0001VTE0
	R10A	10 mm	K944554R0001VTS1		
Dark grey Koyu gri	R10A	9 mm		K944552R0001VTE0	K944548R0001VTE0
	R10A	10 mm	K944557R0001VTS1		
Anthracite Antrasit	R10A	9 mm		K944553R0001VTE0	K944549R0001VTE0
	R10A	10 mm	K944558R0001VTS1		

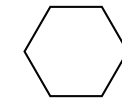

Hexagon decor /  
Altıgen dekor

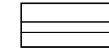

Cut decor /  
Kesme dekor



Cut decor /  
Kesme dekor

Decors Dekorlar	Surface Yüzey	Thickness Kalınlık	60x60 (20"x23") R 51,4x59,4	30x60 (12"x24") R 297x597	5x5 (2"x2") R 47x47
White Beyaz	Matt / Mat	9 mm		K9459508R001VTE0	
	R10A	9 mm	K944891R0001VTE0		
	R10B	9 mm			K9459168R001VTE0
Dark grey Koyu gri	Matt / Mat	9 mm		K9459518R001VTE0	
	R10A	9 mm	K944892R0001VTE0		
	R10B	9 mm			K9459158R001VTE0
Anthracite Antrasit	Matt / Mat	9 mm		K9461938R001VTE0	
	R10A	9 mm	K944893R0001VTE0		
	R10B	9 mm			K9459148R001VTE0

Sizes Ebatlar	Thickness Kalınlık (mm)	Box Kutu			Pallet Palet		
		Pcs Adet	m <sup>2</sup>	kg	Box Kutu	m <sup>2</sup>	kg
<b>Colorbody porcelain / Colorbody porselen</b>							
45x90 Rectified / Rektifiyeli	10	3	1,215	26,55	36	43,74	986
60x60 Rectified / Rektifiyeli	9	4	1,44	26,90	30	43,20	832
30x60 Rectified / Rektifiyeli	9	6	1,08	20,10	40	43,20	829
60x60 Hexagon decor / Altıgen dekor	9	4	0,96	17,76			
30x60 Decor / Dekor	9	6	1,08	22,68	40	43,20	932
5x5 Cut decor / Kesme dekor	9	7	0,63	10,71	78	49,14	860



# British Stone

A colorbody porcelain collection that brings the positive energy and relaxing effect of natural stone to spaces. British Stone creates a powerful effect in spaces by combining natural stone look with natural hues.

Doğal taşın pozitif enerjisini ve rahatlatıcı etkisini mekânlara taşıyan colorbody porselen seramik serisi. British Stone, doğal taş görünümünü doğadan renklerle buluşturarak mekânlarda güçlü bir etki yaratıyor.



Wall tiles / Duvar karoları :  
K94072000001VTE0 30x60 British Stone Light beige / Açık bej  
K94111400001VTE0 30x60 British Stone Relief, light beige / Rölyef, açık bej  
Floor porcelain tiles / Yer porselen karoları :  
K937474R0001VTE0 60x60 British Stone Light beige / Açık bej



Wall tiles / Duvar karoları :  
K944427R0001VTE0 30x60 British Stone White / Beyaz  
Floor porcelain tiles / Yer porselen karoları :  
K944433R0001VTE0 60x60 British Stone White / Beyaz



# British Stone

Colorbody porcelain  
Colorbody porselen

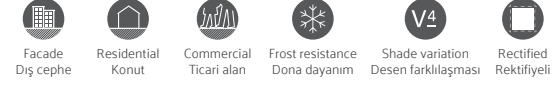

Product standard / Ürün standardı  
EN14411 Group BII

Footnotes / Dip notlar  
H R

## Base Tiles / Fonlar

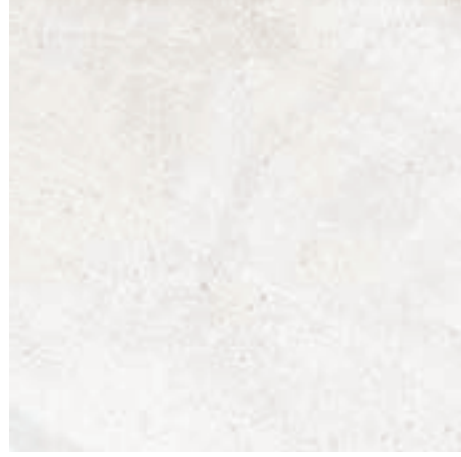

White / Beyaz

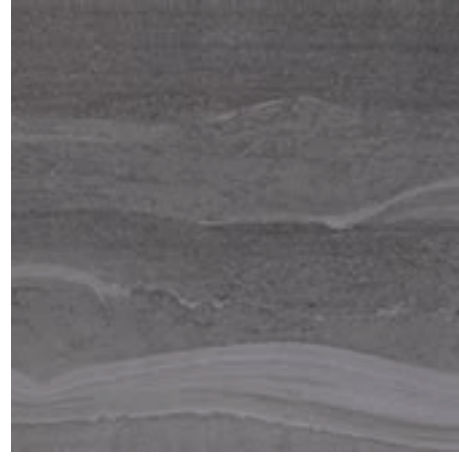

Grey / Gri



Beige / Bej

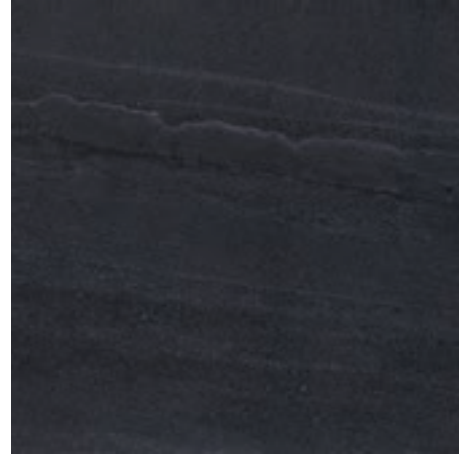

Anthracite / Antrasit

## Decors / Dekorlar



Cut decor / Kesme dekor  
White / Beyaz



Plinth / Süpügelik  
White / Beyaz

Wall tiles  
Duvar karoları



Product standard / Ürün standardı  
EN14411 Group BIII

Footnotes / Dip notlar  
B H R

## Base Tiles / Fonlar



Light beige / Açık bej



Light grey / Açık gri



Anthracite / Antrasit

## Decors / Dekorlar

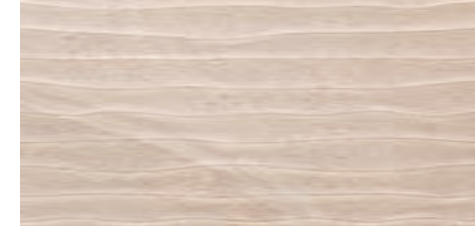

Relief / Rölyef  
Light beige / Açık bej



Relief / Rölyef  
Light grey / Açık gri



Relief / Rölyef  
Anthracite / Antrasit



# British Stone



60x60 Grey / Gri

11 Faces / Yüzey görünümü (132x66)



60x60 Anthracite / Antrasit

11 Faces / Yüzey görünümü (132x66)

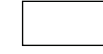

Colorbody porcelain Colorbody porselen	Surface Yüzey	Thickness Kalinlık	60x60 (24"x24") R 597x597	30x60 (12"x24") R 297x597
White Beyaz	LPR	9 mm	K944433LPR01VTE0	K944427LPR01VTE0
	R10A	9 mm	K944433R0001VTE0	K944427R0001VTE0
Beige Bej	LPR	9 mm	K937474LPR01VTE0	K937430LPR01VTE0
	R10A	9 mm	K937474R0001VTE0	K937430R0001VTE0
	R11	20 mm	K943786R0001VTE1	
Grey Gri	LPR	9 mm	K937463LPR01VTE0	K937441LPR01VTE0
	R10A	9 mm	K937463R0001VTE0	K937441R0001VTE0
	R11	20 mm	K943784R0001VTE1	
Anthracite Antrasit	LPR	9 mm	K937264LPR01VTE0	K937452LPR01VTE0
	R10A	9 mm	K937264R0001VTE0	K937452R0001VTE0



Plinth /  
Supürgelik



Cut decor /  
Kesme dekor

Decors Dekorlar	Surface Yüzey	Thickness Kalinlık	8,5x60 (3,4"x24") R 82x597	5x5 (2"x2") R 47x47
White Beyaz	LPR	9 mm	K944696LPR01VTE1	
	LPR	10 mm		K0862208LPR1VTE0
	Matt / Mat	9 mm	K944694R0001VTE1	
	Matt / Mat	10 mm		K0862218R001VTE0
Beige Bej	LPR	9 mm	K942945LPR01VTE1	K0849308LPR1VTE0
	Matt / Mat	9 mm	K934291R0001VTE1	K0849308R001VTE0
Grey Gri	LPR	9 mm	K934302LPR01VTE1	K0849418LPR1VTE0
	Matt / Mat	9 mm	K934302R0001VTE1	K0849418R001VTE0
Anthracite Antrasit	LPR	9 mm	K934313LPR01VTE1	K0849528LPR1VTE0
	Matt / Mat	9 mm	K934313R0001VTE1	K0849528R001VTE0



# British Stone



Wall tiles Duvar karoları	Surface Yüzey	Thickness Kalınlık	30x60 (12"x24") R 297x597
Beige Bej	Matt / Mat	9 mm	K9407200001VTE0
Grey Gri	Matt / Mat	9 mm	K94073100001VTE0
Anthracite Antrasit	Matt / Mat	9 mm	K94074200001VTE0



Relief /  
Rölyef

Decors Dekorlar	Surface Yüzey	Thickness Kalınlık	30x60 (12"x24") R 297x597
Beige Bej	Matt / Mat	9 mm	K94111400001VTE0
Grey Gri	Matt / Mat	9 mm	K94076400001VTE0
Anthracite Antrasit	Matt / Mat	9 mm	K94075300001VTE0

Sizes Ebatlar	Thickness Kalınlık (mm)	Box Kutu			Pallet Palet		
		Pcs Adet	m <sup>2</sup>	kg	Box Kutu	m <sup>2</sup>	kg
<b>Colorbody porcelain / Colorbody porselen</b>							
60x60 Rectified / Rektifiyeli	9	4	1,44	26,90	30	43,20	832
60x60 Rectified / Rektifiyeli	20	2	0,72	31,68	30	21,60	975
30x60 Rectified / Rektifiyeli	9	6	1,08	20,10	40	43,20	829
30x30 Non-rectified / Rektifiyesiz	9	6	1,08	15,93	48	51,84	790
8,5x60 Plinth / Süpürgelik	9	10	0,51	9,40	98	50,00	950
5x5 Cut decor / Kesme dekor	10	7	0,63	10,40	78	49,14	836
5x5 Cut decor / Kesme dekor	9	7	0,63	10,40	78	49,14	836
<b>Wall tiles / Duvar karoları</b>							
30x60 Non-rectified / Rektifiyesiz	9	6	1,08	15,93	48	51,84	790



Wall tiles / Duvar karoları :  
K944427R0001VTE0 30x60 British Stone White / Beyaz  
Floor porcelain tiles / Yer porselen karoları :  
K944433R0001VTE0 60x60 British Stone White / Beyaz



# Lombardy

A natural stone textured ceramic tiles collection, reflecting the everlasting strong character of Italian Alps to the spaces where they are used. The collection offers modern options, for both indoor and outdoor usage with its surface covered with fine veins and allows creative designs on walls and floors.

İtalyan Alpleri'nin yıllara meydan okuyan güçlü karakterini, kullanıldığı mekânlara taşıyan doğal taş dokulu seramik serisi. Yer ve duvar kaplamalarında yaratıcı kullanımlara izin veren seri, ince damarlı yüzeyiyle hem iç hem de dış mekân kullanımları için modern seçenekler sunuyor.

## Compatible collections / Uyumlu koleksiyonlar

Urbancrete



Wall tiles / Duvar karoları :  
K94628000001VTE0 30x60 Lombardy Grey / Gri



Wall tiles / Duvar karoları :  
K94628000001VTE0 30x60 Lombardy Grey / Gri  
Floor porcelain tiles / Yer porselen karoları :  
K946282R0001VTE0 30x60 Lombardy Greige / Grej





# Lombardy

Colorbody porcelain  
Colorbody porselen



**Product standard / Ürün standardı**  
EN14411 Group Bla

**Footnotes / Dip notlar**  
H R

## Base Tiles / Fonlar



Cream / Krem

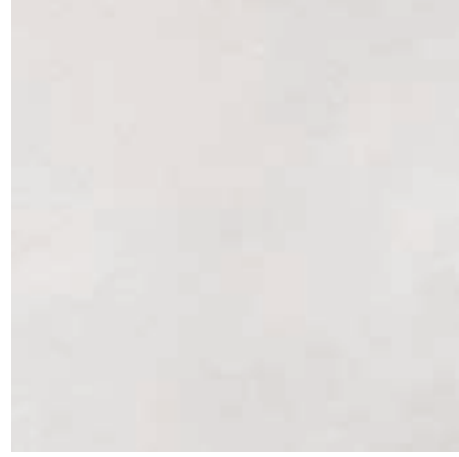

Grey / Gri



Greige / Grej

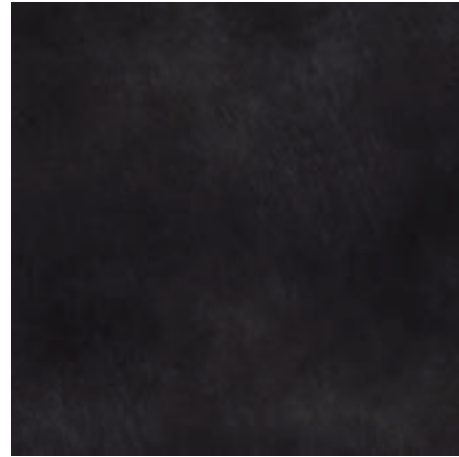

Anthracite / Antrasit

Glazed porcelain  
Sırlı porselen

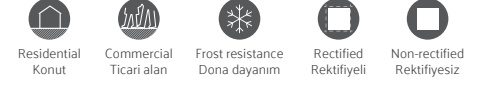

**Product standard / Ürün standardı**  
EN14411 Group Bla

**Footnotes / Dip notlar**  
H R

## Base Tiles / Fonlar



Greige / Grej

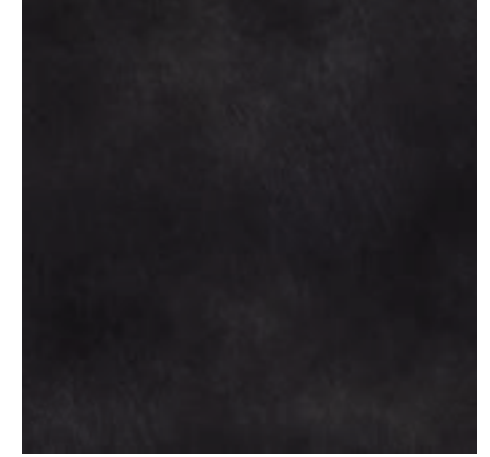

Anthracite / Antrasit

Wall tiles  
Duvar karoları



**Product standard / Ürün standardı**  
EN14411 Group Bill

**Footnotes / Dip notlar**

## Base Tiles / Fonlar



White / Beyaz

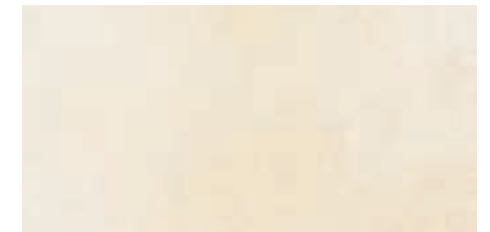

Cream / Krem



# Lombardy

Floor tiles  
Yer karoları



Product standard / Ürün standardı  
EN14411 Group B1b

Footnotes / Dip notlar  
H R

Base Tiles / Fonlar



Cream / Krem

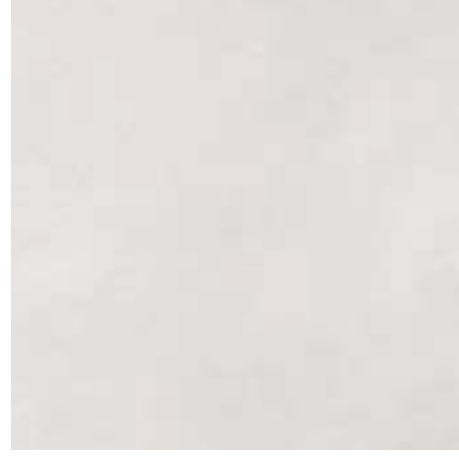

Grey / Gri



Greige / Grej

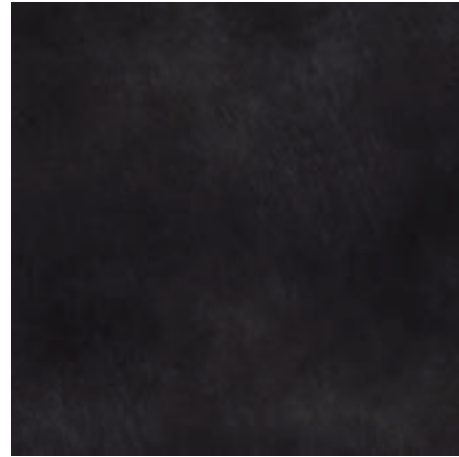

Anthracite / Antrasit



60x60 Grey / Gri

6 Faces / Yüzey görünümü (66x66)

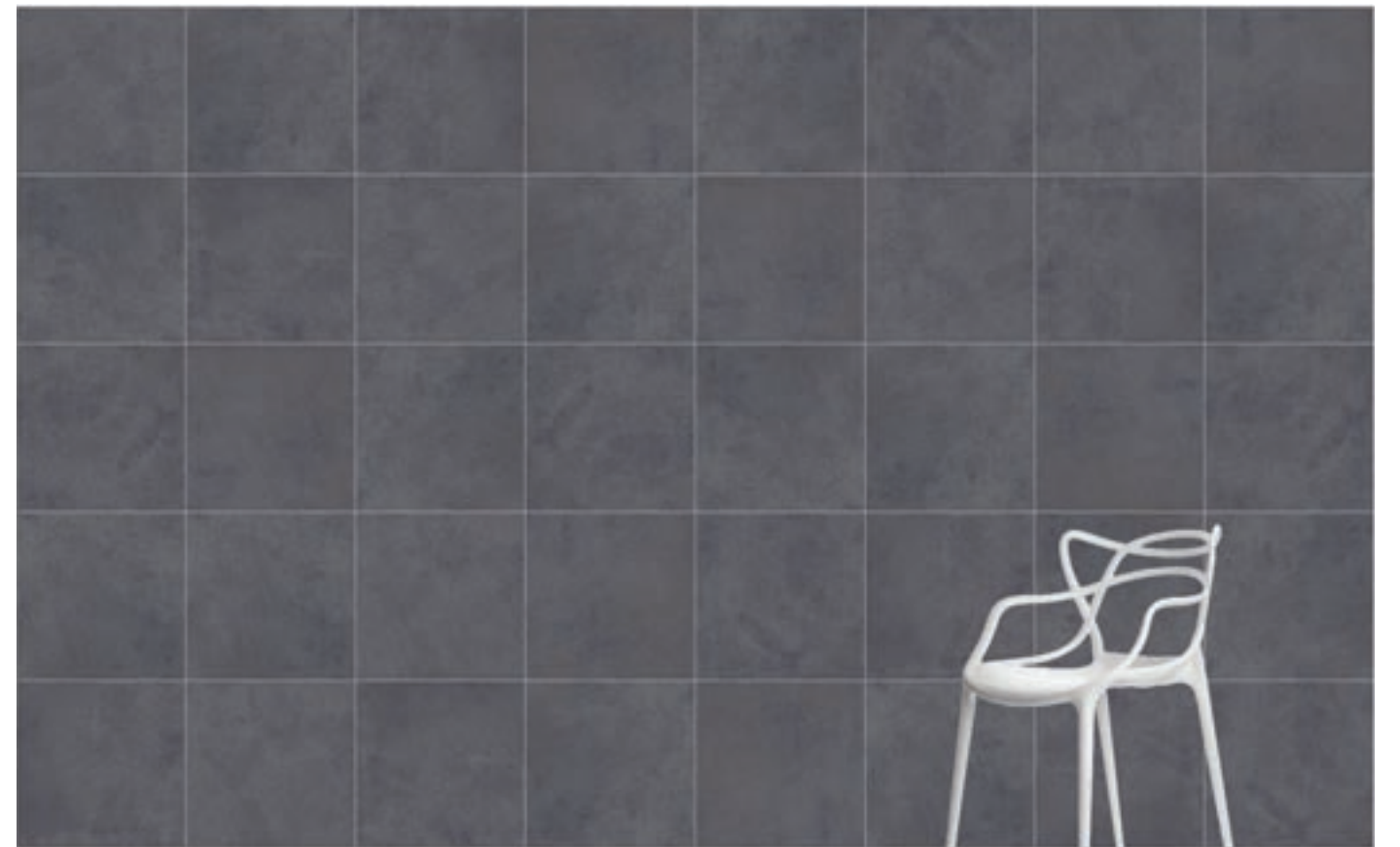

60x60 Anthracite / Antrasit

6 Faces / Yüzey görünümü (66x66)



# Lombardy

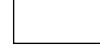

Colorbody porcelain Colorbody porselen		Surface Yüzey	Thickness Kalınlık	60x60 (24"x24") R 597x597	30x60 (12"x24") R 297x597
	Cream Krem	R10B	9 mm	K946285R0001VTE0	K94628100001VTE0
		R10B	9 mm		K946281R0001VTE0
	Greige Grej	R10B	9 mm	K946286R0001VTE0	K94628200001VTE0
		R10B	9 mm		K946282R0001VTE0
	Grey Gri	R10B	9 mm	K946284R0001VTE0	K94628000001VTE0
		R10B	9 mm		K946280R0001VTE0
	Anthracite Antrasit	R10B	9 mm	K946283R0001VTE0	K94627900001VTE0
		R10B	9 mm		K946279R0001VTE0



Glazed porcelain Sırlı porselen		Surface Yüzey	Thickness Kalınlık	45x45 (18"x18") 447x447	
	Grey Gri	R9	9 mm	K94531700001VTE0	
		R10A	9 mm	K94973900001VTE0	
	Anthracite Antrasit	R9	9 mm	K94531400001VTE0	
		R10A	9 mm	K94973800001VTE0	



Wall tiles Duvar karoları		Surface Yüzey	Thickness Kalınlık	30x60 (12"x24") 298x598	
	White Beyaz	Matt / Mat	9 mm	K94772400001VTE0	
		Matt / Mat	9 mm	K94772500001VTE0	



Floor tiles Yer karoları		Surface Yüzey	Thickness Kalınlık	33x33 (13,2"x13,2") 327x327	
	Grey Gri	Matt / Mat	7 mm	K94904800001VTE0	
		R10A	7 mm	K94925300001VTE0	
	Anthracite Antrasit	Matt / Mat	7 mm	K94859300001VTE0	
		R10A	7 mm	K94859400001VTE0	

Sizes Ebatlar	Thickness Kalınlık (mm)	Box Kutu			Pallet Palet		
		Pcs Adet	m <sup>2</sup>	kg	Box Kutu	m <sup>2</sup>	kg
<b>Colorbody porcelain / Colorbody porselen</b>							
30x60 Non-rectified / Rektifiyesiz	9	6	1,08	20,30	40	43,20	837
30x60 Rectified / Rektifiyeli	9	6	1,08	20,10	40	43,20	829
30x60 Rectified / Rektifiyeli	9	4	1,44	26,90	30	43,20	832
<b>Glazed porcelain / Sırlı porselen</b>							
45x45 Non-rectified / Rektifiyesiz	9	7	1,42	26,27	26	36,92	708
<b>Wall tiles / Duvar karoları</b>							
30x60 Non-rectified / Rektifiyesiz	9	6	1,08	15,93	48	51,84	790
<b>Floor tiles / Yer karoları</b>							
33x33 Non-rectified / Rektifiyesiz	7	9	1,00	14,60	74	74,00	1.105



# Meridien

A ceramic series reinterpreting natural stone texture with a modern touch. The collection offers a relaxing atmosphere with timeless cool and calm colours. The series is designed to be used in combination with marble, wood and concrete textured ceramic series.

Doğal taşı modern bir dokunuşla yeniden yorumlayan seramik serisi. Soğuk ve sakin renklerle modası geçmeyecek, rahatlatıcı bir atmosfer sunuyor. Mermer, ahşap ve beton görünümlü seramik serileriyle birlikte kullanılmak için tasarlandı.

## Compatible collections / Uyumlu koleksiyonlar

Urbancrete  
Lombardy



Wall tiles / Duvar karoları :  
K944446R0001VTE0 30x60 Meridien Cream / Krem



Wall tiles / Duvar karoları :  
K944450R0001VTE0 60x60 Meridien Grey / Gri  
K944448R0001VTE0 60x60 Meridien Anthracite / Antrasit  
Floor porcelain tiles / Yer porselen karoları :  
K944448R0001VTE0 60x60 Meridien Anthracite / Antrasit



# Meridien

Glazed porcelain  
Sırlı porselen

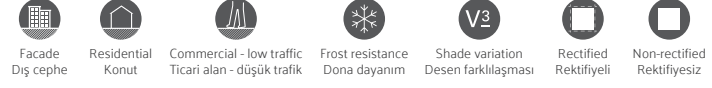

Product standard / Ürün standardı  
EN14411 Group Bla

Footnotes / Dip notlar  
H R

## Base Tiles / Fonlar



Cream / Krem



Grey / Gri



Anthracite / Antrasit

## Decors / Dekorlar



Combi Mosaic / Kombi Mozaik  
Grey / Gri



Cut mosaic / Kesme mozaik  
Grey / Gri



Pressed mosaic / Kalıptan mozaik  
Grey / Gri



60x60 Grey / Gri

132x66 4 Canvases / Kanvas (3,48 m<sup>2</sup>)



60x60 Anthracite / Antrasit

132x66 4 Canvases / Kanvas (3,48 m<sup>2</sup>)



# Meridien

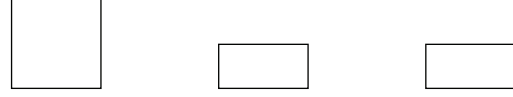

Glazed porcelain Sırlı porselen	Surface Yüzey	Thickness Kalınlık	60x60 (24"x24") R 597x597	30x60 (12"x24") R 297x597	30x60 (12"x24") 297x597
Cream Krem	R10A	9 mm	K944449R0001VTE0	K944446R0001VTE0	K94444600001VTE0
Grey Gri	R10A	9 mm	K944450R0001VTE0	K944447R0001VTE0	K94444700001VTE0
Anthracite Antrasit	R10A	9 mm	K944448R0001VTE0	K944445R0001VTE0	K94444500001VTE0



Cut mosaic /  
Kesme mozaik



Pressed mosaic /  
Kalıptan mozaik

Decors Dekorlar	Surface Yüzey	Thickness Kalınlık	5x5 (2"x2") R 47x47	5x5 (2"x2") R 47x47
Cream Krem	R10B	9 mm	K9463028R001VTE0	
	R10B	6 mm	K94628980001VTE0	
Grey Gri	R10B	9 mm	K9463008R001VTE0	
	R10B	6 mm	K94628780001VTE0	
Anthracite Antrasit	R10B	9 mm	K9463018R001VTE0	
	R10B	6 mm	K94628880001VTE0	

Sizes Ebatlar	Thickness Kalınlık (mm)	Box Kutu			Pallet Palet		
		Pcs Adet	m <sup>2</sup>	kg	Box Kutu	m <sup>2</sup>	kg
<b>Glazed porcelain / Sırlı porselen</b>							
60x60 Rectified / Rektifiyeli	9	4	1,44	26,90	30	43,20	832
30x60 Rectified / Rektifiyeli	9	6	1,08	20,10	40	43,20	829
30x60 Non-rectified / Rektifiyesiz	9	6	1,08	20,30	40	43,20	837
5x5 Cut decor / Kesme dekor	9	7	0,63	10,40	78	49,14	836
<b>Floor tiles / Yer karoları</b>							
5x5 Cut decor / Kesme dekor	6	396	1,00	11,75	78	78,00	942



Wall tiles / Duvar karoları :  
K944450R0001VTE0 60x60 Meridien Grey / Gri  
K944448R0001VTE0 60x60 Meridien Anthracite / Antrasit  
Floor porcelain tiles / Yer porselen karoları :  
K944448R0001VTE0 60x60 Meridien Anthracite / Antrasit



# Pietra Pienza

A ceramic series distinguished with its modern stone outlook and rich surface alternatives derived from state-of-the-art production technologies. Pietra Pienza adds elegance to modern urban life with its natural colours and tones.

Modern taş görünümü ve üretim teknolojisi sayesinde sahip olduğu zengin yüzey alternatifleriyle dikkat çeken seramik serisi. Pietra Pienza, doğal renk ve tonlarıyla modern şehir hayatına şıklık katıyor.



Wall tiles / Duvar karoları :  
K909113R0001VTE0 30x60 Pietra Pienza Cut decor, anthracite / Kesme dekor, antrasit  
Floor porcelain tiles / Yer porselen karoları :  
K909010R0001VTE0 60x60 Pietra Pienza Light grey / Açık gri



Wall tiles / Duvar karoları :  
K909113R0001VTE0 30x60 Pietra Pienza Cut decor, anthracite / Kesme dekor, antrasit  
Floor porcelain tiles / Yer porselen karoları :  
K909010R0001VTE0 60x60 Pietra Pienza Light grey / Açık gri



# Pietra Pienza

Colorbody porcelain  
Colorbody porselen

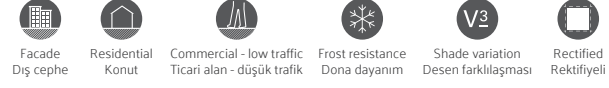

**Product standard / Ürün standardı**  
EN14411 Group Ila

**Footnotes / Dip notlar**  
H R

## Base Tiles / Fonlar

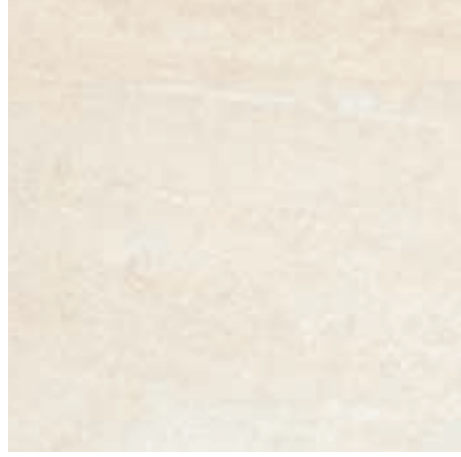

Beige / Bej



Dark grey / Koyu gri



Light grey / Açık gri

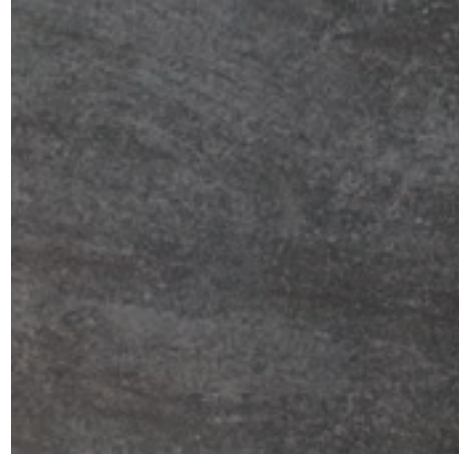

Anthracite / Antrasit



60x60 Light grey / Açık gri

7 Faces / Yüzey görünümü (65x65)

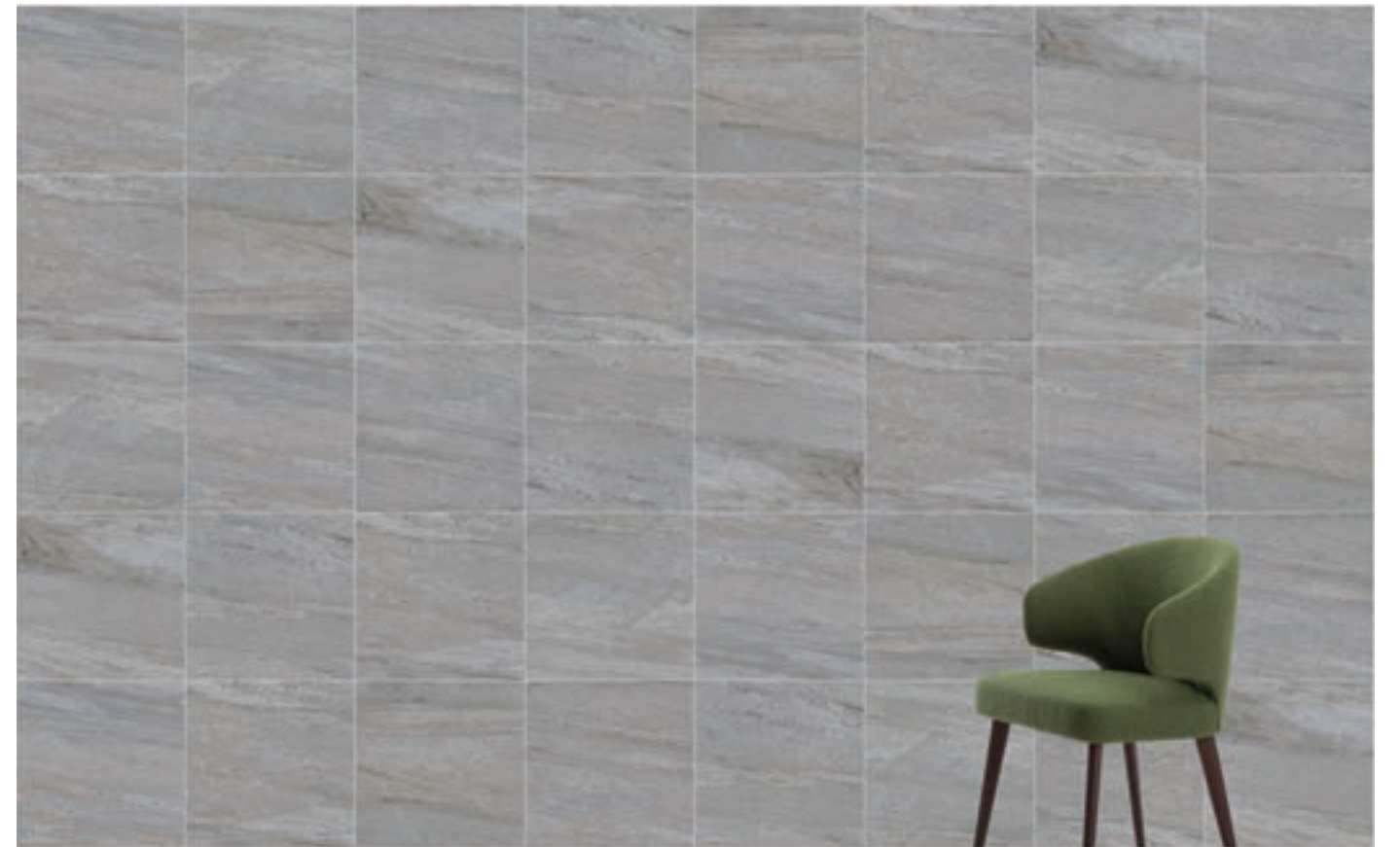

60x60 Dark grey / Koyu gri

7 Faces / Yüzey görünümü (65x65)



# Pietra Pienza



Colorbody porcelain Colorbody porselen	Surface Yüzey	Thickness Kalınlık	60x60 (24"x24") R 597x597	30x60 (12"x24") R 297x597
Beige Bej	R9	9 mm	K909006R0001VTE0	K909080R0001VTE0
Light grey Açık gri	R9	9 mm	K909010R0001VTE0	K909091R0001VTE0
Dark grey Koyu gri	R9	9 mm	K909021R0001VTE0	K909102R0001VTE0
Anthracite Antrasit	R9	9 mm	K909032R0001VTE0	K909113R0001VTE0



Decors Dekorlar	Surface Yüzey	Thickness Kalınlık	8,5x60 (3,4"x24") R 82x597
Beige Bej	R9	9 mm	K909161R0001VTE1
Light grey Açık gri	R9	9 mm	K909172R0001VTE1
Dark grey Koyu gri	R9	9 mm	K909183R0001VTE1
Anthracite Antrasit	R9	9 mm	K909194R0001VTE1

Sizes Ebatlar	Thickness Kalınlık (mm)	Box Kutu			Pallet Palet		
		Pcs Adet	m <sup>2</sup>	kg	Box Kutu	m <sup>2</sup>	kg
Colorbody porcelain / Colorbody porselen							
60x60 Rectified / Rektifiyeli	9	4	1,44	26,90	30	43,20	832
30x60 Rectified / Rektifiyeli	9	6	1,08	20,10	40	43,20	829
8,5x60 Plinth / Süpürgelik	9	10	0,51	9,40	98	50,00	950



Wall tiles / Duvar karoları :  
K909113R0001VTE0 30x60 Pietra Pienza Cut decor, anthracite / Kesme dekor, antrasit  
Floor porcelain tiles / Yer porselen karoları :  
K909010R0001VTE0 60x60 Pietra Pienza Light grey / Açık gri



# Quarzite

Adding positive energy to spaces with the modern interpretation of Quarzite stone, the series addresses individual tastes with contemporary designs. Light and dark grey, beige and anthracite colours offer an ideal solution for both inner and outer spaces.

Quarzite taşının modern yorumuyla mekanlara pozitif enerji katan seri, colorbody porselen çağa uygun tasarımlarıyla her türlü zevke hitap ediyor. Açık ve koyu gri, bej ve antrasit renkleriyle hem iç hem de dış mekânlar için ideal bir çözüm sunuyor.



Floor porcelain tiles / Yer porselen karoları :  
K86442100001VTE0 30x60 Quarzite Beige / Bej



Floor porcelain tiles / Yer porselen karoları :  
K86442100001VTE0 30x60 Quarzite Beige / Bej



# Quarzite

Colorbody porcelain  
Colorbody porselen



**Product standard / Ürün standardı**  
EN14411 Group B1a

**Footnotes / Dip notlar**  
H R

## Base Tiles / Fonlar

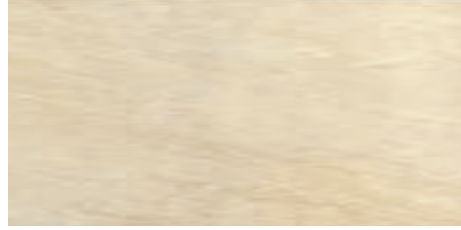

Beige / Bej



Light grey / Açık gri



Dark grey / Koyu gri



Anthracite / Antrasit

## Decors / Dekorlar

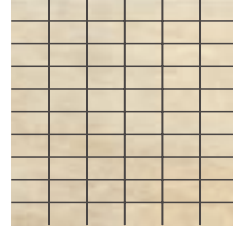

Cut decor / Kesme dekor  
Beige / Bej

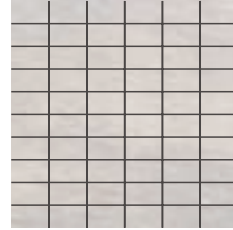

Cut decor / Kesme dekor  
Light grey / Açık gri



Cut decor / Kesme dekor  
Dark grey / Koyu gri



Cut decor / Kesme dekor  
Anthracite / Antrasit



30x60 Light grey / Açık gri

1 Canvases / Kanvas (70x140)



30x60 Dark grey / Koyu gri

1 Canvases / Kanvas (70x140)



# Quarzite

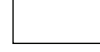

Colorbody porcelain Colorbody porselen	Surface Yüzey	Thickness Kalınlık	30x60 (12"x24") 297x597
Beige Bej	Matt / Mat	9 mm	K86442100001VTE0
Light grey Açık gri	Matt / Mat	9 mm	K86443200001VTE0
Dark grey Koyu gri	Matt / Mat	9 mm	K86681200001VTE0
Anthracite Antrasit	Matt / Mat	9 mm	K86901500001VTE0



Cut decor /  
Kesme dekor

Decors Dekorlar	Surface Yüzey	Thickness Kalınlık	2,5x5 (1"x2") R 22x47
Beige Bej	Matt / Mat	7,5 mm	K05974380001VTE0
Light grey Açık gri	Matt / Mat	7,5 mm	K05975480001VTE0
Dark grey Koyu gri	Matt / Mat	7,5 mm	K05976580001VTE0
Anthracite Antrasit	Matt / Mat	7,5 mm	K05977680001VTE0

Sizes Ebatlar	Thickness Kalınlık (mm)	Box Kutu			Pallet Palet		
		Pcs Adet	m <sup>2</sup>	kg	Box Kutu	m <sup>2</sup>	kg
Colorbody porcelain / Colorbody porselen							
30x60 Non-rectified / Rektifiyesiz	9	6	1,08	20,30	40	43,20	837
2,5x5 Cut decor / Kesme dekor	7,5	8	0,72	10,94	78	56,16	878



Floor porcelain tiles / Yer porselen karoları :  
K86442100001VTE0 30x60 Quarzite Beige / Bej



# Stoneway

A ceramic series combining the relaxing effect of colours and elegance of natural stone that will never be out of fashion. A perfect option for designing plain and timeless spaces, Stoneway is compatible with many wall tile series.

Stoneway Porselen Karo Serisi'nde, renklerin sakinleştirici etkisiyle doğal taşın modası geçmeyecek şıklığı birleşiyor. Sade ve zamana karşı duran mekânlar tasarlamak için mükemmel bir seçim olan Stoneway; birçok duvar karosu serisiyle ideal bir uyum oluşturuyor.



Floor porcelain tiles / Duvar porselen karoları :  
K94398500001VTE0 45x45 Stoneway Light grey / Açık gri

Floor porcelain tiles / Yer porselen karoları :  
K94398500001VTE0 45x45 Stoneway Light grey / Açık gri



# Stoneway

Glazed porcelain  
Sırlı porselen

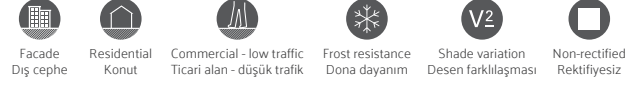

**Product standard / Ürün standardı**  
EN14411 Group B

**Footnotes / Dip notlar**  
H R

## Base Tiles / Fonlar



Cream / Krem



Light grey / Açık gri



45x45 Cream / Krem

1 Canvases / Kanvas (144x90)





45x45 Light grey / Açık gri

1 Canvases / Kanvas (144x90)



# Stoneway



Glazed porcelain Sırlı porselen	Surface Yüzey	Thickness Kalınlık	45x45 (18"x18") 447x447
 Cream Krem	R9	9 mm	K94393800001VTE0
 Light grey Açık gri	R9	9 mm	K94398500001VTE0

Sizes Ebatlar	Thickness Kalınlık (mm)	Box Kutu			Pallet Palet		
		Pcs Adet	m <sup>2</sup>	kg	Box Kutu	m <sup>2</sup>	kg
Glazed porcelain / Sırlı porselen							
45x45 Non-rectified / Rektifiyesiz	9	7	1,42	26,20	26	36,92	706



Floor porcelain tiles / Yer porselen karoları :  
K94398500001VTE0 45x45 Stoneway Light grey / Açık gri





# Wood obsession

## Ahşap tutkusu

The Wood is an obsession with its warm and light-weighted feel that come from its lifelike texture. It is the comforting force of nature.

Ahşap doğal dokusuyla yakınlaştıcı ve hayat katan özellikleri ile yaşayan bir tutku. Doğanın rahatlatıcı etkisinin bir gücü.



# Craft

VitrA is inspired by the characteristic structure of oak, which has been used in architecture for centuries, and which transforms within the course of time, and reshapes it. Through the time approach that adds meaning and depth to wood; the new VitrA tile collection Craft makes a difference with its sophisticated texture and streaks. With delicately selected texture and five different colours, Craft Collection presents the freedom of design with 20 mm tiles specifically developed for outdoor use.

VitrA, yüzyıllardır mimaride yer alan meşenin zaman içinde dönüşen karakterli yapısından ilham alıyor ve meşeyi tekrardan şekillendiriyor. Ahşaba anlam ve derinlik kazandıran zaman yaklaşımıyla yeni VitrA karo koleksiyonu Craft, sofistike dokusu ve damarlarıyla fark yaratıyor. Özenle seçilmiş doku ve beş ayrı rengeyle Craft Koleksiyonu, dış mekân kullanımları için özel olarak geliştirilen 20 mm karolarla da tasarım özgürlüğü sunuyor.

## Compatible collections / Uyumlu koleksiyonlar

Ceppostone	Urbancrete
Marmostone	mode #01
Boscostone	mode #04



Floor porcelain tiles / Yer porselen karoları :  
K949069R0001VTE1 30x120 Craft Light greige / Açık grej



Floor porcelain tiles / Yer porselen karoları :  
K948931R0001VTE0 20x120 Craft Greige / Grej  
K949080R0001VTE0 40x120 20mm Craft Greige / Grej



# Craft

Glazed porcelain  
Sırlı porselen



**Product standard / Ürün standardı**  
EN14411 Group B1a

**Footnotes / Dip notlar**  
F H R

## Base Tiles / Fonlar



Light greige / Açık grej



Beige / Bej



Oak / Meşe



Greige / Grej



Dark oak / Koyu meşe



Floor porcelain tiles / Yer porselen karoları :  
K949072R0001VTE1 30x120 Craft Dark oak / Koyu meşe  
K947307R0001VTE0 60x60 Ceppostone Mink / Vizon



# Craft



20x120 Greige / Grej

12 Faces / Yüzey görünümü (132x24)



20x120 Dark oak / Koyu meşe

12 Faces / Yüzey görünümü (132x24)

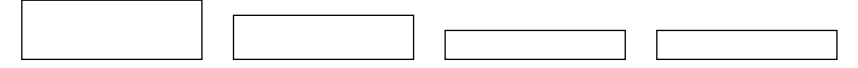

Glazed porcelain Sırlı porselen	Surface Yüzey	Thickness Kalınlık	40x120 (16"x48") R 397x1197	30x120 (12"x48") R 297x1197	20x120 (8"x48") R 197x1197	20x120 (8"x48") 206x1207
Light greige Açık grej	R10A	10 mm		K949069R0001VTE1	K948930R0001VTE0	K94893000001VTE0
	R11B	20 mm	K949079R0001VTE0			
Beige Bej	R10A	10 mm		K949071R0001VTE1	K948932R0001VTE0	K94893200001VTE0
	R11B	20 mm	K949081R0001VTE0			
Oak Meşe	R10A	10 mm		K949073R0001VTE1	K948934R0001VTE0	K94893400001VTE0
	R11B	20 mm	K949083R0001VTE0			
Greige Grej	R10A	10 mm		K949070R0001VTE1	K948931R0001VTE0	K94893100001VTE0
	R11B	20 mm	K949080R0001VTE0			
Dark oak Koyu meşe	R10A	10 mm		K949072R0001VTE1	K948933R0001VTE0	K94893300001VTE0
	R11B	20 mm	K949082R0001VTE0			

Sizes Ebatlar	Thickness Kalınlık (mm)	Box Kutu			Pallet Palet		
		Pcs Adet	m <sup>2</sup>	kg	Box Kutu	m <sup>2</sup>	kg
<b>Glazed porcelain / Sırlı porselen</b>							
40x120 Rectified / Rektifiyeli	20	1	0,48	22,32	36	17,28	829
30x120 Rectified / Rektifiyeli	10	4	1,44	27,36	36	51,84	1.010
20x120 Rectified / Rektifiyeli	10	4	0,96	20,50	48	46,08	1.009
20x120 Non-rectified / Rektifiyesiz	10	4	0,96	20,54	48	46,08	1.011



# Oakland

Oakland, the new member of Vitra collections with wooden texture, has been inspired and designed by the most natural form of oak. In the Oakland Collection that reflects the inherent characteristic and calmness of oak; natural texture and colours are preserved, and four colours carefully selected among hundreds of different options, based on Vitra approach. Representing the natural beauty of the knotless oak; Oakland Collection is enriched with 7.5x30 cm mini size with creative tiling options. In addition, it presents anti-slip surface for outdoor use such as poolside etc.

Ahşap dokulu Vitra koleksiyonlarının yeni üyesi Oakland, meşenin en doğal halinden ilham alarak geliştirildi. Meşenin özündeki doğallık ve sakinliği yansıtan Oakland Koleksiyonu'nda, doğal doku ve renkler korunarak Vitra yaklaşımıyla yüzlerce farklı seçenek arasından özenle seçilmiş dört renge odaklanılıyor. Budaksız meşenin doğal güzelliğini taşıyan Oakland Koleksiyonu, 7.5x30 cm mini ebatla zenginleştirilerek yaratıcı döşeme seçenekleri sunuyor. Bunun yanında havuz kenarı gibi dış mekân kullanımlarına uygun kaydırmazlık özelliği taşıyor.

## Compatible collections / Uyumlu koleksiyonlar

Boscostone  
mode

Urbancrete



Floor porcelain tiles / Yer porselen karoları :  
K94892400001VTE0 20x120 Oakland Dark oak / Koyu meşe



Floor porcelain tiles / Yer porselen karoları :  
K948924R0001VTE0 20x120 Oakland Dark oak / Koyu meşe



# Oakland

Glazed porcelain  
Sırlı porselen

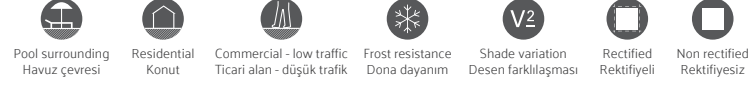

Product standard / Ürün standardı  
EN14411 Group Bla

Footnotes / Dip notlar  
F H R

## Base Tiles / Fonlar



Light oak / Açık meşe



Natural oak / Doğal meşe



Oak / Meşe



Dark oak / Koyu meşe



Floor porcelain tiles / Yer porselen karoları :  
K94872100001VTE0 20x120 Oakland Light oak / Açık meşe



# Oakland



20x120 Light oak / Açık meşe

12 Faces / Yüzey görünümü (132x24)



20x120 Dark oak / Koyu meşe

12 Faces / Yüzey görünümü (132x24)

Glazed porcelain Sırlı porselen	Surface Yüzey	Thickness Kalınlık	20x120 (8"x48") R 197x1197	20x120 (8"x48") 206x1207
Light oak Açık meşe	PTV Wet +36	10 mm	K948887R0001VTE0	
	R10A	10 mm	K948720R0001VTE0	K94872000001VTE0
Natural oak Doğal meşe	PTV Wet +36	10 mm	K948889R0001VTE0	
	R10A	10 mm	K948721R0001VTE0	K94872100001VTE0
Oak Meşe	PTV Wet +36	10 mm	K948890R0001VTE0	
	R10A	10 mm	K948723R0001VTE0	K94872300001VTE0
Dark oak Koyu meşe	PTV Wet +36	10 mm	K948926R0001VTE0	
	R10A	10 mm	K948924R0001VTE0	K94892400001VTE0

Sizes Ebatlar	Thickness Kalınlık (mm)	Box Kutu			Pallet Palet		
		Pcs Adet	m <sup>2</sup>	kg	Box Kutu	m <sup>2</sup>	kg
Glazed porcelain / Sırlı porselen							
20x120 Rectified / Rektifiyeli	10	4	0,96	20,50	48	46,08	1.009
20x120 Non-rectified / Rektifiyesiz	10	4	0,96	20,59	48	46,08	1.013



# Urbanwood

A porcelain collection that uses the ColorCode approach to add a modern hue to the intrinsic serenity of Scandinavian wood. Natural wood and concrete combine effortlessly and harmoniously in the Urbanwood Collection. The collection's highly effective anti-slip surface ensures that it is safe for all commercial and public uses.

ColorCode yaklaşımıyla İskandinav ahşabı modern dokuya sakince taşıyan porselen koleksiyonu. Urbanwood Koleksiyonu'nda doğal ahşap, beton ile uyum sağlayarak şekil buluyor. Yüksek kaydırmazlığa sahip yüzeyi sayesinde Urbanwood, ticari ve kamusal alanlarda da güvenli kullanım sağlıyor.

## Compatible collections / Uyumlu koleksiyonlar

Ceppostone	Metalcrete
Urban Travertino	mode
Urbancrete	miniworx



Floor porcelain tiles / Yer porselen karoları :  
K9475108R001VTE0 3,7x20 Urbanwood Chevron decor, dark grey /  
Chevron dekor, koyu gri



Floor porcelain tiles / Yer porselen karoları :  
K948616R0001VTE0 20x120 Urbanwood Light oak / Açık meşe



# Urbanwood

Glazed porcelain  
Sırlı porselen



**Product standard / Ürün standardı**  
EN14411 Group Bla

**Footnotes / Dip notlar**  
F H R

## Base Tiles / Fonlar



Mink / Vizon

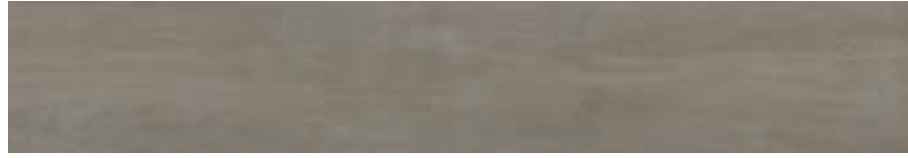

Dark greige / Koyu grej



Grey / Gri

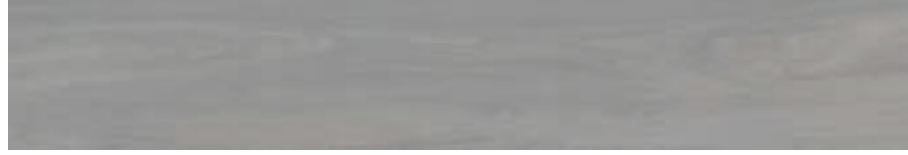

Dark grey / Koyu gri



Light oak / Açık meşe



Dark oak / Koyu meşe



Oiled oak / Yağlı meşe



Natural oak / Doğal meşe



Chevron decor / Chevron dekor  
Mink / Vizon



Chevron decor / Chevron dekor  
Dark greige / Koyu grej



Chevron decor / Chevron dekor  
Grey / Gri



Chevron decor / Chevron dekor  
Dark grey / Koyu gri

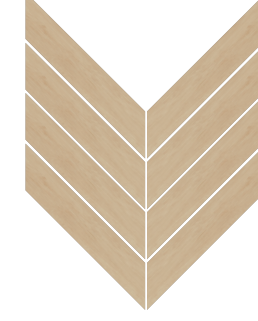

Chevron decor / Chevron dekor  
Light oak / Açık meşe

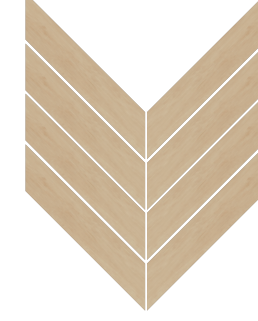

Chevron decor / Chevron dekor  
Natural oak / Doğal meşe

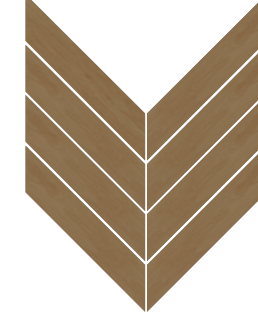

Chevron decor / Chevron dekor  
Oiled oak / Yağlı meşe

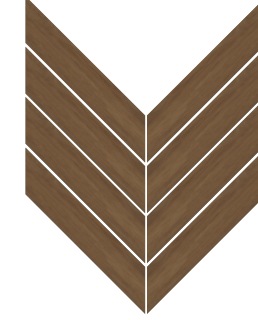

Chevron decor / Chevron dekor  
Dark oak / Koyu meşe



# Urbanwood



20x120 Light oak / Açık meşe

6 Faces / Yüzey görünümü (134x26)

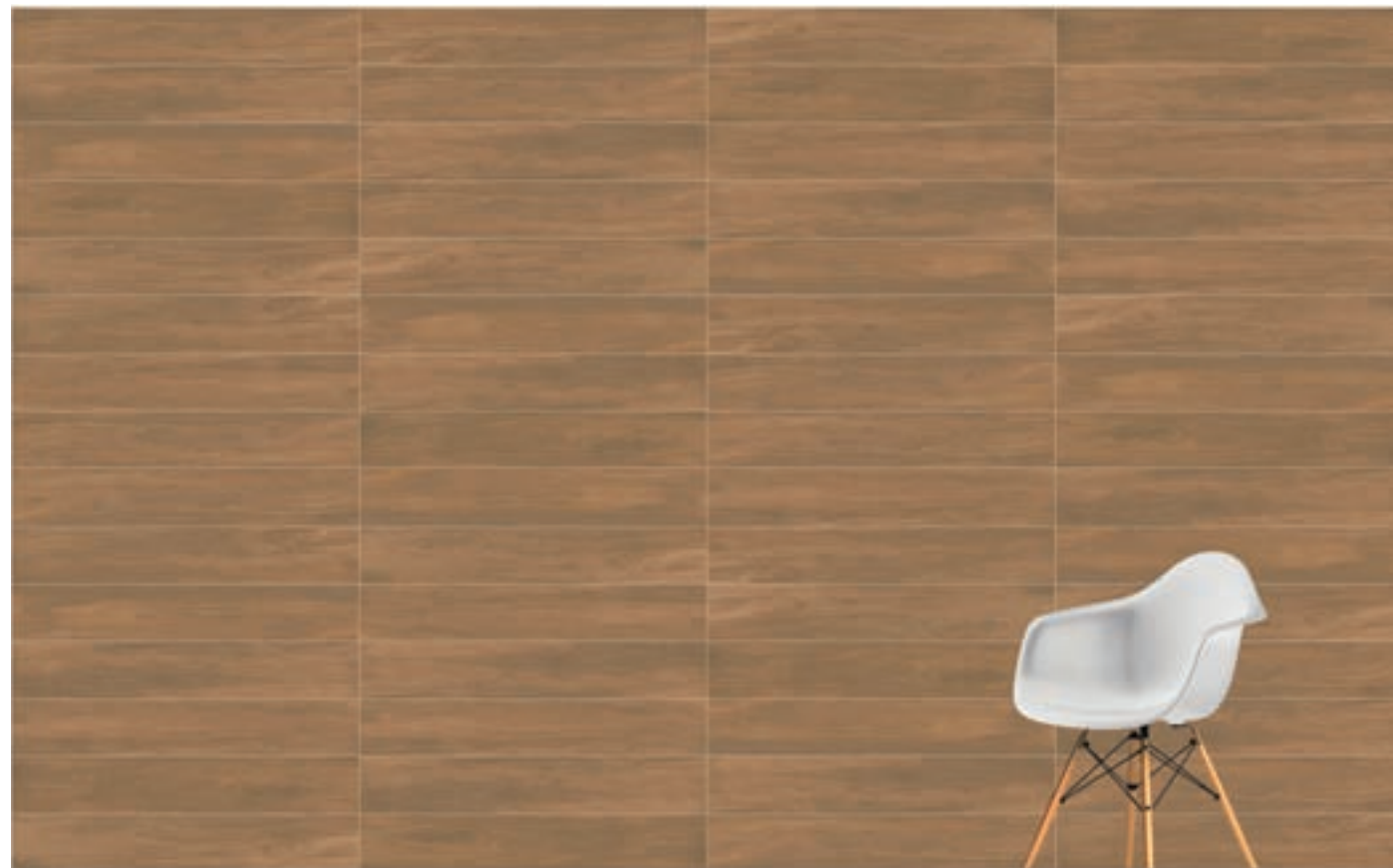

20x120 Dark oak / Koyu meşe

7 Faces / Yüzey görünümü (134x26)

Glazed porcelain Sırlı porselen	Surface Yüzey	Thickness Kalınlık	20x120 (8"x48") R 197x1197	20x120 (8"x48") 206x1207
Mink Vizon	R10A	10 mm	K947488R0001VTE0	K94748800001VTE0
Dark greige Koyu grej	R10A	10 mm	K947486R0001VTE0	K94748600001VTE0
Grey Gri	R10A	10 mm	K947485R0001VTE0	K94748500001VTE0
Dark grey Koyu gri	R10A	10 mm	K947487R0001VTE0	K94748700001VTE0
Light oak Açık meşe	R10A	10 mm	K948616R0001VTE0	K94861600001VTE0
Natural oak Doğal meşe	R10A	10 mm	K948617R0001VTE0	K94861700001VTE0
Dark oak Koyu meşe	R10A	10 mm	K948618R0001VTE0	K94861800001VTE0
Oiled oak Yağlı meşe	R10A	10 mm	K948619R0001VTE0	K94861900001VTE0



Decors Dekorlar	Surface Yüzey	Thickness Kalınlık	3,7x20
Mink Vizon	R10A	10 mm	K9475118R001VTE0
Dark greige Koyu grej	R10A	10 mm	K9475098R001VTE0
Grey Gri	R10A	10 mm	K9475088R001VTE0
Dark grey Koyu gri	R10A	10 mm	K9475108R001VTE0
Light oak Açık meşe	R10A	10 mm	K9486128R001VTE0
Natural oak Doğal meşe	R10A	10 mm	K9486138R001VTE0
Dark oak Koyu meşe	R10A	10 mm	K9486158R001VTE0
Oiled oak Yağlı meşe	R10A	10 mm	K9486148R001VTE0

Sizes Ebatlar	Thickness Kalınlık (mm)	Box Kutu			Pallet Palet		
		Pcs Adet	m <sup>2</sup>	kg	Box Kutu	m <sup>2</sup>	kg
<b>Glazed porcelain / Sırlı porselen</b>							
20x120 Rectified / Rektifiyeli	10	4	0,96	20,54	48	46,08	1.011
20x120 Non-rectified / Rektifiyesiz	10	4	0,96	21,12	48	46,08	1.039
3,7x20 Decor / Dekor	10	10	0,68	14,41	48	19,44	435



# Aspenwood

The amazing quality of wood, which is bestowed with diverse possibilities of interpretations when applied in surface design, lies in its ability of modeling. Aspenwood is a wooden textured ceramic range; quiet and minimalist for the first and exuberant and colourful for the second. You can see the natural beauty of the trees and raw material look that revolves around the characteristics of Aspen mountains. The product range includes natural wood tones for traditional wood-looking floors, as well as greige tones for modern designed spaces. Thanks to its R10 class anti-slip products, the collection offers safe solutions for public spaces such as restaurants, hotels and offices.

Yüzeylere uygulandığında zengin tasarım ve kullanım imkanı sunan ahşap malzemenin farkı, biçimlendirme kabiliyetinde yatıyor. Ahşap dokulu seramik serisi Aspenwood, hamlıkla gelen yalınlığının yanı sıra coşkulu ve renkli seçenekler sunuyor. Aspen'in karakteristik doğası ve dağları çevreleyen ağaçlardan gelen saf ve ham yansımalar, bu seri ile mekanlara taşınıyor. Ürün yelpazesi, geleneksel ahşap görünümlü zeminler için doğal ahşap renk tonlarını, modern tasarım alanları içinse ham malzeme renk tonlarını içeriyor; R10 sınıfındaki kaymayı önleyici ürünler sayesinde restoran, otel ve ofis gibi alanlar için güvenli çözümler sunuyor.



Floor porcelain tiles / Yer porselen karoları :  
K945691R0001VTE0 20x120 Aspenwood Dark grey / Koyu gri



Floor porcelain tiles / Yer porselen karoları :  
K945692R0001VTE0 20x120 Aspenwood Greige / Grej



# Aspenwood

Glazed porcelain  
Sırlı porselen



Residential  
Konut



Frost resistance  
Dona dayanım



Shade variation  
Desen farklılaşması



Rectified  
Rektifiyeli



Non rectified  
Rektifiyesiz

Product standard / Ürün standardı  
EN14411 Group B1a

Footnotes / Dip notlar  
F G H R S

## Base Tiles / Fonlar



Mink / Vizon



Greige / Grej



Dark greige / Koyu grej



Grey / Gri



Dark grey / Koyu gri



Anthracite / Antrasit



Beige / Bej



Cherry / Kızıl



Wenge / Venge



Dark wenge / Koyu venge



# Aspenwood



20x120 Greige / Grej 10 Faces / Yüzey görünümü (134x26)



20x120 Dark greige / Koyu grej 10 Faces / Yüzey görünümü (134x26)

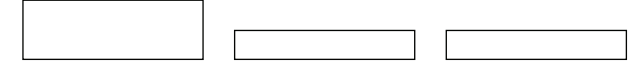

Glazed porcelain Sırlı porselen	Surface Yüzey	Thickness Kalınlık	40x120 (16"x48") R 397x1197	20x120 (8"x48") R 197x1197	20x120 (8"x48") 206x1207
Beige Bej	R10A	10 mm		K946242R0001VTE0	K94624200001VTE0
	R11	20 mm	K950124R0001VTE0		
Cherry Kızıl	R10A	10 mm		K946243R0001VTE0	K94624300001VTE0
	R11	20 mm			
Wenge Venge	R10A	10 mm		K945695R0001VTE0	K94569500001VTE0
	R11	20 mm			
Dark wenge Koyu venge	R10A	10 mm		K946244R0001VTE0	K94624400001VTE0
	R11	20 mm			
Mink Vizon	R10A	10 mm		K945696R0001VTE0	K94569600001VTE0
	R11	20 mm	K950125R0001VTE0		
Greige Grej	R10A	10 mm		K945692R0001VTE0	K94569200001VTE0
	R11	20 mm			
Dark greige Koyu grej	R10A	10 mm		K946241R0001VTE0	K94624100001VTE0
	R11	20 mm			
Grey Gri	R10A	10 mm		K945693R0001VTE0	K94569300001VTE0
	R11	20 mm	K950126R0001VTE0		
Dark grey Koyu gri	R10A	10 mm		K945691R0001VTE0	K94569100001VTE0
	R11	20 mm	K950127R0001VTE0		
Anthracite Antrasit	R10A	10 mm		K945694R0001VTE0	K94569400001VTE0
	R11	20 mm			

Sizes Ebatlar	Thickness Kalınlık (mm)	Box Kutu			Pallet Palet		
		Pcs Adet	m <sup>2</sup>	kg	Box Kutu	m <sup>2</sup>	kg
<b>Glazed porcelain / Sırlı porselen</b>							
40x120 Rectified / Rektifiyeli	20	1	0,48	22,32	36	17,28	829
20x120 Non-rectified / Rektifiyesiz	10	4	0,96	20,54	48	46,08	1.011
20x120 Rectified / Rektifiyeli	10	4	0,96	20,50	48	46,08	1.009



# Samba

A ceramic series bringing the sustainable effects of the nature to spaces. Samba offers an ideal alternative for urban areas. Giving the opportunity to match versatile designs with infinite number of colours, the series creates a totally new and effective style.

Doğanın sürdürülebilir etkilerini mekânlara taşıyan seramik serisi. Samba, şehir hayatına uygun bir doku alternatifi sunuyor. Çok yönlülük ve sonsuz sayıda renk şeması ile uyumlu bir şekilde harmanlanabilme fırsatı sunan seri yepyeni ve etkili bir tarz yaratıyor.



Wall tiles / Duvar karoları :  
K925353R0001VTE0 20x120 Samba Beige / Bej  
Floor porcelain tiles / Yer porselen karoları :  
K925353R0001VTE0 20x120 Samba Beige / Bej



Wall tiles / Duvar karoları :  
K92537500001VTE0 20x120 Samba Light oak / Açık meşe  
Floor porcelain tiles / Yer porselen karoları :  
K92536400001VTE0 20x120 Samba Wenge / Venge



# Samba

Glazed porcelain  
Sırlı porselen



Facade  
Dış cephe



Residential  
Konut



Commercial - low traffic  
Ticari alan - düşük trafik



Frost resistance  
Dona dayanım



Shade variation  
Desen farklılaşması



Rectified  
Rektifiyeli



Non-rectified  
Rektifiyesiz

Product standard / Ürün standardı  
EN14411 Group Bla

Footnotes / Dip notlar  
H R

## Base Tiles / Fonlar



Light oak / Açık meşe



Oak / Meşe



Beige / Bej

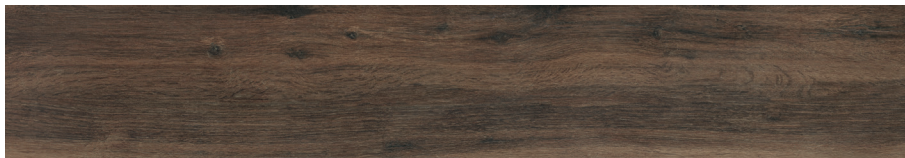

Wenge / Venge



20x120 Oak / Meşe

200x100 3 Canvases / Kanvas (6 m²)

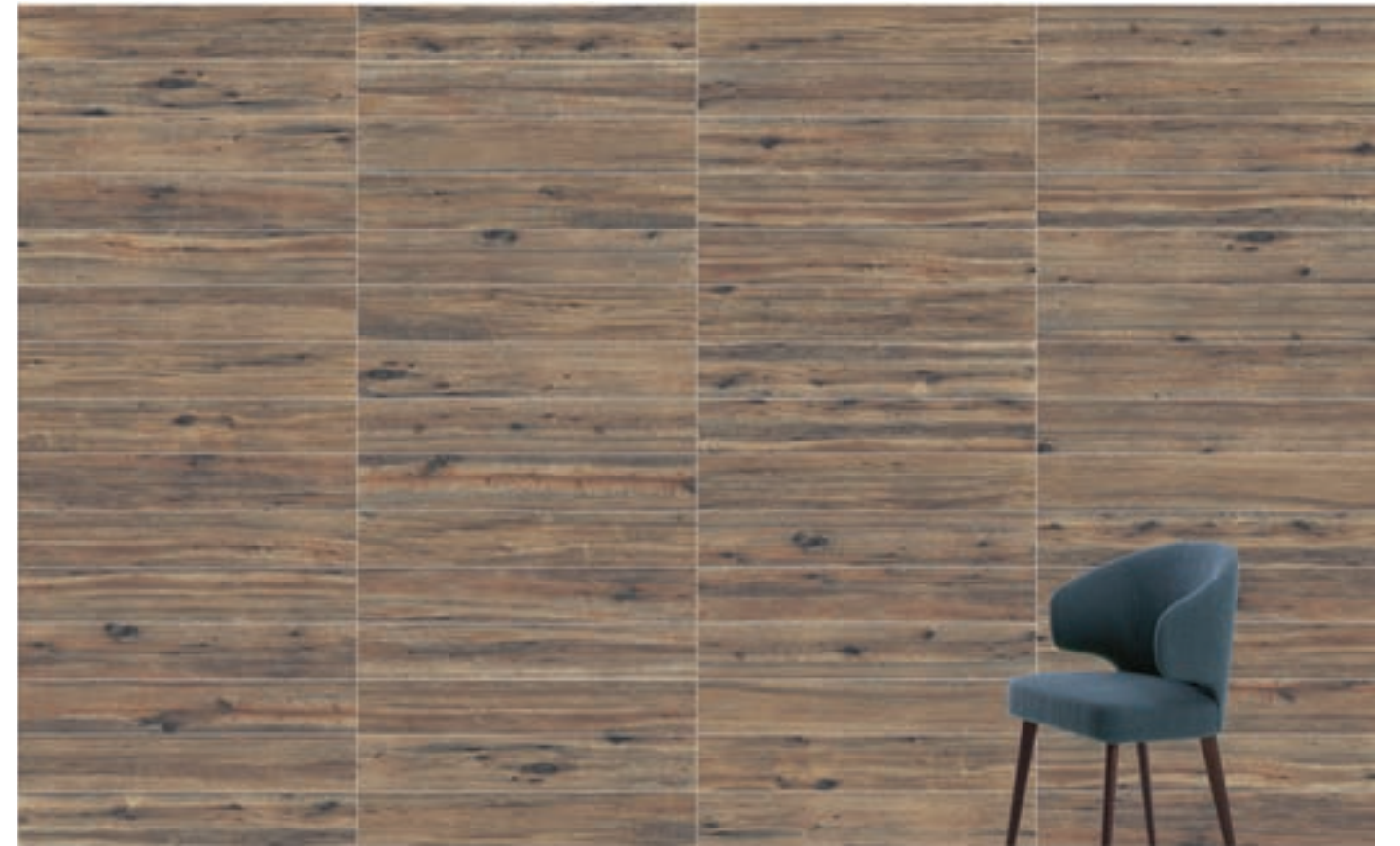





20x120 Wenge / Venge

200x100 4 Canvases / Kanvas (8 m²)



# Samba



Glazed porcelain Sırlı porselen	Surface Yüzey	Thickness Kalınlık	20x120 (8"x48") R 197x1197	20x120 (8"x48") 206x1207
 Light oak Açık meşe	R10	10 mm	K925375R0001VTE0	K92537500001VTE0
 Oak Meşe	R10	10 mm	K943058R0001VTE0	K94305800001VTE0
 Beige Bej	R10	10 mm	K925353R0001VTE0	K92535300001VTE0
 Wenge Venge	R10	10 mm	K925364R0001VTE0	K92536400001VTE0

Sizes Ebatlar	Thickness Kalınlık (mm)	Box Kutu			Pallet Palet		
		Pcs Adet	m <sup>2</sup>	kg	Box Kutu	m <sup>2</sup>	kg
Glazed porcelain / Sırlı porselen							
20x120 Non-rectified / Rektifiyesiz	10	4	0,96	20,54	48	46,08	1.011
20x120 Rectified / Rektifiyeli	10	4	0,96	20,50	48	46,08	1.009



Wall tiles / Duvar karoları :  
K92537500001VTE0 20x120 Samba Light oak / Açık meşe  
Floor porcelain tiles / Yer porselen karoları :  
K92536400001VTE0 20x120 Samba Wenge / Venge





# Marble dream

## Mermer rüyası

Marble is nature's most precious treasure that is used in art and architecture. The atmosphere it creates and the diverse options it provides serves to designs that combine modern life passion with prominent classical taste.

Mermer, doğanın yaratıcılığa, sanata ve mimariye sunduğu en değerli hazinesi. Yarattığı atmosfer ve tasarım zenginliği, modern yaşamın coşkusu ile klasiğin seçkin zevkini bir araya getiriyor.



# MarmoMix



Premium marbles that form the cornerstones of architectural design is offered in Vitra's innovative MarmoMix system with countless laying options to the world of interior designers and architects. The marbles that inspire MarmoMix textures have been used in many architectural structures throughout the history as a strong design element on their own and also in combination with one another to create harmony. These marbles which kept their popularity for ages are now re-interpreted in MarmoMix system for strong, flexible and creative offerings to contemporary designs. MarmoMix system, with its compatibility with other Vitra systems and with its different size offerings, provides users flexibility in design.

Mimarının güçlü yapı taşlarından olan prestijli mermerler Vitra'nın yenilikçi MarmoMix sisteminde sayısız döşeme imkânıyla tasarım ve mimari dünyasına sunuluyor. MarmoMix dokularına ilham olan mermerler, tarih boyunca farklı mimari yapılarda kendi başlarına güçlü birer tasarım ögesi oluşturmalarının yanı sıra, birlikte uyum içerisinde de kullanılmıştır. Gözdeliğini çağlardır koruyan bu mermerler, kullanıcılara güçlü, esnek ve yaratıcı seçenekler sunmak amacıyla çağdaş mekân tasarımları için MarmoMix sisteminde yeniden yorumlanıyor. Diğer Vitra sistemleri ile uyumlu şekilde kullanılabilme özelliği ve farklı kesme ebatları sayesinde MarmoMix sistemi kullanıcılara tasarım esnekliği sağlıyor.

## Compatible collections / Uyumlu koleksiyonlar

Marmoriretromix  
mode



Wall tiles / Duvar karoları :  
K950686R0001VTE0 60x60 MarmoMix St. Laurent fume / St. Laurent füme  
K94971080001VTE0 2.5x15 mode Clay tatami cut / Kil tatami kesim  
Floor porcelain tiles / Yer porselen karoları :  
K948805R0001VTE0 60x60 CementMix Micro Greige / Grej



Wall tiles / Duvar karoları :  
K94842480001VTE0 10x10 retromix Sapphire blue / Safir mavi  
K950684R0001VTE0 60x60 MarmoMix Rosso Alicante / Rosso Alicante  
Floor porcelain tiles / Yer porselen karoları :  
K948815R0001VTE0 60x60 CementMix Micro Light grey / Açık gri



# MarmoMix

Glazed porcelain  
Sırlı porselen

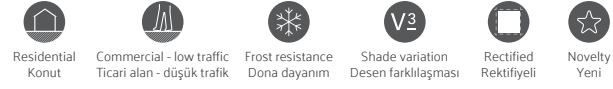

Product standard / Ürün standardı  
EN14411 Group Bla

Footnotes / Dip notlar  
H R

## Base Tiles / Fonlar



Carrara white / Carrara beyaz

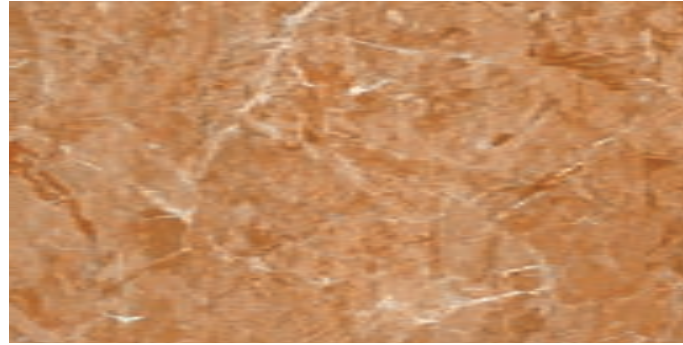

Rosso Alicante

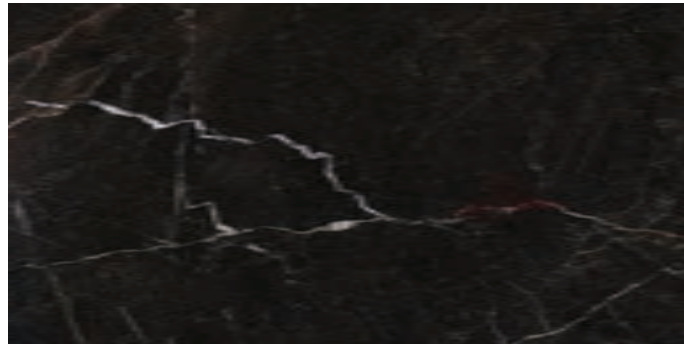

St. Laurent fume / St. Laurent füme



Rosalia Pink

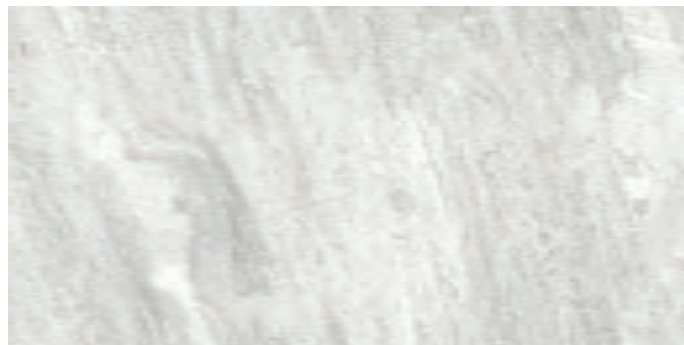

Bardiglio grey / Bardiglio gri

## Decors / Dekorlar



Cut decor / Kesme dekor  
Carrara white / Carrara beyaz

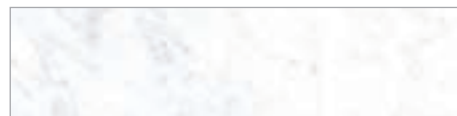

Cut decor / Kesme dekor  
Carrara white / Carrara beyaz



Cut decor / Kesme dekor  
Carrara white / Carrara beyaz



60x120 Bardiglio grey / Bardiglio gri

9 Faces / Yüzey görünümü (180x360)







60x120 Rosalia Pink

9 Faces / Yüzey görünümü (180x300)



# MarmoMix



Glazed porcelain Sırlı porselen	Surface Yüzey	Thickness Kalınlık	60x120 (24"x48") R 597x1197	60x60 (24"x24") R 597x597	30x60 (12"x24") R 297x597
 Carrara white Carrara beyaz	FLPR	9 mm	K947023FLPR1VTSP		
	R10A	9 mm	K947870R0001VTSP	K946537R0001VTE0	K950696R0001VTE0
 Rosso Alicante Rosso Alicante	FLPR	9 mm	K950638FLPR1VTSP		
	R10A	9 mm	K950634R0001VTSP	K950684R0001VTE0	K950657R0001VTE0
 Bardiglio grey Bardiglio gri	FLPR	9 mm	K950637FLPR1VTSP		
	R10A	9 mm	K950633R0001VTSP	K950683R0001VTE0	K950656R0001VTE0
 St. Laurent fume St. Laurent füme	FLPR	9 mm	K950640FLPR1VTSP		
	R10A	9 mm	K950636R0001VTSP	K950686R0001VTE0	K950659R0001VTE0
 Rosalia Pink Rosalia Pink	FLPR	9 mm	K951615FLPR1VTSP		
	R10A	9 mm	K951614R0001VTSP	K951620R0001VTE0	K951616R0001VTE0



Decors Dekorlar	Surface Yüzey	Thickness Kalınlık	30x30 (12"x12") 297x297	15x60 (6"x24") 147x597	7,5x60 (3"x24") 72x597
 Carrara white Carrara beyaz	R10A	9 mm	K950699R0001VTE0	K950697R0001VTE0	K950698R0001VTE0
	R10A	9 mm	K950670R0001VTE0	K950661R0001VTE0	K950668R0001VTE0
 Bardiglio grey Bardiglio gri	R10A	9 mm	K950662R0001VTE0	K950660R0001VTE0	K950667R0001VTE0
	R10A	9 mm	K950672R0001VTE0	K950666R0001VTE0	K950664R0001VTE0
 Rosalia Pink Rosalia Pink	R10A	9 mm	K951619R0001VTE0	K951618R0001VTE0	K951617R0001VTE0

Sizes Ebatlar	Thickness Kalınlık (mm)	Box Kutu			Pallet Palet		
		Pcs Adet	m <sup>2</sup>	kg	Box Kutu	m <sup>2</sup>	kg
<b>Glazed porcelain / Sırlı porselen</b>							
60x120 Rectified / Rektifiyeli	9	2	1,44	29,52	36	51,84	1.098
60x60 Rectified / Rektifiyeli	9	4	1,44	24,48	32	46,08	808
30x60 Rectified / Rektifiyeli	9	6	1,08	18,04	40	43,20	746
30x30 Cut decor / Kesme dekor	9	6	1,08	18,04	48	51,84	891
15x60 Cut decor / Kesme dekor	9	11	1,00	16,70	48	48,00	827
7,5x60 Cut decor / Kesme dekor	9	6	0,27	4,86	96	25,92	492



wall tiles / Duvar karoları:  
K951620R0001VTE0 60x60 MarmoMix Rosalia Pink  
K94971280001VTE0 30x30 mode Stone tatami cut / Taş tatami kesim  
Floor porcelain tiles / Yer porselen karoları:  
K94844500001VTE0 15x15 retromix Cold triangle / Soğuk üçgen



# Marble - X

Marble - X adds luxurious touch to spaces through the most natural look of four different warm marble textures that can be used together. Each texture has its own specific touch; Augustos taupe colour adds a passionate and bold theatrical look, desert rosa terra colour, inspired by brown soil makes a naturalistic relieving impact, skyros cream, a neutral colour gives a refreshing feel, breccia capraia white colour strikes with a noble look.

Marble - X Serisi birbiriyle uyumlu dört farklı sıcak rengi ve etkileyici doku seçenekleri ile mermerin en doğal halini mekânlara yansıtıken lüks bir dokunuş katıyor. Augustos taupe rengi ile tutkulu, cesur bir teatral hava, desert rosa terra rengi ile topraktan ilham olan doğal rahatlatıcı bir etki, skyros krem nötr rengi ile ferahlatıcı bir etki, breccia capraia beyaz rengi ile soylu bir hava veriyor.



Wall tiles / Duvar karoları :  
K949809FLPR1VTSP Marble - X 60x120 Skyros cream / Skyros krem  
Floor porcelain tiles / Yer porselen karoları :  
K949809FLPR1VTSP Marble - X 60x120 Skyros cream / Skyros krem



Wall tiles / Duvar karoları :  
K949808FLPR1VTSP Marble - X 60x120 Breccia capraia white / Breccia capraia beyaz  
K949811FLPR1VTSP Marble - X 60x120 Augustos taupe / Augustos taupe  
Floor porcelain tiles / Yer porselen karoları :  
K949808FLPR1VTSP Marble - X 60x120 Breccia capraia white / Breccia capraia beyaz



# Marble - X

Glazed porcelain  
Sırlı porselen

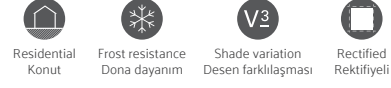

**Product standard / Ürün standardı**  
EN14411 Group Bla

**Footnotes / Dip notlar**  
G H P R

## Base Tiles / Fonlar



Breccia capraia white / Breccia capraia beyaz



Skyros cream / Skyros krem



Desert rose terra / Desert rose terra



Augustos taupe / Augustos taupe



60x120 Breccia capraia white / Breccia capraia beyaz

20 Faces / Yüzey görünümü (34x130)



60x120 Augustos taupe / Augustos taupefüme

21 Faces / Yüzey görünümü (34x130)



# Marble - X



Glazed porcelain Sırlı porselen	Surface Yüzey	Thickness Kalınlık	60x120 (24"x48") R 597x1197
 Breccia capraia white Breccia capraia beyaz	FLPR	9 mm	K949808FLPR1VTSP
 Skyros cream Skyros krem	FLPR	9 mm	K949809FLPR1VTSP
 Desert rose terra Desert rose terra	FLPR	9 mm	K949810FLPR1VTSP
 Augustos taupe Augustos taupe	FLPR	9 mm	K949811FLPR1VTSP

Sizes Ebatlar	Thickness Kalınlık (mm)	Box Kutu			Pallet Palet		
		Pcs Adet	m <sup>2</sup>	kg	Box Kutu	m <sup>2</sup>	kg
Glazed porcelain / Sırlı porselen							
60x120 Rectified / Rektifiyeli	9	2	1,44	29,52	36	51,84	1.098



Wall tiles / Duvar karoları :  
K949810FLPR1VTSP Marble - X 60x120 Desert rose terra / Desert rose terra  
Floor porcelain tiles / Yer porselen karoları :  
K949808FLPR1VTSP Marble - X 60x120 Breccia capraia white / Breccia capraia beyaz



# Nuvola

A porcelain collection reflecting marble elegance to residential and commercial spaces. VitrA re-interprets jewellery designers' favourite Onyx marble in 4 different colours.

Mermerin şıklığını konutlara ve ticari mekânlara yansıtan porselen koleksiyonu. VitrA, mücevher tasarımcılarının gözdesi Oniks mermerini 4 farklı renkte yeniden yorumluyor.



Floor porcelain tiles / Yer porselen karoları :  
K947884FLPR1VTSP Nuvola 60x120 Grey / Gri



Wall tiles / Duvar karoları :  
K947885FLPR1VTSP Nuvola 60x120 Cream / Krem  
K947889FLPR1VTSP Nuvola 60x120 Cream / Krem  
Floor porcelain tiles / Yer porselen karoları :  
K947885FLPR1VTSP Nuvola 60x120 Cream / Krem



# Nuvola

Glazed porcelain  
Sırlı porselen

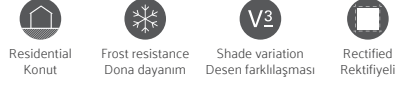

Product standard / Ürün standardı  
EN14411 Group Bla

Footnotes / Dip notlar  
G H P R

## Base Tiles / Fonlar



White / Beyaz



Cream / Krem



Grey / Gri



Brown / Kahve



60x120 White / Beyaz

2 Canvases / Kanvas (100x300)



60x120 Brown / Kahve

2 Canvases / Kanvas (100x300)



# Nuvola

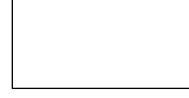

Glazed porcelain Sırlı porselen	Surface Yüzeý	Thickness Kalınlık	60x120 (24"x48") R 597x1197
 White Beyaz	FLPR	9 mm	K947883FLPR1VTSP
 Cream Krem	FLPR	9 mm	K947885FLPR1VTSP
 Grey Gri	FLPR	9 mm	K947884FLPR1VTSP
 Brown Kahve	FLPR	9 mm	K947886FLPR1VTSP

Sizes Ebatlar	Thickness Kalınlık (mm)	Box Kutu			Pallet Palet		
		Pcs Adet	m <sup>2</sup>	kg	Box Kutu	m <sup>2</sup>	kg
Glazed porcelain / Sırlı porselen							
60x120 Rectified / Rektifiyeli	9	2	1,44	29,52	36	51,84	1.098



Floor porcelain tiles / Yer porselen karoları :  
K947884FLPR1VTSP Nuvola 60x120 Grey / Gri



# Marmori

Marble textured porcelain tile series which combines the most elegant examples of classical marbles. The collection stands out with the natural looking tiles inspired by black Saint Laurent Nero, white Calacatta, Carrara and cream / bronze Pulpis marbles as well as the marbles in the range of greige, ivory and grey colours. Its eye-catching harmony nourished by the contrasts of white and black, carries the timeless simplicity of classic to the spaces it is used. On the other hand, the delicacy of cream and bronze adds richness and nobility to interior spaces. The collection offers an unlimited freedom of design, thanks to natural marble colours that can be used in contrast with each other.

Klasik mermerlerin en seçkin sekiz örneğini birlikte sunan mermer görümlü porselen karo serisi. Koleksiyon, siyah renkli Saint Laurent Nero, beyaz renkli Calacatta, Carrara mermerleri ve krem ile bronzun bir araya geldiği Pulpis mermerlerinden ilham alan doğal görümlü seramiklerin yanı sıra grej, fildişi, gri renk yelpazesindeki mermerler ile öne çıkıyor. Siyah ve beyazın zıtlıklardan beslenen çarpıcı uyumu, klasiğin modası geçmeyecek sadeliğini kullandığı mekânlara taşıyor. Krem ve bronzun zarafeti ise iç mekânlara zenginlik ve asalet kazandırıyor. Birbiriyle kontrast içinde kullanılabilecek renkleri sayesinde koleksiyon, sınırsız bir tasarım özgürlüğü sunuyor.

Compatible collections / Uyumlu koleksiyonlar

Futura  
mode



Wall tiles / Duvar karoları :  
K947002FLPR1VTE0 60x60 Marmori Royal cream / Royal krem  
Floor porcelain tiles / Yer porselen karoları :  
K947002FLPR1VTE0 60x60 Marmori Royal cream / Royal krem



Wall tiles / Duvar karoları :  
K947017FLPR1VTSP Marmori 60x120 Royal cream / Royal krem  
Floor porcelain tiles / Yer porselen karoları :  
K94858800001VTE0 Marmori 30x60 Cloud grey / Cloud gri



# Marmori

Wall tiles  
Duvar karoları



Product standard / Ürün standardı  
EN14411 Group BIII

## Base Tiles / Fonlar



Pulpis cream / Pulpis krem

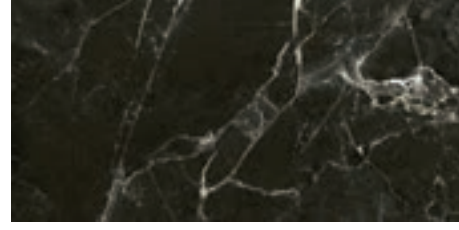

St. Laurent black / St. Laurent siyah

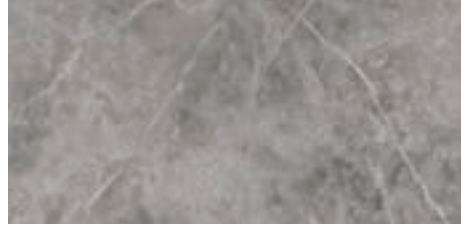

Fior greige / Fior grej



Cloud grey / Cloud gri



Pulpis bronze / Pulpis bronz



Calacatta white / Calacatta beyaz



Royal cream / Royal krem



Carrara white / Carrara beyaz

## Decors / Dekorlar



Carrara white 3D decor / Carrara beyaz 3D dekor

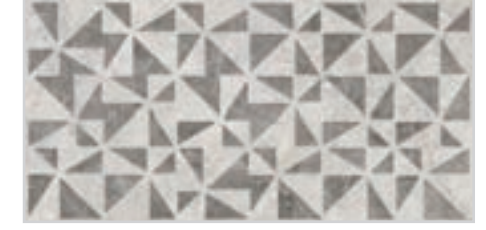

Royal cream 3D decor / Royal krem 3D dekor



Calacatta white 3D decor / Calacatta beyaz 3D dekor



Pulpis cream 3D decor / Pulpis krem 3D dekor

## Colorbody porcelain Colorbody porselen



Product standard / Ürün standardı  
EN14411 Group BIIa

Footnotes / Dip notlar  
G H P R

## Base Tiles / Fonlar



Carrara white / Carrara beyaz



# Marmori

Glazed porcelain  
Sırlı porselen

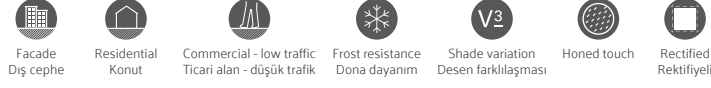

Product standard / Ürün standardı  
EN14411 Group Bla

Footnotes / Dip notlar  
G H P R

## Base Tiles / Fonlar



Pulpis cream / Pulpis krem



St. Laurent black / St. Laurent siyah



Fior greige / Fior grej



Cloud grey / Cloud gri

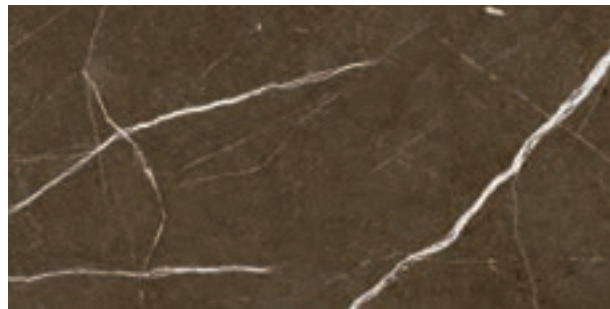

Pulpis bronze / Pulpis bronz



Gold Calacatta white / Gold Calacatta beyaz



Royal cream / Royal krem

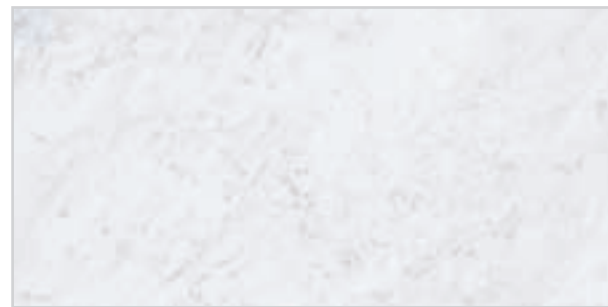

Carrara white / Carrara beyaz

Glazed porcelain  
Sırlı porselen

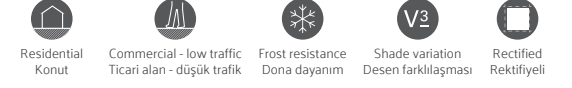

Product standard / Ürün standardı  
EN14411 Group Bla

Footnotes / Dip notlar  
G H P R

## Decors / Dekorlar

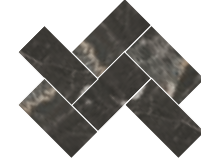

Herringbone cut decor / Balıksırtı kesme dekor  
St. Laurent black / St. Laurent siyah

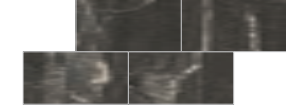

Brick cut decor / Tuğla kesme dekor  
St. Laurent black / St. Laurent siyah

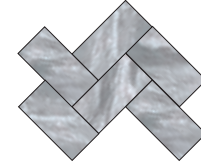

Herringbone cut decor / Balıksırtı kesme dekor  
Cloud grey / Cloud gri

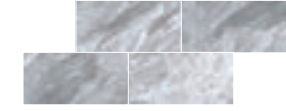

Brick cut decor / Tuğla kesme dekor  
Cloud grey / Cloud gri

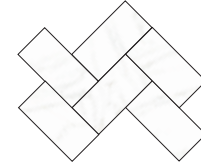

Herringbone cut decor / Balıksırtı kesme dekor  
Gold Calacatta white / Gold Calacatta beyaz

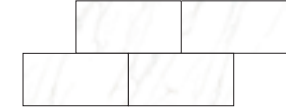

Brick cut decor / Tuğla kesme dekor  
Gold Calacatta white / Gold Calacatta beyaz

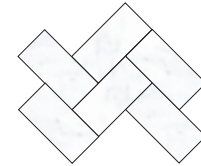

Herringbone cut decor / Balıksırtı kesme dekor  
Carrara white / Carrara beyaz

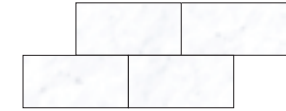

Brick cut decor / Tuğla kesme dekor  
Carrara white / Carrara beyaz



# Marmori





60x120 Carrara White / Carrara Beyaz 300x100 1 Canvases / Kanvas (3 m<sup>2</sup>)





60x120 Cloud grey / Cloud gri 200x100 2 Canvases / Kanvas (4 m<sup>2</sup>)



Wall tiles Duvar karoları	Surface Yüzey	Thickness Kalınlık	30x60 (12"x24") 298x598
 Pulpis cream Pulpis krem	Glossy / Parlak	9 mm	K94858300001VTE0
 Fior greige Fior grej	Glossy / Parlak	9 mm	K94858600001VTE0
 Pulpis bronze Pulpis bronz	Glossy / Parlak	9 mm	K94858400001VTE0
 Royal cream Royal krem	Glossy / Parlak	9 mm	K94858500001VTE0
 St. Laurent black St. Laurent siyah	Glossy / Parlak	9 mm	K94858200001VTE0
 Cloud grey Cloud gri	Glossy / Parlak	9 mm	K94858800001VTE0
 Calacatta white Calacatta beyaz	Glossy / Parlak	9 mm	K94858100001VTE0
 Carrara white Carrara beyaz	Glossy / Parlak	9 mm	K94858700001VTE0











3D decor /  
3D dekor

Decors Dekorlar	Surface Yüzey	Thickness Kalınlık	30x60 (12"x24") 298x598
 Pulpis cream Pulpis krem	Glossy / Parlak	9 mm	K94859000001VTE0
 Royal cream Royal krem	Glossy / Parlak	9 mm	K94859100001VTE0
 Calacatta white Calacatta beyaz	Glossy / Parlak	9 mm	K94858900001VTE0
 Carrara white Carrara beyaz	Glossy / Parlak	9 mm	K94859200001VTE0



# Marmori



Glazed porcelain Sırlı porselen	Surface Yüzey	Thickness Kalınlık	60x120 (24"x48") R 597x1197	60x60 (24"x24") R 597x597	30x60 (12"x24") R 297x597
 Pulpis cream Pulpis krem	FLPR	9 mm	K947005FLPR1VTSP	K947014FLPR1VTE0	K947008FLPR1VTE0
 Fior greige Fior grej	FLPR	9 mm	K947018FLPR1VTSP	K947003FLPR1VTE0	K947016FLPR1VTE0
 Pulpis bronze Pulpis bronz	FLPR	9 mm	K947013FLPR1VTSP	K947001FLPR1VTE0	K947022FLPR1VTE0
 Royal cream Royal krem	FLPR	9 mm	K947017FLPR1VTSP	K947002FLPR1VTE0	K947004FLPR1VTE0
 St. Laurent black St. Laurent siyah	FLPR	9 mm	K947011FLPR1VTSP	K947006FLPR1VTE0	K947012FLPR1VTE0
 Cloud grey Cloud gri	FLPR	9 mm	K947019FLPR1VTSP	K947007FLPR1VTE0	K947010FLPR1VTE0
 G. Calacatta white G. Calacatta beyaz	FLPR	9 mm	K947021FLPR1VTSP	K947000FLPR1VTE0	K947020FLPR1VTE0
 Carrara white Carrara beyaz	FLPR	9 mm	K947023FLPR1VTSP	K947015FLPR1VTE0	K947009FLPR1VTE0



Colorbody porcelain Colorbody porselen	Surface Yüzey	Thickness Kalınlık	60x120 (24"x48") R 597x1197	60x60 (24"x24") R 597x597	30x60 (12"x24") R 297x597	30x30 (12"x12") R 297x297
 St. Laurent black St. Laurent siyah	LPR	9 mm	K947869LPR01VTSP	K945332LPR01VTE0		
	R10A	9 mm	K947869R0001VTSP	K945332R0001VTE0		
 Cloud grey Cloud gri	LPR	9 mm	K947871LPR01VTSP	K946538LPR01VTE0		
	R10A	9 mm	K947871R0001VTSP	K946538R0001VTE0		
 G. Calacatta white G. Calacatta beyaz	LPR	9 mm	K947021LPR01VTSP	K945331LPR01VTE0		
	R10A	9 mm	K947021R0001VTSP	K945331R0001VTE0		
 Carrara white Carrara beyaz	LPR	9 mm	K947870LPR01VTSP	K946537LPR01VTE0		
	R10A	9 mm	K947870R0001VTSP	K946537R0001VTE0	K950696R0001VTE0	950699R0001VTE0







Colorbody porcelain Colorbody porselen	Surface Yüzey	Thickness Kalınlık	15x60 (6"x24") R 147x597	7,5x60 (3"x24") R 72x597
 Carrara white Carrara beyaz	R10A	9 mm	K950697R0001VTE0	K950698R0001VTE0



Herringbone cut decor /  
Balıksırtı kesme dekor



Brick cut decor /  
Tuğla kesme dekor

Decors Dekorlar	Surface Yüzey	Thickness Kalınlık	7x14	5x10 (2"x4") R 47x97
 St. Laurent black St. Laurent siyah	FLPR	9 mm	K9500968FLR1VTE0	K9456318FLR1VTE0
 Cloud grey Cloud gri	FLPR	9 mm	K9465708FLR1VTE0	K9466508FLR1VTE0
 G. Calacatta white G. Calacatta beyaz	FLPR	9 mm	K9503980FLR1VTE0	K950399FLPR1VTE0
 Carrara white Carrara beyaz	FLPR	9 mm	K9465688FLR1VTE0	K9466488FLR1VTE0

Sizes Ebatlar	Thickness Kalınlık (mm)	Box Kutu			Pallet Palet		
		Pcs Adet	m <sup>2</sup>	kg	Box Kutu	m <sup>2</sup>	kg
<b>Wall tiles / Duvar karoları</b>							
30x60 Non-rectified / Rektifiyesiz	9	6	1,08	15,93	48	51,84	790
30x60 Decor / Dekor	9	6	1,08	15,93	48	51,84	790
<b>Glazed porcelain / Sırlı porselen</b>							
60x120 Rectified / Rektifiyeli	9	2	1,44	29,52	36	51,84	1.098
60x60 Rectified / Rektifiyeli	9	4	1,44	29,52	30	43,20	911
30x60 Rectified / Rektifiyeli	9	6	1,08	21,28	40	43,20	876
5x10 Decor / Dekor	9	120	0,60	0,75	31	18,60	48
7x14 Decor / Dekor	9	10	0,80	1,18	32	25,60	63
<b>Colorbody porcelain / Colorbody porselen</b>							
15x60 Rectified / Rektifiyeli	9	11	1,00	19,24	48	48,00	949
30x30 Rectified / Rektifiyeli	9	11	1,00	16,15	60	60,00	994
7,5x60 Rectified / Rektifiyeli	9	6	0,27	4,46	96	25,92	453



# Calacatta

A ceramic series inspired by the world famous Italian luxury marble; Calacatta. It has grey shades on clear white background and can be used to create a fresh look in modern bathrooms, kitchens and other living spaces. The colorbody porcelain series is suitable for both wall and floor use, with honed touch surface alternatives and complemented with Rigato decors.

Dünyaca ünlü lüks Calacatta mermerinden esinlenen seramik serisi. Bembeyaz zemin üzerinde yer alan gri damarlı yapısıyla banyo, mutfak ve diğer yaşam alanlarında modern bir atmosfer yaratıyor. Seri, honed touch parlak saten yüzeyi ve Rigato dekoruyla yer ve duvar kullanımına uygun.

## Compatible collections / Uyumlu koleksiyonlar

Urbanwood  
Oakland  
mode #02  
Urbancrete

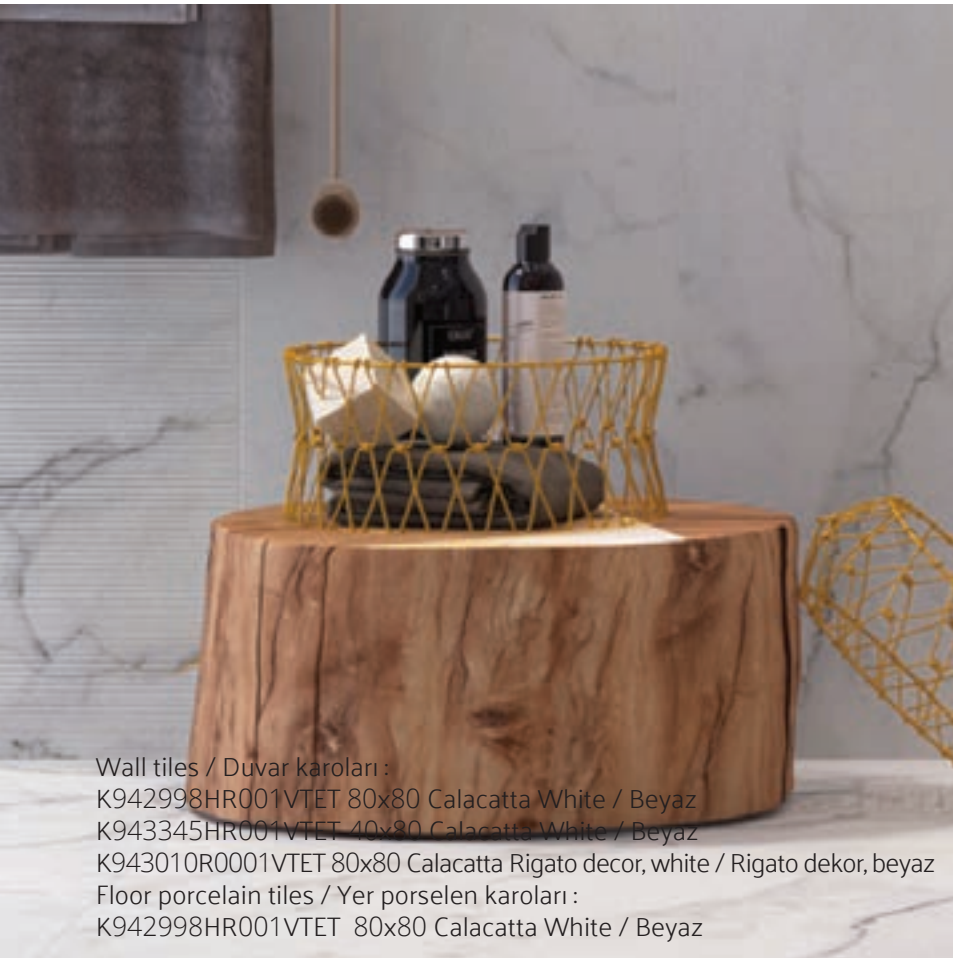

Wall tiles / Duvar karoları :  
K942998HR001VTET 80x80 Calacatta White / Beyaz  
K943345HR001VTET 40x80 Calacatta White / Beyaz  
K943010R0001VTET 80x80 Calacatta Rigato decor, white / Rigato dekor, beyaz  
Floor porcelain tiles / Yer porselen karoları :  
K942998HR001VTET 80x80 Calacatta White / Beyaz



Wall tiles / Duvar karoları :  
K942998HR001VTET 80x80 Calacatta White / Beyaz  
K943345HR001VTET 40x80 Calacatta White / Beyaz  
K943010R0001VTET 80x80 Calacatta Rigato decor, white / Rigato dekor, beyaz  
Floor porcelain tiles / Yer porselen karoları :  
K942998HR001VTET 80x80 Calacatta White / Beyaz



# Calacatta

Colorbody porcelain  
Colorbody porselen

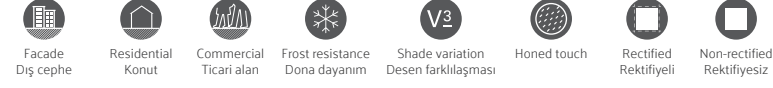

**Product standard / Ürün standardı**  
EN14411 Group Bla

**Footnotes / Dip notlar**  
H R

## Base Tiles / Fonlar

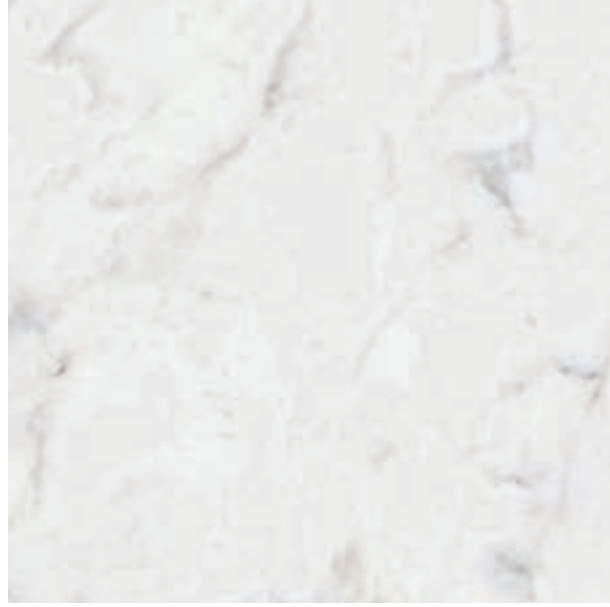

White / Beyaz

## Decors / Dekorlar



Rigato decor / Rigato dekor  
White / Beyaz

Glazed porcelain  
Sırlı porselen



**Product standard / Ürün standardı**  
EN14411 Group Bla

**Footnotes / Dip notlar**  
H R

## Base Tiles / Fonlar



White / Beyaz



Wall tiles / Duvar karoları :  
K942998HR001VTET 80x80 Calacatta White / Beyaz  
K943345HR001VTET 40x80 Calacatta White / Beyaz  
K943010R0001VTET 80x80 Calacatta Rigato decor, white / Rigato dekor, beyaz  
Floor porcelain tiles / Yer porselen karoları :  
K942998HR001VTET 80x80 Calacatta White / Beyaz



# Calacatta



80x80 White / Beyaz

200x100 5 Canvases / Kanvas (10 m<sup>2</sup>)



60x120 White / Beyaz

200x100 5 Canvases / Kanvas (10 m<sup>2</sup>)

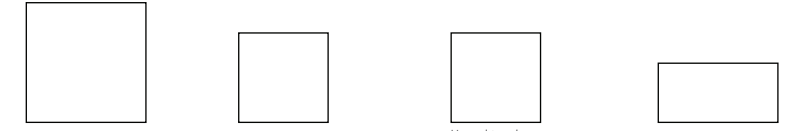

Colorbody porcelain Colorbody porselen	Surface Yüzey	Thickness Kalınlık	80x80 (32"x32") R 797x797	60x60 (24"x24") R 597x597	60x60 (24"x24") R 597x597	40x80 (16"x32") R 397x797
White Beyaz	FLPR	9 mm		K943958FLPR1VTE0	K943959HR001VTE0	
	HT	9 mm	K942998HR001VTET			K943345HR001VTET
	R9	9 mm	K942998R0001VTET			K942999R0001VTET

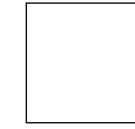

Rigato decor /  
Rigato dekor

Decors Dekorlar	Surface Yüzey	Thickness Kalınlık	80x80 (32"x32") R 797x797
White Beyaz	Matt / Mat	9 mm	K943010R0001VTET

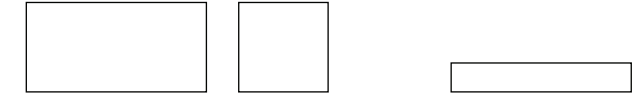

Glazed porcelain Sırlı porselen	Surface Yüzey	Thickness Kalınlık	60x120 (24"x48") R 597x1197	60x60 (24"x24") R 597x597	20x120 (24"x48") R 197x1197
White Beyaz	FLPR	9	K943006FLPR1VTSP	K943958FLPR1VTE0	K943007FLPR1VTET
	R10B	9		K947805R0001VTE0	

Sizes Ebatlar	Thickness Kalınlık (mm)	Box Kutu			Pallet Palet		
		Pcs Adet	m <sup>2</sup>	kg	Box Kutu	m <sup>2</sup>	kg
<b>Colorbody porcelain / Colorbody porselen</b>							
80x80 Rectified / Rektifiyeli	9	2	1,28	24,50	44	56,32	1.103
60x60 Rectified / Rektifiyeli	9	4	1,44	26,90	30	43,20	832
40x80 Rectified / Rektifiyeli	9	4	1,28	24,06	27	34,56	675
80x80 Decor / Dekor	9	2	1,28	24,50	44	56,32	1.103
<b>Glazed porcelain / Sırlı porselen</b>							
60x120 Rectified / Rektifiyeli	9	2	1,44	30,24	32	46,08	1.005
20x120 Rectified / Rektifiyeli	9	4	0,96	18,75	48	46,08	925
60x60 Rectified / Rektifiyeli	9	4	1,44	26,90	30	43,20	832





# Ceramic culture

## Seramik kültürü

Ceramics is the oldest wisdom of humankind. For thousands years, the ceramic culture brings new horizons to your creativity with the diverse texture and colour options it provides for architectural designs.

Seramik, insanlığın en eski bilgeliği. Dokuları, renkleri ve yapıları karakter kazandıran tasarım zenginliği ile binlerce yıllık seramik kültürü yaratıcılığınıza yeni kapılar açıyor.



# miniworx

VitrA presents miniworx innovative tiles system, consisting of basic tiles colours and sizes blended in a unique product and tiling model. miniworx brings together basic colours and rich surfaces, modular sizes and unprecedented shapes, limitless variations of innovative tiling options and wide opportunities to create different atmosphere spaces with various styles.

VitrA, benzersiz bir ürün ve döşeme modeliyle tasarladığı temel karo renkleri ve boyutlarından oluşan yenilikçi miniworx karo sistemini sunar. miniworx; temel renkleri ve zengin yüzeyleri, modüler boyutları ve benzersiz şekilleri, yenilikçi döşeme seçeneklerini ve çeşitli stillerle farklı atmosferde yaşam alanları yaratabileceğiniz geniş seçenekleri bir araya getiriyor.

## Compatible collections / Uyumlu koleksiyonlar

Ceppostone	CementMix
Urban Travertino	Marmori
Urbancrete	Craft
Urbanwood	Samba
Metalcrete	Urbanwood



Wall tiles / Duvar karoları :  
K50498080001VTE0 5x5 miniworx flat Black / Siyah  
Floor tiles / Yer karoları :  
K50498080001VTE0 5x5 miniworx flat Black / Siyah



Wall tiles / Duvar karoları :  
K94527900001VTE0 10x30 miniworx Bumpy White / Beyaz  
K94526200001VTE0 21x24 miniworx Hexagon Black / Siyah  
Floor tiles / Yer karoları :  
K94526200001VTE0 21x24 miniworx Hexagon Black / Siyah



# miniworx

Porcelain and ceramic floor tiles  
Porselen ve seramik yer karoları



**Product standard / Ürün standardı**  
EN14411 Group Bla  
EN 14411 Group Blb

## flat Black / Siyah



2,5x2,5 cm



2,5x5 cm



5x5 cm



5x10 cm



5x20 cm



10x10 cm



10x20 cm



10x30 cm



20x20 cm



30x30 cm

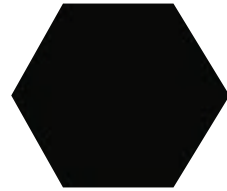

Hexagon 21x24 cm



Midi hexagon 8x9 cm



Mini hexagon ø 2,5 cm

## metro Black / Siyah



10x10 cm



10x20 cm



10x30 cm



20x20 cm

## bumpy Black / Siyah



10x10 cm

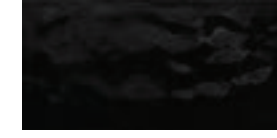

10x20 cm



10x30 cm

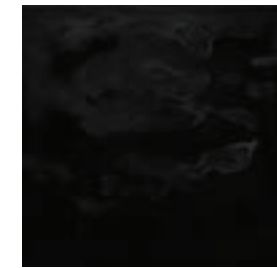

20x20 cm



# miniworx

Porcelain and ceramic floor tiles  
Porselen ve seramik yer karoları

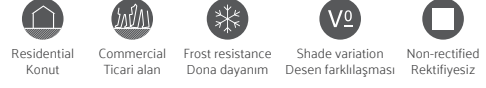

**Product standard / Ürün standardı**  
EN14411 Group Bla  
EN 14411 Group Blb

## flat White / Beyaz

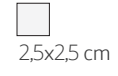

2,5x2,5 cm



2,5x5 cm



5x5 cm



5x10 cm



5x20 cm



10x10 cm



10x20 cm



10x30 cm



20x20 cm



30x30 cm

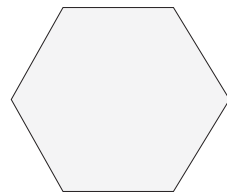

Hexagon 21x24 cm



Midi hexagon 8x9 cm



Mini hexagon ø 2,5 cm

## metro White / Beyaz



10x10 cm

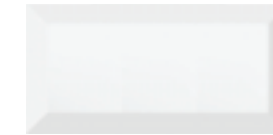

10x20 cm



10x30 cm

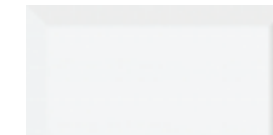

20x20 cm

## bumpy White / Beyaz



10x10 cm



10x20 cm



10x30 cm



20x20 cm



# miniworx

Porcelain and ceramic floor tiles  
Porselen ve seramik yer karoları

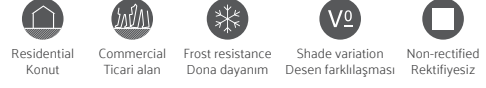

**Product standard / Ürün standardı**  
EN14411 Group Bla  
EN 14411 Group Blb

## flat Cream / Krem

 2,5x2,5 cm

 2,5x5 cm

 5x5 cm

 5x10 cm

 5x20 cm

 10x10 cm

 10x20 cm

 10x30 cm

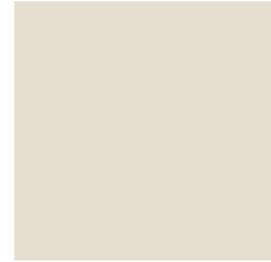
 20x20 cm

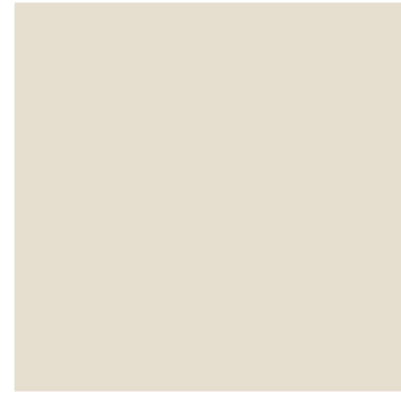
 30x30 cm

 Hexagon 21x24 cm

 Midi hexagon 8x9 cm

 Mini hexagon ø 2,5 cm

## metro Cream / Krem

 10x10 cm

 10x20 cm

 10x30 cm

 20x20 cm

## bumpy Cream / Krem

 10x10 cm

 10x20 cm

 10x30 cm

 20x20 cm



# miniworx

Porcelain and ceramic floor tiles  
Porselen ve seramik yer karoları



**Product standard / Ürün standardı**  
EN14411 Group Bla  
EN 14411 Group Blb

## flat Grey / Gri



2,5x2,5 cm

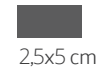

2,5x5 cm



5x5 cm



5x10 cm



5x20 cm



10x10 cm



10x20 cm



10x30 cm



20x20 cm



30x30 cm

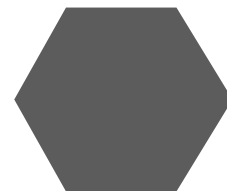

Hexagon 21x24 cm



Midi hexagon 8x9 cm



Mini hexagon ø 2,5 cm

## metro Grey / Gri



10x10 cm



10x20 cm



10x30 cm



20x20 cm

## bumpy Grey / Gri



10x10 cm



10x20 cm



10x30 cm



20x20 cm



# miniworx

Floor tiles  
Yer karoları



Product standard / Ürün standardı  
EN 14411 Group B1b

## metro Gold / Altın



10x20 cm



20x20 cm

## bumpy Gold / Altın



10x20 cm



20x20 cm



Wall tiles / Duvar karoları :  
K94528600001VTE0 10x20 miniworx metro Gold / Altın  
K94530500001VTE0 10x20 miniworx metro Black / Siyah  
K94528380001VTE0 10x10 miniworx metro Black / Siyah



**Product standard / Ürün standardı**

EN14411 Group Bla  
EN 14411 Group Blb

## flat

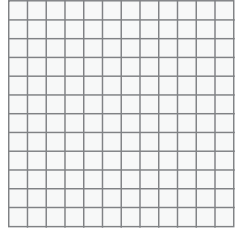

2,5x2,5 cm  
White, Matt / Beyaz, Mat  
White, Glossy / Beyaz, Parlak  
Cream, Matt / Krem, Mat  
Cream, Glossy / Krem, Parlak  
Black, Matt / Siyah, Mat  
Black, Glossy / Siyah, Parlak  
Grey, Matt / Gri, Mat  
Grey, Glossy / Gri, Parlak

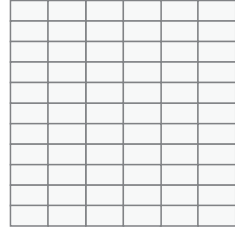

2,5x5 cm  
White, Matt / Beyaz, Mat  
White, Glossy / Beyaz, Parlak  
Cream, Matt / Krem, Mat  
Cream, Glossy / Krem, Parlak  
Black, Matt / Siyah, Mat  
Black, Glossy / Siyah, Parlak  
Grey, Matt / Gri, Mat  
Grey, Glossy / Gri, Parlak



5x20 cm  
White, Matt / Beyaz, Mat  
White, Glossy / Beyaz, Parlak  
Cream, Matt / Krem, Mat  
Cream, Glossy / Krem, Parlak  
Black, Matt / Siyah, Mat  
Black, Glossy / Siyah, Parlak  
Grey, Matt / Gri, Mat  
Grey, Glossy / Gri, Parlak

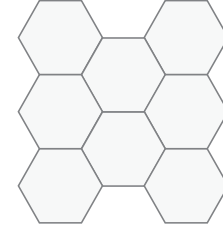

Midi Hexagon 8x9 cm  
White, Matt / Beyaz, Mat  
Cream, Matt / Krem, Mat  
Black, Matt / Siyah, Mat  
Grey, Matt / Gri, Mat

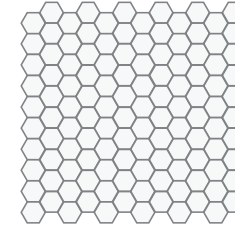

Mini Hexagon ø 2,5 cm  
White, Matt / Beyaz, Mat  
Cream, Matt / Krem, Mat  
Black, Matt / Siyah, Mat  
Grey, Matt / Gri, Mat

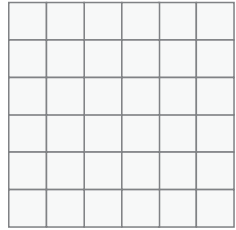

5x5 cm  
White, Matt / Beyaz, Mat  
White, Glossy / Beyaz, Parlak  
Cream, Matt / Krem, Mat  
Cream, Glossy / Krem, Parlak  
Black, Matt / Siyah, Mat  
Black, Glossy / Siyah, Parlak  
Grey, Matt / Gri, Mat  
Grey, Glossy / Gri, Parlak

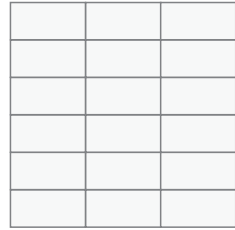

5x10 cm  
White, Matt / Beyaz, Mat  
White, Glossy / Beyaz, Parlak  
Cream, Matt / Krem, Mat  
Cream, Glossy / Krem, Parlak  
Black, Matt / Siyah, Mat  
Black, Glossy / Siyah, Parlak  
Grey, Matt / Gri, Mat  
Grey, Glossy / Gri, Parlak

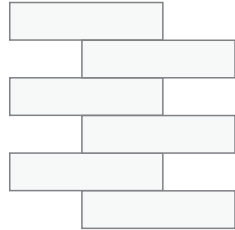

5x20 cm  
Brick / Tuğla  
White, Matt / Beyaz, Mat  
White, Glossy / Beyaz, Parlak  
Cream, Matt / Krem, Mat  
Cream, Glossy / Krem, Parlak  
Black, Matt / Siyah, Mat  
Black, Glossy / Siyah, Parlak  
Grey, Matt / Gri, Mat  
Grey, Glossy / Gri, Parlak

## mix

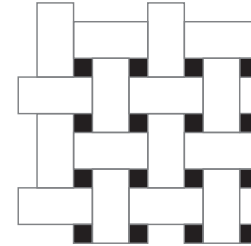

30x30 cm  
Basket mix / Sepet mix  
White, Black, Matt / Beyaz, Siyah, Mat  
White, Grey, Matt / Beyaz, Gri, Mat

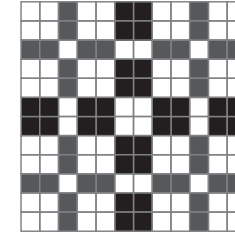

2,5x2,5 cm  
Decor mix / Dekor mix  
White, Black, Grey, Matt / Beyaz, Siyah, Gri, Mat

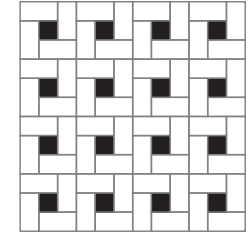

30x30 cm  
Windmill mix / Fırıldak mix  
White, Black, Matt / Beyaz, Siyah, Mat

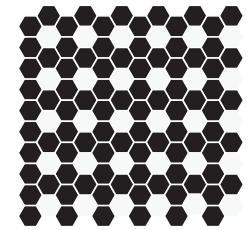

Mini Hexagon ø 2,5 cm  
White Mix, Matt / Beyaz Mix, Mat  
Black Mix, Matt / Siyah Mix, Mat

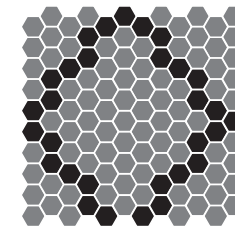

Mini Hexagon ø 2,5 cm  
Grey-White Mix / Gri-Beyaz Mix  
Grey-Black Mix / Gri-Siyah Mix

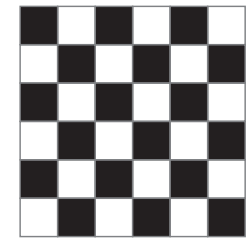

5x5 cm  
Chess mix / Satranç mix  
White, Black, Matt / Beyaz, Siyah, Mat

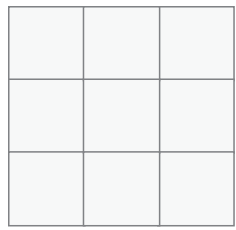

10x10 cm  
White, Matt / Beyaz, Mat  
White, Glossy / Beyaz, Parlak  
White, Matt glossy mix / Beyaz, Mat parlak mix  
Cream, Matt / Krem, Mat  
Cream, Glossy / Krem, Parlak  
Cream, Matt glossy mix / Krem, Mat parlak mix  
Black, Matt / Siyah, Mat  
Black, Glossy / Siyah, Parlak  
Black, Matt glossy mix / Siyah, Mat parlak mix  
Grey, Matt / Gri, Mat  
Grey, Glossy / Gri, Parlak  
Grey, Matt glossy mix / Gri, Mat parlak mix

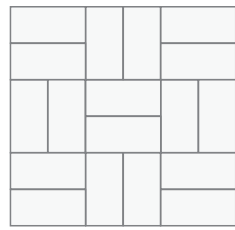

5x10 cm  
Crosshatch / Çapraz döşeme  
White, Matt / Beyaz, Mat  
White, Glossy / Beyaz, Parlak  
Cream, Matt / Krem, Mat  
Cream, Glossy / Krem, Parlak  
Black, Matt / Siyah, Mat  
Black, Glossy / Siyah, Parlak  
Grey, Matt / Gri, Mat  
Grey, Glossy / Gri, Parlak

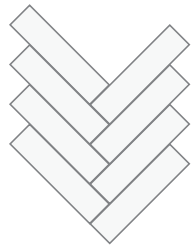

5x20 cm  
Herringbone / Balıksırtı  
White, Matt / Beyaz, Mat  
White, Glossy / Beyaz, Parlak  
White, Matt glossy mix / Beyaz, Mat parlak mix  
Cream, Matt / Krem, Mat  
Cream, Glossy / Krem, Parlak  
Cream, Matt glossy mix / Krem, Mat parlak mix  
Black, Matt / Siyah, Mat  
Black, Glossy / Siyah, Parlak  
Black, Matt glossy mix / Siyah, Mat parlak mix  
Grey, Matt / Gri, Mat  
Grey, Glossy / Gri, Parlak  
Grey, Matt glossy mix / Gri, Mat parlak mix

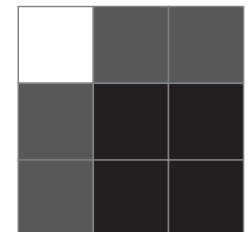

10x10 cm  
Decor mix / Dekor mix  
White, Black, Grey, Matt / Beyaz, Siyah, Gri, Mat

## metro



10x10 cm  
White, Glossy / Beyaz, Parlak  
Cream, Glossy / Krem, Parlak  
Black, Glossy / Siyah, Parlak  
Grey, Glossy / Gri, Parlak

## bumpy

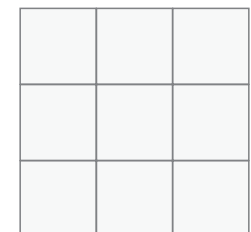

10x10 cm  
White, Glossy / Beyaz, Parlak  
Cream, Glossy / Krem, Parlak  
Black, Glossy / Siyah, Parlak  
Grey, Glossy / Gri, Parlak



# miniworx

Complementary pieces  
Tamamlayıcı parçalar



Product standard / Ürün standardı  
EN14411 Gruppe Bla

## All Round Black / Siyah



10x10 cm  
Down-out external corner  
Alt dış köşe parçası  
ADK1010



5x10 cm  
External beading  
Dış profil  
DP510



5x5 cm  
Up-out external corner  
Üst dış köşe parçası  
UDK55



5x5 cm  
Down-in internal corner  
Alt iç köşe parçası  
AIK55

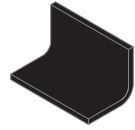

5x10 cm  
Internal beading  
İç profil  
IP510



10x10 cm  
Up-in internal corner  
Üst iç köşe parçası  
UIK1010

## All Round White / Beyaz



10x10 cm  
Down-out external corner  
Alt dış köşe parçası  
ADK1010

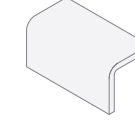

5x10 cm  
External beading  
Dış profil  
DP510



5x5 cm  
Up-out external corner  
Üst dış köşe parçası  
UDK55



5x5 cm  
Down-in internal corner  
Alt iç köşe parçası  
AIK55

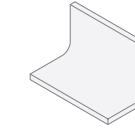

5x10 cm  
Internal beading  
İç profil  
IP510



10x10 cm  
Up-in internal corner  
Üst iç köşe parçası  
UIK1010

## Right angled sit-in / Köşeli dönüş parçaları sit-in

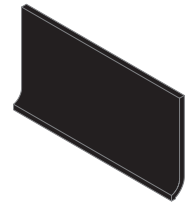

10x20 cm  
Covebase sit-in  
Kenar dönüş parçası sit-in  
KDI1020



10x10 cm  
Covebase sit-in  
Kenar dönüş parçası sit-in  
KDI1010



3x10 cm  
Covebase external corner sit-in  
Dış köşe dönüş parçası sit-in  
DKI310



2x10 cm  
Covebase internal corner sit-in  
İç köşe dönüş parçası sit-in  
IK210



2x20 cm  
Internal beading sit-in  
İç profil sit-in  
IP220



2x20 cm  
External beading sit-in  
Dış profil sit-in  
DP220

## Right angled sit-in / Köşeli dönüş parçaları sit-in

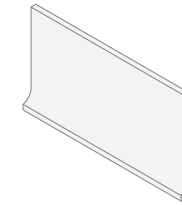

10x20 cm  
Covebase sit-in  
Kenar dönüş parçası sit-in  
KDI1020



10x10 cm  
Covebase sit-in  
Kenar dönüş parçası sit-in  
KDI1010



3x10 cm  
Covebase external corner sit-in  
Dış köşe dönüş parçası sit-in  
DKI310



2x10 cm  
Covebase internal corner sit-in  
İç köşe dönüş parçası sit-in  
IK210



2x20 cm  
Internal beading sit-in  
İç profil sit-in  
IP220



2x20 cm  
External beading sit-in  
Dış profil sit-in  
DP220



# miniworx

Complementary pieces  
Tamamlayıcı parçalar



Product standard / Ürün standardı  
EN14411 Gruppe Bla

## All Round Cream / Krem

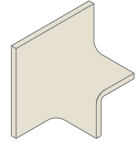

10x10 cm  
Down-out external corner  
Alt dış köşe parçası  
ADK1010

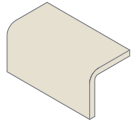

5x10 cm  
External beading  
Dış profil  
DP510



5x5 cm  
Up-out external corner  
Üst dış köşe parçası  
UDK55

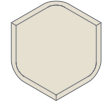

5x5 cm  
Down-in internal corner  
Alt iç köşe parçası  
AIK55

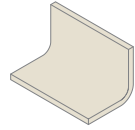

5x10 cm  
Internal beading  
İç profil  
IP510

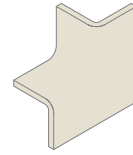

10x10 cm  
Up-in internal corner  
Üst iç köşe parçası  
UIK1010

## All Round Grey / Gri



10x10 cm  
Down-out external corner  
Alt dış köşe parçası  
ADK1010



5x10 cm  
External beading  
Dış profil  
DP510



5x5 cm  
Up-out external corner  
Üst dış köşe parçası  
UDK55



5x5 cm  
Down-in internal corner  
Alt iç köşe parçası  
AIK55

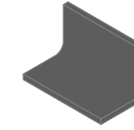

5x10 cm  
Internal beading  
İç profil  
IP510



10x10 cm  
Up-in internal corner  
Üst iç köşe parçası  
UIK1010

## Right angled sit-in / Köşeli dönüş parçaları sit-in

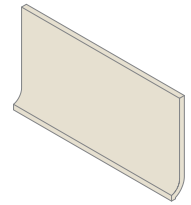

10x20 cm  
Covebase sit-in  
Kenar dönüş parçası sit-in  
KDI1020

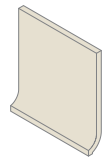

10x10 cm  
Covebase sit-in  
Kenar dönüş parçası sit-in  
KDI1010

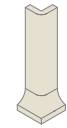

3x10 cm  
Covebase external corner sit-in  
Dış köşe dönüş parçası sit-in  
DKI310

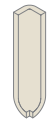

2x10 cm  
Covebase internal corner sit-in  
İç köşe dönüş parçası sit-in  
IK210



2x20 cm  
Internal beading sit-in  
İç profil sit-in  
IP220



2x20 cm  
External beading sit-in  
Dış profil sit-in  
DP220

## Right angled sit-in / Köşeli dönüş parçaları sit-in

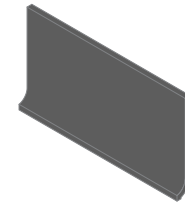

10x20 cm  
Covebase sit-in  
Kenar dönüş parçası sit-in  
KDI1020



10x10 cm  
Covebase sit-in  
Kenar dönüş parçası sit-in  
KDI1010



3x10 cm  
Covebase external corner sit-in  
Dış köşe dönüş parçası sit-in  
DKI310



2x10 cm  
Covebase internal corner sit-in  
İç köşe dönüş parçası sit-in  
IK210



2x20 cm  
Internal beading sit-in  
İç profil sit-in  
IP220



2x20 cm  
External beading sit-in  
Dış profil sit-in  
DP220





Tile mats / flat Fileli ürünler / flat	Surface Yüzey	Thickness Kalınlık	2,5x2,5	2,5x5	5x5
Black Siyah	Matt / Mat	6 mm	K02765580001VTE0	K51688480001VTE0	K50498080001VTE0
	Glossy / Parlak	6 mm	K02766680001VTE0	K51731580001VTE0	K50565480001VTE0
White Beyaz	Matt / Mat	6 mm	K02770380001VTE0	K51684080001VTE0	K50488480001VTE0
	Glossy / Parlak	6 mm	K02771480001VTE0	K51727180001VTE0	K50560680001VTE0
Cream Krem	Matt / Mat	6 mm	K02779580001VTE0	K51689580001VTE0	K50494380001VTE0
	Glossy / Parlak	6 mm	K02780680001VTE0	K51732680001VTE0	K50715080001VTE0
Grey Gri	Matt / Mat	6 mm	K02900080001VTE0	K51691080001VTE0	K50493280001VTE0
	Glossy / Parlak	6 mm	K02901180001VTE0	K51734180001VTE0	K51575380001VTE0



Tile mats / flat Fileli ürünler / flat	Surface Yüzey	Thickness Kalınlık	5x10	5x10
Black Siyah	Matt / Mat	6 mm	K51070180001VTE0	K94557280001VTE0
	Glossy / Parlak	6 mm	K54185180001VTE0	K94557380001VTE0
White Beyaz	Matt / Mat	6 mm	K51069080001VTE0	K94557080001VTE0
	Glossy / Parlak	6 mm	K51240380001VTE0	K94557180001VTE0
Cream Krem	Matt / Mat	6 mm	K54185480001VTE0	K94557480001VTE0
	Glossy / Parlak	6 mm	K54185580001VTE0	K94557580001VTE0
Grey Gri	Matt / Mat	6 mm	K94758780001VTE0	K94758680001VTE0
	Glossy / Parlak	6 mm	K51263680001VTE0	K94758280001VTE0



Tile mats / flat Fileli ürünler / flat	Surface Yüzey	Thickness Kalınlık	5x20	5x20	5x20	10x10
Black Siyah	Matt / Mat	6 mm	K54186680001VTE0	K54188280001VTE0	K54186880001VTE0	K50797580001VTE0
	Glossy / Parlak	6 mm	K54186980001VTE0	K54187080001VTE0	K54187180001VTE0	K50535280001VTE0
	Matt & glossy Mat & parlak	6 mm			K94948380001VTE0	K94946980001VTE0
White Beyaz	Matt / Mat	6 mm	K54185980001VTE0	K54186080001VTE0	K54186180001VTE0	K50792080001VTE0
	Glossy / Parlak	6 mm	K54186280001VTE0	K54186480001VTE0	K54186580001VTE0	K50382380001VTE0
	Matt & glossy Mat & parlak	6 mm			K94948180001VTE0	K94946780001VTE0
Cream Krem	Matt / Mat	6 mm	K54187280001VTE0	K54187380001VTE0	K54187580001VTE0	K54207380001VTE0
	Glossy / Parlak	6 mm	K54187680001VTE0	K54187780001VTE0	K54187880001VTE0	K50956580001VTE0
	Matt & glossy Mat & parlak	6 mm			K94948480001VTE0	K94947080001VTE0
Grey Gri	Matt / Mat	6 mm	K94758880001VTE0	K94758980001VTE0	K94759080001VTE0	K50794280001VTE0
	Glossy / Parlak	6 mm	K94758380001VTE0	K94758480001VTE0	K94758580001VTE0	K50733480001VTE0
	Matt & glossy Mat & parlak	6 mm			K94948280001VTE0	K94946880001VTE0



flat	Surface Yüzey	Thickness Kalınlık	10x20	10x30	20x20	30x30
Black Siyah	Matt / Mat	6 mm	K50068400001VTE0	K79059400001VTE0	K78047400001VTE0	
	Matt / Mat	7 mm				K94773100001VTE0
	Glossy / Parlak	6 mm	K77635500001VTE0	K79421200001VTE0	K79845100001VTE0	
White Beyaz	Matt / Mat	6 mm	K50079100001VTE0	K78512200001VTE0	K78042600001VTE0	
	Matt / Mat	7 mm				K94772900001VTE0
	Glossy / Parlak	6 mm	K76635600001VTE0	K79060500001VTE0	K75907100001VTE0	
Cream Krem	Matt / Mat	6 mm	K54210600001VTE0	K54213200001VTE0	K94367100001VTE0	
	Matt / Mat	7 mm				K80768100001VTE0
	Glossy / Parlak	6 mm	K53802400001VTE0	K79301100001VTE0	K79809000001VTE0	
Grey Gri	Matt / Mat	6 mm	K50272500001VTE0	K78591400001VTE0	K50209500001VTE0	
	Matt / Mat	7 mm				K75444500001VTE0
	Glossy / Parlak	6 mm	K89100000001VTE0	K79424500001VTE0	K79818200001VTE0	



flat	Surface Yüzey	Thickness Kalınlık	21x24	8x9	2,5x2,5
Black Siyah	Matt / Mat	6	K94526200001VTE0	K53256480001VTE0	K53012580001VTE0
White Beyaz	Matt / Mat	6	K94526100001VTE0	K53255380001VTE0	K53011480001VTE0
Cream Krem	Matt / Mat	6	K94526300001VTE0	K53257580001VTE0	K54185680001VTE0
Grey Gri	Matt / Mat	6	K94759200001VTE0	K94760180001VTE0	K94759180001VTE0
White mix Beyaz mix	Matt / Mat	6			K54185780001VTE0
Black mix Siyah mix	Matt / Mat	6			K54185880001VTE0
Grey, white mix Gri, beyaz mix	Matt / Mat	6			K94779380001VTE0
Grey, black mix Gri, siyah mix	Matt / Mat	6			K94779480001VTE0



mix	Surface Yüzey	Thickness Kalınlık	2,5x2,5	5x5	10x10
White, black Beyaz, siyah	Matt / Mat	6 mm		K95133980001VTE0	
White, black, grey Beyaz, siyah, gri	Matt / Mat	6 mm	K95133880001VTE0		K95134080001VTE0





mix	Surface Yüzey	Thickness Kalınlık	30x30	30x30
White, black Beyaz, siyah	Matt / Mat	6 mm	K95082580001VTE0	K95133780001VTE0
White, grey Beyaz, gri	Matt / Mat	6 mm	K95082480001VTE0	



metro	Surface Yüzey	Thickness Kalınlık	10x10	10x20	10x30	20x20
Black Siyah	Glossy / Parlak	6 mm	K94528380001VTE0			
	Glossy / Parlak	7 mm		K94530500001VTE0	K94529100001VTE0	K94528800001VTE0
	Glossy / Parlak	7,5 mm		K53774400001VTE0		
White Beyaz	Glossy / Parlak	6 mm	K94528280001VTE0			
	Glossy / Parlak	7 mm		K94530400001VTE0	K94529000001VTE0	K94528700001VTE0
	Glossy / Parlak	7,5 mm		K53773300001VTE0		
Cream Krem	Glossy / Parlak	6 mm	K94528480001VTE0			
	Glossy / Parlak	7 mm		K94528500001VTE0	K94529200001VTE0	K94528900001VTE0
	Glossy / Parlak	7,5 mm		K53775500001VTE0		
Grey Gri	Glossy / Parlak	6 mm	K94759780001VTE0			
	Glossy / Parlak	7 mm		K94759800001VTE0	K94760000001VTE0	K94759900001VTE0
	Glossy / Parlak	7,5 mm		K94914500001VTE0		
Gold Altın	Glossy / Parlak	7 mm		K94528600001VTE0		K94551300001VTE0



bumpy	Surface Yüzey	Thickness Kalınlık	10x10	10x20	10x30	20x20
Black Siyah	Glossy / Parlak	6 mm	K94527080001VTE0	K94527400001VTE0	K94528000001VTE0	K94527700001VTE0
White Beyaz	Glossy / Parlak	6 mm	K94526880001VTE0	K94527300001VTE0	K94527900001VTE0	K94527600001VTE0
Cream Krem	Glossy / Parlak	6 mm	K94527180001VTE0	K94527500001VTE0	K94528100001VTE0	K94527800001VTE0
Grey Gri	Glossy / Parlak	6 mm	K94759380001VTE0	K94759400001VTE0	K94759600001VTE0	K94759500001VTE0
Gold Altın	Glossy / Parlak	6 mm		K94550900001VTE0		K94551200001VTE0



All Round	Surface Yüzey	Thickness Kalınlık	10x10	5x10	5x5
Black Siyah	Glossy / Parlak	6 mm	K94956200001VTE0	K94955800001VTE0	K94957000001VTE0
White Beyaz	Glossy / Parlak	6 mm	K94956100001VTE0	K94955700001VTE0	K94956900001VTE0
Cream Krem	Glossy / Parlak	6 mm	K94956300001VTE0	K94955900001VTE0	K94957100001VTE0
Grey Gri	Glossy / Parlak	6 mm	K94956400001VTE0	K94956000001VTE0	K94957200001VTE0





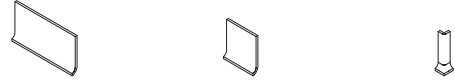

All Round	Surface Yüzey	Thickness Kalınlık	10x10	5x10	5x5
Black Siyah	Glossy / Parlak	6 mm	K94956600001VTE0	K94955400001VTE0	K94957400001VTE0
White Beyaz	Glossy / Parlak	6 mm	K94956500001VTE0	K94955300001VTE0	K94957300001VTE0
Cream Krem	Glossy / Parlak	6 mm	K94956700001VTE0	K94955500001VTE0	K94957500001VTE0
Grey Gri	Glossy / Parlak	6 mm	K94956800001VTE0	K94955600001VTE0	K94957600001VTE0



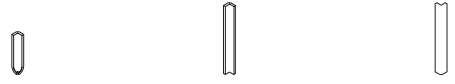

Right angled sit-in Köşeli dönüş parçaları sit-in	Surface Yüzey	Thickness Kalınlık	10x20	10x10	3x10
 Black Siyah	Matt / Mat	6 mm	K94953100001VTE0	K94952500001VTE0	K94951900001VTE0
 White Beyaz	Matt / Mat	6 mm	K94953000001VTE0	K94952400001VTE0	K94951800001VTE0
 Cream Krem	Matt / Mat	6 mm	K94947500001VTE0	K94947400001VTE0	K94955000001VTE0
 Grey Gri	Matt / Mat	6 mm	K94953500001VTE0	K94952900001VTE0	K94952300001VTE0



Right angled sit-in Köşeli dönüş parçaları sit-in	Surface Yüzey	Thickness Kalınlık	2x10	2x20	2x20
 Black Siyah	Matt / Mat	6 mm	K94951300001VTE0	K94953700001VTE0	K94954300001VTE0
 White Beyaz	Matt / Mat	6 mm	K94951200001VTE0	K94953600001VTE0	K94954200001VTE0
 Cream Krem	Matt / Mat	6 mm	K94954900001VTE0	K94955100001VTE0	K94955200001VTE0
 Grey Gri	Matt / Mat	6 mm	K94951700001VTE0	K94954100001VTE0	K94954700001VTE0

Sizes Ebatlar	Thickness Kalınlık (mm)	Box Kutu			Pallet Palet		
		Pcs Adet	m <sup>2</sup>	kg	Box Kutu	m <sup>2</sup>	kg
<b>Glazed porcelain / Sırlı porselen</b>							
2,5x2,5 Hexagon / Altıgen	6	11	1	11	42	42	487
2,5x5 Non-rectified / Rektifiyesiz	6	792	1	11,1	42	42	491,2
2,5x2,5 Non-rectified / Rektifiyesiz	6	11	1	11	42	42	487
8x9 Hexagon / Altıgen	6	99,18	0,57	7,923	42	23,94	357,766
<b>Floor tiles / Yer karoları</b>							
5x5 Non-rectified / Rektifiyesiz	6	11	1	11,75	78	78	941,5
5x10 Crosshatch / Çapraz döşeme	6	198	1	12,1	78	78	968,8
5x10 Non-rectified / Rektifiyesiz	6	198	1	12,1	78	78	968,8
10x10 Non-rectified / Rektifiyesiz	6	11	1	12,5	78	78	1000
5x20 Herringbone / Balıksırtı	6	88	0,88	9,944	60	52,8	621,64
5x20 Brick decor / Tuğla dekor	6	96	0,96	11,52	48	46,08	577,96
5x20 Non-rectified / Rektifiyesiz	6	66	0,66	8,25	120	79,2	1015
10x20 Non-rectified / Rektifiyesiz	6	50	1	12,7	84	84	1091,8
10x30 Non-rectified / Rektifiyesiz	6	33	1	12,05	72	72	892,6
20x20 Non-rectified / Rektifiyesiz	6	25	1	12,7	84	84	1091,8
21x24 Hexagon / Altıgen	6	25	1	12,7	76	76	990,2
30x30 Non-rectified / Rektifiyesiz	7	11	1	14,79	72	72	1089,88
<b>Metro</b>							
10x10 Non-rectified / Rektifiyesiz	6	8,91	0,81	10,125	78	63,18	814,75
10x20 Non-rectified / Rektifiyesiz	7	50	1	14,15	72	72	1043,8
10x20 Non-rectified / Rektifiyesiz	7,5	40	0,8	11,92	84	67,2	1026,28
10x30 Non-rectified / Rektifiyesiz	7	33	1	12,91	66	66	877,06
20x20 Non-rectified / Rektifiyesiz	7	25	1	14,15	72	72	1043,8
<b>Bumpy</b>							
10x10 Non-rectified / Rektifiyesiz	6	11	1	12,5	78	78	1000
10x20 Non-rectified / Rektifiyesiz	6	50	1	12,45	84	84	1070,8
10x30 Non-rectified / Rektifiyesiz	6	33	1	12,05	72	72	892,6
20x20 Non-rectified / Rektifiyesiz	6	25	1	12,7	84	84	1091,8
<b>All Round</b>							
5x5 Non-rectified / Rektifiyesiz	6	2	0,005	0,4			
5x10 Non-rectified / Rektifiyesiz	6	54	0,27	10,8			
10x10 Non-rectified / Rektifiyesiz	6	3	0,03	0,6			
<b>Right angled sit-in</b>							
2x10 Non-rectified / Rektifiyesiz	6	20	0,04	1,04			
3x10 Non-rectified / Rektifiyesiz	6	12	0,04	1,368			
2x20 Non-rectified / Rektifiyesiz	6	20	0,055	1			
10x10 Non-rectified / Rektifiyesiz	6	15	0,15	2,1			
10x20 Non-rectified / Rektifiyesiz	6	18	0,36	6,3			



# Color Line

A ceramic collection that combines the timeless beauty of mosaics with shades of blue and green enriched with natural colour transitions. Color Line enlivens different areas of use from bathrooms to kitchens or sports facilities to pools, reflecting the colourful atmosphere of mosaics.

Mozaiğin zamana karşı duran güzelliğini, mavi ve yeşil tonlarının doğal renk geçişleriyle zenginleştirilmiş kombinasyonlarında bir araya getiren seramik koleksiyonu Color Line, banyolardan mutfaklara, spor tesislerinden havuzlara farklı kullanım alanlarını mozaiğin renkli dünyasıyla canlandırıyor.



Wall tiles / Duvar karoları :  
K50898280001VTE0 5x5 Color Line Green-blue / Yeşil-mavi



Wall tiles / Duvar karoları :  
K50898280001VTE0 5x5 Color Line Green-blue / Yeşil-mavi



# Color Line

Floor tiles  
Yer karoları



Product standard / Ürün standardı  
EN 14411 Group B1b

## Base Tiles / Fonlar

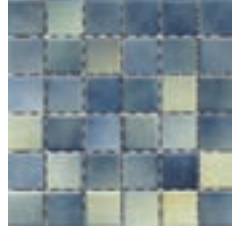

Green-blue / Yeşil-mavi

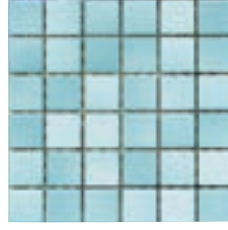

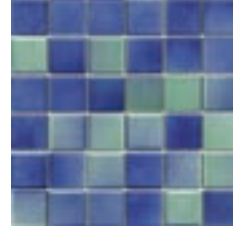

Pool blue / Havuz mavi



Dark blue - Green / Koyu mavi - Yeşil



Floor tiles Yer karoları	Surface Yüze	Thickness Kalınlık	5x5 (2"x2") 47x47
 Green-blue Yeşil-mavi	Glossy / Parlak	6 mm	K50898280001VTE0 (NN/NF)
	Glossy / Parlak	6 mm	K50898270001VTE0 (DM)
 Pool blue Havuz mavi	Glossy / Parlak	6 mm	K51050180001VTE0 (NN/NF)
	Glossy / Parlak	6 mm	K51050170001VTE0 (DM)
 Dark Blue-Green Koyu Mavi-Yeşil	Glossy / Parlak	6 mm	K51292080001VTE0 (NN/NF)
	Glossy / Parlak	6 mm	K51292070001VTE0 (DM)

Sizes Ebatlar	Thickness Kalınlık (mm)	Box Kutu			Pallet Palet		
		Pcs Adet	m <sup>2</sup>	kg	Box Kutu	m <sup>2</sup>	kg
Floor tiles / Yer karoları							
5x5 Non-rectified / Rektifiyesiz	6	11	1,00	11,75	42	42,00	519



Wall tiles / Duvar karoları :  
K50898280001VTE0 5x5 Color Line Green-blue / Yeşil-mavi



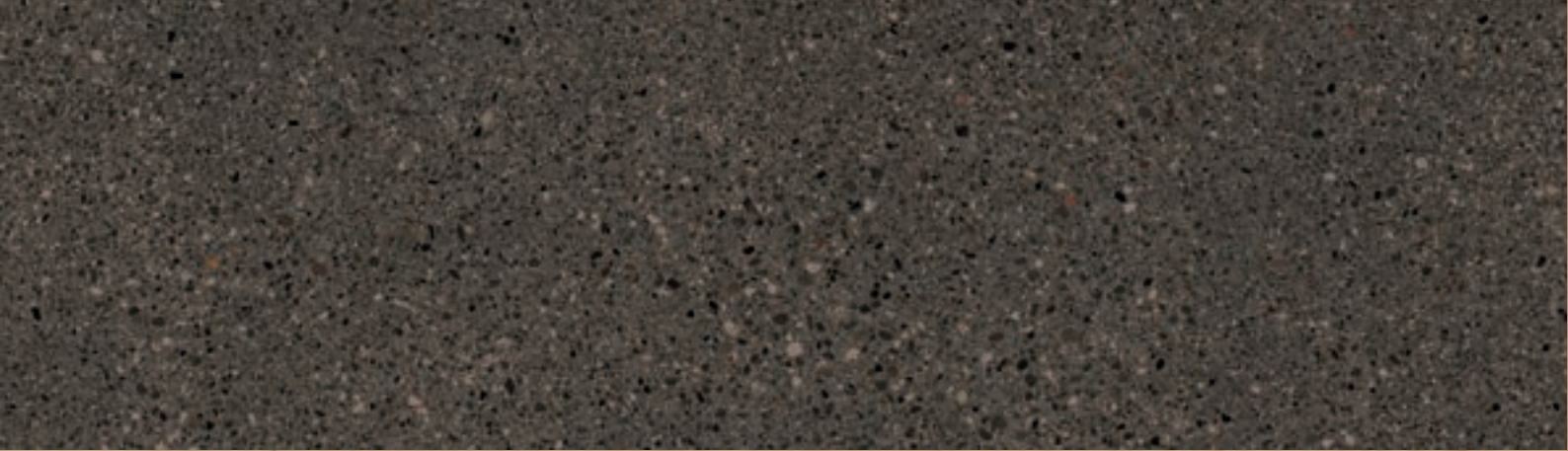

# Technical information

Teknik bilgiler



## Footnotes / Dipnotlar

- A** Cut borders must be set together with Non-rectified tiles.  
Kesme bordürler rektifiye edilmemiş karolarla kullanılmalıdır.
- B** The products are coated with metallic glazes. Scratch and acid resistance of metallic glazes is lower than ordinary glazes.Please clean with pure water, liquid regular glass cleaner or dish washing liquids only by using a soft cloth. Please avoid contact with acidic or harder materials or powders.  
Ürünlerin üzeri metalik sırla kaplanmıştır. Bronz, altın ve platin gibi metalik Sırlı ürünlerin çizilme ve asit direnci normal sırlardan düşüktür. Günlük temizlik için lütfen ürününüzü temiz su, cam-sil veya sıvı bulaşık deterjanı ile temizleyiniz ve temizledikten sonra yumuşak bezle siliniz. Lütfen Sırlı yüzeyin asidik ve daha sert bir malzeme veya toz deterjanla temasını önleyiniz.
- C** Surface of the tile is covered with special glaze Vitra clean. Vitra clean coated products are not suitable for floor.  
Karo yüzeyi Vitra clean kaplanmıştır. Vitra clean kaplı ürünler Yer karosu olarak kullanılamaz.
- E** Please add one of the below options at the end of the mosaic code.  
7 Dot mounted  
8 Nylon net  
Mozaik ürünleri sipariş verirken, kodun sonuna aşağıdaki seçeneklerden birisi eklenmelidir  
7 Dot mounted  
8 Nylon file
- F** Suitable for both wall and floor.  
Duvar ve Yer karosu olarak kullanılabilir.
- G** It is not suitable for heavy traffic areas  
Hareket yoğunluğu fazla olan yerlerde kullanılmamalıdır
- H** Each tile has different shades of the colour and slightly different designs to give real natural stone, marble, wood or cement impression.  
Gerçek doğal taş, mermer, ahşap veya beton görünümünü vermek için ürünlerin herbiri birbirinden farklı tonlarda ve bazen de farklılaşan desenlerde üretilmiştir.
- J** When ordering Cut borders please specify whether the tile, which will be used with the border, is rectified or Non-rectified.  
Kesme bordürler için sipariş girilirken, birlikte kullanılacak olan porselen karonun rektifiye yada rektifiyesiz olduğu mutlaka belirtilmelidir.
- K** When ordering plinths in 8,5x45 and 8,5x60 format, please specify the characteristics of the tile, which will be used with the plinth, such as matte, lappato, rectified, lappato rectified, etc.  
8,5x45 ve 8,5x60 ebatında süpürgelik siparişi girileceği zaman birlikte kullanılacak yer karolarının mat, lappatto, lappatto rektifiye özelliklerinden hangisine sahip olduğu mutlaka belirtilmelidir.
- M** **Glass tiles**  
**Cutting / Perforation:** Tiles shall be cut using a cutting saw equipped with a diamond disk and ensuring water supply. Perforation shall be performed in both directions, at low speed and with water supply.  
**Tile laying:** When laying glass products you should use an adhesive composition for Porcelain or Porcelain Rapid (the short-acting adhesive composition for Porcelain). When laying glass products of bronze, golden or platinum colours you should use the adhesive composition named Gri Flex Rapid, for products of any other colour-the adhesive composition named Beyaz Flex Rapid.  
In order to avoid formation of air gaps you should use a fine-tooth comb.  
In the course of laying the whole back surface of a tile shall be covered with an adhesive composition.  
**Warning:** When laying glass products you should use an adhesive composition for Porcelain or Vitra Fix Flex Rapid. Don't use the adhesive composition named Vitra Fix HP.  
**Cleaning:** For the daily cleaning: Please clean your product with a soft fabric/cloth, after cleaning it with "cam-sil" or with the clean water.
- Cam karolar**  
**Kesme/Delme:** Lütfen sadece sulu elmas ile kesim yapınız. Delme işlemi sulu, çift yönlü ve düşük devirde yapılmalıdır  
**Döşeme:** Cam ürünleri döşerken Flex Porcelain Rapid Yapıştırıcı veya Porselen Yapıştırıcı kullanınız. Bronz, Altın ve Platin renkli cam ürünlerin döşemesinde Gri Flex Rapid Yapıştırıcı, diğer tüm renklerde Beyaz Flex Rapid Yapıştırıcı uygulanmalıdır.  
Arada hava boşluğu kalmaması için ince dişli tarak kullanılmalıdır.  
Ürünlerin yapıştırılmasında silikon kullanmayınız.  
Döşeme sırasında karonun arka kısmının tamamem yapıştırıcı kaplı olması gerekmektedir  
**Uyarı:** Cam ürünlerin döşemesinde yapıştırıcı olarak Vitra Fix Flex Rapid veya Porselen yapıştırıcı kullanılması gerekir. Vitra Fix HP ile yapıştırmayınız  
**Temizlik:** Günlük temizlik için lütfen ürününüzü cam-sil veya temiz su ile temizledikten sonra yumuşak bezle siliniz.

- N** The tiles are scored to give a mosaic look. They should be grouted after installation.  
Karolara, mozaik görüntüsü vermek için, üzerine kanallar açılmıştır. İçinde görülen karo bünyesidir. Döşndikten sonra mutlaka derz dolgu verilmelidir.
- P** **Vitra Protect Material Removing**  
Vitra Protect process is an additional treatment carried out at the manufacturing stage for polished tiles. The process eliminates the need for time-consuming anti-staining treatments at the laying stage.  
Due to this process, the tiles with Vitra Protect have a thin film layer. After installation of the tiles, it can be removed by using mineral added cream cleaning agent (such as Viss Scheuer Milch Citrus, Cif Cream or similar) and a mid-hard (green) sponge (such as 3M green sponge or similar). The tiles must be scrubbed in circular motion. For wide areas, brushing machine can be used to clean the film using the same kind of sponge and cleaning agents specified above.  
**Vitra Protect Malzeme Temizliği**  
Karolar kirlenmeye karşı önlem olarak Vitra Protect teknolojisi ile kaplanmış olup, yüzeyde görülen matlık uygulanan koruyucu malzeme sebebiyledir. Karolar, döşeme ve derz uygulama sonrası yüzey temizliği yapılmasıyla parlak görüntüsüne kavuşacaktır. Döşeme sonrası karo yüzeyleri yeşil renkli sünger (örneğin 3M yeşil sünger) ile mineral katkılı krem temizlik malzemeleri (örneğin Viss Scheuer Milch Citrus) kullanılarak cam siler gibi dairesel hareketlerle orta sertlikte ovalanarak yüzeyden alınabilir. Büyük mekan uygulamalarında döner fırça yardımıyla benzer şekilde yüzey temizliği sağlanabilir.
- R** The edges are rectified.  
Ürünlerin kenarları rektifiye edilmiştir.
- S** Due to their special features, rough or structured anti-slip surfaces are harder to clean. After the grouting, it is important to remove the excesses in a short time and by frequent washing with sponge and water, till the floor is perfectly clean.  
Ürünlerin yüzeyi kaymazlık özelliği nedeniyle rölyefli ve strüktürlüdür. Bu tip yüzeylerin temizlenmesi düz yüzeylere göre daha zordur. Derz uygulaması biter bitmez, yüzeyin sünger kullanarak bol suyla temizlenmesi çok önemlidir. Bu işlem zemin tamamen temizlenene kadar tekrar edilmelidir.
- T** The product has a metallic glaze. Due to the reflection of light, there can be differences in colour and surface mattness-glossiness of products from the same box.  
Ürünlerin üzerinde metalik sır vardır. Metalik yüzeyin ışıkla yansıma yapmasından dolayı, aynı kutudan çıkan ürünler arasında matlık-parlaklık, açıklık-koyuluk gibi farklar görülebilmektedir.
- U** Due to special technique on the decors, there can be worn out effect on the tiles.  
Dekorların üzerindeki özel teknik nedeniyle, karo yüzeyinde, eskitilmiş etkisi görülebilir.



## V-Agent

V-Agent technology is a smart surface technology that **reduces the effect of human coronaviruses and bacteria both on floor and wall tiles by 99.99%**, through a special technique applied to the tile surfaces during the production phase. V-Agent technology is effective against human coronaviruses (Human Coronavirus 229E and OC43) and bacteria (E. coli ve S. aureus) and its effect on these viruses and bacteria has been proven through the tests conducted at **TCNA - North American Ceramic Council** laboratories.



## VitrA Shield

VitrA Shield is an application of nano titanium dioxide (TiO2) coating on tiles. VitrA Shield can be applied on all kinds of tiles for indoor and outdoor use.

VitrA Shield tiles are self-cleaning thanks to the photocatalytic features activated by light and humidity in the air, while ensuring biocidal protection with their hygienic properties. The advanced technology of VitrA Shield eliminates unpleasant smells and airborne pollutants in spaces where the tiles are used.



## VitrA Clean 2.0

VitrA Clean is a surface technology that makes VitrA Tiles easy to clean. The special glazing method increases the surface tension. Thus, water acts like mercury on the surface and allows dirt to easily separate from the surface. Tiles can be easily cleaned with the help of a water-damped wipe or with addition of mild cleaning agents, if needed. This permanent feature provides great convenience to the users when cleaning both commercial and residential areas. With VitrA Clean 2.0, not only wall tiles but also floor tiles can now have VitrA Clean technology.



## VitrA Block

Watermark is a general problem occurring on white wall tiles due to water absorption. Wall tiles with VitrA Block Watermark-Free Technology have very low water absorption and therefore show no sign of watermark on the surface.

VitrA Block Watermark-Free Technology improves the performance of tile for the watermark problem and ensures customers satisfaction. A new engobe recipe has been developed with 0% water absorption without making any change on body recipe, firing cycle and tiling. Material science, chemical disciplines and microstructure characterization techniques were used to develop the innovative VitrA Block Watermark-Free Technology.



## V-Agent

V-Agent, üretim aşamasında karo yüzeylerine uygulanan özel bir teknoloji sayesinde **hem yer hem de duvar karolarında korona virüslerinin ve bakterilerin etkisini %99,99** oranında azaltan akıllı bir yüzey teknolojisidir. V-Agent teknolojisi, korona virüslerine (Human Coronavirus 229E ve OC43) ve bakterilere (E. coli ve S. aureus) karşı etkili olup, virüs üzerindeki etkisi TCNA - Kuzey Amerika Seramik Konseyi laboratuvarlarında yapılan testler ışığında kanıtlanmıştır.



## VitrA Shield

VitrA Shield uygulaması ile karolar nano titanyum dioksit (TiO2) ile kaplanır. VitrA Shield iç ve dış mekân kullanımına uygun tüm karolara uygulanabilir.

VitrA Shield karolar, ışık ve havadaki nem ile aktive olan fotokatalitik özellikleri sayesinde kendi yüzeylerini temizlerken hijyen özellikleriyle de biyosidal koruma sağlar. VitrA Shield kullanıldığı mekânlarda ileri teknolojisi sayesinde kötü kokuların ve havadaki zararlı bileşenlerin etkisini azaltır.



## VitrA Clean 2.0

VitrA Clean, VitrA Karolar'ını daha kolay temizlenebilir hale getiren yenilikçi bir yüzey teknolojisidir. Özel sırlama yöntemi yüzey gerilimini artırır. Böylece su, yüzey üzerinde cıva gibi hareket ederek kirin kolaylıkla yüzeyden ayrılmasını sağlar. Ürün yüzeyleri sadece suyla ıslatılmış bir bez yardımıyla veya gerektiğinde yumuşak temizleme maddeleriyle temizlenebilir. Bu kalıcı özellik hem ticari, hem de konut kullanım alanlarının temizliğinde kullanıcılara büyük kolaylıklar sağlar. VitrA Clean 2.0 ile ise artık sadece duvar karoları değil, yer karoları da Clean teknolojisine sahip olabiliyor.



## VitrA Block

Su lekeleri, su emilimine bağlı olarak beyaz duvar karolarında karşılaşılan genel bir sorundur. VitrA Block Su Lekesi Göstermeyen Teknoloji ile üretilen duvar karoları, su emicilikleri son derece düşük olduğundan yüzeylerde su lekesi izi bırakmaz.

VitrA Block Su Lekesi Göstermeyen Teknoloji, karolarda yaşanan su lekesi sorununu ortadan kaldırarak müşteri memnuniyetini artırır. Karoların hazırlama, fırınlama ve döşeme süreçlerinde herhangi bir değişikliğe gidilmeden %0 su emiciliği sağlayan yeni bir astar formülü keşfedilmiştir. Yenilikçiliği ile çığır açan VitrA Block Su Lekesi Göstermeyen Teknoloji; malzeme mühendisliği, kimya bilimi ve mikroyapı karakterizasyon teknikleri kullanılarak geliştirilmiştir.





Floor tile Yer karosu	Frost resistant Dona dayanım	Colour fast Rengi solmaz	Glass Cam	Matt Mat	Shade variation Desen farklılaşması	Porcelain Porselen	Abrasion Aşınma	Facade Dış cephe	Outdoors Dış mekânlar
Wall tiles Duvar karosu	Flame resistance Ateşe dayanıklı	Salt resistance Tuzlu suya dayanıklı	Rectified Rektifiyeli	Glossy Parlak	Shade variation Desen farklılaşması	Full lappato	Abrasion Aşınma	Residential Konut	Park & garden Bahçe ve parklar
Novelities Yeni	Thermal resistance Isı farkına dayanıklı	Break resistance Yüke dayanıklı	Rectified Rektifiyeli	Satin Saten	Shade variation Desen farklılaşması	Lappato	Abrasion Aşınma	Industrial area Endüstriyel alan	Laying on sand Plaj ve kum zeminler
Award winning Ödüllü	Accessible and reusable Serbest döşeme ile sökölüp taşınabilir	Easy to clean Kolay temizlenir	Reactive ink Reaktif ink	Soft r10	Shade variation Desen farklılaşması	R9 lappato	Abrasion Aşınma	Pool and spa Havuz çevresi ve spa	
Huge dimension Büyük ebat	Easy tiling Kolay döşenir	Resistant to domestic chemicals Evsel kimyasallara dayanıklı	Metallic glaze Metalik sır	Metro	Shade variation Desen farklılaşması		Abrasion Aşınma	Commercial Ticari alanlar	
Thickness Kalınlık	The raised paving system Yükseltilmiş döşemeye uygun	Moss and rust resistance Yosun ve pas oluşturmaz	Decor printing Dekor baskı	Bumpy				Commercial - low traffic Ticari alan - düşük trafik	
Mini size Küçük ebat	Modularity Modülerlik	VitrA SHIELD	Self-cleaning Kendi kendine temizleme	Hygienic effect Hijyenik etki				Parking areas Garajlar ve otomobil galerileri	
VitrA SLIM		VitrA BLOCK	Photoactive Fotokatalitik etki	Protection from airborne pollutants Havadaki kirlere karşı koruma kalkanı					

Usage area icons that are displayed per the collection throughout the catalogues is a generalization for the whole collection and do not indicate SKU based suitability of usage area. For control on which surface to be used in which usage area please refer to the detailed technical classification table in the following pages under this section.

Katalogda koleksiyon sayfalarında bulunan kullanım yeri ikonları tüm SKUlar içindir, yalnız dikkat edilmelidir ki her SKU her ikon için uygun değildir. Kullanım yeri uygunluk kontrolü için lütfen ilerideki teknik yüzey-kullanım alanı sınıflandırma tablosuna bakınız.

## reaLook

World's most advanced printing facilities are combined with VitrA's exquisite design competence. With VitrA's exclusive reaLook Printing technology, images can be reflected on the tiles in such a way that they are indistinguishable from natural.

(1) Dünyanın en ileri baskı olanakları VitrA'nın üstün tasarım yetkinliği ile birleşiyor. VitrA'ya özgü reaLook Baskı teknolojisi ile görüntüler, karo üzerinde, doğala en yakın dokularla ve görsellikle yansıtılıyor.

(1) Only if required by corresponding national statutory regulations / Sadece ilgili ülke mevzuatında gerekiyorsa

Tiles may vary in colour, texture or appearance according to product design for particular tile collections. Especially Shade variation V3, V4 type products may vary significantly within boxes, samples, merchandising and display. It is strongly recommended to pay attention to Shade variation during product selection. VitrA has five groups with different variation intensity that are indicated on the catalogues for specific products.

Karolar, belirli koleksiyonlar özelinde kendi içerisinde ürün tasarımına göre renk, doku veya görünüm olarak değişiklik gösterir. Özellikle Desen farklılaşması V3, V4 tipi ürünler; kutular, numuneler, ticari ürünler ve gösterimler arasında önemli ölçüde değişiklik gösterebilir. Ürün seçimi sırasında Desen farklılaşmasına dikkat etmeniz önerilir. VitrA karolarda, belirli ürünler için kataloglarda belirtilen beş desen farklılaşma sınıflandırması bulunmaktadır.

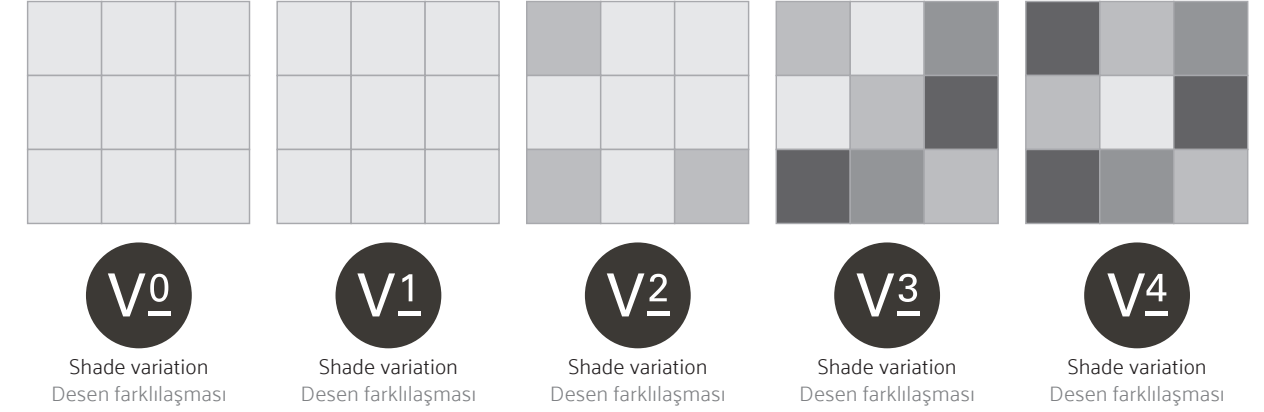

### V0- Very uniform appearance / Tekdüze görünüm

Pieces of the same shade value are very uniform and smooth in texture. Karolar arasında önemsiz farklılıklarla her bir karo aynı renge, tona sahiptir.

### V1- Uniform appearance / Hafif farklı görünüm

Minor variations in colour and structure for a restful, natural effect. Doğal bir etki için karonun kendi içinde ve karolar arasında küçük renk farklılıkları mevcuttur.

### V2- Slight variation / Farklı görünüm

Clearly, distinguishable differences in texture and/or pattern within similar colours. Benzer renklerde doku ve / veya desende gözle fark edilebilir farklılıklar mevcuttur.

### V3- Moderate variation / Çok farklı görünüm

While the colour and/or texture on a single piece of tile could be indicative of the colour and/or texture on the other tiles, the amount of colour and/or texture variation on each piece may be significant. Karolar arasında ve/veya tek bir karo üzerindeki renk ve/veya doku farklılaşması önemli miktardadır.

### V4- Substantial variation / Rastgele farklı görünüm

Random colour and/or texture differences from tile to tile, so that one tile may have totally different colour and/or texture from that on other tiles. Thus, the final installation will be unique. Karodan karoya renk ve/veya dokuda rastgele dağılım mevcuttur. Bu sebeple bir karo diğerinden tamamen farklı renk ve/veya dokuda olabilir. Sonuçta ürünlerin döşenmesi sonucu çıkan görünüm benzersiz olacaktır.

Shade variations of VitrA porcelain and wall tiles collections are shown in the VitrA PRO books.

Please use the given QR codes to download related VitrA PRO books.

VitrA porselen ve duvar karosu koleksiyonlarının desen farklılaşmaları aşağıdaki VitrA PRO kataloglarında gösterilmektedir. İlgili VitrA PRO kataloğunu indirmek için lütfen verilen QR kodlarını kullanın.



VitrA PRO Book - Porcelain Collections  
[https://cdn1.vitra.com.tr/UPLOAD/VitrA\\_PRO\\_Book-LOW.pdf](https://cdn1.vitra.com.tr/UPLOAD/VitrA_PRO_Book-LOW.pdf)



VitrA PRO Book - Wall Collections  
<https://cdn1.vitra.com.tr/UPLOAD/VitrA-Wall-collections.pdf>



## VitrA product code system

VitrA product codes have been renewed in January 2019 in order to achieve a better and more systematic product management structure. The new 16-digits code system helps us to achieve a much better inventory management, error-free planning and easier packaging. The new system also enables more flexible market specific solutions and helps us to eliminate potential customer complaints.

### The new product code structure:

Digits	1	2-7	8-11	12	13-14	15	16
Code	K	947186	R000	1	VT	E	0
Description	Standard	Root code	Operation (R, FLPR,...)	Quality	Brand, box	Pallet type	Packaging revisions
Sample	K947186R0001VTE0						

- Digits 1 through 7 represent the root code of the product (In the old code structure format).
- Digits 8 through 11 represent post firing operations. (surface treatments, edge treatments, mesh type and production type, etc) (FLP: Full lappato, H: Honed touch, FA: Photoactive, S: Shield, etc)
- 12<sup>th</sup> digit represents product quality. (1<sup>st</sup> quality, 2<sup>nd</sup> quality and end of series product)
- Digits between 13 and 14 represent the boxing or branding of the product. (VT: VitrA KE: Kermos, etc.)
- The 15<sup>th</sup> digit represents the pallet used during the shipment of the product. (E: Euro pallet, S: Special pallet, etc.)
- The 16<sup>th</sup> digit represents any revision made in the packaging of the product. (0-9)

### Post firing operation codes:

Feature	Explanation	Abbreviation
Production type	Extruder	E
Mesh type	No mesh	O
Mesh type	Paper mesh	4
Mesh type	Top mesh	5
Mesh type	Dot Mount	7
Mesh type	Nylon mesh	8
Mesh type	Polyurethane mesh	9
Glazed edge	Glazed short edge	JJ
Glazed edge	Glazed long edge	JL
Glazed edge	Glazed both edges	JD
Surface treatment	Polish / Protect	P
Surface treatment	Lappato	LP
Surface treatment	Fulllappato	FLP
Surface treatment	Honedtouch	H
Surface technology	Polished after firing	R
Surface technology	Block	B
Surface technology	Hygiene	A
Surface technology	Clean	C
Surface technology	Photoactive	FA
Surface technology	Shield	S
Surface technology	New glow in the dark technology	G
Edge treatment	Rectified	R

### One overglazed edge application

One overglazed edge tiles are available in 20x25 size of wall tiles. The order should be placed with overglazed edge tile product codes. 5% of the total quantity ordered will be produced with one overglazed edge. If the new code is for the short edge, the expression "JJ" should be added to the 8<sup>th</sup> and 9<sup>th</sup> digit of the base tile code. If the new code is for the long edge, the expression "JL" should be added to the 8<sup>th</sup> and 9<sup>th</sup> digit of the base tile code. Except for these codes, one overglazed edge orders placed with standard product codes and order notes will not be evaluated. Technical approval is required for one overglazed edge tile orders in other sizes and bodies. Please refer to the price lists for the prices of the one overglazed edge tiles.

## VitrA ürün kod sistemi

Daha iyi ve daha sistematik bir ürün yönetimi yapısına ulaşmak için VitrA ürün kodları Ocak 2019'da yenilenmiştir. Yeni 16 basamaklı kod sistemi, çok daha iyi bir envanter yönetimi, hatasız planlama ve daha kolay bir paketleme yönetimi yürütmemize yardımcı oluyor. Yeni sistem ayrıca pazara özel daha esnek çözümler sunabilmemizi ve olası müşteri şikayetlerini ortadan kaldırmamızı sağlıyor.

### Yeni ürün kodu yapısı:

Basamaklar	1	2-7	8-11	12	13-14	15	16
Kod	K	947186	R000	1	VT	E	0
Açıklama	Standart	Kök kod	İşlem (R, FLPR,...)	Kalite	Marka, kutu	Palet tipi	Paketleme değişiklikleri
Örnek	K947186R0001VTE0						

- 1 ile 7 arasındaki haneler ürünün kök kodunu (eski kod yapısı formatında) temsil etmektedir.
- 8 ile 11 arasındaki haneler fırın çıkışı uygulamaları temsil etmektedir. (Yüzey işlemleri, kenar işlemleri, file tipi ve üretim tipi vb.) (FLP: Full lappato, H: Honed touch, FA: Photoactive, S: Shield, vb.)
- 12. hane ürün kalitesini temsil etmektedir. (1. kalite, 2. kalite ve seri sonu ürün)
- 13 ile 14 arasındaki haneler ürünün kutu markasını temsil etmektedir. (VT: VitrA KE: Kermos, vb.)
- 15. hane ürünün sevki esnasında kullanılan paleti temsil etmektedir. (E: Europalet, S: Özel palet, vb.)
- 16. hane ürünün paketlenmesinde bir değişiklik yapılmak istendiğinde yapılan değişikliği temsil etmektedir. (0-9)

### Fırın çıkışı uygulama kodları:

Özellik	Açıklama	Kısaltma
Üretim tipi	Extruder	E
File tipi	Filesiz	O
File tipi	Kağıt File	4
File tipi	Üstten File	5
File tipi	Dot Mount	7
File tipi	Naylon File	8
File tipi	Poliüretan File	9
Kenarı sırlı	Kısa veya (kare için) tek kenarı sırlı	JJ
Kenarı sırlı	Uzun kenarı sırlı	JL
Kenarı sırlı	İki kenarı sırlı	JD
Yüzey işlem	Parlatma / Protect	P
Yüzey işlem	Lappato	LP
Yüzey işlem	Fulllappato	FLP
Yüzey işlem	Honedtouch	H
Yüzey teknoloji	Fırın çıkışı parlak	R
Yüzey teknoloji	Block	B
Yüzey teknoloji	Hijyen	A
Yüzey teknoloji	Clean	C
Yüzey teknoloji	Fotoactive	FA
Yüzey teknoloji	Shield	S
Yüzey teknoloji	Yeni glow in the dark teknolojisi	G
Kenar işlem	Rektifiye	R

### Tek kenarı sırlama uygulaması

Tek kenarı sırlı karo talepleri duvar karolarında 20x25 ebadına yapılmaktadır. Talebe istinaden ürünün kenarı sırlı versiyonunun kodu açılıp, sipariş bu kod üzerinden girilmelidir. Bu kod üzerinden girilecek siparişlerin %5'i tek kenarı sırlı olarak üretilecektir. Açılacak yeni kod eğer kısa kenar içinse, fon kodunun 8. ve 9. hanesine "JJ", uzun kenar içinse 8. ve 9. hanesine "JL" ibaresi eklenecektir. Bu kodların dışında, sipariş notu ile talep edilecek tek kenarı sırlı üretimler değerlendirilmeyecektir. Diğer bünye ve ebatlardaki tek kenarı sırlı uygulamaları için teknik onay gereklidir. Ürünlerin fiyatları için lütfen fiyat listelerine bakınız.



33x100

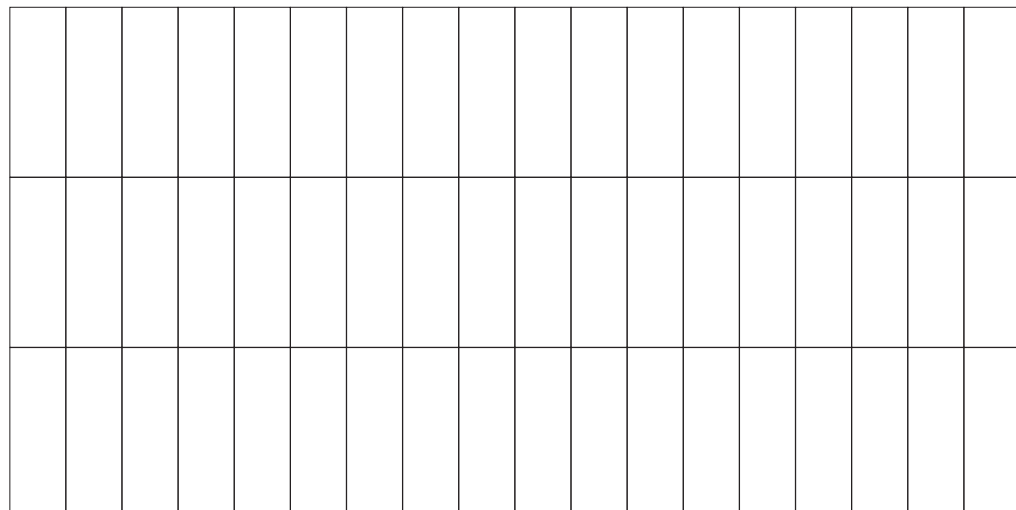
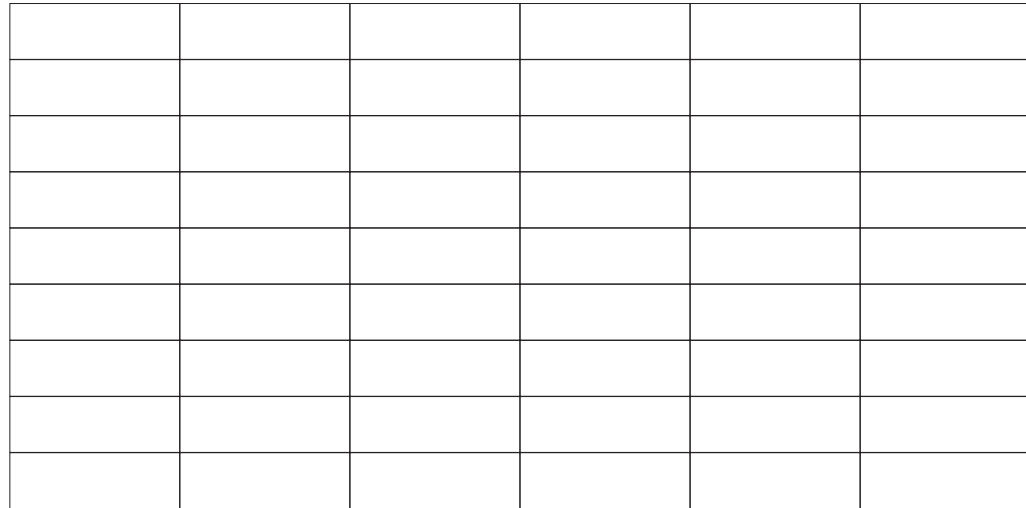
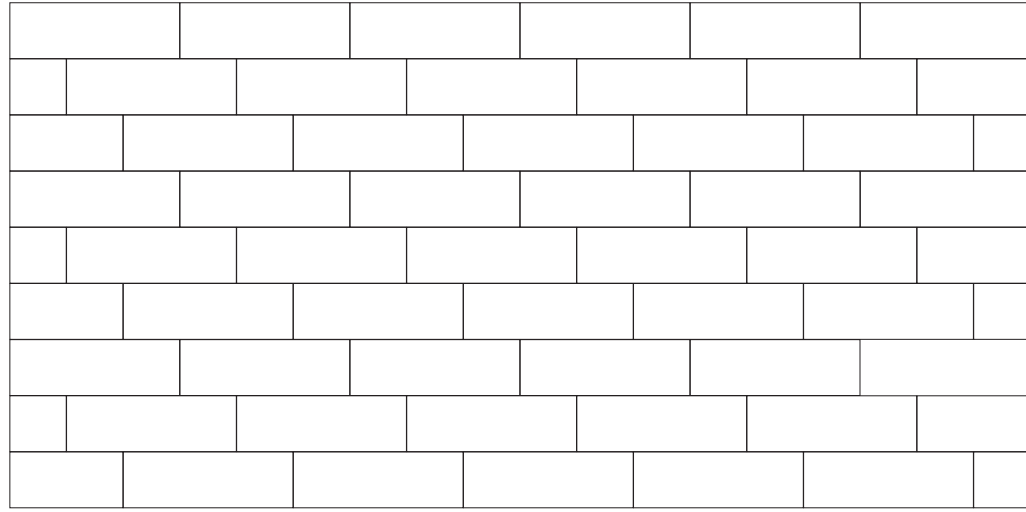

30x90

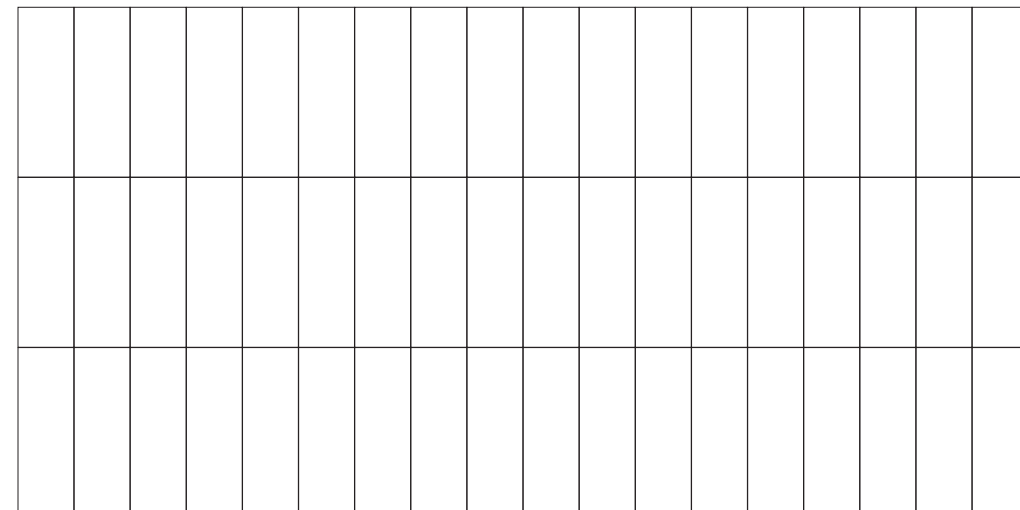
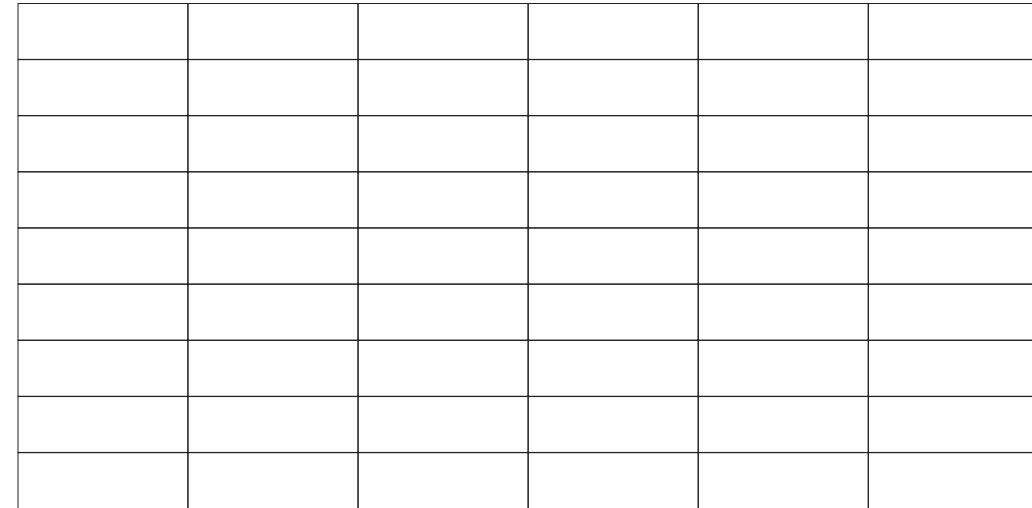
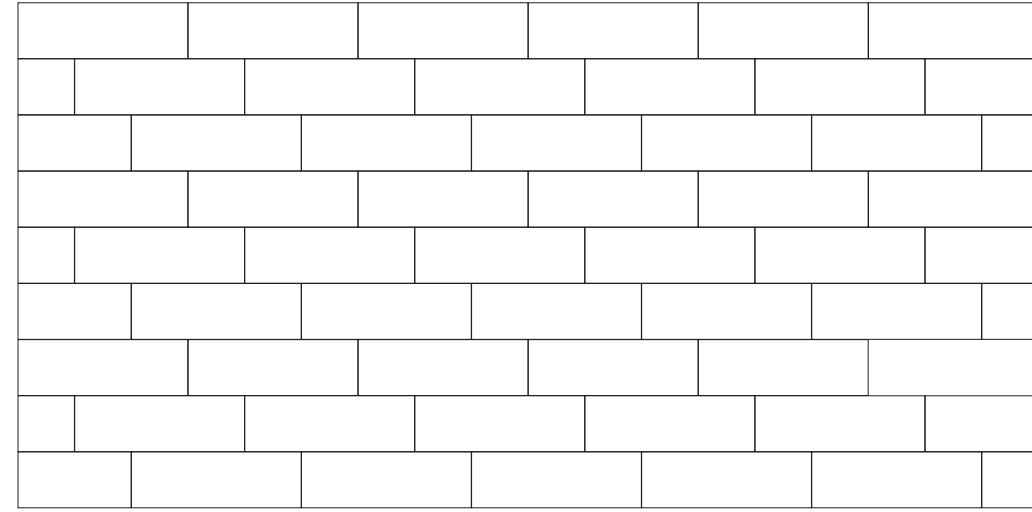



40x80

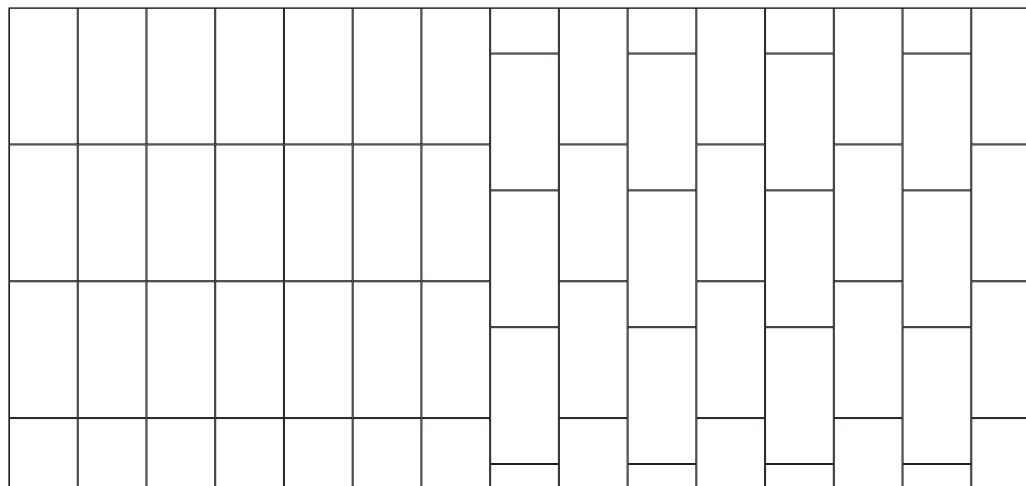
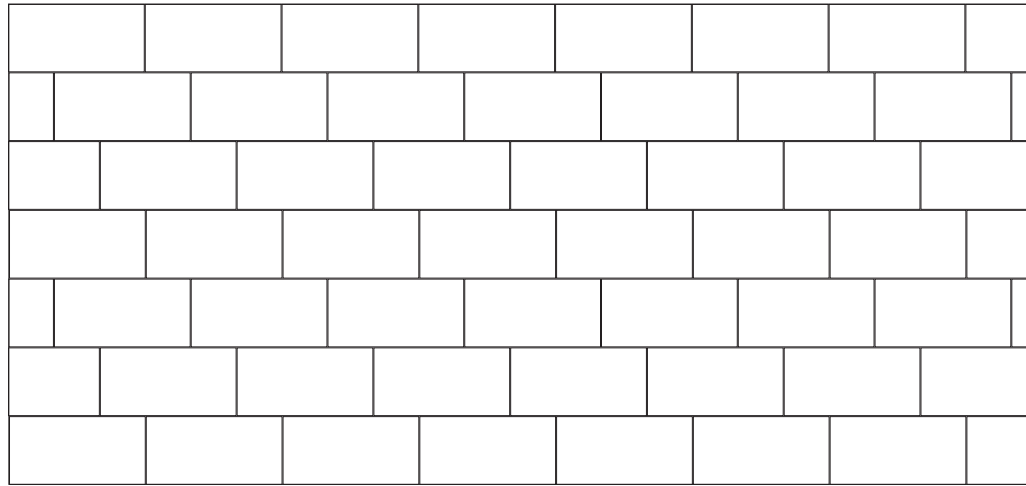
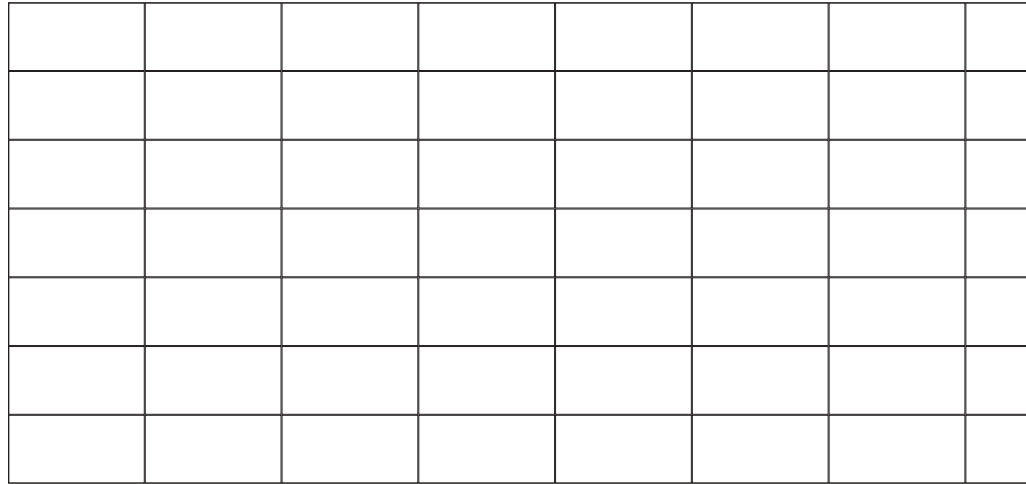

30x60

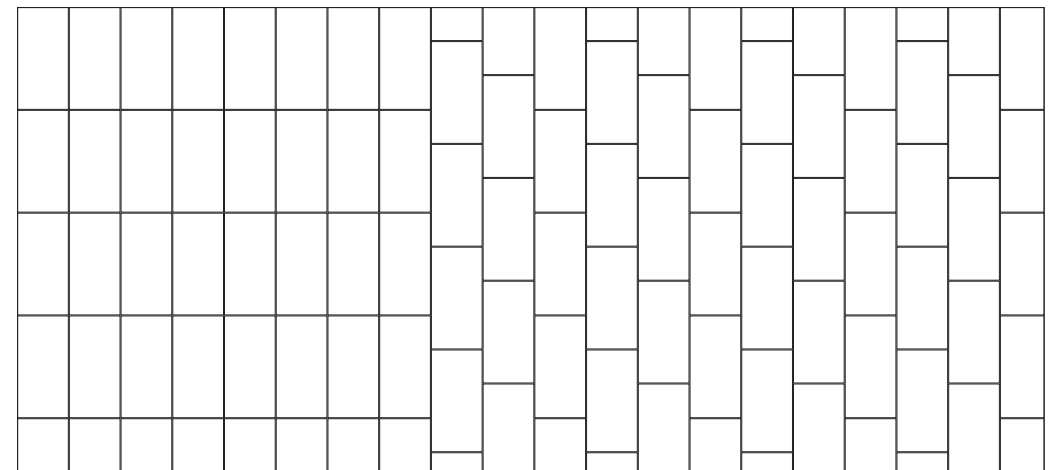
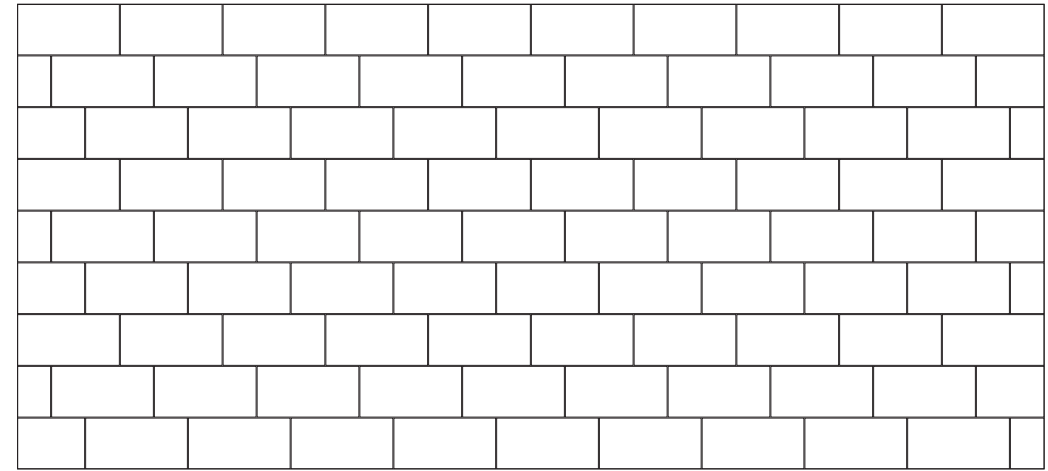
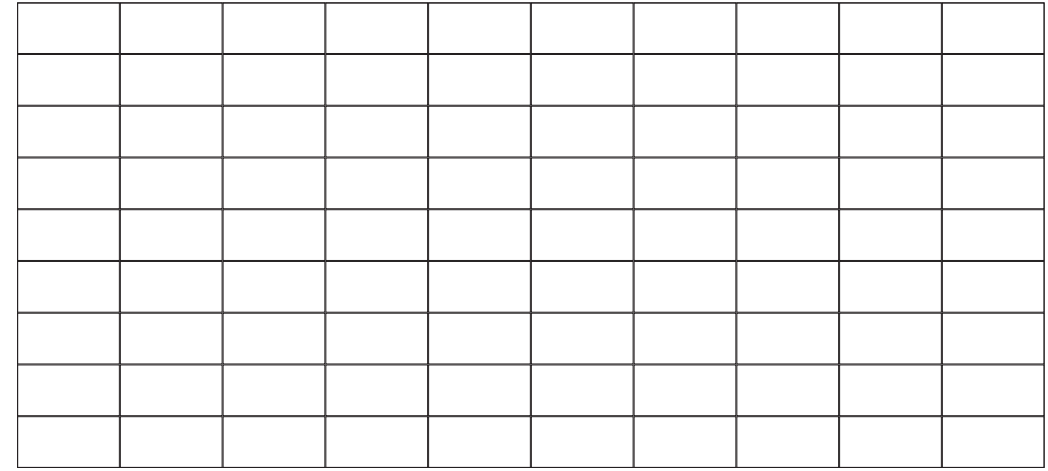



80x80

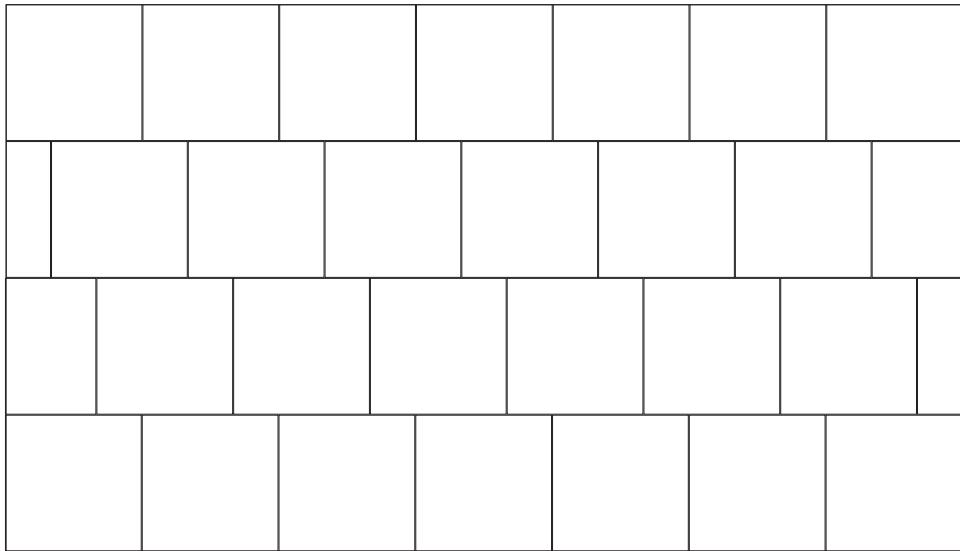
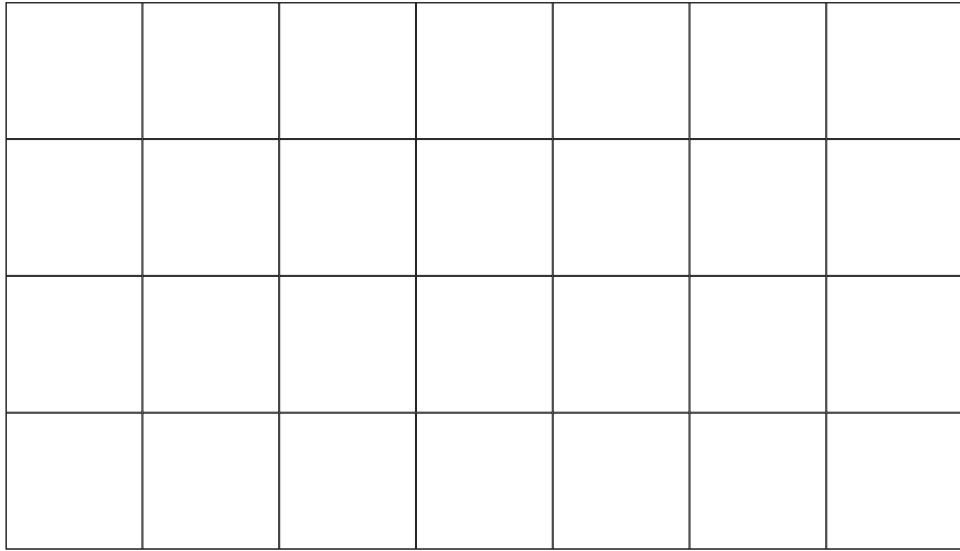

80x80

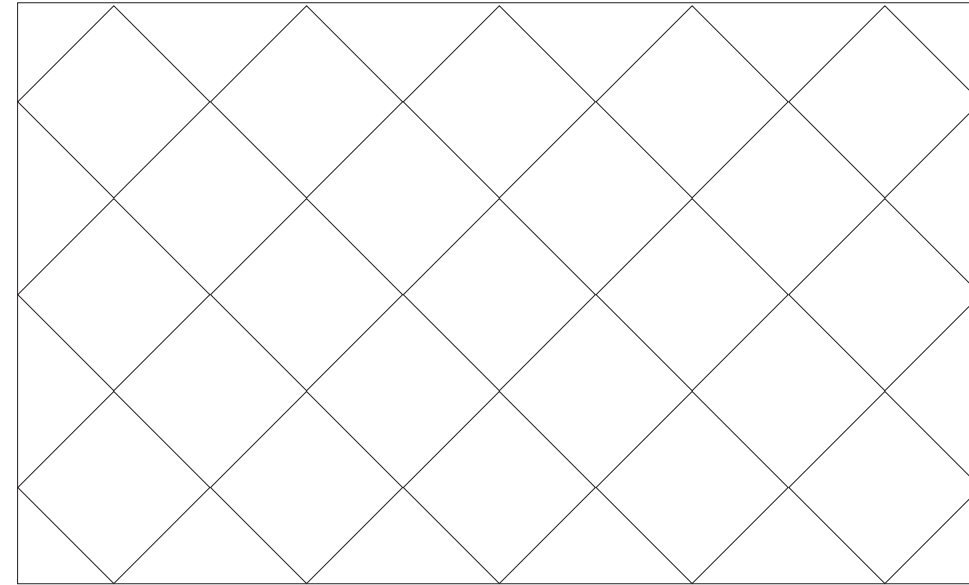

80x80 - 40x80

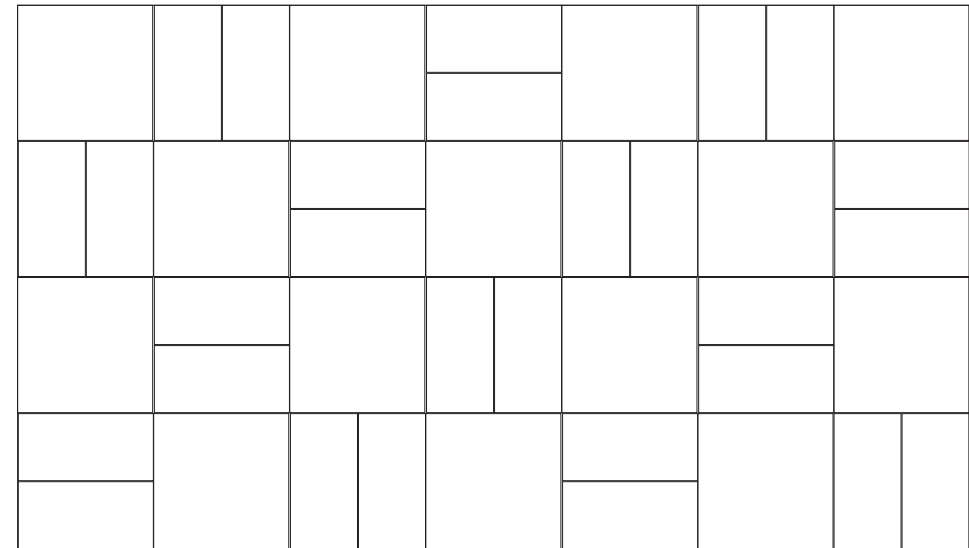



80x80 - 40x80 - 10x80

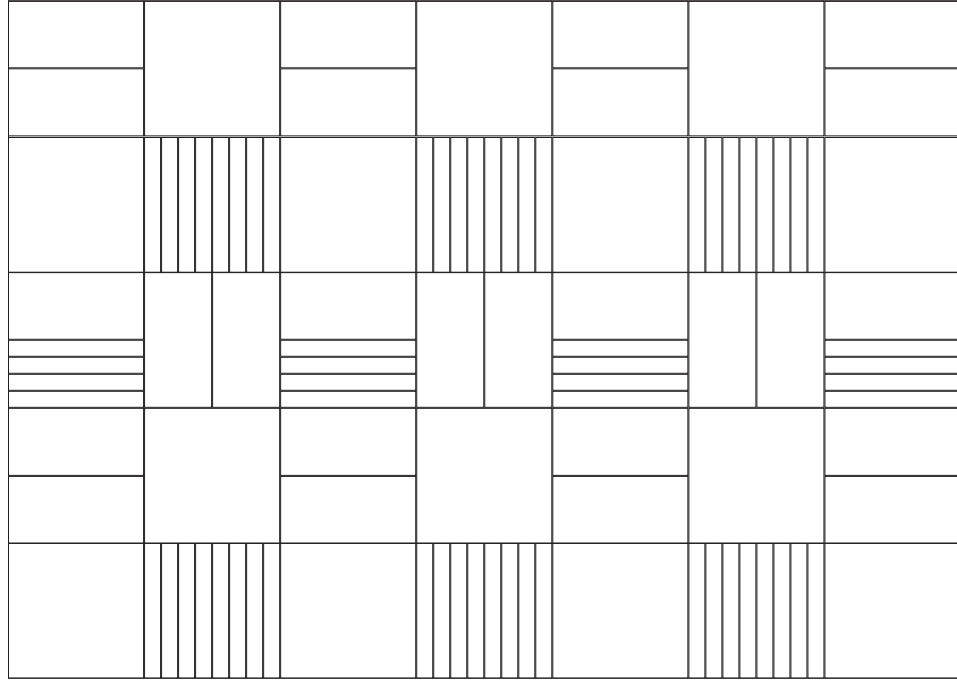

80x80 - 10x80

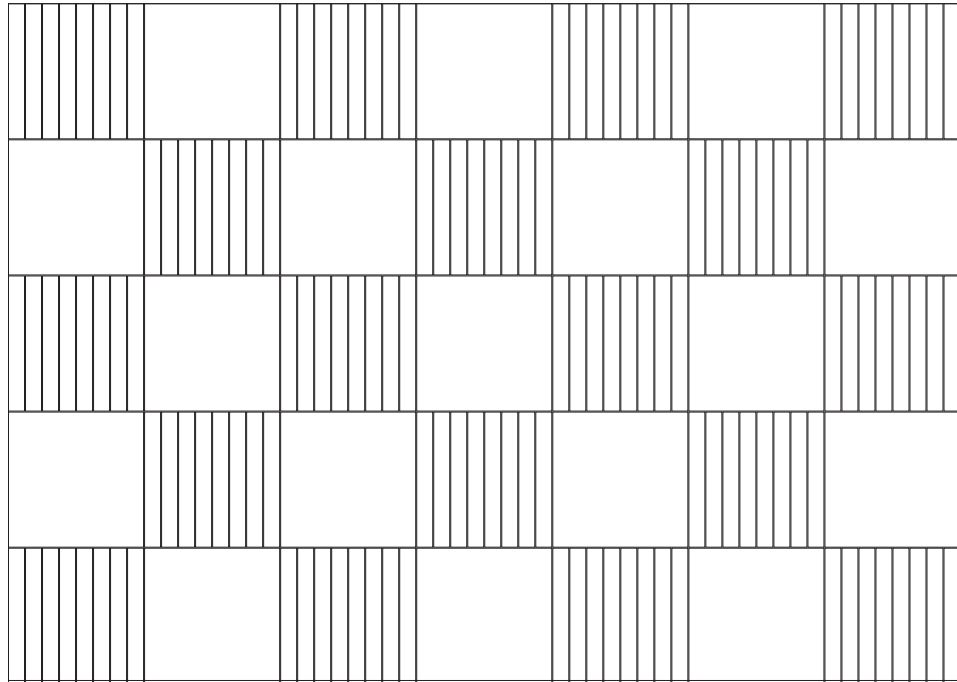

20x120

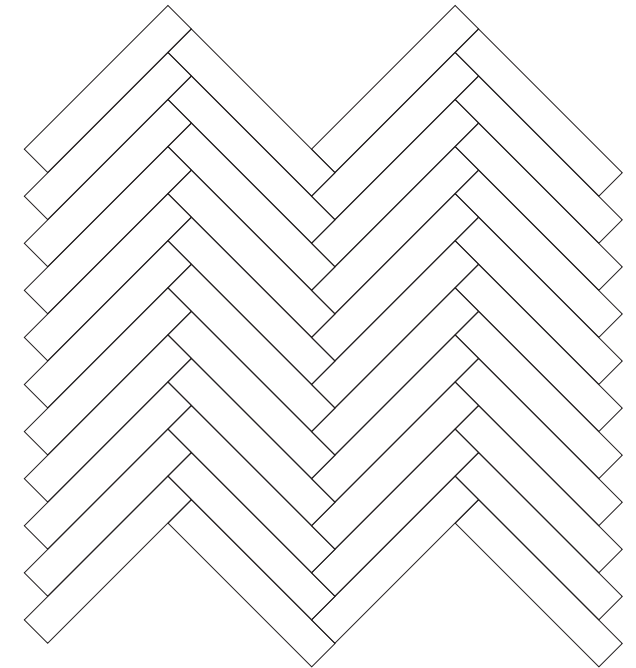
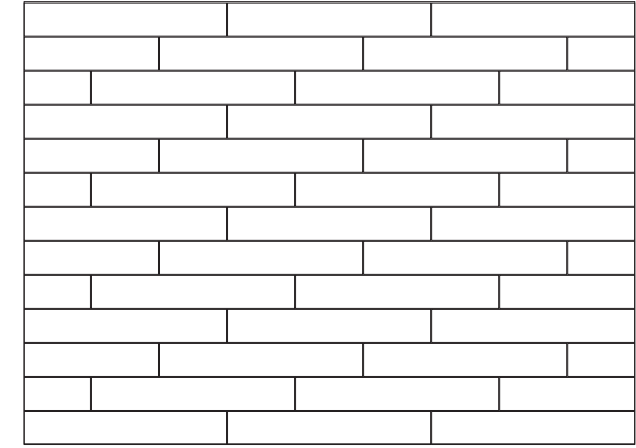
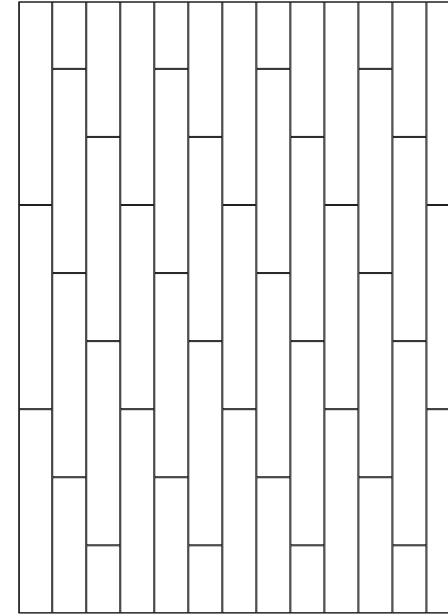
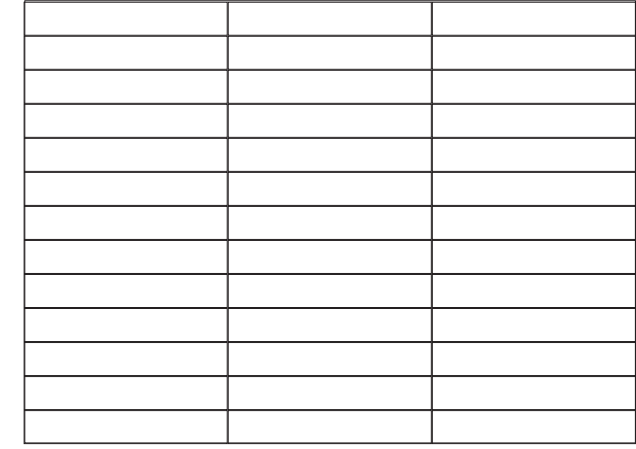
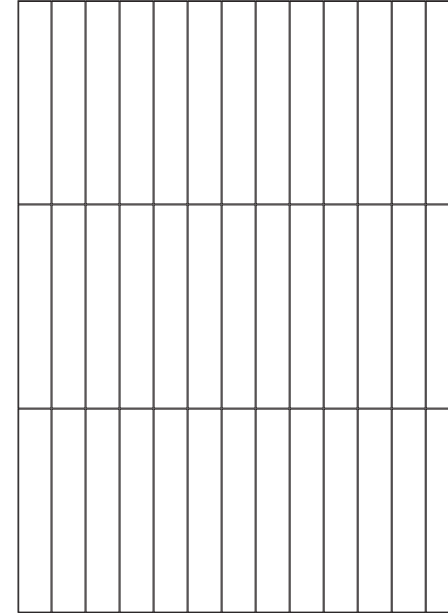

\*\*Laying tiles with maximum 1/4 shifting from the long edge of the rectangular tiles is recommended. Laying tiles with 1/2 shifting from the tiles is not recommended.

\*\*Ürünlerde kaydırmalı döşeme yapılacaksa problem yaşanmaması için kaydırmanın karonun uzun kenarının max 1/4'lük kısmından yapılması gerekmektedir. Karonun tam ortasından yapılan döşeme uygulamaları kesinlikle önerilmez.



45x90

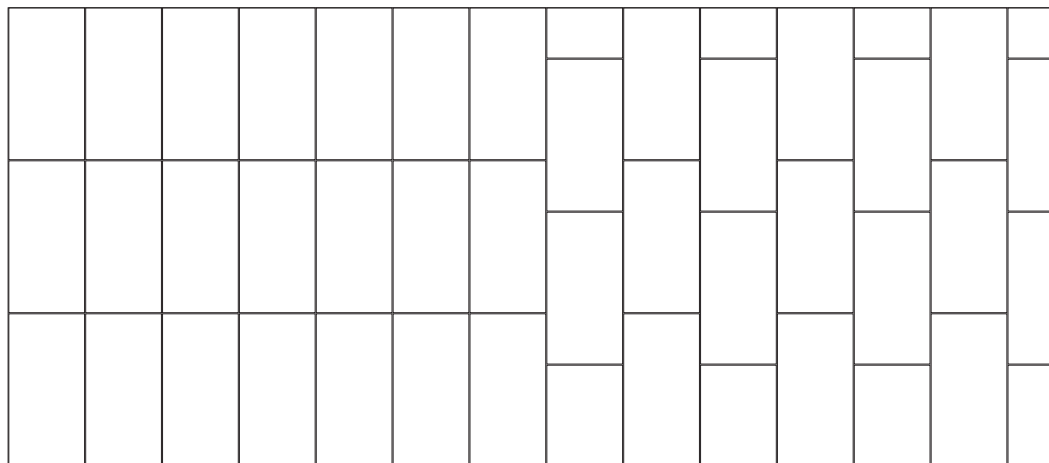
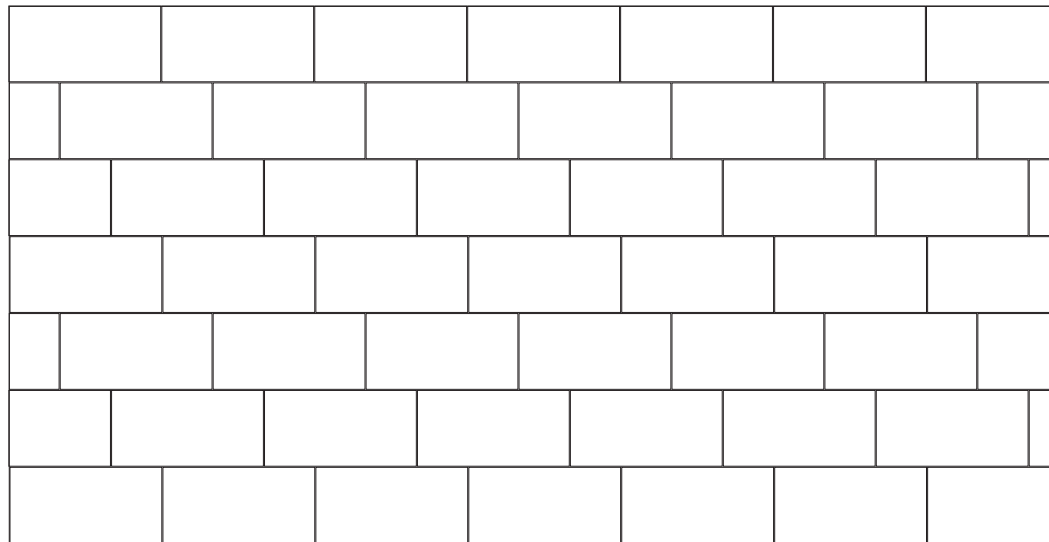
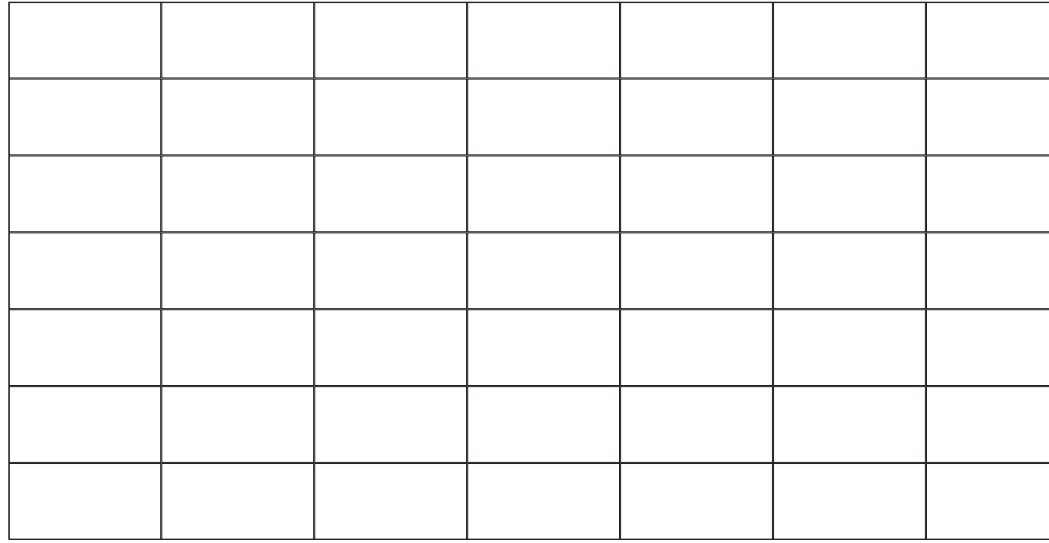

45x90 - 225x90 - 15x90

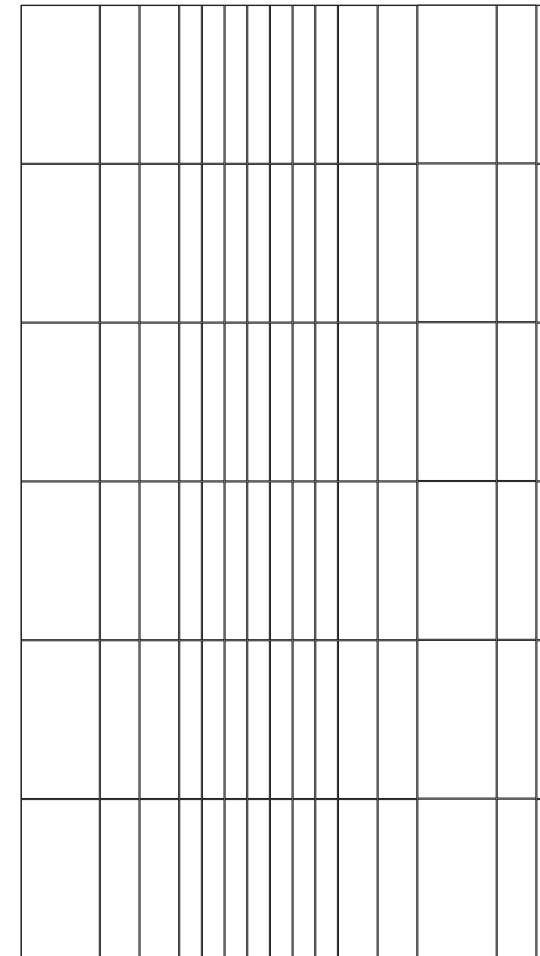
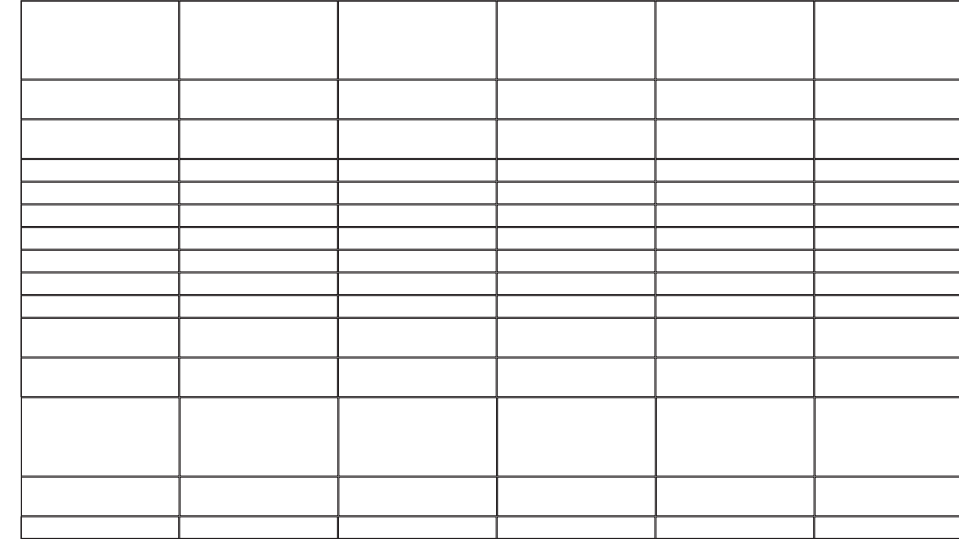

\*\*Laying tiles with maximum 1/4 shifting from the long edge of the rectangular tiles is recommended. Laying tiles with 1/2 shifting from the tiles is not recommended

\*\*Ürünlerde kaydırmalı döşeme yapılacaksa problem yaşanmaması için kaydırmanın karonun uzun kenarının max 1/4'lük kısmından yapılması gerekmektedir. Karonun tam ortasından yapılan döşeme uygulamaları kesinlikle önerilmez.



60x120

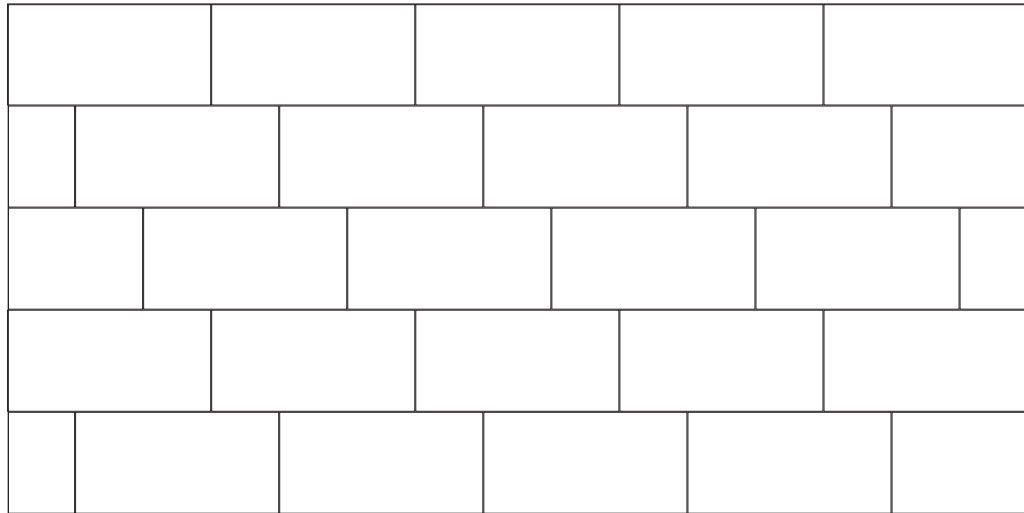
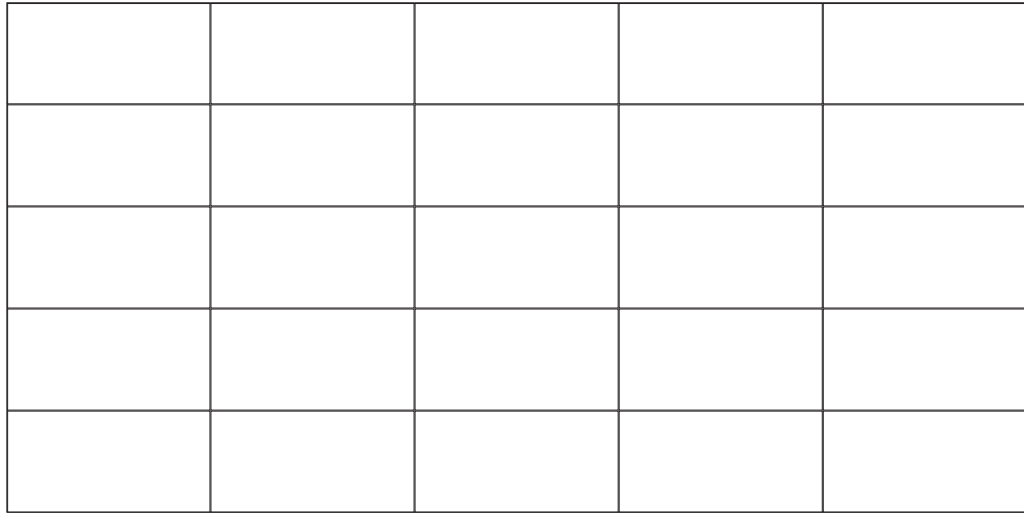

60x120

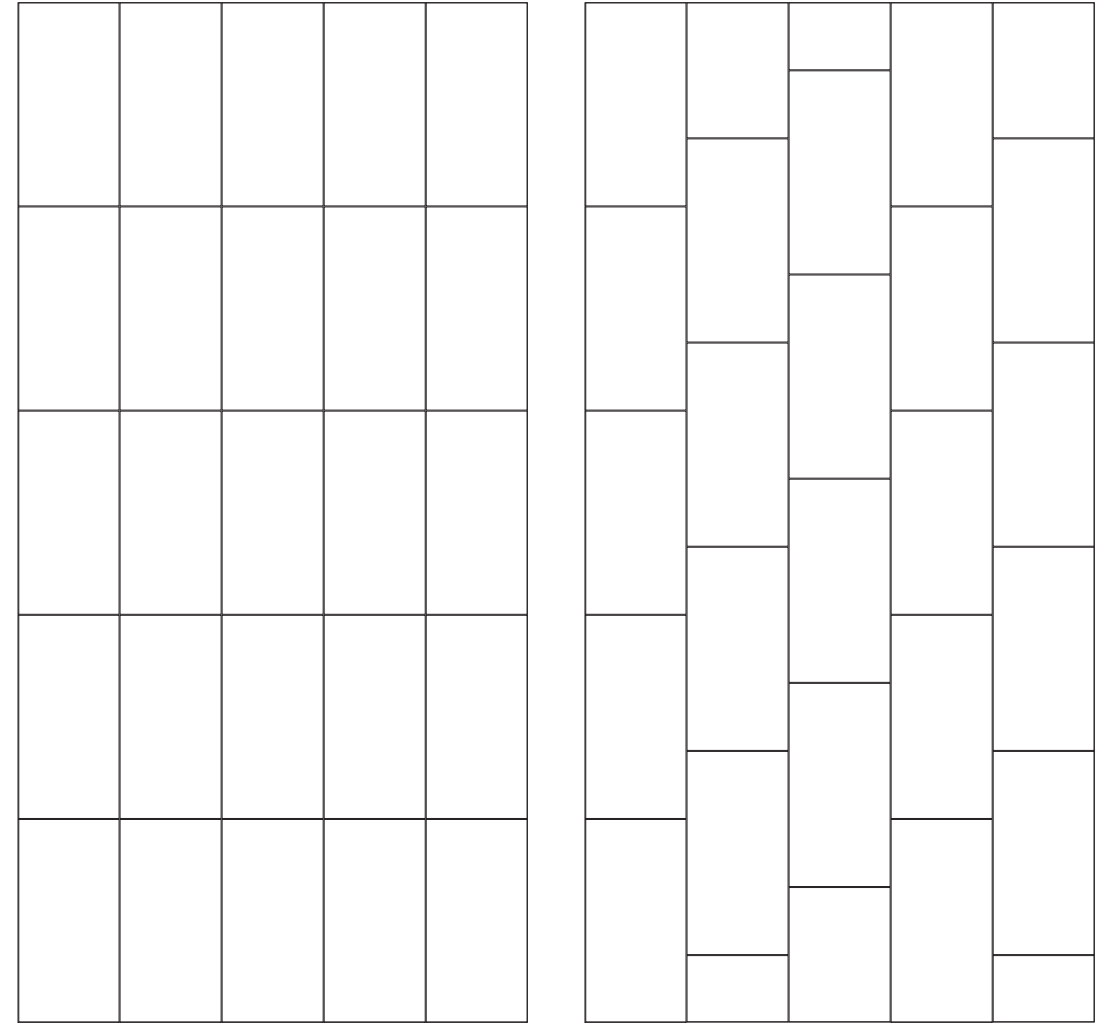

60x120 - 60x60 - 30x60

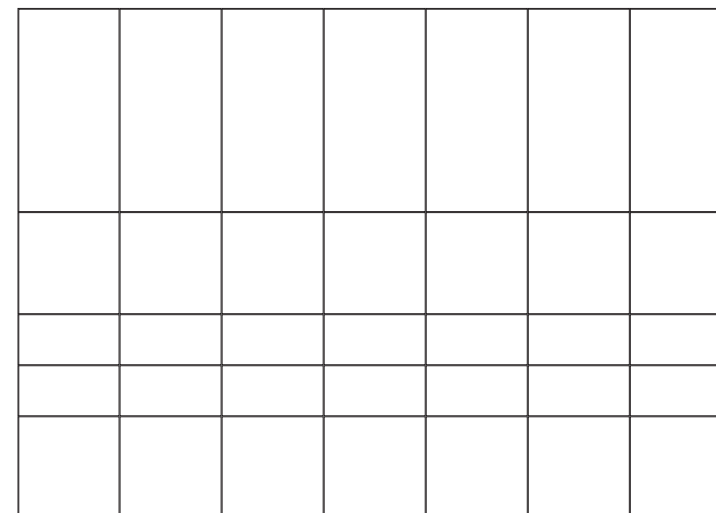



40x80

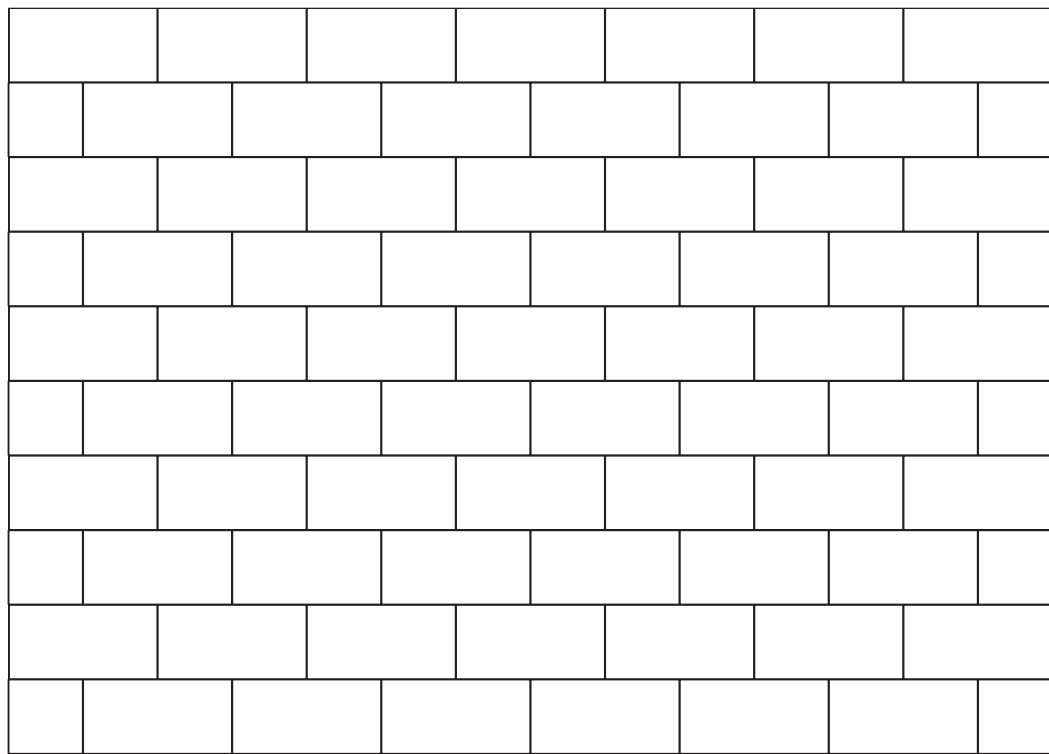
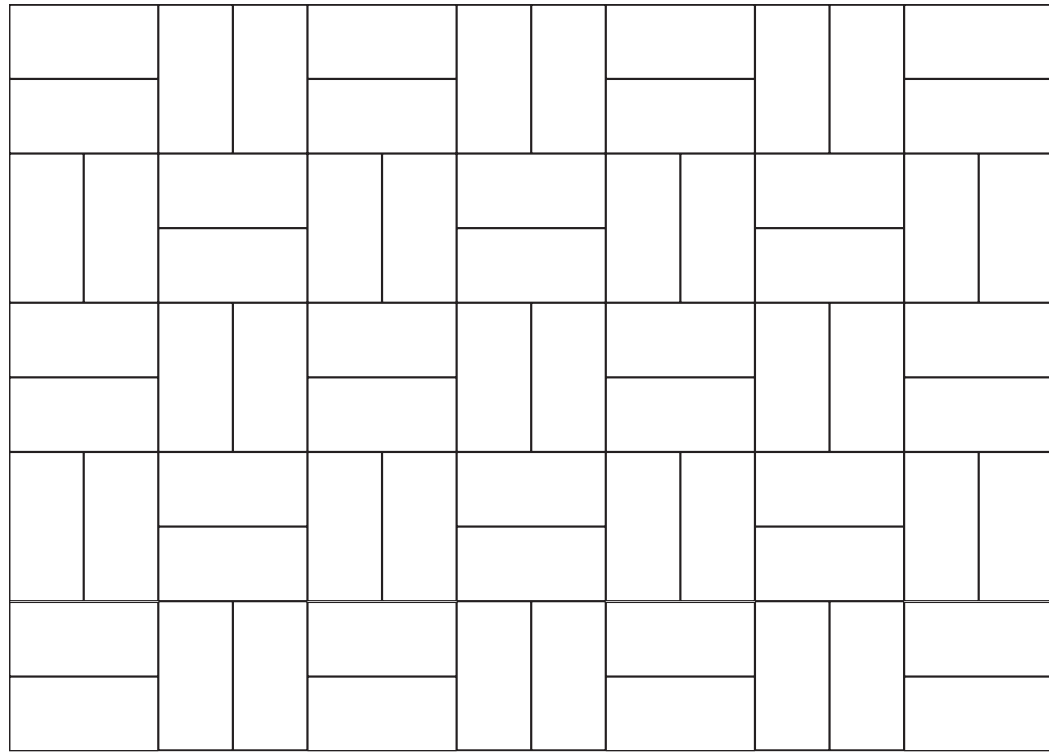

20x80 - 40x80

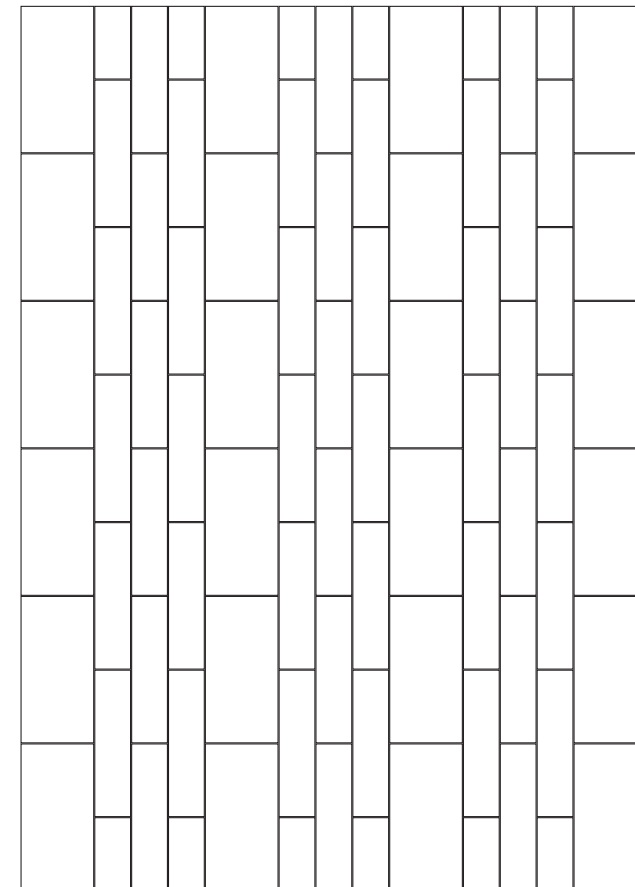
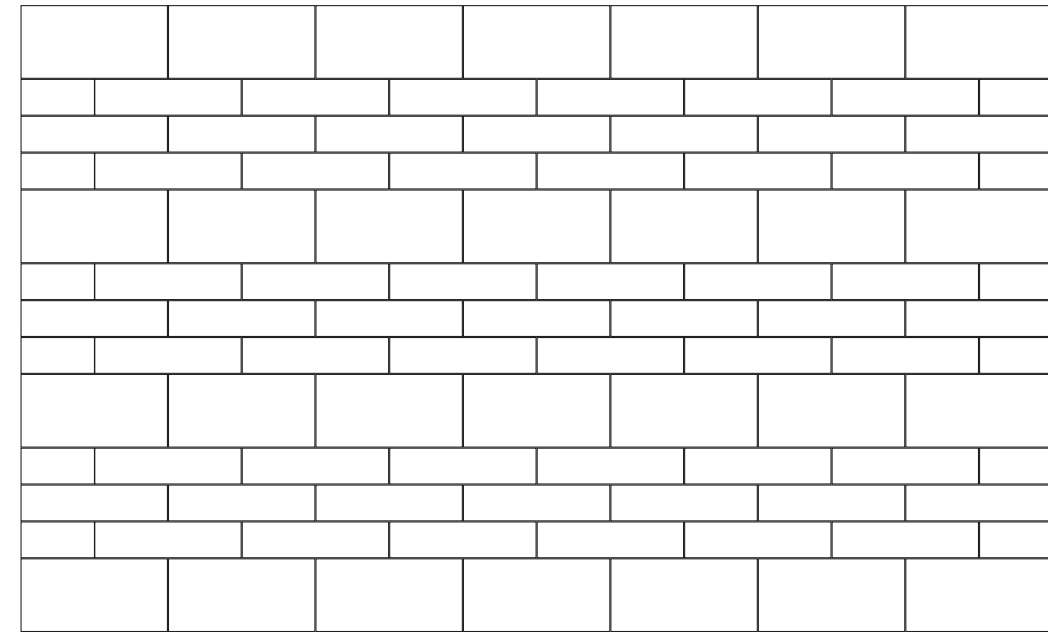



10x30

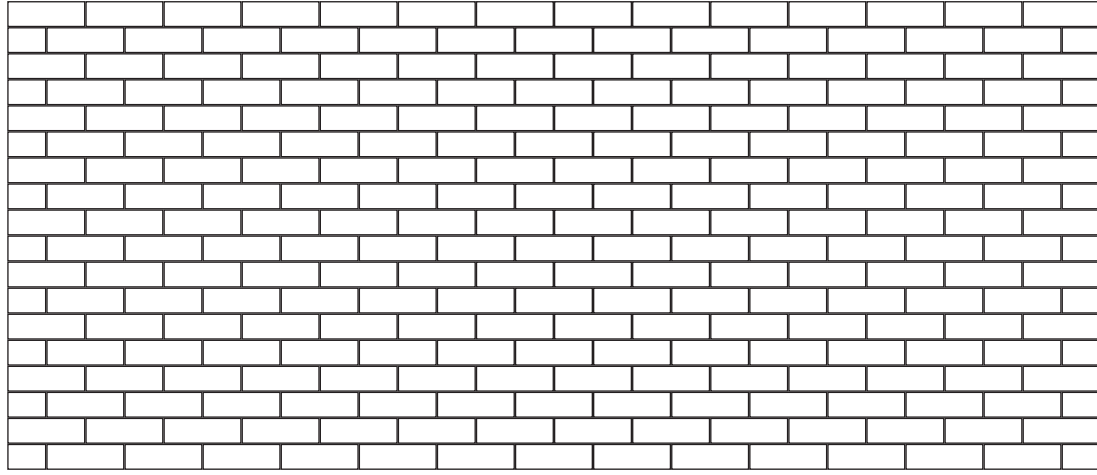

10x10 - 10x30

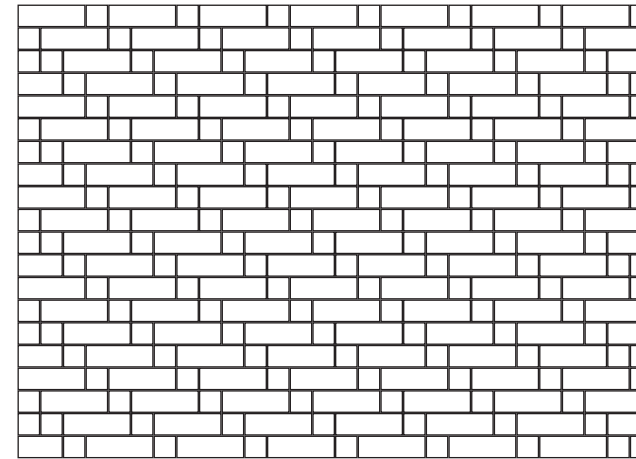
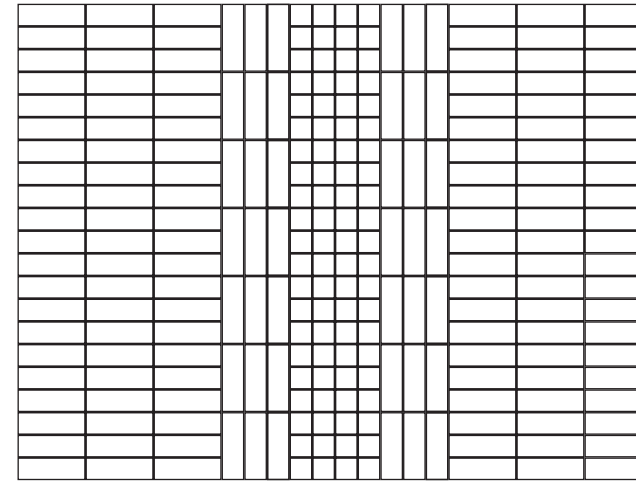

10x10 - 10x30

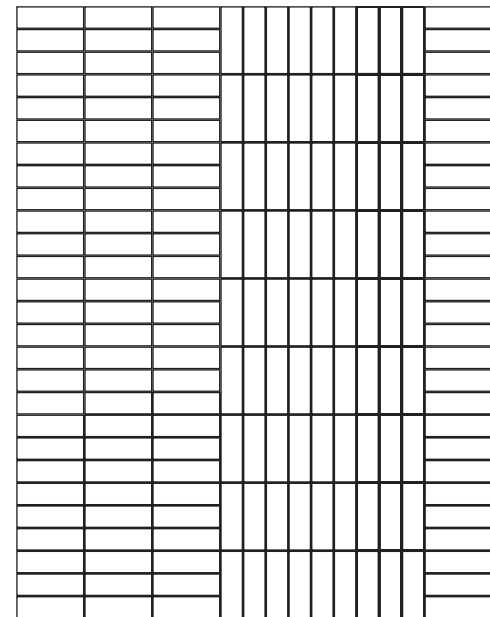
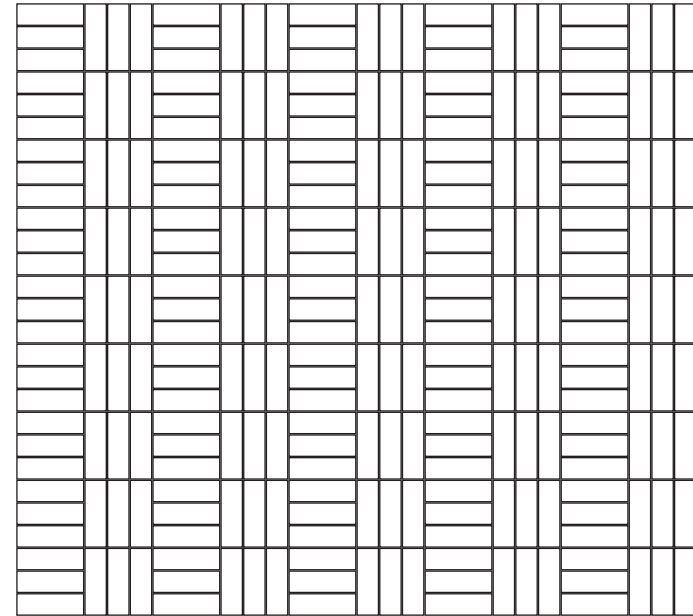
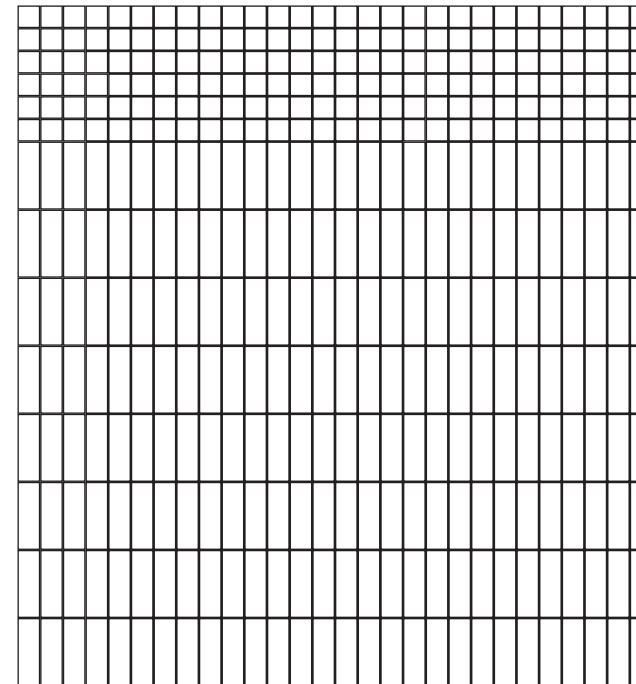



**miniworx I MiniLay**

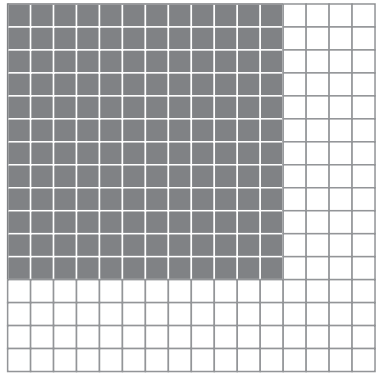

2,5x2,5 cm

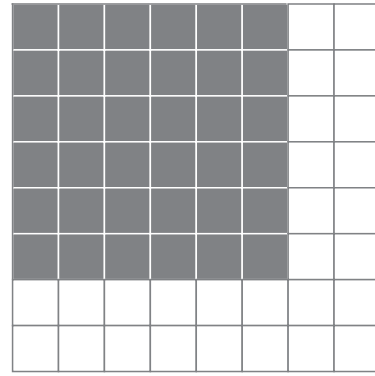

5x5 cm

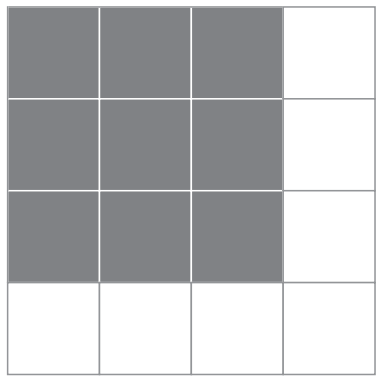

10x10 cm

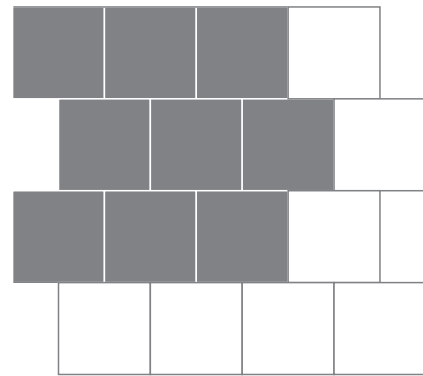

10x10 cm

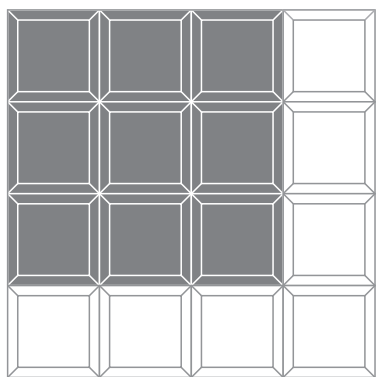

10x10 cm

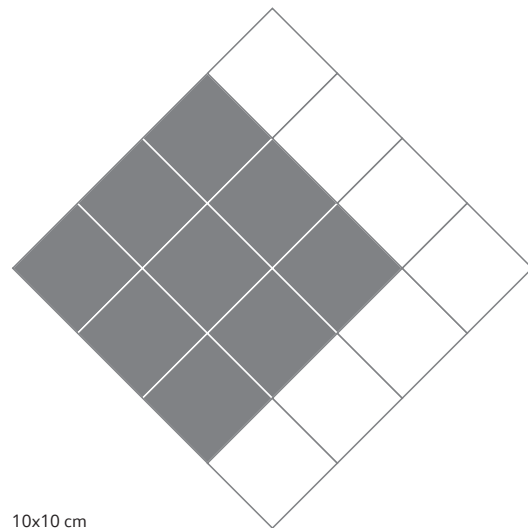

10x10 cm

**miniworx I BrickLay**

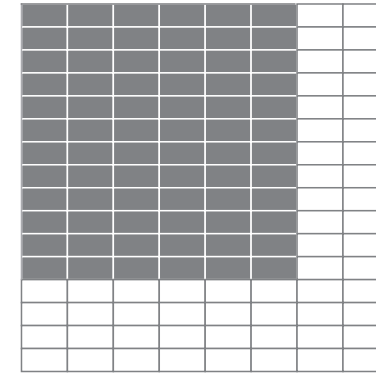

2,5x5 cm

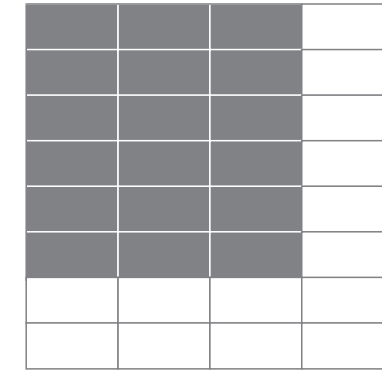

5x10 cm

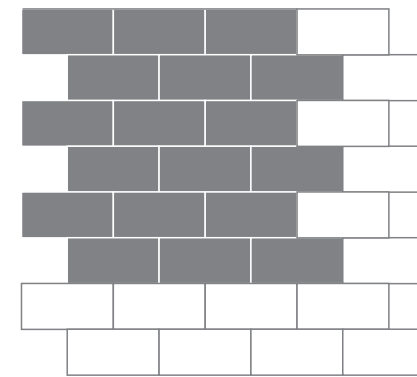

5x10 cm

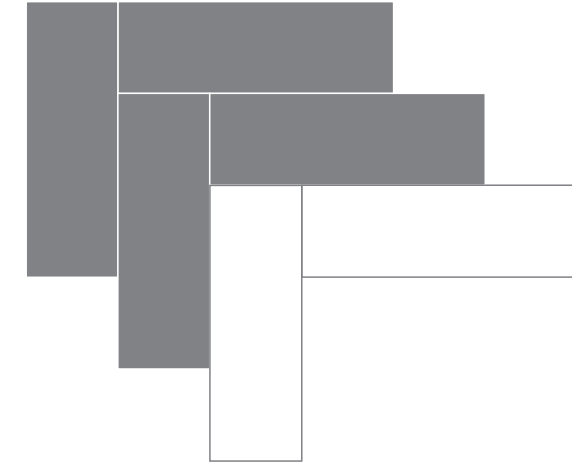

10x30 cm

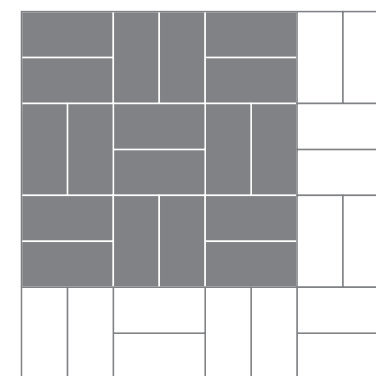

5x10 cm

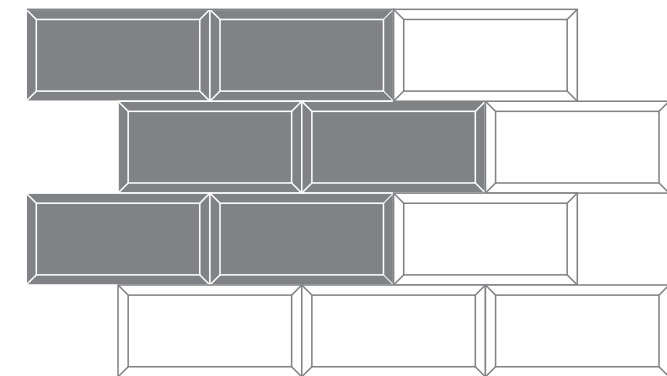

10x20 cm



**miniworx I SlimLay**

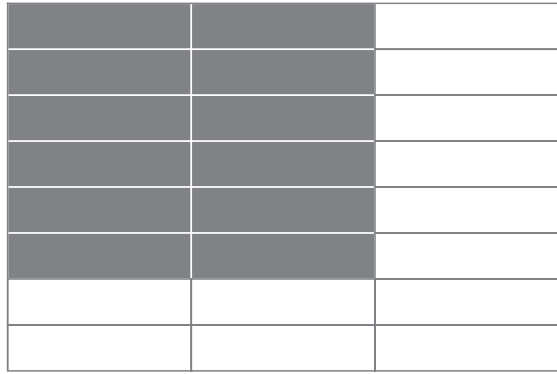

5x20 cm

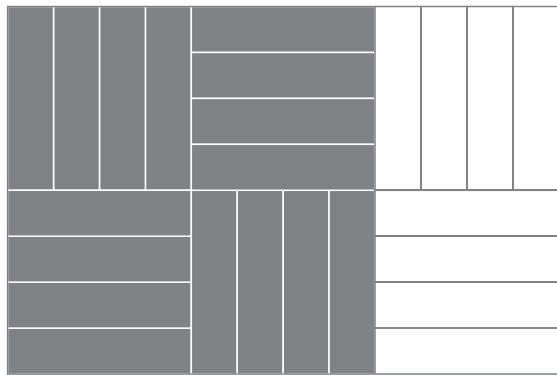

5x20 cm

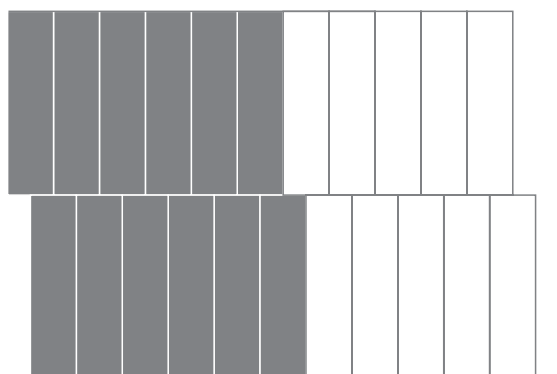

5x20 cm

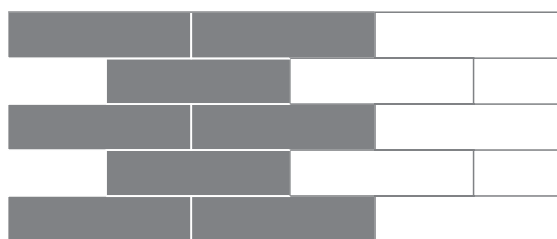

5x20 cm

**miniworx I HexaLay**

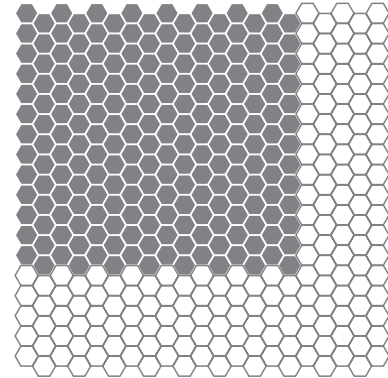

ø 2,5 cm

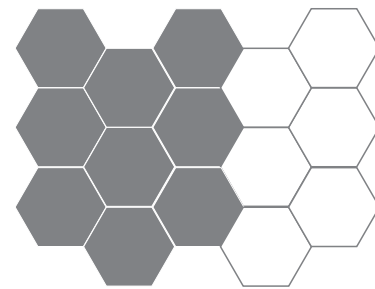

8x9 cm



21x24 cm

**miniworx I MixLay**

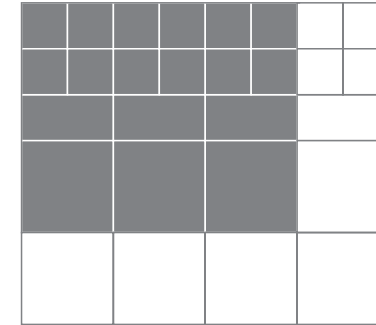

5x5, 5x10, 10x10 cm

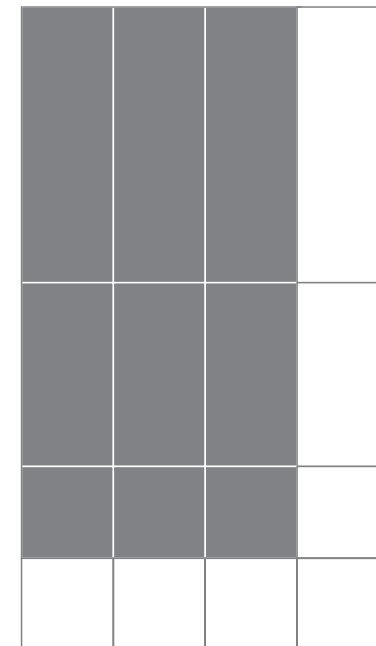
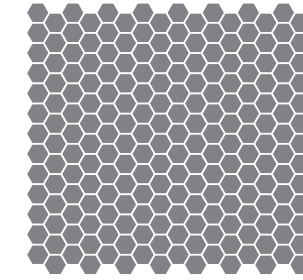

10x10, 10x20, 10x30 cm

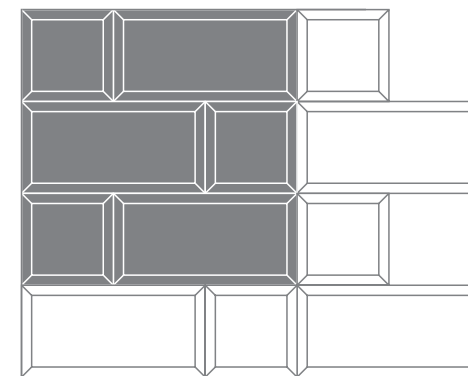

10x10, 10x20 cm

## Packing information / Paketleme bilgisi

Size Ebat (cm)	Body type Bütçe tipi	Type - Series Tip - Seri	Thickness Kalınlık (mm)	Edge Kenar	Weight per pc Karo ağırlığı (kg)	m <sup>2</sup> weight m <sup>2</sup> ağırlığı (kg)	Pcs per box Kutu içi adet	m <sup>2</sup> per box Kutu içi m <sup>2</sup>	Box weight Kutu ağırlığı (kg)	Pcs per pallet Palet içi adet	m <sup>2</sup> per pallet Palet içi m <sup>2</sup>	Pallet weight Palet ağırlığı (kg)
2.5x2.5	Porcelain / Porselen	Hexagon / Altgen	6	N.REC	0,01	11,00	1320	1,00	11,00	55,440	64,68	711
2.5x2.5	Porcelain / Porselen	Standard / Standart	6	N.REC	0,01	11,20	1584	1,00	11,20	66,528	42,00	470
2.5x5	Porcelain / Porselen	Standard / Standart	6	N.REC	0,01	11,50	792	1,00	11,50	33,264	64,68	744
2.5x5	Porcelain / Porselen	Standard / Standart	7,5	N.REC	1,44	16,00	10	0,90	14,40	780	70,20	1.123
3x3	Porcelain / Porselen	Standard / Standart	9	REC	1,60	17,80	8	0,72	12,82	624	64,68	1.151
3.7x20	Porcelain / Porselen	Standard / Standart	9	REC	1,32	19,50	6	0,41	7,90	288	19,44	379
5x5	Floor tile / Yer karosu	Standard / Standart	6	N.REC	0,03	11,70	396	1,00	11,70	30,888	78,00	913
5x5	Porcelain / Porselen	Standard / Standart	6	N.REC	0,03	11,70	396	1,00	11,70	30,888	78,00	913
5x5	Porcelain / Porselen	Standard / Standart	9	REC	0,04	17,00	288	0,72	12,24	22,464	56,16	955
5x10	Floor tile / Yer karosu	Standard / Standart	6	N.REC	0,06	12,00	198	1,00	12,00	15,444	78,00	936
5x20	Floor tile / Yer karosu	Brick / Tuğla	6	N.REC	1,05	12,00	11	0,96	11,52	528	46,08	553
5x20	Floor tile / Yer karosu	Herringbone / Balıksırtı	6	N.REC	0,96	12,00	11	0,88	10,56	660	52,80	634
5x20	Floor tile / Yer karosu	Plain / Düz	6	N.REC	0,72	12,00	11	0,66	7,92	1,320	79,20	950
8x9	Porcelain / Porselen	Standard / Standart	6	N.REC	0,08	13,60	99	0,57	7,75	4,158	23,94	326
10x10	Floor tile / Yer karosu	Standard / Standart	6	N.REC	0,13	12,50	99	1,00	12,50	7,722	78,00	975
10x10	Porcelain / Porselen	Standard / Standart	6	N.REC	0,13	12,50	99	1,00	12,50	7,722	78,00	975
10x20	Floor tile / Yer karosu	Standard / Standart	6	N.REC	0,254	12,70	50	1,00	12,70	1,092	84	1.067
10x30	Floor tile / Yer karosu	Standard / Standart	6	N.REC	0,38	12,40	33	1,00	12,40	2,376	72,00	893
10x30	Wall tile / Duvar karosu	Homemade - X	7,5	N.REC	0,34	11,35	28	0,84	9,53	2,156	64,68	734
10x30	Wall tile / Duvar karosu	Standard / Standart	7,5	N.REC	0,36	11,90	33	1,00	11,90	2,541	77,00	916
10x80	Porcelain / Porselen	Standard / Standart	10	REC	1,58	19,70	8	0,64	12,61	320	25,60	504
12,5x25	Porcelain / Porselen	Standard / Standart	6,5	N.REC	0,40	12,95	32	1,00	12,95	2,400	75,00	971
15x15	Floor tile / Yer karosu	Standard / Standart	6	N.REC	0,28	12,40	44	1,00	12,40	3,520	80,00	992
15x15	Porcelain / Porselen	retromix	9	N.REC	0,42	18,30	11	0,25	4,58	1,815	64,68	1.184
15x15	Porcelain / Porselen	Standard / Standart	8	N.REC	0,36	15,80	44	1,00	15,80	2,992	68,00	1.074
15x15	Porcelain / Porselen	Standard / Standart	9	N.REC	0,41	18,30	29	0,65	11,90	2,320	64,68	1.184
15x15	Wall tile / Duvar karosu	Standard / Standart	6	N.REC	0,22	9,50	44	1,00	9,50	4,400	100,00	950
20x120	Porcelain / Porselen	Standard / Standart	10	REC	5,14	21,40	4	0,96	20,54	192	46,08	986
20x120	Porcelain / Porselen	Standard / Standart	10	N.REC	5,23	21,80	4	0,96	20,93	192	46,08	1.005
20x20	Floor tile / Yer karosu	Standard / Standart	6	N.REC	0,50	12,50	25	1,00	12,50	2,025	81,00	1.013
20x20	Porcelain / Porselen	Standard / Standart	8	N.REC	0,66	16,40	30	1,20	22,32	1,710	19,56	1.140
20x20	Porcelain / Porselen	Standard / Standart	12	N.REC	0,99	24,85	16	0,64	15,90	960	38,40	954
20x20	Wall tile / Duvar karosu	Standard / Standart	6	N.REC	0,39	9,70	25	1,00	9,70	2,400	96,00	931
20x25	Wall tile / Duvar karosu	Standard / Standart	6,5	N.REC	0,53	10,50	20	1,00	11	100	100,00	1.075
20x30	Wall tile / Duvar karosu	Standard / Standart	7	N.REC	0,68	11,55	17	1,00	11,55	1,666	98,00	1.132
20x40	Wall tile / Duvar karosu	Standard / Standart	7	N.REC	0,948	11,85	13	1,04	12,32	936	74,88	887
20x50	Wall tile / Duvar karosu	Standard / Standart	9	N.REC	1,46	14,55	10	1,00	14,55	740	74,00	1.077
20x60	Wall tile / Duvar karosu	Standard / Standart	9	N.REC	1,79	14,90	9	1,08	16,09	576	69,12	1.030
21x24	Floor tile / Yer karosu	Standard / Standart	6	N.REC	0,51	12,70	25	1,00	12,70	1,900	76,00	965
21x24	Porcelain / Porselen	Standard / Standart	9	N.REC	0,74	18,50	17	0,68	12,58	1,292	51,68	956
25x33	Wall tile / Duvar karosu	Standard / Standart	7	N.REC	0,96	11,50	12	1,00	11,50	864	72,00	828
25x40	Wall tile / Duvar karosu	Standard / Standart	7,5	N.REC	1,21	12,10	10	1,00	12,10	720	72,00	871
30x120	Porcelain / Porselen	Standard / Standart	10	REC	7,67	21,30	6	2,16	46,01	144	51,84	1.104
30x30	Floor tile / Yer karosu	Standard / Standart	7	N.REC	1,34	14,75	11	1,00	14,75	792	72,00	1.062

Size Ebat (cm)	Body type Bütçe tipi	Type - Series Tip - Seri	Thickness Kalınlık (mm)	Edge Kenar	Weight per pc Karo ağırlığı (kg)	m <sup>2</sup> weight m <sup>2</sup> ağırlığı (kg)	Pcs per box Kutu içi adet	m <sup>2</sup> per box Kutu içi m <sup>2</sup>	Box weight Kutu ağırlığı (kg)	Pcs per pallet Palet içi adet	m <sup>2</sup> per pallet Palet içi m <sup>2</sup>	Pallet weight Palet ağırlığı (kg)
30x30	Porcelain / Porselen	Standard / Standart	7	REC	1,31	14,40	11	1,00	14,40	792	72,00	1.037
30x30	Porcelain / Porselen	Standard / Standart	7	N.REC	1,31	14,40	11	1,00	14,40	792	72,00	1.037
30x30	Porcelain / Porselen	Standard / Standart	7,5	Polish	1,34	14,75	11	1,00	14,75	660	60,00	885
30x30	Porcelain / Porselen	Standard / Standart	8	N.REC	1,47	16,15	11	1,00	16,15	660	60,00	969
30x30	Porcelain / Porselen	Standard / Standart	9	REC	1,64	18,00	11	1,00	18,00	660	60,00	1.080
30x30	Porcelain / Porselen	Standard / Standart	9	N.REC	1,64	18,00	11	1,00	18,00	660	60,00	1.080
30x30	Porcelain / Porselen	Standard / Standart	12	N.REC	2,30	25,35	11	1,00	25,35	418	38,00	963
30x30	Porcelain / Porselen	Standard / Standart	14	N.REC	2,58	28,70	9	0,81	23,25	342	30,78	884
30x60	Porcelain / Porselen	Standard / Standart	9	REC	3,38	18,75	6	1,08	20,25	240	43,20	810
30x60	Porcelain / Porselen	Standard / Standart	9	N.REC	3,38	18,75	6	1,08	20,25	240	43,20	810
30x60	Porcelain / Porselen	Standard / Standart	9,5	POL	3,64	20,23	6	1,08	21,85	240	43,20	874
30x60	Porcelain / Porselen	Standard / Standart	10	REC	3,82	21,20	6	1,08	22,90	240	43,20	916
30x60	Porcelain / Porselen	Standard / Standart	11	REC	4,00	22,22	6	1,08	24,00	240	43,20	960
30x60	Porcelain / Porselen	Standard / Standart	11	N.REC	4,03	22,41	6	1,08	24,20	240	43,20	968
30x60	Wall tile / Duvar karosu	Standard / Standart	9	N.REC	2,68	14,90	6	1,08	16,09	288	51,84	772
30x60	Wall tile / Duvar karosu	Standard / Standart	9	REC	2,58	14,35	6	1,08	15,50	288	51,84	744
30x90	Wall tile / Duvar karosu	mode	6	REC	2,75	10,20	6	1,62	16,52	192	64,68	660
33x100	Wall tile / Duvar karosu	Standard / Standart	11	REC	6,09	18,45	4	1,32	24,35	84	27,72	511
33x33	Floor tile / Yer karosu	Standard / Standart	7	N.REC	1,64	14,75	9	1,00	14,75	666	74,00	1.092
40x120	Porcelain / Porselen	Standard / Standart	20	REC	22,32	46,50	1	0,48	22,32	36	64,68	3.008
40x40	Floor tile / Yer karosu	Standard / Standart	8	N.REC	2,68	16,72	8	1,28	21,40	240	38,40	642
40x80	Porcelain / Porselen	Standard / Standart	9	REC	6,016	18,80	4	1,28	24,06	108	34,56	650
45x45	Porcelain / Porselen	Standard / Standart	9	N.REC	3,75	18,50	7	1,42	26,27	182	36,92	683
45x45	Porcelain / Porselen	Standard / Standart	10	REC	4,27	21,00	6	1,22	25,62	156	31,72	666
45x45	Porcelain / Porselen	Standard / Standart	11	N.REC	4,58	22,54	6	1,22	27,50	156	31,72	715
45x45	Porcelain / Porselen	Standard / Standart	14	N.REC	5,79	28,60	4	0,81	23,17	112	64,68	1.850
45x90	Porcelain / Porselen	Standard / Standart	9,5	POL	8,20	20,25	3	1,25	26,55	36	43,74	986
45x90	Porcelain / Porselen	Standard / Standart	10	REC	8,85	21,85	3	1,25	26,55	36	43,74	986
60x120	Porcelain / Porselen	Standard / Standart	9	REC	15,12	21,00	2	1,44	30,24	64	46,08	968
60x120	Porcelain / Porselen	Standard / Standart	10	REC	15,98	22,20	2	1,44	31,97	60	43,20	959
60x120	Porcelain / Porselen	Standard / Standart	11	REC	16,85	23,40	2	1,44	33,70	60	43,20	1.011
60x60	Porcelain / Porselen	Boxless / Kutusuz	20	REC	15,98	44,40	1	0,36	15,98	50	64,68	2.872
60x60	Porcelain / Porselen	Standard / Standart	9	REC	6,75	18,75	4	1,44	27,00	120	43,20	810
60x60	Porcelain / Porselen	Standard / Standart	9	N.REC	7,13	19,80	4	1,44	28,51	120	43,20	855
60x60	Porcelain / Porselen	Standard / Standart	9,5	POL	7,10	19,71	4	1,44	28,38	120	43,20	851
60x60	Porcelain / Porselen	Standard / Standart	10	N.REC	7,75	21,53	4	1,44	31,00	120	43,20	930
60x60	Porcelain / Porselen	Standard / Standart	10	REC	7,60	21,11	4	1,44	30,40	120	43,20	912
60x60	Porcelain / Porselen	Standard / Standart	11	REC	7,92	22,00	4	1,44	31,68	120	43,20	950
60x60	Porcelain / Porselen	Standard / Standart	11	N.REC	8,01	22,25	4	1,44	32,04	120	43,20	961
60x60	Porcelain / Porselen	Standard / Standart	20	REC	15,84	44,00	1	0,36	15,84	50	18,00	792
80x80	Porcelain / Porselen	Standard / Standart	10	REC	13,76	21,50	2	1,28	27,52	80	51,20	1.101
80x80	Porcelain / Porselen	Standard / Standart	9	REC	12,288	19,20	2	1,28	24,58	88	56,32	1.081
100x100	Porcelain / Porselen	Standard / Standart	5,5	REC	11,50	11,50	2	2,00	23,00	50	64,68	744
100x300	Porcelain / Porselen	Standard / Standart	3,5	REC	25,50	8,50	1	3,00	25,50	20	64,68	550
100x300	Porcelain / Porselen	Standard / Standart	5,5	REC	34,50	11,50	1	3,00	34,50	13	64,68	744



## Test results / Test sonuçları

### Aspenwood

Sizes / Ebatlar	Units in box / Kutu içi adet	Box m <sup>2</sup> / Kutu içi m <sup>2</sup>	Box kg / Kutu içi kg	Units in pallet / Palet içi adet	Pallet m <sup>2</sup> / Palet m <sup>2</sup>	Pallet kg / Palet kg	Thickness / Kalınlık
20x120 Rectified / Rektifiyeli	4	0,96	20,65	48	46,08	1016	10
20x120 Non-rectified / Rektifiyesiz	4	0,96	20,65	48	46,08	1016	10

Collection / Koleksiyon	Body type / Bünye tipi	Rectified - Non-rectified / Rektifiyeli - Rektifiyesiz	Surface / Yüzey	Size / Ebat	Water absorption / Su emme EN ISO 10545-3	Breaking strength / Kırılma dayanımı EN ISO 10545-4	Bending strength / Eğilme dayanımı EN ISO 10545-4	Resistance to deep abrasion / Derin aşınma dayanımı EN ISO 10545-6	MOHs	Pendulum dry TRL (55) / Pendulum kuru TRL (55) BS 7976-2	Pendulum wet TRL (55) / Pendulum ıslak TRL (55) BS 7976-2	Pendulum dry 4S (96) / Pendulum kuru 4S (96) BS 7976-2	Pendulum wet 4S (96) / Pendulum ıslak 4S (96) BS 7976-2	DCOF ANSI A137.1 Section 9.6.1
Aspenwood	Bla	Rectified / Rektifiyeli	R10A	20x120	Avg. Ev ≤ 0,5 %	> 1300 N	Min. 35 N/mm <sup>2</sup>	Not Applicable	9	PTV Dry ≥ 36	PTV Wet ≤ 24	PTV Dry ≥ 36	PTV Wet ≤ 24	≥ 0.42
Aspenwood	Bla	Non-rectified / Rektifiyesiz	R10A	20x120	Avg. Ev ≤ 0,5 %	> 1300 N	Min. 35 N/mm <sup>2</sup>	Not Applicable	9	PTV Dry ≥ 36	PTV Wet ≤ 24	PTV Dry ≥ 36	PTV Wet ≤ 24	≥ 0.42

### BetonX

Sizes / Ebatlar	Units in box / Kutu içi adet	Box m <sup>2</sup> / Kutu içi m <sup>2</sup>	Box kg / Kutu içi kg	Units in pallet / Palet içi adet	Pallet m <sup>2</sup> / Palet m <sup>2</sup>	Pallet kg / Palet kg	Thickness / Kalınlık
5x5 Rectified / Rektifiyeli	8	0,72	10,87	78	56,16	873,02	9
15x15 Non-rectified / Rektifiyesiz	11	0,25	4,50	165	41,25	770,00	9
30x30 Non-rectified / Rektifiyesiz	11	1,00	14,44	72	72,00	1.064,39	7
30x60 Rectified / Rektifiyeli	6	1,08	20,10	40	43,20	828,95	9
60x60 Rectified / Rektifiyeli	4	1,44	27,00	30	43,20	835,00	9

Collection / Koleksiyon	Body type / Bünye tipi	Rectified - Non-rectified / Rektifiyeli - Rektifiyesiz	Surface / Yüzey	Size / Ebat	Water absorption / Su emme EN ISO 10545-3	Breaking strength / Kırılma dayanımı EN ISO 10545-4	Bending strength / Eğilme dayanımı EN ISO 10545-4	Resistance to deep abrasion / Derin aşınma dayanımı EN ISO 10545-6	MOHs	Pendulum dry TRL (55) / Pendulum kuru TRL (55) BS 7976-2	Pendulum wet TRL (55) / Pendulum ıslak TRL (55) BS 7976-2	Pendulum dry 4S (96) / Pendulum kuru 4S (96) BS 7976-2	Pendulum wet 4S (96) / Pendulum ıslak 4S (96) BS 7976-2	DCOF ANSI A137.1 Section 9.6.1
BetonX	Bla	Rectified / Rektifiyeli	R10B	5x5	Avg. Ev ≤ 0,5 %	> 1300 N	Min. 35 N/mm <sup>2</sup>	Max. 175 mm <sup>3</sup>	8-9	PTV Dry ≥ 36	25 ≤ PTV Wet < 36	PTV Dry ≥ 36	PTV Wet ≥ 36	Not Applicable
BetonX	Bla	Non-rectified / Rektifiyesiz	R9	15x15	Avg. Ev ≤ 0,5 %	> 1300 N	Min. 35 N/mm <sup>2</sup>	Max. 175 mm <sup>3</sup>	8-9	PTV Dry ≥ 36	PTV Wet ≤ 24	PTV Dry ≥ 36	PTV Wet ≤ 24	Not Applicable
BetonX	Bla	Non-rectified / Rektifiyesiz	R10B	30x30	Avg. Ev ≤ 0,5 %	> 1300 N	Min. 35 N/mm <sup>2</sup>	Max. 175 mm <sup>3</sup>	8-9	PTV Dry ≥ 36	25 ≤ PTV Wet < 36	PTV Dry ≥ 36	PTV Wet ≥ 36	Not Applicable
BetonX	Bla	Rectified / Rektifiyeli	R10B	30x60	Avg. Ev ≤ 0,5 %	> 1300 N	Min. 35 N/mm <sup>2</sup>	Max. 175 mm <sup>3</sup>	8-9	PTV Dry ≥ 36	25 ≤ PTV Wet < 36	PTV Dry ≥ 36	PTV Wet ≥ 36	Not Applicable
BetonX	Bla	Rectified / Rektifiyeli	R10B	60x60	Avg. Ev ≤ 0,5 %	> 1300 N	Min. 35 N/mm <sup>2</sup>	Max. 175 mm <sup>3</sup>	8-9	PTV Dry ≥ 36	25 ≤ PTV Wet < 36	PTV Dry ≥ 36	PTV Wet ≥ 36	Not Applicable

### Boscstone

Sizes / Ebatlar	Units in box / Kutu içi adet	Box m <sup>2</sup> / Kutu içi m <sup>2</sup>	Box kg / Kutu içi kg	Units in pallet / Palet içi adet	Pallet m <sup>2</sup> / Palet m <sup>2</sup>	Pallet kg / Palet kg	Thickness / Kalınlık
60x60 Rectified / Rektifiyeli	4	1,44	26,5	30	43,2	835	9
30x60 Rectified / Rektifiyeli	6	1,08	20,3	40	43,2	820	9

Collection / Koleksiyon	Body type / Bünye tipi	Rectified - Non-rectified / Rektifiyeli - Rektifiyesiz	Surface / Yüzey	Size / Ebat	Water absorption / Su emme EN ISO 10545-3	Breaking strength / Kırılma dayanımı EN ISO 10545-4	Bending strength / Eğilme dayanımı EN ISO 10545-4	Resistance to deep abrasion / Derin aşınma dayanımı EN ISO 10545-6	MOHs	Pendulum dry TRL (55) / Pendulum kuru TRL (55) BS 7976-2	Pendulum wet TRL (55) / Pendulum ıslak TRL (55) BS 7976-2	Pendulum dry 4S (96) / Pendulum kuru 4S (96) BS 7976-2	Pendulum wet 4S (96) / Pendulum ıslak 4S (96) BS 7976-2	DCOF ANSI A137.1 Section 9.6.1
Boscstone	Bla	Rectified / Rektifiyeli	R10B	60x60	Avg. Ev ≤ 0,5 %	>1300 N	>35 N/mm <sup>2</sup>	Max. 175 mm <sup>3</sup>	8'-9	PTV Dry≥36	25≤PTV Wet≤36	PTV Dry≥36	PTV Wet≥36	≥ 0.42
Boscstone	Bla	Rectified / Rektifiyeli	R10B	30x60	Avg. Ev ≤ 0,5 %	>1300 N	>35 N/mm <sup>2</sup>	Max. 175 mm <sup>3</sup>	8'-9	PTV Dry≥36	25≤PTV Wet≤36	PTV Dry≥36	PTV Wet≥36	≥ 0.42

## Test results / Test sonuçları

### Canyon

Sizes / Ebatlar	Units in box / Kutu içi adet	Box m <sup>2</sup> / Kutu içi m <sup>2</sup>	Box kg / Kutu içi kg	Units in pallet / Palet içi adet	Pallet m <sup>2</sup> / Palet m <sup>2</sup>	Pallet kg / Palet kg	Thickness / Kalınlık
60x60 Rectified / Rektifiyeli	4	1,44	26,9	30	43,2	807	9
30x60 Rectified / Rektifiyeli	6	1,08	20,2	40	43,2	807	9

Collection / Koleksiyon	Body type / Bünye tipi	Rectified - Non-rectified / Rektifiyeli - Rektifiyesiz	Surface / Yüzey	Size / Ebat	Water absorption / Su emme EN ISO 10545-3	Breaking strength / Kırılma dayanımı EN ISO 10545-4	Bending strength / Eğilme dayanımı EN ISO 10545-4	Resistance to deep abrasion / Derin aşınma dayanımı EN ISO 10545-6	MOHs MOHs	Pendulum dry TRL (55) / Pendulum kuru TRL (55) BS 7976-2	Pendulum wet TRL (55) / Pendulum ıslak TRL (55) BS 7976-2	Pendulum dry 4S (96) / Pendulum kuru 4S (96) BS 7976-2	Pendulum wet 4S (96) / Pendulum ıslak 4S (96) BS 7976-2	DCOF ANSI A137.1 Section 9.6.1
Canyon	Bla	Rectified / Rektifiyeli	R10B	60x60	Avg. Ev ≤ 0,5 %	> 1300 N	Min. 35 N/mm <sup>2</sup>	Not Applicable	8-9	PTV Dry ≥ 36	PTV Wet ≤ 36	PTV Dry ≥ 36	PTV Wet ≥ 36	≥ 0.42
Canyon	Bla	Rectified / Rektifiyeli	R10B	30x60	Avg. Ev ≤ 0,5 %	> 1300 N	Min. 35 N/mm <sup>2</sup>	Not Applicable	8-9	PTV Dry ≥ 36	PTV Wet ≤ 36	PTV Dry ≥ 36	PTV Wet ≥ 36	≥ 0.42

### Cardostone

Sizes / Ebatlar	Units in box / Kutu içi adet	Box m <sup>2</sup> / Kutu içi m <sup>2</sup>	Box kg / Kutu içi kg	Units in pallet / Palet içi adet	Pallet m <sup>2</sup> / Palet m <sup>2</sup>	Pallet kg / Palet kg	Thickness / Kalınlık
80x80 Rectified / Rektifiyeli	2	1,28	24,5	44	56,32	1103	9
40x80 Rectified / Rektifiyeli	4	1,28	24,1	27	34,6	675	9
60x120 Rectified / Rektifiyeli	2	1,44	29,52	36	51,84	1098	9
60x60 Rectified / Rektifiyeli	4	1,44	26,5	30	43,2	835	9
60x60 Rectified / Rektifiyeli 20mm	1	0,36	15,37	50	18	793,6	20
30x60 Cut border / Kesme bordür	6	1,08	20,1	40	43,2	828,95	9
10x80 Plinth / Süpürgelik	9	0,72	13,5	40	28,8	550	9
8.5x60 Plinth / Süpürgelik	6	0,93	16,74	48	44,16	739,24	9
5x5 Mosaic / Mozaik	8	0,72	10,87	78	56,16	873	9

Collection / Koleksiyon	Body type / Bünye tipi	Rectified - Non-rectified / Rektifiyeli - Rektifiyesiz	Surface / Yüzey	Size / Ebat	Water absorption / Su emme EN ISO 10545-3	Breaking strength / Kırılma dayanımı EN ISO 10545-4	Bending strength / Eğilme dayanımı EN ISO 10545-4	Resistance to deep abrasion / Derin aşınma dayanımı EN ISO 10545-6	MOHs MOHs	Pendulum dry TRL (55) / Pendulum kuru TRL (55) BS 7976-2	Pendulum wet TRL (55) / Pendulum ıslak TRL (55) BS 7976-2	Pendulum dry 4S (96) / Pendulum kuru 4S (96) BS 7976-2	Pendulum wet 4S (96) / Pendulum ıslak 4S (96) BS 7976-2	DCOF ANSI A137.1 Section 9.6.1
Cardostone	Bla	Rectified / Rektifiyeli	R10A	40x80	Avg. Ev ≤ 0,5 %	> 1300 N	Min. 35 N/mm <sup>2</sup>	Max. 175 mm <sup>3</sup>	9	NPD	NPD	PTV Dry ≥ 36	25 ≤ PTV Wet < 36	≥ 0.42
Cardostone	Bla	Rectified / Rektifiyeli	R10A	80x80	Avg. Ev ≤ 0,5 %	> 1300 N	Min. 35 N/mm <sup>2</sup>	Max. 175 mm <sup>3</sup>	9	NPD	NPD	PTV Dry ≥ 36	25 ≤ PTV Wet < 36	≥ 0.42
Cardostone	Bla	Rectified / Rektifiyeli	R10A	60x60	Avg. Ev ≤ 0,5 %	> 1300 N	Min. 35 N/mm <sup>2</sup>	Max. 175 mm <sup>3</sup>	9	NPD	NPD	PTV Dry ≥ 36	25 ≤ PTV Wet < 36	≥ 0.42
Cardostone	Bla	Rectified / Rektifiyeli	R11C	60x60	Avg. Ev ≤ 0,5 %	> 1300 N	Min. 35 N/mm <sup>2</sup>	Max. 175 mm <sup>3</sup>	9	PTV Dry ≥ 36	PTV Wet ≥ 36	PTV Dry ≥ 36	PTV Wet ≥ 36	≥ 0.42
Cardostone	Bla	Rectified / Rektifiyeli	R11	60x60	Avg. Ev ≤ 0,5 %	> 1300 N	Min. 35 N/mm <sup>2</sup>	Max. 175 mm <sup>3</sup>	9	PTV Dry ≥ 36	25 ≤ PTV Wet < 36	PTV Dry ≥ 36	25 ≤ PTV Wet < 36	≥ 0.42
Cardostone	Bla	Rectified / Rektifiyeli	R10A	60x120	Avg. Ev ≤ 0,5 %	> 1300 N	Min. 35 N/mm <sup>2</sup>	Max. 175 mm <sup>3</sup>	9	NPD	NPD	PTV Dry ≥ 36	25 ≤ PTV Wet < 36	≥ 0.42
Cardostone	Bla	Rectified / Rektifiyeli	R10A	30x60	Avg. Ev ≤ 0,5 %	> 1300 N	Min. 35 N/mm <sup>2</sup>	Max. 175 mm <sup>3</sup>	9	NPD	NPD	PTV Dry ≥ 36	25 ≤ PTV Wet < 36	≥ 0.42
Cardostone	Bla	Rectified / Rektifiyeli	R10B	30x60	Avg. Ev ≤ 0,5 %	> 1300 N	Min. 35 N/mm <sup>2</sup>	Max. 175 mm <sup>3</sup>	9	NPD	NPD	PTV Dry ≥ 36	25 ≤ PTV Wet < 36	≥ 0.42



## Test results / Test sonuçları

### CementMix

Sizes / Ebatlar	Units in box / Kutu içi adet	Box m <sup>2</sup> / Kutu içi m <sup>2</sup>	Box kg / Kutu içi kg	Units in pallet / Palet içi adet	Pallet m <sup>2</sup> / Palet m <sup>2</sup>	Pallet kg / Palet kg	Thickness / Kalınlık
80x80 Rectified / Rektifiyeli	2	1,28	24,5	44	56,32	1103	9
60x60 Rectified / Rektifiyeli	4	1,44	26,5	30	43,2	835	9
30x60 Rectified / Rektifiyeli	6	1,08	20,3	40	43,2	820	9

Collection / Koleksiyon	Body type / Bünye tipi	Rectified - Non-rectified / Rektifiyeli - Rektifiyesiz	Surface / Yüzey	Size / Ebat	Water absorption / Su emme	Breaking strength / Kırılma dayanımı	Bending strength / Eğilme dayanımı	Resistance to deep abrasion / Derin aşınma dayanımı	MOHs	Pendulum dry TRL (55) / Pendulum kuru TRL (55)	Pendulum wet TRL (55) / Pendulum ıslak TRL (55)	Pendulum dry 4S (96) / Pendulum kuru 4S (96)	Pendulum wet 4S (96) / Pendulum ıslak 4S (96)	DCOF
					EN ISO 10545-3	EN ISO 10545-4	EN ISO 10545-4	EN ISO 10545-6	MOHs	BS 7976-2	BS 7976-2	BS 7976-2	BS 7976-2	ANSI A137.1 Section 9.6.1
CementMix Fine Geo	Bla	Rectified / Rektifiyeli	R11B	80x80	Avg. Ev ≤ 0,5 %	> 1300 N	Min. 35 N/mm <sup>2</sup>	Max. 175 mm <sup>3</sup>	-	NPD	NPD	NPD	NPD	≥ 0,42
CementMix Fine Geo	Bla	Rectified / Rektifiyeli	R11B	60x60	Avg. Ev ≤ 0,5 %	> 1300 N	Min. 35 N/mm <sup>2</sup>	Max. 175 mm <sup>3</sup>	-	NPD	NPD	NPD	NPD	≥ 0,42
CementMix Fine Random	Bla	Rectified / Rektifiyeli	R10A	80x80	Avg. Ev ≤ 0,5 %	> 1300 N	Min. 35 N/mm <sup>2</sup>	Max. 175 mm <sup>3</sup>	-	NPD	NPD	NPD	NPD	< 0,42
CementMix Fine Random	Bla	Rectified / Rektifiyeli	R10A	60x60	Avg. Ev ≤ 0,5 %	> 1300 N	Min. 35 N/mm <sup>2</sup>	Max. 175 mm <sup>3</sup>	-	NPD	NPD	NPD	NPD	< 0,42
CementMix Fine Micro	Bla	Rectified / Rektifiyeli	R10A	80x80	Avg. Ev ≤ 0,5 %	> 1300 N	Min. 35 N/mm <sup>2</sup>	Max. 175 mm <sup>3</sup>	-	NPD	NPD	NPD	NPD	≥ 0,42
CementMix Fine Micro	Bla	Rectified / Rektifiyeli	R10A	60x60	Avg. Ev ≤ 0,5 %	> 1300 N	Min. 35 N/mm <sup>2</sup>	Max. 175 mm <sup>3</sup>	-	NPD	NPD	NPD	NPD	≥ 0,42
CementMix Meso	Bla	Rectified / Rektifiyeli	R10B	80x80	Avg. Ev ≤ 0,5 %	>1300 N	Min. 35 N/mm <sup>2</sup>	Max. 175 mm <sup>3</sup>	8'-9	NPD	NPD	NPD	NPD	≥ 0,42
CementMix Meso	Bla	Rectified / Rektifiyeli	R10B	60x60	Avg. Ev ≤ 0,5 %	>1300 N	Min. 35 N/mm <sup>2</sup>	Max. 175 mm <sup>3</sup>	8'-9	NPD	NPD	NPD	NPD	≥ 0,42
CementMix Meso	Bla	Rectified / Rektifiyeli	R10B	30x60	Avg. Ev ≤ 0,5 %	>1300 N	Min. 35 N/mm <sup>2</sup>	Max. 175 mm <sup>3</sup>	8'-9	NPD	NPD	NPD	NPD	≥ 0,42
CementMix Fine Flake	Bla	Rectified / Rektifiyeli	R10A	80x80	Avg. Ev ≤ 0,5 %	> 1300 N	Min. 35 N/mm <sup>2</sup>	Max. 175 mm <sup>3</sup>	-	PTV Dry ≥ 36	PTV Wet ≤ 24	PTV Dry ≥ 36	PTV Wet ≤ 24	≥ 0,42
CementMix Fine Flake	Bla	Rectified / Rektifiyeli	R10A	60x60	Avg. Ev ≤ 0,5 %	> 1300 N	Min. 35 N/mm <sup>2</sup>	Max. 175 mm <sup>3</sup>	-	PTV Dry ≥ 36	PTV Wet ≤ 24	PTV Dry ≥ 36	PTV Wet ≤ 24	≥ 0,42

### Cementine

Sizes / Ebatlar	Units in box / Kutu içi adet	Box m <sup>2</sup> / Kutu içi m <sup>2</sup>	Box kg / Kutu içi kg	Units in pallet / Palet içi adet	Pallet m <sup>2</sup> / Palet m <sup>2</sup>	Pallet kg / Palet kg	Thickness / Kalınlık
60x120 Rectified / Rektifiyeli	2	1,44	29,52	36	51,84	1098	9
60x60 Rectified / Rektifiyeli	4	1,44	26,5	30	43,2	835	9
30x60 Rectified / Rektifiyeli	6	1,08	20,3	40	43,2	820	9
30x60 Non-rectified / Rektifiyesiz Wall / Duvar	6	1,08	16,2	48	51,84	805	9
30x30 Non-rectified / Rektifiyesiz	11	1	18	72	72	1296	7
15x15 Non-rectified / Rektifiyesiz	29	0,64	18,4	80	52	942,08	9
30x120 Tread / Basamak	3	1,8	23	44	47,52	1035	9
5x5 Cut decor / Kesme dekor	8	0,72	10,87	78	56,16	873	9
8.5x60 Plinth / Süpürgelik	18	0,92	16,74	48	44,16	739,24	9

Collection / Koleksiyon	Body type / Bünye tipi	Rectified - Non-rectified / Rektifiyeli - Rektifiyesiz	Surface / Yüzey	Size / Ebat	Water absorption / Su emme	Breaking strength / Kırılma dayanımı	Bending strength / Eğilme dayanımı	Resistance to deep abrasion / Derin aşınma dayanımı	MOHs	Pendulum dry TRL (55) / Pendulum kuru TRL (55)	Pendulum wet TRL (55) / Pendulum ıslak TRL (55)	Pendulum dry 4S (96) / Pendulum kuru 4S (96)	Pendulum wet 4S (96) / Pendulum ıslak 4S (96)	DCOF
					EN ISO 10545-3	EN ISO 10545-4	EN ISO 10545-4	EN ISO 10545-6	MOHs	BS 7976-2	BS 7976-2	BS 7976-2	BS 7976-2	ANSI A137.1 Section 9.6.1
Cementine	Bla	Rectified / Rektifiyeli	LPR	60x120	Avg. Ev ≤ 0,5 %	>1300 N	>35 N/mm <sup>2</sup>	Max. 175 mm <sup>3</sup>	3'-4	NPD	NPD	NPD	NPD	NPD
Cementine	Bla	Rectified / Rektifiyeli	R10B	60x120	Avg. Ev ≤ 0,5 %	>1300 N	>35 N/mm <sup>2</sup>	Max. 175 mm <sup>3</sup>	8'-9	PTV Dry≥36	25sPTV Wet≤ 36	PTV Dry≥36	PTV Wet≥36	≥ 0,42
Cementine	Bla	Rectified / Rektifiyeli	LPR	60x60	Avg. Ev ≤ 0,5 %	>1300 N	>35 N/mm <sup>2</sup>	Max. 175 mm <sup>3</sup>	3'-4	NPD	NPD	NPD	NPD	NPD
Cementine	Bla	Rectified / Rektifiyeli	R10B	60x60	Avg. Ev ≤ 0,5 %	>1300 N	>35 N/mm <sup>2</sup>	Max. 175 mm <sup>3</sup>	8'-9	PTV Dry≥36	25sPTV Wet≤ 36	PTV Dry≥36	PTV Wet≥36	≥ 0,42
Cementine	Bla	Rectified / Rektifiyeli	LPR	30x60	Avg. Ev ≤ 0,5 %	>1300 N	>35 N/mm <sup>2</sup>	Not Applicable	3'-4	NPD	NPD	NPD	NPD	NPD
Cementine	Bla	Rectified / Rektifiyeli	R10B	30x60	Avg. Ev ≤ 0,5 %	>1300 N	>35 N/mm <sup>2</sup>	Not Applicable	8'-9	PTV Dry≥36	25sPTV Wet≤ 36	PTV Dry≥36	PTV Wet≥36	≥ 0,42
Cementine	Bla	Rectified / Rektifiyeli	Matt	30x60	Avg. Ev >10 %	>600 N	>15 N/mm <sup>2</sup>	Not Applicable	N/A	NPD	NPD	NPD	NPD	NPD
Cementine	Bla	Non-rectified / Rektifiyesiz	R10B	30x30	Avg. Ev ≤ 0,5 %	>1300 N	>35 N/mm <sup>2</sup>	Max. 175 mm <sup>3</sup>	8'-9	PTV Dry≥36	25sPTV Wet≤ 36	PTV Dry≥36	PTV Wet≥36	≥ 0,42
Cementine	Bla	Non-rectified / Rektifiyesiz	LPR	30x30	Avg. Ev ≤ 0,5 %	>1300 N	>35 N/mm <sup>2</sup>	Max. 175 mm <sup>3</sup>	3'-4	NPD	NPD	NPD	NPD	NPD
Cementine	Bla	Rectified / Rektifiyeli	R10B	5x5	Avg. Ev ≤ 0,5 %	>1300 N	>35 N/mm <sup>2</sup>	Not Applicable	8'-9	PTV Dry≥36	25sPTV Wet≤ 36	PTV Dry≥36	PTV Wet≥36	≥ 0,42

## Test results / Test sonuçları

### Ceppostone

Sizes / Ebatlar	Units in box / Kutu içi adet	Box m <sup>2</sup> / Kutu içi m <sup>2</sup>	Box kg / Kutu içi kg	Units in pallet / Palet içi adet	Pallet m <sup>2</sup> / Palet m <sup>2</sup>	Pallet kg / Palet kg	Thickness / Kalınlık
60x120 Rectified / Rektifiyeli	2	1,44	29,52	36	51,84	1098	9
80x80 Rectified / Rektifiyeli	4	1,28	24,1	27	34,6	675	9
60x60 Rectified / Rektifiyeli	2	1,44	30,2	32	46,1	1005	9
60x60 Rectified / Rektifiyeli 20mm	4	1,44	26,5	30	43,2	835	9
40x80 Rectified / Rektifiyeli	6	1,08	20,3	40	43,2	820	9
30x60 Rectified / Rektifiyeli	8	0,72	10,87	78	56,16	873	9
15x15 Rectified / Rektifiyeli	1	0,36	15,37	50	18	793,6	20
5x5 Mosaic decor / Mozaik dekor	9	0,72	13,5	40	28,8	550	9
10x80 Plinth / Süpürgelik	18	0,92	16,74	48	44,16	739,24	9
8.5x60 Plinth / Süpürgelik	29	0,65	11,96	80	52	980	9

Collection / Koleksiyon	Body type / Bünye tipi	Rectified - Non-rectified / Rektifiyeli - Rektifiyesiz	Surface / Yüzey	Size / Ebat	Water absorption / Su emme EN ISO 10545-3	Breaking strength / Kırılma dayanımı EN ISO 10545-4	Bending strength / Eğilme dayanımı EN ISO 10545-4	Resistance to deep abrasion / Derin aşınma dayanımı EN ISO 10545-6	MOHs	Pendulum dry TRL (55) / Pendulum kuru TRL (55) BS 7976-2	Pendulum wet TRL (55) / Pendulum ıslak TRL (55) BS 7976-2	Pendulum dry 4S (96) / Pendulum kuru 4S (96) BS 7976-2	Pendulum wet 4S (96) / Pendulum ıslak 4S (96) BS 7976-2	DCOF ANSI A137.1 Section 9.6.1
Ceppostone	Bla	Rectified / Rektifiyeli	R9	80x80	Avg. Ev ≤ 0,5 %	> 1300 N	Min. 35 N/mm <sup>2</sup>	Max. 175 mm <sup>3</sup>	9	PTV Dry ≥ 36	PTV Wet ≤ 24	PTV Dry ≥ 36	PTV Wet ≤ 24	< 0.42
Ceppostone	Bla	Rectified / Rektifiyeli	R9	40x80	Avg. Ev ≤ 0,5 %	> 1300 N	Min. 35 N/mm <sup>2</sup>	Max. 175 mm <sup>3</sup>	9	PTV Dry ≥ 36	PTV Wet ≤ 24	PTV Dry ≥ 36	PTV Wet ≤ 24	< 0.42
Ceppostone	Bla	Rectified / Rektifiyeli	R9	60x60	Avg. Ev ≤ 0,5 %	> 1300 N	Min. 35 N/mm <sup>2</sup>	Max. 175 mm <sup>3</sup>	9	PTV Dry ≥ 36	PTV Wet ≤ 24	PTV Dry ≥ 36	PTV Wet ≤ 24	< 0.42

### Craft

Sizes / Ebatlar	Units in box / Kutu içi adet	Box m <sup>2</sup> / Kutu içi m <sup>2</sup>	Box kg / Kutu içi kg	Units in pallet / Palet içi adet	Pallet m <sup>2</sup> / Palet m <sup>2</sup>	Pallet kg / Palet kg	Thickness / Kalınlık
20x120 Rectified / Rektifiyeli	4	0,96	21,5	48	46,08	1032	10
20x120 Non-rectified / Rektifiyesiz	4	0,96	21,5	48	46,08	1032	10
30x120 Rectified / Rektifiyeli	6	2,16	46,2	24	51,84	1100	10
40x120 Rectified / Rektifiyeli 20 mm	1	0,48	20,49	36	17,28	737,8	20

Collection / Koleksiyon	Body type / Bünye tipi	Rectified - Non-rectified / Rektifiyeli - Rektifiyesiz	Surface / Yüzey	Size / Ebat	Water absorption / Su emme EN ISO 10545-3	Breaking strength / Kırılma dayanımı EN ISO 10545-4	Bending strength / Eğilme dayanımı EN ISO 10545-4	Resistance to deep abrasion / Derin aşınma dayanımı EN ISO 10545-6	MOHs	Pendulum dry TRL (55) / Pendulum kuru TRL (55) BS 7976-2	Pendulum wet TRL (55) / Pendulum ıslak TRL (55) BS 7976-2	Pendulum dry 4S (96) / Pendulum kuru 4S (96) BS 7976-2	Pendulum wet 4S (96) / Pendulum ıslak 4S (96) BS 7976-2	DCOF ANSI A137.1 Section 9.6.1
Craft	Bla	Rectified / Rektifiyeli	R10	20x120	Avg. Ev ≤ 0,5 %	> 1300 N	Min. 35 N/mm <sup>2</sup>	Not Applicable	9	NPD	NPD	NPD	NPD	≥ 0.42
Craft	Bla	Non-rectified / Rektifiyesiz	R10	20x120	Avg. Ev ≤ 0,5 %	> 1300 N	Min. 35 N/mm <sup>2</sup>	Not Applicable	9	NPD	NPD	NPD	NPD	≥ 0.42
Craft	Bla	Rectified / Rektifiyeli	R10	30x120	Avg. Ev ≤ 0,5 %	> 1300 N	Min. 35 N/mm <sup>2</sup>	Not Applicable	9	NPD	NPD	NPD	NPD	≥ 0.42
Craft	Bla	Rectified / Rektifiyeli	R11	40x120	Avg. Ev ≤ 0,5 %	> 1300 N	Min. 35 N/mm <sup>2</sup>	Not Applicable	9	NPD	NPD	NPD	NPD	≥ 0.42



## Test results / Test sonuçları

### Marble - X

Sizes / Ebatlar	Units in box / Kutu içi adet	Box m <sup>2</sup> / Kutu içi m <sup>2</sup>	Box kg / Kutu içi kg	Units in pallet / Palet içi adet	Pallet m <sup>2</sup> / Palet m <sup>2</sup>	Pallet kg / Palet kg	Thickness / Kalınlık
60x120 Rectified / Rektifiyeli	2	1,44	29,52	36	51,84	1098	9

Collection / Koleksiyon	Body type / Bünye tipi	Rectified - Non-rectified / Rektifiyeli - Rektifiyesiz	Surface / Yüze	Size / Ebat	Water absorption / Su emme	Breaking strength / Kırılma dayanımı	Bending strength / Eğilme dayanımı	Resistance to deep abrasion / Derin aşınma dayanımı	MOHs	Pendulum dry TRL (55) / Pendulum kuru TRL (55)	Pendulum wet TRL (55) / Pendulum ıslak TRL (55)	Pendulum dry 4S (96) / Pendulum kuru 4S (96)	Pendulum wet 4S (96) / Pendulum ıslak 4S (96)	DCOF
Marble - X	Bla	Rectified / Rektifiyeli	FLPR	60x120	EN ISO 10545-3 Avg. ≤ 0,5 %	EN ISO 10545-4 > 1300 N	EN ISO 10545-4 > 35 N/mm <sup>2</sup>	EN ISO 10545-6 Not Applicable	MOHs 3-4	BS 7976-2 Not Applicable	BS 7976-2 Not Applicable	BS 7976-2 Not Applicable	BS 7976-2 Not Applicable	ANSI A137.1 Section 9.6.1 Not Applicable

### MarmoMix

Sizes / Ebatlar	Units in box / Kutu içi adet	Box m <sup>2</sup> / Kutu içi m <sup>2</sup>	Box kg / Kutu içi kg	Units in pallet / Palet içi adet	Pallet m <sup>2</sup> / Palet m <sup>2</sup>	Pallet kg / Palet kg	Thickness / Kalınlık
60x120 Rectified / Rektifiyeli	2	1,44	29,52	36	51,84	1098	9
60x60 Rectified / Rektifiyeli	4	1,44	26,5	30	43,2	835	9
30x60 Rectified / Rektifiyeli	6	1,08	20,3	40	43,2	820	9
30x30 Cut decor / Kesme dekor	11	1,08	18,03	48	51,84	870	9
15x60 Cut decor / Kesme dekor	11	1	19,24	48	48	950	9
7,5x60 Cut decor / Kesme dekor	6	0,27	5,2	96	25,92	525	9

Collection / Koleksiyon	Body type / Bünye tipi	Rectified - Non-rectified / Rektifiyeli - Rektifiyesiz	Surface / Yüze	Size / Ebat	Water absorption / Su emme	Breaking strength / Kırılma dayanımı	Bending strength / Eğilme dayanımı	Resistance to deep abrasion / Derin aşınma dayanımı	MOHs	Pendulum dry TRL (55) / Pendulum kuru TRL (55)	Pendulum wet TRL (55) / Pendulum ıslak TRL (55)	Pendulum dry 4S (96) / Pendulum kuru 4S (96)	Pendulum wet 4S (96) / Pendulum ıslak 4S (96)	DCOF
MarmoMix	Bla	Rectified / Rektifiyeli	R10A	60x120	EN ISO 10545-3 Avg. ≤ 0,5 %	EN ISO 10545-4 > 1300 N	EN ISO 10545-4 > 35 N/mm <sup>2</sup>	EN ISO 10545-6 Not Applicable	MOHs 8'-9	BS 7976-2 NPD	BS 7976-2 NPD	BS 7976-2 PTV Dry≥36	BS 7976-2 25≤PTV Wet≤36	ANSI A137.1 Section 9.6.1 ≥ 0.42
MarmoMix	Bla	Rectified / Rektifiyeli	FLPR	60x120	EN ISO 10545-3 Avg. ≤ 0,5 %	EN ISO 10545-4 > 1300 N	EN ISO 10545-4 > 35 N/mm <sup>2</sup>	EN ISO 10545-6 Not Applicable	MOHs 3'-4	BS 7976-2 NPD	BS 7976-2 NPD	BS 7976-2 PTV Dry≥36	BS 7976-2 25≤PTV Wet≤36	ANSI A137.1 Section 9.6.1 NPD
MarmoMix	Bla	Rectified / Rektifiyeli	R10A	60x60	EN ISO 10545-3 Avg. ≤ 0,5 %	EN ISO 10545-4 > 1300 N	EN ISO 10545-4 > 35 N/mm <sup>2</sup>	EN ISO 10545-6 Not Applicable	MOHs 8'-9	BS 7976-2 NPD	BS 7976-2 NPD	BS 7976-2 PTV Dry≥36	BS 7976-2 25≤PTV Wet≤36	ANSI A137.1 Section 9.6.1 ≥ 0.42
MarmoMix	Bla	Rectified / Rektifiyeli	R10A	30x60	EN ISO 10545-3 Avg. ≤ 0,5 %	EN ISO 10545-4 > 1300 N	EN ISO 10545-4 > 35 N/mm <sup>2</sup>	EN ISO 10545-6 Not Applicable	MOHs 8'-9	BS 7976-2 NPD	BS 7976-2 NPD	BS 7976-2 PTV Dry≥36	BS 7976-2 25≤PTV Wet≤36	ANSI A137.1 Section 9.6.1 ≥ 0.42
MarmoMix	Bla	Rectified / Rektifiyeli	R10A	30x30	EN ISO 10545-3 Avg. ≤ 0,5 %	EN ISO 10545-4 > 1300 N	EN ISO 10545-4 > 35 N/mm <sup>2</sup>	EN ISO 10545-6 Not Applicable	MOHs 8'-9	BS 7976-2 NPD	BS 7976-2 NPD	BS 7976-2 PTV Dry≥36	BS 7976-2 25≤PTV Wet≤36	ANSI A137.1 Section 9.6.1 ≥ 0.42
MarmoMix	Bla	Rectified / Rektifiyeli	R10A	7,5x60	EN ISO 10545-3 Avg. ≤ 0,5 %	EN ISO 10545-4 > 1300 N	EN ISO 10545-4 > 35 N/mm <sup>2</sup>	EN ISO 10545-6 Not Applicable	MOHs 8'-9	BS 7976-2 NPD	BS 7976-2 NPD	BS 7976-2 PTV Dry≥36	BS 7976-2 25≤PTV Wet≤36	ANSI A137.1 Section 9.6.1 ≥ 0.42
MarmoMix	Bla	Rectified / Rektifiyeli	R10A	15x60	EN ISO 10545-3 Avg. ≤ 0,5 %	EN ISO 10545-4 > 1300 N	EN ISO 10545-4 > 35 N/mm <sup>2</sup>	EN ISO 10545-6 Not Applicable	MOHs 8'-9	BS 7976-2 NPD	BS 7976-2 NPD	BS 7976-2 PTV Dry≥36	BS 7976-2 25≤PTV Wet≤36	ANSI A137.1 Section 9.6.1 ≥ 0.42

### Marmostone

Sizes / Ebatlar	Units in box / Kutu içi adet	Box m <sup>2</sup> / Kutu içi m <sup>2</sup>	Box kg / Kutu içi kg	Units in pallet / Palet içi adet	Pallet m <sup>2</sup> / Palet m <sup>2</sup>	Pallet kg / Palet kg	Thickness / Kalınlık
60x120 Rectified / Rektifiyeli	2	1,44	29,52	36	51,84	1098	9
80x80 Rectified / Rektifiyeli	2	1,28	24,5	44	56,32	1103	9
60x60 Rectified / Rektifiyeli	4	1,44	27	30	43,2	835	9
30x60 Cut decor / Kesme dekor	6	1,08	20,3	40	43,2	820	9
7,5x7,5 Cut decor / Kesme dekor	8	0,72	12,46	78	56,16	971,57	9

Collection / Koleksiyon	Body type / Bünye tipi	Rectified - Non-rectified / Rektifiyeli - Rektifiyesiz	Surface / Yüze	Size / Ebat	Water absorption / Su emme	Breaking strength / Kırılma dayanımı	Bending strength / Eğilme dayanımı	Resistance to deep abrasion / Derin aşınma dayanımı	MOHs	Pendulum dry TRL (55) / Pendulum kuru TRL (55)	Pendulum wet TRL (55) / Pendulum ıslak TRL (55)	Pendulum dry 4S (96) / Pendulum kuru 4S (96)	Pendulum wet 4S (96) / Pendulum ıslak 4S (96)	DCOF
Marmostone	Bla	Rectified / Rektifiyeli	FLPR	60x120	EN ISO 10545-3 Avg. ≤ 0,5 %	EN ISO 10545-4 >1300 N	EN ISO 10545-4 >35 N/mm <sup>2</sup>	EN ISO 10545-6 2	MOHs N/A	BS 7976-2 NPD	BS 7976-2 NPD	BS 7976-2 NPD	BS 7976-2 NPD	ANSI A137.1 Section 9.6.1 NPD
Marmostone	Bla	Rectified / Rektifiyeli	R10B	60x120	EN ISO 10545-3 Avg. ≤ 0,5 %	EN ISO 10545-4 >1300 N	EN ISO 10545-4 >35 N/mm <sup>2</sup>	EN ISO 10545-6 Not Applicable	MOHs 8'-9	BS 7976-2 PTV Dry≥36	BS 7976-2 25≤PTV Wet≤36	BS 7976-2 PTV Dry≥36	BS 7976-2 PTV Wet≥36	ANSI A137.1 Section 9.6.1 ≥ 0.42
Marmostone	Bla	Rectified / Rektifiyeli	R10B	80x80	EN ISO 10545-3 Avg. ≤ 0,5 %	EN ISO 10545-4 >1300 N	EN ISO 10545-4 >35 N/mm <sup>2</sup>	EN ISO 10545-6 Max. 175 mm <sup>3</sup>	MOHs 8'-9	BS 7976-2 PTV Dry≥36	BS 7976-2 25≤PTV Wet≤36	BS 7976-2 PTV Dry≥36	BS 7976-2 PTV Wet≥36	ANSI A137.1 Section 9.6.1 ≥ 0.42
Marmostone	Bla	Rectified / Rektifiyeli	R10B	60x60	EN ISO 10545-3 Avg. ≤ 0,5 %	EN ISO 10545-4 >1300 N	EN ISO 10545-4 >35 N/mm <sup>2</sup>	EN ISO 10545-6 Max. 175 mm <sup>3</sup>	MOHs 8'-9	BS 7976-2 PTV Dry≥36	BS 7976-2 25≤PTV Wet≤36	BS 7976-2 PTV Dry≥36	BS 7976-2 PTV Wet≥36	ANSI A137.1 Section 9.6.1 ≥ 0.42
Marmostone	Bla	Rectified / Rektifiyeli	R10B	30x60	EN ISO 10545-3 Avg. ≤ 0,5 %	EN ISO 10545-4 >1300 N	EN ISO 10545-4 >35 N/mm <sup>2</sup>	EN ISO 10545-6 Not Applicable	MOHs 8'-9	BS 7976-2 PTV Dry≥36	BS 7976-2 25≤PTV Wet≤36	BS 7976-2 PTV Dry≥36	BS 7976-2 PTV Wet≥36	ANSI A137.1 Section 9.6.1 ≥ 0.42
Marmostone	Bla	Rectified / Rektifiyeli	R10B	7,5x7,5	EN ISO 10545-3 Avg. ≤ 0,5 %	EN ISO 10545-4 >1300 N	EN ISO 10545-4 >35 N/mm <sup>2</sup>	EN ISO 10545-6 Not Applicable	MOHs 8'-9	BS 7976-2 PTV Dry≥36	BS 7976-2 25≤PTV Wet≤36	BS 7976-2 PTV Dry≥36	BS 7976-2 PTV Wet≥36	ANSI A137.1 Section 9.6.1 ≥ 0.42

## Test results / Test sonuçları

### Metalcrete

Sizes / Ebatlar	Units in box / Kutu içi adet	Box m <sup>2</sup> / Kutu içi m <sup>2</sup>	Box kg / Kutu içi kg	Units in pallet / Palet içi adet	Pallet m <sup>2</sup> / Palet m <sup>2</sup>	Pallet kg / Palet kg	Thickness / Kalınlık
80x80 Rectified / Rektifiyeli	2	1,28	24,5	44	56,32	1103	9
40x80 Rectified / Rektifiyeli	4	1,28	24,1	27	34,6	675	9
40x80 Rectified / Rektifiyeli	4	1,44	26,5	30	43,2	835	9
30x60 Rectified / Rektifiyeli	6	1,08	20,3	40	43,2	820	9
5x5 Mosaic decor / Mozaik dekor	8	0,72	10,87	78	56,16	873	9

Collection / Koleksiyon	Body type / Bünye tipi	Rectified - Non-rectified / Rektifiyeli - Rektifiyesiz	Surface / Yüzey	Size / Ebat	Water absorption / Su emme EN ISO 10545-3	Breaking strength / Kırılma dayanımı EN ISO 10545-4	Bending strength / Eğilme dayanımı EN ISO 10545-4	Resistance to deep abrasion / Derin aşınma dayanımı EN ISO 10545-6	MOHs MOHs	Pendulum dry TRL (55) / Pendulum kuru TRL (55) BS 7976-2	Pendulum wet TRL (55) / Pendulum ıslak TRL (55) BS 7976-2	Pendulum dry 4S (96) / Pendulum kuru 4S (96) BS 7976-2	Pendulum wet 4S (96) / Pendulum ıslak 4S (96) BS 7976-2	DCOF ANSI A137.1 Section 9.6.1
Metalcrete	Bla	Rectified / Rektifiyeli	R9 LPR	80x80	Avg. Ev ≤ 0,5 %	> 1300 N	Min. 35 N/mm <sup>2</sup>	Max. 175 mm <sup>3</sup>	8	PTV Dry ≥ 36	PTV Wet ≤ 24	PTV Dry ≥ 36	PTV Wet ≤ 24	< 0.42
Metalcrete	Bla	Rectified / Rektifiyeli	R9 LPR	40x80	Avg. Ev ≤ 0,5 %	> 1300 N	Min. 35 N/mm <sup>2</sup>	Max. 175 mm <sup>3</sup>	8	PTV Dry ≥ 36	PTV Wet ≤ 24	PTV Dry ≥ 36	PTV Wet ≤ 24	< 0.42

### Oakland

Sizes / Ebatlar	Units in box / Kutu içi adet	Box m <sup>2</sup> / Kutu içi m <sup>2</sup>	Box kg / Kutu içi kg	Units in pallet / Palet içi adet	Pallet m <sup>2</sup> / Palet m <sup>2</sup>	Pallet kg / Palet kg	Thickness / Kalınlık
20x120 Rectified / Rektifiyeli	4	0,96	21,5	48	46,08	1032	10
20x120 Non-rectified / Rektifiyesiz	4	0,96	21,5	48	46,08	1032	10

Collection / Koleksiyon	Body type / Bünye tipi	Rectified - Non-rectified / Rektifiyeli - Rektifiyesiz	Surface / Yüzey	Size / Ebat	Water absorption / Su emme EN ISO 10545-3	Breaking strength / Kırılma dayanımı EN ISO 10545-4	Bending strength / Eğilme dayanımı EN ISO 10545-4	Resistance to deep abrasion / Derin aşınma dayanımı EN ISO 10545-6	MOHs MOHs	Pendulum dry TRL (55) / Pendulum kuru TRL (55) BS 7976-2	Pendulum wet TRL (55) / Pendulum ıslak TRL (55) BS 7976-2	Pendulum dry 4S (96) / Pendulum kuru 4S (96) BS 7976-2	Pendulum wet 4S (96) / Pendulum ıslak 4S (96) BS 7976-2	DCOF ANSI A137.1 Section 9.6.1
Oakland	Bla	Rectified / Non-rectified	PTV	20x120	Avg. Ev ≤ 0,5 %	> 1300 N	Min. 35 N/mm <sup>2</sup>	Not Applicable	9	PTV Dry ≥ 36	25 ≤ PTV Wet < 36	PTV Dry ≥ 36	PTV Wet ≥ 36	≥ 0.42
Oakland	Bla	Rectified / Non-rectified	R10A	20x120	Avg. Ev ≤ 0,5 %	> 1300 N	Min. 35 N/mm <sup>2</sup>	Not Applicable	9	PTV Dry ≥ 36	PTV Wet ≤ 24	PTV Dry ≥ 36	25 ≤ PTV Wet < 36	≥ 0.42

### Scale

Sizes / Ebatlar	Units in box / Kutu içi adet	Box m <sup>2</sup> / Kutu içi m <sup>2</sup>	Box kg / Kutu içi kg	Units in pallet / Palet içi adet	Pallet m <sup>2</sup> / Palet m <sup>2</sup>	Pallet kg / Palet kg	Thickness / Kalınlık
100x300 (3.5mm)	1	3	25,35	20	60	580	3,5
100x300 (5.5mm)	1	3	34,5	13	39	525	5,5
100x300 (5.5mm)	2	3	23	25	50	625	5,5

Collection / Koleksiyon	Rectified - Non-rectified / Rektifiyeli - Rektifiyesiz	Surface / Yüzey	Size / Ebat	Water absorption / Su emme EN ISO 10545-3	Bending strength / Eğilme dayanımı EN ISO 10545-4	Resistance to deep abrasion / Derin aşınma dayanımı EN ISO 10545-6
Scale	Rectified / Rektifiyeli	Matt / Mat	100x300	Avg. Ev ≤ 0,5 %	Min. 35 N/mm <sup>2</sup>	175 mm <sup>3</sup>



## Test results / Test sonuçları

### Softcrete

Sizes / Ebatlar	Units in box / Kutu içi adet	Box m <sup>2</sup> / Kutu içi m <sup>2</sup>	Box kg / Kutu içi kg	Units in pallet / Palet içi adet	Pallet m <sup>2</sup> / Palet m <sup>2</sup>	Pallet kg / Palet kg	Thickness / Kalınlık
30x60 Rectified / Rektifiyeli	6,00	1,08	20,10	40	43,20	828,95	9,00
60x60 Rectified / Rektifiyeli	4,00	1,44	25,30	30	43,20	760,32	8,50
60x120 Rectified / Rektifiyeli	2,00	1,44	30,2	32	46,1	1005	9

Collection / Koleksiyon	Body type / Bünye tipi	Rectified - Non-rectified / Rektifiyeli - Rektifiyesiz	Surface / Yüzey	Size / Ebat	Water absorption / Su emme EN ISO 10545-3	Breaking strength / Kırılma dayanımı EN ISO 10545-4	Bending strength / Eğilme dayanımı EN ISO 10545-4	Resistance to deep abrasion / Derin aşınma dayanımı EN ISO 10545-6	MOHs MOHs	Pendulum dry TRL (55) / Pendulum kuru TRL (55) BS 7976-2	Pendulum wet TRL (55) / Pendulum ıslak TRL (55) BS 7976-2	Pendulum dry 4S (96) / Pendulum kuru 4S (96) BS 7976-2	Pendulum wet 4S (96) / Pendulum ıslak 4S (96) BS 7976-2	DCOF ANSI A137.1 Section 9.6.1
Softcrete	Bla	Rectified / Rektifiyeli	R9	30x60	Avg. Ev ≤ 0,5 %	> 1300 N	Min. 35 N/mm <sup>2</sup>	Not Applicable	8-9	PTV Dry ≥ 36	Not Applicable	PTV Dry ≥ 36	PTV Wet ≤ 24	< 0.42
Softcrete	Bla	Rectified / Rektifiyeli	R9	60x60	Avg. Ev ≤ 0,5 %	> 1300 N	Min. 35 N/mm <sup>2</sup>	Not Applicable	8-9	PTV Dry ≥ 36	Not Applicable	PTV Dry ≥ 36	PTV Wet ≤ 24	< 0.42
Softcrete	Bla	Rectified / Rektifiyeli	R9	60x120	Avg. Ev ≤ 0,5 %	> 1300 N	Min. 35 N/mm <sup>2</sup>	Not Applicable	8-9	PTV Dry ≥ 36	Not Applicable	PTV Dry ≥ 36	PTV Wet ≤ 24	< 0.42

### Stonelevel

Sizes / Ebatlar	Units in box / Kutu içi adet	Box m <sup>2</sup> / Kutu içi m <sup>2</sup>	Box kg / Kutu içi kg	Units in pallet / Palet içi adet	Pallet m <sup>2</sup> / Palet m <sup>2</sup>	Pallet kg / Palet kg	Thickness / Kalınlık
80x80 Rectified / Rektifiyeli	2	1,28	24,5	44	56,32	1103	9
40x80 Rectified / Rektifiyeli	4	1,28	24,1	27	34,6	675	9
60x60 Rectified / Rektifiyeli	4	1,44	26,5	30	43,2	835	9
30x60 Rectified / Rektifiyeli	6	1,08	20,3	40	43,2	820	9
5x15 Mosaic decor / Mozaik dekor	20	0,72	13,4	42	30,24	588	9
5x5 Mosaic decor / Mozaik dekor	8	0,72	10,87	78	56,16	873	9
10x80 Plinth / Süpürgelik	9	0,72	13,5	40	28,8	550	9
8.5x60 Plinth / Süpürgelik	6	0,93	16,74	48	44,16	739,24	9

Collection / Koleksiyon	Body type / Bünye tipi	Rectified - Non-rectified / Rektifiyeli - Rektifiyesiz	Surface / Yüzey	Size / Ebat	Water absorption / Su emme EN ISO 10545-3	Breaking strength / Kırılma dayanımı EN ISO 10545-4	Bending strength / Eğilme dayanımı EN ISO 10545-4	Resistance to deep abrasion / Derin aşınma dayanımı EN ISO 10545-6	MOHs MOHs	Pendulum dry TRL (55) / Pendulum kuru TRL (55) BS 7976-2	Pendulum wet TRL (55) / Pendulum ıslak TRL (55) BS 7976-2	Pendulum dry 4S (96) / Pendulum kuru 4S (96) BS 7976-2	Pendulum wet 4S (96) / Pendulum ıslak 4S (96) BS 7976-2	DCOF ANSI A137.1 Section 9.6.1
Stonelevel	Bla	Rectified / Rektifiyeli	R10A	80x80	Avg. Ev ≤ 0,5 %	> 1300 N	Min. 35 N/mm <sup>2</sup>	Max. 175 mm <sup>3</sup>	9	PTV Dry ≥ 36	PTV Wet ≤ 24	PTV Dry ≥ 36	25 ≤ PTV Wet < 36	≥ 0.42
Stonelevel	Bla	Rectified / Rektifiyeli	R9 LPR	80x80	Avg. Ev ≤ 0,5 %	> 1300 N	Min. 35 N/mm <sup>2</sup>	Max. 175 mm <sup>3</sup>	9	PTV Dry ≥ 36	PTV Wet ≤ 24	PTV Dry ≥ 36	PTV Wet ≤ 24	< 0.42
Stonelevel	Bla	Rectified / Rektifiyeli	R10A	40x80	Avg. Ev ≤ 0,5 %	> 1300 N	Min. 35 N/mm <sup>2</sup>	Max. 175 mm <sup>3</sup>	9	PTV Dry ≥ 36	PTV Wet ≤ 24	PTV Dry ≥ 36	25 ≤ PTV Wet < 36	≥ 0.42
Stonelevel	Bla	Rectified / Rektifiyeli	R9 LPR	40x80	Avg. Ev ≤ 0,5 %	> 1300 N	Min. 35 N/mm <sup>2</sup>	Max. 175 mm <sup>3</sup>	9	PTV Dry ≥ 36	PTV Wet ≤ 24	PTV Dry ≥ 36	PTV Wet ≤ 24	< 0.42
Stonelevel	Bla	Rectified / Rektifiyeli	R10A	60x60	Avg. Ev ≤ 0,5 %	> 1300 N	Min. 35 N/mm <sup>2</sup>	Max. 175 mm <sup>3</sup>	9	PTV Dry ≥ 36	PTV Wet ≤ 24	PTV Dry ≥ 36	25 ≤ PTV Wet < 36	≥ 0.42
Stonelevel	Bla	Rectified / Rektifiyeli	R9 LPR	60x60	Avg. Ev ≤ 0,5 %	> 1300 N	Min. 35 N/mm <sup>2</sup>	Max. 175 mm <sup>3</sup>	9	PTV Dry ≥ 36	PTV Wet ≤ 24	PTV Dry ≥ 36	PTV Wet ≤ 24	< 0.42
Stonelevel	Bla	Rectified / Rektifiyeli	R10A	30x60	Avg. Ev ≤ 0,5 %	> 1300 N	Min. 35 N/mm <sup>2</sup>	Max. 175 mm <sup>3</sup>	9	PTV Dry ≥ 36	PTV Wet ≤ 24	PTV Dry ≥ 36	25 ≤ PTV Wet < 36	≥ 0.42

## Test results / Test sonuçları

### Urban Travertino

Sizes / Ebatlar	Units in box / Kutu içi adet	Box m <sup>2</sup> / Kutu içi m <sup>2</sup>	Box kg / Kutu içi kg	Units in pallet / Palet içi adet	Pallet m <sup>2</sup> / Palet m <sup>2</sup>	Pallet kg / Palet kg	Thickness / Kalınlık
60x120 Rectified / Rektifiyeli	2	1,44	29,52	36	51,84	1098	9
80x80 Rectified / Rektifiyeli	2	1,28	24,5	44	56,32	1103	9
60x60 Rectified / Rektifiyeli	4	1,44	26,5	30	43,2	835	9

Collection / Koleksiyon	Body type / Bünye tipi	Rectified - Non-rectified / Rektifiyeli - Rektifiyesiz	Surface / Yüzey	Size / Ebat	Water absorption / Su emme EN ISO 10545-3	Breaking strength / Kırılma dayanımı EN ISO 10545-4	Bending strength / Eğilme dayanımı EN ISO 10545-4	Resistance to deep abrasion / Derin aşınma dayanımı EN ISO 10545-6	MOHs	Pendulum dry TRL (55) / Pendulum kuru TRL (55) BS 7976-2	Pendulum wet TRL (55) / Pendulum ıslak TRL (55) BS 7976-2	Pendulum dry 4S (96) / Pendulum kuru 4S (96) BS 7976-2	Pendulum wet 4S (96) / Pendulum ıslak 4S (96) BS 7976-2	DCOF ANSI A137.1 Section 9.6.1
Urban Travertino	Bla	Rectified / Rektifiyeli	R10A	60x120	Avg. Ev ≤ 0,5 %	>1300 N	>35 N/mm <sup>2</sup>	Max. 175 mm <sup>3</sup>	8'-9	NPD	NPD	PTV Dry ≥ 36	25 ≤ PTV Wet < 36	≥ 0.42
Urban Travertino	Bla	Rectified / Rektifiyeli	R10A	80x80	Avg. Ev ≤ 0,5 %	>1300 N	>35 N/mm <sup>2</sup>	Max. 175 mm <sup>3</sup>	8'-9	NPD	NPD	PTV Dry ≥ 36	25 ≤ PTV Wet < 36	≥ 0.42
Urban Travertino	Bla	Rectified / Rektifiyeli	R10A	60x60	Avg. Ev ≤ 0,5 %	>1300 N	>35 N/mm <sup>2</sup>	Max. 175 mm <sup>3</sup>	8'-9	NPD	NPD	PTV Dry ≥ 36	25 ≤ PTV Wet < 36	≥ 0.42

### Urbancrete

Sizes / Ebatlar	Units in box / Kutu içi adet	Box m <sup>2</sup> / Kutu içi m <sup>2</sup>	Box kg / Kutu içi kg	Units in pallet / Palet içi adet	Pallet m <sup>2</sup> / Palet m <sup>2</sup>	Pallet kg / Palet kg	Thickness / Kalınlık
60x120 Rectified / Rektifiyeli	2	1,44	29,52	36	51,84	1098	9
80x80 Rectified / Rektifiyeli	2	1,28	24,5	44	56,32	1103	9
60x60 Rectified / Rektifiyeli	4	1,44	26,5	30	43,2	835	9
40x80 Rectified / Rektifiyeli	4	1,28	24,1	27	34,6	675	9
30x60 Rectified / Rektifiyeli	6	1,08	20,3	40	43,2	820	9
30x60 Rectified / Rektifiyeli	6	1,08	16,2	48	51,84	805	9
5x5 Mosaic decor / Mozaik dekor	8	0,72	10,87	78	56,16	873	9
10x80 Plinth / Süpürgelik	9	0,72	13,5	40	28,8	550	9
8.5x60 Plinth / Süpürgelik	18	0,92	16,74	48	44,16	739,24	9

Collection / Koleksiyon	Body type / Bünye tipi	Rectified - Non-rectified / Rektifiyeli - Rektifiyesiz	Surface / Yüzey	Size / Ebat	Water absorption / Su emme EN ISO 10545-3	Breaking strength / Kırılma dayanımı EN ISO 10545-4	Bending strength / Eğilme dayanımı EN ISO 10545-4	Resistance to deep abrasion / Derin aşınma dayanımı EN ISO 10545-6	MOHs	Pendulum dry TRL (55) / Pendulum kuru TRL (55) BS 7976-2	Pendulum wet TRL (55) / Pendulum ıslak TRL (55) BS 7976-2	Pendulum dry 4S (96) / Pendulum kuru 4S (96) BS 7976-2	Pendulum wet 4S (96) / Pendulum ıslak 4S (96) BS 7976-2	DCOF ANSI A137.1 Section 9.6.1
Urbancrete	Bla	Rectified / Rektifiyeli	R10A	80x80	Avg. Ev ≤ 0,5 %	> 1300 N	Min. 35 N/mm <sup>2</sup>	Max. 175 mm <sup>3</sup>	9	PTV Dry ≥ 36	PTV Wet ≤ 24	PTV Dry ≥ 36	25 ≤ PTV Wet < 36	≥ 0.42
Urbancrete	Bla	Rectified / Rektifiyeli	R9 LPR	80x80	Avg. Ev ≤ 0,5 %	> 1300 N	Min. 35 N/mm <sup>2</sup>	Max. 175 mm <sup>3</sup>	8	PTV Dry ≥ 36	PTV Wet ≤ 24	PTV Dry ≥ 36	PTV Wet ≤ 24	< 0.42
Urbancrete	Bla	Rectified / Rektifiyeli	R10A	40x80	Avg. Ev ≤ 0,5 %	> 1300 N	Min. 35 N/mm <sup>2</sup>	Max. 175 mm <sup>3</sup>	9	PTV Dry ≥ 36	PTV Wet ≤ 24	PTV Dry ≥ 36	25 ≤ PTV Wet < 36	≥ 0.42
Urbancrete	Bla	Rectified / Rektifiyeli	R9 LPR	40x80	Avg. Ev ≤ 0,5 %	> 1300 N	Min. 35 N/mm <sup>2</sup>	Max. 175 mm <sup>3</sup>	8	PTV Dry ≥ 36	PTV Wet ≤ 24	PTV Dry ≥ 36	PTV Wet ≤ 24	< 0.42
Urbancrete	Bla	Rectified / Rektifiyeli	R10A	60x60	Avg. Ev ≤ 0,5 %	> 1300 N	Min. 35 N/mm <sup>2</sup>	Max. 175 mm <sup>3</sup>	9	PTV Dry ≥ 36	PTV Wet ≤ 24	PTV Dry ≥ 36	25 ≤ PTV Wet < 36	≥ 0.42
Urbancrete	Bla	Rectified / Rektifiyeli	R9 LPR	60x60	Avg. Ev ≤ 0,5 %	> 1300 N	Min. 35 N/mm <sup>2</sup>	Max. 175 mm <sup>3</sup>	8	PTV Dry ≥ 36	PTV Wet ≤ 24	PTV Dry ≥ 36	PTV Wet ≤ 24	< 0.42
Urbancrete	Bla	Rectified / Rektifiyeli	R10A	30x60	Avg. Ev ≤ 0,5 %	> 1300 N	Min. 35 N/mm <sup>2</sup>	Max. 175 mm <sup>3</sup>	9	PTV Dry ≥ 36	PTV Wet ≤ 24	PTV Dry ≥ 36	25 ≤ PTV Wet < 36	≥ 0.42
Urbancrete	Bla	Rectified / Rektifiyeli	R9 LPR	30x60	Avg. Ev ≤ 0,5 %	> 1300 N	Min. 35 N/mm <sup>2</sup>	Max. 175 mm <sup>3</sup>	8	PTV Dry ≥ 36	PTV Wet ≤ 24	PTV Dry ≥ 36	PTV Wet ≤ 24	< 0.42
Urbancrete	Bla	Non-rectified / Rektifiyesiz	Matt / Mat	21x24	Avg. Ev ≤ 0,5 %	> 1300 N	Min. 35 N/mm <sup>2</sup>	Not Applicable	9	PTV Dry ≥ 36	PTV Wet ≤ 24	PTV Dry ≥ 36	25 ≤ PTV Wet < 36	< 0.42

### Urbanwood

Sizes / Ebatlar	Units in box / Kutu içi adet	Box m <sup>2</sup> / Kutu içi m <sup>2</sup>	Box kg / Kutu içi kg	Units in pallet / Palet içi adet	Pallet m <sup>2</sup> / Palet m <sup>2</sup>	Pallet kg / Palet kg	Thickness / Kalınlık
20x120 Rectified / Rektifiyeli	4	0,96	21,5	48	46,08	1032	10
20x120 Non-rectified / Rektifiyesiz	4	0,96	21,5	48	46,08	1032	10
3.7x20	4	0,405	19,5	48	19,44	380	10

Collection / Koleksiyon	Body type / Bünye tipi	Rectified - Non-rectified / Rektifiyeli - Rektifiyesiz	Surface / Yüzey	Size / Ebat	Water absorption / Su emme EN ISO 10545-3	Breaking strength / Kırılma dayanımı EN ISO 10545-4	Bending strength / Eğilme dayanımı EN ISO 10545-4	Resistance to deep abrasion / Derin aşınma dayanımı EN ISO 10545-6	MOHs	Pendulum dry TRL (55) / Pendulum kuru TRL (55) BS 7976-2	Pendulum wet TRL (55) / Pendulum ıslak TRL (55) BS 7976-2	Pendulum dry 4S (96) / Pendulum kuru 4S (96) BS 7976-2	Pendulum wet 4S (96) / Pendulum ıslak 4S (96) BS 7976-2	DCOF ANSI A137.1 Section 9.6.1
Urbanwood	Bla	Rectified / Rektifiyeli	R10A	20x120	Avg. Ev ≤ 0,5 %	> 1300 N	Min. 35 N/mm <sup>2</sup>	Not Applicable	9	PTV Dry ≥ 36	25 < PTV Wet < 36	PTV Dry ≥ 36	PTV Wet ≥ 36	≥ 0.42
Urbanwood	Bla	Non-rectified / Rektifiyesiz	R10A	20x120	Avg. Ev ≤ 0,5 %	> 1300 N	Min. 35 N/mm <sup>2</sup>	Not Applicable	9	PTV Dry ≥ 36	25 < PTV Wet < 36	PTV Dry ≥ 36	PTV Wet ≥ 36	≥ 0.42



## Technical characteristics / Teknik özellikler

Technical characteristics Teknik özellikler Technische eigenschaften Caractéristiques techniques	Test standard Test metodu Prüfung nach Méthode du test	Porcelain body Unglazed / Sırsız / Unglasierte / Non émaillés	Porcelain body Glazed / Sırlı / Glasierte / Émaillés	Floor tile body Glazed / Sırlı / Glasierte / Émaillés	Floor tile body Glazed / Sırlı / Glasierte / Émaillés	Wall tile body Glazed / Sırlı / Glasierte / Émaillés					
		EN 14411 Group B1a Annex G	EN 14411 Group B1a Annex G	EN 14411 Group B1b Annex H	EN 14411 Group B1a Annex J	EN 14411 Group B11 Annex L					
		Nominal size ≥ 15cm	Nominal size ≥ 15cm	Nominal size ≥ 15cm	Nominal size ≥ 15cm	Nominal size ≥ 15cm					
<b>Dimension and surface quality / / Ebat ve yüzey kalitesi</b>											
Length and width / Uzunluk ve genişlik / Länge und breite / Longueur et largeur	EN ISO 10545-2	± 0,6%	± 2mm	± 0,6%	± 2mm	± 0,6%	± 2mm	± 0,6%	± 2mm	± 0,5 %	± 2mm
Thickness / Kalınlık / Dicke / Epaisseur	EN ISO 10545-2	± 5%	± 0,5mm	± 5%	± 0,5mm	± 5%	± 0,5mm	± 5%	± 0,5mm	+ 10%	± 0,5mm
Thickness / Kalınlık / Dicke / Epaisseur	EN ISO 10545-2	± 0,5%	± 1,5mm	± 0,5%	± 1,5mm	± 0,5%	± 1,5mm	± 0,5%	± 1,5mm	+ 0,3%	± 1,5mm
Thickness / Kalınlık / Dicke / Epaisseur	EN ISO 10545-2	± 0,5%	± 2mm	± 0,5%	± 2mm	± 0,5%	± 2mm	± 0,5%	± 2mm	± 0,5%	± 2mm
Thickness / Kalınlık / Dicke / Epaisseur	EN ISO 10545-2	± 0,5%	± 2mm	± 0,5%	± 2mm	± 0,5%	± 2mm	± 0,5%	± 2mm	± 0,5% - 0,3 %	± 2mm - 1,5mm
Surface quality / Yüzey kalitesi / Oberflächenbeschaffenheit / Qualité de surface	EN ISO 10545-2	Min. 95%		Min. 95%		Min. 95%		Min. 95%		Min. 95%	
<b>Physical properties / Fiziksel özellikler</b>											
Water absorption / Su emme / Wasseraufnahme / Absorption d'eau	EN ISO 10545-3	± 0,5%		± 0,5%		0,5% < E ≤ 3,0%		3,0% < E ≤ 6,0%		E > 10%	
Modulus of rupture / Eğilme dayanımı / Biegefestigkeit / Résistance à la flexion	EN ISO 10545-4	Min. 35 N/mm <sup>2</sup>		Min. 35 N/mm <sup>2</sup>		Min. 30 N/mm <sup>2</sup>		Min. 22 N/mm <sup>2</sup>		Min. 15 N/mm <sup>2</sup>	
Breaking strength / Kırılma dayanımı / Bruchlast / Force de rupture	EN ISO 10545-4	Min.1300 N (t≥7,5mm) Min. 700 N (t<7,5mm)		Min.1300 N (t≥7,5mm) Min. 700 N (t<7,5mm)		Min. 1100 N (t≥7,5mm) Min. 700 N (t<7,5mm)		Min. 1000 N (t≥7,5mm) Min. 600 N (t<7,5mm)		Min.600N (t≥7,5mm) Min.200 N (t<7,5mm)	
Surface abrasion / Yüzey aşınma / Widerstand gegen oberflächenverschleiß / Résistance à l'abrasion pel	EN ISO 10545-7	Not Applicable		As specified in the catalogue / Katalogdaki gibi		As specified in the catalogue / Katalogdaki gibi		As specified in the catalogue / Katalogdaki gibi		Not intended to be used on the floor / Zeminde kullanılmamalıdır	
Deep abrasion / Derin aşınma / Widerstand gegen tiefenverschleiß / Résistance à l'abrasion profonde	EN ISO 10545-6	Max. 175 mm <sup>3</sup>		Not Applicable		Not Applicable		Not Applicable		Not Applicable	
Linear thermal expansion / Lineer ısı genleşme / Linearer wärmeausdehnungs koeffizient / Coeff. de dilatation therm. maxi	EN ISO 10545-8	Max 9 x 10 <sup>-6</sup> K <sup>-1</sup>		Max 9 x 10 <sup>-6</sup> K <sup>-1</sup>		Max 9 x 10 <sup>-6</sup> K <sup>-1</sup>		Max 9 x 10 <sup>-6</sup> K <sup>-1</sup>		Max 9 x 10 <sup>-6</sup> K <sup>-1</sup>	
Thermal shock resistance / Isı şokuna dayanım / Temperaturwechselbeständigkeit / résistance aux écarts de température	EN ISO 10545-9	Pass / Başarılı Erreicht / Conforme		Pass / Başarılı Erreicht / Conforme		Pass / Başarılı Erreicht / Conforme		Pass / Başarılı Erreicht / Conforme		Pass / Başarılı Erreicht / Conforme	
Frost resistance / Don dayanımı / Frostbeständigkeit / Résistance au gel	EN ISO 10545-12	Pass / Başarılı Erreicht / Conforme		Pass / Başarılı Erreicht / Conforme		Pass / Başarılı Erreicht / Conforme		NPD		----	
Coefficient of friction / Sürtünme katsayısı / Reibungskoeffizient / Résistance à la glissance	Declared test method Beyan edilen metod Angabe prüfverfahren	As specified in the catalogue / Katalogdaki gibi		As specified in the catalogue / Katalogdaki gibi		As specified in the catalogue / Katalogdaki gibi		As specified in the catalogue / Katalogdaki gibi		Not intended to be used on the floor / Zeminde kullanılmamalıdır	
Crazing resistance / Sırlı karolarda çatlamaya dayanım / Widerstand gegen glassurrisse Résistance au tressailage	EN ISO 10545-11	-----		Pass / Başarılı Erreicht / Conforme		Pass / Başarılı Erreicht / Conforme		Pass / Başarılı Erreicht / Conforme		Pass / Başarılı Erreicht / Conforme	
Reaction to fire / Ateşe dayanıklılık / Reaktion gegenüber feuer / Réaction au feu	-----	Class A1 or A1 <sub>FL</sub>		Class A1 or A1 <sub>FL</sub>		Class A1 or A1 <sub>FL</sub>		Class A1 or A1 <sub>FL</sub>		Class A1 or A1 <sub>FL</sub>	
Small colour differences for plain coloured tiles / Tek renkli karolarda küçük renk farkları / Farbabweichungen zwischen einfarbig glasierten keramischen fliesen und platten / De faibles différences de couleur entre carreaux céramiques de couleur unie	EN ISO 10545-16	ΔE < 1,0		ΔE < 0,75		ΔE < 0,75		ΔE < 0,75		ΔE < 0,75	
<b>Chemical resistance / Kimyasal dayanım</b>											
Staining resistance / Lekelenmeye dayanım / Fleckbeständigkeit / Résistance aux taches	EN ISO 10545-14	Test method Avaliable Test metodu bulunur Prüfverfahren Vorhanden Méthode d'essai Applicable		Min. Class / Sınıf 3 Klasse / Classe 3		Min. Class / Sınıf 3 Klasse / Classe 3		Min. Class / Sınıf 3 Klasse / Classe 3		Min. Class / Sınıf 3 Klasse / Classe 3	
Resistance to household chemicals and swimming pool water cleaners / Ev kimyasalları ve yüzme havuzu temizleyicilerine dayanım / Beständigkeit gegen haushaltschemikalien und badewassersätze / Résistance aux Produits ménagers	EN ISO 10545-13	Class / Sınıf Klasse / Classe Min. B		Class / Sınıf Klasse / Classe Min. B		Class / Sınıf Klasse / Classe Min. B		Class / Sınıf Klasse / Classe Min. B		Class / Sınıf Klasse / Classe Min. B	
Resistance to low concentrations acids&alkalis / Düşük konsantrasyonlu asit ve alkali dayanımı / Beständigkeit gegen säuren und laugen mit niedriger konzentration / Résistance aux produits bas concentration acides et bases	EN ISO 10545-13	Class / Sınıf Klasse / Classe LA-LC		Class / Sınıf Klasse / Classe LA-LC		Class / Sınıf Klasse / Classe LA-LC		Class / Sınıf Klasse / Classe LA-LC		Class / Sınıf Klasse / Classe LA-LC	
Resistance to high concentrations acids&alkalis / Yüksek konsantrasyonlu asit ve alkali dayanımı / Beständigkeit gegen säuren und laugen mit hoher konzentration / Résistance Aux produits haut concentration ucides et bases	EN ISO 10545-13	Class / Sınıf Klasse / Classe HA-HC		Class / Sınıf Klasse / Classe HA-HC		Class / Sınıf Klasse / Classe HA-HC		Class / Sınıf Klasse / Classe HA-HC		Class / Sınıf Klasse / Classe HA-HC	

Vitra tiles conforms to EN 14411 Standard requirements which are specified in the related product groups with better values. All references to as well as quotations from product and test standards are to be considered as information which is not binding. The latest versions apply. / Garanti koşulları, temizlik ve bakım talimatları, teknik özellikler ile ilgili son bilgileri PRO Nature kataloğundan bulabilirsiniz. / Vitra-Fliesen entsprechen den EN 14411 Standardanforderungen, die in den zugehörigen Produktgruppen mit besseren Werten angegeben sind. / Alle Verweise sowie Zitate aus Produkt- und Prüfnormen sind als unverbindliche Informationen zu betrachten. Die neuesten Versionen gelten. 14.08.2018 Rev: 01

## Declaration of performance - Dry-pressed ceramic tiles Ala / Performans deklarasyonu - Kuru preslenmiş seramik karolar Ala



Vitra Karo Sanayi ve Ticaret A.Ş. Şifa Mah. Hükümet Cad. Tuzla 34941 İSTANBUL -TURKEY

Info: www.vitra.com.tr

05

DoP No: D100-01

### EN 14411:2016

#### Product / Ürün / Produkt / Produits

Extruded ceramic tiles, with Water absorption Eb ≤ 0,5% - Group Ala  
Düşük Su emmeli çekme seramik karolar, Su emme oranı Eb ≤ %0,5 - Grup Ala  
Keramische Fliesen, Stranggepresste mit geringer Wasseraufnahme Eb ≤ 0,5% - Gruppe Ala  
Carreaux céramiques étirés présentant une faible absorption d'eau Eb ≤ 0,5% - Groupe Ala

#### Intended use / Kullanım alanı / Vorgesehene Verwendungszwecke / Usages prévus

For internal and external walls and flooring / İç ve dış mekân zemin ve duvar kaplama  
Wand und Boden; innen und außen / Pour murs et sols, d'intérieur et d'extérieur



Reaction to fire / Yangına tepki / Brandverhalten / Réaction au feu	Class / Sınıf / Klasse / Classe A1/A1 <sub>FL</sub>	EN 14411:2016
<b>Release of dangerous substance, for / Açığa çıkan tehlikeli maddeler / Abgabe gefährlicher Stoffe / Libération de substances dangereuses</b>		
- Cadmium / Kadmium / Cadmium / Cadmium	NPD	EN 14411:2016
- Lead / Kurşun / Blei / Plomb	NPD	EN 14411:2016
Breaking strength / Kırılma dayanımı / Bruchlast / Résistance à la rupture (t= thickness, kalınlık, dicke, épaisseur)	> 1300 N (t ≥ 7,5mm) > 600 N (t < 7,5mm)	EN 14411:2016
Slipperiness <sup>(1)</sup> / Kaymaya direnç <sup>(1)</sup> / Rutschhemmende Eigenschaften <sup>(1)</sup> / Glissance <sup>(1)</sup>	See technical documents and catalog Teknik doküman ve kataloğlara bakınız Siehe bitte technische Dokuments und Katalog Voir les documents techniques et catalogues	EN 14411:2016
Tactility / Hissedilebilir yüzey / Taktilität / Propriétés tactiles	NPD	

#### Durability for / Dayanıklılık / Dauerhaftigkeit bei / Durabilité pour

- Internal use / İç mekan kullanım / Anwendungen in Innenbereichen / Une utilisation en intérieur	Pass / Geçer / Bestanden / Validé	EN 14411:2016
- External use: Freeze - thaw resistance / Dış mekan kullanım - Dona dayanım / Anwendungen Beständigkeit / Une utilisation en extérieur - Résistance aux gelées	Pass / Geçer / Bestanden / Validé	EN 14411:2016

(1) Only if required by corresponding national statutory regulations / Sadece ilgili ülke mevzuatında gerekiyorsa / Nur wenn erforderlich durch entsprechende nationale gesetzliche Regelungen / Seulement s'il y a lieu par des règlements statutaires nationaux correspondants

06032018 Rev01

# Declaration of performance - Dry-pressed ceramic tiles Bla / Performans deklarasyonu - Kuru preslenmiş seramik karolar Bla



Vitra Karo Sanayi ve Ticaret A.Ş. Şifa Mah. Hükümet Cad. Tuzla 34941 İSTANBUL -TURKEY  
Info: www.vitra.com.tr  
05  
DoP No: D200-01

## EN 14411:2016

### Product / Ürün / Produkt / Produits

Dry-pressed ceramic tiles, with water absorption  $E_b \leq 0,5\%$  - Group Bla  
Düşük su emmeli kuru preslenmiş seramik karolar, su emme oranı  $E_b \leq 0,5\%$  - Grup Bla  
Keramische Fliesen, trockenengepresst mit geringer Wasseraufnahme  $E_b \leq 0,5\%$  - Gruppe Bla  
Carreaux céramiques pressés à sec présentant une faible absorption d'eau  $E_b \leq 0,5\%$  - Groupe Bla

### Intended use / Kullanım alanı / Vorgesehene Verwendungszwecke / Usages prévus

For internal and external walls and flooring / İç ve dış mekân zemin ve duvar kaplama  
Wand und Boden; innen und außen / Pour murs et sols, d'intérieur et d'extérieur



Reaction to fire / Yangına tepki / Brandverhalten / Réaction au feu	Class / Sınıf / Klasse / Classe A1 / A1 <sub>FL</sub>	EN 14411:2016
---	--	---------------

### Release of dangerous substance for / Açığa çıkan tehlikeli maddeler / Abgabe gefährlicher Stoffe / Libération de substances dangereuses

- Cadmium / Kadmiyum / Cadmium / Cadmium	NPD	EN 14411:2016
- Lead / Kurşun / Blei / Plomb	NPD	EN 14411:2016
Breaking strength / Kırılma dayanımı / Bruchlast / Résistance à la rupture (t= thickness, kalınlık, dicke, épaisseur)	> 1300 N (t ≥ 7,5mm) > 700 N (t < 7,5mm)	EN 14411:2016
Slipperiness <sup>(1)</sup> / Kaymaya direnç <sup>(1)</sup> / Rutschhemmende Eigenschaften <sup>(1)</sup> / Glissance <sup>(1)</sup>	See technical documents and catalog Teknik doküman ve kataloglara bakınız Siehe bitte technische Dokumente und Katalog Voir les documents techniques et catalogues  Test method / Test metod / Méthode d'essai / Test methode CEN/ TS 16165	EN 14411:2016
Tactility / Hissedilebilir yüzey / Taktilität / Propriétés tactiles	NPD	

### Bond strength-adhesion for / Bağ dayanımı - yapışma / Verbundfestigkeit-Haftfestigkeit / Adhésion

- For cementitious adhesives typ C2 / Çimento esaslı yapıştırıcı tip C2 / Für zementhaltige Mörtel typ C2 / Ciment colle type C2	≥ 0,5 N/mm <sup>2</sup>	EN 14411:2016
- Dispersion adhesive / Dispersiyon esaslı yapıştırıcı / Dispersionsklebstoffe / Dispersion de l'adhésif	NPD	EN 14411:2016
- Reaction resin adhesive / Reaksiyon reçine esaslı yapıştırıcı / Reaktionsharzklebstoffe / Réactif à la résine	NPD	EN 14411:2016
- Thermal shock resistance / Isı şokuna dayanım / Temperaturwechsel beständigkeit / Résistance au choc thermique	Pass / Geçer / Bestanden / Validé	EN 14411:2016

### Durability for / Dayanıklılık / Dauerhaftigkeit bei / Durabilité pour

- Internal use / İç mekan kullanım / Anwendungen in Innenbereichen / Une utilisation en intérieur	Pass / Geçer / Bestanden / Validé	EN 14411:2016
- External use: Freeze - thaw resistance / Dış mekan kullanım - Dona dayanım / Anwendungen Beständigkeit / Une utilisation en extérieur - Résistance aux gelées	Pass / Geçer / Bestanden / Validé	EN 14411:2016

(1) Only if required by corresponding national statutory regulations / Sadece ilgili ülke mevzuatında gereklirse / Nur wenn erforderlich durch entsprechende nationale gesetzliche Regelungen / Seulement s'il y a lieu par des règlements statutaires nationaux correspondants

06032018 Rev01

# Declaration of performance - Dry-pressed ceramic tiles Blb / Performans deklarasyonu - Kuru preslenmiş seramik karolar Blb



Vitra Karo Sanayi ve Ticaret A.Ş. Şifa Mah. Hükümet Cad. Tuzla 34941 İSTANBUL -TURKEY  
Info: www.vitra.com.tr  
05  
DoP No: D300-01

## EN 14411:2016

### Product / Ürün / Produkt / Produits

Dry-pressed ceramic tiles, with water absorption  $0,5\% < E_b \leq 3\%$  - Group Blb  
Düşük su emmeli kuru preslenmiş seramik karolar su emme oranı  $0,5\% < E_b \leq 3\%$  - Grup Blb  
Keramische Fliesen, trockenengepresst mit geringer Wasseraufnahme  $0,5\% < E_b \leq 3\%$  - Gruppe Blb  
Carreaux céramiques pressés à sec présentant une faible absorption d'eau  $0,5\% < E_b \leq 3\%$  - Groupe Blb

### Intended use / Kullanım alanı / Vorgesehene Verwendungszwecke / Usages prévus

For internal and external walls and flooring / İç ve dış mekân zemin ve duvar kaplama  
Wand und Boden; innen und außen / Pour murs et sols, d'intérieur et d'extérieur



Reaction to fire / Yangına tepki / Brandverhalten / Réaction au feu	Class / Sınıf / Klasse / Classe A1 / A1 <sub>FL</sub>	EN 14411:2016
---	--	---------------

### Release of dangerous substance for / Açığa çıkan tehlikeli maddeler / Abgabe gefährlicher Stoffe / Libération de substances dangereuses

- Cadmium / Kadmiyum / Cadmium / Cadmium	NPD	EN 14411:2016
- Lead / Kurşun / Blei / Plomb	NPD	EN 14411:2016
Breaking strength / Kırılma dayanımı / Bruchlast / Résistance à la rupture (t= thickness, kalınlık, dicke, épaisseur)	> 1100 N (t ≥ 7,5mm) > 700 N (t < 7,5mm)	EN 14411:2016
Slipperiness <sup>(1)</sup> / Kaymaya direnç <sup>(1)</sup> / Rutschhemmende Eigenschaften <sup>(1)</sup> / Glissance <sup>(1)</sup>	See technical documents and catalog Teknik doküman ve kataloglara bakınız Siehe bitte technische Dokumente und Katalog Voir les documents techniques et catalogues  Test method / Test metod / Méthode d'essai / Test methode CEN/ TS 16165	EN 14411:2016
Tactility / Hissedilebilir yüzey / Taktilität / Propriétés tactiles	NPD	

### Bond strength-adhesion for / Bağ dayanımı - yapışma / Verbundfestigkeit-Haftfestigkeit / Adhésion

- For cementitious adhesives typ C2 / Çimento esaslı yapıştırıcı tip C2 / Für zementhaltige Mörtel typ C2 / Ciment colle type C2	≥ 0,5 N/mm <sup>2</sup>	EN 14411:2016
- Dispersion adhesive / Dispersiyon esaslı yapıştırıcı / Dispersionsklebstoffe / Dispersion de l'adhésif	NPD	EN 14411:2016
- Reaction resin adhesive / Reaksiyon reçine esaslı yapıştırıcı / Reaktionsharzklebstoffe / Réactif à la résine	NPD	EN 14411:2016
- Thermal shock resistance / Isı şokuna dayanım / Temperaturwechsel beständigkeit / Résistance au choc thermique	Pass / Geçer / Bestanden / Validé	EN 14411:2016

### Durability for / Dayanıklılık / Dauerhaftigkeit bei / Durabilité pour

- Internal use / İç mekan kullanım / Anwendungen in Innenbereichen / Une utilisation en intérieur	Pass / Geçer / Bestanden / Validé	EN 14411:2016
- External use: Freeze - thaw resistance / Dış mekan kullanım - Dona dayanım / Anwendungen Beständigkeit / Une utilisation en extérieur - Résistance aux gelées	Pass / Geçer / Bestanden / Validé	EN 14411:2016

(1) Only if required by corresponding national statutory regulations / Sadece ilgili ülke mevzuatında gereklirse / Nur wenn erforderlich durch entsprechende nationale gesetzliche Regelungen / Seulement s'il y a lieu par des règlements statutaires nationaux correspondants

06032018 Rev01



# Declaration of performance - Dry-pressed ceramic tiles BIII / Performans deklarasyonu - Kuru preslenmiş seramik karolar BIII



VitrA Karo Sanayi ve Ticaret A.Ş. Şifa Mah. Hükümet Cad. Tuzla 34941 İSTANBUL -TURKEY  
Info: www.vitra.com.tr  
05  
DoP : D400-01

## EN 14411:2016

### Product / Ürün / Produkt / Produits

Dry-pressed ceramic tiles, with Water absorption Eb > 10 % - Group BIII  
Kuru preslenmiş seramik karolar, Su emme oranı Eb > %10 - Grup BIII  
Keramische Fliesen, trockenengepresst mit hoher Wasseraufnahme Eb > 10% - Gruppe BIII  
Carreaux céramiques pressés à sec Eb > 10% - Groupe BIII

### Intended use / Kullanım alanı / Vorgesehene Verwendungszwecke / Usages prévus

For internal walls / İç duvar kaplama  
Wandbeläge innen / Revêtements muraux à l'intérieur



Reaction to fire / Yangına Tepki / Brandverhalten / Réaction au feu	Class / Sınıf / Klasse / Classe A1	EN 14411:2016
<b>Release of dangerous substance for/ Açığa çıkan tehlikeli maddeler / Abgabe gefährlicher Stoffe / Libération de substances dangereuses</b>		
- Cadmium / Kadmium / Cadmium / Cadmium	NPD	EN 14411:2016
- Lead / Kurşun / Blei / Plomb	NPD	EN 14411:2016
Breaking strength / Kırılma dayanımı / Bruchlast / Résistance à la rupture (t= thickness, kalınlık, dicke, épaisseur)	> 600 N (t ≥ 7,5mm) > 200 N (t < 7,5mm)	EN 14411:2016
<b>Bond strength-adhesion for / Bağ dayanımı - yapışma / Verbundfestigkeit-Haftfestigkeit / Adhésion</b>		
- For cementitious adhesives typ C1 / Çimento esaslı yapıştırıcı tip C1 / Für zementhaltige Mörtel typ C1 / Ciment colle type C1	≥ 0,5 N/mm <sup>2</sup>	EN 14411:2016
- Dispersion adhesive / Dispersiyon esaslı yapıştırıcı / Dispersionsklebstoffe / Dispersion de l'adhésif	NPD	EN 14411:2016
- Reaction resin adhesive / Reaksiyon reçine esaslı yapıştırıcı / Reaktionsharzklebstoffe / Réactif à la résine	NPD	EN 14411:2016
- Thermal shock resistance / Isı şokuna dayanım / Temperaturwechsel beständigkeit / Résistance au choc thermique	Pass / Geçer / Bestanden / Validé	EN 14411:2016
<b>Durability for / Dayanıklılık / Dauerhaftigkeit bei / Durabilité pour</b>		
- Internal use / İç mekan kullanım / Anwendungen in Innenbereichen / Une utilisation en intérieur	Pass / Geçer / Bestanden / Validé	EN 14411:2016

06032018 Rev01

# Declaration of performance - Dry-pressed ceramic tiles BIIa / Performans deklarasyonu - Kuru preslenmiş seramik karolar BIIa



VitrA Karo Sanayi ve Ticaret A.Ş. Şifa Mah. Hükümet Cad. Tuzla 34941 İSTANBUL -TURKEY  
Info: www.vitra.com.tr  
05  
DoP No: D300-01

## EN 14411:2016

### Product / Ürün / Produkt / Produits

Dry-pressed ceramic tiles, with water absorption 3% < Eb ≤ 6 % - Group BIIa  
Kuru preslenmiş seramik karolar su emme oranı 3% < Eb ≤ 6 % - Grup BIIa  
Keramische Fliesen, trockenengepresst mit Wasseraufnahme 3% < Eb ≤ 6 % - Group BIIa  
Carreaux céramiques pressés à sec présentant une absorption d'eau 3% < Eb ≤ 6 % - Group BIIa

### Intended use / Kullanım alanı / Vorgesehene Verwendungszwecke / Usages prévus

For internal walls and flooring / İç mekan zemin ve duvar kaplama  
Wand und Boden; innen / Pour murs et sols, d'intérieur



Reaction to fire / Yangına tepki / Brandverhalten / Réaction au feu	Class / Sınıf / Klasse / Classe A1 / A1 <sub>FL</sub>	EN 14411:2016
<b>Release of dangerous substance for/ Açığa çıkan tehlikeli maddeler / Abgabe gefährlicher Stoffe / Libération de substances dangereuses</b>		
- Cadmium / Kadmium / Cadmium / Cadmium	NPD	EN 14411:2016
- Lead / Kurşun / Blei / Plomb	NPD	EN 14411:2016
Breaking strength / Kırılma dayanımı / Bruchlast / Résistance à la rupture (t= thickness, kalınlık, dicke, épaisseur)	> 1100 N (t ≥ 7,5mm) > 600 N (t < 7,5mm)	EN 14411:2016
Slipperiness <sup>(1)</sup> / Kaymaya direnç <sup>(1)</sup> / Rutschhemmende Eigenschaften <sup>(1)</sup> / Glissance <sup>(1)</sup>	See technical documents and catalog Teknik doküman ve kataloglara bakınız Siehe bitte technische Dokumente und Katalog Voir les documents techniques et catalogues	EN 14411:2016
Tactility / Hissedilebilir yüzey / Taktilität / Propriétés tactiles	NPD	
<b>Bond strength-adhesion for / Bağ dayanımı - yapışma / Verbundfestigkeit-Haftfestigkeit / Adhésion</b>		
- For cementitious adhesives typ C2 / Çimento esaslı yapıştırıcı tip C2 / Für zementhaltige Mörtel typ C2 / Ciment colle type C2	≥ 0,5 N/mm <sup>2</sup>	EN 14411:2016
- Dispersion adhesive / Dispersiyon esaslı yapıştırıcı / Dispersionsklebstoffe / Dispersion de l'adhésif	NPD	EN 14411:2016
- Reaction resin adhesive / Reaksiyon reçine esaslı yapıştırıcı / Reaktionsharzklebstoffe / Réactif à la résine	NPD	EN 14411:2016
- Thermal shock resistance / Isı şokuna dayanım / Temperaturwechsel beständigkeit / Résistance au choc thermique	Pass / Geçer / Bestanden / Validé	EN 14411:2016
<b>Durability for / Dayanıklılık / Dauerhaftigkeit bei / Durabilité pour</b>		
- Internal use / İç mekan kullanım / Anwendungen in Innenbereichen / Une utilisation en intérieur	Pass / Geçer / Bestanden / Validé	EN 14411:2016

(1) Only if required by corresponding national statutory regulations / Sadece ilgili ülke mevzuatında gereklirse / Nur wenn erforderlich durch entsprechende nationale gesetzliche Regelungen / Seulement s'il y a lieu par des règlements statutaires nationaux correspondants

06032018 Rev00

### Terms and classification according to TS EN 14411

Tiles are usually shaped by extruding or dry-pressing at room temperature followed by drying and firing at temperatures sufficient to develop the required properties. They can also be formed by other processes, but these are not covered by this European Standard. Tiles can be glazed (GL) or unglazed (UGL). A tile with an engobed surface is regarded as an unglazed tile.

Table 1. Classification of the ceramic tiles according to their groups of Water absorption (E) and their shaping

Shaping	Group I E ≤ 0.5%	Group II <sub>a</sub> 3% < E ≤ 6%	Group II <sub>b</sub> 6% < E ≤ 10%	Group III E > 10%
A Extruded tiles	Group AI <sub>a</sub> E ≤ 0.5% (see annex M)	Group AI <sub>a-1</sub> (see annex B)	Group AI <sub>b-1</sub> (see annex D)	Group AIII (see annex F)
	Group AI <sub>b</sub> 0.5% < E ≤ 3% (see annex A)	Group AI <sub>a-2</sub> (see annex C)	Group AI <sub>b-2</sub> (see annex E)	
B Dry pressed tiles	Group BI <sub>a</sub> E ≤ 0.5% (see annex G)	Group BII <sub>a</sub> (see annex J)	Group BII <sub>b</sub> (see annex K)	Group BIII (see annex L)
	Group BI <sub>b</sub> 0.5% < E ≤ 3% (see annex H)			

Traditionally the following terms are used:

#### Ceramic tiles

Tile made from clays and/or other inorganic raw materials.

#### Extruded tiles

Ceramic tile whose body is shaped in the plastic state in an extruder, the column obtained being cut into tiles of pre-determined dimension.

#### Dry-pressed tiles

Tile formed from a finely milled body mixture and shaped by pressing.

#### Porcelain tiles

Fully vitrified ceramic tile with Water absorption of 0,5% or less.

#### Mosaics

Tiles that are small (Porcelain) stoneware tiles stuck onto sheets.

The water absorption E in weight-% is determined in accordance with EN ISO 10545-3.

### TS EN 14411 standardına göre sınıflandırmalar ve terimler

Karolar genellikle oda sıcaklığında çekme veya kuru presleme ile şekillendirilir, ardından gerekli özellikleri sağlamak için yeterli sıcaklıklarda kurutulur ve fırınlanır. Başka üretim prosesleri ile de oluşturulabilirler, ancak bunlar Avrupa Standardı kapsamında değildir. Karolar, Sırlı (GL) veya sırsız (UGL) olabilir. Angop uygulanmış karolar, sırsız karo olarak kabul edilir.

Tablo 1. Su emme kapasitesi ve şekillendirme özelliklerine göre seramik karoların sınıflandırılması

Şekillendirme	Grup I E ≤ 0.5%	Grup II <sub>a</sub> 3% < E ≤ 6%	Grup II <sub>b</sub> 6% < E ≤ 10%	Grup III E > 10%
A Çekme karolar	Grup AI <sub>a</sub> E ≤ 0.5% (ek M)	Grup AI <sub>a-1</sub> (ek B)	Grup AI <sub>b-1</sub> (ek D)	Grup AIII (ek F)
	Grup AI <sub>b</sub> 0.5% < E ≤ 3% (ek A)	Grup AI <sub>a-2</sub> (ek C)	Grup AI <sub>b-2</sub> (ek E)	
B Kuru preslenmiş karolar	Grup BI <sub>a</sub> E ≤ 0.5% (ek G)	Grup BII <sub>a</sub> (ek J)	Grup BII <sub>b</sub> (ek K)	Grup BIII (ek L)
	Grup BI <sub>b</sub> 0.5% < E ≤ 3% (ek H)			

Geleneksel olarak kullanılan terimler aşağıdaki gibidir:

#### Seramik karo

Kil ve/veya diğer inorganik ham maddelerden elde edilen karodur.

#### Çekme seramik karo

Karo hamurunun plastik halde bir ekstruderde şekillendirilmesi ile elde edilen, kütlelen önceden belirlenmiş boyutlarda kesilmesi ile üretilen seramik karolardır.

#### Kuru preslenmiş karo

Çok ince öğütülmüş ana karışımın preslenerek şekillendirilmesi ile elde edilen karodur.

#### Porselen seramik karo

Su emme kapasitesi % 0,5 veya daha az olacak şekilde tamamen sırlanmış (vitrifiye edilmiş) seramik karodur.

#### Mozaik

Küçük Porselen karoların fileye yapıştırılmasıyla oluşan karolardır.

Su emme kapasitesi E, seramik gövde tarafından emilen suyun yüzdesini (kütlece) belirtir, TS EN ISO 10545-3'e göre deney yapılır.



## VitrA technical properties

### Dimensions and surfaces

#### 1. Dimensions, EN ISO 10545-2

All dimensions are determined in accordance with the standard.

EN 14411	Group Aa		Group Ba / Bb/ B1a	Group B11
	Nature	Precision		
The permissible deviation of the average size for each tile from the work size (W)	± 2% to a maximum of ±4 mm	± 1.0% to a maximum of ±2 mm	± 0.6% and ±2,0 mm	± 0.5% and ± 2,0 mm

#### 2. Surface quality, EN ISO 10545-2

At least 1 m<sup>2</sup> of tiles and a minimum of 30 of them shall be examined at 300 lux for visible defects at a distance of 1 m. For quality 1, a minimum of 95% of the tiles shall be free from visible defects that would impair the appearance of a major area of tiles.

#### 3. Size grading (Calibre)

The production sizes vary for technical reasons. The production size is coded and stamped on the box. Only boxes with the same calibre should be laid together.

### Physical properties

#### 1. Water absorption, EN ISO 10545-3

A sample of each type of tile under test shall consist of 10 whole tiles. Using the below formula,

$$E = (m_2 - m_1) / m_1 \times 100$$

m<sub>2</sub> is the mass of the wet tile;

m<sub>1</sub> is the mass of the dry tile

The Water absorption (E) gives the weight increase in % as compared to the dry weight of boiled samples saturated with water.

#### 1.1. Apparent density, EN ISO 10545-3

It gives the ratio between mass and external volume.

#### 2. Modulus of rupture, EN ISO 10545-4

Breaking strength, breaking load and modulus of rupture of a tile are determined by applying a force at a definite rate to the centre of a tile. Specimens are selected arbitrarily from the part.

Minimum number of test specimens are;

Dimension of the tile in mm	Minimum number of test specimens
18 < L ≤ 48	10
48 < L ≤ 1000	7
L > 1000	5

Breaking strength is calculated by using the below formula,

Breaking strength;  $S = FL/b$

Modulus of rupture;  $R = 3FL/(2bh^2)$

where

• F is the breaking load; in Newtons

• L is the bearing span, in milimeters

• B is the width of the test specimen, in milimeters

• h is the minimum thickness of the test specimen, in milimeters

## VitrA teknik özellikler

### Boyut ve yüzey kalitesi

#### 1. Boyut, TS EN ISO 10545-2

Tüm boyutlar standartlara uygun olarak belirlenir.

EN 14411	Group Aa		Grup Ba / Bb/ B1a	Grup B11
	Doğal	Hassas		
Her bir karonun ortalama boyutunun çalışma boyutundan (W) sapması	± 2% en çok ±4 mm	± 1.0% en çok ±2 mm	± 0.6% ve ±2,0 mm	± 0.5% ve ± 2,0 mm

#### 2. Yüzey kalitesi, TS EN ISO 10545-2

En az 1 m<sup>2</sup> ve en az 30 adet karo, üst yüzeyleri 1 m mesafeden dik olarak görülecek şekilde 300 lx ışık altında incelenir. Kalite 1 için, karonun en az %95'i, asıl görünümü bozan yüzey hatalarından arındırılmış olmaktadır.

#### 3. Boyutlandırma (Kalibre)

Üretim boyutları teknik nedenlerden dolayı değişmektedir. Üretim boyutu kutu üzerine yazılır ve işaretlenir. Sadece aynı kalibreye sahip kutular/karolar birlikte döşenmelidir.

### Fiziksel özellikler

#### 1. Su emme, TS EN ISO 10545-3

Test edilen her tipteki karo, 10 adet bütün karodan oluşmaktadır. Su emme aşağıdaki formül kullanılarak hesaplanır:

$$E = (m_2 - m_1) / m_1 \times 100$$

m<sup>2</sup> ıslak karo kütlesi;

m<sup>1</sup> kuru karo kütlesi

Su emme değeri (E), su ile doyurulmuş numunelerin kuru ağırlığına kıyasla ağırlık artışını % olarak verir.

#### 1.1. Görünen gözeneklilik, TS EN ISO 10545-3

Görünen gözeneklilik, deney numunesinin açık gözeneklerin hacminin dış hacmine oranının yüzdesi olarak ifade edilir.

#### 2. Kopma modülü ve kırılma dayanımı, TS EN ISO 10545-4

Bir karonun Kırılma dayanımı, kırılma yükü ve kopma modülü karonun merkezine belirli bir oranda kuvvet uygulayarak belirlenir.

Örnekleme üretim partisinden rassal olarak yapılır.

Gereken test numunesi adetleri;

Karo boyutu mm cinsinden	Gereken test numune adedi (en az)
18 < L ≤ 48	10
48 < L ≤ 1000	7
L > 1000	5

Kırılma dayanımı aşağıdaki formül ile hesaplanır,

Kırılma dayanımı:  $S = FL/b$

Kırılma katsayısı:  $R = 3FL/(2bh^2)$

formülünde;

• F Kırılma yükü; (Newton)

• L Mesnet çubukları arasındaki açıklık (mm)

• B Deney numunesinin genişliği (mm)

• h Deney numunesinin deneyden sonra kırılmış kenar boyunca ölçülen en küçük kalınlığı (mm)

## VitrA technical properties

### 3. Resistance to shock, EN ISO 10545-5

A minimum of 5 pieces in dimensions 75 mm x 75 mm cut from five tiles used in the test for determination of the coefficient of restitution by dropping a steel ball from a fixed height onto the test specimen and measuring the height of rebound.

### 4. Resistance to deep abrasion, EN ISO 10545-6

Tests shall be carried out using whole tiles or test specimens of suitable dimensions. Before testing, small specimens shall be fixed with an adhesive on to a larger background, avoiding joints. Purpose is to determine the abrasion resistance of unglazed tiles by measuring the length of the groove produced in the proper surface by means of a rotating steel disc, under given conditions and with the use of abrasive material.

### 5. Glaze abrasion, EN ISO 10545-7

The abrasion class of glazed tiles is established in the wet test. Artificial abrasion is produced with the help of aluminium oxide grains, steel balls and the addition of water in an eccentrically revolving system. The number of revolutions at which a visible change of the test surface occurs results in the following classification:

Abrasion stage, Failure visible at revolutions	Class
100	0
150	1
600	2
750, 1500	3
2100, 6000, 12000	4
> 12000*	5

\* Must pass the stain test according to EN ISO 10545-14

Abrasion class	Usage areas
Class 0	The use of glazed tiles of this class is unsuitable for floor.
Class 1	For using the tiles in areas walked on in soft footwear or barefoot and no abrasive dirt contamination. For example; bathrooms and bedrooms in the houses.
Class 2	This class is suitable for usage of tiles in areas infrequently walked on with soft or normal shoes and exposed to only small amount of abrasive dirt contamination. For example; rooms in living areas of houses, except kitchens, entrances, terraces, stairs and heavily frequented used rooms.
Class 3	For floors in areas subject to frequently walking on with normal shoes and abrasive dirt contamination. For example; all rooms in the house including bathrooms, kitchens, entrances, stairs etc.
Class 4	For floors in areas subject to frequently walking and frequent, intense soiling. For example; commercial kitchens, terraces, offices, hotels, schools, hospitals etc.
Class 5	This class is the highest for the wear resistance is suitable for using the tiles in areas that subject to heavy pedestrian traffic and abrasive dirt contamination. For example; shopping centres, airports, banks, restaurants etc.

### 6. Linear thermal expansion, EN ISO 10545-8

The test is used to determine linear thermal expansion coefficient for the temperature range from ambient temperature to 100°C and prepared by cutting two test specimens at right angles from the central portion of one tile so that their lengths are suitable for the apparatus. Then ends of the test specimens shall be ground flat and parallel.

The linear thermal expansion coefficient,  $\alpha$ , is expressed in 10<sup>-6</sup> per degree Celsius (10<sup>-6</sup>/°C), to the first decimal place, in accordance with the expression

$$\alpha = \frac{\Delta L}{L_0 \Delta t}$$

where

- $L_0$  is the length of the test specimen at the ambient temperature;
- $\Delta L$  is the increase in length of the test specimen between ambient temperature and 100 °C;
- $\Delta t$  is the rise in temperature

## VitrA teknik özellikler

### 3. Çarpma dayanımı, TS EN ISO 10545-5

Testte kullanılan beş karodan 75 mm x 75 mm boyutunda en az 5 parça, sabit bir yükseklikten test numunesi üzerine çelik bilyenin düşürülmesi ve sıçrama yüksekliğinin ölçülmesi ile geri gelme katsayısının belirlenmesi için kullanılmaktadır.

### 4. Derin aşınma dayanımı, TS EN ISO 10545-6

Derin aşınma testi, bütün haldeki karolar veya uygun boyutlardaki test numuneleri kullanılarak gerçekleştirilmektedir. Testten önce, küçük boyuttaki numuneler, derzlerden kaçınarak daha büyük bir arka plan üzerine yapıştırıcı ile sabitlenmektedir. Amaç, belirli koşullar altında ve aşındırıcı malzemenin kullanımıyla, dönen bir çelik disk vasıtasıyla yüzeyde oluşan çukur alanın uzunluğunu ölçerek, sırsız karoların aşınma direncini belirlemektir.

### 5. Yüzey aşınma, TS EN ISO 10545-7

Islak test ile Sırlı karoların aşınma sınıfları belirlenir. Yapay aşınma; alüminyum oksit tanecikleri, çelik bilyeler ve eksantrik olarak dönen bir sistemde suyun eklenmesiyle sağlanır. Test yüzeyinde gözle görülür bir değişimin meydana geldiği devir sayısı, aşağıdaki sınıflandırma ile sonuçlanır:

Aşınma kademesi, Kusurun görüldüğü devirler	Sınıf
100	0
150	1
600	2
750, 1500	3
2100, 6000, 12000	4
> 12000*	5

\* EN ISO 10545-14'te belirtilen lekelenmeye dayanıklılık deneyini başarıyla geçmelidir.

Aşınma sınıfı	Kullanım alanları
Sınıf 0	Bu sınıflandırmaya sahip ürünler Yer karosu olarak kullanıma uygun değildir.
Sınıf 1	Yumuşak tabanlı ayakkabı veya çıplak ayakla yürünen bölgelerde aşındırıcı kire maruz kalmayan alanlarda kullanıma uygundur. Örneğin; evlerde banyo ve yatak odası.
Sınıf 2	Bu sınıf, yumuşak veya normal tabanlı ayakkabılarla sık olarak yürünmeyen ve yalnızca az miktarda aşındırıcı kirlenmeye maruz kalan alanlarda kullanım için uygundur. Örneğin; mutfak, giriş, teras, merdiven ve yoğun olarak kullanılan odalar hariç olmak üzere, evlerdeki yaşam alanları.
Sınıf 3	Normal ayakkabılarla ve aşındırıcı kirlenmeye maruz kalan yerlerdeki zeminlerde kullanıma uygundur. Örneğin; Evdeki tüm odalar banyo, mutfak, giriş, merdiven vb.
Sınıf 4	Sık yürünen ve sık yoğun kirlenmeye maruz kalan bölgelerdeki zeminler için uygundur. Örneğin; ticari mutfaklar, teraslar, ofisler, oteller, okullar, hastaneler vb.
Sınıf 5	Aşınma direnci en yüksek olan bu sınıf, yaya trafiğine ve aşındırıcı yoğun kirliliğe maruz kalan alanlarda kullanmak için uygundur. Örneğin; alışveriş merkezleri, havaalanları, bankalar, restoranlar vb.

### 6. Doğrusal ısı genleşme, TS EN ISO 10545-8

Bu testin amacı, ortam sıcaklığı ile 100 °C arasındaki sıcaklık aralığı için doğrusal ısı genleşme katsayısını belirlemektir. Test için bir karonun orta kısmından, cihaza uygun boylarda, birbirine dik açı yapacak şekilde, iki adet deney numunesi kesilmektedir. Deney numunelerinin uçları, düzgün ve birbirine paralel olarak taşlanmaktadır.

Lineer ısı genleşme katsayısı,  $\alpha$ , 10<sup>-6</sup>/°C birimiyle ifade edilir. Aşağıdaki formül yardımıyla hesaplanır:

$$\alpha = \frac{\Delta L}{L_0 \Delta t}$$

formülünde;

- $L_0$  Deney numunesinin ortam sıcaklığındaki uzunluğu,
- $\Delta L$  Ortam sıcaklığı ile 100 °C arasında deney numunesinin uzunluk artışı,
- $\Delta t$  Sıcaklık artışı



## VitrA technical properties

---

### 7. Thermal shock resistance, EN ISO 10545-9

Purpose of the test is to determine the resistance of thermal shock of a whole tile by cycling 10 times between the temperatures of 15 °C and 145 °C.  
A minimum of five whole tiles shall be tested.

### 8. Moisture expansion, EN 10545-10

The test is performed to determine moisture expansion which is proportional accelerated expansion that results from subjecting reheated tiles to extended immersion in boiling water.  
A sample consists of five whole tiles.

### 9. Crazing resistance, EN 10545-11

Crazing refers to the fine hairline cracks to be found in the glaze of nonvitreous tiles and glass plating.  
A minimum of five whole tiles shall be tested and exceptionally large tiles may be cut into pieces for enclosure in the autoclave, but all pieces shall be tested. The cut pieces shall be as large as possible.

### 10. Frost resistance, EN ISO 10545-12

Main criterion for using tiles outdoors. Required, according to EN 14411 Group Bla for Porcelain stoneware and EN 14411 group Blb for vitreous tiles. Frost damage can occur, however, even with tiles complying with standards, if they are laid incorrectly or on defective substrate.

### 11. Colour deviations, EN ISO 10545-16

For quantifying the small colour differences between plain coloured ceramic tiles, which are designed to be of uniform and consistent colour.  
Specimens which are compared to a reference standard will fall into two categories: those are which the  $\Delta E_{cmc}$  values are less than or equal to the agreed upon tolerance are acceptable (pass), while those for which the  $\Delta E_{cmc}$  values are greater than the agreed upon tolerance are unacceptable (fail).

### 12. Behaviour in fire

Ceramic tiles are classified A1 according to EN ISO 13501-1 and EN 14411. Therefore, they are generally non-combustible and thus fire-resistant. Also in the case of fire they do not release any toxic emissions.

## VitrA teknik özellikler

---

### 7. Isı şokuna dayanıklılık, TS EN ISO 10545-9

Testin amacı, bütün bir karonun 15 °C ve 145 °C sıcaklıklar arasında 10 defa çevirim yapılarak ısı şokuna dayanıklılığını belirlemektir. En az 5 bütün karo test edilir.

### 8. Rutubet genişmesi, EN 10545-10

Amaç, karolarda rutubet genişmesini belirlemektir. Rutubet genişmesi, yeniden ısıtılıp soğutulan karonun kaynar su içerisine daldırılarak geniştirilmesi sonucunda oluşan hızlandırılmış bağıl genişmedir. Beş bütün karo test edilir.

### 9. Sırın çatlama dayanımı, EN 10545-11

Sır çatlağı, karonun sadece Sırlı yüzeyinde oluşmuş, saç teli inceliğinde, kılcal çatlaktır. En az beş adet bütün karo denenir. İstisnai olarak, büyük karolar otoklava sığması için kesilebilir, fakat bu durumda kesilen bütün parçalar deneye alınır. Kesilen parçalar mümkün olduğu kadar büyük olmaktadır.

### 10. Dona dayanıklılık, TS EN ISO 10545-12

Dona dayanıklılık, Dış mekânlarda kullanılacak karolar için şarttır. EN 14411'e göre Grup Bla porselen ve Grup Blb seramik karolar Dona dayanım şartını sağlamış olmalıdır. Ancak, hatalı olarak veya uygunsuz bir zemin üzerine döşenen karolarda, standartlara uygun olsa bile dondan hasar oluşabilir.

### 11. Küçük renk farklıları, TS EN ISO 10545-16

Bir örnek ve birbirine uygun renk vermesi için tasarlanmış, tek renkli Sırlı/sırsız seramik karolar arasındaki küçük renk farklılıklarını tayin etmek için kullanılır. Numuneler referans numune ile karşılaştırıldığında iki ana gruba ayrılır.  $\Delta E_{cmc}$  değerleri önceden kabul edilebilen en uygun toleranstan küçük veya ona eşit olanlar kabul edilir.  $\Delta E_{cmc}$  değerleri önceden kabul edilebilen uygun toleranstan büyük olanlar kabul edilmez.

### 12. Yangına tepki

Seramik karolar TS EN ISO 13501-1 ve EN 14411'e göre A1 olarak sınıflandırılmıştır. Bu sebeple, genellikle yanmaz ve dolayısıyla ateşe dayanıklıdırlar. Ayrıca yangın durumunda, herhangi bir toksik madde yaymazlar.

## Chemical properties

### 1. Chemical resistance, EN ISO 10545-13

Subjection of the test specimens to the action of the test solutions and visual determination of attack after a defined period.

Medium	Concentration
1 Aqueous test solutions	
<b>1.1 Household chemicals / swimming pool additives</b>	
Ammonium-chloride solution	100 g/l
Sodium hypochlorite solution	20 mg/l
Classification groups	A/B/C
<b>1.2 Acids and alkalis</b>	
<b>1.2.1 Low concentrations (L)</b>	
Hydrochloric acid	3%
Citric acid	100 g/l
Potassium hydroxide	30 g/l
Classification groups	LA/LB/LC
<b>1.2.2 High concentrations (H)</b>	
Hydrochloric acid	18%
Lactic acid	5%
Potassium hydroxide	100 g/l
Classification groups	HA/HB/HC

\* Class A shows the highest resistance to chemicals, which decreases more and more towards C.

Number of specimens can be listed as:

Tile maximum area, A (cm <sup>2</sup> )	Total Number of Tests Specimens (Tiles)
200 < A ≤ 3600	3
A > 3600	3
When A is ≤ 200 cm <sup>2</sup> , the total number of test specimens (tiles) should be sufficient to cover an area of 200 cm <sup>2</sup> .	

### 2. Stain resistance, EN ISO 10545-14

Determination of the resistance to stains by maintaining test solutions and materials in contact with the proper surface of the tiles for a suitable length of time; the surfaces are then subjected to defined cleaning methods, and finally inspected for visual changes.

Chemicals used in the test can be listed as:

#### - Stains leaving a trace

Green staining agent in light oil

Red staining agent in light oil

#### - Stains having chemical/oxidizing action

Iodine, 13g/l in alcohol

#### - Stain forming a film

Olive oil

#### Cleaning (within the framework of the test)

##### - Cleaning agent

Hot water (+55 °C)

Weak cleaning agent

Strong cleaning agent

##### - Solvent

Hydrochloric acid solution 3% (V/V)

Potassium hydroxide 200g/l

Acetone

Classes

Cl. 5 / Cl. 4 / Cl. 3 / Cl. 2 / Cl. 1

Class 5 shows the highest stain resistance, which decreases more and more towards 1.

## Kimyasal özellikler

### 1. Kimyasal maddelere dayanıklılık, TS EN ISO 10545-13

Testin amacı, deney numunelerini deney çözeltilerinin etkisine maruz bırakmak ve belirli bir süre sonunda oluşabilecek hasarı gözle incelemektir.

Ortam	Konsantrasyon
1 Sulu deney çözeltileri	
<b>1.1 Ev kimyasalları / yüzme havuzu tuzları</b>	
Amonyum klorür çözeltisi	100 g/l
Sodyum hipoklorit çözeltisi	20 mg/l
Sınıflandırma grupları	A/B/C
<b>1.2 Asit ve alkaliler</b>	
<b>1.2.1 Düşük konsantrasyonlar (L)</b>	
Hidroklorik asit çözeltisi	3%
Sitrik asit çözeltisi	100 g/l
Potasyum hidroksit çözeltisi	30 g/l
Sınıflandırma grupları	LA/LB/LC
<b>1.2.2 Yüksek konsantrasyonlar (H)</b>	
Hidroklorik asit çözeltisi	18%
Laktik asit çözeltisi	5%
Potasyum hidroksit çözeltisi	100 g/l
Sınıflandırma grupları	HA/HB/HC

\* A sınıfı, kimyasallara karşı en yüksek dayanımı gösterir, bu da C'ye doğru gittikçe azalır.

Test numunelerinin sayısı aşağıdaki gibidir:

Karo alanı, A (cm <sup>2</sup> )	Toplam deney numune sayısı (karo)
200 < A ≤ 3600	3
A > 3600	3
Alan 200 cm <sup>2</sup> 'e eşit veya küçükse, 200 cm <sup>2</sup> 'yi kaplayacak kadar deney numunesi yeterlidir.	

### 2. Lekelenmeye dayanıklılık, TS EN ISO 10545-14

Karoların üst yüzeyinin deney çözeltileri ve maddeleri ile uygun bir süre boyunca temas halinde bulundurulması, daha sonra yüzeylerin belirli temizleme metotlarına tâbi tutulması ve son olarak görüntü değişikliklerinin kontrol edilmesi ile lekelenmeye dayanıklılıklarının tayinidir.

Kullanılan kimyasallar aşağıdaki gibidir:

#### - Kalıntı bırakan lekelenendiriciler

İnce Yağ İçinde Yeşil Lekelenendirici Madde

İnce Yağ İçinde Kırmızı Lekelenendirici Madde

#### - Kimyasal ve oksitleyici etkili lekelenendiriciler

İyot, alkoldeki 13 g/l'lik çözeltisi

#### - Film oluşturan lekelenendiriciler

Zeytinyağı

#### Temizleme

##### - Temizleyici maddeler

Sıcak su (55 ± 5 °C sıcaklıkta)

Zayıf temizleme maddesi

Güçlü temizleme maddesi

##### - Uygun çözücüler

Hidroklorik asit çözeltisi, hacimce 3% (V/V)

Potasyum hidroksit çözeltisi, 200 g/l'lik

Aseton

#### Sınıflandırma

Sınıf 5 / Sınıf 4 / Sınıf 3 / Sınıf 2 / Sınıf 1

Sınıf 5 en yüksek lekelenmeye karşı direnci gösterir, bu da 1'e doğru gittikçe azalır.



### 1. Coefficient of friction / Slip resistance

Slip-resistant coverings in publicly accessible areas are distinguished according to those that are walked over barefoot or in footwear. Special protective measures against slipping are necessary where there is a risk due to use of water, oil, slush, grease or waste. This should be taken into consideration when choosing the surface material.

The slip resistance value of installed tiles can change over time as a result of wear and surface contaminants. In addition to regular cleaning, deep cleaning and traction-enhancing maintenance may be needed periodically to maintain the slip resistance values. (Ref: ANSI A137.1-2017)

There are many factors that affect the possibility of a slip occurring on a surface including by way of example, but not in limitation, the following: the material of the shoe sole and the degree of its wear; the presence and nature of surface contaminants; the speed and length of stride at the time of a slip; the physical and mental condition of the individual at the time of a slip; whether the floor is flat or inclined; how the hard surface flooring material is used and maintained, and the slip resistance classification of the material, how the flooring surface is structured, and how drainage takes place if liquids are involved. Because many variables affect the risk of a slip occurring, the slip resistance classification shall not be the only factor in determining the appropriateness of a hard surface flooring material for a particular application. (Ref: ANSI A326.3 April 2017)

#### 1.1. Slip resistance properties in commercial applications

DIN 51130 is the test method that is used for determining slip resistance of floor coverings in work rooms and work areas subject to higher risk of slipping. Working rooms and areas are classified according to five assessment groups on the basis of size and the risk of slipping. The lowest slip resistance value is R9 whereas the highest one is R13 for industrial slip resistance of tiles.

In table of industrial areas slip resistance classification and collection space, the application areas are indicated in accordance with "ASR 1.5/1,2 Technical Regulations for workplaces -Floors".



Open field test

**Important Notice:** The indicated angles of inclination helps to identify anti-slip classification of the product and cannot be related to the angles of inclination of slopes/ramps.

### 1. Sürtünme katsayısı / Kayma direnci

Kamuya açık alanlardaki kaymaya karşı dayanıklı karolar çıplak ayakla veya ayakkabıyla üzerinde yürünenler olarak ayırt edilmektedir. Su, yağ, çamur, makine yağı veya atık kullanımı nedeniyle risk olan yerlerde kaymaya karşı özel koruyucu tedbirler gereklidir. Bu durum yüzey materyali seçilirken dikkate alınmalıdır.

Döşenen karoların kaymaya karşı dayanıklılık değeri aşınma ve yüzey kirleri nedeniyle zaman içinde değişebilmektedir. Kaymaya karşı dayanıklılık değerlerinin korunması için düzenli temizlemenin yanında, derinlemesine temizlik ve çekiş arttırıcı bakım periyodik olarak gerekebilecektir. (Ref: ANSI A137.1-2017)

Bir yüzeydeki kayma olasılığını etkileyebilecek olan pek çok faktör mevcuttur. Örnek olarak verilebilecekler: Ayakkabı tabanının malzemesi ve aşınma derecesi; yüzey kirlerinin mevcut olması ve yapısı; kayma sırasındaki geçişin hızı ve uzunluğu; bir kayma sırasında bireyin fiziksel ve zihinsel durumu; zeminin düz mü yoksa eğimli mi olduğu; sert zemin döşeme malzemesinin nasıl kullanıldığı ve muhafaza edildiği ve malzemenin kayma dayanıklılık sınıflandırması, zemin yüzeyinin nasıl yapılandırıldığı ve sıvılar söz konusu olduğunda tahliyenin nasıl gerçekleştiği gibi faktörlerdir. Kayma riskinin oluşmasını etkileyebilecek pek çok değişken olduğundan, belirli bir uygulama için karonun kullanım uygunluğunun belirlenmesinde kayma dayanım sınıflandırması tek unsur olmayacaktır. (Ref: ANSI A326.3 Nisan 2017)

#### 1.1. Endüstriyel alanlarda kayma direnci

DIN 51130, yüksek kayma riski olan çalışma odaları ve çalışma alanlarındaki zemin kaplamalarının kayma direncini belirlemek için kullanılan test yöntemidir. Çalışma alanları kayma riskine göre beş değerlendirme grubu içerisinde sınıflandırılmıştır. Karoların endüstriyel kayma direnci için en düşük kaymazlık değeri R9 iken, en yüksek olanı R13'tür.

Endüstriyel alanların kayma direnci sınıflandırması ve dolma hacmi tablosunda, uygulama alanları "ASR 1.5/1,2 İşyerleri için Teknik Düzenlemeler"e göre belirlenmiştir.

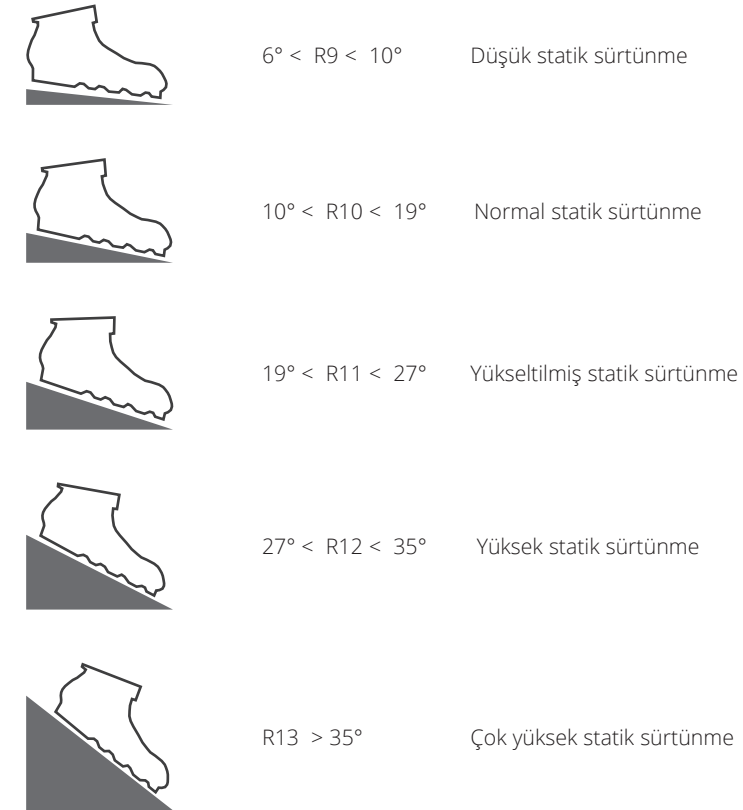

Açık alan testi

**Önemli Not:** Belirtilen eğim açıları ürünün kaymazlık sınıflandırmasının belirlenmesine yardımcı olmaktadır ve eğim ve rampaların eğim açılarıyla ilişkilendirilemezler.

# VitrA slip resistance

## 1.1.1. Working rooms and areas with risk of slipping (in accordance with ASR A1.5/1,2)

DIN 51130 is the test method that is used for determining slip resistance of floor coverings in work rooms and work areas subject to higher risk of slipping. Working rooms and areas are classified according to five assessment groups on the basis of size and the risk of slipping. The lowest slip resistance value is R9 whereas the highest one is R13 for industrial slip resistance of tiles.

In table of industrial areas slip resistance classification and collection space, the application areas are indicated in accordance with "ASR 1.5/1,2 Technical Regulations for workplaces -Floors".

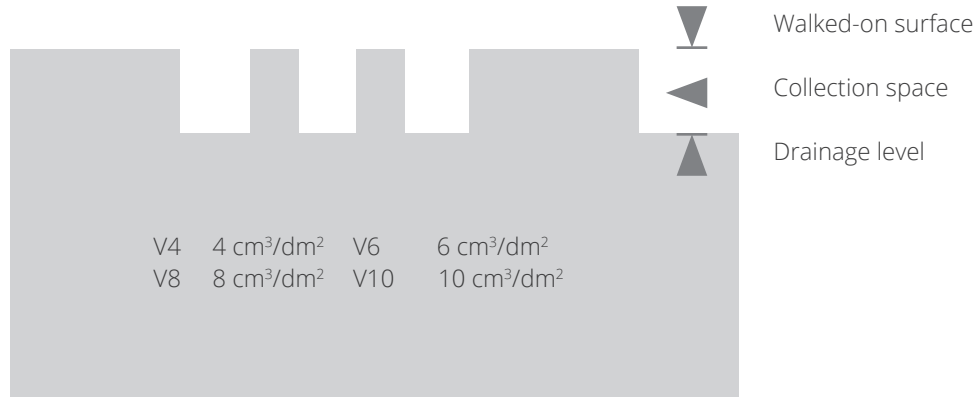

The displacement space (V4-V10) is the open space between the upper walked-on surface and the drainage level of profiled surfaces.

## Industrial areas slip resistance classification and collection space - Application areas

Nr.	Working areas, walking corridors	Antislip groups (R classes)	Minimum collection space	Nr.	Working areas, walking corridors	Antislip groups (R classes)	Minimum collection space
<b>0</b>	<b>General working rooms and areas</b>			95	Food preparation kitchens (fast-food kitchens, snack bars)	R 12	V 4
0.1	Entrance areas (inside)	R 9		96	Kitchens for heating up frozen meals	R 10	
0.2	Entrance areas (outside)	R 11 - R 10	V 4	97	Coffee and tea kitchens, hotel garni kitchens and ward kitchens	R 10	
0.3	Stairs (inside)	R 9		98	Washing-up areas		
0.4	Stairs (outside)	R 11 - R 10	V 4	98.1	Washing-up areas for 9.1, 9.4, 9.5	R 12	V 4
0.5	Sloping ramps, inside* (e.g. for wheelchairs, leveling slopes, transport paths)	R 10		98.2	Washing-up areas for 9.2	R 11	
0.6	Sanitary rooms	R 9		98.3	Washing-up areas for 9.3	R 12	
0.6.1	Toilets			99	Dining rooms, guest rooms, canteens including serving counters	R 9	
0.6.2	Changing or washrooms			<b>10</b>	<b>Cold stores, deep freeze stores</b>	R 12	
0.7	Break rooms (e.g. dayrooms, canteens)			10.1	For unpacked goods	R 12	
0.8	First aid rooms and similar facilities (see ASR A4.3)			10.2	For packed goods	R 11	
<b>1</b>	<b>Manufacture of margarine, edible fats and oils</b>			<b>11</b>	<b>Sales outlets, shops</b>		
1.1	Melting of fat	R 13	V 6	11.1	Reception of goods, meats		
1.2	Cooking oil refinery	R 13	V 4	11.1.1	For unpacked goods	R 11	
1.3	Margarine production and packaging	R 13		11.1.2	For packed goods	R 10	
1.4	Cooking fat production and packing, oil bottling	R 12		11.2	Reception of goods, fish	R 11	
<b>2</b>	<b>Milk processing, cheese production</b>			11.3	Serving counters for meat and sausage		
2.1	Fresh milk processing and butter production	R 12		11.3.1	For unpacked goods	R 11	
2.2	Cheese production, storage and packaging	R 11		11.3.2	For packed goods	R 10	
2.3	Icecream manufacturing	R 12		11.4	Serving counters for bread, cakes and pastries, unpacked goods	R 10	
<b>3</b>	<b>Chocolate and confectionery production</b>			11.5	Serving counters for cheese and cheese products, unpacked goods	R 10	
3.1	Sugar processing	R 12		11.6	Serving counters for fish		
3.2	Cocoa production	R 12		11.6.1	For unpacked goods	R 12	
3.3	Production of raw mixtures	R 11		11.6.2	For packed goods	R 11	
3.4	Fabrication of chocolate bars, shells and filled chocolates	R 11		11.7	Serving counters from Nr.11.3 to 11.6	R 9	
<b>4</b>	<b>Production of bread, cakes and pastries (bakeries, cake shops, production of long-life bakery products)</b>			11.8	Meat preparation rooms		
4.1	Dough production	R 11		11.8.1	For meat preparation, except for no.5	R 12	V 8
4.2	Rooms in which predominantly fats or liquid mixtures are processed	R 12		11.8.2	For meat processing, except for no.5	R 11	
4.3	Washing-up rooms	R 12	V 4	11.9	Florists shops	R 11	
<b>5</b>	<b>Slaughtering, meat processing</b>			11.10	Sales areas with stationary ovens		
5.1	Slaughter house	R 13	V 10	11.10.1	For the production of bread, cakes and pastries	R 11	
5.2	Tripe processing room	R 13	V 10	11.10.2	For the warming-up of refabricated bread, cakes and pastries	R 10	
5.3	Meat sectioning	R 13	V 8	11.11	Sales areas with stationary chip pans or grills	R 12	V 4
5.4	Sausage kitchen	R 13	V 8	11.12	Shops, customer rooms	R 9	
5.5	Boiled sausage unit	R 13	V 8	11.13	Preparation areas for food and self-service shops	R 10	
5.6	Raw sausage unit	R 13	V 6	11.14	Cash register areas, packing areas	R 9	
5.7	Sausage drying room	R 12		11.15	Outdoor sales areas	R 11 - R 10	V 4
5.8	Smoking establishments	R 12		<b>12</b>	<b>Health service rooms</b>		
5.9	Salting and curing rooms	R 12		12.1	Disinfection rooms (wet)	R 11	
5.10	Poultry processing	R 12	V 6	12.2	Pre-cleaning areas of sterilization	R 10	
5.11	Gut store	R 12		12.3	Faeces disposal rooms, discharge rooms, unclean nursing work rooms	R 10	
5.12	Cold cuts and packaging unit	R 12	V 8	12.4	Pathological facilities	R 10	
<b>6</b>	<b>Fish processing, production of delicatessen</b>			12.5	Rooms for medical baths, hydrotherapy, fango preparation	R 11	
6.1	Fish processing	R 13	V 10	12.6	Washrooms of operating theatres, plastering rooms	R 10	
6.2	Production of delicatessen	R 13	V 6	12.7	Sanitary rooms, ward bathrooms	R 10	
6.3	Manufacture of mayonnaise	R 13	V 4	12.8	Rooms for medical diagnosis and therapy, massage rooms	R 9	
<b>7</b>	<b>Processing of vegetables</b>			12.9	Operation theatres	R 9	
7.1	Production of sauerkraut	R 13	V 6	12.10	Wards with hospital rooms and corridors	R 9	
7.2	Vegetable tinning	R 13	V 6	12.11	Medical practices, day clinics	R 9	
7.3	Sterilization rooms	R 13	V 6	12.12	Pharmacies	R 9	
7.4	Rooms in which vegetables are prepared for processing	R 12	V 4	12.13	Laboratories	R 9	
<b>8</b>	<b>Food areas in food and beverage production (if not specifically mentioned)</b>			12.14	Hairdressing salons	R 10	
8.1	Storage cellars	R 10		<b>13</b>	<b>Laundries</b>		
8.2	Beverage bottling, fruit juice production	R 11		13.1	Rooms with continuous-flow washing machines	R 9	
<b>9</b>	<b>Catering establishments</b>			13.2	Rooms with washing machines or with spin-drier	R 11	
9.1	Kitchens in the catering trade (restaurant kitchens, hotel kitchens)			13.3	Ironing rooms	R 9	
9.1.1	Up to 100 meals per day	R 11	V 4	<b>14</b>	<b>Fodder concentrate production</b>		
9.1.2	More than 100 meals per day	R 12	V 4	14.1	Dried fodder production	R 11	
9.2	Catering kitchens serving to homes, schools, kindergartens, sanatoria	R 11		14.2	Fodder concentrate production using fat and water	R 11	V 4
9.3	Kitchens of hospitals and clinics	R 12					
9.4	Catering kitchens serving to universities and industrial canteens	R 12	V 4				

## Industrial areas slip resistance classification and collection space - Application areas

Nr.	Working areas, walking corridors	Antislip groups (R classes)	Minimum collection space	Nr.	Working areas, walking corridors	Antislip groups (R classes)	Minimum collection space
<b>15</b>	<b>Leather productions, textiles</b>			24.3	Washing halls	R 12	
15.1	Wet areas in tanneries	R 13		<b>25</b>	<b>Sewage treatment plants</b>		
15.2	Rooms with fleshing machines	R 13		25.1	Pump rooms	R 11	V 4
15.3	Areas where leather scraps accumulate	R 13	V 10	25.2	Rooms for sludge draining facilities	R 12	
15.4	Rooms for making leather impermeable by means of grease	R 12	V 10	25.3	Rooms for screening equipment	R 12	
15.5	Dye mills for textures	R 11		25.4	Stands of workplaces, scaffolds and maintenance platforms	R 12	
<b>16</b>	<b>Paint shops</b>			<b>26</b>	<b>Fire brigade buildings</b>		
16.1	Wet grinding areas	R 12		26.1	Vehicle parking places	R 12	
<b>17</b>	<b>Ceramic industry</b>			26.2	Rooms for hose maintenance equipment	R 12	
17.1	Wet grinding mills (processing of ceramic, raw materials)	R 11	V 10	<b>27</b>	<b>Functional rooms in the breathing apparatus training facility</b>		
17.2	Mixers; handling of materials like tar, pitch, graphite and synthetic resins	R 11		27.1	Preparation room	R 12	
17.3	Presses (shaping); handling of materials like tar, pitch, graphite and synthetic resins	R 11	V 6	27.2	Conditioning room		
17.4	Casting / die casting areas	R 12	V 6	27.3	Training room		
17.5	Glazing areas	R 12		27.4	Air lock		
<b>18</b>	<b>Glass and stone processing</b>			27.5	Mock-up dwelling		
18.1	Stone cutting, stone grinding	R 11		27.6	Heat acclimatization room		
18.2	Glass moulding of hollow glass, container glass, structural glass	R 11		27.7	Control station		
18.3	Grinding areas for hollow glass ware, flat glass	R 11		<b>28</b>	<b>Schools and day nurseries</b>		
18.4	Insulating glass manufacture; handling of drying agents	R 11		28.1	Class rooms, group rooms	R 9	
18.5	Packaging, shipping of flat glass; handling of anti-adhesive agents	R 11	V 6	28.2	Stairs	R 10	
18.6	Etching and acid polishing facilities for glass	R 11	V 6	28.3	Toilets, washrooms	R 11 - R 10	V 4
<b>19</b>	<b>Cast concrete factories</b>			28.4	Instructional kitchens in schools (also see no.9)	R 11 - R 10	V 4
19.1	Concrete washing areas	R 11		28.5	Kitchens in kindergartens (also see no.9)		
<b>20</b>	<b>Storage rooms</b>			28.6	Machine rooms for wood processing	R 9	
20.1	Storage areas for oils and fats	R 12		28.7	Special rooms for handicrafts	R 9	
20.2	Storage areas for packed food	R 10	V 6	28.8	Schoolyards	R 9	
20.3	Outdoor storage areas	R 11 - R 10		<b>29</b>	<b>Banks</b>		
<b>21</b>	<b>Chemical and thermal treatment of iron and metal</b>			29.1	Bank counter	R 10	
21.1	Pickling plants	R 12	V 4	<b>30</b>	<b>Plant traffic routes in outdoor areas</b>		
21.2	Hardening shops	R 12		30.1	Footpaths	R 10	
21.3	Laboratory rooms	R 11		30.2	Loading platforms	R 10	
<b>22</b>	<b>Metal processing, metal workshops</b>			30.2.1	Covered	R 11 - R 10	V 4
22.1	Galvanizing shops	R 12		30.2.2	Not covered		
22.2	Grey cast iron processing	R 11		30.3	Sloping ramps (e.g. for wheel-chairs, loading platforms)	R 11 - R 10	V 4
22.3	Mechanical processing areas (turnery, milling shop), punching room, pressroom, drawing shop (pipes, wires) and areas exposed to increased stress by oil and lubricants	R 11	V 4	30.4	Covered		
22.4	Parts cleaning areas, exhaust steam areas			30.4.2	Not covered	R 11 - R 10	V 4
<b>23</b>	<b>Vehicle repair workshops</b>			<b>31</b>	<b>Parking areas</b>		
23.1	Repair and servicing bays	R 12		31.1	Garages, multi-storey and underground car parks not subject to the effects of the weather	R 12	V 4
23.2	Working and inspection pits	R 11		31.2	Garages, multi-storey and underground car parks subject to the effects of the weather	R 12	
23.3	Car washing halls, washing areas	R 12	V 4	31.3	Parking areas outdoors	R 11	
<b>24</b>	<b>Aircraft repair workshops</b>						
24.1	Aircraft hangars	R 11	V 4				
24.2	Repair hangars	R 11					



## VitrA kayma dayanımı

### 1.1.1. Kayma kiski olan çalışma odaları ve alanları ( ASR A1.5/1,2'ye uygun olarak)

Özellikle çalışma alanlarındaki basma/basamak seviyesinin altındaki boşlukta dolma hacmine biriken ve kaymaya neden olan malzemelerin boşaltılması için dolma hacminin asgari hacmi bir "V" numarası ile tanımlanmaktadır.

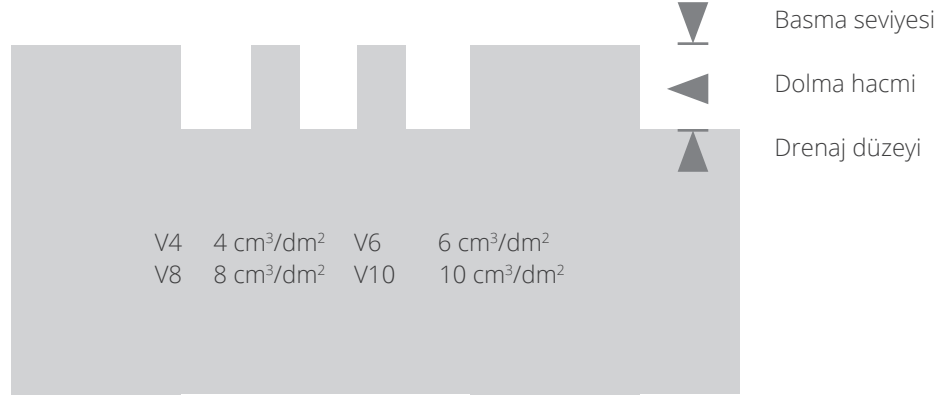

Yer değiştirme alanı (V4-V10) üzerinde yürünen üst dolaşım yüzeyi ile profilli yüzeylerin drenaj düzeyi arasındaki açık alandır.

### Endüstriyel alanda kayma sınıfları ve dolma hacmi - Kullanım alanları - Asr 1.5/1.2'ye uygun olarak

Nr.	Çalışma alanları, yürüme yolları	Kayma sınıfı (R grupları)	En küçük dolma hacmi	Nr.	Çalışma alanları, yürüme yolları	Kayma sınıfı (R grupları)	En küçük dolma hacmi
15	<b>Deri üretimi, tekstil</b>	R 11		25	<b>Eysel atık işleme istasyonları</b>	R 12	
15.1	Tabakhaneleri sulu yerler	R 11		25.1	Pompa odaları	R 11	V 4
15.2	Deri yüzme makinelerinin olduğu odalar			25.2	Sulu atıkların drenaj		
15.3	Deri Parçalarının toplandığı odalar	R 13	V 10	25.3	Eleme odaları	R 12	
15.4	Derilerin empreye yapıldığı yerler	R 13	V 10	25.4	Ayakta durulan yerler ve bekleme odaları	R 12	
15.5	Tekstil için boya değirmenlerinin olduğu yerler	R 13		26	<b>İtfaiye binaları</b>	R 12	
16	<b>Cila atölyeleri</b>	R 12		26.1	Araç parkı	R 12	
16.1	Sulu öğütme atölyeleri	R 11		26.2	Hortum bakım atölyesi		
17	<b>Seramik endüstrisi</b>			27	<b>Solumun cihazları eğitim tesisinde işlevsel odalar</b>	R 12	
17.1	Islak değirmenler (seramik hammaddenin hazırlanması)	R 12		27.1	Hazırlık odası	R 12	
17.2	Karıştırıcılar, zift, grafit ve sentetik malzemelerin kullanıldığı yerler		V 10	27.2	Havalandırma odası		
17.3	Şekillendirme presleri zift, grafit ve sentetik malzemelerin kullanıldığı yerler	R 11		27.3	Eğitim odası	R 9	
17.4	Döküm / pres döküm alanları	R 11	V 6	27.4	Hava hücresi		
17.5	Sırlama	R 11	V 6	27.5	Model ev		
18	<b>Cam ve taş prosesi</b>	R 12		27.6	Sıcak iklimlendirme odaları		
18.1	Taş kesme ve öğütme yeri	R 12		27.7	Denetim istasyonu		V 4
18.2	Her türlü cam şekillendirme alanı			28	<b>Okullar ve kreşler</b>	V 4	
18.3	Öğütme yerleri	R 11		28.1	Sınıflar, grup odaları		
18.4	İzolasyon camı üretiminde kurutucu malzemelerin işlendiği yerler	R 11		28.2	Merdivenler		
18.5	Düz camın paketlenmesi ve yüklenmesi için kullanılan malzemelerin hazırlanması	R 11		28.3	Tuvaletler, yıkama odaları	R 10	
18.6	Asitli indirme yapılan yerler	R 11	V 6	28.4	Okullardaki eğitimci mutfağlar (bkz. Nr. 9)	R 11 - R 10	
19	<b>Prefabrik beton fabrikaları</b>	R 11	V 6	28.5	Çocuk yuvalarındaki mutfağlar (bkz. Nr. 9)	R 11 - R 10	
19.1	Beton yıkama yerleri			28.6	Ağaç işleme makinelerinin olduğu odalar		
20	<b>Depolar</b>	R 11		28.7	El sanatları için özel odalar	R 9	
20.1	Likit ve katı yağlar için stok sahaları	R 11		28.8	Teneffüs alanları	R 9	
20.2	Paketlenmiş yiyeceklerin stok sahaları			29	<b>Bankalar</b>	R 9	
20.3	Açık alandaki stok sahaları	R 12		29.1	Banka vezneleri	R 10	V 4
21	<b>Demir ve metalin kimyasal ve ısı işleme prosesi</b>	R 10	V 6	30	<b>Diş mekanlardaki işletmeyle ilgili yollar</b>	R 10	
21.1	Bezereyen	R 11 - R 10		30.1	Yürüme yolları	R 10	V 4
21.2	Sertleştirme prosesi		V 4	30.2	Yükleme rampaları	R 10	
21.3	Laboratuvarlar	R 12		30.2.1	Örtülü	R 10	V 4
22	<b>Metal prosesi, metal atölyeleri</b>	R 12		30.2.2	Açık	R 11 - R 10	
22.1	Galvanize atölyeleri	R 11		30.3	Eğik rampalar (örn. tekerlekli sandalyeler, yükleme köprüleri için)		
22.2	Graugussbearbeitung			30.4.1	Üstü kapalı	R 11 - R 10	
22.3	Mekanik proses (torna, pres yerleri) tel boru çekme yerleri, yağlı ortamdan dolayı riskin fazla olduğu ortamlar	R 12		30.4.2	Üstü açık	R 11 - R 10	
22.4	Parça temizleme yerleri, buhar çıkışının olduğu odalar	R 11	V 4	31	<b>Park alanları</b>	R 11 - R 10	
23	<b>Araç bakım yerleri</b>	R 11	V 4	31.1	Garajlar, hava koşullarından etkilenmeyen çok katlı ve yeraltı otoparkları	R 12	
23.1	Bakım ve servis alanı	R 12		31.2	Garajlar, hava koşullarından etkisinde kalan çok katlı ve yeraltı otoparkları	R 12	
23.2	Çalışma ve kontrol alanı			31.3	Açık park alanları	R 11	
23.3	Araç yıkama yerleri	R 11					
24	<b>Uçak bakım atölyeleri</b>	R 12	V 4				
24.1	Uçak hangarları	R 11	V 4				
24.2	Uçak bakım ve tamir hangarları						
24.3	Uçak yıkama yerleri	R 11					

### Endüstriyel alanda kayma sınıfları ve dolma hacmi - Kullanım alanları - Asr 1.5/1.2'ye uygun olarak

Nr.	Çalışma alanları, yürüme yolları	Kayma sınıfı (R grupları)	En küçük dolma hacmi	Nr.	Çalışma alanları, yürüme yolları	Kayma sınıfı (R grupları)	En küçük dolma hacmi
0	<b>Genel çalışma odaları</b>			9.5	Yemek hazırlama mutfağları (fast-food, snack bar)	R 12	
0.1	Giriş yerleri (iç)	R 9		9.6	Dondurulmuş ürünlerin ısıtıldığı mutfağlar	R 12	V 4
0.2	Giriş yerleri (dış)	R 11 - R 10	V 4	9.7	Çay ve kahve hazırlama mutfağları, garni mutfağı, koğuş mutfağı	R 10	V 4
0.3	Merdivenler (iç)	R 9		9.8	Bulaşık yıkama alanları	R 10	
0.4	Merdivenler (dış)	R 11 - R 10	V 4	9.8.1	Bulaşık yıkama alanları 9.1, 9.4, 9.5 için	R 12	
0.5	Eğimli rampalar, iç (örn. tekerlekli sandalye, tesviye yokuşu, nakliye yolları için)	R 10		9.8.2	Bulaşık yıkama alanları 9.2 için		
0.6	Sağlık odaları	R 9		9.8.3	Bulaşık yıkama alanları 9.3 için	R 11	
0.6.1	Tuvaletler			9.9	Yemek odaları, misafir yemek odaları, servis bankosu olan kantinler	R 12	V 4
0.6.2	Soyunma kabini veya yıkama alanları			10	<b>Soğuk hava ve donmuş gıda depoları</b>	R 12	
0.7	Dinlenme odaları (örn. sosyal tesisler, kantinler)			10.1	Paketlenmiş malzemeler için	R 9	
0.8	İlk yardım odaları ve benzer tesisler			10.2	Paketlenmiş malzemeler için		
1	<b>Margarin, yenilebilir sıvı ve katı yağ üretimi</b>			11	<b>Satış yerleri, dükkanlar</b>	R 12	
1.1	Yağın eritilmesi	R 13	V 6	11.1	Et giriş	R 11	
1.2	Yemeklik yağ arıtımı	R 13	V 4	11.1.1	Paketlenmiş malzemeler için		
1.3	Margarin üretim ve paketlenme	R 12		11.1.2	Paketlenmiş malzemeler için		
1.4	Yemeklik yağ üretimi, paketlenme, işleme	R 12		11.2	Balık girişi	R 11	
2	<b>Süt prosesi, peynir üretimi</b>			11.3	Sosis, salam, sucuk ve et için servis geçişi	R 10	
2.1	Taze süt işlenmesi ve tereyağı üretimi	R 12		11.3.1	Paketlenmiş malzemeler için	R 11	
2.2	Peynir üretimi, depolama ve paketlenme	R 11		11.3.2	Paketlenmiş malzemeler için		
2.3	Dondurma üretimi	R 12		11.4	Paketlenmiş ekmeğe ve unlu mamuller için servis geçişi	R 10	
3	<b>Çikolata ve şekerleme üretimi</b>			11.5	Paketlenmiş süt ürünleri ve meze için servis geçişi	R 10	
3.1	Şekerin işlenmesi	R 12		11.6	Balık servisi	R 10	
3.2	Kakao üretimi	R 12		11.6.1	Paketlenmiş malzemeler için	R 10	
3.3	Ham karışımların üretimleri	R 11		11.6.2	Paketlenmiş malzemeler için		
3.4	Çubuk, kabuk ve içi doldurulmuş çikolata üretimi	R 11		11.7	Nr. 11.3'ten 11.6'ya kadar hariç servis geçişleri	R 12	
4	<b>Kepek, pasta ve ekmeğe üretimi (firınlar, pastaneler ve uzun dayanımlı unlu mamul üretimi)</b>			11.8	Et hazırlama odaları	R 11	
4.1	Hamur hazırlama	R 11		11.8.1	Nr. 5 hariç et işleme (işleme)	R 9	
4.2	Yağlı ve sıvı üretimin ağır bastığı yerler	R 12		11.8.2	Nr. 5 hariç et işleme (işleme)		
4.3	Bulaşık yıkama odası	R 12	V 4	11.9	Çiçek buketi yapım odaları	R 12	V 8
5	<b>Et işleme, kesimhaneler (mezbahalar)</b>			11.10	Sabit firını olan satış bölgeleri	R 11	
5.1	Kesim yeri	R 13	V 10	11.10.1	Unlu mamullerin hazırlanması	R 11	
5.2	Sakatat temizleme yeri	R 13	V 10	11.10.2	Önceden hazırlanmış unlu mamullerin işlenmesi		
5.3	Et parçalama	R 13	V 8	11.11	Sabit fritöz ya da ızgarası olan satış bölgeleri	R 11	
5.4	Sosis, salam ve sucuk hazırlama	R 13	V 8	11.12	Satış yerleri ve müşteri kabul	R 10	V 4
5.5	Haşlama bölümü	R 13	V 8	11.13	Self-servis yapan yerlerde yiyecek hazırlama bölümü	R 12	
5.6	Ham üretim bölümü	R 13	V 6	11.14	Kasa ve paketlenme bölümleri	R 9	
5.7	Sucuk, salam, sosis kurutma odası	R 12		11.15	Açık alanda satış bölümleri	R 10	
5.8	Bağırsak deposu	R 12		12	<b>Sağlık birimleri</b>	R 9	
5.9	Tuzlama ve terbiye odası	R 12		12.1	Dezenfekte odaları (ıslak)	R 11 - R 10	V 4
5.10	Kanalı işleme	R 12	V 6	12.2	Sterilizasyon için ön temizlik yerleri		
5.11	Soğuk kesim ve paketlenme	R 12		12.3	Dış atık odaları, temiz olmayan hemşirelik hizmetleri	R 11	
5.12	Elle işleme ve satış	R 12	V 8	12.4	Sektörsalräume	R 10	
6	<b>Balık işleme ve meze üretimi</b>			12.5	Tıbbi banyolar, hidroterapi üniteleri	R 10	
6.1	Balık işlenmesi	R 13	V 10	12.6	Ameliyathanelerin ve alçıların yıkama odaları	R 10	
6.2	Meze üretimi	R 13	V 6	12.7	Tuvaletler, koğuş banyoları	R 11	
6.3	Mayonez üretimi	R 13	V 4	12.8	Masaj odaları, teşhis ve terapi odaları	R 10	
7	<b>Sebzeler işlenmesi</b>			12.9	Ameliyathaneler	R 10	
7.1	Sauerkraut üretimi	R 13	V 6	12.10	Hasta odaları ve koridorlar olan klinikler	R 9	
7.2	Konserve üretimi	R 13	V 6	12.11	Muayenehaneler, gündüz klinikleri	R 9	
7.3	Sterilizasyon odaları	R 11		12.12	Eczaneler	R 9	
7.4	Üretim için hazırlama	R 12	V 4	12.13	Laboratuvarlar	R 9	
8	<b>Yemek ve içecek üretimindeki ıslak zeminler (özellikle farklı bir şey belirtilmemişse)</b>			12.14	Kuaförler	R 9	
8.1	Kilerler, malzemeler	R 10		13	<b>Çamaşırhaneler</b>		
8.2	Mezhebe işleme ve meyve suyu üretimi	R 11		13.1	Kurutmalı (santrifüjli) çamaşır makineleri		
9	<b>Mutfaklar ve pişirme yerleri</b>			13.2	Çok ıslak çamaşırhaneleri olduğu yıkama odaları		
9.1	Restoran, otel mutfağları	R 11		13.3	Ütü ve çamaşır sıkma makinelerinin olduğu odalar	R 9	
9.2	Evlere, çocuk yuvalarına, sanatoryumlara servis yapan mutfağlar	R 12	V 4	14	<b>Konsantre hayvan yemi üretimi</b>	R 11	
9.3	Hastane ve klinik mutfağları	R 11	V 4	14.1	Kurutulmuş yem üretimi	R 9	
9.4	Üniversite ve büyük fabrikalara servis veren mutfağlar	R 12		14.2	Su ve yağ kullanılarak kurutulmuş yem üretimi		V 4

## VitrA slip resistance

### 1.2. Slip-resistance properties in barefoot areas

DIN 51097 is the test method that is used for determining slip resistance of floor coverings in wet barefoot areas subject to risk of slipping. According to DIN 51097, there are three assessment groups on the basis of size and the risk of slipping in wet barefoot areas. The lowest slip resistance value is A, whereas the highest one is C for classification of barefoot slip resistance of tiles.

In the following table of barefoot areas slip resistance classification, the application areas are indicated in accordance with the leaflet "DGUV Information 207-006 - Floor coverings for wet barefoot areas".

#### Wet barefoot areas slip resistance classification and application areas

Class	Min. degree of slope	Areas
<b>A</b>	12°	<ul style="list-style-type: none"><li>- Barefoot passages and sanitary areas (mainly dry)</li><li>- Individual and common dressing rooms</li><li>- Pool floors in non-swimmer areas if the water depth is more than 80 cm in the entire area</li><li>- Sauna and relaxation areas (mainly dry)</li></ul>
<b>B</b>	18°	<ul style="list-style-type: none"><li>- Barefoot passages and sanitary areas, if not classified in group A</li><li>- Showers</li><li>- Steam baths</li><li>- Area of disinfecting spray facilities</li><li>- Pool surrounds</li><li>- Pool floors in non-swimmer areas if the water depth is less than 80 cm in certain areas</li><li>- Non-swimmer sections of wave-action pools</li><li>- Movable floors</li><li>- Paddling pools</li><li>- Ladders and stairs outside the pool area, if not classified in group C</li><li>- Accessible surfaces of diving platforms and diving boards, if not classified in group C</li><li>- Sauna and relaxation areas, if not classified in group A</li></ul>
<b>C</b>	24°	<ul style="list-style-type: none"><li>- Ladders and stairs leading into the water</li><li>- Stairs up to diving facilities and water slides</li><li>- Surfaces of diving platforms and diving boards over the length reserved for the diver (the slip-resistant surface of the diving platforms and diving boards must cover the front edge where the hands and the toes of the divers grip)</li><li>- Walk-through pools</li><li>- Inclined pool edge designs</li><li>- Kneipp pools, water-treading pools</li><li>- Ramps in the pool surround area with an inclination &gt; 6 %</li></ul>

**Important notice:** The indicated angles of inclination helps to identify anti-slip classification of the product and cannot be related to the angles of inclination of slopes/ramps.

## VitrA kayma dayanımı

### 1.2. Çıplak ayaklı alanlardaki kayma dayanım özellikleri

DIN 51097, kayma riski olan ıslak çıplak ayaklı alanlardaki zemin kaplamalarının kayma dayanımının belirlenmesi için kullanılan test yöntemidir. DIN 51097'ye göre, ıslak çıplak ayaklı alanlarda kayma riskine göre üç değerlendirme grubu bulunmaktadır. Karoların çıplak ayaklı kayma dayanımı sınıflandırması için en düşük kayma dayanım değeri A iken en yüksek olanı C'dir.

Çıplak ayaklı alanların kayma dayanım sınıflandırması ile ilgili aşağıdaki tabloda, uygulama alanları "DGUV Bilgileri 207-006 - Islak çıplak ayak alanlar için zemin kaplamaları" kitapçığına göre belirlenmiştir.

#### Wet barefoot areas slip resistance classification and application areas

Class	Min. degree of slope	Areas
<b>A</b>	12°	<ul style="list-style-type: none"><li>- Çıplak ayaklı geçişler ve sıhhi bölgeler (esas kuru olarak)</li><li>- Bireysel ve ortak giyinme odaları</li><li>- Eğer su derinliği tüm alanda 80 cm'den fazlaysa, yüzücüler için olmayan alanlardaki havuz zeminleri</li><li>- Sauna ve rahatlama alanları (esas olarak kuru olanlar)</li></ul>
<b>B</b>	18°	<ul style="list-style-type: none"><li>- Eğer grup A içinde sınıflandırılmamışsa çıplak alan geçişleri ve sıhhi alanlar</li><li>- Duşlar</li><li>- Buhar banyoları</li><li>- Dezenfektan sprey imkanları alanı</li><li>- Havuz çevreleri</li><li>- Belirli alanlarda su derinliği 80 cm'den azsa yüzücülerin olmadığı alandaki havuz zeminleri</li><li>- Dalga hareketli havuzlarda yüzücüler için olmayan alanlar</li><li>- Hareket edebilen zeminler</li><li>- Çocuk havuzları</li><li>- Eğer C grubu içinde sınıflandırılmamışsa havuz alanı dışındaki merdivenler ve basamaklar</li><li>- Eğer C grubu içinde sınıflandırılmamışsa dalış platformları ve dalış tahtalarının erişilebilir yüzeyleri</li><li>- Eğer A grubu içinde sınıflandırılmamışsa sauna ve rahatlama alanları</li></ul>
<b>C</b>	24°	<ul style="list-style-type: none"><li>- Suya gidiş merdivenleri ve basamakları</li><li>- Dalış alanlarına ve su kaydıraklarına giden merdiven basamakları</li><li>- Dalıcı için ayrılan uzunluk üzerindeki dalış platformlarının ve dalış tahtalarının yüzeyleri (Dalış platformlarının ve dalış tahtalarının kaymaya dayanıklı yüzeyleri dalıcıların ellerinin ve ayak parmaklarının kavradığı ön kısmı kaplamalıdır)</li><li>- İçinden yürünebilen havuzlar</li><li>- Eğimli havuz kenar tasarımları</li><li>- Kneipp havuzları, su basamak havuzları</li><li>- Havuzdaki rampalar alanı &gt; 6 % eğimi ile çevrelemektedir.</li></ul>

**Önemli not:** Belirlenen eğim açıları ürünün kaymazlık sınıflandırmasını tanımlamaya yardımcı olurlar ve bunlar eğimlerin / rampaların eğim açıları ile ilişkilendirilemezler.



## VitrA slip resistance

### 2. Pendulum

The pendulum CoF test (also known as the portable skid resistance tester, the British pendulum, and the TRRL pendulum) is the subject of a British Standard, BS 7976: Parts 1-3, 2002.

Information generated by the pendulum using Slider 96 rubber, also known as Four-S rubber (Standard Simulated Shoe Sole) is sufficient for assessing slipperiness in most circumstances. However, for assessing barefoot areas, unusually rough or profiled floors, the use of Slider 55 rubber, also known as TRRL rubber (a similar but softer, more malleable compound) may be advantageous.

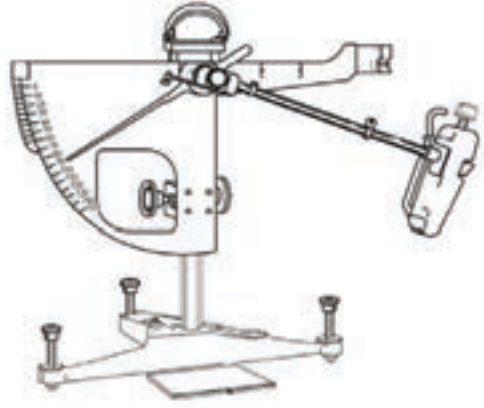

Pendulum CoF Test (Diagram adapted from BS 7976-1:2002 Pendulum testers - Part 1: Specification)

Slip Potential Classification, based on pendulum test values (PTV) (from UKSRG, 2011)	
	PTV
High Slip Potential	0-24
Moderate Slip Potential	25-35
Low Slip Potential	36 +

### 3. DCOF

DCOF is the ratio of the force necessary to keep a surface already in motion sliding over another divided by the weight (or normal force) of an object. This force is a materials property of the two surfaces. Contaminants such as dirt, water, soap, oil or grease can change this value. The test is done according to standards of ANSI A137.1 and ANSI A326.3.

Unless otherwise specified, tiles suitable for level interior spaces expected to be walked upon when wet shall have a wet DCOF of 0,42 or greater when tested using SLS solution. However, tiles with a DCOF of 0,42 or greater are not necessarily suitable for all projects. The specifier shall determine tiles appropriate for specific project conditions, considering by way of example, but not in limitation, type of use, traffic, expected contaminants, expected maintenance, expected wear and manufacturers' guidelines and recommendations. (Ref: ANSI A137.1-2017)

## VitrA tile size information

The tile format is given as a nominal dimension, which is calculated by the work size (aspired manufacturing size) plus the recommended joint width. The content within the box is printed as square-meter on box label and is calculated from the nominal size which is achieved with the use of appropriate joint width.

In the industrial manufacture of tiles, variations in the size (calibre) of the tiles are inevitable for Non-rectified tiles. The sizes are sorted, labelled and boxed separately. The calibre code is printed on each box label and specifies the actual size of the tile as below:



Label on the box

Information on the box

\*The labels shown are for information only and the contents of the labels are not binding.

## VitrA kayma dayanımı

### 2. Pendulum

Pendulum CoF testi (Ayrıca taşınabilir kayma direnci test cihazı, İngiliz pendulumu ve TRRL pendulumu olarak da adlandırılmıştır) bir İngiliz Standardı olan BS 7976: 1-3 kısımları, 2002'ye tabidir.

Four-S kauçuğu olarak da bilinen Slider 96 kauçuğu kullanılarak pendulumdan elde edilen bilgiler (Standart simüle edilen ayakkabı tabanı) ortamların çoğunda kayganlığın değerlendirilmesi için yeterlidir. Fakat çıplak ayaklı alanların değerlendirilmesinde, alışılmadık şekilde pürüzlü veya profilli olan zeminlerde TRRL kauçuğu olarak da bilinen Slider 55 kauçuğun kullanımı avantajlı olabilecektir (benzer ama daha yumuşak olan daha şekil verilebilir bir bileşen).

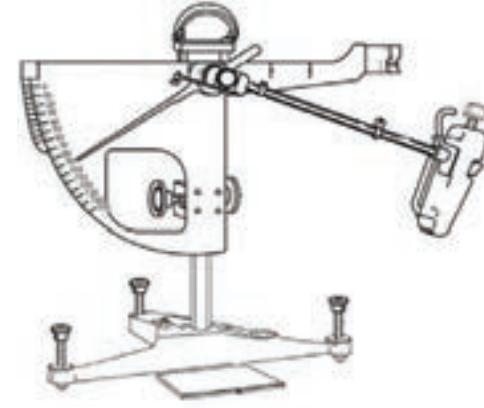

Pendulum CoF Testi (BS 7976-1:2002 Pendulum test cihazlarından uyarlanan diyagram - 1.Kısım: Özellikler)

(PTV) (UKSRG, 2011'den) Pendulum test değerlerine dayalı olarak kayma potansiyeli sınıflandırması	
	PTV
Yüksek Kayma Potansiyeli	0-24
Orta Düzeyde Kayma Potansiyeli	25-35
Düşük Düzeyde Kayma Potansiyeli	36 +

### 3. DCOF

DCOF, hareket halinde olan bir yüzeyin üzerinde bulunan yüzey üzerinden kayması için gereken gücün bir nesnenin ağırlığına (veya normal güç) bölünmesi ile elde edilen orandır. Bu güç iki yüzeyin maddesel özelliğidir. Kir, su, sabun, yağ veya motor yağı gibi kontaminasyonlar bu değeri değiştirebilirler. Test ANSI A137.1 ve ANSI A326.3 standartlarına göre yapılmaktadır.

Aksi belirtilmedikçe, yüzeyler ıslak olduklarında üzerinde yürünmeye uygun olan karolar SLS çözümü ile test edildiklerinden 0,42 veya daha büyük ıslaklık DCOF değerine sahip olacaklardır. Fakat DCOF değeri 0,42 veya üzerinde olan karoların tüm projeler için uygun olduğunu belirtmek mümkün değildir. Belli proje koşulları için uygun olan karolar, karo seçimini gerçekleştirirken belirlenmelidir. Örnek olarak kullanım çeşidi, trafik, beklenen kirlendiriciler, beklenen bakım, beklenen aşınma ve üreticilerin tavsiyeleri ve kılavuzları dikkate alınmalıdır. (Ref: ANSI A137.1-2017)

## VitrA karo ebat bilgileri

Karo boyutu, çalışma boyutu ve önerilen derz aralığı ile hesaplanan anma boyutu olarak ifade edilir. Kutu içindeki miktar, kutu etiketinde metrekare olarak basılır ve uygun derz aralığı ile döşenmesinden elde edilen anma boyutundan hesaplanır.

Endüstriyel karo üretiminde, karoların boyutlarındaki (kalibre) farklılıklar, rektifiye olmayan karolar için kaçınılmazdır. Boyutlar kalibrelerine göre ayrı ayrı sıralanır, etiketlenir ve kutulanır. Kalibre numarası her kutu etiketinde basılıdır ve aşağıdaki örnekte olduğu gibi karonun gerçek boyutunu ifade eder:

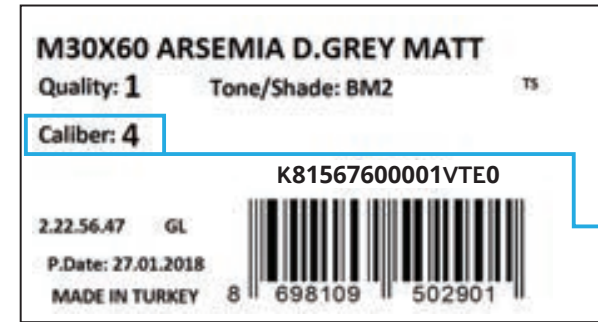

Kutu Üzeri Etiket

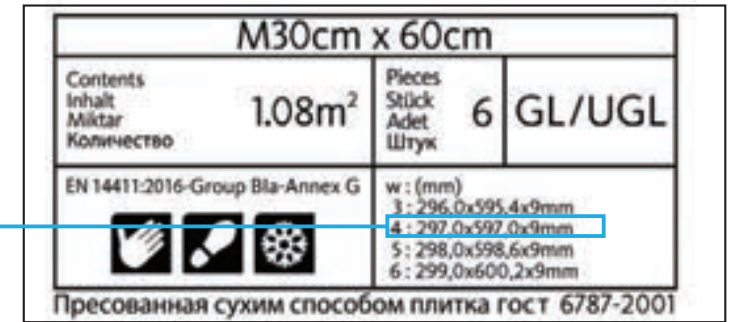

Kutu Üzeri Bilgi

\* Gösterilen etiketler sadece bilgi amaçlıdır ve etiketlerin içeriği bağlayıcı değildir.

## VitrA cleaning and care instructions

### 1. General information

VitrA Tiles are produced utilizing the most advanced equipment under extensive and strict process controls. Quality is assured with sourcing the finest raw materials available in the market. VitrA continuously focuses on maintaining its commitment to quality so that our products meet and exceed your expectations.

Market research studies and tests prove that ceramic displays excellent properties compared to other covering materials. Its long lasting beauty, ease of cleaning and high functionality are what makes ceramic tiles the most chosen covering material in both private and public areas. All glazed and unglazed materials are distinguished by surfaces which are ideal for easy cleaning. As with every covering material, our products require nominal care in order to maintain a satisfactory appearance and acceptable sanitation for years. As a company committed to sustainability, VitrA recommends the use of low VOC, non-hazardous, and non-polluting products for cleaning and maintaining tiles and grout.

Regular cleaning has to be planned according to the needs, depending on the degree of soiling and frequency of use: could be several times a day or once a day or once a week. For public use, shoe-scrapers, doormats and cleaning zones for shoes in front of the entrance of the building ensure that most dirt is left outside. VitrA recommends proper selection of such preventive elements for the sake of minimizing the use of cleaning agents and impact on environment. Before grouting, regardless of the grout colour chosen, always test a small area first to determine if the grout or grout pigment will affect the surface of the tile.

#### 1.1 Proper care during construction

Since VitrA products are considered to be a finish covering material, they should not be laid until all heavy construction is finished. Between the installation and putting the tiled area into service, it is imPerative to properly protect the tile and grout in order to avoid construction related cleaning problems. There is a build-up of dirt and debris on each construction site. This dirt and debris may cause the grout, and sometimes the tile, to be negatively affected. VitrA recommends that a protective cover be put over the tile surface to safeguard the appearance. This will insure a quality appearance when the floor is ready for use. The protective cover could be cardboard, plywood or any other clean soft-covering that will not damage the integrity of the installation. Do not use plastic as it may not allow the grout to properly cure, and it also may become extremely slippery as construction dust settles on the floor.

#### 1.2 Proper selection and use of cleaning agent

Use only recommended dilution of detergent. As an important rule, more is not always better; higher concentrations of detergent in the cleaning solution would only make it more difficult to rinse. However, hard water requires more frequent use of cleaning agents. When using any cleaning agent, please make sure to comply with the instructions for use and hazard indications of the cleaning agent manufacturer. VitrA does not assume any liability for damage incurred by non-compliance with these instructions and information. The detergent solution must be given time to act on the soil load. Generally 5-10 minutes is sufficient. Rinse thoroughly with clean, clear water to remove the dirty detergent solution and soil. Rinsing is a critical step in the maintenance procedure. Remove the rinse water with a wet vacuum, dry mop or towelling. If dirty detergent solution is not removed and is allowed to dry on the surface, a coating will form which is very difficult to remove.

##### 1.2.1. Warnings for proper selection and use of cleaning agent:

- 1) VitrA tiles are chemically resistant to both acidic and alkaline chemical products as defined in EN ISO 10545-13, with the exception of hydrofluoric acids or compounds containing fluoride salts and derivatives. Hydrofluoric acid is the only one that will attack tiles due to their molecular structure, even when diluted with plenty of water. All spills must be cleaned as quickly as possible
- 2) Never use a cleaning agent forming sticky grease, wax and synthetic layers on the tiles, which have a negative effect on the visual, hygienic, anti-slip and cleaning properties. The cleaning agent that is chosen should also be compatible with the grout at the same time. Always test a small area first with the selected cleaning agent.

#### 1.3 General cleaning procedure

The following principles apply for the cleaning procedure:

1. Selecting the appropriate cleaning agent.
2. Sweeping or vacuuming floor areas prior to cleaning to remove any dust or debris.
3. Leaving the cleaning agent to act for sufficient time upon the dirt and to loosen it.
4. Brushing or wiping mechanically.
5. Collecting, washing or sucking off the dirt separated from the tiles thoroughly.
6. Rinsing with water when the cleaning process is finished.
7. Removing the rinse water with a wet vacuum, dry mop or towelling.

Above are general recommendations. Any specific recommendations of cleaning agents, grout, grout removers etc. suggested by the individual manufacturer should be followed.

## VitrA temizlik ve bakım talimatları

### 1.Genel bilgiler

VitrA karolar, en gelişmiş ekipmanlar kullanılarak, kapsamlı ve sıkı önlemler ile takip edilen proses kontrolleri altında üretilmektedir. Piyasadaki en iyi hammaddelerin tedarik edilmesiyle kalite, güvence altına alınmıştır. VitrA, sürekli olarak kaliteye olan bağlılığını sürdürmeye odaklanmakta, böylece ürünlerimiz beklentilerinizi karşılamakta ve beklentilerinizin ötesine geçmektedir.

Pazar araştırma çalışmaları ve testler, seramiklerin diğer kaplama malzemelerine kıyasla mükemmel özellikler sergilediğini kanıtlamaktadır. Uzun ömürlü görsel güzelliği, temizlik kolaylığı ve yüksek işlevsellik, seramik karoları hem özel (kişisel kullanım) hem de kamusal alanlarda en çok tercih edilen yüzey döşeme malzemesi yapan şeydir. Tüm Sırlı ve sırsız karolar, kolay temizlik için ideal yüzey özellikleri ile ayırt edicidir. Her kaplama malzemesinde olduğu gibi, ürünlerimiz yıllarca tatmin edici temiz bir görünüm sağlamak için bakım gerektirir. Sürdürülebilirliğe önem veren bir şirket olarak VitrA, karo ve derzlerin temizlenmesi ve bakımı için düşük VOC, tehlikeli olmayan ve kirlletmeyen ürünlerin kullanılmasını önermektedir.

Düzenli temizlik; kirlilik derecesine ve kullanım sıklığına bağlı olarak ihtiyaçlara göre planlanmalıdır: günde birkaç kez veya günde bir kez veya haftada bir kez olabilir. Kamusal alanlardaki kullanımı için, ayakkabılardaki kirin binanın girişinin önünde bulunan çamurluk, paspaslar ve temizleme bölgeleri ile dışarıda kalması sağlanmalıdır. VitrA, temizlik maddelerinin kullanımını ve çevreye olan etkiyi en aza indirmek amacıyla bu tür kirlenmeyi önleyici öğelerin uygun şekilde seçilmesini önermektedir. Döşmeden önce, seçilen derz renginden bağımsız olarak, her zaman, harç veya harç pigmentinin karo yüzeyini etkileyip etkilemeyeceğini belirlemek için küçük bir alan test edilmelidir.

#### 1.1. Döşeme - inşaat sırasında bakım

VitrA ürünleri son kaplama malzemesi olarak kabul edildiğinden, tüm ağır işler bitene kadar döşenmemelidir. İnşaat kaynaklı temizlik sorunlarından kaçınmak için döşenen alan kullanıma açık hale gelene kadar döşenen alandaki karoları ve derz dolgularını uygun bir şekilde korumak gereklidir. Her şantiyede kir ve kalıntı birikir ve bu biriken kirler/kalıntılar, derzin ve bazen de karoların olumsuz etkilenmesine neden olabilir. VitrA, bu durumu önlemek ve döşendikten sonraki görünümü korumak için döşeme alanı üzerine koruyucu bir malzeme serilmesini önerir. Bu sayede döşenmiş alanın kalitesi kullanıma hazır oluncaya kadar korunacaktır. Koruyucu malzeme olarak mukavva, karton, kontrplak veya döşemenin bütünlüğüne zarar vermeyecek herhangi temiz ve yumuşak bir malzeme kullanılabilir. Derzlerin düzgün bir şekilde kuruyup sertleşmesine izin vermeyeceği ve inşaat tozunun üzerine yapışarak kaygan bir alan oluşturabileceği için plastik korumalar kullanılmamalıdır.

#### 1.2. Uygun malzeme seçimi ve temizleme maddesi kullanımı

Sadece önerilen miktarda seyreltilmiş deterjan kullanılmalıdır. Unutulmamalıdır ki temizlik malzemelerinin fazlası her zaman için iyi değildir; temizleme çözeltilsinde daha yüksek deterjan konsantrasyonları kullanmak durulamayı zorlaştıracaktır. Bununla birlikte, suyun sertliğinin artması daha fazla temizlik maddelerinin kullanılmasına neden olur. Herhangi bir temizlik maddesini kullanırken, lütfen temizlik maddesi üreticisinin kullanım ve tehlike göstergelerine uygun olarak kullanıldığından emin olun. VitrA, temizlik maddesi üreticileri tarafından verilen talimatlara ve bilgilere uyulmamasından kaynaklanan hasarlar için herhangi bir sorumluluk kabul etmemektedir. Kirliliğe etki etmesi için temizlik maddeleri kirli alan üzerinde bir süre bekletilmelidir. Genellikle 5-10 dakika yeterlidir. Kirli alandaki deterjanı ve kirleri arındırmak ve temizlemek için temiz su ile bölgeyi iyice durulayın. Durulama, bakım prosedüründe kritik bir adımdır. Durulama için kullanılan suyu yerden vakumla, kuru paspasla veya bezle temizleyin. Kirli deterjan solüsyonu durulanmazsa ve yüzeyde kurumaya bırakılırsa, yüzey üzerinde çıkarılması çok zor olan bir kaplama oluşacaktır.

##### 1.2.1. Temizlik maddelerinin uygun seçimi ve kullanımı için uyarılar:

- 1) VitrA karolar, hidroflik asitler veya florür tuzları ve türevleri içeren bileşikler dışında, EN ISO 10545-13'te tanımlanan hem asidik hem de alkali kimyasallara dayanıklıdır. Hidroflorik asit, bol su ile seyreltildiğinde bile, moleküler yapıları nedeniyle karolara zarar veren tek örnektir. Herhangi bir malzeme döküldüğünde mümkün olduğunca çabuk temizlenmelidir.
- 2) Karolar üzerinde görsel, hijyenik, kayma dayanımı ve temizleme özelliklerini olumsuz etkileyecek, yapışkan yağlı, mumsu ve sentetik tabakalar oluşturacak bir temizlik maddesi kullanmayın. Seçilen temizlik maddesi aynı zamanda harçla da uyumlu olmalıdır. Her zaman kullanım öncesi seçilen temizlik maddesiyle küçük bir alan test edilmelidir.

#### 1.3.Genel temizlik talimatları

Temizlik prosedürü için aşağıdaki kurallara uyulmalıdır:

1. Uygun temizlik maddesi seçilmelidir.
2. Toz veya kalıntıları temizlemek için temizlikten önce zemin süpürülmelidir.
3. Temizlik maddesi kir üzerine temas etmesi ve yok etmesi için yeterli süre üzerinde bekletilmelidir.
4. Mekanik bir fırçalama işlemi veya silme işlemi yapılmalıdır.
5. Karolardan çıkan kirler toplanmalı, yıkanmalı veya vakumlanmalıdır.
6. Temizleme işlemi bittiğinde su ile durulanmalıdır.
7. Durulama suyu ıslak bir vakum, kuru paspas veya bez ile alınmalıdır.

Yukarıda bahsi geçen prosedür içeriği genel önerileri kapsamaktadır. Bireyse üreticiler tarafından önerilen temizlik maddeleri, derz, derz temizleyiciler vb. özel tavsiyeler uygulanmalıdır.



## VitrA cleaning and care instructions

### 2. First cleaning after installation

The first step for maintenance is complete removal of grout and construction dirt after tiles are laid. To remove the grout from the surface, there are many products available in the market. These products can be diluted for removal of light deposits of grouting materials with the possibility of using higher concentrations when aggressive cleaning is required. Grout manufacturers print instructions for proper mixing, curing, and cleaning of grout on packaging, these must be followed. This cleaning must be carried out after the cement grout has dried out, which takes at least 24-48 hours for quicksetting and quick-drying products. In any case the grout manufacturer's instructions must be followed. In most cases, VitrA tiles can be cleaned successfully by scrubbing the installation with hot water and a neutral detergent, followed by a thorough rinsing and then removing the rinse water with a wet vacuum, mop or dry towelling. If grout residue still remains, further cleaning of the tile should be accomplished in consultation with the grout manufacturer. Once the initial cleaning has been thoroughly completed, daily maintenance procedures can be followed for continuous and long-lasting beauty.

For polished Porcelain tiles, following the completion of the grouting process, the tile surface can be cleaned and any excess protective sealer removed. Use dry and wet cloth (such as MICROFIBER) in order to remove excess, if needed, add neutral detergent according to manufacturer's instruction, help removing the residue. Always test a small area first. Wipe up the residue with a cotton towel or sponge. Rinse thoroughly with clean water.

In the case of anti-slip surfaces, mechanical cleaning by means of brushing machines with rotating soft nylon brushes or microfiber as well as high-pressure or vapour pressure cleaners is most effective, whereby joints must be cared during cleaning process. During the cleaning do not use improper pads or brushes with abrasive grain as they can significantly weaken non-slip safety!

#### 2.1 General first cleaning after installation procedure

Cleaning should be carried out by the professionals who have installed the material:

1. Sweep/vacuum the floor thoroughly to remove construction dust
2. Dilute the cement film remover in water as instructed on the package
3. Apply the cleaning product with an ordinary mop
4. Leave to act for a few minutes
5. Rub the zones with the toughest deposits hard with an abrasive sponge such as Scotch-Brite
6. Wipe up the residues using cloth and rinse with plenty of clean water and dry with mop, wet vacuum or towel.

#### Warnings for first cleaning after installation:

- 1) First cleaning after installation can damage objects close to the tiled area; such as doors, metallic objects and finishes; it is recommended to protect these before starting the cleaning oPeration.
- 2) Acid cleaners attack cement joints. Therefore, protect the joints by dampening with water and thoroughly rinse the covering with clear water after the use of acid cleaners, neutralise if possible. When using epoxy grouts, use a specially formulated cleaner and strictly follow the manufacturer's instructions for preparation, application and cleaning.
- 3) Especially for metallic tiles and tiles with metallic decors, use only non-acidic grout cleaners, always handle with maximum care. Water should be first option. If a stronger cleaning is needed clean with alcohol and a soft cloth or alternatively use a neutral PH. Avoid abrasive, acidic or alkaline cleaning products. Use a slightly damp sponge to clean the tile joints, passing it diagonally across them. Do not use dirty water.
- 4) Never clean tiles that are too hot (e.g. exposed to sunlight during hot summer days) since the reaction of chemicals may become harsher. In the summer, cleaning should be done during the coolest period of the day especially on areas exposed to direct sunlight.

### 3. Regular cleaning

#### 3.0. General rules

Two methods are customarily used:

- 1) Manual cleaning using a broom, scrubbing brush or a mop.
- 2) Machine cleaning using a disc machine, scrubbing suction machine or high-pressure cleaner with spray injection.

Manual cleaning is recommended for only little dirt. When machines are used, single-disc or multi-disc machines or brush/scrubber suction machines are most effective options. High-pressure cleaners with spray injection are particularly suitable for slip-resistant surfaces. Which is the most rational method for these surfaces.

## VitrA temizlik ve bakım talimatları

### 2. Döşeme sonrası ilk temizlik

Bakım için ilk adım, karo döşendikten sonra harç ve inşaat kirinin tamamen temizlenmesidir. Derzleri yüzeyden çıkarmak için piyasada birçok ürün bulunmaktadır. Bu ürünler, yoğun temizlik gerektiğinde daha yüksek konsantrasyonlar kullanma olasılığı ile derz dolgu malzemelerinin daha az birikmesi için seyretililebilirler. Derz üreticileri tarafından ambalaj üzerinde harçların uygun şekilde karıştırılması, sertleşmesi ve temizlenmesi için talimatlar yazılır, bu talimatlar uygulanmalıdır. Temizleme işlemi; çimento harçları kuruduktan sonra yapılmalıdır. Çabuk kuruyan ürünler için en az 24-48 saat sonra yapılmalıdır. Her koşulda, derz üreticisinin talimatları takip edilmelidir. VitrA karolar, çoğu durumda, sıcak su ve nötr bir deterjan ile ovularak temizlenir, ardından iyice durulanır ve daha sonra durulama suyunun ıslak vakum, paspas veya kuru havlu ile çıkarılması sağlanmalıdır. Derz kalıntısı hala mevcut ise, karonun temizlenmesi, derz üreticisine danışılarak gerçekleştirilmelidir. İlk temizlik tamamlandıktan sonra, sürekli ve uzun ömürlü güzel görünüm için günlük bakım prosedürleri takip edilmelidir.

Parlatılmış Porselen karolar için, derz işleminin tamamlanmasından sonra, karo yüzeyi temizlenebilir ve yüzeydeki fazla koruyucu kaplama maddesi çıkarılabilir. Gerekirse yüzeydeki fazlalığı gidermek için kuru ve ıslak bir bez kullanılmalıdır (örn. MICROFIBER), üreticinin talimatlarına göre nötr deterjan eklenmeli, kalıntıların giderilmesi sağlanmalıdır. Her zaman önce küçük bir alan test edilmelidir. Kalıntı, pamuklu bir havlu/bez veya süngerle silinmeli ve temiz su ile iyice durulanmalıdır.

Kayma dayanımı olan yüzeylerde, dönen yumuşak naylon fırçalar veya mikrofiber içeren fırçalama makinelerinin yanı sıra yüksek basınçlı veya buhar basınçlı temizleyiciler ile mekanik temizlik en etkili yöntemdir, bu sayede temizlik işlemi sırasında derzler korunmaktadır. Temizlik sırasında kayma dayanımını önemli ölçüde zayıflatabilecekleri için aşındırıcı taneli, uygun olmayan ped veya fırça kullanılmamalıdır!

#### 2.1. Döşeme sonrası genel ilk temizlik talimatı

Temizlik işlemi, döşemeyi yapmış profesyoneller tarafından yapılmalıdır:

1. İnşaat tozunu temizlemek için zemin iyice süpürülmelidir.
2. Çimento film temizleyici, pakette belirtildiği şekilde suyla seyretilmelidir.
3. Temizlik ürünü sıradan bir paspas ile uygulanmalıdır.
4. Etki etmesi için birkaç dakika beklenmelidir.
5. Scotch-Brite gibi aşındırıcı bir süngerle sertleşmiş bölgeler ovalanmalıdır.
6. Kalıntılar bezle silinmeli ve bolca temiz su ile durulmalı ve paspas, ıslak vakum veya havlu ile kurulanmalıdır.

#### 2.1.1. Döşeme sonrası ilk temizlik için uyarılar:

- 1) Döşeme sonrası ilk temizlik, karo ile döşenmiş alana yakın nesnelere; kapılar, metalik objeler ve cilalar vb. zarar verebilir. Temizlik işlemine başlamadan önce bunların korunması tavsiye edilir.
- 2) Asit içerikli temizleyiciler çimento derzlerine etki eder. Bu nedenle derzler su ile nemlendirerek korunmalı ve asit temizleyicileri kullanıldıktan sonra kaplama temiz suyla iyice durulanmalı, mümkünse nötr hale getirilmelidir. Epoksi harçlar kullanılırken, özel olarak formüle edilmiş bir temizleyici kullanılmalı ve harç üreticisinin hazırlık, uygulama ve temizlik için talimatları uygulanmalıdır.
- 3) Özellikle metalik karolar ve metalik dekorlu karolar için, asidik olmayan derz temizleyicileri kullanılmalı, daima maksimum özen gösterilmelidir. Temizlik için ilk seçenek su olmalıdır. Daha güçlü bir temizleme gerekirse, alkol ve yumuşak bir bezle temizlenmeli veya alternatif olarak nötr PH içeren temizlik malzemeleri kullanılmalıdır. Aşındırıcı, asidik veya alkali temizlik ürünlerinden kaçınılmalıdır. Karo derzlerini temizlemek için hafifçe nemli bir sünger kullanılmalı ve diyagonal olarak uygulanmalıdır. Kirli su kullanılmamalıdır.
- 4) Sıcak ile birlikte kimyasalların reaksiyonu daha sert/aşındırıcı hale gelebileceğinden, çok sıcak olan (sıcak yaz günlerinde güneş ışığına maruz kalan) karolar asla temizlenmemelidir. Yaz aylarında, günün en serin döneminde, özellikle doğrudan güneş ışığına maruz kalınmayan zamanlarda temizlik yapılmalıdır.

### 3. Düzenli temizlik

#### 3.0. Genel kurallar

Genellikle iki yöntem kullanılır:

- 1) Süpürge, ovma fırçası veya paspas kullanılarak manuel olarak yapılan temizlik.
- 2) Makine yardımıyla temizleme; bir disk makinesi, vakum makinesi veya yüksek basınçlı temizleyiciyi sprey enjeksiyonuyla temizleme. Elle temizlik sadece az miktardaki kirler için önerilir. Makineler kullanıldığında, tek diskli veya çok diskli makineler veya fırça/ovalayıcı vakum makineleri en etkili seçeneklerdir. Sprey enjeksiyonlu yüksek basınçlı temizleyiciler, kaymaya dayanıklı yüzeyler için özellikle uygundur.

## VitrA cleaning and care instructions

### 3.0.1. Warnings for regular cleaning:

- 1) All of the information provided about cleaning, care and removing stains from ceramic tiles is based on the latest knowledge and material. It is, however, a general information and cannot cover every single possibility. Therefore, please pay attention to the instructions provided by the cleaning agent and grout manufacturer.
- 2) Routine cleaners should never contain acids or ammonia. Acids can damage the grout and the glazed surface of the tile, and ammonia can discolour the grout.
- 3) Film-forming cleaning agents should not be used as they can considerably reduce or even neutralise the slip resistance of ceramic coverings, and can also cause staining.
- 4) With high-pressure cleaners there is a slight danger of washing out and destroying cement joints if the machine is not used correctly (pressure too high because water jet is too close to surface). Using of unsuitable cleaning agents, e.g. acidic cleansers for cleaning increases this effect.
- 5) Where underfloor heating systems are installed, it is particularly important to ensure that the removed dirt and dirty water is cleaned before it is able to dry again when heating is on.

### 3.1. Unglazed tiles

VitrA unglazed tiles has a protective glaze finish that is not a glaze, but rather a special surface preparation sprayed on the tile before firing. During the manufacturing process, the structure of the tile surface is sealed with a protective glaze in order to further increase the tiles' resistance to staining and dirt, as a result of which subsequent treatment with impregnating agents is no longer necessary. The following represents a simple procedure for maintaining protective glaze coating and unpolished matte finish tile floors with a moderate soil load. For best results:

1. Sweep or vacuum the floor of all loose dirt and other foreign materials.
2. Saturate the floor with a mild cleaning solution and hot water, agitate, and allow it to dwell (remain on the floor) 5-10 minutes. Do not allow cleaning solutions to dry. It may be best to complete small areas at a time.
3. Clean routinely with tile cleaners that have a neutral pH for safe regular use.
4. Remove the dirty cleaning solution and rinse the surface with clean, clear water.
5. Buff with a dry mop or towel.

### 3.2. Glazed tiles

Wall tiles should be cleaned routinely with an all-purpose, non-oil-based household or commercial cleaner. The type of product may vary depending on the tile application and use. A multipurpose spray cleaner, which removes soap residue, hard water deposits and dirt designed for everyday use can be used on Wall tiles. Floor tiles should be cleaned and scrubbed with cleaner solution through the use of a cotton mop, cloth, sponge, or non-metallic brush.

Important Notice: Strongly alkaline or strongly acidic cleaning agents can attack or destroy the surface of glazed tiles and joints and must therefore not be used!

### 3.3. Polished porcelain

VitrA Protect is applied to the surfaces of the polished Porcelain tiles at the factory, improving the resistance to staining and soiling. VitrA does not recommend subsequent treatment with impregnating agents.

**Important Notice:** Dry thoroughly with a soft cloth after cleaning is completed to increase the shine and prevent water spots.

### 3.4. VitrA clean surface

The VitrA Clean finish was developed to achieve an easy-care tile surface by VitrA Innovation Center.

Dirt particles are virtually unable to hold and flow off with the water droplets on Wall tiles with VitrA Clean application. Water and a soft cloth are sufficient for routine cleaning without a need for aggressive detergents.

### 3.5. Antislip tiles

VitrA product range includes a great number of anti-slip glazed and unglazed series. These products are perfectly suitable for use in commercial, industrial and public areas as well as in wet barefoot areas such as swimming pools, showers and saunas. They have smooth, micro-rough or relief-type surfaces, depending on the area of application. In the case of anti-slip surfaces, mechanical cleaning by means of brushing machines with rotating soft nylon brushes or microfiber as well as high-pressure or vapour pressure cleaners is most effective, whereby joints must be cared during cleaning process. Cleaning agents, equipment and methods must be selected due to type of soiling and area of application. An extensive cleaning is required compared to smooth, glazed surfaces.

## VitrA temizlik ve bakım talimatları

### 3.0.1. Düzenli temizlik için uyarılar:

- 1) Seramik karolara dair verilen temizlik, bakım ve lekelerin çıkarılması ile ilgili tüm bilgilerde, en son öğrenilmiş olan bilgi ve malzemeler temel alınmaktadır. Bu nedenle, genel bir bilgidir ve her bir olasılığı kapsamamaktadır. Temizlik maddesi ve derz imalatçısı tarafından sağlanan talimatlara dikkat edilmelidir.
- 2) Rutin temizleyiciler asla asit veya amonyak içermemelidir. Asitler karonun Sırlı yüzeyine ve derze zarar verebilir; amonyak, derzin rengini bozabilir.
- 3) Film oluşturuvcu temizlik maddeleri, seramik kaplamaların kayma dayanımını önemli ölçüde azaltabilen, hatta yok edebilecekleri ve lekelenmeye neden olabileceği için kullanılmamalıdır.
- 4) Yüksek basınçlı temizleyicilerde, makine doğru kullanılmadığında (su jeti yüzeye çok yakın olduğu için basınç çok yüksekse) çimento derzlerini su ile çıkarılması ve zarar görmesi gibi bir tehlike söz konusudur. Uygun olmayan temizlik maddelerinin kullanılması, örneğin temizlik için asidik temizleyiciler bu etkiyi artırır.
- 5) Yerden ısıtma sistemlerinin olduğu yerlerde, ısıtma açıkken kir ve kirlı suyun kurumadan temizlenmesi özellikle önemlidir.

### 3.1. Sırsız karolar

VitrA sırsız karolar, koruyucu bir sırla kaplıdır, bu kaplama pişirimden önce sırdan farklı olarak karo üzerine püskürtülen özel bir yüzey hazırlık uygulamasıdır. Üretim işlemi sırasında, karo yüzeyinin yapısı, karonun lekelenmeye ve kirlenmeye karşı direncini daha da arttırmak için koruyucu bir malzeme ile kaplanır ve bunun sonucunda, emprenye maddesi ile ikincil işlemlere gerek kalmaz. Aşağıda bulunan temel temizlik prosedürü, koruyucu sırlı kaplı ve sırsız mat karolar için orta seviyedeki kirlenmelerde uygulanır. En iyi sonuçlar için aşağıdaki uygulamalara göre temizlik yapılması önerilir:

- 1) Tüm hafif tozlar, kirler ve diğer yabancı maddeler süpürülmeli veya vakumlanmalıdır.
- 2) Zemin yumuşak bir temizleme solüsyonu ve sıcak su ile doyurulmalı, iyice karıştırılmalı/dağıtılmalı ve 5-10 dakika bekletilmelidir (yüzeyde kalması sağlanmalı). Temizleme solüsyonlarının kurumasına izin verilmemelidir. Tek seferde küçük alanları tamamlayarak ilerlemek en iyisidir.
- 3) Düzenli kullanımda nötr pH değerine sahip karo temizleyicilerle rutin olarak temizlenmelidir.
- 4) Kirlı temizleme solüsyonu yüzeyden temizlenmeli, berrak su ile durulanmalıdır.
- 5) Kuru bir paspas veya havlu ile son işlem olarak yüzey kurulanmalıdır.

### 3.2. Sırlı karolar

Duvar karoları, çok amaçlı, yağ bazlı olmayan temizlik kimyasalı ile rutin olarak temizlenmelidir. Temizleyici tipi, karo uygulamasına ve kullanımına bağlı olarak değişebilir. Duvar karolarında, sabun kalıntılarını, sert su birikintilerini ve günlük kullanımda oluşan kirleri temizleyen çok amaçlı bir sprey temizleyici kullanılabilir. Yer karoları, pamuklu paspas, bez, sünger veya metalik olmayan fırça kullanılarak bir temizlik solüsyonu yardımı ile temizlenmelidir.

Önemli Uyarı: Kuvvetli alkali veya kuvvetli asidik temizlik maddeleri, Sırlı karoların yüzeyine ve derzlere zarar verip tahrip edebilir, bu nedenle bu tür temizlik maddeleri kullanılmamalıdır!

### 3.3. Parlatılmış porselen karolar

VitrA Protect, parlatılmış Porselen karoların yüzeyine fabrikada üretim esnasında uygulanır, karolardaki leke ve kirlenmeye karşı direnci artırır. VitrA, emprenye kimyasalları/maddeleriyle yapılan ikincil işlemleri önermez. Önemli Uyarı: Parlaklığı arttırmak ve su lekelerini önlemek için temizlik tamamlandıktan sonra yumuşak bir bezle iyice kurulayın.

### 3.4. VitrA Clean uygulanmış karolar

VitrA Clean, VitrA İnovasyon Merkezi tarafından kolay bakım yapılabilen bir yüzey elde etmek için geliştirilmiştir. Kir parçacıkları, VitrA Clean uygulaması ile Duvar karoları üzerinde tutunamaz ve su damlacıkları ile akar. Su ve yumuşak bir bez yardımı ile yoğun deterjanlara ihtiyaç duymadan rutin temizlik yapılabilir.

### 3.5. Kayma direnci olan karolar

VitrA ürün yelpazesinde çok sayıda kaydırmaz özellikli Sırlı ve sırsız ürün bulunmaktadır. Bu ürünler ticari, endüstriyel, kamusal alanlarda ve yüzme havuzları, duşlar, saunalar gibi ıslak alanlarda kullanım için uygundur. Uygulama alanına bağlı olarak pürüzsüz, mikro-pürüzlü veya rölyef tipi yüzeylere sahiptirler. Kaydırmaz yüzeylerde, dönen yumuşak naylon veya mikrofiber fırçalı yüzey temizleme makinelerinin yanı sıra yüksek veya buhar basınçlı temizleyiciler ile mekanik temizlik en etkili yöntemdir. Bu sayede temizlik işlemi sırasında derzlere zarar verilmemektedir. Kirlenme ve uygulama alanlarına göre temizlik maddeleri, ekipman ve yöntemler belirlenmelidir. Pürüzsüz, Sırlı yüzeylere kıyasla kapsamlı bir temizlik gereklidir.



## VitrA cleaning and care instructions

A selection of suitable cleaning agents is outlined in the RK List (list of tested cleaning agents for ceramic surfaces in swimming pools) supplied by the German Society for the Pool Industry. In any case, the instructions for use and hazard warnings provided by the respective manufacturer must be respected.

There are several recommended good ways of cleaning this type of floor surface:

- High-pressure cleaning equipment (Pressure washers or high-pressure hoses).
- Vapour steam cleaners.
- Disc cleaners
- Scrubbing the surface with a brush with hard plastic bristles and then rinsing it with plenty of clean water.

### 3.5.1. Warnings for antislip tiles cleaning:

- 1) Brushes or pads containing abrasives must not be used under any circumstances, as they reduce slip resistance.
- 2) When using disc machines, suitable pads must be used, particularly on slip-resistant tile coverings in order to prevent cleaning from impairing the slip resistance. The slip-resistant properties are achieved through the roughness of the tile's surface or by means of relief-type profiling.
- 3) Whichever cleaning system is used, it is important to use clean water because otherwise, when the water evaporates, small particles of dirt from the water will be deposited in lower, more inaccessible parts of the embossed surface. For good results, it is essential to rinse with plenty of water.
- 4) Cleaning agent may cause the floor to become slipperier, therefore they should be rinsed thoroughly to avoid forming a greasy layer which negatively affects anti-slip safety. When anti-slip floor tiles are cleaned, whatever their surface finish, it is not sufficient to clean them with damp mopping, because it will not clean away any dirt embedded in the particles that give the tiles their anti-slip finish. This means that dirt will build up, spoiling the overall appearance of the floor surface and normally modifying the colour slightly.
- 5) Alkaline cleaning agents should be used for basic cleaning and regular maintenance cleaning. Where water is soft, only occasional acidic cleaning is necessary (weekly or monthly depending on the flow of water and water hardness). Hard water requires more frequent use of cleaning agents.

## 3.6. Metallic tiles/decors

Some tiles are made out of metal-containing decoration which gives a shiny appearance with a silver / platinum / gold / copper effect. These tiles are indicated in the catalogue. For these tiles, extreme care must be taken during their installation, first cleaning after installation and general cleaning. Avoid using abrasive cleaners that can scratch and damage the surface. VitrA recommends using a soft cloth with water and alcohol. After cleaning, dry the surface with a clean cotton cloth to avoid water mark.

**Important Notice:** Never install metallic tiles/decors in wet areas such as showers, baths.

## 3.7. Photocatalytic tiles

The same products can be used for cleaning as for similar tiles without photocatalytic coating - with the advantage that the concentration of the cleaning agent can be considerably lower.

Any cleaning material forming a film or a greasy or sticky layer on the tile would impair the effectiveness of photocatalytic and must be avoided as they impede the incidence of light onto the tile surface.

It is very important to thoroughly remove cleaning and disinfecting agents.

\* You can find most recent information about our products, Warranty Conditions, Cleaning and Care Instructions, along with other Product Performance Data and Installation specifications at:  
[www.vitra.com.tr](http://www.vitra.com.tr) / <https://vitraglobal.com/>

## VitrA temizlik ve bakım talimatları

Havuz Endüstrisi için Alman Topluluğu tarafından sağlanan RK Listesinde (yüzme havuzlarındaki seramik yüzeyler için test edilmiş temizlik maddelerinin listesi) uygun temizlik maddelerinin seçimi anlatılmıştır. İlgili üretici tarafından verilen kullanım ve tehlike uyarılarına uyulmalıdır. Bu tür zemin yüzeyini temizlemek için önerilen birkaç yol vardır:

- Yüksek basınçlı temizlik ekipmanları (Basınçlı yıkayıcılar veya yüksek basınçlı hortumlar).
- Buharlı temizleyiciler
- Diskli yer temizleyiciler
- Yüzeysel aşındırıcı olmayan sert plastik bir fırça ile ovalamak (kayma direncine zarar vermeden) ve bolca temiz su ile durulamak

### 3.5.1. Kaydırmaz özellikli karoların temizliği için uyarılar:

- 1) Aşındırıcı özellikli fırçalar, pedler veya bezler, kayma direncini azalttığı için hiçbir koşulda kullanılmamalıdır.
- 2) Yer temizleme/cilalama makineleri, kayma dayanım özelliğini azaltmaması için kaymaya karşı dayanıklı karolara uygun olarak kullanılmalıdır. Kayma dayanım özelliği, karo yüzeyinin pürüzlülüğü veya rölyef ile elde edilir.
- 3) Tüm temizliklerde, temiz su kullanılması önemlidir. Aksi takdirde su buharlaştığı zaman, sudaki küçük kir parçacıkları yüzeyin daha az erişilebilen kısımlarına ulaşacak ve orada kirler kalacaktır. İyi sonuçlar elde etmek için yüzeyin bol su ile durulanması gerekir.
- 4) Temizleme maddesi zeminin kayganlaşmasına neden olabilir. Bu nedenle, kaymaya sebep olan ve kayma direncini olumsuz yönde etkileyen yağlı bir tabakanın oluşmasını önlemek için yüzeydeki temizlik maddesi iyice durulanmalıdır. Kaydırmaz özellikli yer karoları temizlendiğinde, yüzeyleri nasıl olursa olsun, bunları nemli paspas ile temizlemek yeterli değildir, çünkü karolarda kayma direncini sağlayan parçacıklara gömülmüş kirleri temizlemeyecektir. Bu da kirlerin birikerek yüzeyinin genel görünümünü bozmasına ve rengin biraz değişmesine neden olacaktır.
- 5) Temel ve düzenli bakımda alkali temizlik malzemeleri kullanılmalıdır. Eğer temizlik için kullanılan su yumuşaksa, daha az sıklıkta (su ve suyun sertliğine bağlı olarak haftalık veya aylık) yüzeye zarar vermeyen asidik temizlik malzemeleri kullanmak gerekir. Sert su, daha fazla temizlik kimyasalına ihtiyaç duymaya neden olur.

## 3.6. Metalik karolar/dekorlar

Bazı karolar üzerinde gümüş / platin / altın / bakır etkisi ile parlak bir görünüm veren metal dekorlar bulunmaktadır. Bu karolar kataloglarda belirtilmiştir ve döşeme sırasında, döşeme sonrası ilk temizlikte ve genel temizliklerde çok dikkatli ve özenli olunmalıdır. Yüzeysel çizilecek ve zarar verebilecek aşındırıcı temizleyiciler kullanılmamalıdır. VitrA, su ve alkol ile yumuşak bir bez kullanmanızı önerir. Temizledikten sonra, su lekelerini önlemek için yüzey temiz bir pamuklu bezle kurulanmalıdır.

Önemli Uyarı: Metalik karolar / dekorlar asla duş, banyo gibi ıslak mekanlarda kullanılmamalıdır.

## 3.7. Fotokatalitik karolar

Temizlik için, fotokatalitik kaplama içermeyen diğer karolarda kullanılan ürünler kullanılabilir - daha düşük konstrasyona sahip temizlik maddeleri de yeterli olabilmektedir. Karo üzerinde bir film, yağlı ya da yapışkan bir tabaka oluşturan herhangi bir temizlik malzemesi, fotokatalitik etkiyi bozar ve bu tür tabaka oluşturan malzemeler karo yüzeyinin ışık almasını engeller. Bahsi geçen uygulamalar, bu tür karoların özelliklerini azaltacağından yapılmamalıdır. Temizlik için kullanılan malzemeleri iyice durulamak ve yüzeyden arındırmak çok önemlidir.

\*Ürünle ilgili teknik bilgiler, döşeme talimatları, garanti koşulları, temizlik ve bakım talimatlarıyla ilgili güncel bilgiler VitrA web sitesinde yer almaktadır:  
[www.vitra.com.tr](http://www.vitra.com.tr) / <https://vitraglobal.com/>

## CE marking – declaration of performance and VOC label

The CE marking indicates that a construction product conforms its declared performance and it has been assessed according to a harmonised European standard. The CE mark is the safety product certification required by EU and it is finalized to preserve the people's health and the goods in buildings. The CE marking of the Vitra products is prepared according to the Annex V of the Regulation (EU) No 305/2011 (amended by Delegated Regulation EU No 568/2017)



All the declaration of performances of the Vitra products are prepared according to model provided in Delegated Regulation EU No 574/2014. Ceramic tiles do not require to be tested for reaction to fire (System 1) and are classified without testing (according to Commission Decision 96/603/EC).

Vitra DoPs are available on the catalogues and on the website:  
<https://www.vitra.com.tr/performans-banyo-karo/>

Volatile organic compounds (VOCs) are emitted as gases under certain conditions (i.e. excessively high pressure etc.) from certain solids or liquids. The boiling range of VOCs is between 50-100 °C and 240-260 °C. Ceramic tiles are manufactured at temperatures higher than 1100 °C and as a result of this high temperature process condition, the product no longer contains VOC substances. Since 1 September 2012 in France, all building products have to be labelled with an emissions classification on the basis of VOC emissions tests. As emission-neutral products, they are classified as A+. This label can be found on the boxes.

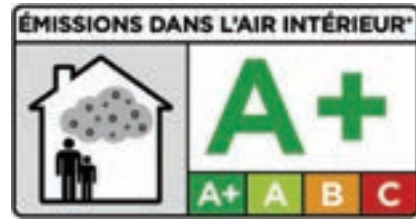

\*Information sur le niveau d'émission de substances volatiles dans l'air intérieur, présentant un risque de toxicité par inhalation, sur une échelle de classe allant de A+ (très faibles émissions) à C (fortes émissions).



## CE markalaması – performans beyanı ve VOC etiketi

CE markalaması bir ürünün beyan edilen performansına uygun olduğunu ve uyumlandırılan Avrupa standardına göre değerlendirildiğini göstermektedir. CE işareti AB için gerekli olan güvenli ürün sertifikalandırmasıdır ve insanların sağlığını ve binalardaki ürünleri korumak için oluşturulmuştur. Vitra ürünlerinin CE markalaması No 305/2011 no.lu Yönetmeliğin (AB) Ek V kısmına göre hazırlanmıştır. (568/2017 no.lu Delege edilen AB Yönetmeliğine göre değiştirilmiştir.)



Vitra ürünlerinin performanslarının beyanı 574/2014 no.lu delege edilen AB yönetmeliğinde sunulan modele göre hazırlanmıştır. Seramik karoların yangın reaksiyonu (1.Sistem) için test edilmesi gerekli değildir ve bunlar test edilmeden sınıflandırılmaktadır (96/603/EC Komite kararına göre).

Vitra DoP'ları kataloglarda ve aşağıdaki web sitesinde mevcuttur:  
<https://www.vitra.com.tr/performans-banyo-karo/>

Uçucu organik bileşenler (VOC'ler) belirli koşullarda belli katı ve sıvılardan gaz olarak atılırlar (Örneğin fazla yüksek basınç altında vb.). VOC'lerin kaynama aralığı 50-100 °C ve 240-260 °C aralıklarındadır. Seramik karolar 1100 °C'nin üzerindeki sıcaklıklarda üretilirler ve bu yüksek ısı sürecinden dolayı, ürün artık VOC maddelerini içermez. 1 Eylül 2012 tarihinden itibaren Fransa'da tüm yapı ürünleri VOC emisyon testlerine göre emisyon sınıflandırması ile etiketlenmelidirler. Emisyon açısından nötr olan ürünler olarak karolar A+ olarak sınıflandırılmaktadırlar. Etiket kutuların üzerinde bulunmaktadır.



\*Information sur le niveau d'émission de substances volatiles dans l'air intérieur, présentant un risque de toxicité par inhalation, sur une échelle de classe allant de A+ (très faibles émissions) à C (fortes émissions).





## UPEC

UPEC classification associated with the QB certification mark attests to the compliance of floor coverings with the technical requirements set out in certification reference documents. Although it is not compulsory to have an item classified according to UPEC standards, this classification means giving a customer the opportunity to choose an appropriate product for the intended use. The UPEC classification is performed by the CSTB (Centre Scientifique et Technique du Bâtiment, Scientific and Technical Building Centre) in Paris.

The four letters U, P, E and C stand for:

U: It indicates the wear resistance and corresponds to the wear groups as per EN ISO 10545-7. The index U can go from 2 (minimum stress) to 4.

P: It indicates the mechanical stresses to which the floor is expected to be subjected. These stresses can be caused by mobile or fixed furnishing uses or objects falling on the floor. It is also defined using the bending (tensile) strength. In practice the five indices 2, 3, 4, 4+ and 4s (highest toughness) are assigned.

E: It indicates the water sensitivity of the floor covering. This index E can go from 1 to a maximum of 3. The highest index 3 is always assigned to ceramic tiles. It is however remembered that the classification E3 of the tiles does not imply that a tiled floor is waterproof.

C: It indicates the resistance to chemical and staining substances that have a negative effect on the durability of the covering (stains, attacks that penetrate to various depths etc.). The index C can go from a minimum of 0 (lowest risk) to 2 (exceptionally 3 for particular rooms, as some laboratories).

Only certified manufacturers have the right to stipulate the UPEC classification of tested tiles. These tiles display the QB-UPEC logo on the labels and the UPEC classification of the product is indicated as well.

This certification guarantees:

- that the tiles comply with the prerequisites of the EN 14411 standard,
- that the tiles actually possess the specified wear-resistance characteristics, as defined by the UPEC classification (regular checking by an independent laboratory)
- that the tiles originate from a constantly controlled manufacturing process according to the extremely strict rules and regulations.

This is provided for information purposes only. CSTB has the right to replace/revise this Technical information and the UPEC classification of the products.

The full, up-to-date list of certified products of VitrA can be viewed at the following address:

<http://evaluation.cstb.fr/fr/carreau-ceramique/detail/1909/>  
<http://webapp.cstb.fr/upec-ceramique/index.php?view=TitulaireGammeSerie&sid=32>



## UPEC

QB sertifikalandırma işareti ile ilgili UPEC sınıflandırması referans belgelerinde belirtilen teknik gerekliliklerle zemin kaplamalarının uygunluğunu teyit eder. UPEC standartlarına göre sınıflandırılan bir ürüne sahip olmak zorunlu olmasa da, bu sınıflandırma müşteriye kullanım amacına uygun ürünün seçilme imkanını vermektedir. UPEC sınıflandırması Paris'teki CSTB (Centre Scientifique et Technique du Bâtiment, Bilimsel ve Teknik Yapım Merkezi) tarafından gerçekleştirilmektedir.

Dört harf U, P, E ve C aşağıdakileri ifade etmektedir:

U: Aşınma dayanımını göstermektedir ve EN ISO 10545-7'ye göre aşınma gruplarına karşılık gelmektedir. U sınıflandırması 2 (minimum stres) ile 4 arasında olabilmektedir.

P: Zeminin maruz kalması beklenen mekanik stresleri ifade etmektedir. Bu stresler hareketli veya sabit döşeme kullanımları veya zemine düşen nesnelere nedeniyle oluşabilmektedir. Bu ayrıca eğilme (gerilme) direnci kullanılarak da tanımlanmaktadır. Uygulamada beş sınıflandırma; 2, 3, 4, 4+ ve 4s (En yüksek sertlik) kullanılmaktadır.

E: Zemin kaplamasının su duyarlılığını göstermektedir. Bu E sınıflandırması 1 ile 3 arasında olabilmektedir. En yüksek sınıf olan 3 seramik karolar için tanımlanmıştır. Karoların E3 sınıflandırmasının karo döşenmiş bir zeminin su geçirmez olduğu anlamına gelmediği hatırlanmalıdır.

C: Bu kaplamanın dayanıklılığı üzerinde olumsuz etkisi olan kimyasal ve lekelenme maddelerine karşı dayanıklılığını tanımlamaktadır (Farklı derinliklere nüfus eden lekeler). C Endeksi minimum 0 seviyesinden (en düşük risk) 2 düzeyine çıkabilmektedir (Bazı laboratuvar gibi belirli odalar için istisnai olarak sınıf 3 olarak verilebilir).

Sadece onaylı üreticiler test edilen karoların UPEC sınıflandırmasını belirleme hakkına sahiptirler. Bu karolar için etiket üzerinde QB-UPEC logosu ve ürünün UPEC sınıflandırması gösterilir.

Bu sertifikalandırma şunları garanti etmektedir:

- Karoların EN 14411 standardının ön şartlarını karşıladığını,
- Karoların UPEC sınıflandırmasında tanımlanan belirli aşınma dayanım özelliklerine sahip olduğunu (Bağımsız bir laboratuvar tarafından düzenli kontrol yapılarak)
- Karoların aşırı katı olan kural ve yönetmeliklere göre düzenli kontrol edilen bir üretim sürecinden geçerek üretildiğini.

Bunlar sadece bilgi amaçlı olarak verilmiştir. CSTB, bu teknik bilgileri ve ürünlerin UPEC sınıflandırmasını yenileme/güncelleme hakkına sahiptir.

VitrA sertifikalı ürünlerinin tam ve güncel listesi aşağıdaki adresten görüntülenebilmektedir:

<http://evaluation.cstb.fr/fr/carreau-ceramique/detail/1909/>  
<http://webapp.cstb.fr/upec-ceramique/index.php?view=TitulaireGammeSerie&sid=32>



## Certificates

### Management system certificates



### Product certificates



### Turkish Standard Institute Certificates



\*For specific products/series only.  
Please refer to the website for the up-to-date certificates:  
<https://vitraglobal.com/catalogues/quality-certificates>  
<https://www.vitra.com.tr/kalite-sertifikalari/vitra-karo/>

## Sertifikalar

### Yönetim sistemleri sertifikaları



### Ürün sertifikaları



### Türk Standartları Enstitüsü Sertifikaları



\*Sadece belirli ürünlerde/serilerde geçerlidir.  
Güncel sertifikalar için lütfen aşağıdaki web-sitelerine başvurun:  
<https://vitraglobal.com/catalogues/quality-certificates>  
<https://www.vitra.com.tr/kalite-sertifikalari/vitra-karo/>



## VitrA terms and warranty conditions

### 1. Product quality

- 1.1. Products designated as “Quality: 1” comply with the quality requirements of European quality standard EN 14411. Those designated other than “Quality: 1” comply with the requirements for the CE-symbol but not with the aforementioned standard and exhibit technical and/or visual defects excluding them from classification as “Quality: 1” products.
- 1.2. No liability can be assumed if the colour, surface appearance of the goods delivered is not even or if the goods do not exactly match the samples or merchandising, the images on the website or the printed material (i.e. catalogues, brochures, price lists etc.). This is due to the variability of the natural raw materials and the ceramic production process. Particularly in mosaics, some colour variation is to be expected which is limited to the quality requirements of European quality standard EN 14411.
- 1.3. Tiles may vary in colour, texture or appearance according to product design for particular tile collections. Especially Shade variation V3, V4 type products may vary significantly within boxes, samples, merchandising and display. It is strongly recommended to pay attention to Shade variation during product selection.
- 1.4. Normal tolerances with respect to size and thickness do not constitute flaws. This shall also apply to any subsequent deliveries.
- 1.5. All floor coverings are subject to wear and tear depending on the area of application, the frequency of contact, the type and degree of soiling as well as the hardness and wear resistance of the product in question. The classification in stress groups refers to the wear resistance of the glazed surface, but not to the resistance to strain caused by pressure or heavy weights.
- 1.6. In the case of some artistic and decorative glazes, crazing in the glaze (formed before/after laying) is a natural effect and do not impair the ability to use the tiles for their intended purpose or constitute a defect.
- 1.7. During product selection, please pay attention to recommendations for area of use for suitable products in the price lists or catalogues.

### 2. Complaint management

- 2.1. The delivered goods shall be inspected immediately upon receipt to ensure that they are correct, complete and free of any defects. If there is an external/visible damage on the pallets identified during unloading of the delivery, the customer must remove the packaging for the pallets in question and inspect the goods. Any complaints shall be referred to VitrA in writing without delay and at the latest within 14 days. Any defects that do not become obvious until after the boxes have been opened shall also be reported in writing within 14 days and, in any case, prior to being laid. In any case, they may not be laid. In the absence of any written complaint or if the goods are laid, they are assumed to be accepted by the customer and the products are free of any defects.
- 2.2. Defected products must be kept ready and available for inspection at the time of realising the defects, without any removal of the tiles. Pallet and box labels should be stored as reference for analysing the defects thoroughly. All further processing of such goods must be stopped. The customer shall duly store the defected products until the complaint has been settled. In the event of a violation of the above obligation, VitrA does not carry an obligation to provide any replacements or any kind of payment.
- 2.3. If the complaint includes tiles that are already laid, VitrA carries an obligation only for those defects that become evident only after the tiles that are properly used according to the maintenance and care instructions. The tiles can be removed only after VitrA has been given the opportunity to inspect the defect within a reasonable time period and VitrA has given consent for removal in writing.
- 2.4. In any case, the removal of the tiles laid is limited to the defected tiles only.
- 2.5. VitrA reserves the right to repair, refund or replace the purchased or an equivalent product (to the same value) at its sole discretion.
- 2.6. No claim will be accepted without product inspection by VitrA or its authorized representatives.
- 2.7. The customer must notify VitrA, authorized representative or seller in writing within 14 days of the discovery of any defects. Claims can be notified via website:

[www.vitra.com.tr](http://www.vitra.com.tr) / <https://vitraglobal.com/contact>

### 3. Warranty conditions

- 3.1. Information contained on website or in brochures, offers, product descriptions, drawings, illustrations, Certificate of Conformities or other declarations, e.g. with respect to dimensions, weights or other performance criteria, may not be a binding guarantee but shall merely be deemed to be general product warranty information.
- 3.2. Warranty shall be assertible solely in case of fault on our part regarding material, workmanship and production under proper use resulting noncompliance of the product to VitrA specifications, industry allowable tolerances and quality standard such as EN 14411 and ANSI 137.1. Where warranty claims are assertible against our representatives, such parties shall be liable to the customer solely in case of fault on our part regarding material, workmanship and production under proper use resulting noncompliance of the product to VitrA specifications, industry allowable tolerances and quality standard such as EN 14411 and ANSI 137.1. If this is the case and if the conditions specified in Section 2 are satisfied, VitrA may choose to repair, replace with non-defected same or equivalent products or compensate the customer for the reduced value of the products caused by the defects in question, depending on the nature of the defect and availability of the product. In each case, no further remedies shall be available to the customer other than VitrA’s. Purely optical defects (i.e. matt/gloss differences, colour shade differences, digital printing faults and thin printing stripes etc.) shall only entitle the customer to claim a reduction in value. There would not be any change for the laid products.
- 3.3. Any usage errors or misuse of the product by the customer including physical or chemical abuse, or negligence is evaluated as direct damages/user error and they are not covered under the product warranty.
- 3.4. Do not apply any adhesive material to the laid/not laid tiles, decorative or skirting tiles. Any direct damage that may occur as a result of this application is considered as a user error and VitrA is not liable for any product change or payment.
- 3.5. We shall solely reimburse direct damages stated above provided that such direct damages are finally awarded by a court of competent jurisdiction.
- 3.6. The customer is obliged to inform VitrA within 14 calendar days in writing about the products / pallets which have delivered as broken, and to keep all broken products for inspection by the technical experts authorized by VitrA. VitrA is not responsible for any changes or claims for damages if it determined by technical experts that the fracture formation is not caused by the pallet arrangement.

## VitrA garanti koşul ve kuralları

### 1. Ürün kalitesi

- 1.1. “Kalite: 1” olarak tanımlanan ürünler, Avrupa Kalite Standardı EN 14411’in gerekliliklerini sağlamaktadır. “Kalite: 1” dışında tanımlanan ürünler ise CE-sembolünün gerekliliklerini sağlar, ancak EN 14411 standardının, CE işareti gereklilikleri haricindeki görsel veya teknik 1. Kalite gerekliliklerini sağlayamayabilir.
- 1.2. Teslim edilen ürünlerin renk, yüzey görünüşünün benzer olmaması ya da ürünlerin numunelerle, mağaza teşhirleriyle, web sitesindeki görüntüler veya basılı evraklar ile tam olarak uymaması durumunda hiçbir sorumluluk kabul edilmez (Örneğin Kataloglar, broşürler, fiyat listeleri vb.). Bu durum üretimde kullanılan doğal hammaddelerin değişkenliğinden ve seramik üretim prosesinden kaynaklanmaktadır. Özellikle mozaiklerde, Avrupa Kalite Standardı EN 14411’in kalite gereklilikleriyle sınırlı olacak oranda hafif renk değişimleri beklenmektedir.
- 1.3. Karolar, bazı serilerdeki ürün tasarımı kaynaklı olarak, renk, doku ve görünüş olarak değişiklik gösterebilir. Özellikle Desen farklılaşması V3, V4 olarak tanımlanan ürünler kutu içindekilerle, numunelerle, ticari numunelerle ve teşhirlerle önemli ölçüde farklılık gösterebilir. Ürün seçimi sırasında Desen farklılaşmasına dikkat etmenizi önemle bilgilerinize sunarız.
- 1.4. Boyut ve kalınlığı bakımından ISO 13006, EN 14411 ve ANSI 137.1 standartlarında belirtilen toleranslar içerisinde olan ürünler kusur teşkil etmez. Bu durum, farklı sevkiyatlarda gönderilen ürünlerin her teslimatı için geçerlidir.
- 1.5. Tüm zemin kaplamaları, uygulama alanına, kullanım yoğunluğuna, kirleticinin türüne ve kirlenmenin yoğunluğuna, ayrıca söz konusu ürünün sertliğine ve aşınma direncine bağlı olarak aşınma ve yıpranmaya maruz kalır. Stres gruplarındaki sınıflandırma, Sırlı yüzeyin aşınma direncine karşılık gelir, ancak basınç veya ağır yüklerin neden olduğu gerilime/sürtünmeye karşılık direncini göstermez.
- 1.6. Dekoratif sırlar söz konusu olduğunda, sır içindeki çatlaklar (döşmeden önce / sonra oluşan) doğal bir etkidir ve karoların amacına yönelik kullanımına olumsuz bir etkisi olmaz veya bir hata teşkil etmez.
- 1.7. Ürün seçimi sırasında, fiyat listeleri veya kataloglarda bulunan kullanım alanı önerilerine dikkat edilmelidir.

### 2. Şikayet yönetimi

- 2.1. Teslim edilen ürünlerin, doğru, eksiksiz ve herhangi bir kusur taşımadıklarından emin olmak için teslim alındıktan sonra derhal kontrol edilmelidir. Teslimatın indirilmesi sırasında belirlenen paletler üzerinde harici / görünür bir hasar varsa, söz konusu paletlerin ambalajları açılmalı ve ürünler gözden geçirilmelidir. Tüm şikayetler VitrA’ya gecikme olmaksızın en geç 14 gün içinde yazılı olarak bildirilmelidir. Kutular açılmadan anlaşılamayan tüm hatalar da en geç 14 gün içerisinde, karolar döşenmeden önce VitrA’ya yazılı olarak bildirilmelidir. Hata olduğu düşünüldür veya görülürse ürünler döşenmemelidir. Yazılı şikâyetin bulunmadığı veya ürünlerin döşendiği durumlarda, ürünlerin müşteri tarafından kabul edildiği varsayılır ve ürünler kusursuz kabul edilir.
- 2.2. Kusurlu ürünler, hata fark edildiğinde sökülmemeli ve kontrol için hazır halde bulundurulmalıdır. Kutu, palet ve kutu etiketleri, şikayetin incelenmesi için saklanmalıdır. Ürünlerin hataları fark edildiğinde döşeme işlemleri durdurulmalı, şikayet çözülene kadar kusurlu ürünler saklanmalıdır. Yukarıdaki şartların ihlali durumunda VitrA herhangi bir ürün değişimi veya herhangi bir ödeme yapma yükümlülüğü taşımamaktadır.
- 2.3. Şikayet, halihazırda döşenmiş karolar içinse, VitrA, yalnızca temizlik ve bakım talimatlarına göre uygun şekilde kullanılan karolarda ortaya çıkan kusurlar için bir yükümlülük taşır. Karolar, VitrA’ya makul bir süre içinde kusuru inceleme fırsatı verildikten ve VitrA yazılı olarak izin verdikten sonra sökülebilir, aksi takdirde işlem yapılamaz.
- 2.4. VitrA tarafından üretim hatası olarak kabul edilen şikayetlerde yapılacak değişim sadece hatalı karoların değiştirilmesi ile sınırlıdır.
- 2.5. VitrA, satın alınan üründe hata çıkması durumunda birebir değiştirme, tamir etme, iade alma veya muadili ile değiştirme hakkını saklı tutar.
- 2.6. VitrA veya yetkili temsilcileri tarafından ürün incelemesi yapılmadan hiçbir talep ve şikayet kabul edilmeyecektir.
- 2.7. Müşteri, herhangi bir kusurun bulunmasından sonraki 14 gün içerisinde VitrA’yı, yetkili temsilci veya satıcıyı yazılı olarak bilgilendirmelidir. Talepler web sitesi aracılığıyla da bildirilebilir:

[www.vitra.com.tr/iletisim](http://www.vitra.com.tr/iletisim) / <https://vitraglobal.com/contact>

### 3. Garanti koşulları

- 3.1. Web sitesinde, broşürlerde, tekliflerde, ürün açıklamalarında, çizimlerde, numunelerde, Uygunluk Sertifikasında veya diğer beyanlarda bulunan bilgiler, (Örneğin boyutlar, ağırlıklar veya diğer performans kriterleri) bağlayıcı bir garanti değildir, sadece genel ürün bilgileri olarak kabul edilmelidir.
- 3.2. Garanti, ürünlerin müşteri tarafından doğru ve amacına uygun olarak kullanılması şartıyla, malzeme, işçilik ve üretim kaynaklı bir hata içeren durumlarda; VitrA’nın şartlarının, endüstride kabul edilen EN 14411 ve ANSI 137.1 gibi standartlardaki toleransların dışına çıkıldığı durumlarda geçerlidir. Bayiler/temsilciler, ürünlerin müşteri tarafından doğru ve amacına uygun olarak kullanılması şartıyla, malzeme, işçilik ve üretim kaynaklı bir hata içeren durumlarda; VitrA’nın şartlarının, endüstride kabul edilen EN 14411 ve ANSI 137.1 gibi standartlardaki toleransların dışına çıkıldığı durumlarda müşteriye karşı sorumlu olacaktır. Bölüm 2’de belirtilen şartlar yerine getirilmişse, VitrA, müşterinin hatalı ürünlerden oluşan zararını karşılamak için, mevcut stoklara ve hata tipine bağlı olarak, onarım yapma, hatalı ürünü kusurlu olmayan birebir veya eşdeğer ürünlerle değiştirme hakkını saklı tutar. VitrA tarafından beyan edilen çözüm yönteminin dışında bir talep kabul edilmeyecektir. Tamamen görsel kusurlardan oluşan durumlarda (Örneğin matlık / parlaklık farklılıkları, renk tonu farklılıkları, dijital baskı hataları ve ince baskı çizgileri vb.), hatalı ürün adediyle sınırlı olmak şartıyla ürün satış bedeli üzerinden indirim talep etme hakkı verir, döşenen ürünlerde değişim yapılmaz.
- 3.3. Ürünün fiziksel veya kimyasal olarak hatalı kullanıma maruz kalması veya ihmalkarlık dahil olmak üzere müşteri tarafından herhangi bir şekilde yanlış kullanılması durumu kullanıcı hatası olarak değerlendirilir ve söz konusu ürün garanti kapsamında değerlendirilmez.
- 3.4. Döşenmiş/döşenmemiş karo, dekor veya süpürgelekler üzerinde herhangi bir yapıştırıcı madde içeren malzeme ile uygulama yapılmamalıdır. Bu uygulama neticesinde ortaya çıkabilecek direkt hasarlar kullanıcı hatası olarak kabul edilir ve VitrA herhangi bir ürün değişikliği veya ödeme yapma yükümlülüğü taşımamaktadır.
- 3.5. Yukarıda tanımlanan durumlarda, kararın nihai olarak taraflarca yetkili tayin edilen bir mahkeme tarafından verilmesi şartıyla sadece oluşan direkt hasar/zarar VitrA tarafından tazmin edilir.
- 3.6. Müşteri, eline kırık olarak ulaşan ürünler/paletler ile ilgili, 14 takvim günü içinde VitrA’yı yazılı olarak bilgilendirmek ve tüm kırık ürünleri VitrA tarafından yetkilendirilmiş teknik uzmanlarca incelenmesi için muhafaza etmekle yükümlüdür. Kırık oluşumunun palet dizilimi kaynaklı olmadığıнын teknik uzmanlarca tespiti halinde VitrA, herhangi değişim ve tazminat taleplerinden sorumlu değildir.

## VitrA terms and warranty conditions

- 3.7. The customer is responsible to check the goods for any variation in colour before being laid. Once the goods have been laid, VitrA is not liable under any circumstances for variations in colour. The products which have the same colour tone and calibre number should be laid to the same space by mixing different boxes. The product should not be laid without joint due to technical reasons. The recommended joint width should be used that is indicated on the boxes.
- 3.8. Products (Wall tiles, Floor tiles, Porcelain, pool parts and mirrored tiles) should never be laid on the ceiling. VitrA is not liable for any incidents or consequences of accidents, property or loss of life that may occur as a result of laying.
- 3.9. VitrA strongly recommends ordering and storing for more than enough products from the area calculated (min. 2 boxes or 2% for areas larger than 100 square meters according to the area to be used) for the losses and the partial change and repair requirements that may occur during installation / use and keep them for future requirements.
- 3.10. Rectified / Non-rectified products with pattern should be controlled with recommended joint width during before laying. In the absence of any written complaint or if the goods are laid, they are assumed to be accepted by the customer and the products are free of any defects.
- 3.11. Installation quality is as important as product quality, therefore VitrA recommends utilization of competent tile layers for the best results. VitrA does not accept any responsibility for defects aroused from infrastructure failures, faults due to installation and insulation, errors caused by application of plaster without hardening enough, application of faulty plaster / defects due to plaster content, breakage / cracking due to improper application of adhesive under tiles, incorrect flooring and wrong adhesive selection.
- 3.12. In wide area applications (in areas larger than 6x6 m), the elasticity of the adhesive alone is not sufficient. The continuity of the coating should be cut using expansion joints and the tensile movements should be damped with the help of these joints. Attention should be paid to the structural expansion (dilatation) joints left on the application surfaces and the joints should not be covered with tile. Any direct damage that may occur as a result of non-observance of this application is considered as a user error and VitrA is not liable for any product change or payment.
- 3.13. VitrA shall not accept any warranty for metallic decors and metallic glazed tiles installed in wet areas such as showers, baths etc. Never use abrasive materials and strong cleaning agents for cleaning these products. Please refer to Maintenance and Cleaning Instructions.
- 3.14. Any food, liquid or chemical spill must be cleaned away immediately to prevent harsh staining. It is possible for foreign substances to leave slight discoloration on the tiles if left unattended for prolonged time periods. VitrA's warranty does not cover deterioration to the product due to improper use, incorrect cleaning applications or gross negligence.
- 3.15. VitrA is not liable for any of the consequences of improper planning, wrong product selection, and environmental conditions or for damage caused by inappropriate cleaning that is not carried according to the maintenance and care instructions. Under any circumstances, the detergents must not contain any hydrofluoric acid and its derivatives.
- If alternative/restorative floor treatments are employed, it is the responsibility of the floor treatment manufacturer/seller to verify compatibility and offer product warranty. Some treatments may alter the tile surface characteristics such as anti-slip resistance, staining resistance etc. which might be inconsistent with VitrA's product recommendations and VitrA's warranty does not cover this situation.
- 3.16. Inappropriate product selection may cause abrasion, breakage, crack, slipperiness, frost damage etc. on the tiles. VitrA is not liable for lawsuit, replacement or renovation claims regarding these kind of consequences of improper planning or misuse of the products.
- 3.17. VitrA is not responsible for any replacement or renewal request arising from laying procedures that are in contradiction with VitrA's written or visual laying guidelines specified on the box, product or catalogue.
- 3.18. VitrA shall not accept any warranty for products other than those classified as "Quality: 1".
- 3.19. In the event of any damage to the product during the cutting process, VitrA informs the customer about the conditions of cutting, which equipment can be used and cutting techniques. In the event of a dispute, VitrA's standard cutting test result and recommendation of VitrA are taken into consideration. VitrA is not responsible for any replacement or replacement requests caused by improper use of the products or applications other than the recommended cutting application.
- 3.20. VitrA shall assume no warranty for any additional secondary application with refiring or without refiring such as polishing, rectification, scoring, wet/dry cutting, netting without written approval.
- 3.21. The use of dark coloured grout is not recommended due to the color pigments in the chemical composition of the material. If used, it should be tested for staining performance on several tiles before grouting. For products with risk of staining, the tiles should be covered with a protective film, primer or similar material before the application and then grouting should be made.
- 3.22. If dark coloured (black anthracite, dark blue, etc.) grouting materials are used, stains caused by the chemical structure of the grout may occur, such stains are not covered by the guarantee.
- 3.23. For tiles to be used in dry areas, minimum C2 type adhesives must be used, and for tiles that are suitable for use in wet areas or pools, minimum C2TE S2 type adhesives must be used. Ceramic tile adhesives suitable for the needs of the relevant area should be used for special application areas (flexible, very flexible, fast setting, frost resistant etc.). For special adhesive types, information should be obtained from adhesive producers and application should be made according to their directions.
- 3.24. It is essential to completely fill the bottom of tiles with ceramic adhesive materials, using appropriate ceramic trowel and fixing technique, so that there is no gap left between the floor and the ceramic tile. The presence of any gap left under the tile directly affects the load bearing and impact resistance performance of tiles. If there is a gap under the tiles, the products are out of the scope of guarantee in terms of strength properties.

\* You can find most recent information about our products, Warranty Conditions, Maintenance and Cleaning Instructions, along with other Product Performance Data and Installation specifications at: [www.vitra.com.tr](http://www.vitra.com.tr) / <https://vitraglobal.com/>

## VitrA garanti koşul ve kuralları

- 3.7. Müşteri, döşeme yapılmadan önce herhangi bir desen/renek farklılaşması olup olmadığına dair ürünleri kontrol etmekle yükümlüdür. Ürünler döşendikten sonra, VitrA, renk farklılaşması için hiçbir koşulda sorumlu değildir. Aynı renk tonuna ve kalibreye sahip ürünler, farklı kutuları karıştırarak aynı alana döşenmelidir. Ürünler teknik sebeplerden dolayı derzsiz döşenmemelidir. Kutu üstünde tavsiye edilen derz ölçüsü kullanılmalıdır.
- 3.8. Ürünler (Duvar karosu, Yer karosu, porselen, havuz parçaları ve aynalı karolar) kesinlikle tavana döşenmemelidir. Döşenmesi halinde yaşanabilecek kaza, mal veya can kaybı olaylarının doğurabileceği talep ve sonuçlardan VitrA sorumlu değildir.
- 3.9. Döşeme esnasında oluşabilecek kayıplar ve döşeme/kullanım sonrası oluşabilecek kısmi değişim ve tamirat ihtiyaçları için hesaplanan alandan yeteri kadar fazla (kullanılacak alana göre min. 2 kutu veya 100 metrekareden büyük alanlar için %2) ürün sipariş etmenizi ve ileride oluşabilecek ihtiyaçlar için saklamanızı önemle tavsiye ederiz.
- 3.10. Rektifiyeli/kalibreli ürünler, döşeme öncesinde önerilen derz aralığı ile kontrol edilmelidir. Herhangi bir yazılı şikâyetin bulunmaması veya desen takibi bulunan özel ürünlerin tavsiye edilen derz artısı ile kontrol edildikten sonra döşenmesi halinde, ürünlerin müşteri tarafından kabul edildiği ve kusursuz olduğu varsayılır.
- 3.11. Döşeme kalitesi ürün kalitesi kadar önemlidir, bu nedenle VitrA, ürünlerinden en iyi performansın alınması için döşemenin yetkin karo döşeyicileri tarafından yapılmasını önerir. Altyapı hataları, tesisat veyalıtım kaynaklı hatalar, uygulanan sıva yeterince sertleşmeden yapılan uygulama kaynaklı hatalar, hatalı sıva kullanımı/sıva muhteviyatı kaynaklı hatalar, karoların altında uygun şekilde yapıştırıcı uygulanmaması nedeniyle oluşan kırılma/çatlamalar, yanlış döşeme ve yanlış yapıştırıcı seçimi nedeniyle ortaya çıkan hatalar VitrA'nın sorumluluğunda değildir.
- 3.12. Geniş alan uygulamalarında (6x6 m'den büyük alanlarda) yapıştırıcının elastikiyet özelliği tek başına yeterli olmamaktadır. Kaplama sürekliliği genişleme derzleri kullanılarak kesilmeli ve bu derzler yardımıyla gerilme hareketleri sönmülmelidir. Uygulama yüzeylerinde bırakılmış yapısal genişleme (dilatasyon) derzlerine dikkat edilmeli, derzlerin üzeri kesinlikle karo ile kaplanmamalıdır. Bu uygulamaya uyulmaması neticesinde ortaya çıkabilecek direkt hasarlar kullanıcı hatası olarak kabul edilir ve VitrA herhangi bir ürün değişikliği veya ödeme yapma yükümlülüğü taşımamaktadır.
- 3.13. VitrA, duş, banyo vb. ıslak alanlara döşenen metalik dekorlar ve metalik Sırlı karolar için herhangi bir garanti sunmamaktadır. Bu ürünleri temizlemek için kesinlikle aşındırıcı malzemeler ve güçlü temizlik maddeler kullanılmamalıdır. Detaylı bilgi için Temizlik ve Bakım Talimatlarına bakınız.
- 3.14. Karo üzerinde ağır lekelenmeleri önlemek için herhangi bir gıda, sıvı veya kimyasal dökülmesi durumunda karo yüzeyi derhal temizlenmelidir. Uzun süre temizlenmez ise, yabancı maddelerin karolarda hafif renk değişimi yapması mümkündür. VitrA'nın garantisi, yanlış kullanım, yanlış temizlik uygulamaları veya ihmal nedeniyle ürünün bozulmasını kapsamamaktadır.
- 3.15. VitrA, hatalı tasarım, yanlış ürün seçimi, çevre koşulları veya temizlik ve bakım talimatlarına uygun olmayan temizlikten kaynaklanan hasarlardan sorumlu değildir. Kullanılan deterjanlar kesinlikle hidroflorik asit ve türevlerini içermemelidir. Alternatif / koruyucu zemin uygulamaları kullanılıyorsa, uygulamayı doğrulamak ve ürün garantisini sunmak zemin uygulamaları üreticisinin / satıcısının sorumluluğundadır. VitrA'nın ürün önerilerinden bağımsız yapılan özel yüzey uygulamaları kaymazlık değeri, lekelenme direnci vb. gibi karo yüzey özelliklerini değiştirebilir ve bu durum VitrA'nın garanti şartlarını geçersiz kılar.
- 3.16. Uygun olmayan ürün seçimi, karolarda aşınmaya, kırılmaya, çatlamaya, kaymaya, donma hasarına vb. neden olabilir. VitrA, hatalı planlamanın veya ürünlerin yanlış kullanımının bu tür sonuçlarıyla ilgili dava, değiştirme veya yenileme taleplerinden sorumlu değildir.
- 3.17. VitrA'nın kutu, ürün veya katalog üzerinde belirttiği yazılı ya da görsel döşeme yönergelerine aykırı yapılmış döşeme işlemlerinden doğacak herhangi değiştirme veya yenileme talebinden VitrA sorumlu değildir.
- 3.18. VitrA, "Kalite: 1" olarak sınıflandırılanların dışındaki ürünler için herhangi bir garanti vermemektedir.
- 3.19. Kesme işlemi esnasında üründe meydana gelebilecek herhangi bir hasar durumunda VitrA, ürünlerin hangi ekipman kullanılarak ve hangi koşullar altında, hangi teknikle kesilebildiğini müşteriye bildirir. Anlaşmazlık halinde VitrA'nın standart kesme test sonucu ve önerisi esas alınır. VitrA, ürünlerin yanlış kullanımı veya önerilen kesme uygulaması dışındaki uygulamalar nedeniyle oluşan değiştirme veya yenileme taleplerinden sorumlu değildir.
- 3.20. VitrA, yazılı izni olmaksızın ürünlerinde fırınlanarak veya fırınlanmadan yapılan ikincil işlemlere dair garanti vermez. Örneğin: parlatma, rektifiye etme, scoring, sulu/kuru kesim, fileleme gibi işlemler sonucu oluşacak hatalar garanti kapsamı dışındadır.
- 3.21. Koyu renkli derz dolgu malzemelerinin kullanımı, derz dolgusunun kimyasal yapısındaki renk pigmentlerinden dolayı önerilmemektedir. Kullanılması durumunda ise, derz uygulaması yapılmadan önce birkaç karo üzerinde, lekelenme performansı açısından test edilmelidir. Lekelenme riski görülen ürünlerde uygulama öncesi karolar yüzey koruyucu film astar veya benzeri bir malzeme ile kaplanmalı, ardından derz uygulaması yapılmalıdır.
- 3.22. Koyu renkli (siyahı antrasit, koyu mavi vb) derz dolgu malzemelerinin kullanılması halinde, derzlerin kimyasal yapısından kaynaklanan lekelenmeler oluşabileceğinden, bu gibi lekeler garanti kapsamı dışındadır.
- 3.23. Kuru alanlarda kullanılacak olan ürünlerimiz için minimum C2 tipinde, ıslak alanlarda veya havuz için kullanıma uygun olduğu beyan edilen ürünlerin havuzda kullanımı için ise minimum C2TE S2 tipinde yapıştırıcıların kullanılması gerekmektedir. Özel uygulama alanları için ilgili alanın ihtiyaçlarına uygun karo seramik yapıştırıcıları kullanılmalıdır (esnek, çok esnek, hızlı prizlenen, soğuğa dayanıklı vb). Özel yapıştırıcı tipleri için yapıştırıcı firmalarından bilgi alınmalı ve yönlendirmelerine göre uygulama yapılmalıdır.
- 3.24. Ürünlerimizin altlarının, uygun seramik malası ve yapıştırma tekniği ile, zemin ve karo seramik arasında boşluk kalmayacak şekilde, seramik yapıştırıcı malzemelerle tam doldurulması esastır. Karonun altında boşluk olması, karoların yük taşıma ve darbe dayanımı performanslarını doğrudan etkilemektedir. Karo altlarında boşluk bulunması durumunda ürünler, mukavemet özellikleri açısından garanti kapsamı dışında kalmaktadır.

\* Ürünlerimizin, Garanti Koşullarının, Temizlik ve Bakım Talimatlarının yanı sıra Ürün Teknik Özellikleri ve döşeme talimatlarıyla ilgili en son bilgileri aşağıdaki web sitelerinde bulabilirsiniz: [www.vitra.com.tr](http://www.vitra.com.tr) / <https://vitraglobal.com/>



## VitrA Fix Building Chemicals

### 1. Product portfolio

VitrA Fix Building Chemicals are produced under the high reliability and quality standards of VitrA brand.

• **Adhesive group** consists of products for sticking floor and wall tiles according to different usage areas and needs. Non-slip, elastic, water-repellent products with extended product lives are generally offered in white and grey colours. In addition to those with cement-based content, ready-to-use acrylic dispersion-based and 2-component polyurethane-based adhesives are also available in the product range.

• **VitrA Fix grouting materials** are classified according to their usage area and colour type. Their structure is cement based with either fine and coarse ingredients. They can also be found as two-component epoxy resin-based. Those with proven bacteria resistance and hygienic structure provide a safe and healthy environment.

• **Waterproofing products** are used especially in wet areas. The use of these products is practical and the product selection should be made according to the place of use. Solutions for wet spaces such as balconies, terraces, pools, water tanks etc. are included in the product portfolio. Care should be taken to ensure that the products to be used for water storage have: contact with drinking water and appropriate analysis certificates. The product portfolio includes cement-based products as well as acrylic resin-based ready-to-use products.

• **Performance-enhancing additives** provide flexibility, abrasion resistance, impact resistance, adhesion strength, water impermeability, crack resistance, etc. for tiles. They are used to increase the performance of features. Primers are ready to use, and besides the function of facilitating the adhesion of the products applied after them to the surface, they also reduce product consumption and bring down the total cost of projects.

• **Surface cleaning and care products** are used for cleaning tiles. Adhesive, grouting, plaster, cement and lime-based mortar residues remaining on the surface after the tiling can be easily cleaned without damaging the tiles thanks to surface cleaning and care products.

• **Repair mortars** are cement based and are used for surface smoothing and repair. They are suitable for interior and exterior use, and are available in different varieties as fine and coarse grained.

• **Floor products group** includes self-levelling screeds, floor levelling mortars and floor strengtheners for floors with high traffic.

• **Silicone sealants** in the sealing and expansion sealants group are used in sinks, bathtubs, glass, aluminium, etc. They can be used safely in filling and sealing the joints of materials.

• **VitrA Fix antibacterial grouting materials** provide a hygienic environment when applied together with tiles. They prevent the formation of bacteria, mould and fungus in the areas used. This provides an advantage for people with allergies and respiratory disorders. Especially today, the importance of hygiene is increasing day by day, They can be safely used in large-scale public spaces such as hotels and cafes. Their bacterial resistance is proven and they are hygienic with their mould and algae-free structure.

### 2. About grouting

The grouting materials used in tile applications have two basic functions. The physical function protects the coated surface and the bottom of the coating against abrasion, the effects of water and chemicals. The decorative function, on the other hand, allows variations in design. It adds decorative richness to tile applications with colour alternatives. The surface absorbency of the tile, the flexibility of the application surface, the dimensions and weights of the tile, and the area to be applied are as important as the choice of colour in the selection of grout filling material. Attention should be paid to the warnings on the packaging and the information given by the manufacturer during the preparation and application of the grout filler material.

### 3. Colour in grout selection

Choosing the right colour is an important criteria in the selection of grout colour. When choosing from the grout filler colour chart, one should choose from actual colour samples instead of printed catalogues. During the selection, the colour samples should be viewed under daylight and the tile and the grouting rod should be brought together.

An harmonious space design can be created by choosing the grout colour compatible with the colours of the tile. However, grouting can be used in the contrasting colours of the tile as well. For example, when a white tile with black grouting is chosen, grouting will come to the fore and a third dimension effect will be created in the area used. If a contrasting colour is to be chosen, care must be taken to ensure that the tile and grouting workmanship is top-notch. Otherwise, the eye will be constantly drawn to the details.

If the colour preference is more natural and harmonious shades, it can be decided by using the basic colour wheel. Using warm tile colours with warm grouting colours and cold ones with cold ones (such as sapphire blue, emerald green) will be the most appropriate solution for the space.

## VitrA Fix Yapı Kimyasalları

### 1. Ürün portföyü

VitrA Fix Yapı Kimyasalları, VitrA markasının yüksek güvenilirlik ve kalite standartlarında üretilmektedir.

• **Yapıştırıcı grubu**, farklı kullanım yerleri ve kullanım ihtiyaçlarına göre yer ve duvar karolarını yapıştırmaya yönelik ürünlerden oluşmaktadır. Kayma yapmayan, elastik, su itici, ihtiyaca göre çalışma süresi uzatılmış ürünler, genellikle beyaz ve gri renklerde sunulmaktadır. Çimento esaslı içeriğe sahip olanlar dışında kullanıma hazır akrilik dispersiyon esaslı ve 2 bileşenli poliüretan esaslı yapıştırıcılar da ürün gamı içerisinde mevcuttur.

• **Vitra Fix derz dolgular**, kullanım yerine ve renk çeşidine göre sınıflandırılır. Genel yapıları çimento esaslı olup, ince veya kalın dolgulu olabilirler. Epoksi reçine esaslı çift bileşenli olarak da bulunabilirler. Bakteri direnci kanıtlanmış, hijyenik yapıda olanlar güvenli ve sağlıklı bir ortam sağlarlar.

• **Su Yalıtım ürünleri** özellikle ıslak hacimli mekanlarda kullanılır. Bu ürünlerin kullanımı pratik olup, ürün seçimi kullanım yerine göre belirlenmelidir. Balkon, teras, havuz, su deposu vb. daimi ıslak hacimli alanlar için uygun çözümler ürün portföyü içerisinde yer almaktadır. Su deposu için kullanılacak ürünlerde içme suyu ile temas ve uygun analiz sertifikalarının bulunmasına dikkat edilmelidir. Ürün portföyü içerisinde çimento esaslı ürünler olduğu gibi, akrilik reçine esaslı kullanıma hazır ürünler de yer almaktadır

• **Performans artırıcı katkılar**, karolar için esenklik, aşınma direnci, darbe direnci, yapışma mukavemeti, su geçirimsizlik, çatlama direnci vb. özelliklerin performansını artırma amacıyla kullanılır. Astarlar kullanıma hazır olup, kendinden sonra uygulanan ürünlerin yüzeye yapışmasını kolaylaştırma fonksiyonu yanında ürün tüketimini de azaltır ve proje toplam maliyetinin indirilmesini sağlar.

• **Yüzey temizlik ve bakım ürünleri** karoların temizliği amacıyla kullanılır. Yapıştırıcı, derz dolgu, sıva vb. uygulamalardan sonra yüzeyde kalan çimento ve kireç esaslı harç kalıntıları, yüzey temizlik ve bakım ürünleri sayesinde karolara zarar vermeden kolaylıkla temizlenebilir.

• **Tamir harçları** çimento esaslı olup, yüzey düzeltme ve tamiri amacıyla kullanılır. İç ve dış cephelerde kullanıma uygun olup, ince ve kalın taneli olarak farklı çeşitleri mevcuttur.

• **Zemin ürünleri** grubunda kendinden yayılan şaplar, zemin düzeltme harçları ve yüksek trafiğe sahip zeminler için zemin sertleştiricileri yer almaktadır.

• **Sızdırmazlık ve genişleme mastikleri** grubunda yer alan silikon mastikler, lavabo, küvet, cam, alüminyum vb. malzemelerin detay birleşim yerlerinde doldurma ve sızdırmazlık sağlamada güvenle kullanılabilir.

• **VitrA Fix antibakteriyel derz dolgular**, karolar ile birlikte uygulandığında hijyenik bir ortam sağlar. Kullanılan alanlarda bakteri, küf ve mantar oluşumunu engeller. Bu da alerjik ve solunum rahatsızlığı olan kişiler için avantaj sağlar. Özellikle günümüzde hijyenin önemi her geçen gün artarken, ev dışında, otel, cafe vb. büyük ölçekli toplu kullanıma açık mekanlarda da kullanımı güvenle tercih edilebilir. Bakteri direnci kanıtlanmıştır, küf ve yosun oluşturmayan yapısı ile hijyeniktir.

### 2. Derz dolgular hakkında

Karo uygulamalarında kullanılan derz dolgu malzemelerinin iki temel fonksiyonu bulunmaktadır, bunlardan ilki olan fiziksel fonksiyon, kaplanmış yüzeyi ve kaplama altını aşınmaya, suyun ve kimyasalların etkilerine karşı korur. Dekoratif fonksiyon ise farklı tasarım aralıklarına göre tasarımda değişkenliğe imkân verir. Renk alternatifleri ile karo uygulamalarına dekoratif zenginlik katar. Derz dolgu malzemesi seçiminde kaplama malzemesinin yüzey emiciliği, uygulama yüzeyi esnekliği, kaplama malzemesinin boyut ve ağırlıkları, uygulama yapılacak alan da en az renk seçimi kadar önemlidir. Derz dolgu malzemesi hazırlama ve uygulama aşamalarında ambalaj üzerindeki uyarılar ve üretici firma tarafından verilen bilgilere dikkat edilmelidir.

### 3. Derz dolgu seçiminde renk faktörü

Derz rengi seçiminde doğru renk seçimi önemli kriterlerden biridir. Öncelikle derz dolgu renk kartelasından seçim yaparken, basılı kartelalar yerine birebir uygulanmış kartelalardan seçim yapılmalıdır. Seçim sırasında gün ışığı gibi doğru bir ışık altında bakılmalı ve mümkünse karo ile derz dolgu çubuğu bir araya getirilmelidir.

Renk seçiminde karonun renkleri ile uyumlu derz dolgu rengi seçilerek bütünsel bir mekan tasarımı yaratılabilir. Bununla birlikte karonun tam zit renklerinde de derz dolgusu kullanılabilir. Örneğin, beyaz karo ile siyah derz dolgu seçildiğinde derz dolguları ön plana çıkacak ve kullanılan alanda üçüncü boyut etkisi oluşacaktır. Zit renk seçimi yapılacaksa karo ve derz dolgu işçiliğinin mutlaka üst düzey olmasına özen gösterilmelidir. Aksi takdirde göz süreklili olarak ayrıntılara takılacaktır.

Renk tercihi daha doğal ve uyumlu tonlar ise yine temel renk çarkı kullanılarak karar verilebilir. Sıcak tonlar ile sıcak tonları ve soğuk karo renkleri ile soğuk derz dolgu renklerini (safir mavi, zümrüt yeşil gibi) kullanmak mekan için en uygun çözüm olacaktır.





## Contacts / İletişim

### Headquarters

Genel merkez

### VitrA Karo San. ve Tic. A.Ş.

Büyükdere Cad. Ali Kaya Sok. No: 5  
Levent, 34394 İstanbul  
Phone: +90 (212) 350 80 00  
Fax: +90 (212) 350 85 58

### Regional offices

Bölge ofisleri

### VitrA UK Ltd.

Park 34 Collet Way,  
Didcot Oxon OX11 7WB, UK  
Phone: +44 (1235) 750 990  
Fax: +44 (1235) 750 985

### VitrA Fliesen GmbH-Co. KG.

Brucknerstrasse 43  
56566 Neuwied, Germany  
Phone: +49 (2622) 7007-0  
Fax: +49 (2622) 7007-60

### VitrA Plitka LLC

142253, bld. 1, Bolshevik Settlement,  
Serpukhov District, Moscow Region, Russia  
Phone: +7 (496) 738 06 08  
Fax: +7 (495) 520 78 76

vitraglobal.com

vitra.com.tr

### Flagship showrooms

Flagship mağazalar

### VitrA Nişantaşı

Vali Konağı Cad. No: 24, Nişantaşı  
Şişli, İstanbul  
Phone: +90 (212) 233 07 78  
Fax: +90 (212) 232 94 67

### VitrA Suadiye

VitrA Suadiye (Cavit Paşa Köşkü)  
Bağdat Cad. 493-1, Bostancı  
Kadıköy, 34744 İstanbul  
Phone: +90 (216) 467 06 40

### VitrA Cologne

Agrippinawerft 24  
D-50678 Köln, Cologne  
Phone: +49 (221) 27 73 68-0  
Fax: +49 (2622) 88 95 500

### VitrA London

Unit 2  
64 Turnmill Street  
EC1M 5RR London  
E-mail: london@vitra.co.uk

### VitrA Moscow

Varshavskoe Highway, 9, Bld.1  
“Danilovskaya Manufaktura” Office Center  
117105 Moscow  
Phone / Fax: +7 (495) 221 76 11

### Attention

When ordering ceramic tiles specify the areas of use.  
Before tile setting, verify the tonality and calibration numbers, claims regarding these indications cannot be accepted after tile setting.  
Crazing of glass borders is a nature of the ceramic tiles.  
It is recommended to use VitrA Fix grout and adhesive materials with VitrA Ceramic Tiles.  
The colours of tiles in the catalogue may not reflect the exact colours of the products.  
For the compatibility of the products to be used with complementary parts, a special order note should be added requesting the simultaneous production of all tiles. There may be a colour tone difference in products produced at different times.  
VitrA Karo San. ve Tic. A.Ş. reserves the right to change the products and technical specifications.

### Dikkat

Seramik karoları sipariş ederken kullanım alanlarını belirtiniz.  
Seramik karoları döşemedenden önce lütfen tonalite ve kalibre numaralarının aynı mekânlar için aynı olmasına dikkat ediniz; döşendikten sonra sorumluluk kabul edilmez.  
Camsı bordürlerde Kraküle (çatlama) olabilme, seramiğin doğasında olan bir unsurdur.  
VitrA Karo Seramikleri ile birlikte VitrA Fix derz dolgu ve yapıştırıcı malzemeleri kullanılması önerilir.  
Katalogdaki ürün renkleri seramik karoların renklerini aynen yansıtmayabilir.  
Tamamlayıcı parçalar ile bu parçaların birlikte döneceği ürünlerin uyumu için sipariş notu düşülerek üretim yapılmalıdır. Farklı zamanlarda üretilen ürünlerde renk tonu farkı olabilir.  
VitrA Karo San. ve Tic. A.Ş.'nin ürünler ve teknik detaylarında değişiklik yapma hakkı saklıdır.

VitrA