

T

ENERGY PRO

INTRODUCTION

As a company we are devoted to creating ideal work environments with minimal expenses and to developing products that can satisfy even the most rigorous of quality and energy efficiency standards. Through compliance with sustainable development principles, our efforts are aimed at Termovent's future evolution.

Cleanroom is an environment that has a controlled level of contamination that is specified by the number of particles per cubic meter for the appropriate particle size.

Termovent specializes in production of modular panel systems, which are used in the field of clean room technology.

The whole system is aligned with GMP and FDA directives, as well as ISO 14644 standard. Compliance with applicable regulations in the field of clean room technology enables its use in rooms from ISO 9 to ISO 1 class (GMP classes A, B, C and D).



OVERVIEW

Production facility:
Kladovo, Serbia

**PART OF
SWISS
CORPORATION
ARBONIA
GROUP**

HQ
**Belgrade
Serbia**

Founded
1993

Modular component systems are easily integrated with all other systems. By combining a variety of materials in panel production for cleanrooms, Termovent company offers a vast range of use in:

Pharmaceutical industry,
Micro-electronics,
Chemical industry,
Food industry,
Health facilities,
Laboratories etc.

A team of young experts that is responsible for cleanrooms development consists of a group of people that participated in international competitions throughout Europe and Asia, and with their experience, hard work and devotion they are responsible for the great satisfaction of our partners.

Through the pursuit of modernization and contemporaneous business, the entire production and design system is based on automation and BiM design.



CONTENT

Introduction	1
Why do you need us	5
Energy high-efficiency units	7
ENERGYpro Adiabatic Basic	11
ENERGYpro Adiabatic Standard	17
ENERGYpro Adiabatic Genius	23
Quality management system	32
Designing recommendation	33

ENERGY PRO GENERAL CHARACTERISTICS

The main characteristics of the Tervovent energy-efficient air handling units are a large return of waste energy, and work with a large amount of fresh air.

The production program of Tervovent energy-efficient AHUs include two main groups:

- Energy:PRO
- Energy:PRO ADIABATIC

With both types of air conditioning units, heat exchange between the streams of waste and fresh air is accomplished with use of two-stage plate heat recovery. Thanks to high energy-efficient two-stage plate heat exchanger, the degree of utilization of the sensible heat reach up to 85%.

The main difference between these two types of energy-efficient air handling units is in the design of two-stage

plate heat exchanger, and adiabatic air humidification. At ENERGY:PRO ADIABATIC unit, unlike ENERGY:PRO, adiabatic humidification of the hot waste air stream is done in a two-stage plate exchanger, decreasing air temperature, and at the same time achieving indirectly adiabatic cooling of fresh air stream. That's why the ENERGY:PRO ADIABATIC units is distinguished by a reduced need of cooling energy in summer period in comparison to ENERGY:PRO.

Depending on air cooling mode in summer period, within each of these two groups, three different AHUs series have been developed : cooling with heat pump, cooling with chilled water coil, and air handling units without cooling. Tervovent energy-efficient air handling units are designed to autonomously maintain optimal microclimate conditions in space. They are design complete with electrical cabinet and necessary peripheral elements of automation.

BENEFITS OF ENERGY-EFFICIENT AIR HANDLING UNITS

- Working with fresh air
- High return of waste air heat
- High energy-efficiency in all operating modes
- Operating modes adapted to external conditions
- Autonomous work
- Maintain optimum microclimate conditions
- Installation of heat pump
- Compact design
- EC direct driven fans

APPLICATION

Due to system performance, they have been found primarily in objects occupied with a large number of people, such as: Public buildings, shopping malls, sports halls and stadiums, hotels and restaurants, industrial buildings...

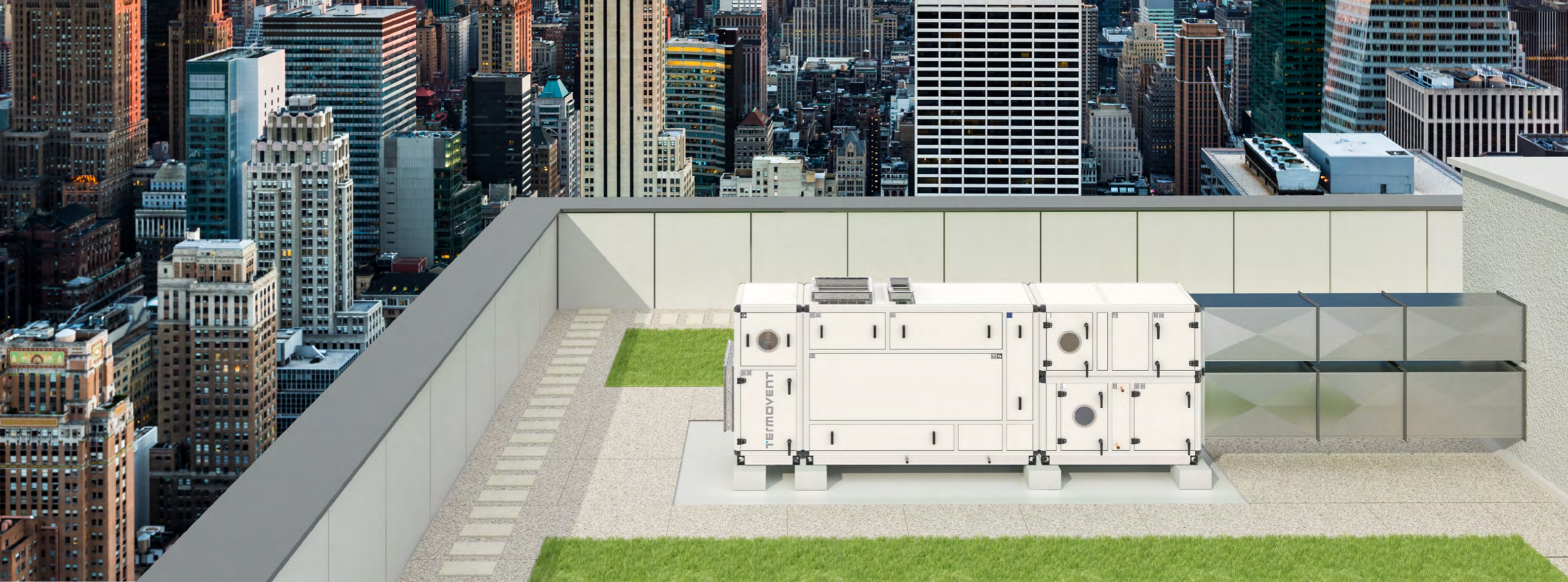

ENERGY:PRO ADIABATIC BASIC

ENERGY:PRO ADIABATIC BASIC are made in 14 sizes with air flow range 800 - 40,000 m³/h. ENERGY:PRO ADIABATIC BASIC is air conditioning unit with two-stage plate heat exchanger and with indirect adiabatic cooling. Additional heating is provided with hot water coil.

ENERGY:PRO ADIABATIC STANDARD

ENERGY:PRO ADIABATIC STANDARD are made in 14 sizes with air flow range 800 - 40,000 m³/h. ENERGY:PRO ADIABATIC STANDARD is air handling unit with two-stage plate heat

exchanger, with indirect adiabatic cooling and additional cooling with chilled water coil. Additional heating is provided with hot water coil.



ENERGY:PRO ADIABATIC GENIUS

ENERGY:PRO ADIABATIC GENIUS are made in 12 sizes with air flow range 2,000 - 40,000 m³/h. ENERGY:PRO ADIABATIC GENIUS is air handling unit with two-stage plate heat exchanger, with indirect adiabatic cooling and integrated heat pump that can be reversible upon request. The installation of a heat pump achieves a higher energy efficiency of the air handling unit in all operating modes, regardless of the external parameters. Additional heating is provided with hot water coil.

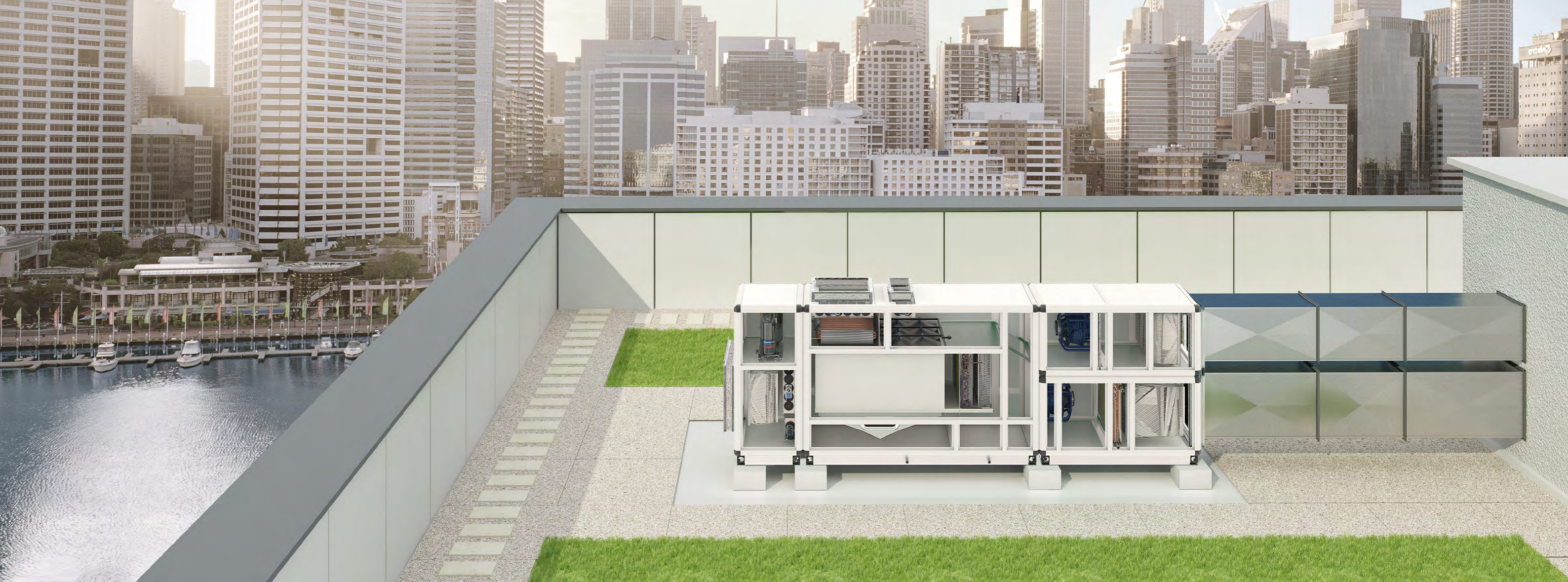

DIRECT DRIVE EC FANS

- Contributes to the reduction of the air handling unit size
- Simple air flow regulation
- Integrated frequency inverter
- High energy efficiency



INTEGRATED HEAT PUMP

- Maximum level of utilisation (COP)
- Compressor with "Inverter" technology
- Evaporator and condenser are made from aluminum fins and copper tubes
- High energy savings
- Indoor humidity regulation independent on outdoor conditions

PLATE HEAT EXCHANGER

- Over 70% energy savings
- Corrosion-free heat exchanger made from polypropylene
 - Low pressure drops
 - No air currents mixing





energy | pro ADIABATIC BASIC

ENERGYpro Adiabatic Basic is comfort air conditioning unit designed for objects with standard thermal loads requirements.

Basic unit uses indirect adiabatic evaporative cooling an achieves to cool up to 40% with water.

Main features		min	max
Nominal air flow	m ³ /h	1350	35000
Adiabatic cooling capacity	kW	5	140
Heat exchanger recovery rate [EN 308]	%	60	85

energy | pro Adiabatic Basic | AHU airflow diagram

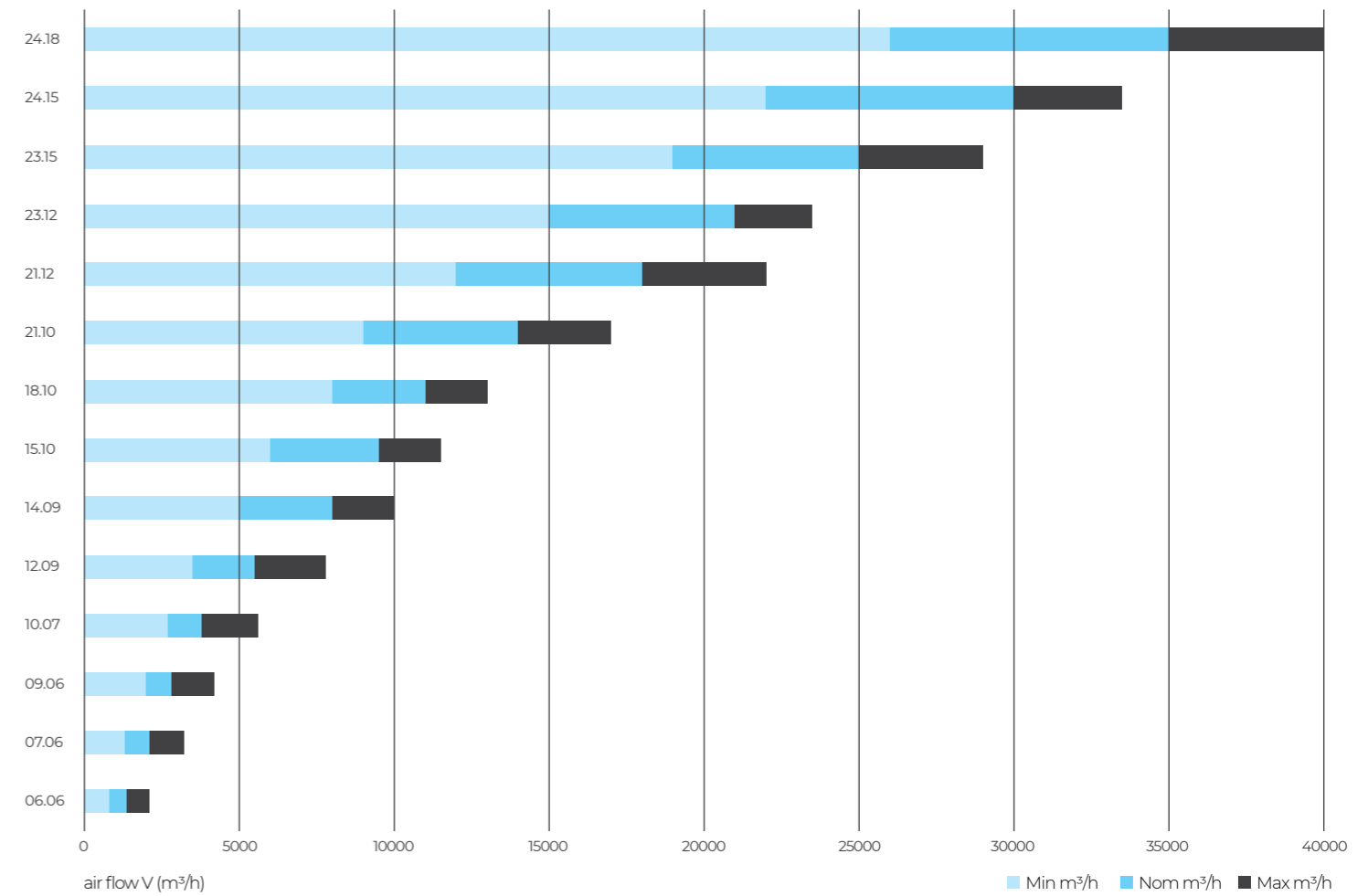

Unit type		06.06	07.06	09.06	10.07	12.09	14.09	15.10	18.10	21.10	21.12	23.12	23.15	24.15	24.18
Min	m ³ /h	800	1300	2000	2700	3500	5000	6000	8000	9000	12000	15000	19000	22000	26000
Nom	m ³ /h	1350	2100	2800	3800	5500	8000	9500	11000	14000	18000	21000	25000	30000	35000
Max	m ³ /h	2100	3200	4200	5600	7800	10000	11500	13000	17000	22000	23500	29000	33500	40000

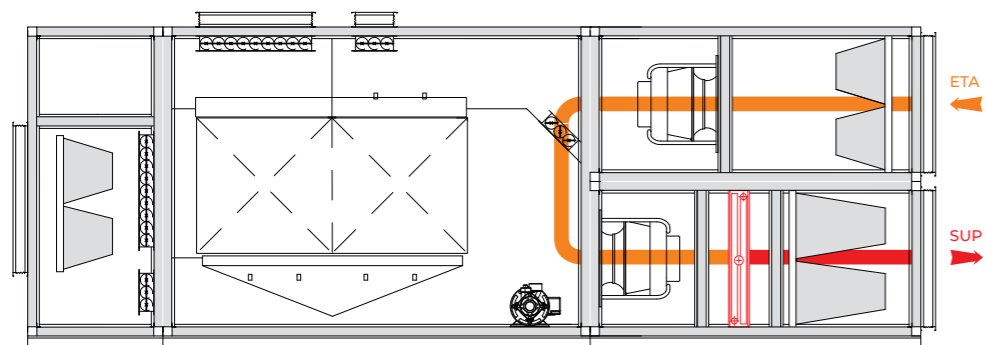

STARTING MODE FOR FAST HEATING IN WINTER PERIOD

Working mode with 100% recirculation air heated via hot water heater. In this mode the outdoor and exhaust air dampers are closed. This mode is common for rooms that are not used all the time and which can be heated up very quickly.

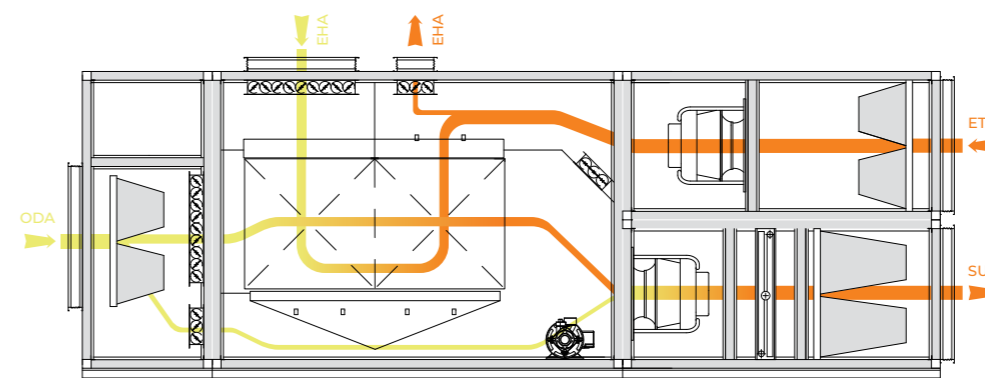

TRANSITIONAL PERIOD

In transitional period of year, fresh air is treated only with two-stage plate heat exchanger. Some amount or 100% of fresh air is going through plate heat exchanger. In case that only some amount going through plate heat exchanger, the rest is going through bypass, and then these two flows are mixing before going to room. With dampers on return, supply and bypass system can achieve desired conditions of

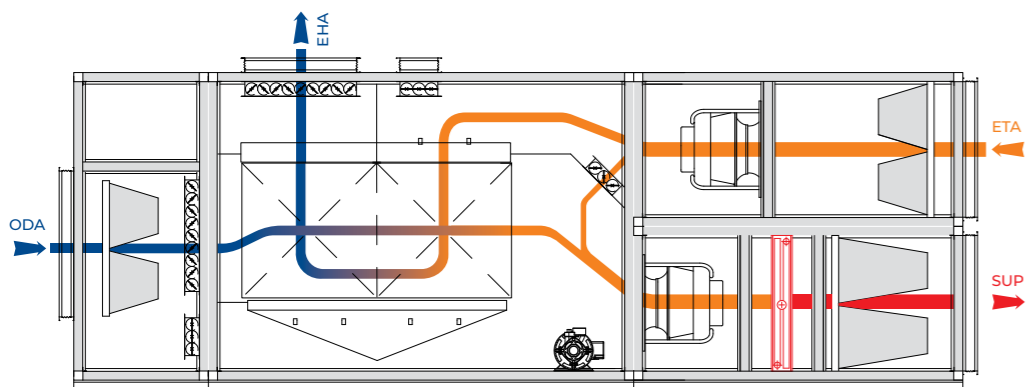

WINTER MODE

In wintertime, system is working completely with two-stage plate heat recovery exchanger. On request heating coil covers ventilation and transmission heat losses of the building. When the outside temperatures are very low for which system is not calculated, system is using small portion of recirculation air for mixing with fresh air. In this way ventilation losses are reduced, and in the same time necessary heating of fresh air is also reduced. On request system can work with some portion of recirculation air in winter mode when 100% of fresh air is not necessary.

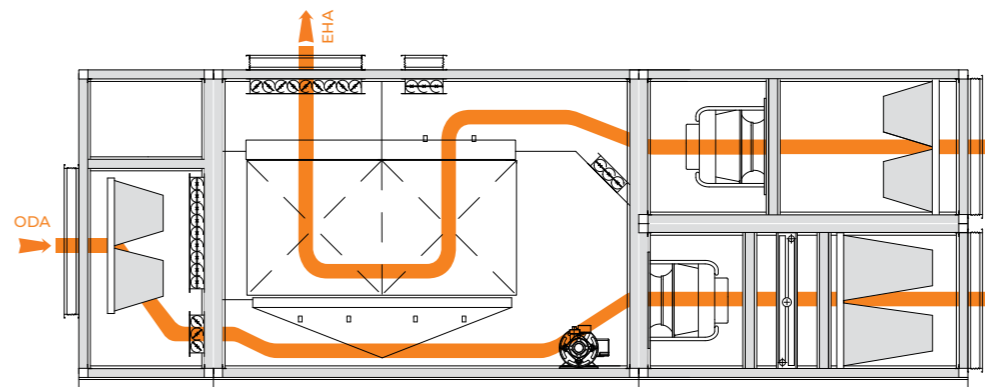

FREE COOLING

If outside temperatures continue to rise system is working with 100% fresh air that bypassed the plate heat exchanger. System is working with less pressure drop and therefore less power consumption of fans.

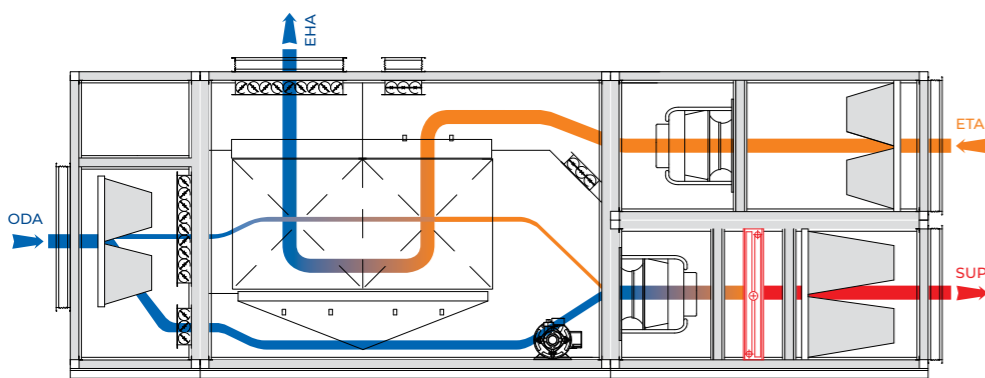

DEFROSTING MODE

In period of low outside temperatures, during cooling and separating moisture from return air, plate heat exchanger tend to ice. In defrost mode, bypass will open on fresh air side. Reducing of fresh air quantity that flows through plate heat exchanger, cooling of return air is reduced. The heat contained in the return air melts any ice in the plate heat exchanger, while the airflow rate of fresh air routed past the plate heat exchanger is regulated as required.

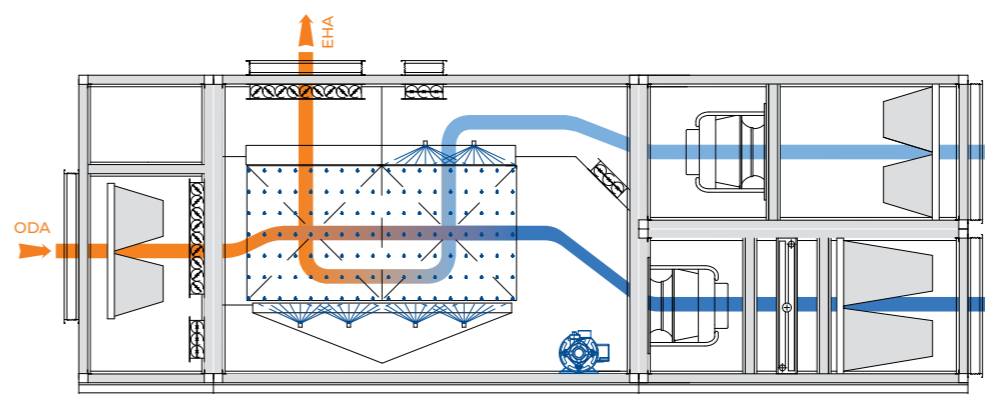

SUMMER MODE

With indirect "Adiabatic" evaporative cooling it is achieved cooling of fresh air. Warm fresh air flow through double plate heat exchanger gives heat to adiabatic cooled down return air, and this way is cooled down. Outside air is cooled down without being humidified. The high efficiency rate is provided thanks to both processes ("adiabatic" evaporative cooling of the return air + cooling of the outside air) take place simultaneously in the double plate heat exchanger. The high degree of temperature efficiency of the double plate heat exchanger allows significant cooling of the outside air (heat recovery rate more than 80%).

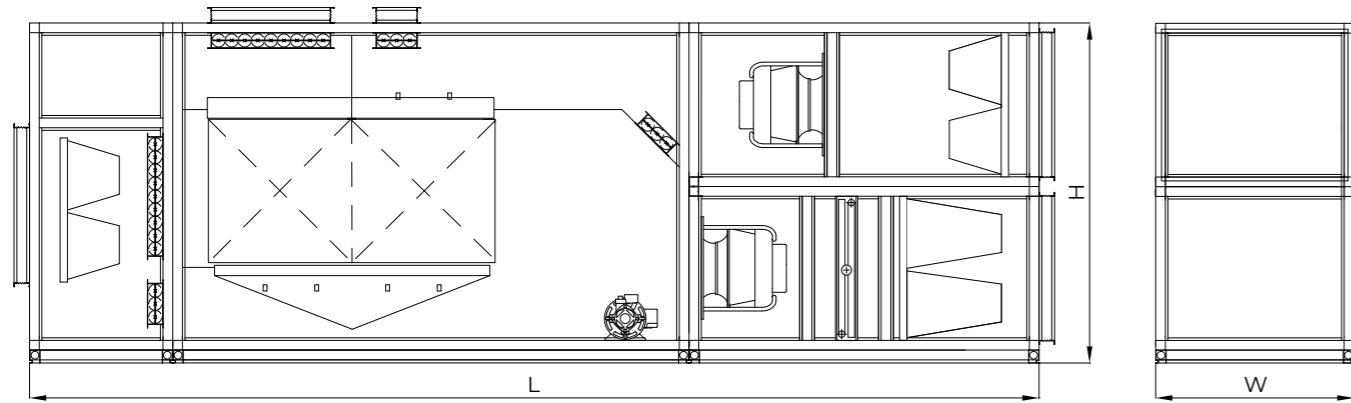

Unit type	Nominal air flow	Dimensions		
		W (mm)	H (mm)	L (mm)
	m ³ /h			
06.06	1350	720	1730	4300
07.06	2100	820	1830	4550
09.06	2800	1025	1830	4600
10.07	3800	1125	1930	4700
12.09	5500	1330	2340	5000
14.09	8000	1530	2340	5500
15.10	9500	1635	2540	5700
18.10	11000	1940	2540	5900
21.10	14000	2245	2540	6200
21.12	18000	2245	2950	6500
23.12	21000	2445	2950	6500
23.15	25000	2445	3560	7100
24.15	30000	2550	3560	7300
24.18	35000	2550	4170	7900

* Dimensions vary depending on selected execution (indoor/outdoor, type of PHE,...)

		Unit type													
		06.06	07.06	09.06	10.07	12.09	14.09	15.10	18.10	21.10	21.12	23.12	23.15	24.15	24.18

Nominal air flow	m ³ /h	1350	2100	2800	3800	5500	8000	9500	11000	14000	18000	21000	25000	30000	35000
------------------	-------------------	------	------	------	------	------	------	------	-------	-------	-------	-------	-------	-------	-------

Filtration according to EN 779:2012|ISO 16890

Fresh / Supply air	M5 / F7 ePM10 60% / ePM1 60%
--------------------	--------------------------------

Return air	M5 ePM10 60%
------------	----------------

Double plate heat exchanger

Material	Polypropylene
----------	---------------

Energy efficiency according to DIN EN 13053 ¹	%	73	72	71	71	70	69	69	70	70	70	69	69	70	70
--	---	----	----	----	----	----	----	----	----	----	----	----	----	----	----

Heat recovery rate winter/summer according to EN 308 ¹	%	79/85	79/85	78/85	78/85	79/85	78/85	78/85	76/85	82/88	80/86	79/85	81/86	82/87	84/89
---	---	-------	-------	-------	-------	-------	-------	-------	-------	-------	-------	-------	-------	-------	-------

Evaporative cooling

Cooling capacity	kW	5.1	7.9	10.6	14.3	20.7	30.1	35.8	41.4	54.6	69.0	79.1	95.8	116.0	138.8
------------------	----	-----	-----	------	------	------	------	------	------	------	------	------	------	-------	-------

Water flow rate	m ³ /h	8	12	16	22	32	46	55	63	81	103	115	138	171	199
-----------------	-------------------	---	----	----	----	----	----	----	----	----	-----	-----	-----	-----	-----

Hot water coil^{2,3}

Heating capacity	kW	5.35	8.26	11.32	15.09	21.79	32.34	37.69	43.32	50.67	68.28	81.42	93.67	109.38	118.91
------------------	----	------	------	-------	-------	-------	-------	-------	-------	-------	-------	-------	-------	--------	--------

Water flow rate	m ³ /h	0.47	0.72	0.99	1.32	1.90	2.82	3.29	3.78	4.42	5.95	7.10	8.16	9.53	10.36
-----------------	-------------------	------	------	------	------	------	------	------	------	------	------	------	------	------	-------

Water pressure drop	kPa	1.97	1.41	1.94	2.51	2.52	3.84	3.88	4.87	4.20	5.05	6.08	5.82	6.22	5.94
---------------------	-----	------	------	------	------	------	------	------	------	------	------	------	------	------	------

Connections	DN	20	25	25	25	32	32	40	40	40	50	50	50	65	65
-------------	----	----	----	----	----	----	----	----	----	----	----	----	----	----	----

External pressure drop *

Fresh and supply air duct	Pa	800	1000	800	700	850	950	600	900	800	700	550	850	700	700
---------------------------	----	-----	------	-----	-----	-----	-----	-----	-----	-----	-----	-----	-----	-----	-----

Return and exhaust air duct	Pa	800	1000	1200	950	850	800	1250	900	600	1200	450	700	650	700
-----------------------------	----	-----	------	------	-----	-----	-----	------	-----	-----	------	-----	-----	-----	-----

Device data

Rated input - supply air fan ⁴	kW	1.05	1.8	1.92	2.50	3.38	5.70	5.70	11.00	11.00	12.00	11.40	22.00	22.00	24.00
---	----	------	-----	------	------	------	------	------	-------	-------	-------	-------	-------	-------	-------

Rated input - return air fan ⁴	kW	0.75	1.29	1.80	1.92	2.50	3.45	5.70	5.00	5.00	12.00	6.90	10.00	13.50	15.40
---	----	------	------	------	------	------	------	------	------	------	-------	------	-------	-------	-------

Rated input - pump for evaporative cooling	kW	0.55	0.55	0.55	0.55	0.72	0.72	0.72	1.00	1.00	1.00	1.68	1.68	1.68	1.68
--	----	------	------	------	------	------	------	------	------	------	------	------	------	------	------

Total electrical power rating	kW	2.35	3.64	4.27	4.97	6.60	9.87	12.12	17.00	17.00	25.00	19.98	33.68	37.18	41.08
-------------------------------	----	------	------	------	------	------	------	-------	-------	-------	-------	-------	-------	-------	-------

Total current consumption	A	6.0	5.9	13.8	15.7	22.3	32.3	35.7	47.5	48.5	73	73.5	96.3	107.5	131.7
---------------------------	---	-----	-----	------	------	------	------	------	------	------	----	------	------	-------	-------

Sound power level - supply ⁴	dB(A)	64.1	65.8	66.0	69.1	72.1	75.0	75.5	76.5	77.7	76.1	79.2	79.5	81.4	78.9
---	-------	------	------	------	------	------	------	------	------	------	------	------	------	------	------

Sound power level - return ⁴	dB(A)	54.2	56.8	62.2	63.0	64.3	67.8	72.8	69.1	74.7	71.0	79.4	74.4	75.3	77.1
---	-------	------	------	------	------	------	------	------	------	------	------	------	------	------	------

Acoustic pressure at a distance of 1 m from the device ⁴	dB(A)	52.2	51.8	51.9	54.3	56.8	59.3	60.0	61.7	62.8	62.3	63.8	65.3	67.1	65.2
---	-------	------	------	------	------	------	------	------	------	------	------	------	------	------	------

SFPint	W/m ³ /s	514	545	690	785	810	912	1161	1247	1369	1238	1210	1321	1534	1225
--------	---------------------	-----	-----	-----	-----	-----	-----	------	------	------	------	------	------	------	------

Operating voltage	3~380-480V 50/60 Hz													
-------------------	---------------------	--	--	--	--	--	--	--	--	--	--	--	--	--

- 1. The data is valid for the following parameters:

Indoor conditions winter mode	20°C/40%
Indoor conditions summer mode	26°C/55%
Outdoor temperature and relative humidity winter mode	-12°C/90%
Outdoor temperature and relative humidity summer mode	33°C/33%
 - 2 At supply temperature 25°C for nominal air flow, FL = 55 °C , SA=45 °C
 - 3 Inlet conditions after double plate heat exchanger
 - 4 For external pressure drop 200 Pa with average filter contamination
- * Max allowed pressure drop in duct system at nominal air flow

Please seek approval of technical data and specifications prior to start of the planning process.



energy | pro ADIABATIC STANDARD

ENERGYpro Adiabatic Standard is comfort air conditioning unit designed for objects with high thermal loads requirements.

Standard unit uses indirect adiabatic evaporative cooling an achieves to cool up to 40% with water. Additional cooling capacity is further enhanced with a water cooling coil.

Main features		min	max
Nominal air flow	m ³ /h	1350	35000
Adiabatic cooling capacity	kW	5	140
Heat exchanger recovery rate [EN 308]	%	60	85

energy | pro Adiabatic Standard | AHU airflow diagram

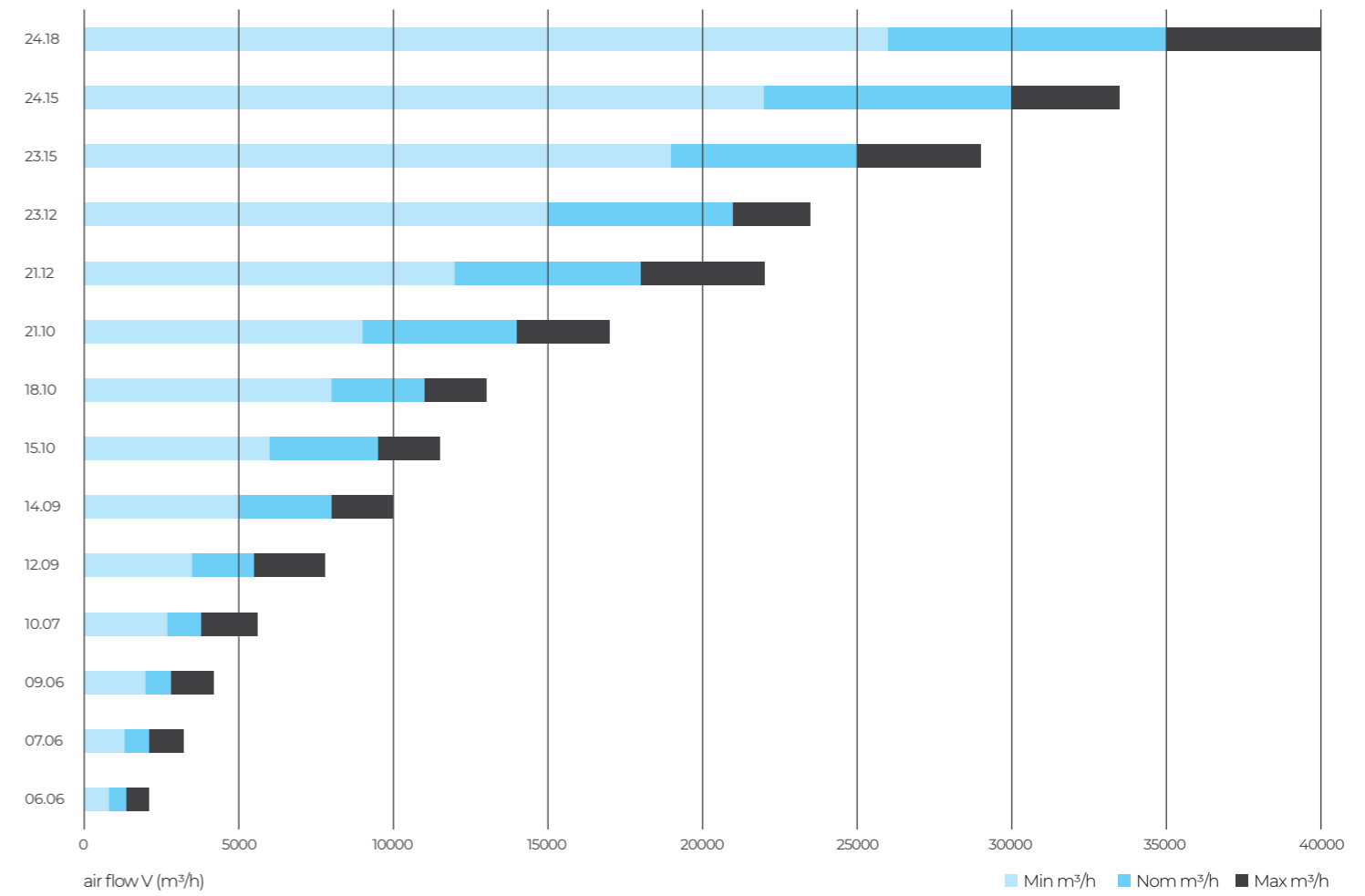

Unit type		06.06	07.06	09.06	10.07	12.09	14.09	15.10	18.10	21.10	21.12	23.12	23.15	24.15	24.18
Min	m ³ /h	800	1300	2000	2700	3500	5000	6000	8000	9000	12000	15000	19000	22000	26000
Nom	m ³ /h	1350	2100	2800	3800	5500	8000	9500	11000	14000	18000	21000	25000	30000	35000
Max	m ³ /h	2100	3200	4200	5600	7800	10000	11500	13000	17000	22000	23500	29000	33500	40000

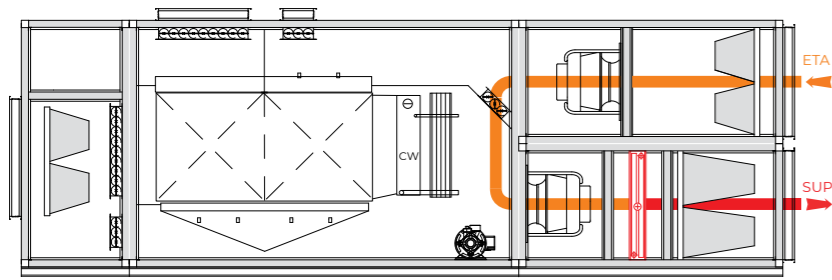

STARTING MODE FOR FAST HEATING IN WINTER PERIOD

Working mode with 100% recirculation air heated via hot water heater. In this mode the outdoor and exhaust air dampers are closed. This mode is common for rooms that are not used all the time and which can be heated up very quickly.

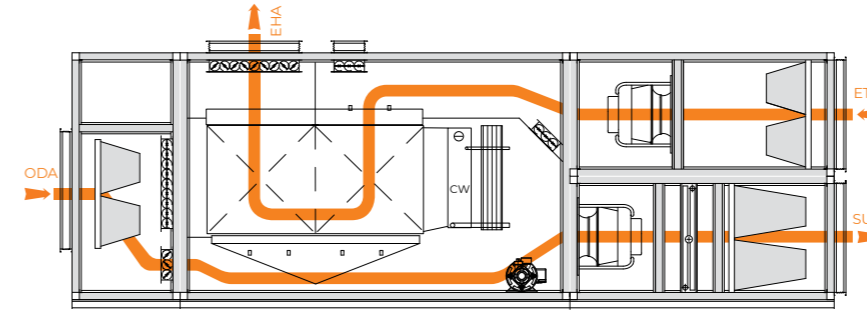

FREE COOLING

If outside temperatures continue to rise system is working with 100% fresh air that bypassed the plate heat exchanger. System is working with less pressure drop and therefore less power consumption of fans.

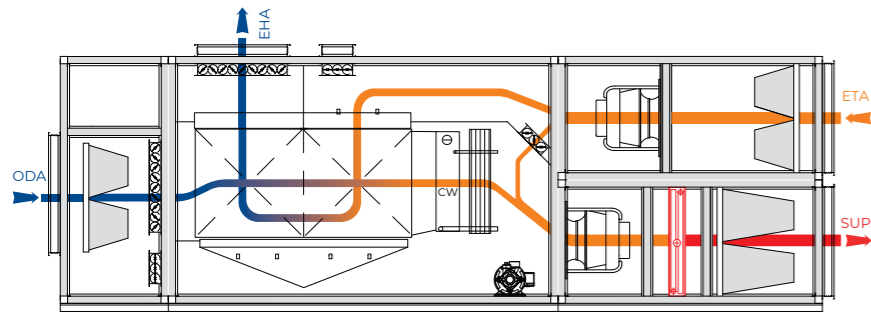

WINTER MODE

In wintertime, system is working completely with two-stage plate heat recovery exchanger. On request heating coil covers ventilation and transmission heat losses of the building. When the outside temperatures are very low for which system is not calculated, system is using small portion of recirculation air for mixing with fresh air. In this way ventilation losses are reduced, and in the same time necessary heating of fresh air is also reduced. On request system can work with some portion of recirculation air in winter mode when 100% of fresh air is not necessary.

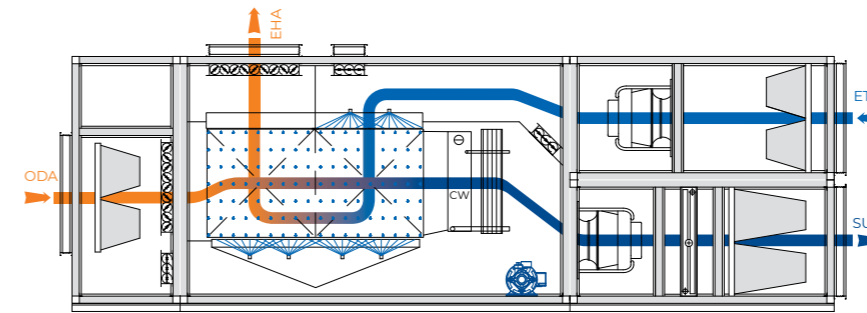

SUMMER MODE

With indirect "Adiabatic" evaporative cooling it is achieved cooling of fresh air. Warm fresh air flow through double plate heat exchanger gives heat to adiabatic cooled down return air, and this way is cooled down. Outside air is cooled down without being humidified. The high efficiency rate is provided thanks to both processes ("adiabatic" evaporative cooling of the return air + cooling of the outside air) take place simultaneously in the double plate heat exchanger. The high degree of temperature efficiency of the double plate heat exchanger allows significant cooling of the outside air (heat recovery rate more than 80%).

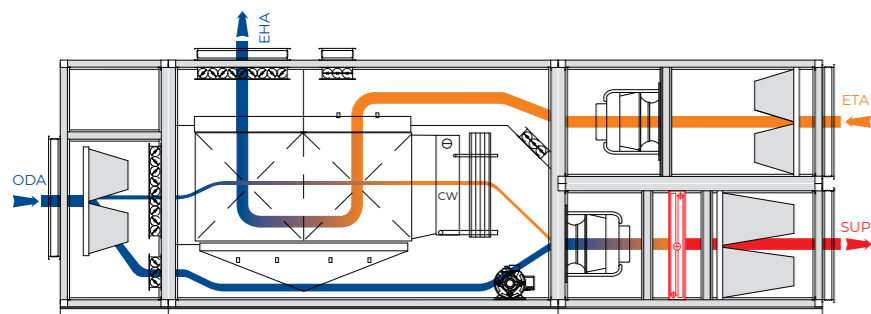

DEFROSTING MODE

In period of low outside temperatures, during cooling and separating moisture from return air, plate heat exchanger tend to ice. In defrost mode, bypass will open on fresh air side. Reducing of fresh air quantity that flows through plate heat exchanger, cooling of return air is reduced. The heat contained in the return air melts any ice in the plate heat exchanger, while the airflow rate of fresh air routed past the plate heat exchanger is regulated as required.

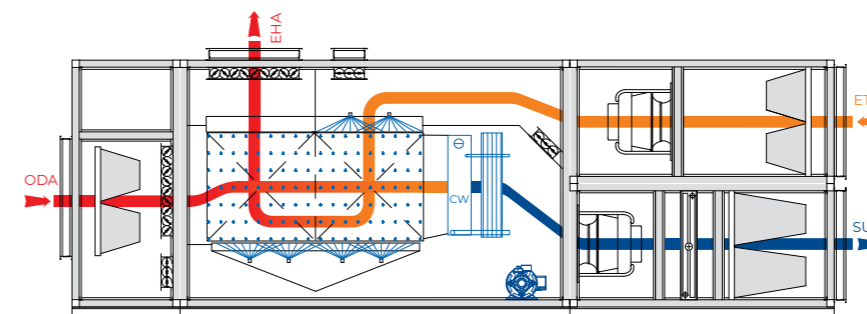

SUMMER MODE WITH HIGHER OUTDOOR TEMPERATURES

When the system with double plate heat exchanger and indirect adiabatic cooling is not enough to eliminate heat gains, additional cooling of outside air is provided with water cooling coil.

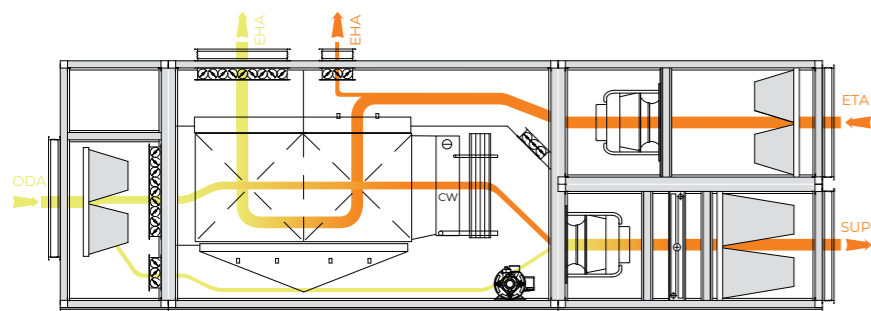

TRANSITIONAL PERIOD

In transitional period of year, fresh air is treated only with two-stage plate heat exchanger. Some amount or 100% of fresh air is going through plate heat exchanger. In case that only some amount going through plate heat exchanger, the rest is going through bypass, and then these two flows are mixing before going to room. With dampers on return, supply and bypass system can achieve desired conditions of supply air.

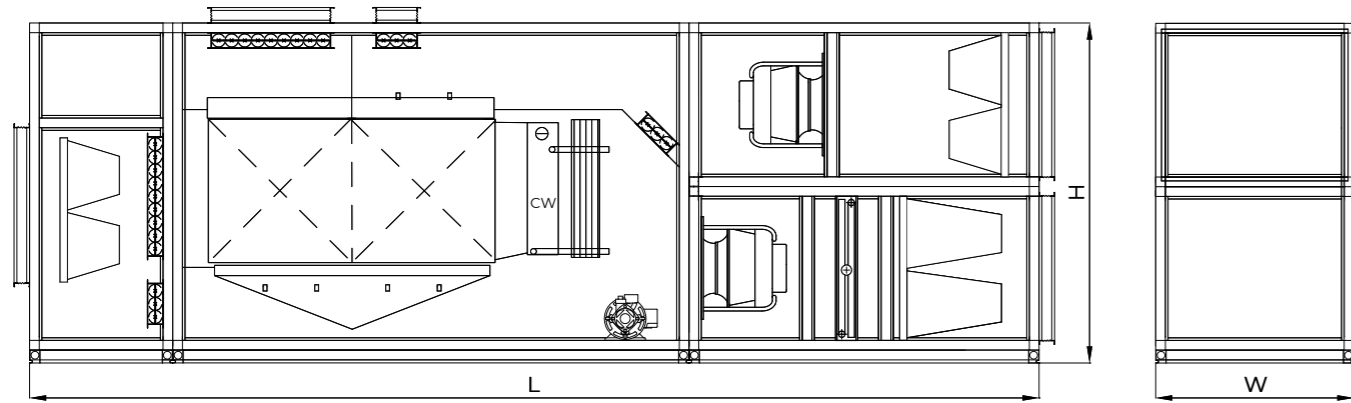

Unit type	Nominal air flow	Dimensions		
		W (mm)	H (mm)	L (mm)
06.06	1350	720	1730	4600
07.06	2100	820	1830	4850
09.06	2800	1025	1830	4900
10.07	3800	1125	1930	5100
12.09	5500	1330	2340	5500
14.09	8000	1530	2340	6000
15.10	9500	1635	2540	6300
18.10	11000	1940	2540	6500
21.10	14000	2245	2540	6700
21.12	18000	2245	2950	7000
23.12	21000	2445	2950	7000
23.15	25000	2445	3560	7600
24.15	30000	2550	3560	7900
24.18	35000	2550	4170	8500

* Dimensions vary depending on selected execution (indoor/outdoor, type of PHE,...)

	Unit type													
	06.06	07.06	09.06	10.07	12.09	14.09	15.10	18.10	21.10	21.12	23.12	23.15	24.15	24.18

Nominal air flow	m ³ /h	1350	2100	2800	3800	5500	8000	9500	11000	14000	18000	21000	25000	30000	35000
------------------	-------------------	------	------	------	------	------	------	------	-------	-------	-------	-------	-------	-------	-------

Filtration according to EN 779:2012|ISO 16890

Fresh / Supply air M5 / F7 | ePM10 60% / ePM1 60%

Return air M5 | ePM10 60%

Double plate heat exchanger

Material Polypropylene

Energy efficiency according to DIN EN 13053 ¹	%	73	72	71	71	70	69	69	70	70	70	69	69	70	84/89
--	---	----	----	----	----	----	----	----	----	----	----	----	----	----	-------

Heat recovery rate winter/summer according to EN 308 ¹	%	79/85	79/85	78/85	78/85	79/85	78/85	78/85	76/85	82/88	80/86	79/85	81/86	82/87	84/89
---	---	-------	-------	-------	-------	-------	-------	-------	-------	-------	-------	-------	-------	-------	-------

Evaporative cooling

Cooling capacity	kW	5.1	7.9	10.6	14.3	20.7	30.1	35.8	41.4	54.6	69.0	79.1	95.8	116.0	138.8
------------------	----	-----	-----	------	------	------	------	------	------	------	------	------	------	-------	-------

Water flow rate	m ³ /h	8	12	16	22	32	46	55	63	81	103	115	138	171	199
-----------------	-------------------	---	----	----	----	----	----	----	----	----	-----	-----	-----	-----	-----

Cold water coil^{2,5}

Cooling capacity	kW	3.23	5.13	6.92	9.14	13.44	19.42	23.37	26.94	31.97	42.91	51.00	57.80	70.43	77.75
------------------	----	------	------	------	------	-------	-------	-------	-------	-------	-------	-------	-------	-------	-------

Water flow rate	m ³ /h	0.55	0.88	1.19	1.57	2.31	3.33	4.01	4.62	5.48	7.36	8.75	9.92	12.08	13.34
-----------------	-------------------	------	------	------	------	------	------	------	------	------	------	------	------	-------	-------

Water pressure drop	kPa	2.61	2.5	3.62	3.30	4.17	5.51	6.08	6.89	6.81	6.61	7.21	6.96	8.18	7.78
---------------------	-----	------	-----	------	------	------	------	------	------	------	------	------	------	------	------

Connections	DN	20	25	25	32	32	40	40	40	50	50	65	65	65	65
-------------	----	----	----	----	----	----	----	----	----	----	----	----	----	----	----

Hot water coil^{3,5}

Heating capacity	kW	5.35	8.26	11.32	15.09	21.79	32.34	37.69	43.32	50.67	68.28	81.42	93.67	109.38	118.91
------------------	----	------	------	-------	-------	-------	-------	-------	-------	-------	-------	-------	-------	--------	--------

Water flow rate	m ³ /h	0.47	0.72	0.99	1.32	1.90	2.82	3.29	3.78	4.42	5.95	7.10	8.16	9.53	10.36
-----------------	-------------------	------	------	------	------	------	------	------	------	------	------	------	------	------	-------

Water pressure drop	kPa	1.97	1.41	1.94	2.51	2.52	3.84	3.88	4.87	4.20	5.05	6.08	5.82	6.22	5.94
---------------------	-----	------	------	------	------	------	------	------	------	------	------	------	------	------	------

Connections	DN	20	25	25	25	32	32	40	40	40	50	50	50	65	65
-------------	----	----	----	----	----	----	----	----	----	----	----	----	----	----	----

External pressure drop *

Fresh and supply air duct	Pa	700	950	750	650	750	900	550	850	750	650	500	800	650	650
---------------------------	----	-----	-----	-----	-----	-----	-----	-----	-----	-----	-----	-----	-----	-----	-----

Return and exhaust air duct	Pa	800	1000	1200	950	850	800	1250	900	600	1200	450	700	650	700
-----------------------------	----	-----	------	------	-----	-----	-----	------	-----	-----	------	-----	-----	-----	-----

Device data

Rated input - supply air fan ⁴	kW	1.05	1.8	1.92	2.50	3.38	5.70	5.70	11.00	11.00	12.00	11.40	22.00	22.00	24.00
---	----	------	-----	------	------	------	------	------	-------	-------	-------	-------	-------	-------	-------

Rated input - return air fan ⁴	kW	0.75	1.29	1.80	1.92	2.50	3.45	5.70	5.00	5.00	12.00	6.90	10.00	13.50	15.40
---	----	------	------	------	------	------	------	------	------	------	-------	------	-------	-------	-------

Rated input - pump for evaporative cooling	kW	0.55	0.55	0.55	0.55	0.72	0.72	0.72	1.00	1.00	1.00	1.68	1.68	1.68	1.68
--	----	------	------	------	------	------	------	------	------	------	------	------	------	------	------

Total electrical power rating	kW	2.35	3.64	4.27	4.97	6.60	9.87	12.12	17.00	17.00	25.00	19.98	33.68	37.18	41.08
-------------------------------	----	------	------	------	------	------	------	-------	-------	-------	-------	-------	-------	-------	-------

Total current consumption	A	6.0	5.9	13.8	15.7	22.3	32.3	35.7	47.5	48.5	73	73.5	96.3	107.5	131.7
---------------------------	---	-----	-----	------	------	------	------	------	------	------	----	------	------	-------	-------

Sound power level - supply ⁴	dB(A)	66.6	67.3	66.7	70.8	72.9	75.5	76.2	76.9	77.9	76.5	79.6	80.1	81.8	79.3
---	-------	------	------	------	------	------	------	------	------	------	------	------	------	------	------

Sound power level - return ⁴	dB(A)	54.0	56.7	62.2	63.0	64.3	67.8	72.8	69.1	74.7	71.0	79.4	74.4	75.3	77.1
---	-------	------	------	------	------	------	------	------	------	------	------	------	------	------	------

Acoustic pressure at a distance of 1 m from the device ⁴	dB(A)	55.4	54.6	52.3	56.0	57.8	59.9	60.6	62.1	63.0	62.8	64.2	65.9	67.4	65.7
---	-------	------	------	------	------	------	------	------	------	------	------	------	------	------	------

SFPint	W/m ³ /s	514	545	690	785	810	912	1161	1247	1369	1238	1210	1321	1534	1225
--------	---------------------	-----	-----	-----	-----	-----	-----	------	------	------	------	------	------	------	------

Operating voltage 3-380-480V 50/60 Hz

1. The data is valid for the following parameters:

Indoor conditions winter mode 20°C/40%

Indoor conditions summer mode 26°C/55%

Outdoor temperature and relative humidity winter mode -12°C/90%

Outdoor temperature and relative humidity summer mode 33°C/33%

- At supply temperature 16°C for nominal air flow, FL = 7 °C , SA = 12 °C
- At supply temperature 25°C for nominal air flow, FL = 55 °C , SA=45 °C
- For external pressure drop 200 Pa with average filter contamination
- Inlet conditions after double plate heat exchanger
- * Max allowed pressure drop in duct system at nominal air flow

Please seek approval of technical data and specifications prior to start of the planning process.



energy | pro ADIABATIC GENIUS

ENERGYpro Adiabatic Genius is comfort air conditioning unit designed for objects with higher thermal loads requirements.

Genius unit uses indirect adiabatic evaporative cooling and achieves to cool up to 40% with water. Additional cooling capacity is further enhanced with an integrated compression refrigeration system.

Main features		min	max
Nominal air flow	m ³ /h	2800	35000
Adiabatic cooling capacity	kW	5	140
Heat exchanger recovery rate [EN 308]	%	60	85

energy | pro Adiabatic Genius | AHU airflow diagram

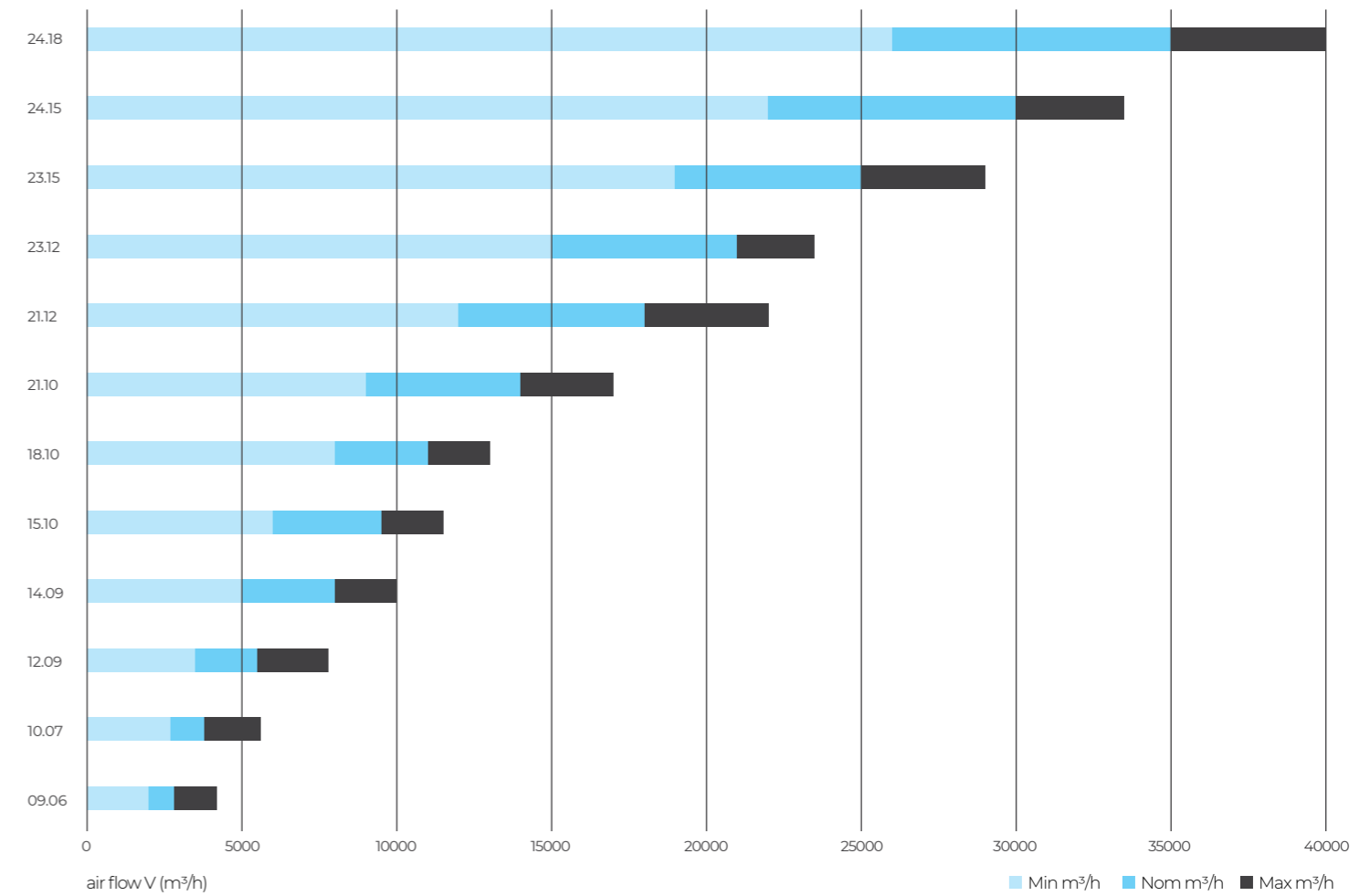

Unit type		09.06	10.07	12.09	14.09	15.10	18.10	21.10	21.12	23.12	23.15	24.15	24.18
Min	m ³ /h	2000	2700	3500	5000	6000	8000	9000	12000	15000	19000	22000	26000
Nom	m ³ /h	2800	3800	5500	8000	9500	11000	14000	18000	21000	25000	30000	35000
Max	m ³ /h	4200	5600	7800	10000	11500	13000	17000	22000	23500	29000	33500	40000

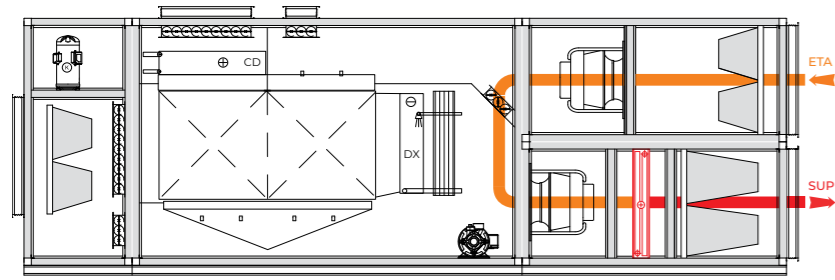

STARTING MODE FOR FAST HEATING IN WINTER PERIOD

Working mode with 100% recirculation air heated via hot water heater. In this mode the outdoor and exhaust air dampers are closed. This mode is common for rooms that are not used all the time and which can be heated up very quickly.

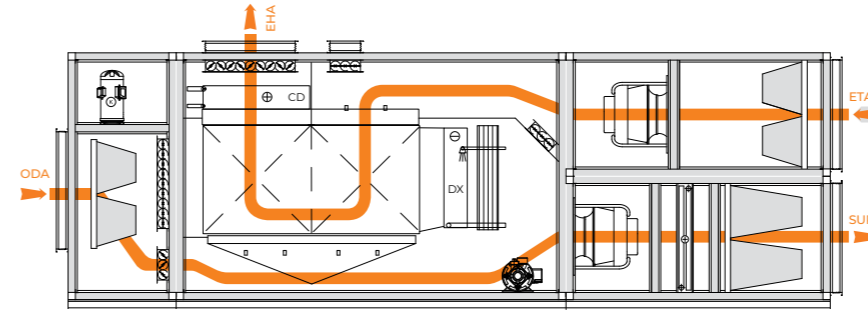

FREE COOLING

If outside temperatures continue to rise system is working with 100% fresh air that bypassed the plate heat exchanger. System is working with less pressure drop and therefore less power consumption of fans.

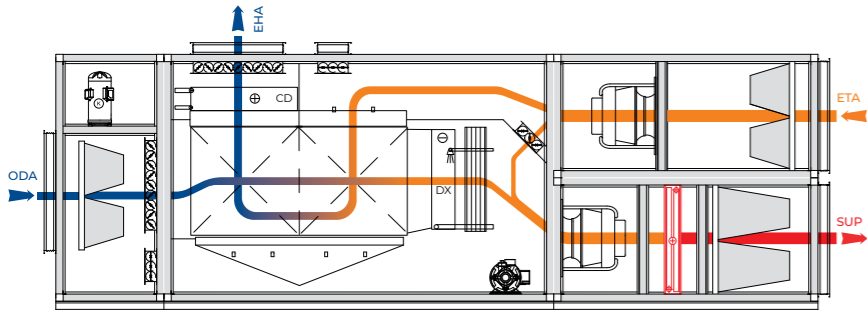

WINTER MODE

In wintertime, system is working completely with two-stage plate heat recovery exchanger. On request heating coil covers ventilation and transmission heat losses of the building. When the outside temperatures are very low for which system is not calculated, system is using small portion of recirculation air for mixing with fresh air. In this way ventilation losses are reduced, and in the same time necessary heating of fresh air is also reduced. On request system can work with some portion of recirculation air in winter mode when 100% of fresh air is not necessary.

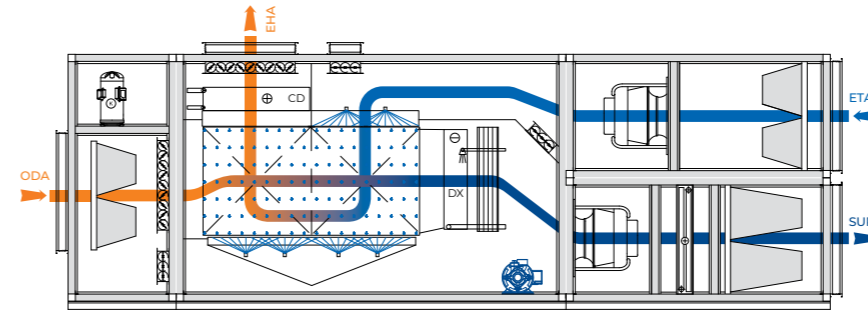

SUMMER MODE

With indirect "Adiabatic" evaporative cooling it is achieved cooling of fresh air. Warm fresh air flow through double plate heat exchanger gives heat to adiabatic cooled down return air, and this way is cooled down. Outside air is cooled down without being humidified. The high efficiency rate is provided thanks to both processes ("adiabatic" evaporative cooling of the return air + cooling of the outside air) take place simultaneously in the double plate heat exchanger. The high degree of temperature efficiency of the double plate heat exchanger allows significant cooling of the outside air (heat recovery rate more than 80%).

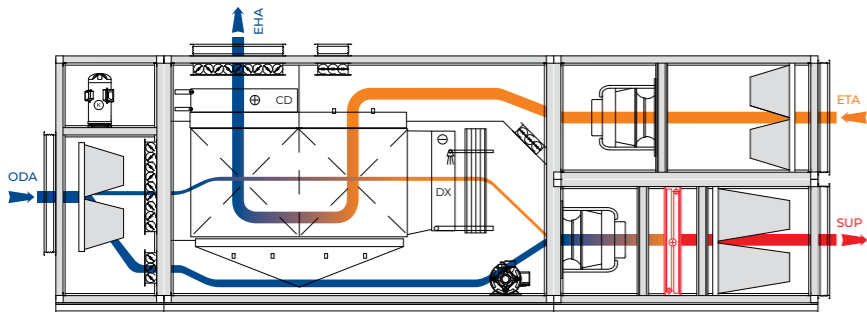

DEFROSTING MODE

In period of low outside temperatures, during cooling and separating moisture from return air, plate heat exchanger tend to ice. In defrost mode, bypass will open on fresh air side. Reducing of fresh air quantity that flows through plate heat exchanger, cooling of return air is reduced. The heat contained in the return air melts any ice in the plate heat exchanger, while the airflow rate of fresh air routed past the plate heat exchanger is regulated as required.

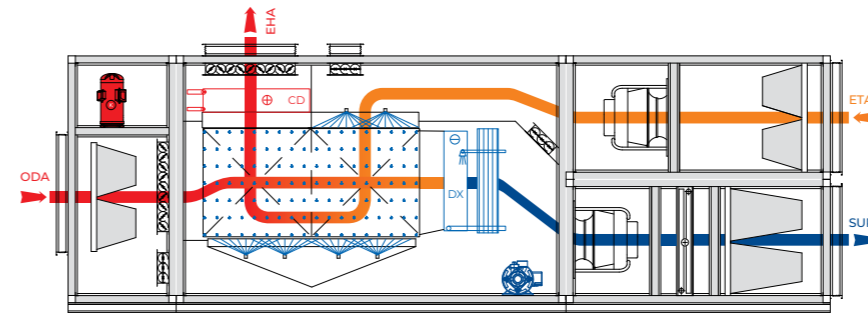

SUMMER MODE WITH HIGHER OUTDOOR TEMPERATURES

When the system with double plate heat exchanger and indirect adiabatic cooling is not enough to eliminate heat gains, additional cooling of outside air is provided with heat pump.

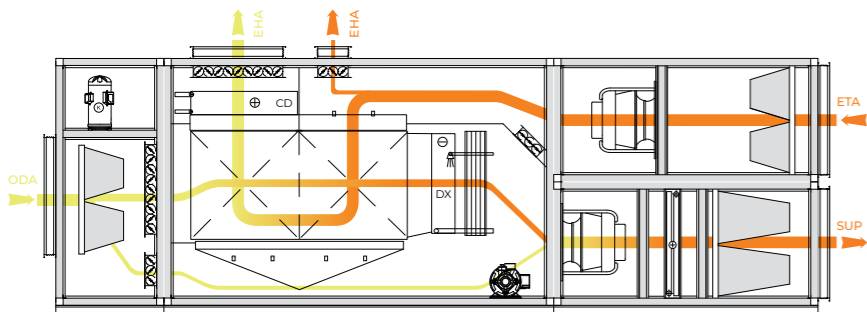

TRANSITIONAL PERIOD

In transitional period of year, fresh air is treated only with two-stage plate heat exchanger. Some amount or 100% of fresh air is going through plate heat exchanger. In case that only some amount going through plate heat exchanger, the rest is going through bypass, and then these two flows are mixing before going to room. With dampers on return, supply and bypass system can achieve desired conditions of supply air.

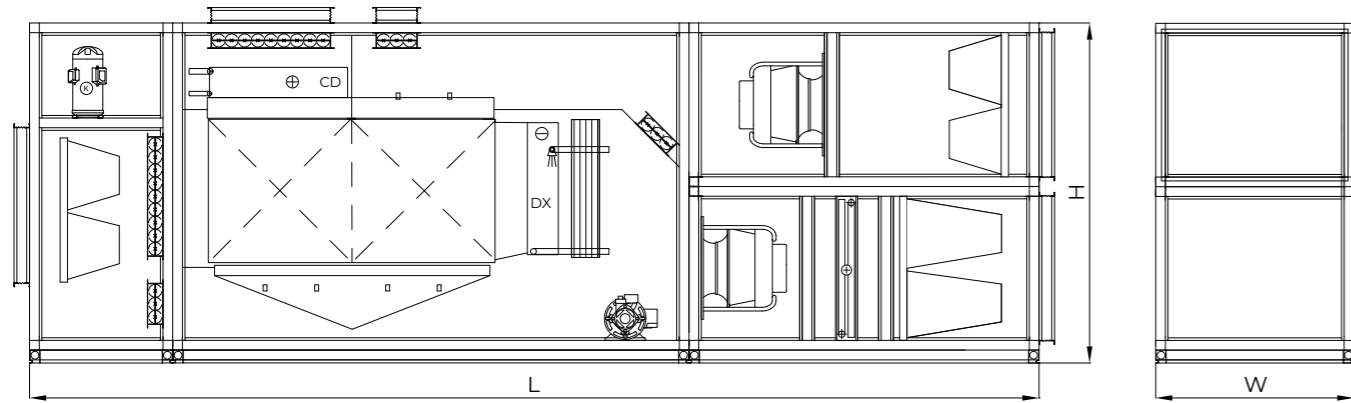

Unit type	Nominal air flow	Dimensions		
		W (mm)	H (mm)	L (mm)
09.06	2800	1025	1830	4900
10.07	3800	1125	1930	5100
12.09	5500	1330	2340	5500
14.09	8000	1530	2340	6000
15.10	9500	1635	2540	6300
18.10	11000	1940	2540	6500
21.10	14000	2245	2540	6700
21.12	18000	2245	2950	7000
23.12	21000	2445	2950	7000
23.15	25000	2445	3560	7600
24.15	30000	2550	3560	7900
24.18	35000	2550	4170	8500

* Dimensions vary depending on selected execution (indoor/outdoor, type of PHE,...)

		Unit type											
		09.06	10.07	12.09	14.09	15.10	18.10	21.10	21.12	23.12	23.15	24.15	24.18

Nominal air flow	m ³ /h	2800	3800	5500	8000	9500	11000	14000	18000	21000	25000	30000	35000
------------------	-------------------	------	------	------	------	------	-------	-------	-------	-------	-------	-------	-------

Filtration according to EN 779: 2012|ISO 16890

Fresh / Supply air M5 / F7 | ePM10 60% / ePM1 60%

Return air M5 | ePM10 60%

Double plate heat exchanger

Material Polypropylene

Energy efficiency according to DIN EN 13053 ¹	%	71	71	70	69	69	70	70	70	69	69	70	84/89
--	---	----	----	----	----	----	----	----	----	----	----	----	-------

Heat recovery rate winter/summer according to EN 308 ¹	%	78/85	78/85	79/85	78/85	78/85	76/85	82/88	80/86	79/85	81/86	82/87	84/89
---	---	-------	-------	-------	-------	-------	-------	-------	-------	-------	-------	-------	-------

Evaporative cooling

Cooling capacity	kW	10.6	14.3	20.7	30.1	35.8	41.4	54.6	69.0	79.1	95.8	116.0	138.8
------------------	----	------	------	------	------	------	------	------	------	------	------	-------	-------

Evaporated water	l/h	16	22	32	46	55	63	81	103	115	138	171	199
------------------	-----	----	----	----	----	----	----	----	-----	-----	-----	-----	-----

Integrated heat pump

Mechanical cooling capacity ^{2,57}	kW	9.67	12.05	17.40	23.30	25.20	29.30	34.70	50.50	58.50	69.90	77.00	101.50
---	----	------	-------	-------	-------	-------	-------	-------	-------	-------	-------	-------	--------

Heating capacity	COP	4.35	4.52	4.32	4.28	4.45	4.56	4.65	4.42	4.56	4.74	4.62	4.48
------------------	-----	------	------	------	------	------	------	------	------	------	------	------	------

Energy efficiency ratio ⁸	EER	7.32	8.21	8.02	8.67	9.56	9.55	10.54	9.60	9.50	10.09	10.53	9.86
--------------------------------------	-----	------	------	------	------	------	------	-------	------	------	-------	-------	------

Hot water coil^{3,5}

Heating capacity	kW	11.32	15.09	21.79	32.34	37.69	43.32	50.67	68.28	81.42	93.67	109.38	118.91
------------------	----	-------	-------	-------	-------	-------	-------	-------	-------	-------	-------	--------	--------

Water flow rate	m ³ /h	0.99	1.32	1.90	2.82	3.29	3.78	4.42	5.95	7.10	8.16	9.53	10.36
-----------------	-------------------	------	------	------	------	------	------	------	------	------	------	------	-------

Water pressure drop	kPa	1.94	2.51	2.52	3.84	3.88	4.87	4.20	5.05	6.08	5.82	6.22	5.94
---------------------	-----	------	------	------	------	------	------	------	------	------	------	------	------

Connections	DN	25	25	32	32	40	40	40	50	50	50	65	65
-------------	----	----	----	----	----	----	----	----	----	----	----	----	----

External pressure drop *

Fresh and supply air duct	Pa	750	650	750	900	550	850	750	650	500	800	650	650
---------------------------	----	-----	-----	-----	-----	-----	-----	-----	-----	-----	-----	-----	-----

Return and exhaust air duct	Pa	1200	900	800	750	1200	900	600	1150	400	650	650	650
-----------------------------	----	------	-----	-----	-----	------	-----	-----	------	-----	-----	-----	-----

Device data

Rated input - supply air fan ⁴	kW	1.92	2.50	3.38	5.70	5.70	11.00	11.00	12.00	11.40	22.00	22.00	24.00
---	----	------	------	------	------	------	-------	-------	-------	-------	-------	-------	-------

Rated input - return air fan ⁴	kW	1.80	1.92	2.50	3.45	5.70	5.00	5.00	12.00	6.90	10.00	13.50	15.40
---	----	------	------	------	------	------	------	------	-------	------	-------	-------	-------

Rated input - compressor ⁶	kW	2.22	2.66	4.03	5.44	5.66	6.41	7.47	11.45	12.80	14.75	16.65	22.70
---------------------------------------	----	------	------	------	------	------	------	------	-------	-------	-------	-------	-------

Rated input - pump for	kW	0.55	0.55	0.72	0.72	0.72	1.00	1.00	1.00	1.68	1.68	1.68	1.68
------------------------	----	------	------	------	------	------	------	------	------	------	------	------	------

Total electrical power rating	kW	6.49	7.63	10.63	15.31	17.78	23.41	24.47	36.45	32.78	48.43	53.83	63.78
-------------------------------	----	------	------	-------	-------	-------	-------	-------	-------	-------	-------	-------	-------

Total current consumption	A	13.8	15.7	22.3	32.3	35.7	47.5	48.5	73	73.5	96.3	107.5	131.7
---------------------------	---	------	------	------	------	------	------	------	----	------	------	-------	-------

Sound power level - supply ⁴	dB(A)	67.2	70.8	72.9	75.5	76.3	77.1	78.0	77.0	79.7	80.4	81.9	79.4
---	-------	------	------	------	------	------	------	------	------	------	------	------	------

Sound power level - return ⁴	dB(A)	62.5	63.1	64.4	67.9	73.0	68.9	74.5	73.4	79.6	74.5	75.6	77.6
---	-------	------	------	------	------	------	------	------	------	------	------	------	------

Acoustic pressure at a distance of 1 m from the device ⁴	dB(A)	53.0	56.0	57.8	59.9	60.7	62.3	63.1	62.7	64.2	66.2	67.5	65.7
---	-------	------	------	------	------	------	------	------	------	------	------	------	------

SFPint	W/m ³ /s	690	785	810	912	1161	1247	1369	1238	1210	1321	1534	1225
--------	---------------------	-----	-----	-----	-----	------	------	------	------	------	------	------	------

Operating voltage 3-380-480V 50/60 Hz

1. The data is valid for the following parameters:

Indoor conditions winter mode	20°C/40%
-------------------------------	----------

Indoor conditions summer mode	26°C/55%
-------------------------------	----------

Outdoor temperature and relative humidity winter mode	-12°C/90%
---	-----------

Outdoor temperature and relative humidity summer mode	33°C/33%
---	----------

- At supply temperature 16°C for nominal air flow
- At supply temperature 25°C for nominal air flow, FL = 55 °C, SA=45 °C
- For external pressure drop 200 Pa with average filter contamination
- Inlet conditions after double plate heat exchanger
- For mechanical cooling capacity
- Depends on operation mode
- Including evaporative cooling capacity taking into account power consumption for adiabatic pump

* Max allowed pressure drop in duct system at nominal air flow

Please seek approval of technical data and specifications prior to start of the planning process.

TERMOVENT AHU FAMILY

std | pro

hygiene | pro

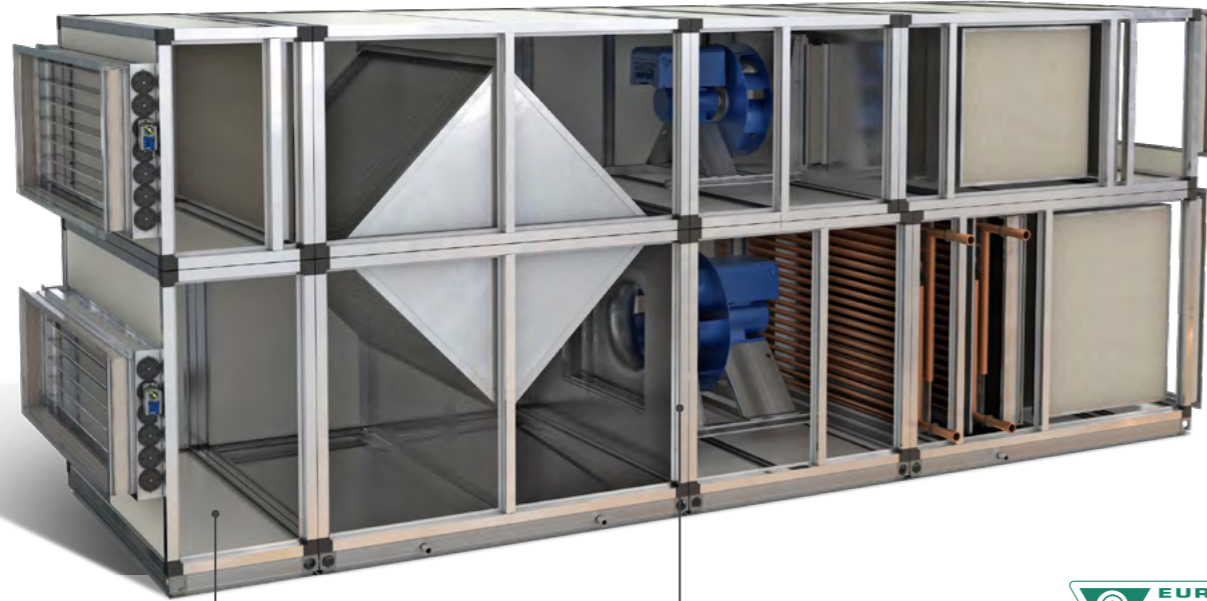

Panels with polyurethane or rockwool insulation

Aluminum frame profiles



The inner surface is smooth and without protuberances

Condensate drainage pipes, condensate tubes and all moving parts are made of stainless steel



30
sizes

Air flow

from **1.000** m³/h
to **100.000** m³/h

- Widespread use - catering facilities, cafes, restaurants, hotels, shopping malls, public facilities, industrial plants, warehouses...
- Modular design
- Thermally separated modular design
- Construction is a combination of aluminum profiles and pre-varnished panels, filled with polyurethane or rock wool
- Exterior or interior installation

30
sizes

Air flow

from **1.000** m³/h
to **100.000** m³/h

- Application – operating rooms, laboratories, pharmaceutical production facilities, food, military or electronics industries...
- In conformity with GMP, FDA and HACCAP
- Prevention of space contamination
- All elements are easily approachable for washing and disinfection
- Formation of undesirable microorganisms is prevented



Hotel Marriott | Skopje, North Macedonia



Coca-Cola HBC | Belgrade, Serbia



Pfizer Global Manufacturing | Puurs, Belgium



Zoetis | Louvain la Neuve, Belgium

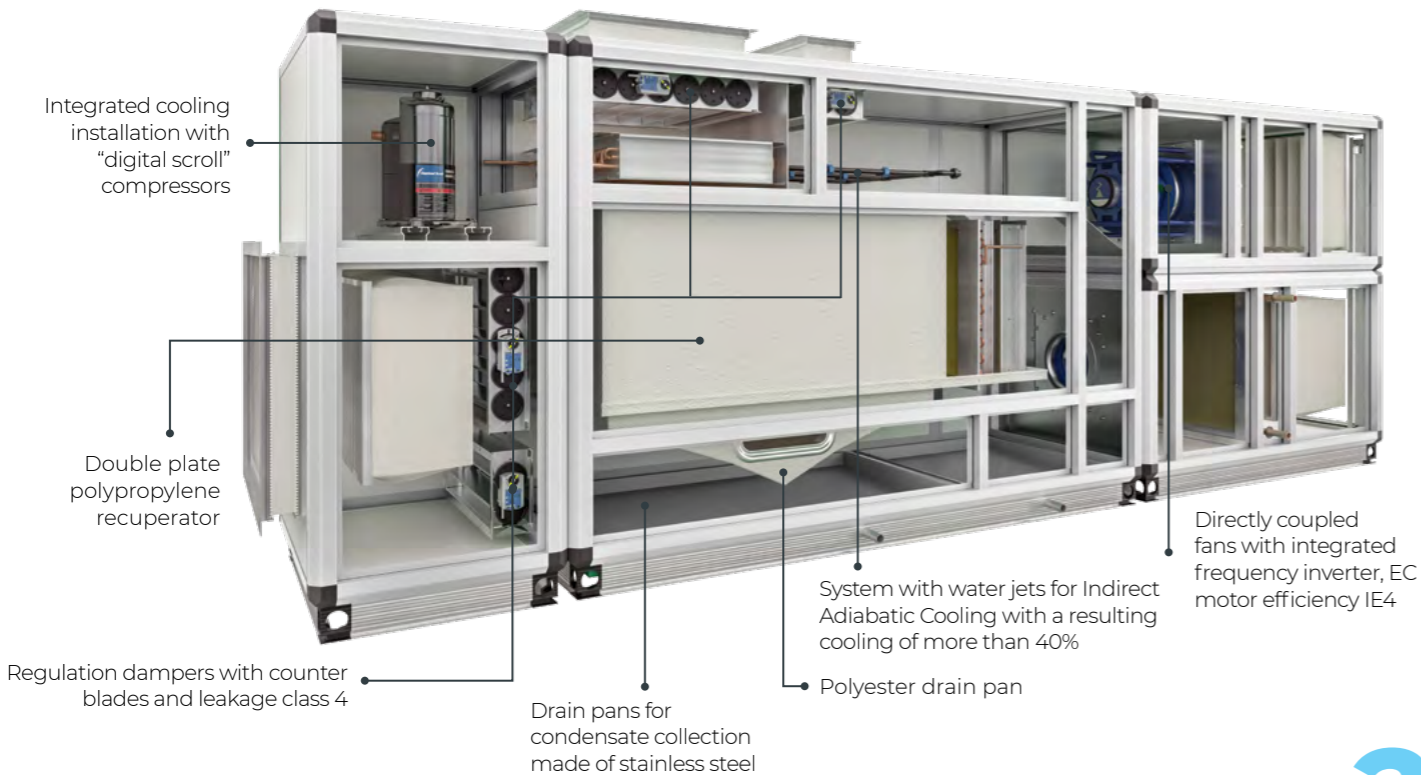

HEAT RECOVERY RATE
80%

Air flow
from **800** m³/h
to **40.000** m³/h

- Prevented the occurrence of condensate in a stream of supply air
- Prevented water leakage into the exchange section
- Ecological system with low power consumption and low CO₂ emissions
- The optional energy | pro design without integrated cooling installations with compressors



energy | pro
energy | pro Adiabatic
models 2

QUALITY MANAGEMENT SYSTEM

CERTIFICATES AS THE GUARANTEE OF QUALITY

Termovent is fully committed to meeting the customer's requirements in terms of quality, environmental protection and safety. The set high quality standards are the cornerstone of our operations.

In order to achieve the goals we set at all times, our employees are involved in the processes of continuous improvement and optimization of our products and services. The success of this approach is confirmed by numerous certificates held by Termovent, which guarantee the highest standards to our customers.



Eurovent Certita Certification

Eurovent Certita Certification Eurovent Certita Certification has certified that Termovent Air Handling Units, Range KK, and Software for calculation of performances SELECT:pro, Trade name TERMOVENT, have been assessed according to requirements. TERMOVENT participates in the ECP program for AHU. Check ongoing validity of certificate: www.eurovent-certification.com

CE marking for Termovent AHUs

CE marking for Termovent AHUs Termovent Air handling Units hold CE Marking of Conformity to Machinery Directive 2006/42/EC Annex II, Point A. In addition, Termovent AHUs are designed and produced according to set of harmonized standards: EN ISO 12100:2010, EN ISO 12100:2010, EN ISO 13850:2015, EN 1037:1995+A1:2008, EN ISO 14120:2015, EN 60204-1:2006/A1:2009 and EN 61000-6-2:2005/AC:2005



ISO 13485:2016

ISO 13485:2016 Certification body SIQ confirmed that Termovent introduced Quality Management System in accordance with ISO 13485:2016 in the field of manufacturing, design and installation of Termovent panels for the construction of clean rooms.

ISO 9001: 2015

ISO 9001: 2015 Certification body TUV SUD Management Service GmbH confirmed that Termovent introduced Quality Management System in accordance with ISO 9001:2015 standard in the field of manufacturing, installation and sales of equipment for air conditioning, heating and cooling.

ISO 14001:2015

ISO 9001: 2015 Certification body TUV SUD Management Service GmbH confirmed that Termovent introduced Quality Management System in accordance with ISO 9001:2015 standard in the field of manufacturing, installation and sales of equipment for air conditioning, heating and cooling.

ISO 45001:2018

OHSAS 18001:2007 Certification body TUV SUD Management Service GmbH confirmed that Termovent introduced Health and Safety Management System in accordance with OHSAS 18001:2007 in the field of manufacturing, installation and automation of air conditioning, heating and cooling equipment and systems.

AAA Creditworthiness Rating

AAA Creditworthiness Rating Bisnode Serbia awards Golden certificate of Creditworthiness Rating



TERMOVENT

A company of Arbonia Group
ARBONIA 

TERMOVENT Komerc d.o.o.
Kneza Miloša 88a
Skyline, object D, 1st floor
11070 Belgrade, Serbia
tel: +381 60 660 10 68
email: info@termovent.rs