

 Hydrothermal and gaseous fuels distribution systems

 *Système de distribution hydrothermiques et combustible gazeux*

 *Трубы и комплектующие для газо-, водо- и теплоснабжения*

 *Sistem de distributie hidrotermica si combustibili gazosi*

 *Sistema de distribución hidrotérmica y de combustibles gaseosos*

 *Heizungs-, Sanitär- und Gas Verteilungssystem*

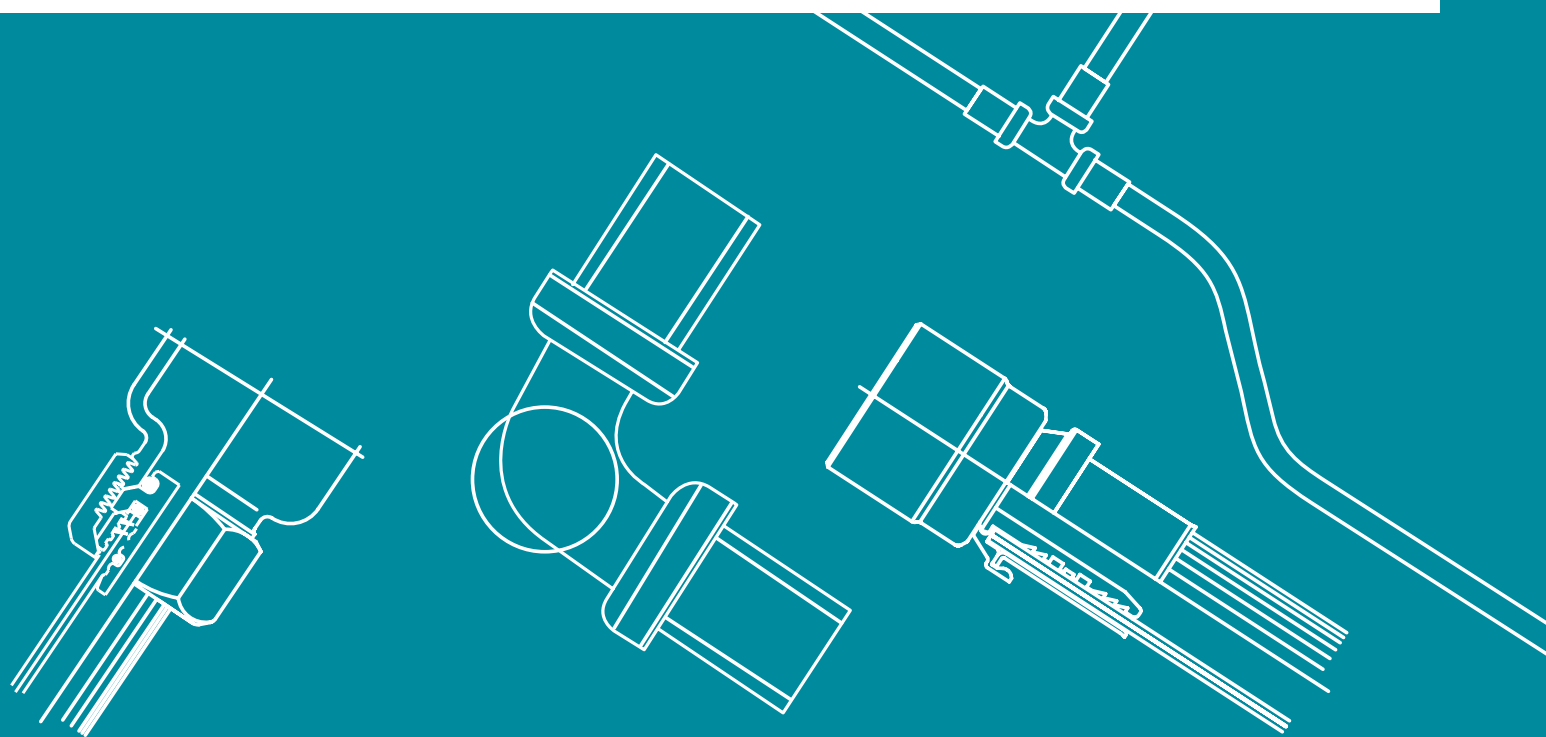

Tita-fix 

Code Code APT. Cod Código Kode	Page Page CTP. Pagina Página Seite
1165.00.02	3.01
1253.04.00	2.12
1253.04.10	2.12
1253.04.50	2.12
1338.00.02	3.02
1339.00.02	3.03
1340.14.02	3.03
1340.16.02	3.03
1340.18.02	3.03
1340.20.02	3.03
1340.26.02	3.03
1340.32.02	3.03
1496.00.02	3.02
1541.16.40	2.01
1541.16.50	2.01
1541.16.80	2.00
1541.16.90	2.00
1541.20.40	2.01
1541.20.50	2.01
1541.20.80	2.00
1541.20.90	2.00
1541.26.40	2.01
1541.26.50	2.01
1541.32.40	2.01
1541.32.50	2.01
1542.16.00	2.00
1542.20.00	2.00
1542.26.00	2.00
1542.32.00	2.00
1543.16.00	2.00
1543.20.00	2.00
1543.26.00	2.00
1543.32.00	2.00
1544.16.40	2.03
1544.16.50	2.03
1544.16.80	2.02
1544.16.90	2.02
1544.20.40	2.03
1544.20.50	2.03
1544.20.80	2.02
1544.20.90	2.02
1544.26.40	2.03
1544.26.50	2.03
1544.32.40	2.03
1544.32.50	2.03
1545.16.00	2.02
1545.20.00	2.02
1545.26.00	2.02
1545.32.00	2.02
1545.40.00	2.02
1546.16.00	2.02
1546.20.00	2.02
1546.26.00	2.02
1546.32.00	2.02
1546.40.00	2.02
1546.50.00	2.02
1546.63.00	2.02
1875.14.02	3.00
1875.16.02	3.00
1875.18.02	3.00
1875.20.02	3.00
1875.26.02	3.00
1927.16.00	2.03
1927.20.00	2.03
1953.16.00	1.08
1953.20.00	1.08
1954.16.00	1.08
1954.20.00	1.08
1955.16.30	1.01
1955.20.30	1.01
1955.26.30	1.01
1956.16.00	1.02
1956.20.00	1.02
1957.16.00	1.02
1957.20.00	1.02
1957.26.00	1.02
1957.32.00	1.02
1958.16.20	1.02
1958.20.20	1.02
1958.20.30	1.02
1958.26.30	1.02
1958.32.40	1.02
1959.16.20	1.03

Code Code APT. Cod Código Kode	Page Page CTP. Pagina Página Seite
1959.16.30	1.03
1959.20.20	1.03
1959.20.30	1.03
1959.26.30	1.03
1959.32.40	1.03
1960.16.00	1.03
1960.20.00	1.03
1960.26.00	1.03
1960.32.00	1.03
1961.16.20	1.03
1961.20.20	1.03
1961.26.30	1.03
1961.32.40	1.03
1962.16.20	1.04
1962.20.20	1.04
1962.26.30	1.04
1962.32.40	1.04
1963.16.00	1.04
1963.20.00	1.04
1963.26.00	1.04
1963.32.00	1.04
1964.16.20	1.04
1964.20.20	1.04
1964.26.30	1.04
1964.32.40	1.04
1965.16.10	1.06
1965.16.30	1.05
1965.16.60	1.05
1965.16.90	1.06
1965.20.00	1.06
1965.20.10	1.05
1965.20.20	1.05
1965.20.40	1.05
1965.20.70	1.06
1965.26.00	1.05
1966.20.00	1.06
1967.04.00	1.07
1967.04.10	1.07
1969.16.00	1.00
1969.16.10	1.00
1969.20.00	1.00
1969.20.10	1.00
1969.26.00	1.00
1969.32.00	1.00
1970.16.00	1.00
1970.20.00	1.00
1970.26.00	1.00
1970.32.00	1.00
20.04.10	2.12
20.05.10	2.12
20.05.20	2.12
2006.14.02	3.01
2006.16.02	3.01
2006.18.02	3.01
2006.20.02	3.01
2006.26.02	3.01
2006.32.02	3.01
2006.40.02	3.01
2006.50.02	3.01
2006.63.02	3.01
2007.00.02	3.01
2008.00.02	3.01
2010.16.00	1.00
2010.20.00	1.00
2021.16.02	1.00
2021.20.02	1.00
2021.26.02	1.00
2021.32.02	1.00
2025.16.02	1.01
2025.20.02	1.01
2025.26.02	1.01
2025.32.02	1.01
2064.20.10	1.05
2064.26.20	1.05
2064.32.20	1.05
2085.16.20	1.01
2085.16.30	1.01
2085.20.30	1.01
2085.26.40	1.01
2136.06.02	1.09
2137.06.02	1.09
2138.00.02	1.09
2139.00.02	1.09

Code Code APT. Cod Código Kode	Page Page CTP. Pagina Página Seite
2140.00.02	1.10
2141.00.02	1.09
2142.00.02	1.10
2143.00.02	1.10
2143.00.12	1.10
2179.00.02	3.00
246.00.00	3.03
553.00.02	3.02
553.00.12	3.02
553.00.32	3.00
553.00.42	3.00
553.00.52	3.00
553.00.62	3.00
553.00.72	3.00
671.14.00	2.05
671.16.00	2.05
671.18.00	2.05
671.20.00	2.05
671.26.00	2.05
671.32.00	2.05
671.40.00	2.05
671.50.00	2.05
671.63.00	2.05
672.14.20	2.05
672.16.20	2.05
672.18.20	2.05
672.18.30	2.05
672.20.20	2.05
672.20.30	2.05
672.26.30	2.05
672.26.40	2.05
672.32.40	2.05
672.40.40	2.05
672.40.50	2.05
672.50.60	2.05
672.63.70	2.05
673.14.10	2.06
673.14.20	2.06
673.16.10	2.06
673.16.20	2.06
673.18.20	2.06
673.18.30	2.06
673.20.20	2.06
673.20.30	2.06
673.26.30	2.06
673.26.40	2.06
673.32.40	2.06
673.40.50	2.06
673.50.60	2.06
673.63.70	2.06
674.14.00	2.06
674.16.00	2.06
674.18.00	2.06
674.20.00	2.06
674.26.00	2.06
674.32.00	2.06
674.40.00	2.06
674.50.00	2.06
674.63.00	2.06
675.14.20	2.06
675.16.20	2.06
675.18.20	2.06
675.18.30	2.06
675.20.20	2.06
675.20.30	2.06
675.26.30	2.06
675.32.40	2.06
675.40.50	2.06
675.50.60	2.06
676.14.20	2.07
676.16.20	2.07
676.18.20	2.07
676.18.30	2.07
676.20.20	2.07
676.20.30	2.07
676.26.30	2.07
676.32.40	2.07
676.40.50	2.07
677.14.00	2.07
677.16.00	2.07
677.18.00	2.07
677.20.00	2.07
677.26.00	2.07

Code Code APT. Cod Código Kode	Page Page CTP. Pagina Página Seite
677.32.00	2.07
677.40.00	2.07
677.50.00	2.07
677.63.00	2.07
678.14.20	2.07
678.16.20	2.07
678.18.20	2.07
678.18.30	2.07
678.20.20	2.07
678.20.30	2.07
678.26.30	2.07
678.32.30	2.07
678.32.40	2.07
678.40.40	2.07
678.40.50	2.07
678.50.40	2.07
679.14.20	2.08
679.16.20	2.08
679.18.20	2.08
679.18.30	2.08
679.20.20	2.08
679.20.30	2.08
679.26.30	2.08
679.32.40	2.08
680.14.20	2.08
680.16.20	2.08
680.18.20	2.08
680.18.30	2.08
680.20.20	2.08
680.20.30	2.08
680.26.30	2.08
680.26.40	2.08
680.32.30	2.08
680.32.40	2.08
680.40.40	2.08
680.40.50	2.08
681.14.02	3.02
681.16.02	3.02
681.18.02	3.02
681.20.02	3.02
681.26.02	3.02
681.32.02	3.02
681.40.02	3.02
681.50.02	3.02
681.63.02	3.02
69.00.00	3.03
812.14.10	2.04
812.14.20	2.04
812.16.10	2.04
812.16.20	2.04
812.16.30	2.04
812.18.30	2.04
812.20.30	2.04
812.26.40	2.04
812.32.50	2.04
826.14.00	2.04
826.16.00	2.04
826.18.00	2.04
826.20.00	2.04
851.14.00	2.09
851.14.10	2.09
851.14.20	2.09
851.14.50	2.09
851.16.00	2.09
851.16.10	2.09
851.16.20	2.09
851.16.30	2.09
851.16.40	2.09
851.16.60	2.09
851.16.90	2.09
851.18.00	2.09
851.18.10	2.09
851.18.20	2.09
851.18.30	2.09
851.18.40	2.10
851.20.00	2.10
851.20.10	2.09
851.20.20	2.09
851.20.40	2.09
851.20.70	2.09
851.20.90	2.09
851.26.00	2.09
851.26.10	2.09

Code Code APT. Cod Código Kode	Page Page CTP. Pagina Página Seite
851.26.20	2.09
851.26.40	2.09
851.26.50	2.10
851.32.00	2.09
851.32.10	2.09
851.32.20	2.09
851.32.30	2.10
851.40.00	2.09
851.40.10	2.09
851.50.00	2.09
851.50.20	2.09
851.63.20	2.09
851.63.40	2.09
852.04.00	2.11
852.04.30	2.11
853.04.00	2.10
853.04.10	2.10
853.04.90	2.11
890.16.00	2.08
890.18.00	2.08
890.18.10	2.08
890.20.10	2.08
890.20.20	2.08
890.26.00	2.08
890.26.10	2.08
890.26.20	2.08
890.32.00	2.08
890.32.10	2.08
890.32.20	2.08
890.40.10	2.08
890.50.00	2.08
890.50.10	2.08
890.63.00	2.08
890.63.10	2.08
933.16.00	2.09
934.00.00	1.07
934.00.00	2.11
934.00.50	1.07
934.00.50	2.11
962.14.00	2.05
962.16.00	2.05
962.20.00	2.05
962.26.00	2.05
963.16.30	2.04
963.18.30	2.04
963.20.30	2.04
963.26.30	2.04
999.20.00	2.10



Tita-gas 

 **GASEOUS FUELS
DISTRIBUTION SYSTEM
RBM TITA-GAS**

 *SYSTÈME DE DISTRIBUTION DE COMBUSTIBLES
GAZEUX RBM TITA-GAS*

 *ТРУБЫ И КОМПЛЕКТУЮЩИЕ ДЛЯ СИСТЕМ
ГАЗОСНАБЖЕНИЯ RBM TITA-GAS*

 *SISTEM DE DISTRIBUȚIE COMBUSTIBILI GAZOȘI RBM TITA-GAS*

 *SISTEMA DE DISTRIBUCIÓN DE COMBUSTIBLES
GASEOSOS RBM TITA-GAS*

 *SYSTEM ZUR VERTEILUNG VON GASFÖRMIGE BRENNSTOFFE
RBM TITA-GAS*

- A ■ PE-Xc Multilayer pipe for gas distribution
- B ■ Fittings for gas multilayer system
- C ■ Gaseous fuels distribution accessories

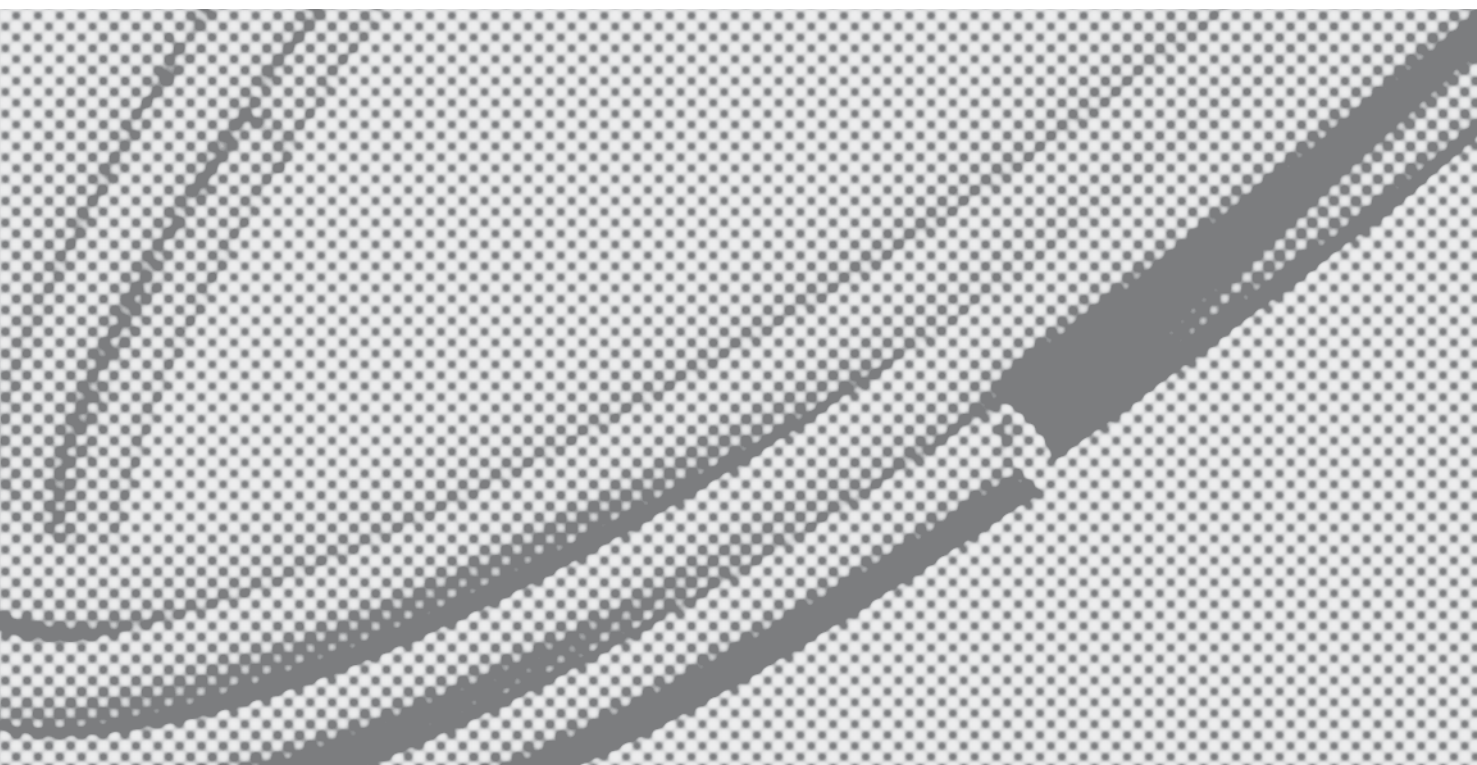

A

B

C

PE-Xc RBM Tita-gas multilayer pipe.

Suitable for the implementation of networks transporting gaseous fuels, according to UNI/TS 11343 and UNI/TS 11344
 "Metal-plastic multilayer pipe systems and fittings for transporting gaseous fuels for internal plants"

- Composition PE-Xc/Al/PE-RT
- Yellow
- Maximum operating pressure: 0.5 bar
- Operating temperature: -20 ÷ +70°C



- PE-Xc RBM Tita-gas multilayer pipe in roll
- Tube multicouche PE-Xc RBM Tita-gas en rouleau
- Металлопластиковая труба PE-Xc RBM Tita-gas в бухтах
- Conductă multistrat PE-Xc RBM Tita-gas în colac
- Tubo multicapa PE-Xc RBM Tita-gas, en rollos
- Mehrschichtverbundrohr PE-Xc RBM Tita-gas auf Rolle

Code Code Articol Cod Código Code	Size Pipe Dim. Tube Раз. Трубы Dimensiune Conductă Med. Tubo Abm. Rohr	Aluminium th. Ep. aluminium Толщ. алюминия Gros. Aluminii Espesor alum. St. Aluminium	Roll Rouleau Бухта Colac Rollo Rolle	EURO EURO EURO EURO EURO EURO	Pack Cond. Уп-ка Ambalaj Caja Verp.
1969.16.10	16x2	0,20 mm	50 m	1,77	1
1969.16.00	16x2	0,20 mm	100 m	1,77	1
1969.20.10	20x2	0,30 mm	50 m	2,32	1
1969.20.00	20x2	0,30 mm	100 m	2,32	1
1969.26.00	26x3	0,40 mm	50 m	4,71	1
1969.32.00	32x3	0,40 mm	50 m	7,71	1

Size: Outside Ø x pipe thickness.

- PE-Xc RBM Tita-gas multilayer pipe in bars
- Tube multicouche PE-Xc RBM Tita-gas en barres
- Металлопластиковая труба PE-Xc RBM Tita-gas в штангах
- Conductă multistrat PE-Xc RBM Tita-gas în bare
- Tubo multicapa PE-Xc RBM Tita-gas, en barras
- Mehrschichtverbundrohr PE-Xc RBM Tita-gas in Stangen

Code Code Articol Cod Código Code	Size Pipe Dim. Tube Раз. Трубы Dimensiune Conductă Med. Tubo Abm. Rohr	Aluminium th. Ep. aluminium Толщ. алюминия Gros. Aluminii Espesor alum. St. Aluminium	Bar Barre Штанга Bară Barra Stange	EURO EURO EURO EURO EURO EURO	Pack Cond. Уп-ка Ambalaj Caja Verp.
1970.16.00	16x2	0,20 mm	4 m	2,12	25
1970.20.00	20x2	0,30 mm	4 m	2,77	19
1970.26.00	26x3	0,40 mm	4 m	5,65	10
1970.32.00	32x3	0,40 mm	4 m	9,25	6

Size: Outside Ø x pipe thickness.

- Compliant with UNI/TS 11344



033MC



The entire package must be ordered.

PE-Xc RBM Tita-gas multilayer pipe, with protective HD polyethylene conduit.

Suitable for the implementation of networks transporting gaseous fuels, according to UNI/TS 11343 and UNI/TS 11344
 "Metal-plastic multilayer pipe systems and fittings for transporting gaseous fuels for internal plants"

- Composition: PE-Xc/Al/PE-RT
- Yellow
- Maximum operating pressure: 0.5 bar
- Operating temperature: -20 ÷ +70°C



- PE-Xc RBM Tita-gas multilayer pipe with protective conduit
- Tube multicouche PE-Xc RBM Tita-gas avec gaine de protection
- Металлопластиковая труба PE-Xc RBM Tita-gas
- Conductă multistrat PE-Xc RBM Tita-gas cu înveliș de protecție
- Tubo multicapa PE-Xc RBM Tita-gas con vaina de proteccción, en rollos
- Mehrschichtverbundrohr PE-Xc RBM Tita-gas mit Schutzmantel

Code Code Articol Cod Código Code	Size Pipe Dim. Tube Раз. Трубы Dimensiune Conductă Med. Tubo Abm. Rohr	Aluminium th. Ep. aluminium Толщ. алюминия Gros. Aluminii Espesor alum. St. Aluminium	Roll Rouleau Бухта Colac Rollo Rolle	EURO EURO EURO EURO EURO EURO	Pack Cond. Уп-ка Ambalaj Caja Verp.
2010.16.00	16x2	0,20 mm	50 m	2,83	1
2010.20.00	20x2	0,30 mm	50 m	3,53	1

Size: Outside Ø x pipe thickness.

- Compliant with UNI/TS 11344



033MC



Suitable for implementing buried distribution systems.

Protective flexible extensible conduit for RBM Tita-gas pipe.

The extendable, flexible corrugated conduit, made in PP, makes the pipe resistant to crushing and blows.



- Protective flexible extendable conduit for RBM Tita-gas pipe
- Gaine extensibilă flexibilă protectrice pentru conductă RBM Tita-gas
- Гибкая защитная и растяжимая гофра для трубы RBM Tita-gas
- Înveliș de protecție extensibil flexibil de protecție pentru conductă RBM Tita-gas
- Vaina extensibilă y flexible para protección de tubo RBM Tita-gas
- Ausziehbares biegsames Schutzummantelung für Rohr RBM Tita-gas

Code Code Articol Cod Código Code	Ø sheathed pipe Ø tube gainable Ø трубы Ø conductă care poate fi protejată cu înveliș Ø tubo amantelable Ø ummantelbares Rohr	Outside Ø conduit Ø externe gaine Внешний Ø гофры Ø exterior înveliș Ø exterior vaina Ø Mantelaussenseite	Roll Rouleau Бухта Colac Rollo Rolle	EURO EURO EURO EURO EURO EURO	Pack Cond. Уп-ка Ambalaj Caja Verp.
2021.16.02	16 mm	29 mm	50 m	0,70	1
2021.20.02	20 mm	34 mm	50 m	0,82	1
2021.26.02	26 mm	40 mm	50 m	1,01	1
2021.32.02	32 mm	53 mm	50 m	1,73	1



Resistant to crushing and blows.

Suitable for buried installations.

033MC

Protective flexible conduit for RBM Tita-gas pipe.

The flexible conduit, with reinforced spiral, and the smooth inside surface made of PVC makes the pipe resistant to crushing and blows as well as protecting it from stray currents.



033MC

- Protective flexible conduit for RBM Tita-gas pipe
- *Gaine flexible protectrice pour tube RBM Tita-gas*
- *Гибкая защитная и растяжимая гофра для трубы RBM Tita-gas*
- *Înveliș flexibil de protecție pentru conducta RBM Tita-gas*
- *Vaina flexible para protección de tubo RBM Tita-gas*
- *Biegsame Schutzummantelung für Rohr RBM Tita-gas*

Code Code Артикул Cod Código Code	Ø sheathed pipe Ø tube gainable Ø трубы Ø conductă care poate fi protejată cu înveliș Ø tubo envainable Ø ummantelbares Rohr	Outside Ø conduit Ø externe gaine Внешний Ø гофры Ø exterior înveliș Ø exterior vaina Ø Mantelausbenseite	Roll Rouleau Букта Colac Rollo Rolle	EURO EURO EURO EURO EURO EURO	Pack Cond. Уп-ка Ambalaj Caja Verp.
2025.16.02	16 mm	24,5 mm	25 m	0,76	1
2025.20.02	20 mm	30 mm	25 m	0,95	1
2025.26.02	26 mm	36,5 mm	25 m	1,31	1
2025.32.02	32 mm	46 mm	25 m	1,81	1



Resistant to crushing and blows.

Protects the pipe from possible stray currents.

Suitable for buried installations.

PE-XC MULTILAYER PIPE FOR GAS DISTRIBUTION

.01

Press fitting for Tita-gas multilayer pipe.

Fitting compatible with series TH clamps.

- Externally nickel-plated brass body
- HNBR seals (complying with UNI EN 682)
- Stainless steel pipe clamping bush
- Dielectric pipe clamp cover in PE
- Gas threaded connection, flat seat
- Maximum operating pressure: 0.5 bar



032

- Press fitting for gas for multilayer pipe - rotary nut - flat seat gas thread
- *Raccord à presser pour gaz pour tube multicouche - écrou tournant - filetage gaz garniture plate*
- *Пресс-фитинг для металлопластиковых труб для газоснабжения - с накидной гайкой - резьба плоское уплотнение*
- *Racord prin presare pentru gaz pentru conductă multistrat - piuliță rotantă - filet gaz garnitură plată*
- *Racor Press Fitting Gas recto con tuerca loca para junta plana para tubo multicapa gas*
- *Gassteckanschluss für Mehrschichtverbundrohr - Überwurfmutter - Gasgewinde flach dichtend*

Code Code Артикул Cod Código Code	Size A Dim. A Pas. A Dimens. A Med. A Abm. A	Size B Dim. B Pas. B Dimens. B Med. B Abm. B	EURO EURO EURO EURO EURO EURO	Pack Cond. Уп-ка Ambalaj Caja Verp.
2085.16.20	16x2	1/2" F	7,73	10
2085.16.30	16x2	3/4" F	8,80	10
2085.20.30	20x2	3/4" F	9,53	10
2085.26.40	26x3	1" F	12,18	10

Size A: Outside Ø x pipe thickness.

Suitable for the implementation of networks transporting gaseous fuels, according to UNI/TS 11343 and UNI/TS 11344
 "Metal-plastic multilayer pipe systems and fittings for transporting gaseous fuels for internal plants"

FITTINGS FOR GAS MULTILAYER SYSTEM

Press fitting for Tita-gas multilayer pipe.

Fitting compatible with series TH clamps.

- Externally nickel-plated brass body
- HNBR seals (complying with UNI EN 682)
- Stainless steel pipe clamping bush
- Dielectric pipe clamp cover in PE
- Euroconus threaded connection G3/4" UNI-EN-ISO 228
- Maximum operating pressure: 0.5 bar



032

- Press fitting for gas for multilayer pipe - rotary nut - Euroconus seal gas thread
- *Raccord à presser pour gaz pour tube multicouche - écrou tournant - filetage gaz garniture Euroconus*
- *Пресс-фитинг для металлопластиковых труб для газоснабжения - с накидной гайкой - резьба газ Euroconus*
- *Racord cu presare pentru gaz pentru conductă multistrat - piuliță fluture - filet gaz garnitură Euroconus*
- *Racor Press Fitting Gas recto con tuerca loca para conexión Euroconus, para tubo multicapa gas*
- *Gasdruckanschluss für Mehrschichtverbundrohr - Überwurfmutter - Gasgewinde Euroconus dichtend*

Code Code Артикул Cod Código Code	Size A Dim. A Pas. A Dimens. A Med. A Abm. A	Size B Dim. B Pas. B Dimens. B Med. B Abm. B	EURO EURO EURO EURO EURO EURO	Pack Cond. Уп-ка Ambalaj Caja Verp.
1955.16.30	16x2	Euroconus	10,26	10
1955.20.30	20x2	Euroconus	10,91	10
1955.26.30	26x3	Euroconus	12,62	10

Size A: Outside Ø x pipe thickness.

Suitable for the implementation of networks transporting gaseous fuels, according to UNI/TS 11343 and UNI/TS 11344
 "Metal-plastic multilayer pipe systems and fittings for transporting gaseous fuels for internal plants"



Press fitting for Tita-gas multilayer pipe.

Fitting compatible with series TH clamps.

- Externally nickel-plated brass body
- HNBR seals (complying with UNI EN 682)
- Stainless steel pipe clamping bush
- Dielectric pipe clamp cover in PE
- Standard RBM threaded connection W 24.5x19F
- Maximum operating pressure: 0.5 bar

- Press fitting for gas for multilayer pipe - rotary nut - standard RBM thread
- Raccord à presser pour gaz pour tube multicouche - écrou tournant - filetage Standard RBM
- Пресс-фитинг для металлопластиковых труб для газоснабжения- с накидной гайкой - резьба стандартная RBM
- Racord cu presare pentru gaz pentru conductă multistrat - piuliță fluture - filet Standard RBM
- Racor Press Fitting Gas recto con tuerca loca para conexión Standard RBM, para tubo multicapa gas
- Gasdruckanschluss für Mehrschichtverbudrohr - Überwurfmutter - Standardgewinde RBM

Code Code Артикул Cod Codigo Code	Size A Dim. A Pas. A Dimens. A Med. A Abm. A	Size B Dim. B Pas. B Dimens. B Med. B Abm. B	EURO EURO EURO EURO EURO	Pack Cond. Уп-ка Ambalaj Caja Verp.
1956.16.00	16x2	RBM	9,47	10
1956.20.00	20x2	RBM	10,74	10

Size A: Outside Ø x pipe thickness.

Suitable for the implementation of networks transporting gaseous fuels, according to UNI/TS 11343 and UNI/TS 11344

"Metal-plastic multilayer pipe systems and fittings for transporting gaseous fuels for internal plants"

032

Press fitting for Tita-gas multilayer pipe.

Fitting compatible with series TH clamps.

- Externally nickel-plated brass body
- HNBR seals (complying with UNI EN 682)
- Stainless steel pipe clamping bush
- Dielectric pipe clamp cover in PE
- Maximum operating pressure: 0.5 bar

- Press fitting for gas for multilayer pipe - straight - intermediate
- Raccord à presser pour gaz pour tube multicouche - droit - intermédiaire
- Пресс-фитинг для металлопластиковых труб для газоснабжения- прямой- промежуточный
- Racord cu strângere pentru gaz pentru conductă multistrat - drept - intermediar
- Manguito Press Fitting Gas recto, para tubo multicapa gas
- Druckanschluss für Mehrschichtverbudrohr - gerade - Zwischenstück

Code Code Артикул Cod Codigo Code	Size A Dim. A Pas. A Dimens. A Med. A Abm. A	EURO EURO EURO EURO EURO	Pack Cond. Уп-ка Ambalaj Caja Verp.
1957.16.00	16x2	5,91	10
1957.20.00	20x2	7,64	10
1957.26.00	26x3	9,10	10
1957.32.00	32x3	11,08	5

Size A: Outside Ø x pipe thickness.

Suitable for the implementation of networks transporting gaseous fuels, according to UNI/TS 11343 and UNI/TS 11344

"Metal-plastic multilayer pipe systems and fittings for transporting gaseous fuels for internal plants"

032

Press fitting for Tita-gas multilayer pipe.

Fitting compatible with series TH clamps.

- Externally nickel-plated brass body
- HNBR seals (complying with UNI EN 682)
- Stainless steel pipe clamping bush
- Dielectric pipe clamp cover in PE
- Straight threaded connection F UNI-EN-ISO 228
- Maximum operating pressure: 0.5 bar

- Press fitting for gas for multilayer pipe - straight - female connection
- Raccord à presser pour gaz pour tube multicouche - droit - branchement femelle
- Пресс-фитинг для металлопластиковых труб для газоснабжения- прямой- вн. резьба
- Racord cu presare pentru gaz pentru conductă multistrat - drept - prindere tip mamă
- Racor Press Fitting Gas recto hembra, para tubo multicapa gas
- Druckanschluss für Mehrschichtverbudrohr - gerade - Aufsteckanschluss

Code Code Артикул Cod Codigo Code	Size A Dim. A Pas. A Dimens. A Med. A Abm. A	Size B Dim. B Pas. B Dimens. B Med. B Abm. B	EURO EURO EURO EURO EURO	Pack Cond. Уп-ка Ambalaj Caja Verp.
1958.16.20	16x2	1/2"F	5,06	10
1958.20.20	20x2	1/2"F	5,64	10
1958.20.30	20x2	3/4"F	6,74	10
1958.26.30	26x3	3/4"F	8,61	10
1958.32.40	32x3	1"F	12,21	5

Size A: Outside Ø x pipe thickness.

Suitable for the implementation of networks transporting gaseous fuels, according to UNI/TS 11343 and UNI/TS 11344

"Metal-plastic multilayer pipe systems and fittings for transporting gaseous fuels for internal plants"

032

Press fitting for Tita-gas multilayer pipe.

Fitting compatible with series TH clamps.

- Externally nickel-plated brass body
- HNBR seals (complying with UNI EN 682)
- Stainless steel pipe clamping bush
- Dielectric pipe clamp cover in PE
- Straight threaded connection M UNI-EN-ISO 228
- Maximum operating pressure: 0.5 bar



- Press fitting for gas for multilayer pipe - straight - male connection
- *Raccord à presser pour gaz pour tube multicouche - droit - branchement mâle*
- *Пресс-фитинг для металлопластиковых труб для газоснабжения - прямой - нар. резьба*
- *Racord cu presare pentru gaz pentru conductă multistrat - drept - prindere tip tată*
- *Racor Press Fitting Gas recto macho, para tubo multicapa gas*
- *Druckanschluss für Mehrschichtverbundrohr - gerade - Steckanschluss*

Code Code Артикул Cod Código Code	Size A Dim. A Paz. A Dimens. A Med.A Abm. A	Size B Dim. B Paz. B Dimens. B Med.B Abm. B	EURO EURO EURO EURO EURO EURO	Pack Cond. Уп-ка Ambalaj Caja Verp.
1959.16.20	16x2	1/2"М	3,96	10
1959.16.30	16x2	3/4"М	6,53	10
1959.20.20	20x2	1/2"М	5,06	10
1959.20.30	20x2	3/4"М	7,36	10
1959.26.30	26x3	3/4"М	7,71	10
1959.32.40	32x3	1"М	9,62	10

Size A: Outside \varnothing x pipe thickness.

Suitable for the implementation of networks transporting gaseous fuels, according to UNI/TS 11343 and UNI/TS 11344
 "Metal-plastic multilayer pipe systems and fittings for transporting gaseous fuels for internal plants"

032

Press fitting for Tita-gas multilayer pipe.

Fitting compatible with series TH clamps.

- Externally nickel-plated brass body
- HNBR seals (complying with UNI EN 682)
- Stainless steel pipe clamping bush
- Dielectric pipe clamp cover in PE
- Maximum operating pressure: 0.5 bar



- Press fitting for gas for multilayer pipe - angle - intermediate
- *Raccord à presser pour gaz pour tube multicouche - angle - intermédiaire*
- *Пресс-фитинг для металлопластиковых труб для газоснабжения - угловой - промежуточный*
- *Racord cu presare pentru gaz pentru conductă multistrat - cu cot - intermediar*
- *Codo Press Fitting Gas 90°, para tubo multicapa gas*
- *Steckanschluss für Gas für Mehrschichtverbundrohr - Winkel - Zwischenstück*

Code Code Артикул Cod Código Code	Size A Dim. A Paz. A Dimens. A Med.A Abm. A	EURO EURO EURO EURO EURO EURO	Pack Cond. Уп-ка Ambalaj Caja Verp.
1960.16.00	16x2	7,75	10
1960.20.00	20x2	8,83	10
1960.26.00	26x3	9,99	5
1960.32.00	32x3	14,27	5

Size A: Outside \varnothing x pipe thickness.

Suitable for the implementation of networks transporting gaseous fuels, according to UNI/TS 11343 and UNI/TS 11344
 "Metal-plastic multilayer pipe systems and fittings for transporting gaseous fuels for internal plants"

032

Press fitting for Tita-gas multilayer pipe.

Fitting compatible with series TH clamps

- Externally nickel-plated brass body
- HNBR seals (complying with UNI EN 682)
- Stainless steel pipe clamping bush
- Dielectric pipe clamp cover in PE
- Angle threaded connection F UNI-EN-ISO 228
- Maximum operating pressure: 0.5 bar



- Press fitting for gas for multilayer pipe - angle - female connection
- *Raccord à presser pour gaz pour tube multicouche - angle - branchement femelle*
- *Пресс-фитинг для металлопластиковых труб для газоснабжения - угловой - вн. резьба*
- *Racord cu presare pentru gaz pentru conductă multistrat - cu cot - prindere tip mamă*
- *Racor Press Fitting Gas curvo hembra, para tubo multicapa gas*
- *Steckanschluss für Gas für Mehrschichtverbundrohr - Winkel - Aufsteckanschluss*

Code Code Артикул Cod Código Code	Size A Dim. A Paz. A Dimens. A Med.A Abm. A	Size B Dim. B Paz. B Dimens. B Med.B Abm. B	EURO EURO EURO EURO EURO EURO	Pack Cond. Уп-ка Ambalaj Caja Verp.
1961.16.20	16x2	1/2"F	5,96	10
1961.20.20	20x2	1/2"F	7,16	10
1961.26.30	26x3	3/4"F	10,50	10
1961.32.40	32x3	1"F	15,10	5

Size A: Outside \varnothing x pipe thickness.

Suitable for the implementation of networks transporting gaseous fuels, according to UNI/TS 11343 and UNI/TS 11344
 "Metal-plastic multilayer pipe systems and fittings for transporting gaseous fuels for internal plants"

032



Press fitting for Tita-gas multilayer pipe.

Fitting compatible with series TH clamps.

- Externally nickel-plated brass body
- HNBR seals (complying with UNI EN 682)
- Stainless steel pipe clamping bush
- Dielectric pipe clamp cover in PE
- Angle threaded connection M UNI-EN-ISO 228
- Maximum operating pressure: 0.5 bar

- Press fitting for gas for multilayer pipe - angle - male connection
- Raccord à presser pour gaz pour tube multicouche - angle - branchement mâle
- Пресс-фитинг для металлопластиковых труб для газоснабжения - угловой - нар. резьба
- Racord cu presare pentru gaz pentru conductă multistrat - cu cot - prindere tip tată
- Racor Press Fitting Gas curvo macho, para tubo multicapa gas
- Steckanschluss für Gas für Mehrschichtverbudrohr - Winkel - Steckanschluss

Code Code Артикул Cod Código Code	Size A Dim. A Paz. A Dimens. A Med. A Abm. A	Size B Dim. B Paz. B Dimens. B Med. B Abm. B	EURO EURO EURO EURO EURO EURO	Pack Cond. Уп-ка Ambalaj Caja Verp.
1962.16.20	16x2	1/2" M	5,48	10
1962.20.20	20x2	1/2" M	6,79	10
1962.26.30	26x3	3/4" M	9,73	10
1962.32.40	32x3	1" M	14,85	5

Size A: Outside Ø x pipe thickness.

Suitable for the implementation of networks transporting gaseous fuels, according to UNI/TS 11343 and UNI/TS 11344

"Metal-plastic multilayer pipe systems and fittings for transporting gaseous fuels for internal plants"

032



Press fitting for Tita-gas multilayer pipe.

Fitting compatible with series TH clamps.

- Externally nickel-plated brass body
- HNBR seals (complying with UNI EN 682)
- Stainless steel pipe clamping bush
- Dielectric pipe clamp cover in PE
- Maximum operating pressure: 0.5 bar

- Press fitting for gas for multilayer pipe - T-shaped - intermediate
- Raccord à presser pour gaz pour tube multicouche - en T - intermédiaire
- Пресс-фитинг для металлопластиковых труб для газоснабжения - T-образный - промежуточный
- Racord cu strângere pentru gaz pentru conductă multistrat - în formă de "T" - intermediar
- Te Press Fitting Gas, para tubo multicapa gas
- Steckanschluss für Gas für Mehrschichtverbudrohr - "T"-Verbindung - Zwischenstück

Code Code Артикул Cod Código Code	Size A Dim. A Paz. A Dimens. A Med. A Abm. A	EURO EURO EURO EURO EURO EURO	Pack Cond. Уп-ка Ambalaj Caja Verp.
1963.16.00	16x2	8,83	10
1963.20.00	20x2	10,06	10
1963.26.00	26x3	14,41	5
1963.32.00	32x3	19,48	5

Size A: Outside Ø x pipe thickness.

Suitable for the implementation of networks transporting gaseous fuels, according to UNI/TS 11343 and UNI/TS 11344

"Metal-plastic multilayer pipe systems and fittings for transporting gaseous fuels for internal plants"

032



Press fitting for Tita-gas multilayer pipe.

Fitting compatible with series TH clamps.

- Externally nickel-plated brass body
- HNBR seals (complying with UNI EN 682)
- Stainless steel pipe clamping bush
- Dielectric pipe clamp cover in PE
- Threaded connection F UNI-EN-ISO 228
- Maximum operating pressure: 0.5 bar

- Press fitting for gas for multilayer pipe - T-shaped - central female connection
- Raccord à presser pour gaz pour tube multicouche - en T - branchement femelle central
- Пресс-фитинг для металлопластиковых труб для газоснабжения - T-образный - вн. центральная резьба
- Racord cu strângere pentru gaz pentru conductă multistrat - în formă de "T" - prindere tip mamă centrală
- Racor Te Press Fitting Gas - Hembra - Press Fitting Gas, para tubo multicapa gas
- Steckanschluss für Mehrschichtverbudrohr Gas - "T"-Verbindung - zentraler Aufsteckanschluss

Code Code Артикул Cod Código Code	Size A Dim. A Paz. A Dimens. A Med. A Abm. A	Size B Dim. B Paz. B Dimens. B Med. B Abm. B	EURO EURO EURO EURO EURO EURO	Pack Cond. Уп-ка Ambalaj Caja Verp.
1964.16.20	16x2	1/2" F	8,69	10
1964.20.20	20x2	1/2" F	10,50	10
1964.26.30	26x3	3/4" F	15,40	5
1964.32.40	32x3	1" F	19,75	5

Size A: Outside Ø x pipe thickness.

Suitable for the implementation of networks transporting gaseous fuels, according to UNI/TS 11343 and UNI/TS 11344

"Metal-plastic multilayer pipe systems and fittings for transporting gaseous fuels for internal plants"

032

Press fitting for Tita-gas multilayer pipe.

Fitting compatible with series TH clamps.

- Externally nickel-plated brass body
- HNBR seals (complying with UNI EN 682)
- Stainless steel pipe clamping bush
- Dielectric pipe clamp cover in PE
- Maximum operating pressure: 0.5 bar



- Press fitting for gas for multilayer pipe - straight with reduced route
- *Raccord à presser pour gaz pour tube multicouche - droit à voie réduite*
- *Пресс-фитинг для металлопластиковых труб - прямой - редуционный*
- *Racord prin presare pentru gaz pentru conductă multistrat – drept cu canal redus*
- *Manguito Press Fitting Gas recto reducido, para tubo multicapa gas*
- *Steckanschluss für Mehrschichtverbundrohr - gerade und reduziert*

Code Code Артикул Cod Código Code	Size A Dim. A Paz. A Dimens. A Med. A Abm. A	Size B Dim. B Paz. B Dimens. B Med. B Abm. B	EURO EURO EURO EURO EURO EURO	Pack Cond. Уп-ка Ambalaj Caja Verp.
2064.20.10	20x2	16x2	6,54	10
2064.26.20	26x3	20x2	8,21	10
2064.32.20	32x3	26x3	11,02	5

Size A-B: Outside Ø x pipe thickness.

Suitable for the implementation of networks transporting gaseous fuels, according to UNI/TS 11343 and UNI/TS 11344
 "Metal-plastic multilayer pipe systems and fittings for transporting gaseous fuels for internal plants"

032

Press fitting for Tita-gas multilayer pipe.

Fitting compatible with series TH clamps.

- Externally nickel-plated brass body
- HNBR seals (complying with UNI EN 682)
- Stainless steel pipe clamping bush
- Dielectric pipe clamp cover in PE
- Maximum operating pressure: 0.5 bar



- Press fitting for gas for multilayer pipe - T-shaped - reduced lateral route
- *Raccord à presser pour gaz pour tube multicouche - en T - voie réduite latérale*
- *Пресс-фитинг для металлопластиковых труб для газоснабжения - Т-образный - редуционный*
- *Racord cu presare pentru gaz pentru conductă multistrat – în formă de "T" – canal redus lateral*
- *Te Press Fitting Gas reducida lateral, para tubo multicapa gas*
- *Steckanschluss für Mehrschichtverbundrohr Gas - "T"-Verbindung - seitliches Reduzierstück*

Code Code Артикул Cod Código Code	Size A Dim. A Paz. A Dimens. A Med. A Abm. A	Size B Dim. B Paz. B Dimens. B Med. B Abm. B	EURO EURO EURO EURO EURO EURO	Pack Cond. Уп-ка Ambalaj Caja Verp.
1965.20.10	20x2	16x2	11,39	10

Size A-B: Outside Ø x pipe thickness.

Suitable for the implementation of networks transporting gaseous fuels, according to UNI/TS 11343 and UNI/TS 11344
 "Metal-plastic multilayer pipe systems and fittings for transporting gaseous fuels for internal plants"

032

Press fitting for Tita-gas multilayer pipe.

Fitting compatible with series TH clamps.

- Externally nickel-plated brass body
- HNBR seals (complying with UNI EN 682)
- Stainless steel pipe clamping bush
- Dielectric pipe clamp cover in PE
- Maximum operating pressure: 0.5 bar



- Press fitting for gas for multilayer pipe - T-shaped - reduced central route
- *Raccord à presser pour gaz pour tube multicouche - en T - voie réduite centrale*
- *Пресс-фитинг для металлопластиковых труб для газоснабжения - Т-образный - редуционный*
- *Racord cu presare pentru gaz pentru conductă multistrat – în formă de "T" – canal redus central*
- *Te Press Fitting Gas reducida central, para tubo multicapa gas*
- *Steckanschluss für Mehrschichtverbundrohr Gas - "T"-Verbindung - zentrales Reduzierstück*

Code Code Артикул Cod Código Code	Size A Dim. A Paz. A Dimens. A Med. A Abm. A	Size B Dim. B Paz. B Dimens. B Med. B Abm. B	EURO EURO EURO EURO EURO EURO	Pack Cond. Уп-ка Ambalaj Caja Verp.
1965.16.30	20x2	16x2	11,56	10
1965.16.60	26x3	16x2	15,07	5
1965.20.20	26x3	20x2	15,24	5
1965.20.40	32x3	20x2	21,52	5
1965.26.00	32x3	26x3	21,67	5

Size A-B: Outside Ø x pipe thickness.

Suitable for the implementation of networks transporting gaseous fuels, according to UNI/TS 11343 and UNI/TS 11344
 "Metal-plastic multilayer pipe systems and fittings for transporting gaseous fuels for internal plants"

032

Press fitting for Tita-gas multilayer pipe.

Fitting compatible with series TH clamps.

- Externally nickel-plated brass body
- HNBR seals (complying with UNI EN 682)
- Stainless steel pipe clamping bush
- Dielectric pipe clamp cover in PE
- Maximum operating pressure: 0.5 bar



- Press fitting for gas for multilayer pipe - T-shaped - reduced central and lateral route
- Raccord à presser pour gaz pour tube multicouche - en T - voie réduite centrale et latérale
- Пресс-фитинг для металлопластиковых труб для газоснабжения - T-образный - редуцирующий
- Racord cu presare pentru gaz pentru conductă multistrat - în formă de "T" - canal redus central și lateral
- Te Press Fitting Gas reducida central y lateral, para tubo multicapa gas
- Steckanschluss für Mehrschichtverbundrohr Gas - "T"-Verbindung - seitliches und zentrales Reduzierstück

Code Code Артикул Cod Codigo Code	Size A Dim. A Pas. A Dimens. A Med. A Abm. A	Size B Dim. B Pas. B Dimens. B Med. B Abm. B	EURO EURO EURO EURO EURO	Pack Cond. Уп-ка Ambalaj Caja Verp.
1965.16.10	20x2	16x2	11,23	10
1965.16.90	26x3	16x2	14,24	5
1965.20.70	26x3	20x2	14,91	5

Size A-B: Outside Ø x pipe thickness.

Suitable for the implementation of networks transporting gaseous fuels, according to UNI/TS 11343 and UNI/TS 11344
 "Metal-plastic multilayer pipe systems and fittings for transporting gaseous fuels for internal plants"

032

Press fitting for Tita-gas multilayer pipe.

Fitting compatible with series TH clamps.

- Externally nickel-plated brass body
- HNBR seals (complying with UNI EN 682)
- Stainless steel pipe clamping bush
- Dielectric pipe clamp cover in PE
- Maximum operating pressure: 0.5 bar



- Press fitting for gas for multilayer pipe - T-shaped - reduced lateral double route
- Raccord à presser pour gaz pour tube multicouche - en T - double voie réduite latérale
- Пресс-фитинг для металлопластиковых труб для газоснабжения - T-образный - редуцирующий
- Racord cu presare pentru gaz pentru conductă multistrat - în formă de "T" - dublu canal redus lateral
- Te Press Fitting Gas reducida doble lateral, para tubo multicapa gas
- Steckanschluss für Mehrschichtverbundrohr Gas - "T"-Verbindung - doppeltes seitliches Reduzierstück

Code Code Артикул Cod Codigo Code	Size A Dim. A Pas. A Dimens. A Med. A Abm. A	Size B Dim. B Pas. B Dimens. B Med. B Abm. B	EURO EURO EURO EURO EURO	Pack Cond. Уп-ка Ambalaj Caja Verp.
1965.20.00	20x2	16x2	10,62	10

Size A-B: Outside Ø x pipe thickness.

Suitable for the implementation of networks transporting gaseous fuels, according to UNI/TS 11343 and UNI/TS 11344
 "Metal-plastic multilayer pipe systems and fittings for transporting gaseous fuels for internal plants"

032

Press fitting for Tita-gas multilayer pipe.

Fitting compatible with series TH clamps.

- Externally nickel-plated brass body
- HNBR seals (complying with UNI EN 682)
- Stainless steel pipe clamping bush
- Dielectric pipe clamp cover in PE
- Maximum operating pressure: 0.5 bar



- Press fitting for gas for multilayer pipe - T-shaped - triple reduction
- Raccord à presser pour gaz pour tube multicouche - en T - triple réduction
- Пресс-фитинг для металлопластиковых труб для газоснабжения - T-образный - редуцирующий
- Racord cu presare pentru gaz pentru conductă multistrat - în formă de "T" - reducție triplă
- Te Press Fitting Gas reducida triple, para tubo multicapa gas
- Steckanschluss für Mehrschichtverbundrohr Gas - "T"-Verbindung - dreifaches Reduzierstück

Code Code Артикул Cod Codigo Code	Size A Dim. A Pas. A Dimens. A Med. A Abm. A	Size B Dim. B Pas. B Dimens. B Med. B Abm. B	Size C Dim. C Pas. C Dimens. C Med. C Abm. C	EURO EURO EURO EURO EURO	Pack Cond. Уп-ка Ambalaj Caja Verp.
1966.20.00	26x3	20x2	16x2	15,63	10

Size A-B-C: Outside Ø x pipe thickness.

Suitable for the implementation of networks transporting gaseous fuels, according to UNI/TS 11343 and UNI/TS 11344
 "Metal-plastic multilayer pipe systems and fittings for transporting gaseous fuels for internal plants"

032

Press fitting for Tita-gas multilayer pipe.

Fitting compatible with series TH clamps.

- Externally nickel-plated brass body
- HNBR seals (complying with UNI EN 682)
- Stainless steel pipe clamping bush
- Dielectric pipe clamp cover in PE
- Threaded connection F UNI-EN-ISO 228
- Maximum operating pressure: 0.5 bar



- Press fitting for gas for multilayer pipe - flanged elbow - standard length F gas connection
- *Raccord à presser pour gaz pour tube multicouche - coudé à bride - longueur standard branchement F gaz*
- *Пресс-фитинг для металлопластиковых труб - с фланцевым коленом - длина стандартная резьба вн.*
- *Racord cu presare pentru gaz pentru conductă multistrat - cu Cot cu Flanșă - lungimea standard prindere tip Mamă gaz*
- *Racor Press Fitting Gas curvo hembra con base de soporte, para tubo multicapa gas*
- *Steckanschluss für Mehrschichtverbundrohr Gas - "T"-Verbindung - seitlicher Bogen Standardlänge Anschluss F Gas*

Code Code Артикул Cod Código Code	Size A Dim. A Paz. A Dimens. A Med.A Abm. A	Size B Dim. B Paz. B Dimens. B Med.B Abm. B	EURO EURO EURO EURO EURO EURO	Pack Cond. Уп-ка Ambalaj Caja Verp.
1967.04.00	16x2	1/2"F	9,95	10
1967.04.10	20x2	1/2"F	10,14	10

Size A: Outside Ø x pipe thickness.

Suitable for the implementation of networks transporting gaseous fuels, according to UNI/TS 11343 and UNI/TS 11344
 "Metal-plastic multilayer pipe systems and fittings for transporting gaseous fuels for internal plants"

032



Fixing on specific Fixing Plate code 934.00.00

Flanged fittings fixing plate.

- Galvanised steel material
- Flanged fitting application with prefixed centre distance of 80-100-120-160 mm
- Possibility of choosing bracket attachments at only centre distance 80 mm



- Fixing plate
- *Plaque de fixation*
- *Крепежная пластина*
- *Placă de fixare*
- *Placa de montaje para racor con base de soporte*
- *Befestigungsplatte*

Code Code Артикул Cod Código Code	EURO EURO EURO EURO EURO EURO	Pack Cond. Уп-ка Ambalaj Caja Verp.
934.00.00	2,96	1

032

Fixing and positioning bracket.

- Galvanised steel material
- Complete with fixing nut



- Fixing bracket
- *Étrier de fixation*
- *Монтажная планка*
- *Bridă de fixare*
- *Soporte de fijación y posicionamiento*
- *Befestigungsbügel*

Code Code Артикул Cod Código Code	EURO EURO EURO EURO EURO EURO	Pack Cond. Уп-ка Ambalaj Caja Verp.
934.00.50	7,88	1



Plate bracket code 934.00.00

032

Compression fitting for Tita-gas multilayer pipe.

- Brass nut, core and pipe clamping ogive
- Nickel plated nut
- HNBR seals (complying with UNI EN 682)
- Standard RBM threaded connection W 24.5x19F
- Maximum operating pressure: 0.5 bar



RBM

- Compression fitting for gas for multilayer pipe - Standard RBM thread
- Raccord à presser pour gaz pour tube multicouche - filetage Standard RBM
- Обжимной фитинг для металлопластиковых труб для газоснабжения - стандартная резьба RBM
- Racord prin presare pentru gaz pentru conductă multistrat - filet Standard RBM
- Adaptador Standard RBM Gas para tubo multicapa
- Schraubanschluss für Gas für Mehrschichtverbundrohr - Standardgewinde RBM

Code Code Артикул Cod Código Code	Size Dim. Раз. Dimensiune Med. Abm.	EURO EURO EURO EURO EURO	Pack Cond. Уп-ка Ambalaj Caja Verp.
1953.16.00	16x2	5,26	10
1953.20.00	20x2	6,18	10

Size: Outside Ø x pipe thickness.

Suitable for the implementation of networks transporting gaseous fuels, according to UNI/TS 11343 and UNI/TS 11344

"Metal-plastic multilayer pipe systems and fittings for transporting gaseous fuels for internal plants"

032

Compression fitting for Tita-gas multilayer pipe.

- Brass nut, core and pipe clamping ogive
- Nickel plated nut
- HNBR seals (complying with UNI EN 682)
- Euroconus threaded connection G3/4" UNI-EN-ISO 228
- Maximum operating pressure: 0.5 bar



G 3/4" EK

- Compression fitting for gas for multilayer pipe - Euroconus thread
- Raccord à serrer pour gaz pour tube multicouche - filetage Euroconus
- Обжимной фитинг для металлопластиковых труб для газоснабжения - резьба Euroconus
- Racord prin presare pentru gaz pentru conductă multistrat - filet Standard RBM
- Adaptador Euroconus Gas para tubo multicapa
- Schraubanschluss für Gas für Mehrschichtverbundrohr - Standardgewinde Euroconus

Code Code Артикул Cod Código Code	Size Dim. Раз. Dimensiune Med. Abm.	EURO EURO EURO EURO EURO	Pack Cond. Уп-ка Ambalaj Caja Verp.
1954.16.00	16x2	8,07	10
1954.20.00	20x2	8,92	10

Size: Outside Ø x pipe thickness.

Suitable for the implementation of networks transporting gaseous fuels, according to UNI/TS 11343 and UNI/TS 11344

"Metal-plastic multilayer pipe systems and fittings for transporting gaseous fuels for internal plants"

032

Manifold complete with integrated shut-off valve.

- Inlet connection G1" UNI-EN-ISO 228
- Euroconus G3/4" junction connections
- Max temperature 60°C
- Maximum operating pressure: 5 bar



- Manifold complete with integrated shut-off valve
- Collecteur avec robinet d'arrêt intégré.
- Коллектор со встроенным отсекающим клапаном
- Colector prevăzut cu supapă integrată de interceptare
- Colector Gas con válvula interceptación, para tubo multicapa gas
- Sammler komplett mit eingebautem Absperrventil

Code Code Артикул Cod Código Code	Dimension Dimension Размер Dimensiune Dimensiones Abmessung	n. ways Nb points de décrochage к-во отводов nr. deconectări Nº Vías Anz. Unterbrechungen	EURO EURO EURO EURO EURO EURO	Pack Cond. Уп-ка Ambalaj Caja Verp.
2136.06.02	1"	2-way	46,68	1
2137.06.02	1"	3-way	49,69	1

Inlet connection G1" UNI-EN-ISO 228
 Euroconus G3/4" junction connections

055



Use press fittings (see page 1.01) or compression fittings (see page 1.08) with G 3/4" Euroconus thread for the junction pipe connection.

Inspectionable metal box for manifolds, for buried systems.

- Metal box
- Adjustable height cover
- Nr. 2 supports for manifold fixing
- Box dimensions (2-way)
(LxHxP) = 250x195x75 mm
- Box dimensions (3-way)
(LxHxP) = 300x195x75 mm



- Inspectionable metal box for manifolds, for buried systems
- Coffret métallique contrôlable pour collecteur, pour installations encastrées
- Металлический монтажный шкаф для коллекторов, подходит для скрытых систем
- Casetă metalică cu posibilitate de inspectare pentru colectoare, pentru instalații poziționate în jgheaburi
- Caja metálica empotrable e inspeccionable para colector Gas
- Kontrollierbarer Metallkasten für Sammler, für Unterputzanlagen

Code Code Артикул Cod Código Code	suitable for manifold Indiqué pour collecteur подходит для коллекторов adecvată pentru colector Collector geeignet für Sammler	EURO EURO EURO EURO EURO EURO	Pack Cond. Уп-ка Ambalaj Caja Verp.
2138.00.02	2-way	49,91	1
2139.00.02	3-way	52,21	1

055

Supports for manifold fixing kit.

Kit composed of 2 pieces.



- Supports for manifold fixing kit
- Kit de supports de fixation collecteur
- Набор для крепления коллекторов
- Kit suporturi pentru fixare colector
- Par soportes de para colector Gas en caja metálica
- Bausatz Halterungen für Sammlerbefestigung

Code Code Артикул Cod Código Code	EURO EURO EURO EURO EURO EURO	Pack Cond. Уп-ка Ambalaj Caja Verp.
2141.00.02	3,82	1

055



Valve kit plus box for buried systems.

- Kit includes:
- Ball valve
 - box for buried gas systems
 - adjustable support brackets
 - protective cap
 - Euroconus G3/4" connection
 - Max temperature 60°C
 - Maximum operating pressure: 5 bar

- Valve kit plus box for buried systems
- Kit vanne pour coffret pour installations encastrées
- Комплект клапан и коробка для скрытых установок
- Kit supapă plus cutie pentru instalații poziționate în jgheaburi
- Kit válvula de esfera y caja empotrar, para tubo multicapa gas
- Bausatz Ventil plus Dose für Unterputzanlagen

Code Code Артикул Cod Código Code	Dimension Dimension Dimensiune Dimensiones Abmessung	EURO EURO EURO EURO EURO	Pack Cond. Уп-ка Ambalaj Caja Verp.
2142.00.02		44,47	1

Euroconus G3/4" connection

055



Kit for buried systems.

Use press fittings (see page 1.01) or compression fittings (see page 1.08) with G 3/4" Euroconus thread for the pipe connection.

Cover plate.

Suitable for valve kit for buried systems code 2142.00.02

Available in version
White, or satin chrome.



- Cover plate
- Plaque de revêtement
- Крышка
- Placa de acoperire
- Tapa para kit válvula de esfera y caja empotrar
- Abdeckplatte

Code Code Артикул Cod Código Code	Finish Finition Доводка Finisaj Acabado Oberflächenbehandlung	EURO EURO EURO EURO EURO	Pack Cond. Уп-ка Ambalaj Caja Verp.
2143.00.02	White	6,36	1
2143.00.12	Satin chrome	11,33	1

055

built-in kit for outlet fitting.

- Kit includes:
- Threaded angled fitting
 - Box for buried gas systems
 - White adjustable plate
 - Adjustable support brackets
 - Protective cap
 - Euroconus G3/4" inlet connection
 - Outlet connection 1/2" F UNI-ISO 7/1 (UNI EN 10226)
 - Sandwich box
 - ABS white cover plate
 - Max temperature 60°C
 - Maximum operating pressure: 5 bar

- built-in kit for outlet fitting
- Kit encastrable pour raccord de sortie
- Встраиваемый комплект для выходного соединения
- Kit de încastrat pentru racord de ieșire
- Kit racor 1/2" hembra, caja empotrar y tapa, para tubo multicapa gas
- Einbaubausatz für Ausgangsanschlüsse



Code Code Артикул Cod Código Code	Dimension Dimension Dimensiune Dimensiones Abmessung	EURO EURO EURO EURO EURO	Pack Cond. Уп-ка Ambalaj Caja Verp.
2140.00.02		45,41	1

Euroconus G3/4" inlet connection
Outlet side F1/2" connection

055



Use press fittings (see page 1.01) or compression fittings (see page 1.08) with G 3/4" Euroconus thread for the pipe connection.



Tita-fix 

 **HYDROTHERMAL
DISTRIBUTION SYSTEM
RBM TITA-FIX**

 *SYSTÈME DE DISTRIBUTION HYDROTHERMIQUE
RBM TITA-FIX*

 *ТРУБЫ И КОМПЛЕКТУЮЩИЕ ДЛЯ СИСТЕМ ВОДО- И
ТЕПЛОСНАБЖЕНИЯ RBM TITA-FIX*

 *SISTEM DE DISTRIBUȚIE HIDROTHERMICĂ RBM TITA-FIX*

 *SISTEMA DE DISTRIBUCIÓN HIDROTÉRMICA RBM TITA-FIX*

 *SYSTEM ZUR HYDROTHERMISCHEN VERSORGUNG
RBM TITA-FIX*

- A ■ PE-Xc Multilayer pipe for water distribution
- B ■ PE-RT Multilayer pipe for water distribution
- C ■ RBM Tita-fast quick coupling fittings
- D ■ Press fittings for hydrothermal distribution



PE-Xc RBM Tita-fix multilayer pipe.

- Composition PE-Xc/Al/PE-RT
- White
- Poper 10 bar
- Tmal 95°C
- Duration at operating conditions ~ 50 years



- PE-Xc RBM Tita-fix multilayer pipe in roll
- Tube multicouche PE-Xc RBM Tita-fix en rouleau
- Металлопластиковая труба PE-Xc RBM Tita-fix в бухтах
- Conductă multistrat PE-Xc RBM Tita-fix în colac
- Tube multicapa PE-Xc RBM Tita-fix, en rollos
- Tube multistrato PE-Xc RBM Tita-fix in rotolo

Code Code Артикул Cod Código Code	Size Pipe Dim. Tube Раз. Трубы Dimensiune Conductă Med. Tubo Abm. Rohr	Aluminium th. Ep. aluminium Толщ. алюминия Gros. Aluminii Espesor alum. St. Aluminium	Roll Rouleau Бухта Colac Rollo Rolle	EURO EURO EURO EURO EURO EURO	Pack Cond. Уп-ка Ambalaj Caja Verp.
1542.16.00	16x2	0,20 mm	100 m	1,41	1
1542.20.00	20x2	0,30 mm	100 m	1,85	1
1542.26.00	26x3	0,40 mm	50 m	3,75	1
1542.32.00	32x3	0,40 mm	50 m	6,16	1

Size: Outside Ø x pipe thickness

- PE-Xc RBM Tita-fix multilayer pipe in bars
- Tube multicouche PE-Xc RBM Tita-fix en barres
- Металлопластиковая труба PE-Xc RBM Tita-fix в штангах
- Conductă multistrat PE-Xc RBM Tita-fix în bare
- Tube multicapa PE-Xc RBM Tita-fix, en barras
- Mehrschichtverbundrohr PE-Xc RBM Tita-fix in Stangen

Code Code Артикул Cod Código Code	Size Pipe Dim. Tube Раз. Трубы Dimensiune Conductă Med. Tubo Abm. Rohr	Aluminium th. Ep. aluminium Толщ. алюминия Gros. Aluminii Espesor alum. St. Aluminium	Bar Barre Штанга Bară Barra Stange	EURO EURO EURO EURO EURO EURO	Pack Cond. Уп-ка Ambalaj Caja Verp.
1543.16.00	16x2	0,20 mm	4 m	1,70	25
1543.20.00	20x2	0,30 mm	4 m	2,22	19
1543.26.00	26x3	0,40 mm	4 m	4,51	10
1543.32.00	32x3	0,40 mm	4 m	7,39	6

Size: Outside Ø x pipe thickness

Compliant with:
- DM n° 174/04



033MC



The entire package must be ordered.

PE-Xc RBM Tita-fix multilayer pipe, protected externally with polypropylene corrugated conduit.

Pipe features as in code 1542-1543.

- Corrugated conduit features:
- outside diameter of pipe 16x2: 25 mm
 - outside diameter of pipe 20x2: 32 mm



- PE-Xc RBM Tita-fix multilayer pipe in roll with protective corrugated conduit
- Tube multicouche PE-Xc RBM Tita-fix en rouleau avec gaine ondulée de protection
- Металлопластиковая труба PE-Xc RBM Tita-fix в бухтах с защитной гофрой
- Conductă multistrat PE-Xc RBM Tita-fix în colac cu înveliș de protecție cu striiații
- Tube multicapa PE-Xc RBM Tita-fix con vaina corrugada de protección, en rollos
- Mehrschichtverbundrohr PE-Xc RBM Tita-fix auf Rolle mit gefaltem Schutzmantel

Code Code Артикул Cod Código Code	Size Pipe Dim. Tube Раз. Трубы Dimensiune Conductă Med. Tubo Abm. Rohr	Aluminium th. Ep. aluminium Толщ. алюминия Gros. Aluminii Espesor alum. St. Aluminium	Roll Rouleau Бухта Colac Rollo Rolle	EURO EURO EURO EURO EURO EURO	Pack Cond. Уп-ка Ambalaj Caja Verp.
1541.16.80	16x2 (Blue)	0,20 mm	50 m	2,27	1
1541.16.90	16x2 (Red)	0,20 mm	50 m	2,27	1
1541.20.80	20x2 (Blue)	0,30 mm	50 m	2,91	1
1541.20.90	20x2 (Red)	0,30 mm	50 m	2,91	1

Size: Outside Ø x pipe thickness

Compliant with:
- DM n° 174/04



033MC



Suitable for domestic hot water distribution systems.

PE-Xc RBM Tita-fix multilayer pipe externally insulated with closed cell expanded polyethylene conduit, CFC-free, flame retardant.

Installation compliant with the law 10/91 and valid for pipes running in heated environments and/or structures not bordering with the outside or with unheated rooms.

Pipe features as in code 1542-1543.

Insulating conduit features:

- Density 35 kg/m³
- Thermal conductivity at 40 °C
- conduit only: 0.040 W/mK
- conduit + pipe (average value): 0.069 W/mK
- Steam permeability ? 3.500
- Insulation thickness 6 mm
- Reaction to fire class I



- PE-Xc RBM Tita-fix multilayer pipe in roll with thermal insulation
- Tube multicouche PE-Xc RBM Tita-fix en rouleau à isolation thermique
- Металлопластиковая труба PE-Xc RBM Tita-fix в бухтах с теплоизоляцией
- Conductă multistrat PE-Xc RBM Tita-fix în colac cu izolare termică
- Tubo multicapa PE-Xc RBM Tita-fix con aislamiento térmico, en rollos
- Mehrschichtverbundrohr PE-Xc RBM Tita-fix auf Rolle mit Wärmedämmung

Code Code Артикул Cod Código Code	Size Pipe Dim. Tube Раз. Трубы Dimensiune Conductă Med. Tubo Abm. Rohr	Aluminium th. Ép. aluminium Толщ. алюминия Gros. Aluminii Espesor alum. St. Aluminium	Roll Rouleau Бухта Colac Rollo Rolle	EURO EURO EURO EURO EURO EURO	Pack Cond. Уп-ка Ambalaj Caja Verp.
1541.16.50	16x2 (*)	0,20 mm	50 m	2,35	1
1541.20.50	20x2	0,30 mm	50 m	2,63	1
1541.26.50	26x3	0,40 mm	50 m	4,64	1
1541.32.50	32x3	0,40 mm	25 m	7,44	1

Size: Outside Ø x pipe thickness

(*) Diameters comply with Law 10/91

Compliant with:
- DM n° 174/04



033MC



Suitable for heating and domestic hot water distribution systems.

PE-Xc RBM Tita-fix multilayer pipe externally insulated with closed cell expanded polyethylene anti-condensation conduit, CFC-free, flame retardant.

Installation compliant with the law 10/91 and valid for pipes running in heated environments and/or structures not bordering with the outside or with unheated rooms.

Pipe features as in code 1542-1543.

Insulating conduit features:

- Density 35 kg/m³
- Thermal conductivity at 40 °C
- conduit only 0.040 W/mK
- conduit + pipe (average value) 0.062 W/mK
- Steam permeability ? 6,500
- Insulation thickness 10 mm
- Reaction to fire class I



- PE-Xc RBM Tita-fix multilayer pipe in roll with thermal anti-condensation insulation
- Tube multicouche PE-Xc RBM Tita-fix en rouleau à isolation thermique anti-condensation
- Металлопластиковая труба PE-Xc RBM Tita-fix в бухтах
- Conductă multistrat PE-Xc RBM Tita-fix în colac cu izolare termică împotriva condensului
- Tubo multicapa PE-Xc RBM Tita-fix con aislamiento térmico anti-condensación, en rollos
- Mehrschichtverbundrohr PE-Xc RBM Tita-fix auf Rolle mit kondensfestem Wärmeschutz

Code Code Артикул Cod Código Code	Size Pipe Dim. Tube Раз. Трубы Dimensiune Conductă Med. Tubo Abm. Rohr	Aluminium th. Ép. aluminium Толщ. алюминия Gros. Aluminii Espesor alum. St. Aluminium	Roll Rouleau Бухта Colac Rollo Rolle	EURO EURO EURO EURO EURO EURO	Pack Cond. Уп-ка Ambalaj Caja Verp.
1541.16.40	16x2	0,20 mm	50 m	2,72	1
1541.20.40	20x2	0,30 mm	50 m	3,45	1
1541.26.40	26x3	0,40 mm	50 m	6,14	1
1541.32.40	32x3	0,40 mm	25 m	10,30	1

Size: Outside Ø x pipe thickness

Compliant with:
- DM n° 174/04



033MC



Suitable for hydronic refrigeration and heating systems

PE-RT RBM Tita-fix multilayer pipe.

- Composition PE-RT/Al/PE-RT
- White
- Poper 10 bar
- Tmal 95°C
- Duration at operating conditions ~ 50 years



- PE-RT RBM Tita-fix multilayer pipe in roll
- Tube multicouche PE-RT RBM Tita-fix en rouleau*
- Металлопластиковая труба PE-RT RBM Tita-fix в бухтах*
- Conductă multistrat PE-RT RBM Tita-fix în colac*
- Tubo multicapa PE-RT RBM Tita-fix, en rollos*
- Mehrschichtverbundrohr PE-RT RBM Tita-gas auf Rolle*

Code Code Артикул Cod Código Code	Size Pipe Dim. Tube Раз. Трубы Dimensiune Conductă Med. Tubo Abm. Rohr	Aluminium th. Ép. aluminium Толщ. алюминия Gros. Aluminii Espesor alum. St. Aluminium	Roll Rouleau Бухта Colac Rollo Rolle	EURO EURO EURO EURO EURO EURO	Pack Cond. Уп-ка Ambalaj Caja Verp.
1545.16.00	16x2	0,20 mm	100 m	1,18	1
1545.20.00	20x2	0,30 mm	100 m	1,60	1
1545.26.00	26x3	0,40 mm	50 m	3,27	1
1545.32.00	32x3	0,40 mm	50 m	5,37	1
1545.40.00	40x3,5	0,50 mm	25 m	10,72	1

Size: Outside Ø x pipe thickness

- PE-RT RBM Tita-fix multilayer pipe in bars
- Tube multicouche PE-RT RBM Tita-fix en barres*
- Металлопластиковая труба PE-RT RBM Tita-fix в штангах*
- Conductă multistrat PE-RT RBM Tita-fix în bare*
- Tubo multicapa PE-RT RBM Tita-fix, en barras*
- Mehrschichtverbundrohr PE-RT RBM Tita-fix in Stangen*

Code Code Артикул Cod Código Code	Size Pipe Dim. Tube Раз. Трубы Dimensiune Conductă Med. Tubo Abm. Rohr	Aluminium th. Ép. aluminium Толщ. алюминия Gros. Aluminii Espesor alum. St. Aluminium	Bar Barre Штанга Bară Barra Stange	EURO EURO EURO EURO EURO EURO	Pack Cond. Уп-ка Ambalaj Caja Verp.
1546.16.00	16x2	0,20 mm	4 m	1,46	25
1546.20.00	20x2	0,30 mm	4 m	2,08	19
1546.26.00	26x3	0,40 mm	4 m	3,76	10
1546.32.00	32x3	0,40 mm	4 m	6,29	6
1546.40.00	40x3,5	0,50 mm	5 m	13,94	10
1546.50.00	50x4	0,60 mm	5 m	19,81	3
1546.63.00	63x4,5	0,80 mm	5 m	26,59	1

Size: Outside Ø x pipe thickness

Compliant with:
 - DM n° 174/04
 - ACS



033MT



The entire package must be ordered.

PE-RT RBM Tita-fix multilayer pipe, protected externally with polypropylene corrugated conduit.

Pipe features as in code 1545-1546.

Corrugated conduit features:

- outside diameter of pipe 16x2: 25 mm
- outside diameter of pipe 20x2: 32 mm



- PE-RT RBM Tita-fix multilayer pipe in roll with protective corrugated conduit
- Tube multicouche PE-RT RBM Tita-fix en rouleau avec gaine ondulée de protection*
- Металлопластиковая труба PE-RT RBM Tita-fix в бухтах*
- Conductă multistrat PE-RT RBM Tita-fix în colac cu înveliș de protecție cu striții*
- Tubo multicapa PE-RT RBM Tita-fix con vaina de protecțion, en rollos*
- Mehrschichtverbundrohr PE-RT RBM Tita-fix auf Rolle mit gefaltem Schutzmantel*

Code Code Артикул Cod Código Code	Size Pipe Dim. Tube Раз. Трубы Dimensiune Conductă Med. Tubo Abm. Rohr	Aluminium th. Ép. aluminium Толщ. алюминия Gros. Aluminii Espesor alum. St. Aluminium	Roll Rouleau Бухта Colac Rollo Rolle	EURO EURO EURO EURO EURO EURO	Pack Cond. Уп-ка Ambalaj Caja Verp.
1544.16.80	16x2 (Blue)	0,20 mm	50 m	2,09	1
1544.16.90	16x2 (Red)	0,20 mm	50 m	2,09	1
1544.20.80	20x2 (Blue)	0,30 mm	50 m	2,66	1
1544.20.90	20x2 (Red)	0,30 mm	50 m	2,66	1

Size: Outside Ø x pipe thickness

Compliant with:
 - DM n° 174/04
 - ACS



033MT



Suitable for domestic hot water distribution systems.

PE-RT RBM Tita-fix multilayer pipe externally insulated with closed cell expanded polyethylene conduit, CFC-free, flame retardant.

Installation compliant with the law 10/91 and valid for pipes running in heated environments and/or structures not bordering with the outside or with unheated rooms.

Pipe features as in code 1545-1546.

Insulating conduit features:

- Density 35 kg/m³
- Thermal conductivity at 40 °C
- conduit only: 0.040 W/mK
- conduit + pipe (average value): 0.069 W/mK
- Steam permeability ? 3.500
- Insulation thickness 6 mm
- Reaction to fire class I

Compliant with:
 - DM n° 174/04
 - ACS



033MT

- PE-RT RBM Tita-fix multilayer pipe in roll with thermal insulation
- Tube multicouche PE-RT RBM Tita-fix en rouleau à isolation thermique
- Металлопластиковая труба PE-RT RBM Tita-fix в бухтах
- Conductă multistrat PE-RT RBM Tita-fix în colac cu izolare termică
- Tubo multicapa PE-RT RBM Tita-fix con aislamiento térmico, en rollos
- Mehrschichtverbundrohr PE-RT RBM Tita-fix auf Rolle mit Wärmedämmung

Code Code Articul Cod Código Code	Size Pipe Dim. Tube Раз. Трубы Dimensiune Conductă Med. Tubo Abm. Rohr	Aluminium th. Ep. aluminium Толщ. алюминия Gros. Aluminii Espesor alum. St. Aluminium	Roll Rouleau Бухта Colac Rollo Rolle	EURO EURO EURO EURO EURO EURO	Pack Cond. Уп-ка Ambalaj Caja Verp.
1544.16.50	16x2 (*)	0,20 mm	50 m	2,04	1
1544.20.50	20x2	0,30 mm	50 m	2,29	1
1544.26.50	26x3	0,40 mm	50 m	4,04	1
1544.32.50	32x3	0,40 mm	25 m	6,45	1

Size: Outside Ø x pipe thickness
 (*) Diameters comply with Law 10/91



Suitable for heating and domestic hot water distribution systems.

PE-RT RBM Tita-fix multilayer pipe externally insulated with closed cell expanded polyethylene anti-condensation conduit, CFC-free, flame retardant.

Installation compliant with the law 10/91 and valid for pipes running in heated environments and/or structures not bordering with the outside or with unheated rooms.

Pipe features as in code 1545-1546.

Insulating conduit features:

- Density 35 kg/m³
- Thermal conductivity at 40 °C
- conduit only 0.040 W/mK
- conduit + pipe (average value) 0.062 W/mK
- Steam permeability ? 6,500
- Insulation thickness 10 mm
- Reaction to fire class I

Compliant with:
 - DM n° 174/04
 - ACS



033MT

- PE-RT RBM Tita-fix multilayer pipe in roll with thermal anti-condensation insulation
- Tube multicouche PE-RT RBM Tita-fix en rouleau à isolation thermique anti-condensation
- Металлопластиковая труба PE-RT RBM Tita-fix в бухтах
- Conductă multistrat PE-RT RBM Tita-fix în colac cu izolare termică împotriva condensului
- Tubo multicapa PE-RT RBM Tita-fix con aislamiento térmico anti-condensación, en rollos
- Mehrschichtverbundrohr PE-RT RBM Tita-fix auf Rolle mit kondensfestem Wärmeschutz

Code Code Articul Cod Código Code	Size Pipe Dim. Tube Раз. Трубы Dimensiune Conductă Med. Tubo Abm. Rohr	Aluminium th. Ep. aluminium Толщ. алюминия Gros. Aluminii Espesor alum. St. Aluminium	Roll Rouleau Бухта Colac Rollo Rolle	EURO EURO EURO EURO EURO EURO	Pack Cond. Уп-ка Ambalaj Caja Verp.
1544.16.40	16x2	0,20 mm	50 m	2,37	1
1544.20.40	20x2	0,30 mm	50 m	3,01	1
1544.26.40	26x3	0,40 mm	50 m	4,86	1
1544.32.40	32x3	0,40 mm	25 m	8,96	1

Size: Outside Ø x pipe thickness



Suitable for hydronic refrigeration and heating systems.

Quick coupling fitting for Tita-fix multilayer pipe.

- Transparent technopolymer body
- Brass core
- Stainless steel AISI 301 pipe clamp
- Peroxidic EPDM seals
- Standard RBM threaded connection W24.5x19F
- Max operating pressure 1000KPa
- Max temperature 95°C



- Quick coupling fitting for multilayer pipe - standard RBM thread
- Raccord à attache rapide pour tube multicouche - filetage standard RBM
- Фитинг с системой быстрого монтажа для металлопластиковых труб - стандартная резьба RBM
- Raccord cu cuplare rapidă pentru conductă multistrat- filet standard RBM
- Racor Rápido recto para conexión Standard RBM, para tubo multicapa
- Schnellsteckkupplung für Mehrschichtverbundrohr - Standardgewinde RBM

Code Code Articul Cod Código Code	Size A Dim. A Pas. A Dimens. A Med. A Abm. A	Size B Dim. B Pas. B Dimens. B Med. B Abm. B	EURO EURO EURO EURO EURO EURO	Pack Cond. Уп-ка Ambalaj Caja Verp.
1927.16.00	16x2	RBM	3,70	10
1927.20.00	20x2	RBM	4,05	10

Size A: Outside Ø x pipe thickness



Quick connection on terminal elements with standard RBM thread.

029



Press fitting for Tita-fix multilayer pipe.

- Multi-clamp fitting.
- Compatible with clamps series:
 - TH, H, U, B for Ø 14x2;
 - TH, H, U, B, F for Ø 16x2 - 18x2 and 20x2;
 - TH, H, B for Ø 26x3;
 - TH, H for Ø 32x3;
 - TH for Ø 40x3.5 - 50x4 e 63x4.5
- Externally nickel-plated brass body
- EPDM seals
- Stainless steel pipe clamping bush
- Dielectric pipe clamp cover in PE
- Threaded connection UNI-EN-ISO 228
- Max temperature 95 °C
- Max operating pressure 1000 kPa

- Press fitting for multilayer pipe - rotary nut - flat seat gas thread
- Raccord à presser pour gaz pour tube multicouche - écrou tournant - filetage gaz garniture plate
- Пресс-фитинг для металлопластиковых труб -с накидной гайкой - резьба плоское уплотнение
- Racord cu presare pentru conductă multistrat - piuliță rotantă - filet gaz garnitură plată
- Racor Press Fitting Gas recto con tuerca loca para junta plana para tubo multicapa gas
- Steckanschluss für Mehrschichtverbundrohr Überwurfmutter - Gasgewinde flach dichtend

Code Code Артикул Cod Código Code	Size A Dim. A Pаз. A Dimens. A Med.A Abm. A	Size B Dim. B Pаз. B Dimens. B Med.B Abm. B	EURO EURO EURO EURO EURO EURO	Pack Cond. Уп-ка Ambalaj Caja Verp.
812.14.10	14x2	3/8" F	6,29	10
812.14.20	14x2	1/2" F	6,29	10
812.16.10	16x2	3/8" F	6,29	10
812.16.20	16x2	1/2" F	6,29	10
812.16.30	16x2	3/4" F	7,18	10
812.18.30	18x2	3/4" F	7,25	10
812.20.30	20x2	3/4" F	7,77	10
812.26.40	26x3	1" F	9,93	10
812.32.50	32x3	1 1/4" F	13,79	10

Size A: Outside Ø x pipe thickness

032

- ACS



Press fitting for Tita-fix multilayer pipe.

- Multi-clamp fitting.
- Compatible with clamps series:
 - TH, H, U, B for Ø 14x2;
 - TH, H, U, B, F for Ø 16x2 - 18x2 and 20x2;
 - TH, H, B for Ø 26x3;
 - TH, H for Ø 32x3;
 - TH for Ø 40x3.5 - 50x4 e 63x4.5
- Externally nickel-plated brass body
- EPDM seals
- Stainless steel pipe clamping bush
- Dielectric pipe clamp cover in PE
- Euroconus threaded connection G3/4" UNI-EN-ISO 228
- Max temperature 95 °C
- Max operating pressure 1000 kPa

- Press fitting for multilayer pipe - rotary nut - Euroconus seal gas thread
- Raccord à presser pour gaz pour tube multicouche- écrou tournant - filetage gaz garniture Euroconus
- Пресс-фитинг для металлопластиковых труб -с накидной гайкой - резьба уплотнение Euroconus
- Racord cu presare pentru conductă multistrat - piuliță rotantă - filet gaz garnitură Euroconus
- Racor Press Fitting recto con tuerca loca para junta plana para tubo multicapa
- Steckanschluss für Mehrschichtverbundrohr Überwurfmutter - Gasgewinde Euroconus dichtend

Code Code Артикул Cod Código Code	Size A Dim. A Pаз. A Dimens. A Med.A Abm. A	Size B Dim. B Pаз. B Dimens. B Med.B Abm. B	EURO EURO EURO EURO EURO EURO	Pack Cond. Уп-ка Ambalaj Caja Verp.
963.16.30	16x2	Euroconus	8,22	10
963.18.30	18x2	Euroconus	8,48	10
963.20.30	20x2	Euroconus	8,73	10
963.26.30	26x3	Euroconus	10,10	10

Size A: Outside Ø x pipe thickness

032

- ACS



Press fitting for Tita-fix multilayer pipe.

- Multi-clamp fitting.
- Compatible with clamps series:
 - TH, H, U, B for Ø 14x2;
 - TH, H, U, B, F for Ø 16x2 - 18x2 and 20x2;
 - TH, H, B for Ø 26x3;
 - TH, H for Ø 32x3;
 - TH for Ø 40x3.5 - 50x4 e 63x4.5
- Externally nickel-plated brass body
- EPDM seals
- Stainless steel pipe clamping bush
- Dielectric pipe clamp cover in PE
- Standard RBM threaded connection W24.5x19F
- Max temperature 95 °C
- Max operating pressure 1000 kPa

- Press fitting for multilayer pipe - rotary nut - standard RBM thread
- Raccord à presser pour gaz pour tube multicouche- écrou tournant - filetage Standard RBM
- Пресс-фитинг для металлопластиковых труб -с накидной гайкой - резьба стандартная RBM
- Racord cu presare pentru conductă multistrat - piuliță rotantă - filet standard RBM
- Racor Press Fitting recto con tuerca loca para conexión Standard RBM, para tubo multicapa
- Steckanschluss für Mehrschichtverbundrohr - Überwurfmutter - Standardgewinde RBM

Code Code Артикул Cod Código Code	Size A Dim. A Pаз. A Dimens. A Med.A Abm. A	Size B Dim. B Dim. B Dimens. B Med.B Abm. B	EURO EURO EURO EURO EURO EURO	Pack Cond. Уп-ка Ambalaj Caja Verp.
826.14.00	14x2	RBM	7,58	10
826.16.00	16x2	RBM	7,58	10
826.18.00	18x2	RBM	8,17	10
826.20.00	20x2	RBM	8,60	10

Size A: Outside Ø x pipe thickness

032

- ACS

Press fitting for Tita-fix multilayer pipe.

- Multi-clamp fitting.
 Compatible with clamps series:
 - TH, H, U, B for Ø 14x2;
 - TH, H, U, B, F for Ø 16x2 - 18x2 and 20x2;
 - TH, H, B for Ø 26x3;
 - TH, H for Ø 32x3;
 - TH for Ø 40x3.5 - 50x4 e 63x4.5
- Externally nickel-plated brass body
 - EPDM seals
 - Stainless steel pipe clamping bush
 - Dielectric pipe clamp cover in PE
 - Withworth threaded connection W 28 x 19 F
 - Max temperature 95 °C
 - Max operating pressure 1000 kPa



- Press fitting for multilayer pipe - rotary nut - thread W28x19F
- Raccord à presser pour gaz pour tube multicouche - écrou tournant - filetage W28x19F
- Пресс-фитинг для металлопластиковых труб - с накидной гайкой - резьба W28x19F
- Racord cu presare pentru conductă multistrat - piuliță rotantă - filet W28x19F
- Racor Press Fitting recto con tuercas para conexión Withworth W28x19F, para tubo multicapa
- Steckanschluss für Mehrschichtverbundrohr - Überwurfmutter - Gewinde W28x19F

Code Code Артикул Cod Código Code	Size A Dim. A Pas. A Dimens. A Med. A Abm. A	Size B Dim. B Pas. B Dimens. B Med. B Abm. B	EURO EURO EURO EURO EURO EURO	Pack Cond. Уп-ка Ambalaj Caja Verp.
962.14.00	14x2	W 28x19F	8,77	10
962.16.00	16x2	W 28x19F	9,04	10
962.20.00	20x2	W 28x19F	9,76	10
962.26.00	26x3	W 28x19F	10,24	10

Size A: Outside Ø x pipe thickness

032

- ACS

Press fitting for Tita-fix multilayer pipe.

- Multi-clamp fitting.
 Compatible with clamps series:
 - TH, H, U, B for Ø 14x2;
 - TH, H, U, B, F for Ø 16x2 - 18x2 and 20x2;
 - TH, H, B for Ø 26x3;
 - TH, H for Ø 32x3;
 - TH for Ø 40x3.5 - 50x4 e 63x4.5

- Press fitting for multilayer pipe - straight - intermediate
- Raccord à presser pour gaz pour tube multicouche - droit - intermédiaire
- Пресс-фитинг для металлопластиковых труб - прямой - промежуточный
- Racord cu presare pentru conductă multistrat - drept - intermediar
- Manguito Press Fitting Gas, para tubo multicapa
- Steckanschluss für Mehrschichtverbundrohr - gerade - Zwischenstück

Code Code Артикул Cod Código Code	Size A Dim. A Pas. A Dimens. A Med. A Abm. A	EURO EURO EURO EURO EURO EURO	Pack Cond. Уп-ка Ambalaj Caja Verp.
671.14.00	14x2	4,30	10
671.16.00	16x2	4,73	10
671.18.00	18x2	5,56	10
671.20.00	20x2	6,10	10
671.26.00	26x3	7,27	10
671.32.00	32x3	8,86	5
671.40.00	40x3,5	16,52	5
671.50.00	50x4	29,76	4
671.63.00	63x4,5	40,40	3

Size A: Outside Ø x pipe thickness



032

- ACS

Press fitting for Tita-fix multilayer pipe.

- Multi-clamp fitting.
 Compatible with clamps series:
 - TH, H, U, B for Ø 14x2;
 - TH, H, U, B, F for Ø 16x2 - 18x2 and 20x2;
 - TH, H, B for Ø 26x3;
 - TH, H for Ø 32x3;
 - TH for Ø 40x3.5 - 50x4 e 63x4.5

- Press fitting for multilayer pipe - straight - female gas connection
- Raccord à presser pour gaz pour tube multicouche - droit - branchement femelle gaz
- Пресс-фитинг для металлопластиковых труб - прямой - вн. резьба
- Racord cu presare pentru conductă multistrat - drept - prindere tip mamă gaz
- Racor Press Fitting Gas recto hembra, para tubo multicapa gas
- Steckanschluss für Mehrschichtverbundrohr - gerade - Aufsteckanschluss Gas

Code Code Артикул Cod Código Code	Size A Dim. A Pas. A Dimens. A Med. A Abm. A	Size B Dim. B Pas. B Dimens. B Med. B Abm. B	EURO EURO EURO EURO EURO EURO	Pack Cond. Уп-ка Ambalaj Caja Verp.
672.14.20	14x2	1/2" F	3,93	10
672.16.20	16x2	1/2" F	4,05	10
672.18.20	18x2	1/2" F	4,28	10
672.18.30	18x2	3/4" F	5,68	10
672.20.20	20x2	1/2" F	4,50	10
672.20.30	20x2	3/4" F	6,21	10
672.26.30	26x3	3/4" F	6,90	10
672.26.40	26x3	1" F	9,22	10
672.32.40	32x3	1" F	9,77	5
672.40.40	40x3,5	1" F	10,42	5
672.40.50	40x3,5	1 1/4" F	14,84	5
672.50.60	50x4	1 1/2" F	22,21	5
672.63.70	63x4,5	2" F	29,61	1

Size A: Outside Ø x pipe thickness



032

- ACS

Press fitting for Tita-fix multilayer pipe.

- Multi-clamp fitting.
 Compatible with clamps series:
 - TH, H, U, B for Ø 14x2;
 - TH, H, U, B, F for Ø 16x2 - 18x2 and 20x2;
 - TH, H, B for Ø 26x3;
 - TH, H for Ø 32x3;
 - TH for Ø 40x3.5 - 50x4 e 63x4.5
- Externally nickel-plated brass body
 - EPDM seals
 - Stainless steel pipe clamping bush
 - Dielectric pipe clamp cover in PE
 - Straight threaded connection M UNI-EN-ISO 228
 - Max temperature 95 °C
 - Max operating pressure 1000 kPa



- Press fitting for multilayer pipe - straight - male gas connection
- Raccord à presser pour gaz pour tube multicouche - droit - branchement mâle gaz
- Пресс-фитинг для металлопластиковых труб - прямой - резьба нар.
- Racord cu presare pentru conductă multistrat - drept - prindere tip tată gaz
- Racor Press Fitting recto macho, para tubo multicapa
- Steckanschluss für Mehrschichtverbundrohr - gerade - Steckverbindung Gas

Code Code Articol Cod Código Code	Size A Dim. A Pas. A Dimens. A Med.A Abm. A	Size B Dim. B Pas. B Dimens. B Med.B Abm. B	EURO EURO EURO EURO EURO EURO	Pack Cond. Уп-ка Ambalaj Caja Verp.
673.14.10	14x2	3/8" M	3,02	10
673.14.20	14x2	1/2" M	2,75	10
673.16.10	16x2	3/8" M	3,17	10
673.16.20	16x2	1/2" M	3,17	10
673.18.20	18x2	1/2" M	3,82	10
673.18.30	18x2	3/4" M	5,47	10
673.20.20	20x2	1/2" M	4,05	10
673.20.30	20x2	3/4" M	5,89	10
673.26.30	26x3	3/4" M	6,18	10
673.26.40	26x3	1" M	6,44	10
673.32.40	32x3	1" M	7,70	10
673.40.50	40x3,5	1"1/4 M	15,49	1
673.50.60	50x4	1"1/2 M	22,88	1
673.63.70	63x4,5	2" M	35,35	1

Size A: Outside Ø x pipe thickness

032

- ACS

Press fitting for Tita-fix multilayer pipe.

- Multi-clamp fitting.
 Compatible with clamps series:
 - TH, H, U, B for Ø 14x2;
 - TH, H, U, B, F for Ø 16x2 - 18x2 and 20x2;
 - TH, H, B for Ø 26x3;
 - TH, H for Ø 32x3;
 - TH for Ø 40x3.5 - 50x4 e 63x4.5
- Externally nickel-plated brass body
 - EPDM seals
 - Stainless steel pipe clamping bush
 - Dielectric pipe clamp cover in PE
 - Max temperature 95 °C
 - Max operating pressure 1000 kPa



- Press fitting for multilayer pipe - angle - intermediate
- Raccord à presser pour gaz pour tube multicouche - en angle - intermédiaire
- Пресс-фитинг для металлопластиковых труб - угловой - промежуточный
- Racord prin presare pentru conductă multistrat - cu cot - intermediar
- Codo Press Fitting 90°, para tubo multicapa
- Steckanschluss für Mehrschichtverbundrohr - Winkel - Zwischenstück

Code Code Articol Cod Código Code	Size A Dim. A Pas. A Dimens. A Med.A Abm. A	EURO EURO EURO EURO EURO EURO	Pack Cond. Уп-ка Ambalaj Caja Verp.
674.14.00	14x2	5,72	10
674.16.00	16x2	6,21	10
674.18.00	18x2	6,54	10
674.20.00	20x2	7,05	10
674.26.00	26x3	7,99	5
674.32.00	32x3	11,41	5
674.40.00	40x3,5	19,20	5
674.50.00	50x4	35,35	1
674.63.00	63x4,5	49,48	1

Size A: Outside Ø x pipe thickness

032

- ACS

Press fitting for Tita-fix multilayer pipe.

- Multi-clamp fitting.
 Compatible with clamps series:
 - TH, H, U, B for Ø 14x2;
 - TH, H, U, B, F for Ø 16x2 - 18x2 and 20x2;
 - TH, H, B for Ø 26x3;
 - TH, H for Ø 32x3;
 - TH for Ø 40x3.5 - 50x4 e 63x4.5
- Externally nickel-plated brass body
 - EPDM seals
 - Stainless steel pipe clamping bush
 - Dielectric pipe clamp cover in PE
 - Angle threaded connection F UNI-EN-ISO 228
 - Max temperature 95 °C
 - Max operating pressure 1000 kPa



- Press fitting for multilayer pipe - angle - female gas connection
- Raccord à presser pour gaz pour tube multicouche - en angle - branchement femelle gaz
- Пресс-фитинг для металлопластиковых труб - угловой - резьба вн.
- Racord prin presare pentru conductă multistrat - cu cot - prindere tip mamă gaz
- Racor Press Fitting curvo hembra, para tubo multicapa
- Steckanschluss für Mehrschichtverbundrohr - Winkel - Aufsteckanschluss Gas

Code Code Articol Cod Código Code	Size A Dim. A Pas. A Dimens. A Med.A Abm. A	Size B Dim. B Pas. B Dimens. B Med.B Abm. B	EURO EURO EURO EURO EURO EURO	Pack Cond. Уп-ка Ambalaj Caja Verp.
675.14.20	14x2	1/2" F	4,47	10
675.16.20	16x2	1/2" F	4,77	10
675.18.20	18x2	1/2" F	5,38	10
675.18.30	18x2	3/4" F	7,83	10
675.20.20	20x2	1/2" F	5,72	10
675.20.30	20x2	3/4" F	7,91	10
675.26.30	26x3	3/4" F	8,40	10
675.32.40	32x3	1" F	12,10	5
675.40.50	40x3,5	1"1/4 F	18,84	5
675.50.60	50x4	1"1/2 F	29,96	1

Size A: Outside Ø x pipe thickness

032

- ACS

Press fitting for Tita-fix multilayer pipe.

- Multi-clamp fitting.
 Compatible with clamps series:
 - TH, H, U, B for Ø 14x2;
 - TH, H, U, B, F for Ø 16x2 - 18x2 and 20x2;
 - TH, H, B for Ø 26x3;
 - TH, H for Ø 32x3;
 - TH for Ø 40x3.5 - 50x4 e 63x4.5

- Externally nickel-plated brass body
- EPDM seals
- Stainless steel pipe clamping bush
- Dielectric pipe clamp cover in PE
- Angle threaded connection M UNI-EN-ISO 228
- Max temperature 95 °C
- Max operating pressure 1000 kPa



- Press fitting for multilayer pipe - angle - male gas connection
- Raccord à presser pour gaz pour tube multicouche - en angle - branchement mâle gaz
- Пресс-фитинг для металлопластиковых труб - угловой - резьба нар.
- Racord prin presare pentru conductă multistrat - cu cot - prindere tip tată gaz
- Racor Press Fitting curvo macho, para tubo multicapa
- Druckanschluss für Mehrschichtverbundrohr - Bogen - Steckverbindung

Code Code Артикул Cod Código Code	Size A Dim. A Pas. A Dimens. A Med.A Abm. A	Size B Dim. B Pas. B Dimens. B Med. B Abm. B	EURO EURO EURO EURO EURO	Pack Cond. Уп-ка Ambalaj Caja Verp.
676.14.20	14x2	1/2" M	4,24	10
676.16.20	16x2	1/2" M	4,39	10
676.18.20	18x2	1/2" M	5,27	10
676.18.30	18x2	3/4" M	7,02	10
676.20.20	20x2	1/2" M	5,43	10
676.20.30	20x2	3/4" M	7,10	10
676.26.30	26x3	3/4" M	7,78	10
676.32.40	32x3	1" M	11,88	5
676.40.50	40x3,5	1"1/4" M	22,21	5

Size A: Outside Ø x pipe thickness

032

- ACS

Press fitting for Tita-fix multilayer pipe.

- Multi-clamp fitting.
 Compatible with clamps series:
 - TH, H, U, B for Ø 14x2;
 - TH, H, U, B, F for Ø 16x2 - 18x2 and 20x2;
 - TH, H, B for Ø 26x3;
 - TH, H for Ø 32x3;
 - TH for Ø 40x3.5 - 50x4 e 63x4.5

- Externally nickel-plated brass body
- EPDM seals
- Stainless steel pipe clamping bush
- Dielectric pipe clamp cover in PE
- Max temperature 95 °C
- Max operating pressure 1000 kPa



- Press fitting for multilayer pipe - T-shaped - intermediate
- Raccord à presser pour gaz pour tube multicouche - en T - intermédiaire
- Пресс-фитинг для металлопластиковых труб - T образный - промежуточный
- Racord prin presare pentru conductă multistrat - în formă de "T" - intermediar
- Te Press Fitting, para tubo multicapa
- Druckanschluss für Mehrschichtverbundrohr - "T"-Verbindung - Zwischenstück

Code Code Артикул Cod Código Code	Size A Dim. A Pas. A Dimens. A Med.A Abm. A	EURO EURO EURO EURO EURO	Pack Cond. Уп-ка Ambalaj Caja Verp.
677.14.00	14x2	6,71	10
677.16.00	16x2	7,05	10
677.18.00	18x2	7,54	5
677.20.00	20x2	8,05	10
677.26.00	26x3	11,54	5
677.32.00	32x3	15,58	5
677.40.00	40x3,5	26,59	5
677.50.00	50x4	49,81	1
677.63.00	63x4,5	67,33	1

Size A: Outside Ø x pipe thickness

032

- ACS

Press fitting for Tita-fix multilayer pipe.

- Multi-clamp fitting.
 Compatible with clamps series:
 - TH, H, U, B for Ø 14x2;
 - TH, H, U, B, F for Ø 16x2 - 18x2 and 20x2;
 - TH, H, B for Ø 26x3;
 - TH, H for Ø 32x3;
 - TH for Ø 40x3.5 - 50x4 e 63x4.5

- Externally nickel-plated brass body
- EPDM seals
- Stainless steel pipe clamping bush
- Dielectric pipe clamp cover in PE
- Threaded connection F UNI-EN-ISO 228
- Max temperature 95 °C
- Max operating pressure 1000 kPa



- Press fitting for multilayer pipe - T-shaped - central female connection
- Raccord à presser pour tube multicouche - en T - branchement femelle central
- Пресс-фитинг для металлопластиковых труб - T образный - центральная резьба вн.
- Racord prin presare pentru conductă multistrat - în formă de "T" - prindere tip mamă centrală
- Racor Te Press Fitting-Hembra-Press Fitting, para tubo multicapa
- Druckanschluss für Mehrschichtverbundrohr - "T"-Verbindung - mittlerer Aufsteckanschluss

Code Code Артикул Cod Código Code	Size A Dim. A Pas. A Dimens. A Med.A Abm. A	Size B Dim. B Pas. B Dimens. B Med. B Abm. B	EURO EURO EURO EURO EURO	Pack Cond. Уп-ка Ambalaj Caja Verp.
678.14.20	14x2	1/2" F	6,80	10
678.16.20	16x2	1/2" F	6,96	10
678.18.20	18x2	1/2" F	7,96	5
678.18.30	18x2	3/4" F	9,77	5
678.20.20	20x2	1/2" F	8,40	10
678.20.30	20x2	3/4" F	10,12	10
678.26.30	26x3	3/4" F	12,32	5
678.32.30	32x3	3/4" F	15,77	5
678.32.40	32x3	1" F	15,80	5
678.40.40	40x3,5	1" F	21,21	5
678.40.50	40x3,5	1"1/4" F	26,94	5
678.50.40	50x4	1" F	33,66	1

Size A: Outside Ø x pipe thickness

032

- ACS



Press fitting for Tita-fix multilayer pipe.

- Multi-clamp fitting.
 Compatible with clamps series:
 - TH, H, U, B for Ø 14x2;
 - TH, H, U, B, F for Ø 16x2 - 18x2 and 20x2;
 - TH, H, B for Ø 26x3;
 - TH, H for Ø 32x3;
 - TH for Ø 40x3.5 - 50x4 e 63x4.5
- Externally nickel-plated brass body
 - EPDM seals
 - Stainless steel pipe clamping bush
 - Dielectric pipe clamp cover in PE
 - Threaded connection F UNI-EN-ISO 228
 - Max temperature 95 °C
 - Max operating pressure 1000 kPa

- Press fitting for multilayer pipe - T-shaped - lateral gas female connection
- Raccord à presser pour tube multicouche- en T - branchement femelle latéral gaz
- Пресс-фитинг для металлопластиковых труб - T образный - боковая резьба вн.
- Racord prin presare pentru conductă multistrat - în formă de "T" - prindere tip mamă laterală gaz
- Racor Te Press Fitting-Press Fitting-Hembra, para tubo multicapa
- Druckanschluss für Mehrschichtverbundrohr - "T"-Verbindung - gasseitiger Aufsteckanschluss

Code Code Articul Cod Código Code	Size A Dim. A Pas. A Dimens. A Med.A Abm. A	Size B Dim. B Pas. B Dimens. B Med.B Abm. B	EURO EURO EURO EURO EURO EURO	Pack Cond. Уп-ка Ambalaj Caja Verp.
679.14.20	14x2	1/2" F	6,64	10
679.16.20	16x2	1/2" F	6,92	10
679.18.20	18x2	1/2" F	8,42	10
679.18.30	18x2	3/4" F	9,83	10
679.20.20	20x2	1/2" F	8,48	10
679.20.30	20x2	3/4" F	9,91	10
679.26.30	26x3	3/4" F	11,88	5
679.32.40	32x3	1" F	15,60	5

Size A: Outside Ø x pipe thickness

032

- ACS

Press fitting for Tita-fix multilayer pipe.

- Multi-clamp fitting.
 Compatible with clamps series:
 - TH, H, U, B for Ø 14x2;
 - TH, H, U, B, F for Ø 16x2 - 18x2 and 20x2;
 - TH, H, B for Ø 26x3;
 - TH, H for Ø 32x3;
 - TH for Ø 40x3.5 - 50x4 e 63x4.5

- Externally nickel-plated brass body
- EPDM seals
- Stainless steel pipe clamping bush
- Dielectric pipe clamp cover in PE
- Threaded connection M UNI-EN-ISO 228
- Max temperature 95 °C
- Max operating pressure 1000 kPa

- Press fitting for multilayer pipe - T-shaped - central gas male connection
- Raccord à presser pour tube multicouche- en T - branchement mâle centrale gaz
- Пресс-фитинг для металлопластиковых труб- T образный - центральная резьба нар.
- Racord prin presare pentru conductă multistrat - în formă de "T" - prindere tip tată centrală gaz
- Racor Te Press Fitting-Macho-Press Fitting, para tubo multicapa
- Druckanschluss für Mehrschichtverbundrohr - "T"-Verbindung - mittlerer Steckanschluss Gas

Code Code Articul Cod Código Code	Size A Dim. A Pas. A Dimens. A Med.A Abm. A	Size B Dim. B Pas. B Dimens. B Med.B Abm. B	EURO EURO EURO EURO EURO EURO	Pack Cond. Уп-ка Ambalaj Caja Verp.
680.14.20	14x2	1/2" M	6,35	10
680.16.20	16x2	1/2" M	6,90	10
680.18.20	18x2	1/2" M	8,31	10
680.18.30	18x2	3/4" M	9,59	10
680.20.20	20x2	1/2" M	8,40	10
680.20.30	20x2	3/4" M	9,73	10
680.26.30	26x3	3/4" M	11,06	5
680.26.40	26x3	1" M	12,83	5
680.32.30	32x3	3/4" M	13,86	5
680.32.40	32x3	1" M	15,43	5
680.40.40	40x3,5	1" M	21,55	5
680.40.50	40x3,5	1"1/4 M	22,88	5

Size A: Outside Ø x pipe thickness

032

- ACS

Press fitting for Tita-fix multilayer pipe.

- Multi-clamp fitting.
 Compatible with clamps series:
 - TH, H, U, B for Ø 14x2;
 - TH, H, U, B, F for Ø 16x2 - 18x2 and 20x2;
 - TH, H, B for Ø 26x3;
 - TH, H for Ø 32x3;
 - TH for Ø 40x3.5 - 50x4 e 63x4.5

- Externally nickel-plated brass body
- EPDM seals
- Stainless steel pipe clamping bush
- Dielectric pipe clamp cover in PE
- Max temperature 95 °C
- Max operating pressure 1000 kPa

- Press fitting for multilayer pipe - straight - reduced route
- Raccord à presser pour gaz pour tube multicouche- droit - voie réduite
- Пресс-фитинг для металлопластиковых труб- прямой - редуцированный
- Racord cu presare pentru conductă multistrat - drept - canal redus
- Manguito Press Fitting recto reducido, para tubo multicapa
- Druckanschluss für Mehrschichtverbundrohr - gerade - Reduzierstück

Code Code Articul Cod Código Code	Size A Dim. A Pas. A Dimens. A Med.A Abm. A	Size B Dim. B Pas. B Dimens. B Med.B Abm. B	EURO EURO EURO EURO EURO EURO	Pack Cond. Уп-ка Ambalaj Caja Verp.
890.16.00	16x2	14x2	4,18	10
890.18.00	18x2	14x2	5,01	10
890.18.10	18x2	16x2	5,22	10
890.20.10	20x2	16x2	5,43	10
890.20.20	20x2	18x2	5,65	10
890.26.00	26x3	16x2	6,25	10
890.26.10	26x3	18x2	6,51	10
890.26.20	26x3	20x2	6,69	10
890.32.00	32x3	16x2	8,22	5
890.32.10	32x3	20x2	8,59	5
890.32.20	32x3	26x3	9,00	5
890.40.10	40x3,5	32x3	14,67	5
890.50.10	50x4	32x3	15,91	5
890.50.00	50x4	40x3,5	25,25	5
890.63.10	63x4,5	40x3,5	33,33	1
890.63.00	63x4,5	50x4	37,02	1

Size A-B: Outside Ø x pipe thickness

032

- ACS

Press fitting for Tita-fix multilayer pipe.

- Multi-clamp fitting.
 Compatible with clamps series:
 - TH, H, U, B for Ø 14x2;
 - TH, H, U, B, F for Ø 16x2 - 18x2 and 20x2;
 - TH, H, B for Ø 26x3;
 - TH, H for Ø 32x3;
 - TH for Ø 40x3.5 - 50x4 e 63x4.5
- Externally nickel-plated brass body
 - EPDM seals
 - Stainless steel pipe clamping bush
 - Dielectric pipe clamp cover in PE
 - Max temperature 95 °C
 - Max operating pressure 1000 kPa



- Press fitting for multilayer pipe - T-shaped - reduced lateral route
- *Raccord à presser pour tube multicouche - en T - voie réduite latérale*
- *Пресс-фитинг для металлопластиковых труб - T-образный - редуцированный*
- *Racord prin presare pentru conductă multistrat - în formă de "T" - canal redus lateral*
- *Te Press Fitting reducida lateral, para tubo multicapa*
- *Steckanschluss für Mehrschichtverbundrohr - "T"-Verbindung - seitliches Reduzierstück*

Code Code Артикул Cod Código Code	Size A Dim. A Paz. A Dimens. A Med.A Abm. A	Size B Dim. B Paz. B Dimens. B Med. B Abm. B	EURO EURO EURO EURO EURO EURO	Pack Cond. Уп-ка Ambalaj Caja Verp.
851.16.00	16x2	14x2	6,90	10
851.20.10	20x2	16x2	9,12	10
851.26.10	26x3	16x2	11,66	10
851.26.20	26x3	20x2	11,98	10
851.32.10	32x3	16x2	15,44	5
851.32.00	32x3	20x2	17,13	5
851.32.20	32x3	26x3	17,27	5

Size A-B: Outside Ø x pipe thickness

032

- ACS

Press fitting for Tita-fix multilayer pipe.

- Multi-clamp fitting.
 Compatible with clamps series:
 - TH, H, U, B for Ø 14x2;
 - TH, H, U, B, F for Ø 16x2 - 18x2 and 20x2;
 - TH, H, B for Ø 26x3;
 - TH, H for Ø 32x3;
 - TH for Ø 40x3.5 - 50x4 e 63x4.5
- Externally nickel-plated brass body
 - EPDM seals
 - Stainless steel pipe clamping bush
 - Dielectric pipe clamp cover in PE
 - Max temperature 95 °C
 - Max operating pressure 1000 kPa



- Press fitting for multilayer pipe - T-shaped - reduced central route
- *Raccord à presser pour gaz pour tube multicouche - en T - voie réduite centrale*
- *Пресс-фитинг для металлопластиковых труб - T-образный - редуцированный*
- *Racord prin presare pentru conductă multistrat - în formă de "T" - canal redus central*
- *Te Press Fitting reducida central, para tubo multicapa*
- *Steckanschluss für Mehrschichtverbundrohr - "T"-Verbindung - mittleres Reduzierstück*

Code Code Артикул Cod Código Code	Size A Dim. A Paz. A Dimens. A Med.A Abm. A	Size B Dim. B Paz. B Dimens. B Med. B Abm. B	EURO EURO EURO EURO EURO EURO	Pack Cond. Уп-ка Ambalaj Caja Verp.
851.14.00	16x2	14x2	6,88	10
851.14.20	18x2	14x2	9,00	10
851.16.20	18x2	16x2	9,25	10
851.14.50	20x2	14x2	9,00	10
851.16.30	20x2	16x2	9,25	10
851.18.00	20x2	18x2	9,17	5
851.16.60	26x3	16x2	12,04	10
851.18.20	26x3	18x2	12,18	5
851.20.20	26x3	20x2	12,18	5
933.16.00	32x3	16x2	15,35	5
851.18.30	32x3	18x2	15,61	5
851.20.40	32x3	20x2	17,21	5
851.26.00	32x3	26x3	17,35	5
851.40.10	40x3,5	26x3	22,16	5
851.40.00	40x3,5	32x3	23,02	5
851.50.20	50x4	26x3	32,40	1
851.50.00	50x4	40x3,5	36,25	1
851.63.40	63x4,5	26x3	49,60	1
851.63.20	63x4,5	40x3,5	50,58	1

Size A-B: Outside Ø x pipe thickness

032

- ACS

Press fitting for Tita-fix multilayer pipe.

- Multi-clamp fitting.
 Compatible with clamps series:
 - TH, H, U, B for Ø 14x2;
 - TH, H, U, B, F for Ø 16x2 - 18x2 and 20x2;
 - TH, H, B for Ø 26x3;
 - TH, H for Ø 32x3;
 - TH for Ø 40x3.5 - 50x4 e 63x4.5
- Externally nickel-plated brass body
 - EPDM seals
 - Stainless steel pipe clamping bush
 - Dielectric pipe clamp cover in PE
 - Max temperature 95 °C
 - Max operating pressure 1000 kPa



- Press fitting for multilayer pipe - T-shaped - reduced central and lateral route
- *Raccord à presser pour gaz pour tube multicouche - en T - voie réduite centrale et latérale*
- *Пресс-фитинг для металлопластиковых труб - T-образный - редуцированный*
- *Racord prin presare pentru conductă multistrat - în formă de "T" - canal redus central și lateral*
- *Te Press Fitting reducida central y lateral, para tubo multicapa*
- *Steckanschluss für Mehrschichtverbundrohr - "T"-Verbindung - mittleres und seitliches Reduzierstück*

Code Code Артикул Cod Código Code	Size A Dim. A Paz. A Dimens. A Med.A Abm. A	Size B Dim. B Paz. B Dimens. B Med. B Abm. B	EURO EURO EURO EURO EURO EURO	Pack Cond. Уп-ка Ambalaj Caja Verp.
851.14.10	16x2	14x2	6,77	10
851.16.40	18x2	16x2	9,00	10
851.16.10	20x2	16x2	9,00	10
851.18.10	20x2	18x2	9,05	5
851.16.90	26x3	16x2	11,39	5
851.20.70	26x3	20x2	11,93	5
851.20.90	32x3	20x2	17,20	5
851.26.40	32x3	26x3	17,39	5

Size A-B: Outside Ø x pipe thickness

032

- ACS

Press fitting for Tita-fix multilayer pipe.

- Multi-clamp fitting.
 Compatible with clamps series:
 - TH, H, U, B for Ø 14x2;
 - TH, H, U, B, F for Ø 16x2 - 18x2 and 20x2;
 - TH, H, B for Ø 26x3;
 - TH, H for Ø 32x3;
 - TH for Ø 40x3.5 - 50x4 e 63x4.5
- Externally nickel-plated brass body
 - EPDM seals
 - Stainless steel pipe clamping bush
 - Dielectric pipe clamp cover in PE
 - Max temperature 95 °C
 - Max operating pressure 1000 kPa



- Press fitting for multilayer pipe - T-shaped - double reduced lateral route
- Raccord à presser pour tube multicouche - en T - double voie réduite latérale
- Пресс-фитинг для металлопластиковых труб - Т-образный - редуцированный
- Racord prin presare pentru conductă multistrat - în formă de "T" - dublu canal redus lateral
- Te Press Fitting reducida doble lateral, para tubo multicapa
- Steckanschluss für Mehrschichtverbundrohr - "T"-Verbindung - doppeltes seitliches Reduzierstück

Code Code Артикул Cod Código Code	Size A Dim. A Paz. A Dimens. A Med.A Abm. A	Size B Dim. B Paz. B Dimens. B Med.B Abm. B	EURO EURO EURO EURO EURO EURO	Pack Cond. Уп-ка Ambalaj Caja Verp.
851.18.40	18x2	16x2	9,00	5
851.20.00	20x2	16x2	9,00	10
851.26.50	26x3	20x2	11,93	5
851.32.30	32x3	26x3	17,39	5

Size A-B: Outside Ø x pipe thickness

032

- ACS

Press fitting for Tita-fix multilayer pipe.

- Multi-clamp fitting.
 Compatible with clamps series:
 - TH, H, U, B for Ø 14x2;
 - TH, H, U, B, F for Ø 16x2 - 18x2 and 20x2;
 - TH, H, B for Ø 26x3;
 - TH, H for Ø 32x3;
 - TH for Ø 40x3.5 - 50x4 e 63x4.5



- Externally nickel-plated brass body
- EPDM seals
- Stainless steel pipe clamping bush
- Dielectric pipe clamp cover in PE
- Max temperature 95 °C
- Max operating pressure 1000 kPa

- Press fitting for multilayer pipe -T-shaped - triple reduction
- Raccord à presser pour tubemulticouche - en T - triple réduction
- Пресс-фитинг для металлопластиковых труб - Т-образный - редуцированный
- Racord prin presare pentru conductă multistrat - în formă de "T" - reducție triplă
- Te Press Fitting reducida triple, para tubo multicapa
- Steckanschluss für Mehrschichtverbundrohr - "T"-Verbindung - dreifaches Reduzierstück

Code Code Артикул Cod Código Code	Size A Dim. A Paz. A Dimens. A Med.A Abm. A	Size B Dim. B Paz. B Dimens. B Med.B Abm. B	Size C Dim. C Paz. C Dimens. C Med. C Abm. C	EURO EURO EURO EURO EURO EURO	Pack Cond. Уп-ка Ambalaj Caja Verp.
999.20.00	26x3	20x2	16x2	12,51	10

Size A-B-C: Outside Ø x pipe thickness

032

- ACS

Press fitting for Tita-fix multilayer pipe.

- Multi-clamp fitting.
 Compatible with clamps series:
 - TH, H, U, B for Ø 14x2;
 - TH, H, U, B, F for Ø 16x2 - 18x2 and 20x2;
 - TH, H, B for Ø 26x3;
 - TH, H for Ø 32x3;
 - TH for Ø 40x3.5 - 50x4 e 63x4.5



- Externally nickel-plated brass body
- EPDM seals
- Stainless steel pipe clamping bush
- Dielectric pipe clamp cover in PE
- Threaded connection F UNI-EN-ISO 228
- Max temperature 95 °C
- Max operating pressure 1000 kPa

- Press fitting for multilayer pipe - flanged elbow - standard length - F Gas connection
- Raccord à presser pour gaz pour tube multicouche - coudé à bride - longueur standard- branchement F Gaz
- Пресс-фитинг для металлопластиковых труб - фланцевое колено - стандартная длина - резьба вн.
- Racord prin presare pentru conductă multistrat - cu cot prevăzut cu flanșă - lungime standard - prindere tip Mamă gaz
- Racor Press Fitting curvo hembra con base de soporte, para tubo multicapa
- Steckanschluss für Mehrschichtverbundrohr - geflanschter Bogen - Standardlänge - Anschluss F Gas

Code Code Артикул Cod Código Code	Size A Dim. A Paz. A Dimens. A Med.A Abm. A	Size B Dim. B Paz. B Dimens. B Med.B Abm. B	EURO EURO EURO EURO EURO EURO	Pack Cond. Уп-ка Ambalaj Caja Verp.
853.04.00	16x2	1/2" F	7,96	10
853.04.10	20x2	1/2" F	8,10	10

Size A: Outside Ø x pipe thickness

032

- ACS



Fixing on specific Fixing Plate code 934.00.00

Press fitting for Tita-fix multilayer pipe.

- Multi-clamp fitting.
 Compatible with clamps series:
 - TH, H, U, B for Ø 14x2;
 - TH, H, U, B, F for Ø 16x2 - 18x2 and 20x2;
 - TH, H, B for Ø 26x3;
 - TH, H for Ø 32x3;
 - TH for Ø 40x3.5 - 50x4 e 63x4.5
- Externally nickel-plated brass body
 - EPDM seals
 - Stainless steel pipe clamping bush
 - Dielectric pipe clamp cover in PE
 - Threaded connection F UNI-EN-ISO 228
 - Max temperature 95 °C
 - Max operating pressure 1000 kPa



- Press fitting for multilayer pipe - flanged elbow - XL length 77 mm - F Gas connection
- Raccord à presser pour gaz pour tube multicouche - coudé à bride - longueur XL 77 mm - branchement F Gaz
- Пресс-фитинг для металлопластиковых труб - фланцевое колено - стандартная длина - резьба вн.
- Racord prin presare pentru conductă multistrat - cu cot prevăzut cu flanșă - lungime XL 77 mm - prindere tip Mamă gaz
- Racor Press Fitting curvo hembra con base de soporte, para tubo multicapa
- Steckanschluss für Mehrschichtverbundrohr - geflanschter Bogen - länge XL 77 mm - Anschluss F Gas

Code Code Артикул Cod Código Code	Size A Dim. A Раз. A Dimens. A Med.A Abm. A	Size B Dim. B Раз. B Dimens. B Med. B Abm. B	EURO EURO EURO EURO EURO	Pack Cond. Уп-ка Ambalaj Caja Verp.
853.04.90	16x2	1/2" F	9,30	10

Size A: Outside Ø x pipe thickness



Fixing on specific Fixing Plate code 934.00.00

032

Press fitting for Tita-fix multilayer pipe.

- Multi-clamp fitting.
 Compatible with clamps series:
 - TH, H, U, B for Ø 14x2;
 - TH, H, U, B, F for Ø 16x2 - 18x2 and 20x2;
 - TH, H, B for Ø 26x3;
 - TH, H for Ø 32x3;
 - TH for Ø 40x3.5 - 50x4 e 63x4.5
- Externally nickel-plated brass body
 - EPDM seals
 - Stainless steel pipe clamping bush
 - Dielectric pipe clamp cover in PE
 - Threaded connection F UNI-EN-ISO 228
 - Max temperature 95 °C
 - Max operating pressure 1000 kPa



- Press fitting for multilayer pipe - flanged - F gas connection
- Raccord à presser pour gaz pour tube multicouche - à bride - branchement F Gaz
- Пресс-фитинг для металлопластиковых труб - фланцевый - резьба вн.
- Racord prin presare pentru conductă multistrat - cu flanșă - prindere tip Mamă gaz
- Racor Press Fitting recto hembra con base de soporte, para tubo multicapa
- Steckanschluss für Mehrschichtverbundrohr - geflanscht - Anschluss F Gas

Code Code Артикул Cod Código Code	Size A Dim. A Раз. A Dimens. A Med.A Abm. A	Size B Dim. B Раз. B Dimens. B Med. B Abm. B	EURO EURO EURO EURO EURO	Pack Cond. Уп-ка Ambalaj Caja Verp.
852.04.00	16x2	1/2" F	10,71	10
852.04.30	20x2	1/2" F	10,85	5

Size A: Outside Ø x pipe thickness



Fixing on specific Fixing Plate code 934.00.00

032

Flanged fittings fixing plate.

- Galvanised steel material
 - Flanged fitting application with prefixed centre distance of 80-100-120-160 mm
 - Possibility of choosing bracket attachments at only centre distance 80 mm



- Fixing plate
- Plaque de fixation
- Крепежная пластина
- Placă de fixare
- Placa de montaje para racor con base de soporte
- Befestigungsplatte

Code Code Артикул Cod Código Code	EURO EURO EURO EURO EURO	Pack Cond. Уп-ка Ambalaj Caja Verp.
934.00.00	2,96	1

032

Fixing and positioning bracket.

- Galvanised steel material
 - Complete with fixing nut



- Fixing bracket
- Étrier de fixation
- Монтажная планка
- Bridă de fixare
- Soporte de fijación y posicionamiento
- Befestigungsbügel

Code Code Артикул Cod Código Code	EURO EURO EURO EURO EURO	Pack Cond. Уп-ка Ambalaj Caja Verp.
934.00.50	7,88	1



Plate bracket code 934.00.00

032



Brackets with press fitting for Tita-fix multilayer pipe.

- Multi-clamp fitting.
 Compatible with clamps series:
 - TH, H, U, B for Ø 14x2;
 - TH, H, U, B, F for Ø 16x2 - 18x2 and 20x2;
 - TH, H, B for Ø 26x3;
 - TH, H for Ø 32x3;
 - TH for Ø 40x3.5 - 50x4 e 63x4.5
- Nickel-plated brass body
 - EPDM seals
 - Stainless steel pipe clamping bush
 - Dielectric pipe clamp cover in PE
 - Threaded connection F UNI-EN ISO 228
 - Galvanised steel bracket
 - Fittings applied at prefixed interest
 - Fittings free to rotate
 - Connection G 1/2" F



- Brackets with press fittings for multilayer pipe
- Étriers pour raccords à presser pour tube multicouche
- Хомуты с пресс-фитингами для металлопластиковых труб
- Bride cu racorduri prin presare pentru conductă multistrat
- Soporte de fijación con par de racores Press Fitting curvo hembra con base de soporte, para tubo multicapa
- Bügel mit Steckanschlüsse für Mehrschichtverbundrohr

Code Code Articul Cod Codigo Code	Size A Dim. A Pas. A Dimens. A Med. A Abm. A	Centre distance mm Entraxe mm Межосевое расстояние мм Distanță interaxială mm Entre-ejes mm Weite mm	EURO EURO EURO EURO EURO EURO	Pack Cond. Уп-ка Ambalaj Caja Verp.
1253.04.00	16x2	80	19,38	5
1253.04.10	16x2	160	19,38	5
1253.04.50	20x2	160	22,72	5

Size A: Outside Ø x pipe thickness

032

- ACS

built-in stop cock with chrome plated cap and press fittings for Tita-fix multilayer pipe.

- Multi-clamp fitting.
 Compatible with clamps series:
 - TH, H, U, B for Ø 14x2;
 - TH, H, U, B, F for Ø 16x2 - 18x2 and 20x2;
 - TH, H, B for Ø 26x3;
 - TH, H for Ø 32x3;
 - TH for Ø 40x3.5 - 50x4 e 63x4.5
- Brass body
 - Chrome plated cap and manoeuvre knob
 - Seals in nitrile - EPDM
 - Press connections with dielectric cover in PE and stainless steel pipe clamping bush
 - Max temperature 95 °C
 - Max operating pressure 1000 kPa



- built-in stop cock with chrome plated cap and press fittings for multilayer pipe
- Robinet d'arrêt encastrable capuchon chromé et raccords à presser pour tube multicouche
- Встриваемый шаровый кран с хромированным копкаком и пресс-фитингами для металлопластиковых труб
- Robinet de oprire de încastrat cu capișon cromat și racorduri prin presare pentru conductă multistrat
- Llave de asiento Press Fitting empotrable con volante y florón cromados, para tubo multicapa
- Einbausperrhahn mit verchromter Kappe und Steckanschlüsse für Mehrschichtverbundrohr

Code Code Articul Cod Codigo Code	Size Dim. Pas. Dimensiune Med. Abm.	EURO EURO EURO EURO EURO EURO	Pack Cond. Уп-ка Ambalaj Caja Verp.
20.04.10	1/2" - 16x2	27,38	5
20.05.10	3/4" - 20x2	38,16	3
20.05.20*	3/4" - 26x3	42,67	3

*Fitting supplied disassembled

032



For spacer fitting extensions, see the spare parts pricelist.

**RBM
PRESS FITTING
“TITA-FIX”:**
*Best quality
guaranteed!*

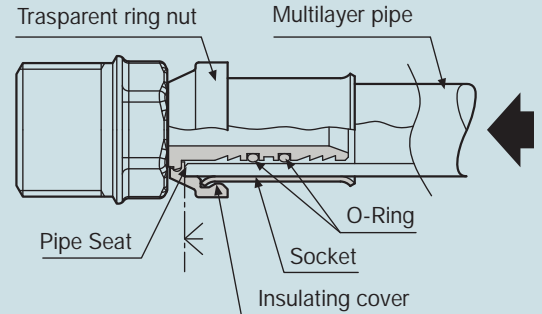

Double O-Ring seal

Every fitting is equipped with 2 O-Rings: perfect tightness during the time!

Pipe socket made in Stainless Steel

Stainless steel gives an higher system rigidity than aluminium. Furthermore, being stainless steel resistant to corrosion, it is possible to use RBM fitting “laid underfloor or wall”, too.



Transparent plastic ring nut

Transparent plastic ring nut allows to verify correct pipe positioning into the fitting. Produced in one piece only (without hole), therefore resistant to possible strikes.

“Anti pull-out” system

Specific fishbone shape of fitting body allows an higher grip to the pipe, avoiding pull-out of the pipe in the compression action.

PERFECT COMPRESSION system

Ring nut finds the perfect seat in the TH series plier (recommended series). This makes the compression easier, ensuring that the fitting will not move.



Exact position of the press-fitting (profile TH plier).

Multiplier press-fittings

RBM press fittings can be used with different plier profiles:

- TH, H, U, B \varnothing 14x2;
- TH, H, U, B, F \varnothing 16x2, 18x2 e 20x2;
- TH, H, B \varnothing 26x3;
- TH, H \varnothing 32x3;
- TH \varnothing 40x3,5, 50x4 e 63x4,5.

Compression of press-fitting for gas fuel system must be done exclusively with TH profile plier!

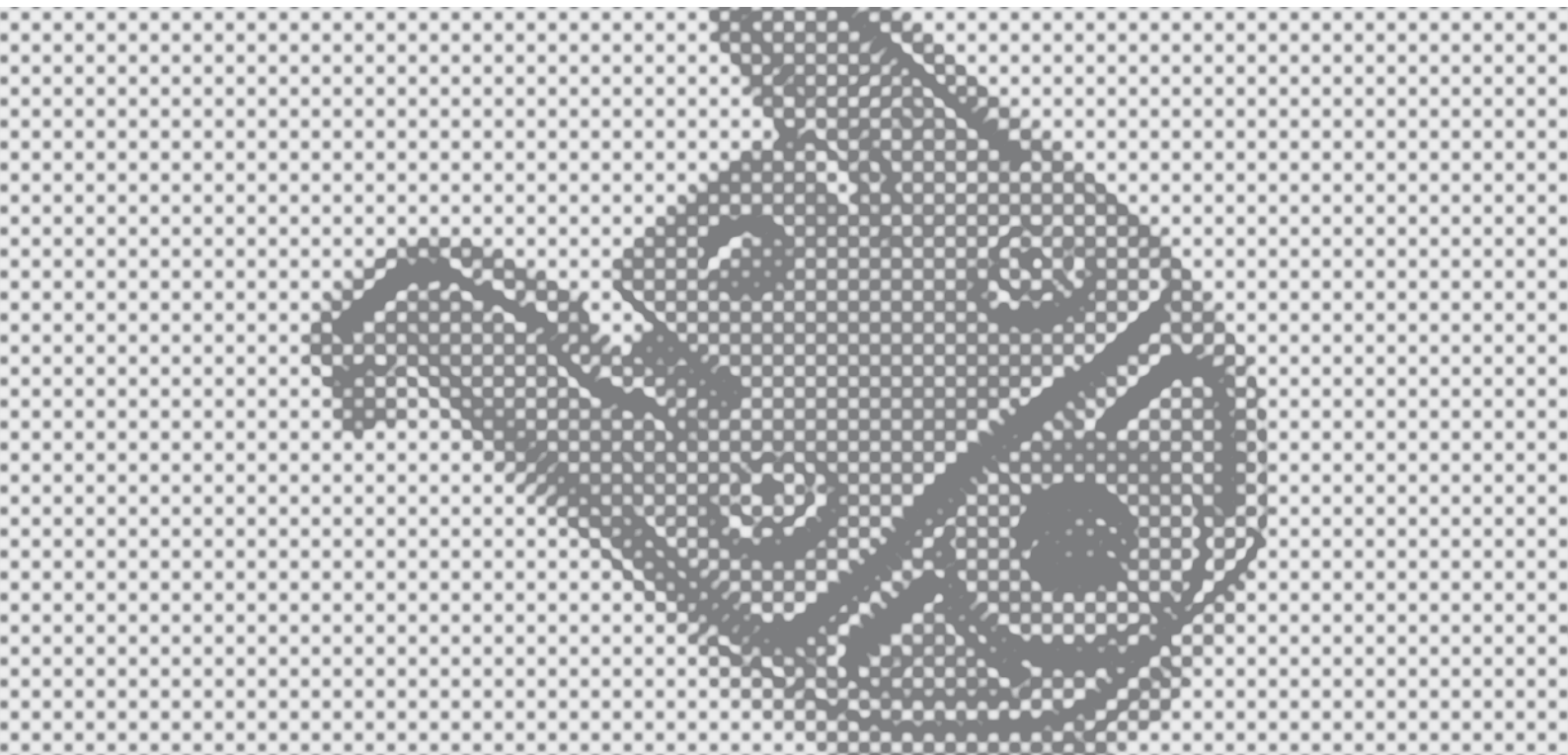



Tita-fix 

 **EQUIPMENT AND TOOLS FOR MULTILAYER SYSTEM**

A  Equipment and tools for multilayer system

 *ÉQUIPEMENTS ET OUTILS POUR SYSTÈME MULTICOUCHE*

 *ОБОРУДОВАНИЕ И ИНСТРУМЕНТЫ ДЛЯ МОНТАЖА СИСТЕМ ИЗ МЕТАЛЛОПЛАСТИКОВЫХ ТРУБ*

 *ECHIPAMENTE ȘI INSTRUMENTE PENTRU SISTEM MULTISTRAT*

 *ACCESORIOS Y HERRAMIENTAS PARA SISTEMA MULTICAPA*

 *AUSRÜSTUNGEN UND WERKZEUGE FÜR MEHRSCICHTSYSTEME*

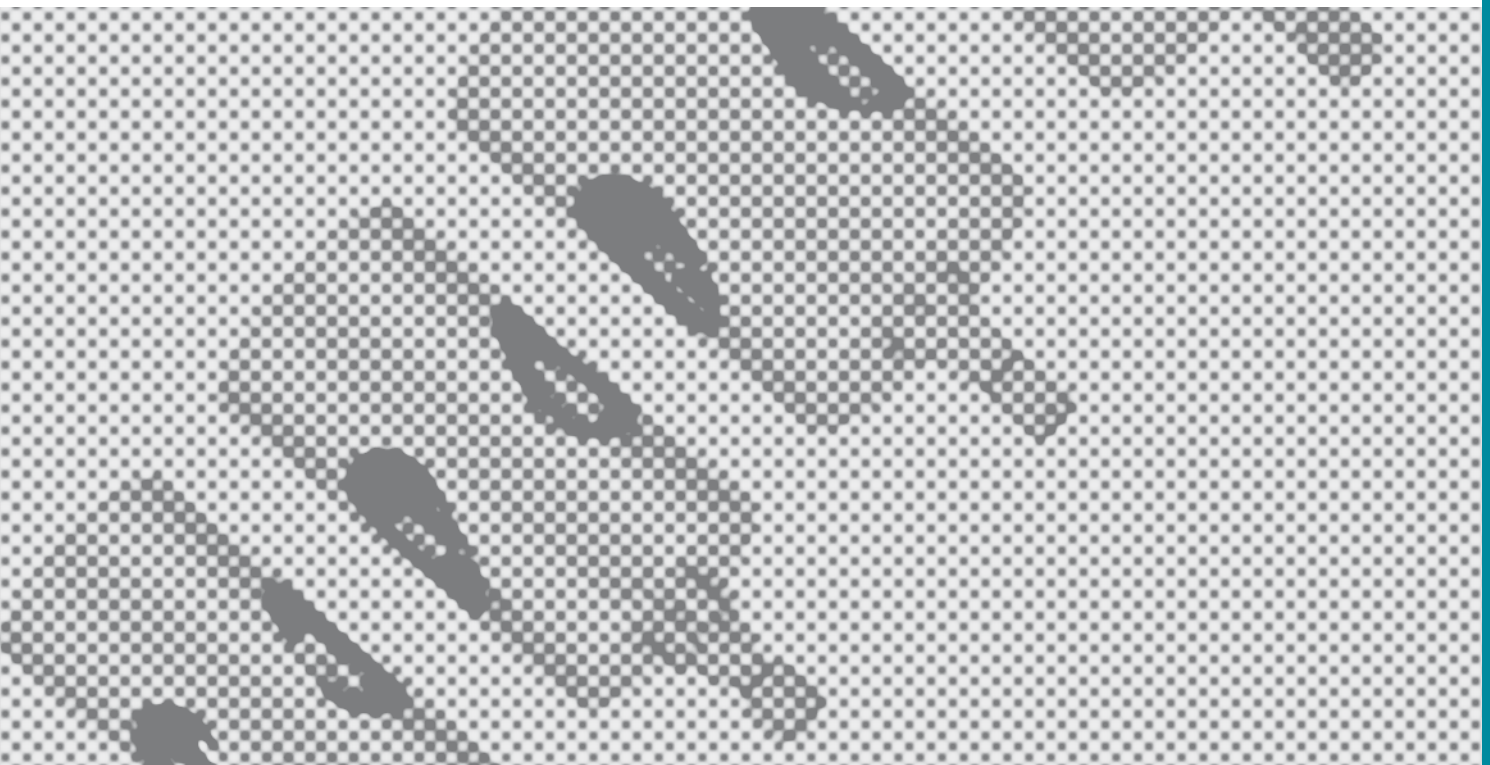

A

Manual shears.

Suitable for pipes in PE, PB, PP, PVC, PVDF.

- Manual shears
- Cisaille manuelle*
- Труборез
- Foarfece manuale*
- Tijera cortatubos manual*
- Handscher*

Code Code Артикул Cod Código Code	Model Modèle Модель Modelul Modelo Modell	For pipe Ø Pour tube Ø Для трубы Ø Pentru conductă Ø Para tubo Ø Für Rohr Ø	EURO EURO EURO EURO EURO EURO	Pack Cond. Уп-ка Ambalaj Caja Verp.
553.00.42	CS 6/35 RV	6÷35	122,51	1
553.00.52	CS 6/42 RV	6÷42	244,93	1

055

Manual pipe cutter.

Suitable for multiplayer, PVC and copper pipe. Complete with deburring tool.

- Manual pipe cutter
- Coupeuse de tubes manuelle*
- Ручной труборез
- Instrument tăiere conducte manual*
- Rodina cortatubos manual*
- Handrohrschneider*

Code Code Артикул Cod Código Code	Model Modèle Модель Modelul Modelo Modell	For pipe Ø Pour tube Ø Для трубы Ø Pentru conductă Ø Para tubo Ø Für Rohr Ø	EURO EURO EURO EURO EURO EURO	Pack Cond. Уп-ка Ambalaj Caja Verp.
553.00.62	TG 67S	6÷67	197,85	1
553.00.72	TG 32	6÷32	94,26	1

055

Manual shears.

Suitable for a precise and quick cut.

- Manual shears
- Cisaille manuelle*
- Труборез
- Foarfece manuale*
- Tijera cortatubos manual*
- Handscher*

Code Code Артикул Cod Código Code	Model Modèle Модель Modelul Modelo Modell	For pipe Ø Pour tube Ø Для трубы Ø Pentru conductă Ø Para tubo Ø Für Rohr Ø	EURO EURO EURO EURO EURO EURO	Pack Cond. Уп-ка Ambalaj Caja Verp.
2179.00.02	-	6÷26	188,09	1

055

Manual pipe bender spring for multi-layer pipe.

Prevents crushing pipe during bending operation

- Manual pipe bender spring
- Ressort cintreuse manuelle*
- Ручной гидравлический трубогиб
- Resort curbare conducte manual*
- Muelle curvabudo manual*
- Manuelle Rohrbögenfeder*

Code Code Артикул Cod Código Code	Size Dim. Paz. Dimensiune Med. Abm.	EURO EURO EURO EURO EURO EURO	Pack Cond. Уп-ка Ambalaj Caja Verp.
1875.14.02	Ø14	55,28	1
1875.16.02	Ø16	55,28	1
1875.18.02	Ø18	55,28	1
1875.20.02	Ø20	55,28	1
1875.26.02	Ø26	97,70	1

Size: Pipe outside Ø



Its use is recommended to correctly perform bending operation.

055

Hydraulic pipe bending kit, for multi-layer pipe.

Prevents crushing pipe during bending operation.

Supply includes:

- Manual hydraulic pump;
- Shockproof containment and carrying case;
- Aluminium pipe bending templates suitable for pipes with outside diameter 14-16-18-20-26-32;
- Quick coupling aluminium counter templates.

- Hydraulic pipe bender
- Cintreuse de tubes hydraulique*
- Гидравлический трубогиб
- Dispozitiv de curbare conductă hidraulic*
- Curvadora de tubos hidráulica manual a ballesta*
- Hydraulische Rohrbögen*

Code Code Артикул Cod Código Code	Model Modèle Модель Modelul Modelo Modell	EURO EURO EURO EURO EURO EURO	Pack Cond. Уп-ка Ambalaj Caja Verp.
553.00.32	0B/85S	1510,59	1

055



Its use is recommended to correctly perform bending operation.



Wireless screwdriver drill.

Set includes:
 - n°1 wireless drill
 - n°2 batteries, 14.4V 1.5 Ah
 - n°1 battery charger for screwdriver drill
 - n°1 case containing entire screwdriver drill set

- Wireless screwdriver drill
- *Perceuse visseuse sans fil*
- *Беспроводная дрель*
- *Tarod mecanism de înşurubat fără fire*
- *Taladro-atornillador a batería*
- *Drahtloser Elektroschrauber*

Code Code Артикул Cod Código Code	EURO EURO EURO EURO EURO	Pack Cond. Уп-ка Ambalaj Caja Verp.
1165.00.02	379,76	1

055



Knob for gauging-flaring tools.

Knob for manual use of flaring tool suitable for flaring RBM multilayer pipes.

- Knob for gauging-flaring tools
- *Poignée pour outils de calibrage-fraises coniques*
- *Ручка для калибровки*
- *Manetă pentru ustensile de calibrare – teşitoare*
- *Mango para Calibrador-Desbarbador interno*
- *Regler für Kalibrierungswerkzeuge - Profilsenker*

Code Code Артикул Cod Código Code	EURO EURO EURO EURO EURO	Pack Cond. Уп-ка Ambalaj Caja Verp.
2007.00.02	39,52	1

055



For RBM Tita-gas and Tita-fix multilayer pipes.

Gauging-flaring tools for multilayer pipe.

Eliminates internal and external burrs and gauges the inside diameter of the pipe at the cutting zone.
 Prearranged for manual use with specific knob and for use with screwdriver drill.

- Gauging - Flaring tools
- *Outils de calibrage - Fraises coniques*
- *Насадки для калибровки металлопластиковых труб*
- *Ustensile de Calibrare – Teşitoare*
- *Calibrador-Desbarbador interno para taladro-atornillador y Mango*
- *Kalibrierungswerkzeuge - Profilsenker*



Code Code Артикул Cod Código Code	Size Dim. Pas. Dimensiune Med. Abm.	EURO EURO EURO EURO EURO	Pack Cond. Уп-ка Ambalaj Caja Verp.
2006.14.02	Ø14x2	37,15	1
2006.16.02	Ø16x2	37,88	1
2006.18.02	Ø18x2	39,30	1
2006.20.02	Ø20x2	41,52	1
2006.26.02	Ø26x3	50,16	1
2006.32.02	Ø32x3	63,12	1
2006.40.02	Ø40x3,5	91,47	1
2006.50.02	Ø50x4	145,06	1
2006.63.02	Ø63x4,5	250,09	1

Size: Outside Ø x pipe thickness.

055



For RBM Tita-gas and Tita-fix multilayer pipes.

Complete set of gauging-flaring tools for multilayer pipe.

Case containing gauging and flaring tools, sizes Ø 16 - 20 - 26 - 32 with specific knob for manual tool used.

- Gauging - Flaring Tools Set
- *Jeu Outils de calibrage - Fraises coniques*
- *Насадки для калибровки металлопластиковых труб*
- *Set Ustensile de Calibrare – Teşitoare*
- *Set completo Calibrador-Desbarbador*
- *Bausatz Kalibrierungswerkzeuge - Profilsenker*



Code Code Артикул Cod Código Code	Size Dim. Pas. Dimensiune Med. Abm.	EURO EURO EURO EURO EURO	Pack Cond. Уп-ка Ambalaj Caja Verp.
2008.00.02	Ø16 - 20 - 26 - 32	248,25	1

Size: Pipe outside Ø.

055



For RBM Tita-gas and Tita-fix multilayer pipes.

Electric press for press fittings.

Electric mains power supply.
 Supply complete with shockproof containment and carry case.

- Power supply 230VAC
- Absorptive power 400W
- Weight in use 4.4Kg
- Sound emissions 82Db
- Dimensions 430x110x85 mm



- Portale electric press
- Presse électrique portative
- Электрический переносной пресс
- Dispozitiv presor electric portabil
- Prensa hidráulica electroportatil para racores Press Fitting
- Tragbare elektrische Rohrdruckpresse

Code Code Артикул Cod Código Code	EURO EURO EURO EURO EURO EURO	Pack Cond. Уп-ка Ambalaj Caja Verp.
553.00.12	3377,25	1



055

Wireless press for press fitting.

Rechargeable battery power supply.
 Supply complete with shockproof containment and carry case.

- Battery 14V 2Ah
- Weight in use 4.5Kg
- Sound emissions 73Db
- Dimensions 338x290x85 mm



- Portale wireless press
- Presse sans fil portative
- Переносной беспроводной пресс
- Dispozitiv presor fără fire portabil
- Prensa hidráulica a batería para racores Press Fitting
- Tragbare drahtlose Rohrdruckpresse

Code Code Артикул Cod Código Code	EURO EURO EURO EURO EURO EURO	Pack Cond. Уп-ка Ambalaj Caja Verp.
553.00.02	2948,65	1



055

Series TH clamps for press fittings.

Suitable for RBM press code 553.00.X2



- Series TH clamps for press fittings
- Pinces série TH pour raccords à presser
- Клеши серии TH для пресс-фитингов
- Cleme seria TH pentru racorduri cu presare
- Mordaza estándar serie TH para racores Press Fitting
- Zangen Baureihe TH für zu pressende Verbindungsteile

Code Code Артикул Cod Código Code	Size Dim. Раз. Dimensione Med. Abm.	Series Série Серия Seria Serie Baureihe	EURO EURO EURO EURO EURO EURO	Pack Cond. Уп-ка Ambalaj Caja Verp.
681.14.02	Ø14	TH	369,39	1
681.16.02	Ø16	TH	369,39	1
681.18.02	Ø18	TH	369,39	1
681.20.02	Ø20	TH	369,39	1
681.26.02	Ø26	TH	369,39	1
681.32.02	Ø32	TH	473,17	1
681.40.02	Ø40	TH	473,17	1
681.50.02	Ø50	TH	799,13	1
681.63.02	Ø63	TH	1233,01	1

Size: Pipe outside Ø.

055

Wireless press for press fitting.

Rechargeable battery power supply.
 Supply complete with shockproof containment and carry case.

Press supply: Mother clamp and inserts for pipe with outside diameter 16-20-26

- Battery 9.6V
- Autonomy 65 clampings
- Weight in use 2.5Kg



- Portale wireless press
- Presse sans fil portative
- Переносной беспроводной пресс
- Dispozitiv presor fără fire portabil
- Prensa hidráulica compacta a batería para racores Press Fitting
- Tragbare drahtlose Rohrdruckpresse

Code Code Артикул Cod Código Code	EURO EURO EURO EURO EURO EURO	Pack Cond. Уп-ка Ambalaj Caja Verp.
1338.00.02	5025,59	1

- Spare battery
- Batterie de rechange
- Запасной аккумулятор
- Baterie de rezervă
- Batería de recambio
- Auswechselfatterie

Code Code Артикул Cod Código Code	EURO EURO EURO EURO EURO EURO	Pack Cond. Уп-ка Ambalaj Caja Verp.
1496.00.02	454,07	1









055

Clamp and interchangeable inserts for press fittings.

Suitable for RBM press code 1338.00.02



-  Clamp and interchangeable inserts
-  *Pince et inserts interchangeables*
-  *Клещи и вставки заменяемые*
-  *Clemă și plăcuțe distanțiere interschimbabile*
-  *Mordaza y casquillos intercambiables para prensa hidráulica compacta*
-  *Zange und auswechselbare Einsätze*

Code Code Артикул Cod Código Code	Size Dim. Pas. Dimensiune Med. Abm.	Fig. Fig. Рис. Fig. Fig. Abb.	EURO EURO EURO EURO EURO EURO	Pack Cond. Уп-ка Ambalaj Caja Verp.
1339.00.02		1	864,49	1
1340.14.02	Ø14	2	184,65	1
1340.16.02	Ø16	2	184,65	1
1340.18.02	Ø18	2	184,65	1
1340.20.02	Ø20	2	184,65	1
1340.26.02	Ø26	2	184,65	1
1340.32.02	Ø32	2	184,65	1







Size: Pipe outside Ø.

055

Spanner for fitting with Standard RBM thread.

Square 1/2" connection, for combination or torque wrenches, to easily tighten fitting in any position.



-  Spanner for Standard RBM fitting.
-  *Clé pour raccord standard RBM*
-  *Ключ для обжимных фитингов с резьбой стандарта RBM*
-  *Cheie pentru racord Standard RBM*
-  *Llave hexagonal abierta para adaptadores Standard RBM*
-  *Schlüssel für Standardanschluss RBM*







Code Code Артикул Cod Código Code	Size Dim. Pas. Dimensiune Med. Abm.	EURO EURO EURO EURO EURO EURO	Pack Cond. Уп-ка Ambalaj Caja Verp.
69.00.00	Ch 28	-	10

041

Spanner for fitting with Euroconus thread.

Square 1/2" connection, for combination or torque wrenches, to easily tighten fitting in any position.



-  Spanner for Euroconus fitting.
-  *Clé pour raccord Euroconus*
-  *Ключ для обжимных фитингов с резьбой стандарта EURO-CONUS*
-  *Cheie pentru racord Euroconus*
-  *Llave hexagonal abierta para adaptadores Euroconus*
-  *Schlüssel für Euroconus-Anschluss*

Code Code Артикул Cod Código Code	Size Dim. Pas. Dimensiune Med. Abm.	EURO EURO EURO EURO EURO EURO	Pack Cond. Уп-ка Ambalaj Caja Verp.
246.00.00	Ch 30	-	10

041