

[www.lavita21.com](http://www.lavita21.com)  
[www.lavita-russia.ru](http://www.lavita-russia.ru)

 **LAVITA**



# LAVITA. Стремление к лучшему качеству

ЛАТУННЫЕ ШАРОВЫЕ КЛАПАНЫ LAVITA

- Высокое качество
- Контроль качества
- Застрахован PL (ответственность за качество продукции)
- Сертификат ГОСТ-Р

# Шаровые краны Lavita

Шаровые краны Lavita - это качество, сочетающее высокие технологии современного оборудования и сервис по обслуживанию потребителей.



## Полнопроходные клапаны

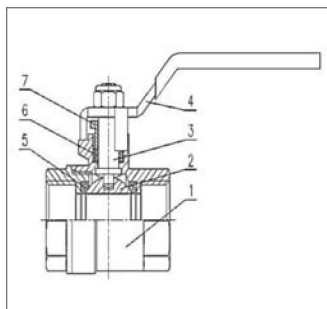

## Материал

1	Корпус	Латунь никелированная С3771
2	Шар	Латунь хромированная С3604/С3771
3	Шток	Латунь С3604
4	Рукоятка	Стальная рукоятка с пластиковым покрытием
		Алюминиевая рукоятка
5	Кольца седельные	PTFE
6	Уплотнение	PTFE
7	Гайка сальниковая	Латунь
8	Ремонтопригодность	Ремонтопригодны

## Спецификация

Номинальное давление	Размеры	Рабочая температура	Применение
мПа	А	°C	
2.5	15А - 50А(1/2 - 2)	от -20°C до 120°C	Вода, Масла, Газ

## Шаровые краны

КРАН ШАРОВОЙ FxFL

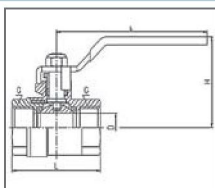

DN	D	L	H	L'
1/2	14	47.5	44	80
3/4	19	55.5	49	90
1	24	64.5	55	100
1 1/4	31.5	78	59.5	108
1 1/2	39.5	87	70	125
2	49.5	101.5	82	150

КРАН ШАРОВОЙ MxFL

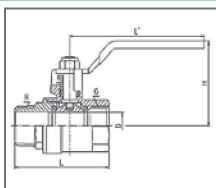

DN	D	L	H	L'
1/2	14	56.5	44	80
3/4	19	62	49	90
1	24	71.5	55	100
1 1/4	31.5	91	59.5	108
1 1/2	39.5	100	70	125
2	49.5	115	82	150

КРАН ШАРОВОЙ FxFB

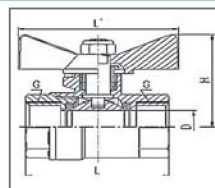

DN	D	L	H	L'
1/2	14	47.5	40	53
3/4	19	55.5	43.5	53
1	24	64.5	53.5	68

КРАН ШАРОВОЙ MxFB

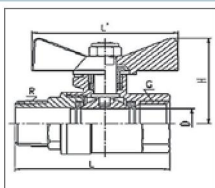

DN	D	L	H	L'
1/2	14	56.5	40	53
3/4	19	62	43.5	53
1	24	71.5	53.5	68

КРАН ШАРОВОЙ MxMB

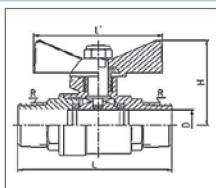

DN	D	L	H	L'
1/2	14	63.5	40	53

КРАН ШАРОВОЙ, ТРЕХХОДОВОЙ

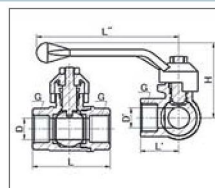

DN	D	L	H	D'	L'
1/2	15	54.5	53	14	27
3/4	20	61	56	18	31
1	25	72	59.5	22	36.5

## Радиаторные клапаны

КРАН ШАРОВОЙ С ПОЛУСГОНОМ FxMCSB

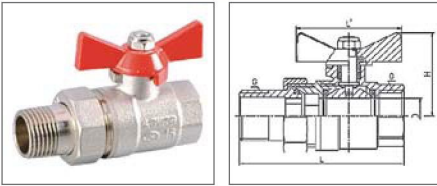

DN	D	L	H	L'
1/2	14	74.5	40	53
3/4	19	82.5	43.5	53
1	24	97	53.5	68

КРАН ШАРОВОЙ УГЛОВОЙ С ПОЛУСГОНОМ AxFCB

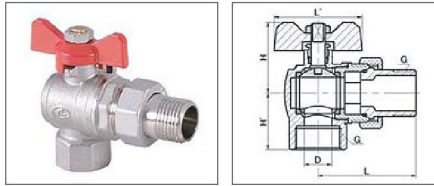

DN	D	L	H	L'	H'
1/2	13.5	56.5	38	51.5	31
3/4	15.5	56.5	40.5	51.5	31
1	20	66	51	64.5	38.5

КЛАПАН ПРЯМОЙ FxMCP

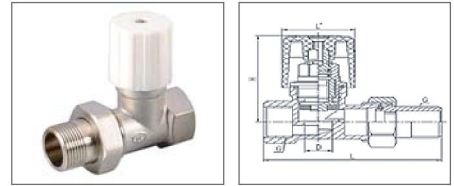

DN	D	L	H	L'
1/2	12	76.5	58	31.5
3/4	16	85.5	63	35.5

КЛАПАН УГЛОВОЙ ACP

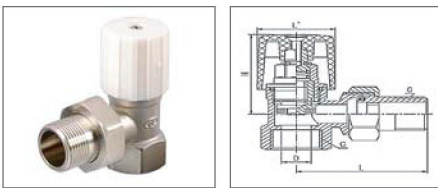

DN	D	L	H	L'
1/2	12	53	50	31.5
3/4	16	58.5	53	35.5

КЛАПАН УГЛОВОЙ С ТЕРМОГОЛОВКОЙ AxTCP

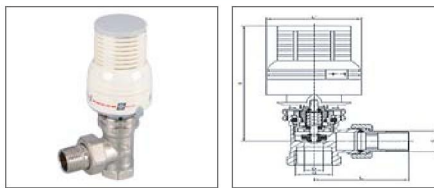

DN	D	L	H	L'
1/2	11	52	113.5	52
3/4	11	60.5	114.5	52

КЛАПАН ПРЯМОЙ С ТЕРМОГОЛОВКОЙ MxTCP

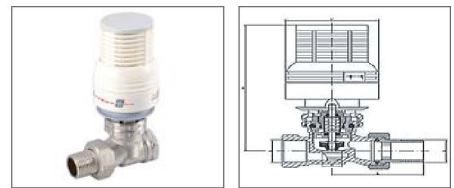

DN	D	L	H	L'
1/2	11	51	115.5	52
3/4	11	57.5	116.5	52

КЛАПАН НАСТРОЕЧНЫЙ УГЛОВОЙ ACS

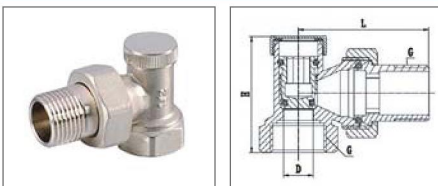

DN	D	L	H
1/2	11	48.5	43.5
3/4	11	56.5	45

КЛАПАН НАСТРОЕЧНЫЙ ПРЯМОЙ FxMCS

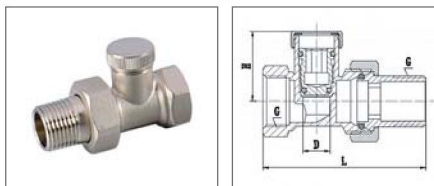

DN	D	L	H
1/2	11	66.5	29
3/4	11	76.5	28.5

Краны для металлопластиковой трубы

PxPL

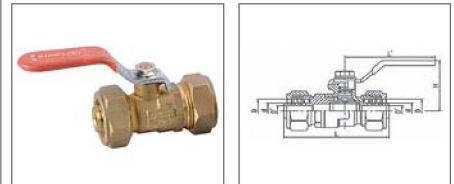

Model	d	L	H	L'
16	11.2	65	36.5	56
20	14.7	64.5	36.5	56

## Краны для гибкой гофрированной трубы

PxFL(C)

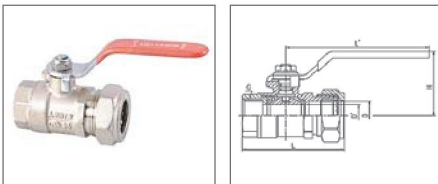

Model	D	L	H	L'
15A	14	59	40.5	80
20A	18	69.5	44.5	90

PxML(C)

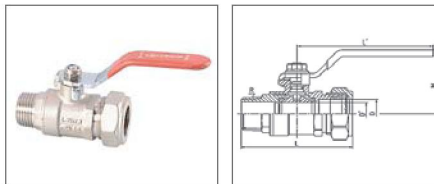

Model	D	L	H	L'
15A	14	67.5	40.5	80
20A	18	78	44.5	90

PxFL

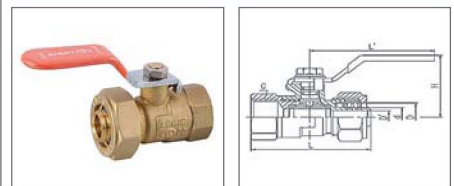

Model	d	L	H	L'
16	11.2	53.5	36.5	56
20	14.7	54.5	36.5	56

КРАН ШАРОВОЙ С ПОЛУСГОНОМ ДЛЯ ГОФРИРОВАННОЙ ТРУБЫ

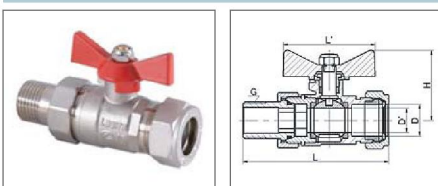

Model	D	D'	L	H	L'
15A	18.1	14	86.5	39	53
20A	25.9	19	95.5	42	53

КРАН ШАРОВОЙ ДЛЯ ГАЗА

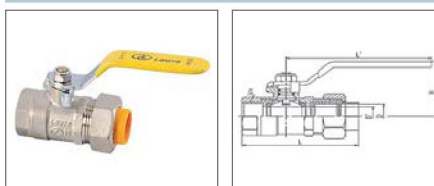

Model	D	L	H	L'
15A	14	64.5	40.5	80
20A	18	72	44.5	90

PxML

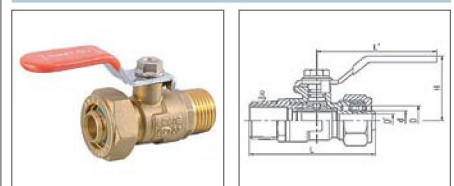

Model	d	L	H	L'
16	11.2	59	36.5	56
20	14.7	59.5	36.5	56

## Прочая запорная арматура

Check valve : латунь/никелевое покрытие

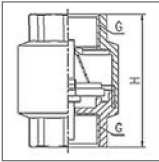

DN	H
1/2	45.5
3/4	49.5
1"	56.5

КЛАПАН ОБРАТНЫЙ ПРУЖИННЫЙ МУФТОВЫЙ.

Вариант "А" КЛАПАН ОБРАТНЫЙ ПРУЖИННЫЙ МУФТОВЫЙ С ЛАТУННЫМ ЗАТВОРОМ.

Вариант "В" КЛАПАН ОБРАТНЫЙ ПРУЖИННЫЙ МУФТОВЫЙ С ПЛАСТИКОВЫМ ЗАТВОРОМ.

## Фильтр грубой очистки косоу муфтовый

Y Filter : латунь/никелевое покрытие

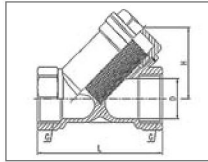

DN	D	L	H
1/2	16	54	32
3/4	21	67.5	37.5
1	26	78	42.5

## Предохранительный клапан

Safety valve - 3

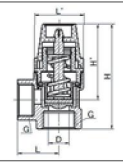

DN	D	L	H	L'	H'
1/2	13	25.5	65.5	30.5	47.5

## Шаровые краны эконом-класса

FxPB ECO

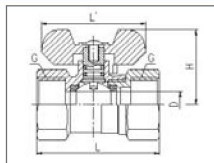

DN	D'	L	H	L'
1/2	10	47.5	29.5	40.5

MxPB ECO

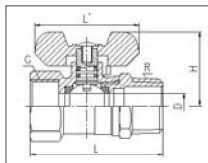

DN	D'	L	H	L'
1/2	10	51.5	29.5	40.5

## Кран шаровой со встроенным фильтром

FFB with filter

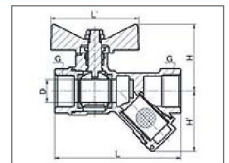

DN	D	L	H	L'	H'
1/2	14	76	41	53	36.5

## Редукторы давления

Reducing valve - A1

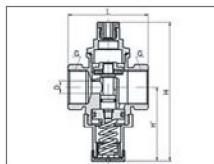

DN	D	L	H	H'	G
1/2	8.5	60	104.5	55.5	1/2
3/4	9	60	105	55.5	3/4

Reducing valve - L1

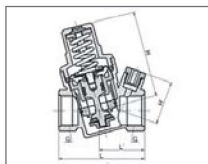

DN	L	H	L'	H'	G
1/2	70	72.5	36.5	32.5	1/2
3/4	71	72	67.5	35.5	3/4

FFL with filter

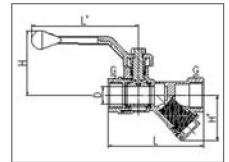

DN	D	L	H	L'	H'
1/2	14	76	41	85	37
3/4	17	91	53	85	45

## Краны специального назначения и вентили для подключения бытовой техники

Bibcock

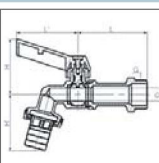

DN	D	L	H	L'	H'
1/2	10	54	49	56	46
3/4	12	63.5	50.5	56	52

Bibcock(B)

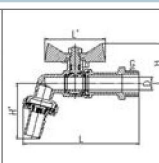

DN	D	L	H	L'	H'
1/2	10	98	34	51	45

Angle valve(S)

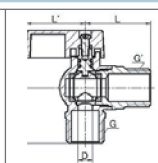

DN	D	L	H	L'	H'
1/2	8	36	32	31	30
3/4	8	35.5	31.5	31	33

Angle valve(U)

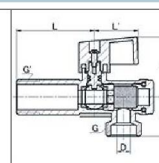

DN	D	L	H	L'	H'
1/2	8	45.5	35	25.5	22.5
3/4	8	45.5	35	25.5	25.5

## Воздухоотводчики

Air vent - A1

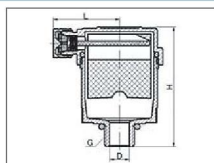

DN	D	L	H	G
3/8	11	29	51	3/8
1/2	15	29	51	1/2

Air vent - L1

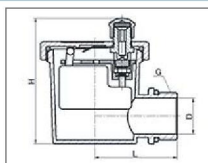

DN	D	L	H	G
3/8	10	35.5	53	3/8
1/2	15.5	35.5	53	1/2

## Сертификат соответствия

