























SPLIT & WINDOW TYPE AIR CONDITIONERS



THE INTELLIGENT CHOICE IN COMFORT





















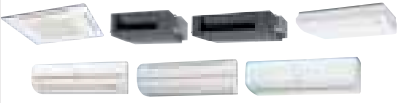









SPLIT & WINDOW TYPE AIR CONDITIONERS LINEUP

Capacity (BTU/h)	CEILING WALL TYPE (P4~5,10~11)				WALL MOUNTED TYPE (P6~9,10~11)	
	INVERTER		INVERTER	INVERTER	INVERTER	
7,000			ASHA07LC 			ASH7FB/7UB
9,000			ASHA09LC 	ASHB09LD 		ASH9FB/9UC
12,000			ASHA12LC 	ASHB12LD 		ASH12FB/12UC
14,000	AWHZ14LB 	AWG14UB	ASHA14LC 			
18,000	AWHZ18LB 	AWG18FA/18UA  AWG18FB/18UB	ASHA18LC	 ASHB18LD		
24,000	 AWHZ24LB 	AWG24FA/24UA  AWG24FB/24UB			 ASHB24LD  ASHA24LC 	
30,000		AWG30FB/30UB			ASHA30LC	

Capacity (BTU/h)	DUCT TYPE (P15,18~21)					COMPACT CASSETTE / CASSETTE		
		INVERTER	INVERTER	INVERTER		INVERTER	INVERTER	
7,000	ARG7F/7U							
9,000	ARG9F/9U							
12,000	ARG12F/12U	 ARHA12L  ARH12L				 AUHA12L 	AUG12F/12U	AUH12L
14,000	ARG14F/14U	 ARHA14L  ARH14L				 AUHA14L 	AUG14F/14U	AUH14L
18,000 ~19,000	ARG18F/18U	 ARHA18L  ARH18L				 AUHA18L 	AUG18F/18U	AUH18L
20,000								
24,000 ~25,000			ARG25F/25U	 ARHA24L  ARH24L		 AUHA24L 		
30,000 ~32,000			ARG30F/30U	ARH30L				
36,000			ARG36F/36U ARG36U(1)	 ARHA36L  ARH36L				
45,000			ARG45F/45U	 ARHA45L  ARH45L	ARH45LH			
54,000					ARH54L			
60,000				ARG60F/60U				
90,000						ARG90E/90T		

		FLOOR TYPE (P9)
		
		INVERTER
ASH9UB 		 AGHV09LA 
ASH12UB 		 AGHV12LA 
ASH14FB/14UB		 AGHV14LA 
	ASG18FA/18UA 	
	ASG18FB/18UB	
	ASG24FB/24UB	
	ASG30FB/30UB	

WINDOW TYPE (P30)			
			
Capacity (BTU/h)			
7,000	AKH7F		
9,000	AKH9F/9U		
12,000		AMH12U	
13,000		AMH13F	
16,000			AFH16F/16U

TYPE (P12~13,22~23)		CEILING/UNIVERSAL TYPE (P14,24~25)		MULTI -TYPE SYSTEMS (P16~17,26~27)					
		FLOOR/CEILING UNIVERSAL TYPE 	CEILING TYPE 	Inner:AS+AS 	Inner:AU+AU 	Inner:AS+AU 			
INVERTER		INVERTER	INVERTER				INVERTER	INVERTER	INVERTER
		ABG14F/14U							
		ABG18F/18U	 ABHA18L  ABH18L	AOH19F AOH19U			AOH18LM2	 ACHA18LAT3 	
AUG25F/25U AUG25F(3)	AUH24L	ABG24F/24U	 ABHA24L  ABH24L	AOH24FSS AOH24USS AOH20F(3) 		AOH20FSU AOH20USU			
AUG30F/30U	AUH30L			AOH24FSS AOH24USS	AOH24FUU AOH24UUU	AOH24FSU AOH24USU	AOH24LM2 	 ACHA24LAT3 	
AUG30F/30U	AUH30L			AOH32E(4)					AOH30LM4 
AUG36F/36U	 AUHA36L  AUH36L			ABG36F/36U	 ABHA36L  ABH36L				
AUG45F/45U	 AUHA45L  AUH45L			ABG45F/45U	 ABHA45L  ABH45L				
AUG54F/54U	AUH54L			ABG54F/54U					

Notice for specifications

I.U.=Indoor Unit O.U.=Outdoor Unit Qu=Quiet * =Not decided yet

- Specifications and design subject to change without notice for further improvement. Please check with your dealer.
- Cooling/Heating capacities are based on the following conditions.

Cooling
Indoor temp. : 27°C DB/19°C WB
Outdoor temp. : 35°C DB/24°C WB

Heating
Indoor temp. : 20°C DB/15°C WB
Outdoor temp. : 7°C DB/6°C WB

For Duct

Air volume (1) models are given without external static pressure.
Air volume (2) models are given when external static pressure is 30Pa.
Air volume (3) models are given when external static pressure is 100Pa.
Air volume (4) models are given when external static pressure is 200Pa.

- (1) ARHA12L/14L/18L, ARG7F/7U/9F/9U/12F/12U/14F/14U/18F/18U
- (2) ARHA24L/36L/45L, ARH30L
- (3) ARH45L/54L, ARG25F/25U/30F/30U/36F/36U/1(1)45F/45U/60F/60U
- (4) ARG90E/90T

INVERTER

CEILING WALL TYPE



4th year of record achievements.
Automatic filter cleaning air conditioner



AWHZ14LB
Ⓞ 4.20kW/14,300BTU/h
Ⓡ 6.00kW/20,500BTU/h



AWHZ18LB
Ⓞ 5.20kW/17,700BTU/h
Ⓡ 6.70kW/22,900BTU/h



AWHZ24LB
Ⓞ 7.10kW/24,200BTU/h
Ⓡ 8.10kW/27,600BTU/h



For AWHZ14/18LB



For AWHZ24LB

V-PAM inverter increases the maximum output of the compressor significantly and enables high power and high efficiency.



V-PAM technology makes the compressor more powerful.



More compact than conventional models.

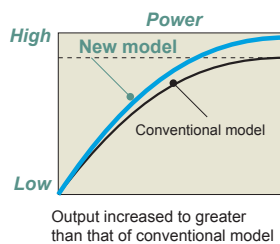
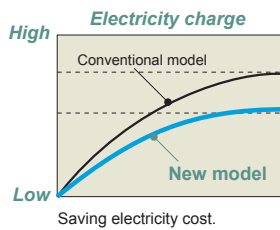

Comparison between V-PAM and conventional PAM.

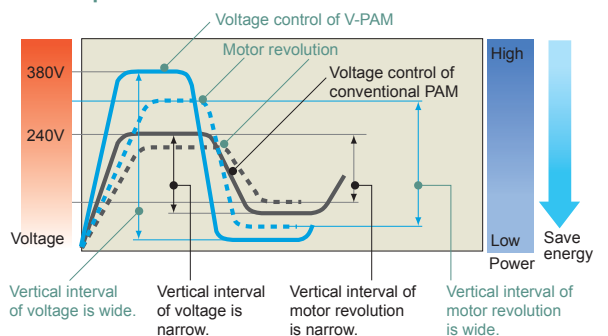

Conventional PAM

Control range between energy saving and high power is small because vertical interval of voltage and motor revolution is narrow.

V-PAM

V-PAM achieves high power by increasing the voltage up to 380V and making the motor rotate faster, and also saves energy in the stable state by making the motor rotate slower than that of conventional models by lowering the voltage.

"Strong vertical air flow" provides powerful floor level heating.

Increased heat exchange efficiency

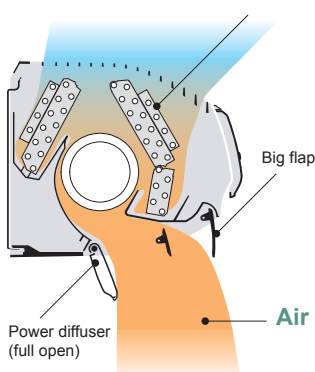

Air is blown directly downward

No. 1
Heating capacity

Comfortable heating area
Approximately **2.5 times***
(Our company comparison)

*Compared to our conventional Model ASH13PSCCW.

"Healthy horizontal air flow" does not blow cool air directly at the occupants in the room.

Increased heat exchange efficiency

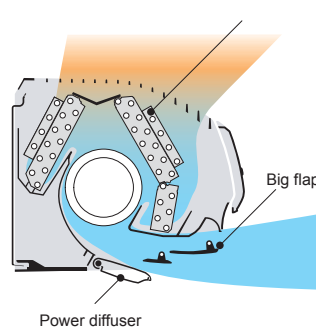

Blown out horizontally

Cooling range
Approximately **1.7 times***
(Our company comparison)

*Compared to our conventional Model ASH13PSCCW.



Automatic filter cleaner

Entire filter is cleaned automatically in approximately 2 minutes.

Since the filter is cleaned automatically, energy saving capability is displayed without regard to the load on the air conditioner.

Energy saving Rank A cleared with a margin to spare.

If the energy saving effect is maintained, filter cleaning once every two weeks is effective.

Two exhaustive bacteria eliminating and deodorizing countermeasures keep the air in the room clean.

If the energy saving effect is maintained, filter cleaning once every two weeks is effective.

Our unique technology that achieved top energy efficiency in the industry



c Energy saving by automatic filter cleaning function

This function allows an energy saving of more than 25% a year and maintains a smooth air flow by preventing the filters from being clogged with dust.

d Computer-designed fan provides a larger air flow than conventional models

New air trunk, which provides a smooth air flow, and axial gap fan motor increase the maximum air flow by 10% over that of conventional models.

CAE: Computer aided engineering



CAE analysis



e Axial gap fan motor enables nonconventional high power and high efficiency.

Axial gap method

Rotor plates are installed above and below electromagnets.

Features (Compared to conventional models)

Compact size with 1.5 more power output Self-driven method increases rotating efficiency by 10%. Our electromagnetic field simulation technology enables low vibration and low noise.

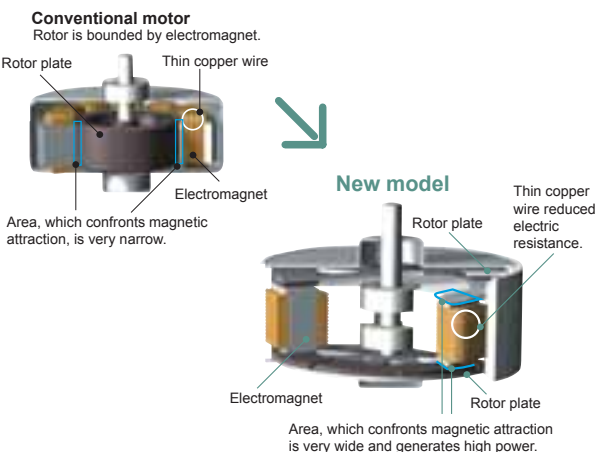

Bacteria eliminating countermeasure

a Dirt and dust are bacteria-eliminated by titan apatite filter*

* Displays double the effect of a conventional optical medium and retains its property for a long time to suck in and remove approximately 99.99% of cigarette odors and bacteria, etc.



b Drives away bacteria and refreshes the air by UV (ultraviolet rays) illumination.

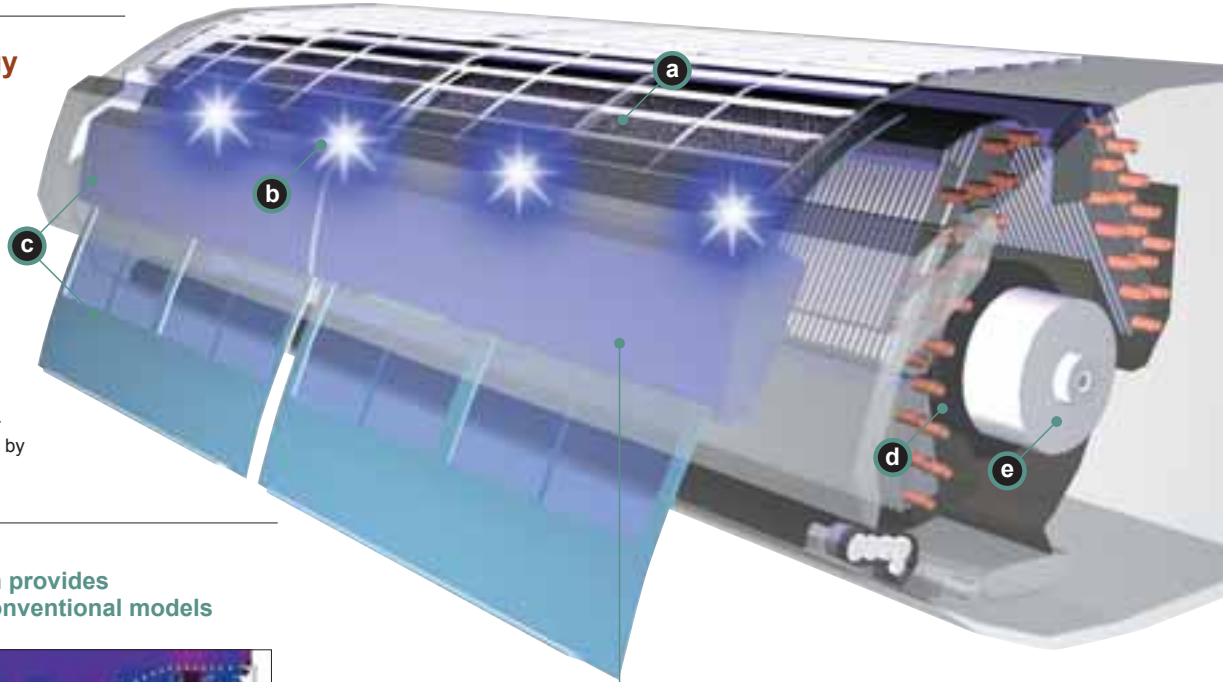

Antibacterial dust box

Removes dirt and dust by double brushes. Dust collection is approximately twice that in the past. (our company comparison) Maintenance: Only throwing into a trash bin once every two years

*1: Announced September 9, 2002. In room air conditioner for the home. (Our company's investigation)

*2: Announced September 26, 2002. Two-wave UV mounted in room air conditioner for the home. (Our company's investigation)

*3: Announced December 13, 2004. As fan motor for air conditioner. (Our company's investigation)



SPECIFICATIONS					
Item	Model No.		AWHZ14LB	AWHZ18LB	AWHZ24LB
	Indoor Unit	Outdoor Unit	AOHZ14LB	AOHZ18LB	AOHZ24LB
Rank (Cooling/Heating)			A/A	A/A	A/A
Capacity	Cooling	kW	4.20 (0.9~5.3)	5.20 (0.9~5.9)	7.10 (2.0~8.0)
			6.00 (0.9~9.1)	6.70 (0.9~9.7)	8.10 (2.0~8.0)
	Cooling	BTU/h	14,300	17,700	24,200
			20,500	22,900	27,600
Moisture Removal	l/h		2.1	2.8	3.0
Room Air Circulation (High)	Inner	m ³ /h	850	850	1,050
	Outer		1,910	1,910	2,500
Input Power	V/ø/Hz		230/1/50	230/1/50	230/1/50
Running Current	Cooling	A	4.5	6.9	9.7
	Heating		5.9	7.2	9.8
Power Consumption	Cooling	kW	1.02	1.58	2.21
	Heating		1.35	1.63	2.24
EER	Cooling	kW/kW	4.12	3.29	3.21
	Heating		4.44	4.11	3.62
Dimensions H x W x D	Inner	mm	250x890x298	250x890x298	250x890x298
			kg(lbs)	13.5(30)	13.5(30)
	Outer	mm	578x790x300	578x790x300	830x900x330
			kg(lbs)	39(86)	39(86)
Connection Method			Flare	Flare	Flare
Connection Pipe Size (Smallø/Largeø)	mm		6.35/12.70	6.35/12.70	6.35/12.70
Max Pipe Length /Height Difference	m		20(15)	20(15)	30(15)
			15	15	20
Permissible Range of Outdoor Temp.	Cooling	°C	-10~43	-10~43	-10~43
	Heating		-15~24	-15~24	-15~24
Refrigerant			R410A	R410A	R410A

INVERTER WALL MOUNTED TYPE

PLASMA AIR CONDITIONER



ASHB09LD
 ● 2.60kW/8,900BTU/h
 ● 3.60kW/12,300BTU/h



ASHB12LD
 ● 3.50kW/11,900BTU/h
 ● 4.80kW/16,400BTU/h



ASHB18LD
 ● 5.20kW/17,700BTU/h
 ● 6.25kW/21,300BTU/h



ASHB24LD
 ● 7.10kW/24,200BTU/h
 ● 8.10kW/27,600BTU/h

*The following contents apply to ASHB09/12/18LD models.

Original plasma air cleaning unit effectively cleans the air in the room.

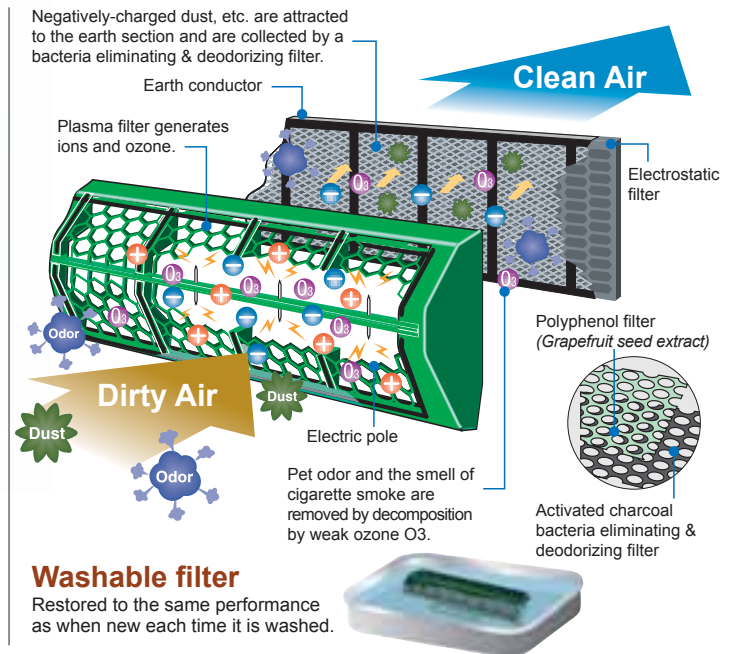

Plasma air cleaner quickly removes small dust particles and odors.

Collects dirt such as...

House dust / Pet fur and dander / Cigarette smoke / Mite carcass / Mold spore / Pollen

Absorbs odors such as...

Smell of cigarette smoke / Pet odor / Kitchen garbage smell / Perspiration and body odor

Dust collection performance (ASHB09/12/18LD)

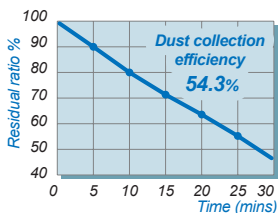

Test method: JEM 1417 Test room: 30m³, sealed room
 Measurement conditions: Cigarette smoke (5 cigarettes burned simultaneously)

Deodorizing performance (ASHB09/12/18LD)

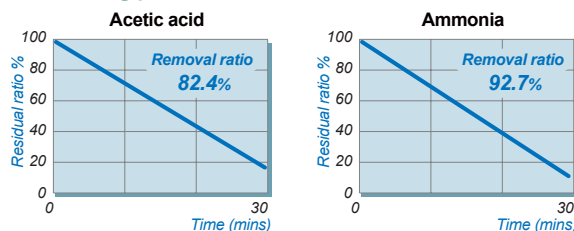

Test method: JEM1467 Test room: 1m³, acrylic sealed box
 Measurement method: Cigarette smoke (5 cigarettes burned simultaneously)

Bacteria elimination effect by Polyphenol ceraglaz



The undiluted solution of the specimen was made the specimen fluid and suspensoid 0.1ml (approximately 10⁷CFU/ml) of the test bacteria was inoculated.

Tested by KITAZATO environment science center
 Test NO. :15-0253 Test condition: at 20degrees C/24hour action

Inner drying operation and plasma effect

This model is equipped with an inner drying function. After the power is turned off, the dry operation starts inside the air conditioner. The plasma air cleaning unit eliminates bacteria, deodorizes, and keeps the interior of the air conditioner clean by generating ozone and ions.

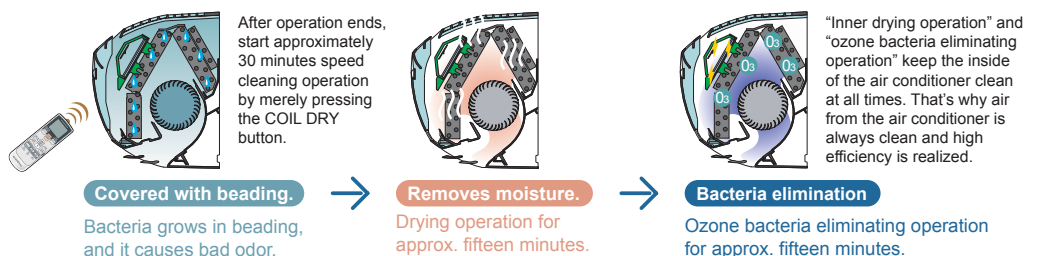



Rank A **i PAM**
ASHA07LC
 C 2.10kW/7,200BTU/h
 H 3.00kW/10,200BTU/h

Rank A **i PAM**
ASHA09LC
 C 2.60kW/8,900BTU/h
 H 3.60kW/12,300BTU/h

Rank A **V PAM**
ASHA12LC
 C 3.50kW/11,900BTU/h
 H 4.80kW/16,400BTU/h

Rank A **ALL DC** **V PAM**
ASHA14LC
 C 4.20kW/14,300BTU/h
 H 5.60kW/19,100BTU/h

ALL DC **V PAM**
ASHA18LC
 C 5.20kW/17,700BTU/h
 H 6.25kW/21,300BTU/h

Air conditioner filter features



Long-life* Ion Deodorization Filter **Ion**
 The filter deodorizes by powerfully decomposing absorbed odors using the oxidizing and reducing effects of ions generated by the ultra-fine-particle ceramic.
 (* The filter can be used for approximately 3 years if it is washed under water to restore its surface action when it is dirty.)

Deodorizing effect (Odor reduction rate)

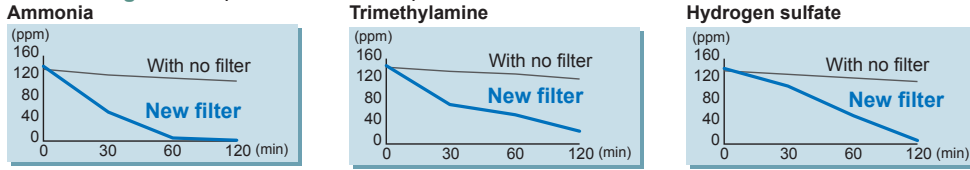

Testing organization : Environmental Sanitary Inspection Center Test method : Deodorization Test

Apple-catechin Filter **AF**
 Fine dust, invisible mold spores, and harmful microorganisms are absorbed onto the filter by static electricity, and further growth is inhibited and deactivated by the polyphenol ingredient extracted from apples.

Easy maintenance

Easy maintenance and always clean. Troublesome maintenance has been made easy. Since the front panel is easy to remove, maintenance is also easy.



Inner drying operation

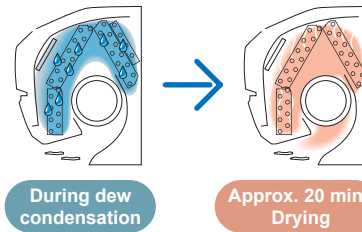

This model is equipped with an inner drying function. After the power is turned off, the dry operation starts inside the air conditioner. This prevents the growth of mold and bacterial inside the air conditioner.

SPECIFICATIONS		Model No.	Indoor Unit	ASHB09LD	ASHB12LD	ASHB18LD	ASHB24LD	ASHA07LC	ASHA09LC	ASHA12LC	ASHA14LC	ASHA18LC
Item			Outdoor Unit	AOHS09LD	AOHS12LD	AOHS18LD	AOHS24LD	AOHR07LC	AOHR09LC	AOHR12LC	AOHR14LC	AOHR18LC
Rank (Cooling/Heating)				A/A	A/A	B/A	A/A	A/A	A/A	A/A	A/A	B/A
Capacity	Cooling	kW		2.60 (0.5~3.7)	3.50 (0.9~4.3)	5.20 (0.9~5.7)	7.10 (2.0~8.0)	2.10 (0.5~3.0)	2.60 (0.5~3.6)	3.50 (0.9~4.3)	4.20 (0.9~5.3)	5.20 (0.9~5.7)
	Heating			3.60 (0.5~6.1)	4.80 (0.9~6.7)	6.25 (0.9~9.1)	8.10 (2.0~10.0)	3.00 (0.5~4.6)	3.60 (0.5~5.3)	4.80 (0.9~6.7)	5.60 (0.9~8.4)	6.25 (0.9~9.1)
	Cooling	BTU/h		8,900	11,900	17,700	24,200	7,200	8,900	11,900(3,100~14,700)	14,300 (3,100~18,100)	17,700 (3,100~19,400)
	Heating			12,300	16,400	21,300	27,600	10,200	12,300	16,400(3,100~22,900)	19,100 (3,100~28,700)	21,300(3,100~31,000)
Moisture Removal		l/h		1.30	1.80	2.80	3.00	1.00	1.30	1.80	2.10	2.80
Room Air Circulation (High)	Inner	m ³ /h		595	635	700	1,100	595	595	635	700	700
	Outer			2,100	1,850	2,000	2,040	1,870	1,870	1,850	1,910	2,000
Input Power		V/ø/Hz		230/1/50	230/1/50	230/1/50	230/1/50	230/1/50	230/1/50	230/1/50	230/1/50	230/1/50
Running Current	Cooling	A		2.90	4.30	7.60	9.70	2.50	3.20	4.30	5.00	7.60
	Heating			3.90	5.50	7.70	9.80	3.20	4.00	5.60	6.40	7.70
Power Consumption	Cooling	kW		0.61	0.91	1.72	2.21	0.47	0.655	0.92	1.11 (0.09~1.75)	1.72 (0.09~2.00)
	Heating			0.81	1.22	1.73	2.24	0.66	0.845	1.24	1.45 (0.09~2.48)	1.73 (0.09~2.66)
EER	Cooling	kW/kW		4.26	3.85	3.02	3.21	4.47	3.97	3.80	3.78	3.02
COP	Heating			4.44	3.93	3.61	3.62	4.55	4.26	3.87	3.86	3.61
Dimensions H x W x D	Inner	mm		283x790x230	283x790x230	283x790x230	320x998x228	275x790x215	275x790x215	275x790x215	275x790x215	275x790x215
		kg(lbs)		9.5(21)	9.5(21)	9.5(21)	16(35)	9(20)	9(20)	9(20)	9(20)	9(20)
Net Weight	Outer	mm		540x790x290	540x790x290	578x790x300	578x790x315	540x660x290	540x660x290	540x790x290	578x790x300	578x790x300
		kg(lbs)		34(75)	36(80)	40(88)	44(97)	32(71)	32(71)	37(82)	40(88)	40(88)
Connection Method				Flare	Flare	Flare	Flare	Flare	Flare	Flare	Flare	Flare
Connection Pipe Size (Smallø/Largeø)		mm		6.35/9.52	6.35/9.52	6.35/9.52	6.35/12.7	6.35/9.52	6.35/9.52	6.35/9.52	6.35/12.7	6.35/12.7
Max Pipe Length /Height Difference		m		20(15)	20(15)	20(15)	30(10)	20(15)	20(15)	20(15)	20(15)	20(15)
				15	15	15	20	15	15	15	15	15
Permissible Range of Outdoor Temp.	Cooling	°C		-10~43	-10~43	-10~43	-10~43	-10~43	-10~43	-10~43	-10~43	-10~43
	Heating			-15~24	-15~24	-15~24	-15~24	-15~24	-15~24	-15~24	-15~24	-15~24
Refrigerant				R410A	R410A	R410A	R410A	R410A	R410A	R410A	R410A	R410A

INVERTER



WALL MOUNTED TYPE

Flat panel and family look design



Rank **A** ALL DC V-PAM
ASHA24LC
 C 7.10kW/24,200BTU/h
 H 8.00kW/27,600BTU/h

ALL DC V-PAM
ASHA30LC
 C 8.00kW/27,300BTU/h
 H 9.00kW/30,700BTU/h

*The following contents apply to ASHA24LC models.

ALL DC



Heat exchange capacities 20% up compared to conventional models



DC fan motor

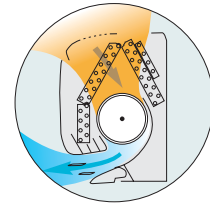

High efficiency layout

Large air flow and quiet operation by new air flow path

a DC fan motor

b V-PAM control
 V-PAM technology makes a compressor more powerful.

c DC scroll compressor
 More compact compared with conventional model

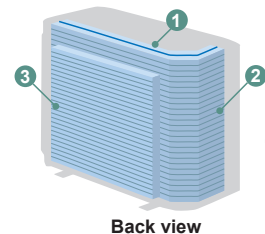
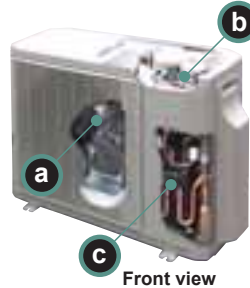

New 3-row heat exchange system

Compact design

New model



H320 x W998 x D228



44kg

H578 x W790 x D315

Conventional model



H320 x W1,120 x D220



70kg

H900 x W900 x D350

(unit:mm)

Air conditioner filter features

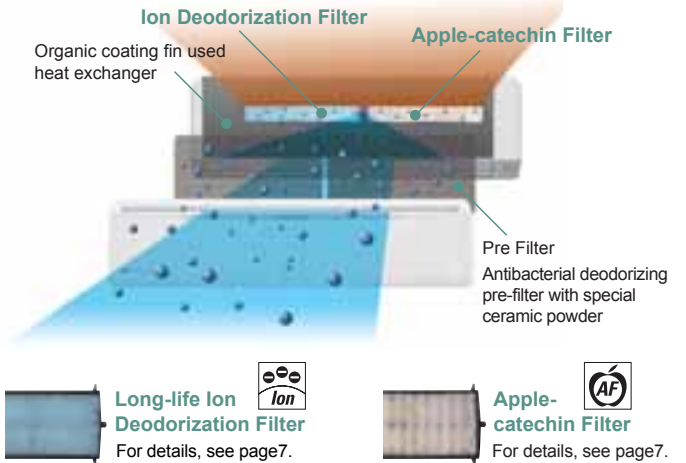

Power diffuser

“Strong vertical air flow” provides powerful floor level heating.

No.1 maximum heating capacity 10kW attained

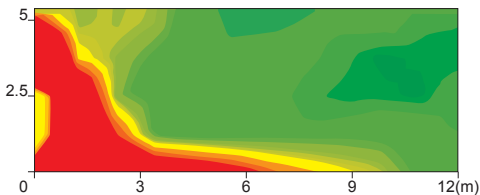

Outside air conditions: 2°C 60%
 Operation contents: Heating,
 Set temperature (Max set temp)
 30°C, Air flow Hi,
 Air direction downward and front

33 32 31 30 29 (°C)

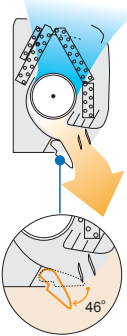

“Healthy horizontal air flow” does not blow cool air directly at the occupants in the room.

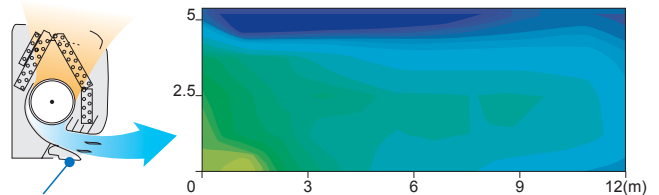

Outside air conditions: 35°C 40%
 Operation contents: Cooling,
 Set temperature (Min set temp)
 18°C, Air flow Hi,
 Air direction downward and front

15 16 17 18 (°C)

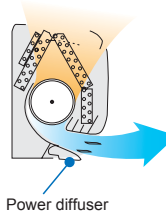

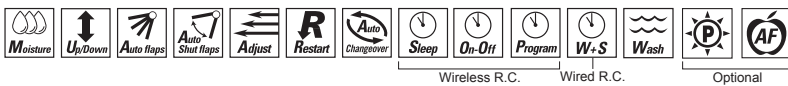

INVERTER

FLOOR TYPE

Simple & Thin design harmonizes with the interior

NEW

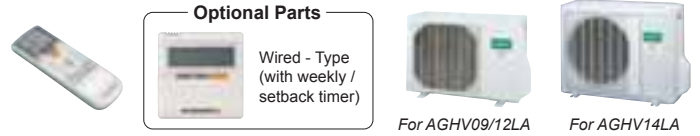

Rank **A** ALL DC V PAM
AGHV09LA
 C 2.60kW/8,900BTU/h
 H 3.50kW/11,900BTU/h

Rank **A** ALL DC V PAM
AGHV12LA
 C 3.50kW/11,900BTU/h
 H 4.50kW/15,400BTU/h

Rank **A** ALL DC V PAM
AGHV14LA
 C 4.20kW/14,300BTU/h
 H 5.20kW/17,700BTU/h

Flexible & easy installation

Beneath standard window

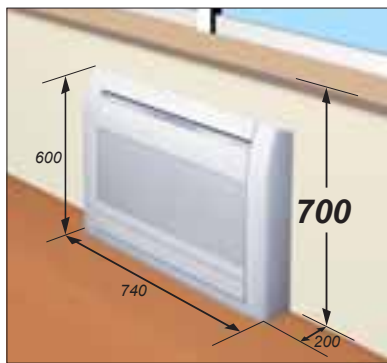

(unit: mm)

Standard concave portion

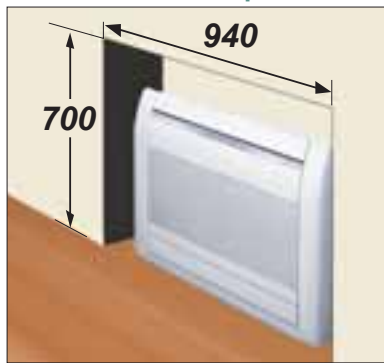

(unit: mm)

Wall



(unit: mm)

Choice of 6-direction drain and piping connection

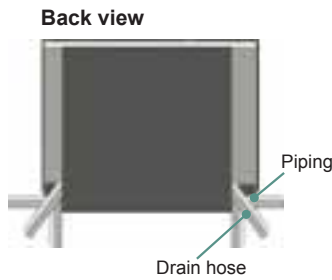

Space is wide and piping work is easy

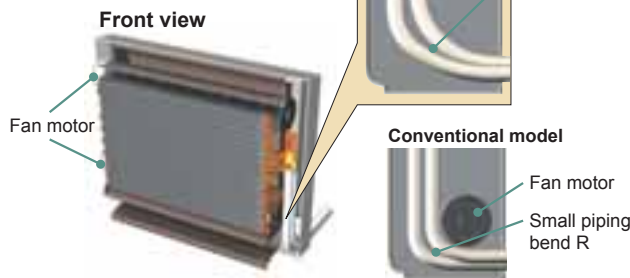

Quiet operation

Fan speed	Noise level
Quiet	22dB(A)

Low ambient outdoor temperature design

Cooling	-10 to 43°C
Heating	-15 to 24°C

2-Fan & wide air flow

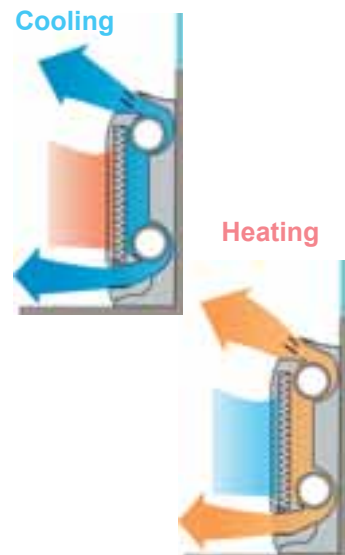

SPECIFICATIONS			WALL MOUNTED TYPE			FLOOR TYPE*	
Model No.	Indoor Unit	Outdoor Unit	ASHA24LC	ASHA30LC	AGHV09LA	AGHV12LA	AGHV14LA
Item			AOHR24LC	AOHR30LC	AOHV09LA	AOHV12LA	AOHV14LA
Rank (Cooling/Heating)			A/A	B/B	A/A	A/A	A/A
Capacity	Cooling	kW	7.10(2.0~8.0)	8.00(2.0~9.0)	2.60(0.9~3.5)	3.50(0.9~4.1)	4.20(0.9~4.8)
	Heating		8.10(2.0~11.0)	9.00(2.0~11.0)	3.50(0.9~5.2)	4.50(0.9~6.2)	5.20(0.9~7.0)
	Cooling	BTU/h	24,200	27,300	8,900	11,900	14,300
	Heating		27,600	30,700	11,900	15,400	17,700
Moisture Removal		l/h	3	3.6	1.3	1.8	2.1
Room Air Circulation (High)	Inner	m³/h	1,100	1,100	600	600	650
	Outer		2,040	3,600	1,850	1,850	1,910
Input Power		V/ø/Hz	230/1/50	230/1/50	230/1/50	230/1/50	230/1/50
Running Current	Cooling	A	9.7	11.7	2.8	4.8	5.6
	Heating		9.8	11.6	3.9	5.6	6.4
Power Consumption	Cooling	kW	2.21	2.66	0.58	1.02	1.23
	Heating		2.24	2.64	0.8	1.21	1.44
EER	Cooling	kW/kW	3.21	3.01	4.48	3.43	3.41
COP	Heating	kW/kW	3.62	3.41	4.38	3.72	3.61
Dimensions H x W x D	Inner	mm	320x998x228	320x998x228	600x740x200	600x740x200	600x740x200
		kg(lbs)	16(35)	16(35)	14	14	14
Net Weight	Outer	mm	578x790x315	830x900x330	540x790x290	540x790x290	578x790x300
		kg(lbs)	44(97)	62(137)	36	36	40
Connection Method			Flare	Flare	Flare	Flare	Flare
Connection Pipe Size (Smallø/Largeø)		mm	6.35/15.88	9.52/15.88	6.35/9.52	6.35/9.52	6.35/12.7
Max Pipe Length /Height Difference		m	30(15)	50(15)	20(15)	20(15)	20(15)
			20	30	15	15	15
Permissible Range of Outdoor Temp.	Cooling	°C	-10~43	-10~43	-10~43	-10~43	-10~43
	Heating		-15~24	-15~24	-15~24	-15~24	-15~24
Refrigerant			R410A	R410A	R410A	R410A	R410A

*Tentative specifications

WALL MOUNTED TYPE

Easy-to-install and easy-to-operate wall mounted type for a comfortable life.

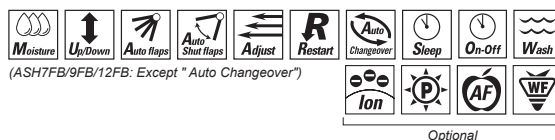

For ASH7FB/9FB/12FB: Except *Auto Changeover*



For ASH9FB/12FB: Plastic Cabinet Outdoor Unit

ASH7FB

2.25kW / 7,700BTU/h

ASH9FB

2.75kW / 9,400BTU/h

ASH12FB

3.40kW / 11,600BTU/h

ASH7UB

2.20kW / 7,500BTU/h
2.30kW / 7,800BTU/h

ASH9UC

2.60kW / 8,900BTU/h
2.95kW / 10,100BTU/h

ASH12UC

3.25kW / 11,100BTU/h
3.95kW / 13,500BTU/h

SPECIFICATIONS			WALL MOUNTED TYPE							
Model No.	Indoor Unit		ASH7FB	ASH7UB	ASH9FB	ASH9UC	ASH12FB	ASH12UC	ASH9UB	ASH12UB
Item	Outdoor Unit		AOH7FB	AOH7UB	AOH9FB	AOH9UC	AOH12FB	AOH12UC	AOH9UB	AOH12UB
Rank			C	D / D	D	E / C	E	E / D	A / A	A / A
Capacity	Cooling	kW	2.25	2.20	2.75	2.60	3.40	3.25	2.90	3.70
			-	2.30	-	2.95	-	3.95	3.05	4.00
	Heating	BTU/h	7,700	7,500	9,400	8,900	11,600	11,100	9,900	12,600
			-	7,800	-	10,100	-	13,500	10,400	13,600
Moisture Removal	l/h		1.0	1.0	1.3	1.3	1.8	1.8	1.3	1.9
Room Air Circulation (High)	Inner	m ³ /h	380	380	540	540	540	540	600	700
	Outer	m ³ /h	1,350	1,350	1,680	1,350	1,470	1,700	1,470	1,710
Input Power	V/ø/Hz		230/1/50	230/1/50	230/1/50	230/1/50	230/1/50	230/1/50	230/1/50	230/1/50
Running Current	Cooling	A	3.7	3.9	4.7	4.8	6.2	5.9	3.7	5.0
	Heating	A	-	3.6	-	4.1	-	5.6	3.3	4.6
Power Consumption	Cooling	kW	0.80	0.83	1.05	1.07	1.33	1.35	0.84	1.13
	Heating	kW	-	0.75	-	0.90	-	1.28	0.75	1.04
EER	Cooling	kW/kW	2.81	2.65	2.62	2.43	2.56	2.41	3.45	3.27
COP	Heating	kW/kW	-	3.07	-	3.28	-	3.09	4.07	3.85
Dimensions H x W x D	Inner	mm	257x808x187	257x808x187	257x808x187	257x808x187	257x808x187	257x808x187	257x790x215	275x790x215
		kg(lbs)	8(18)	8(18)	8(18)	8(18)	8(18)	8(18)	9(20)	9(20)
Net Weight	Outer	mm	535x650x250	535x650x250	535x695x250	535x650x250	535x695x250	535x695x250	535x695x250	535x780x250
		kg(lbs)	25(55)	26(57)	30(66)	28(82)	32(71)	31(68)	30(66)	35(77)
Connection Method			Flare	Flare	Flare	Flare	Flare	Flare	Flare	Flare
Connection Pipe Size (Smallø/Largeø)	mm		6.35/9.52	6.35/9.52	6.35/9.52	6.35/9.52	6.35/9.52	6.35/9.52	6.35/9.52	6.35/9.52
Max Pipe Length /Height Difference	m		10	10	15	15	15	15	15	15
	m		5	5	8	8	8	8	8	8
Permissible Range of Outdoor Temp.	Cooling	°C	21~43	21~43	21~43	21~43	21~43	21~43	21~43	21~43
	Heating	°C	-	-5~24	-	-5~24	-	-5~24	-5~24	-5~24
Refrigerant			R410A	R410A	R410A	R410A	R410A	R410A	R410A	R410A

CEILING WALL TYPE

New intelligent and beautiful air conditioner matches any scene.



For AWG14UB



For AWG18FA/18UA/18FB/18UB/24FB/24UB



For AWG24FA/24UA/24FB/24UB



For AWG30FA/30UA/30FB/30UB

AWG18FA

5.40kW / 18,400BTU/h



AWG18FB

5.40kW / 18,400BTU/h

AWG24FA

6.80kW / 23,200BTU/h



AWG24FB

6.80kW / 23,200BTU/h

AWG30FB

7.90kW / 27,000BTU/h

AWG14UB

4.20kW / 14,300BTU/h
4.60kW / 15,700BTU/h

AWG18UA

5.40kW / 18,400BTU/h
5.70kW / 19,500BTU/h



AWG18UB

5.40kW / 18,400BTU/h
5.70kW / 19,500BTU/h

AWG24UA

6.80kW / 23,200BTU/h
7.40kW / 25,300BTU/h



AWG24UB

6.80kW / 23,200BTU/h
7.40kW / 25,300BTU/h

AWG30UB

7.90kW / 27,000BTU/h
8.40kW / 28,700BTU/h

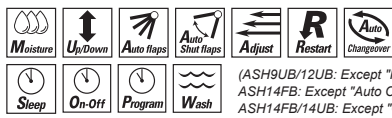

(ASH9UB/12UB: Except "Program"
ASH14FB: Except "Auto Changeover"
ASH14FB/14UB: Except "ON/OFF Timer")

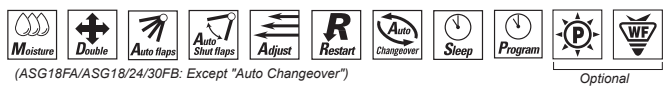

(ASG18FA/ASG18/24/30FB: Except "Auto Changeover")

Optional



For ASH9UB For ASH14FB/14UB



For ASH9UB Plastic Cabinet Outdoor Unit

ASH9UB Rank A
 ● 2.90kW / 9,900BTU/h
 ● 3.05kW / 10,400BTU/h

ASH14FB
 ● 4.20kW / 14,300BTU/h

ASH12UB Rank A
 ● 3.70kW / 12,600BTU/h
 ● 4.00kW / 13,600BTU/h

ASH14UB
 ● 4.25kW / 14,500BTU/h
 ● 4.80kW / 16,400BTU/h



For ASG18FA/18UA 18FB/18UB/24FB/24UB



For ASG30FB/30UB

ASG18FA Rank A
 ● 5.40kW / 18,400BTU/h

ASG18FB
 ● 5.40kW / 18,400BTU/h

ASG24FB
 ● 6.80kW / 23,200BTU/h

ASG30FB
 ● 7.90kW / 27,000BTU/h

ASG18UA Rank A
 ● 5.40kW / 18,400BTU/h
 ● 5.70kW / 19,500BTU/h

ASG18UB
 ● 5.40kW / 18,400BTU/h
 ● 5.70kW / 19,500BTU/h

ASG24UB
 ● 6.80kW / 23,200BTU/h
 ● 7.40kW / 25,300BTU/h

ASG30UB
 ● 7.90kW / 27,000BTU/h
 ● 8.40kW / 28,700BTU/h

WALL MOUNTED TYPE

ASH14FB	ASH14UB	ASG18FA	ASG18UA	ASG18FB	ASG18UB	ASG24FB	ASG24UB	ASG30FB	ASG30UB
AOH14FB	AOH14UB	AOG18FA	AOG18UA	AOG18FB	AOG18UB	AOG24FB	AOG24UB	AOG30FB	AOG30UB
C	B / A	A	A / A	C	C / D	C	C / D	C	C / D
4.20	4.25	5.40	5.40	5.40	5.40	6.80	6.80	7.90	7.90
-	4.80	-	5.70	-	5.70	-	7.40	-	8.40
14,300	14,500	18,400	18,400	18,400	18,400	23,200	23,200	27,000	27,000
-	16,400	-	19,500	-	19,500	-	25,300	-	28,700
2.0	2.0	2.0	2.0	2.0	2.0	2.5	2.5	3.0	3.0
700	700	950	950	795	800	950	970	1,040	1,040
1,755	1,670	3,200	3,200	3,400	3,200	3,200	3,200	3,320	3,320
230/1/50	230/1/50	230/1/50	230/1/50	230/1/50	230/1/50	230/1/50	230/1/50	230/1/50	230/1/50
6.6	6.1	7.3	7.3	8.5	8.3	10.6	10.6	13.0	13.0
-	5.6	-	7.0	-	8.3	-	10.5	-	13.0
1.48	1.38	1.66	1.66	1.90	1.85	2.40	2.40	2.75	2.75
-	1.27	-	1.58	-	1.85	-	2.40	-	2.75
2.84	3.08	3.25	3.25	2.84	2.92	2.83	2.83	2.87	2.87
-	3.78	-	3.61	-	3.08	-	3.08	-	3.05
275x790x215	275x790x215	320x1,120x220	320x1,120x220	320x1,120x220	320x1,120x220	320x1,120x220	320x1,120x220	320x1,120x220	320x1,120x220
9(20)	9(20)	16(35)	16(35)	16(35)	16(35)	16(35)	16(35)	16(35)	16(35)
535x780x250	535x780x250	650x830x320	650x830x320	650x830x320	650x830x320	650x830x320	650x830x320	900x900x350	900x900x350
35(77)	37(82)	51(112)	52(114)	47(103)	52(114)	59(130)	59(130)	73(161)	74(163)
Flare	Flare	Flare	Flare	Flare	Flare	Flare	Flare	Flare	Flare
6.35/12.70	6.35/12.70	6.35/15.88	6.35/15.88	6.35/15.88	6.35/15.88	9.52/15.88	9.52/15.88	9.52/15.88	9.52/15.88
15	15	20	20	20	20	20	20	30	25
8	8	8	8	8	8	8	8	15	15
21~43	21~43	21~43	-5~43	21~43	0~43	21~43	0~43	0~43	0~43
-	-5~24	-	-10~24	-	-6~24	-	-6~24	-	-6~24
R410A	R410A	R410A	R410A	R410A	R410A	R410A	R410A	R410A	R410A

SPECIFICATIONS

Item	Model No.	Indoor Unit		CEILING WALL TYPE												
		Outdoor Unit		AWG14UB	AWG18FA	AWG18UA	AWG18FB	AWG18UB	AWG24FA	AWG24UA	AWG24FB	AWG24UB	AWG30FB	AWG30UB		
Rank				C / B	A	A / A	C	C / D	A	A / A	C	C / D	C	C / D		
Capacity	Cooling	kW		4.20	5.40	5.40	5.40	5.40	6.80	6.80	6.80	6.80	7.90	7.90		
				4.60	-	5.70	-	5.70	-	7.40	-	7.40	-	8.40		
	Heating	BTU/h		14,300	18,400	18,400	18,400	18,400	23,200	23,200	23,200	23,200	27,000	27,000		
				15,700	-	19,500	-	19,500	-	25,300	-	25,300	-	28,700		
Moisture Removal				l/h	1.6	2.0	2.0	2.0	2.5	2.5	2.5	2.5	3.0	3.0		
Room Air Circulation (High)	Inner	Outer		m ³ /h	650	900	900	760	760	1,050	1,050	900	900	950	950	
					1,600	3,200	3,200	3,400	3,200	3,320	3,320	3,200	3,200	3,320	3,320	
Input Power				V/∅/Hz	230/1/50	230/1/50	230/1/50	230/1/50	230/1/50	230/1/50	230/1/50	230/1/50	230/1/50	230/1/50		
Running Current	Cooling	Heating		A	6.5	7.3	7.3	8.5	8.3	9.4	9.4	10.6	10.6	13.0	13.0	
					5.7	-	7.0	-	8.3	-	9.0	-	10.5	-	13.0	
Power Consumption	Cooling	Heating		kW	1.45	1.66	1.66	1.90	1.85	2.12	2.12	2.40	2.40	2.75	2.75	
					1.28	-	1.58	-	1.85	-	2.05	-	2.40	-	2.75	
EER	Cooling			kW/kW	2.90	3.25	3.25	2.84	2.92	3.21	3.21	2.83	2.83	2.87	2.87	
COP	Heating				3.59	-	3.61	-	3.08	-	3.61	-	3.08	-	3.05	
Dimensions H x W x D	Inner	Outer		mm	270x1,150x285	270x1,150x285	270x1,150x285	270x1,150x285	270x1,150x285	270x1,150x285	270x1,150x285	270x1,150x285	270x1,150x285	270x1,150x285	270x1,150x285	
					kg(lbs)	16(35)	16(35)	16(35)	16(35)	16(35)	16(35)	16(35)	16(35)	16(35)	16(35)	16(35)
					mm	530x750x250	650x830x320	650x830x320	650x830x320	650x830x320	900x900x350	900x900x350	650x830x320	650x830x320	900x900x350	900x900x350
Net Weight	Inner	Outer		kg(lbs)	35(77)	51(112)	52(114)	47(103)	52(114)	73(161)	74(163)	58(128)	59(130)	73(161)	74(163)	
					Flare	Flare	Flare	Flare	Flare	Flare	Flare	Flare	Flare	Flare	Flare	
Connection Method					mm	6.35/12.70	6.35/15.88	6.35/15.88	6.35/15.88	6.35/15.88	9.52/15.88	9.52/15.88	9.52/15.88	9.52/15.88	9.52/15.88	
Connection Pipe Size (Small∅/Large∅)					m	15	20	20	20	20	20	20	20	30	25	
Max Pipe Length /Height Difference						8	8	8	8	8	8	8	8	15	15	
Permissible Range of Outdoor Temp.	Cooling	Heating		°C	21~43	21~43	-5~43	21~43	0~43	21~43	-5~43	21~43	0~43	0~43	0~43	
					-6~24	-	-10~24	-	-6~24	-	-10~24	-	-6~24	-	-6~24	
Refrigerant						R410A	R410A	R410A	R410A	R410A	R410A	R410A	R410A	R410A	R410A	

INVERTER

COMPACT CASSETTE TYPE

Grille is an option.

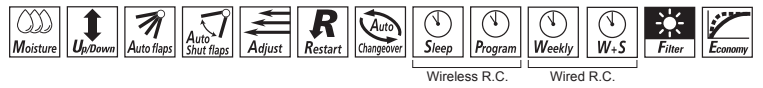

Realised No.1 energy saving in compact cassette type
WORLD FIRST 24 type model in compact cassette category

This design makes us feel wide angle airflow
NEW PANORAMA FLOW DESIGN

Optional Parts

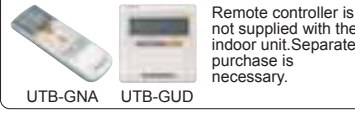

Compact Outdoor Unit



AUHA12L
 C 3.50kW/11,950BTU/h
 H 4.10kW/14,000BTU/h



AUHA14L
 C 4.30kW/14,650BTU/h
 H 5.00kW/17,050BTU/h



AUHA18L
 C 5.20kW/17,700BTU/h
 H 6.00kW/20,500BTU/h



AUHA24L
 C 7.10kW/24,200BTU/h
 H 8.00kW/27,300BTU/h

RANK A

	AUHA12L	AUHA14L	AUHA18/24L	AUHA36/45L
EER (Cooling)	3.33	3.21	3.21	3.21
COP (Heating)	3.69	3.71	3.61	3.71

ALL DC

- a High efficiency DC fan motor (Indoor Unit)
- b High efficiency DC fan motor (Outdoor Unit)
- c High efficiency DC twin rotary compressor

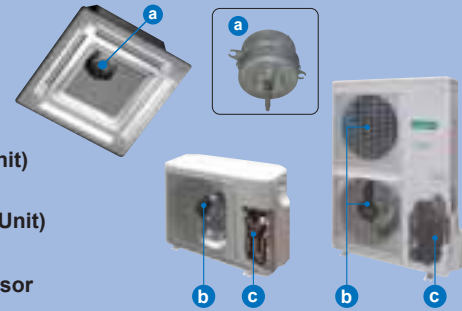

WORLD FIRST 2-stage turbo fan (AUHA12-24L)

High efficiency design by 2 stages structure

Conventional turbo fan

In case of conventional fan, airflow move to motor side which made air outlet range narrow, and velocity of air passing through heat exchanger was uneven.

(Motor side)

Fast
Slow
Wind velocity

2-stage turbo fan

2 stages of airflow attracting each other produced by 2 stages structure of new fan, realize airflow spreading constantly and widely to heat exchanger.

1-stage + 2-stage

Heat exchange efficiency **20%UP**

Quiet quality

Adoption of laminar wing

Laminar wing

Airflow run through smoothly along the laminar wing

Quiet

No airflow separation

Spin direction
Airflow direction

Airflow control (AUHA12-18L)

Improvement in airflow range

* Wind velocity at maximum point of airflow range is 0.5m/s

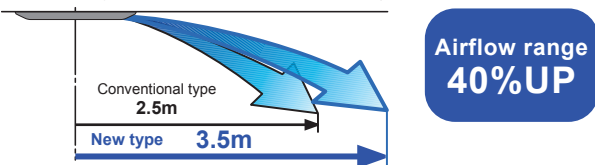

Expansion of air outlet adjustment range

Auto airflow direction and auto swing
Expanded air outlet range provides more comfortable space

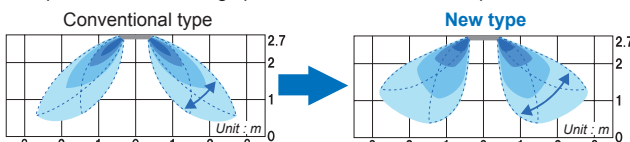

Easy maintenance (AUHA12-18L)

1 Maintenance of fan motor and fan

Maintenance of fan motor and fan can be done easily after taking off the panel, since bell-mouth can be removed easily.

- a: Fan motor
- b: 2-stage turbo fan
- c: Bell-mouth
- d: Panel

2 Long life filter

: standard equipment

3 Adaptation of transparent drainage parts

Easy check of operation of drain-up kit when you install

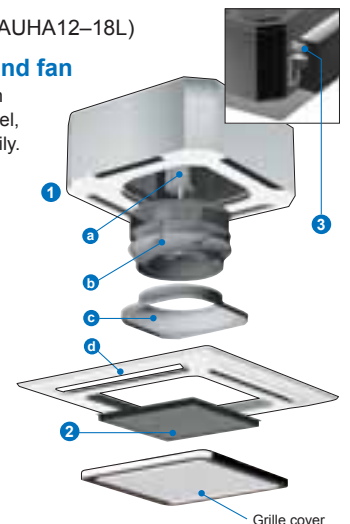

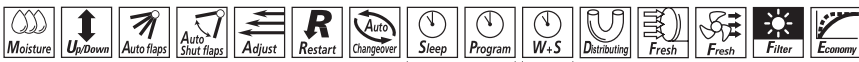

Wireless R.C. Wired R.C.

INVERTER

CASSETTE TYPE



NEW

Optional Parts

Remote controller is not supplied with the indoor unit. Separate purchase is necessary.

UTB-GNA UTB-GUD



AUHA36L
 Ⓞ 10.00kW/34,100BTU/h
 Ⓜ 11.20kW/38,200BTU/h



AUHA45L
 Ⓞ 12.50kW/42,700BTU/h
 Ⓜ 14.00kW/47,800BTU/h

Quiet operation (Example : AUHA18 Type)

Conventional type

Fan speed	Noise level
High	44dB(A)
Med	41dB(A)
Low	39dB(A)
Quiet	No setting

New type

Fan speed	Noise level
High	38dB(A)
Med	34dB(A)
Low	30dB(A)
Quiet	26dB(A)

Long piping & low ambient outdoor temperature design

▶ Maximum piping length

	Max. Length (Chargeless)	Max. Height
AUHA12~18L	25m (15m)	15m
AUHA24L	30m (15m)	20m

▶ Low ambient outdoor temperature

Cooling	-10 to 46 °C
Heating	-15 to 24 °C

Easy installation

▶ Various work setting done from remote controller at the time of installation

Easy setting by wireless or wired remote controller

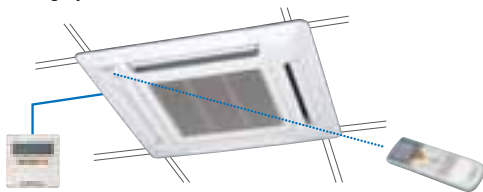

▶ Switching to "High ceiling mode" (AUHA18/24L)

Air reaches sufficiently up to 3.5m height, even it is compact cassette type

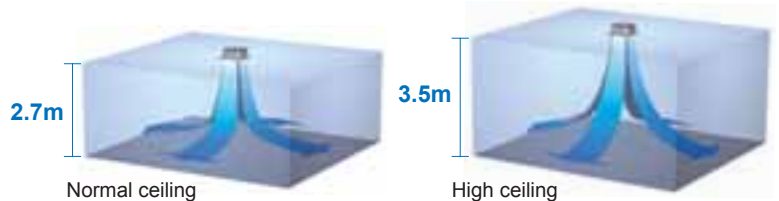

*1:October 18, 2006, announcement at IKK2006. In package air conditioner for commercial use (Our company's investigation)
 *2:October 18, 2006, announcement at IKK2006. As fan for air conditioner (Our company's investigation)
 *3:As of January 2006, size of outdoor unit minimized in 5.3kW and 7.0kW class European size (compact) ceiling cassette air conditioner. (Our company's investigation)
 *4:The specification values exclude the panel.

SPECIFICATIONS			COMPACT CASSETTE TYPE				CASSETTE TYPE	
Model No.	Indoor Unit		AUHA12L	AUHA14L	AUHA18L	AUHA24L	AUHA36L	AUHA45L
Item	Outdoor Unit		AOHA12L	AOHA14L	AOHA18L	AOHA24L	AOHA36L	AOHA45L
Rank (Cooling/Heating)			A / A	A / A	A / A	A / A	A / A	A / A
Capacity	Cooling	kW	3.50	4.30	5.20	7.10	10.00	12.50
			4.10	5.00	6.00	8.00	11.20	14.00
	Heating	BTU/h	11,950	14,650	17,700	24,200	34,100	42,700
			14,000	17,050	20,500	27,300	38,200	47,800
Moisture Removal		l/h	1.2	1.5	2.2	2.7	3.5	4.5
Room Air Circulation (High)	Inner	m ³ /h	600	680	680	930	1,650	1,750
	Outer		1,780	1,910	2,000	2,470	6,600	6,600
Input Power		V/ø/Hz	230/1/50	230/1/50	230/1/50	230/1/50	230/1/50	230/1/50
Running Current	Cooling	A	4.6	5.8	7.1	9.7	13.6	17.0
	Heating		4.9	5.9	7.3	11.5	13.2	16.5
Power Consumption	Cooling	kW	1.05	1.33	1.62	2.21	3.11	3.89
	Heating		1.11	1.34	1.66	2.21	3.02	3.77
EER	Cooling	kW/kW	3.33	3.21	3.21	3.21	3.21	3.21
COP	Heating		3.69	3.71	3.61	3.61	3.71	3.71
Dimensions H x W x D	Inner	mm	245x570x570	245x570x570	245x570x570	245x570x570	296x830x830	296x830x830
		kg(lbs)	15(33)	15(33)	15(33)	17(37)	39(86)	39(86)
Net Weight	Outer	mm	578x790x300	578x790x300	578x790x300	578x790x315	1,290x900x330	1,290x900x330
		kg(lbs)	40(88)	40(88)	40(88)	44(97)	98(216)	98(216)
Connection Method			Flare	Flare	Flare	Flare	Flare	Flare
Connection Pipe Size (Smallø/Largeø)		mm	6.35/9.52	6.35/12.70	6.35/12.70	6.35/15.88	9.52/15.88	9.52/15.88
Max Pipe Length /Height Difference		m	25	25	25	30	50	50
			15	15	15	20	30	30
Permissible Range of Outdoor Temp.	Cooling	°C	-10~46	-10~46	-10~46	-10~46	-15~46	-15~46
	Heating		-15~24	-15~24	-15~24	-15~24	-15~24	-15~24
Refrigerant			R410A	R410A	R410A	R410A	R410A	R410A
Grille			UTG-UFGA-W	UTG-UFGA-W	UTG-UFGA-W	UTG-UFGA-W	-	-

INVERTER

FLOOR/CEILING UNIVERSAL TYPE

NEW

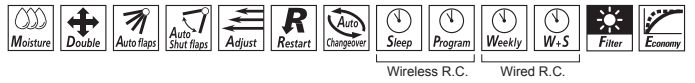

Rank **A** ALL DC V PAM

ABHA18L
 C 5.20kW/17,700BTU/h
 H 6.00kW/20,500BTU/h

Rank **A** ALL DC V PAM

ABHA24L
 C 7.10kW/24,200BTU/h
 H 8.00kW/27,300BTU/h



Remote controller is not supplied with the indoor unit. Separate purchase is necessary.



INVERTER

CEILING TYPE

NEW

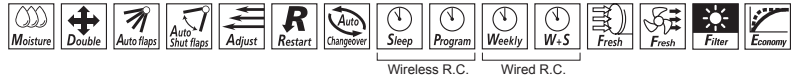

Rank **A** ALL DC i PAM

ABHA36L
 C 10.00kW/34,100BTU/h
 H 11.20kW/38,200BTU/h

Rank **A** ALL DC i PAM

ABHA45L
 C 12.50kW/42,700BTU/h
 H 14.00kW/47,800BTU/h

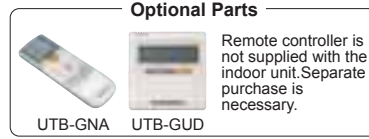

Remote controller is not supplied with the indoor unit. Separate purchase is necessary.



RANK A Rank **A**

FLOOR / CEILING UNIVERSAL TYPE

	ABHA18/24L	ABHA36/45L
EER (Cooling)	3.21	3.21
COP (Heating)	3.61	3.71

DUCT TYPE

	ARHA12L	ARHA14L	ARHA18/24L	ARHA36/45L
EER (Cooling)	3.33	3.21	3.21	3.21
COP (Heating)	3.69	3.71	3.61	3.71

ALL DC ALL DC



- a DC fan motor (Indoor units)
- b DC fan motor (Outdoor units)
- c DC twin rotary compressor

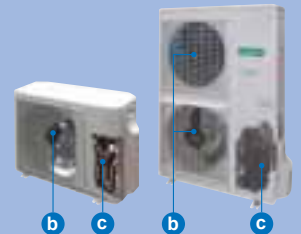
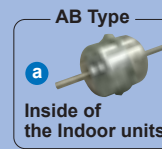

Multi auto swing, long distance airflow For CEILING TYPE

A combination of right/left and up/down directional swing allows 3-dimensional air direction control.

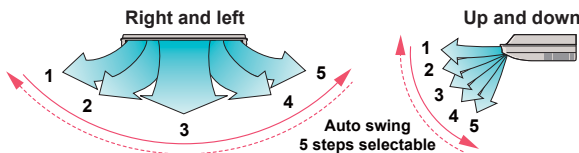

Long distance airflow Due to air blasting performance of maximum 18m, long-reach airflow is available for both cooling and heating operation.

Side View

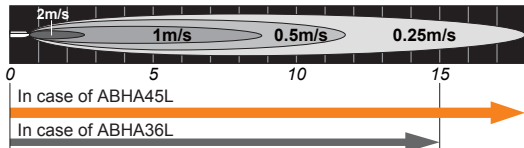

Fan speed : High
 Operation mode : FAN
 Vertical flap : Upward
 Horizontal flap : Center

Max.18m

For ARHA18/24L

High static pressure mode function

Responds to the wide static pressure range by 4-step static pressure mode.

Static pressure range
 12-18 type: 0 to 90Pa
 24 type: 30 to 150Pa

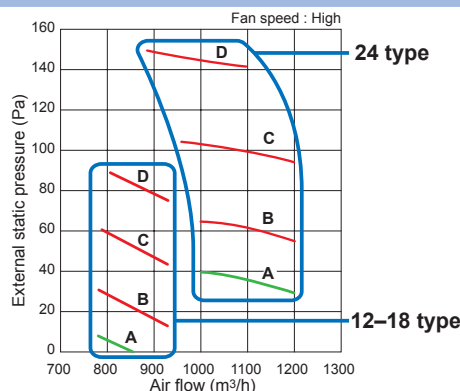

Static pressure setting

(Example : ARHA18 Type)

Conventional type

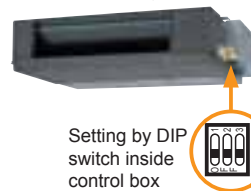

Setting by DIP switch inside control box

New type



Easy setting by wired remote controller



INVERTER

DUCT TYPE



ARHA12L
 C 3.50kW/11,950BTU/h
 H 4.10kW/14,000BTU/h



ARHA14L
 C 4.30kW/14,650BTU/h
 H 5.00kW/17,050BTU/h



ARHA18L
 C 5.20kW/17,700BTU/h
 H 6.00kW/20,500BTU/h

Optional Parts



Remote controller is not supplied with the indoor unit. Separate purchase is necessary.

UTB-GUD



ARHA24L



ARHA24L
 C 7.10kW/24,200BTU/h
 H 8.00kW/27,300BTU/h



ARHA36L
 C 10.00kW/34,100BTU/h
 H 11.20kW/38,200BTU/h



ARHA45L
 C 12.50kW/42,700BTU/h
 H 14.00kW/47,800BTU/h

ARHA36/45L



Optional Parts



Remote controller is not supplied with the indoor unit. Separate purchase is necessary.

UTB-GUD



Comfortable remote control performance

Three functions are combined in one unit.

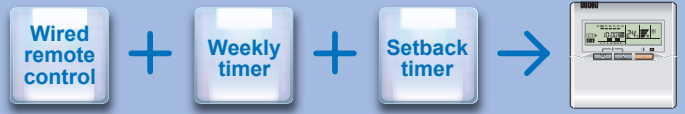

Built-in timers

Weekly timer

Possible to set ON/OFF time to operate twice each day of the week.



Easy-to-understand time bar display

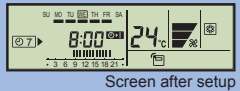

Screen after setup

Setup screen example
 (Set to Wednesday: 8:00 to 20:00.)

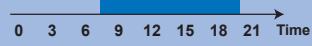

Setback timer

Possible to set temperature for two time spans and for each day of the week.



Setup screen example
 (Set from Sunday to Saturday: 12:00 to 15:00, 28°C.)

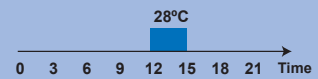

At "Weekly timer" + "Set back timer" setup

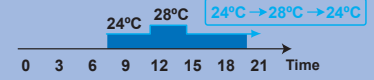

SPECIFICATIONS

SPECIFICATIONS		FLOOR/CEILING TYPE		CEILING TYPE		DUCT TYPE							
Item	Model No.	Indoor Unit	Outdoor Unit	AOHA18L	AOHA24L	AOHA36L	ABHA45L	ARHA12L	ARHA14L	ARHA18L	ARHA24L	ARHA36L	ARHA45L
Rank (Cooling/Heating)				A/A	A/A	A/A	A/A	A/A	A/A	A/A	A/A	A/A	A/A
Capacity	Cooling	kW		5.20	7.10	10.00	12.50	3.50	4.30	5.20	7.10	10.00	12.50
				6.00	8.00	11.20	14.00	4.10	5.00	6.00	8.00	11.20	14.00
	Heating	BTU/h		17,700	24,200	34,100	42,700	11,950	14,650	17,700	24,200	34,100	42,700
				20,500	27,300	38,200	47,800	14,000	17,050	20,500	27,300	38,200	47,800
Moisture Removal		l/h	2.0	2.7	3.0	4.5	1.3	1.5	2.0	2.5	3.0	3.5	
Room Air Circulation (High)	Inner	m ³ /h		780	980	1,900	2,100	720	820	820	1,100	2,020	2,250
			Outer	2,000	2,470	6,600	6,600	1,780	1,910	2,000	2,470	6,600	6,600
Input Power		V/ø/Hz	230/1/50	230/1/50	230/1/50	230/1/50	230/1/50	230/1/50	230/1/50	230/1/50	230/1/50	230/1/50	230/1/50
Running Current	Cooling	A		7.10	9.70	13.6	17.0	4.6	5.8	7.10	9.70	13.6	17.0
			Heating	7.30	9.70	13.2	16.5	4.9	5.9	7.30	9.70	13.2	16.5
Power Consumption	Cooling	kW		1.62	2.21	3.11	3.89	1.05	1.33	1.62	2.21	3.11	3.89
			Heating	1.66	2.21	3.02	3.77	1.11	1.34	1.66	2.21	3.02	3.77
EER	Cooling	kW/kW		3.21	3.21	3.21	3.21	3.33	3.21	3.21	3.21	3.21	3.21
COP	Heating			3.61	3.61	3.71	3.71	3.69	3.71	3.61	3.61	3.71	3.71
Dimensions H x W x D	Inner	mm		199x990x655	199x990x655	240x1,660x700	240x1,660x700	217x953x595	217x953x595	217x953x595	270x1,135x700	270x1,135x700	270x1,135x700
		kg(lbs)		27(60)	27(60)	44(97)	44(97)	23(51)	23(51)	23(51)	38(84)	41(90)	41(90)
		Outer	mm		578x790x300	578x790x315	1,290x900x330	1,290x900x330	578x790x300	578x790x300	578x790x300	578x790x315	1,290x900x330
Net Weight	Outer	kg(lbs)		40(88)	44(97)	98(216)	98(216)	40(88)	40(88)	40(88)	44(97)	98(216)	98(216)
		Connection Method		Flare	Flare	Flare	Flare	Flare	Flare	Flare	Flare	Flare	Flare
Connection Pipe Size (Smallø/Largeø)		mm		6.53/12.70	6.53/15.88	9.52/15.88	9.52/15.88	6.35/9.52	6.35/12.70	6.35/12.70	6.35/15.88	9.52/15.88	9.52/15.88
Max Pipe Length /Height Difference	m			25	30	50	50	25	25	25	30	50	50
				15	20	30	30	15	15	15	20	30	30
Permissible Range of Outdoor Temp.	Cooling	°C		-10~46	-10~46	-15~46	-15~46	-10~46	-10~46	-15~46	-15~46	-15~46	-15~46
			Heating		-15~24	-15~24	-15~24	-15~24	-15~24	-15~24	-15~24	-15~24	-15~24
Refrigerant				R410A	R410A	R410A	R410A	R410A	R410A	R410A	R410A	R410A	R410A

MULTI TYPE SYSTEMS

You can select any type of air conditioners as you like to suit the atmosphere of your room.



Energy Saving

High Efficiency DC Inverter Multi system permits energy saving operation and 40% higher efficiency than a Constant-Speed system. Improved Inverter cooling ratio prevents decrease in capacity under overload operation.

Energy Saving Over a Year's Time



DC Twin Rotary Compressor

Efficiency is improved over a wide range from high-speed rotation at high load up to the low-speed rotation region at low-load where long-term use is especially frequent, and high power is produced with little power consumption. Also, twin rotor provides low-vibration and quiet operation.

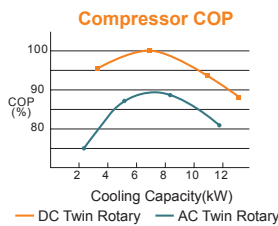

Flexible Installation

The outdoor unit can be installed in a wide range of properties by the long piping of 30m (gas charge less) for AOH18/24LM2, 50m (gas charge less up to 30m) for AOH18/24LAT3 and 70m (gas charge less up to 40m) for AOH30LM4.

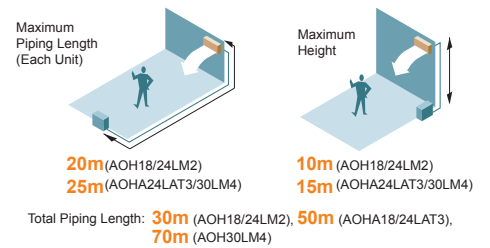

SPECIFICATIONS			INVERTER MULTI-TYPE SYSTEMS					
Model No.	Indoor Unit		ABH14LB ARH9LU, ARH12/14LU AUH12/14LB ASH7/9/12LM	ABH14/18LB ARH9LU, ARH12/14/18LU AUH12/14/18LB ASH7/9/12LM ASH18LB	ABH14LB ARH9LU, ARH12/14LU AUH12/14LB ASH7/9/12LM ASHA14LA	ABH14/18LB ARH9LU, ARH12/14/18LU AUH12/14/18LB ASH7/9/12LM ASHA14/18LA	ABH14/18/24LB ARH9LU, ARH12/14/18/22LU AUH12/14/18LB ASH7/9/12LM ASH18/24LB	
Item	Outdoor Unit		AOH18LM2	AOH24LM2	AOHA18LAT3	AOHA24LAT3	AOH30LM4	
Standard combination indoor unit			ARH14LU+ARH9LU	ASH18LB+ASH12LM	ASHA14LA+ASH7LM x2	ASHA14LA+ASH9LM x2	ASH18LB+ASH9LM x3	
Rank (Cooling/Heating)			B / B	A / A	A / A	A / A	A / A	
Capacity	Cooling	kW	5.50	5.80	5.40	6.80	8.00	
			6.40	6.40	6.80	8.00	9.60	
	Heating	BTU/h	18,800	19,800	18,400	23,200	27,300	
			21,800	21,800	23,200	27,300	32,800	
Moisture Removal	l/h		-	-	-	-	-	
Room Air Circulation (High)	Inner	m ³ /h	-	-	-	-	-	
	Outer		2,800	2,800	3,050	3,300	3,500	
Input Power	V/ø/Hz		230/1/50	230/1/50	230/1/50	230/1/50	230/1/50	
Running Current	Cooling	A	7.50	7.60	5.90	8.50	9.70	
	Heating		8.00	7.20	7.10	8.80	10.5	
Power Consumption	Cooling	kW	1.73	1.73	1.35	1.94	2.22	
	Heating		1.84	1.64	1.62	2.00	2.40	
EER	Cooling	kW/kW	3.18	3.35	4.00	3.50	3.60	
COP	Heating		3.48	3.90	4.20	4.00	4.00	
Dimensions H x W x D	Inner	mm	[ABH14/18/24]199x990x655 [AUH12*14*/18*]235x580x580(+70) [ARH9]217x665x595 [ARH12/14/18/22]217x953x595 [ASH7/9/12]257x808x187 [ASH18/24]320x1,120x220 [ASHA14/18]275x790x215					
			kg(lbs)	[ABH14/18/24]28(62) [AUH12/14/18]18(38) [ARH9]18(38) [ARH12/14]25(55) [ARH18/22]26(57) [ASH7/9/12]8(18) [ASH18/24]16(35) [ASHA14/18]9(20)				
Net Weight	Outer	mm		650x830x320	650x830x320	700x900x330	700x900x330	835x900x330
	kg(lbs)	56(123)	56(123)	55(121)	55(121)	68(150)		
Connection Method			Flare	Flare	Flare	Flare	Flare	
Connection Pipe Size (Small ø/Large ø)	mm		6.35/9.52, 12.70	6.35/9.52, 12.70	6.35/9.52, 12.70	6.35/9.52, 12.70	6.35/9.52, 12.70	
Max Pipe Length(Total)	m		30	30	50	50	70	
Height Difference			10	10	10	10	10	
Permissible Range of Outdoor Temp.	Cooling	°C	0~46	0~46	-10~46	-10~46	0~46	
	Heating		-10~21	-10~21	-15~24	-15~24	-10~24	
Refrigerant			R410A	R410A	R410A	R410A	R410A	

* Grille not included

DUCT TYPE

Easy maintenance with external control box.

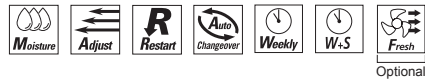

ARH12L
 C 3.5kW / 11,950BTU/h
 H 4.0kW / 13,700BTU/h



Universal type



Wired-Type
 (With Weekly/Setback Timer)



ARH14L
 C 4.3kW / 14,700BTU/h
 H 4.8kW / 16,400BTU/h

ARH18L
 C 5.20kW / 17,800BTU/h
 H 6.20kW / 21,200BTU/h



ARH24L
 C 7.10kW / 24,200BTU/h
 H 8.00kW / 27,300BTU/h

ARH30L
 C 8.50kW / 29,000BTU/h
 H 10.00kW / 34,100BTU/h

ARH36L
 C 10.00kW / 34,100BTU/h
 H 11.20kW / 38,200BTU/h

ARH45L
 C 12.50kW / 42,700BTU/h
 H 14.00kW / 47,800BTU/h



Wired-Type
 (With Weekly/Setback Timer)



For ARH24L



For ARH30/36L



For ARH45L

Installation styles (ARH24/30/36/45L)

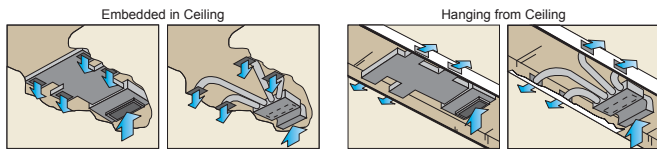

Slim & Compact design

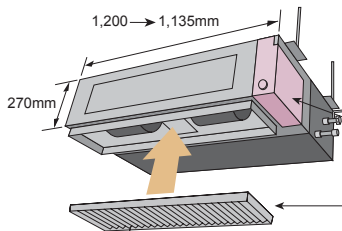

In the case of bottom suction type, as seen from lower rear part. In addition to the slim height of 270 mm which is our sales point, further compactification is attained by reducing 65mm from the width with the flanking controlbox embedded inside the chassis.

Control Box that has been convex shape is now united with main unit (DIP Switch is located on the internal substrate.)

One-touch operating and easy-to-install long-life filter (Optional Parts)

Easy maintenance

In the case of rear suction type, as seen from lower rear part

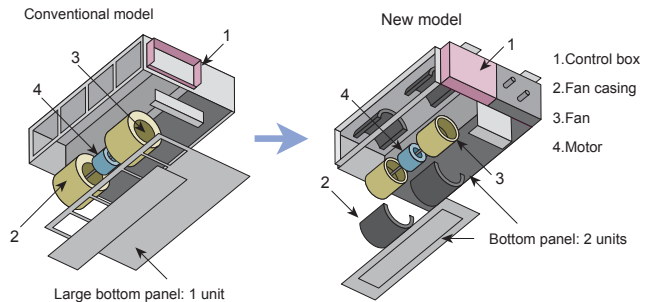

Structural improvement is attained by making the bottom panel two pieces, front and rear, and the internal fan casing is also made dismountable in two pieces, namely, upper and lower ones. The motor and fan maintenance and dismounting can be made easily by removing the rear panel and lower part of the casing with the main chassis installed.

Flexible installation (ARH12/14/18L)

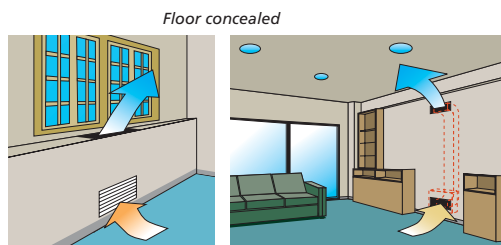
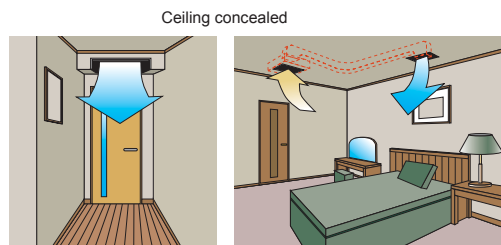

Optional function for comfort (ARH12/14/18L)

Optional parts



Simple remote controllers



Remote Sensor

- Simple remote controllers (UTB-GPB)
 Dimension(HxWxD):120x75x14mm
 Background light!!

- Remote sensor unit (UTD-RS100)

Optional parts

- Remote sensor unit _____ UTD-RS100
- Simple remote controller _____ UTB-GPB
- Flange (square) _____ UTD-SF045T
- Flange (round) _____ UTD-RF204
- Flexible duct _____ UTD-RD202
- Long life filter _____ UTD-LF25NA

Low static pressure mode function (ARH24/30/36/45L)

- 1.Low static pressure mode 1 air volume at 70Pa (fan speed:high)
- 2.Normal Mode Air volume at 100Pa (fan speed:high)

When installed, normal middle static pressure mode and low static pressure mode can be selected by switching over using DIP switch on the board in the control box. Therefore, these models can be operated under the wide range of conditions.

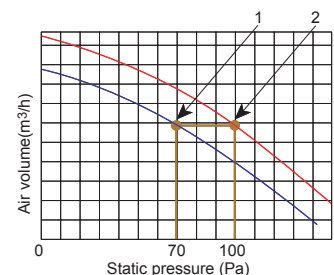

Other features

- Air intake position is selectable. (Rear or Bottom)
- Air outlet shape is selectable at the time of purchase. (Round or Square)
- Drain pipe position is selectable. (Right or Left)
- Fresh air can be taken in.



Wired-Type
(With Weekly/Setback Timer)



ARH45LH
 C 12.50kW / 42,700BTU/h
 H 14.00kW / 47,800BTU/h

ARH54L
 C 14.00kW / 47,800BTU/h
 H 16.00kW / 54,600BTU/h

Easy installation (Compact size & Lightweight)

By downsizing basic chassis and reducing materials weight, compact size and lightweight are realized.

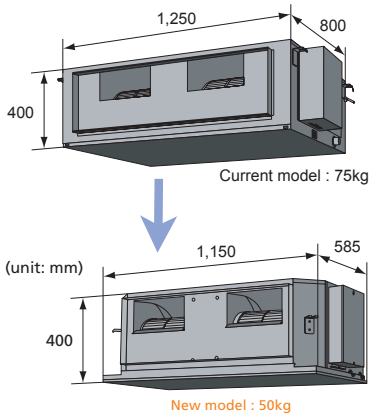

Pursuance of amenity performance

Various remote controllers and sensors can be selected.

1. Wired Remote Controller with Thermo Sensor

- Room temperature sensor selection
- WEEKLY timer
- Temperature SET BACK timer
- Group control system
- Child lock
- Dual remote controllers <optional parts>
- AUTO restart
- Energy saving
- Auto changeover <for heating>
- Hot start <for heating>

2. Simple Remote Controller (Optional Parts)

3. Remote Sensor (Optional Parts)

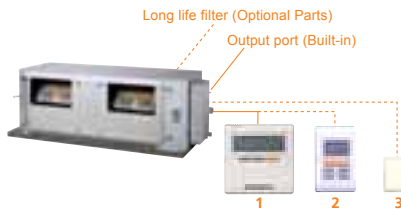

Operation sound (Low noise)

Turbulent air flow is reduced by cutting off the corners of conventional indoor unit front panel and fan case. Uniform internal air pressure makes the noise decreased down to 41 dB (ARH45LH) and 42 dB (ARH54L).

- Large air flow volume of 1,900m³ (ARH45LH) and 3,000m³ (ARH54L) is realized by adopting large fan. (At 100Pa)
- Low noise is realized by adopting plastic case, plastic fan, and 3-step airflow volume switch.
- The noise is decreased by the plastic fan.
- Sirocco fan for airflow and indoor unit fan casing are processed by plastic.

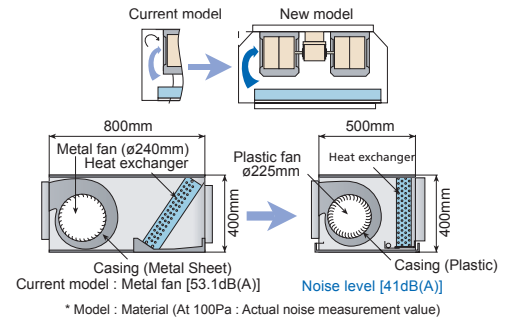

SPECIFICATIONS			INVERTER DUCT TYPE								
Model No.	Indoor Unit		ARH12L	ARH14L	ARH18L	ARH24L	ARH30L	ARH36L	ARH45L	ARH45LH	ARH54L
Item	Outdoor Unit		AOH12L	AOH14L	AOH18L	AOH24L	AOH30L	AOH36L	AOH45L	AOH45LH	AOH54L
Rank (Cooling/Heating)			B / D	B / C	B / C	C / C	C / A	E / B	-	-	-
Capacity	Cooling	kW	3.50	4.30	5.20	7.10	8.50	10.00	12.50	12.50	14.00
		BTU/h	11,950	14,700	17,800	24,200	29,000	34,100	42,700	42,700	47,800
	Heating	kW	4.00	4.80	6.20	8.00	10.00	11.20	14.00	14.00	16.00
		BTU/h	13,700	16,400	21,200	27,300	34,100	38,200	47,800	47,800	54,600
Moisture Removal		l/h	1.2	1.5	1.7	1.5	2.5	3.0	4.0	3.0	4.0
Room Air Circulation (High)	Inner	m ³ /h	580	780	800	1,490	2,200	2,200	2,290	3,500	3,500
	Outer	m ³ /h	2,800	2,800	2,800	2,800	3,600	3,600	6,600	6,600	6,600
Input Power	V/ø/Hz		230/1/50	230/1/50	230/1/50	230/1/50	230/1/50	230/1/50	230/1/50	230/1/50	230/1/50
Running Current	Cooling	A	5.1	6.0	7.4	11.1	13.0	17.9	19.5	18.9	23.6
	Heating	A	5.8	6.5	8.3	10.6	11.7	13.9	17.3	16.7	20.6
Power Consumption	Cooling	kW	1.15	1.37	1.70	2.53	2.96	4.08	4.45	4.30	5.36
	Heating	kW	1.32	1.49	1.90	2.43	2.68	3.18	3.95	3.80	4.70
EER	Cooling	kW/kW	3.04	3.14	3.06	2.81	2.87	2.45	2.81	2.91	2.61
COP	Heating	kW/kW	3.03	3.21	3.26	3.29	3.73	3.52	3.54	3.68	3.40
Dimensions H x W x D	Inner	mm	217x953x595	217x953x595	217x953x595	270x1135x700	270x1135x700	270x1135x700	270x1135x700	400x1150x585	400x1150x585
		kg(lbs)	25(55)	25(55)	25(55)	41(90)	43(95)	43(95)	45(99)	50(110)	50(110)
Net Weight	Outer	mm	650x830x320	650x830x320	650x830x320	650x830x320	835x900x330	835x900x330	1,295x900x330	1290x900x330	1290x900x330
		kg(lbs)	54(119)	54(119)	54(120)	54(120)	64(141)	64(141)	105(231)	105(231)	105(231)
Connection Method			Flare	Flare	Flare	Flare	Flare	Flare	Flare	Flare	Flare
Connection Pipe Size (Smallø/Largeø)		mm	6.35/9.52	6.35/9.52	6.35/12.70	9.52/15.88	9.52/15.88	9.52/15.88	9.52/15.88	9.52/15.88	9.52/15.88
Max Pipe Length /Height Difference	m		25	25	25	25	50	50	70	70	70
			15	15	15	15	30	30	30	30	30
Permissible Range of Outdoor Temp.	Cooling	°C	0~43	0~43	0~43	0~43	-10~43	-10~43	-15~43	-15~43	-15~43
	Heating	°C	-10~24	-10~24	-10~24	-10~24	-10~24	-10~24	-15~24	-15~24	-15~24
Refrigerant			R410A	R410A	R410A	R410A	R410A	R410A	R410A	R410A	R410A

DUCT TYPE



- ARG7F**
C 2.15kW / 7,300BTU/h
- ARG7U**
C 2.15kW / 7,300BTU/h
H 2.45kW / 8,400BTU/h
- ARG9F**
C 2.80kW / 9,500BTU/h
- ARG9U**
C 2.70kW / 9,200BTU/h
H 3.10kW / 10,600BTU/h

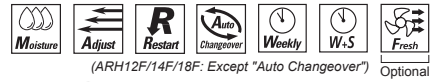

- ARG12F**
C 3.50kW / 11,900BTU/h
- ARG12U**
C 3.50kW / 11,900BTU/h
H 4.00kW / 13,600BTU/h
- ARG14F**
C 4.20kW / 14,300BTU/h
- ARG14U**
C 4.00kW / 13,700BTU/h
H 4.70kW / 16,000BTU/h
- ARG18F**
C 5.40kW / 18,400BTU/h
- ARG18U**
C 5.40kW / 18,400BTU/h
H 6.00kW / 20,500BTU/h



- ARG25F**
C 7.05kW / 24,000BTU/h
- ARG25U**
C 7.00kW / 23,900BTU/h
H 7.70kW / 26,300BTU/h
- ARG30F**
C 8.40kW / 28,700BTU/h
- ARG30U**
C 8.40kW / 28,700BTU/h
H 9.50kW / 32,400BTU/h
- ARG36F**
C 10.50kW / 35,800BTU/h
- ARG36U**
C 10.50kW / 35,800BTU/h
H 12.70kW / 43,400BTU/h
- ARG36U(1)**
C 10.50kW / 35,800BTU/h
H 12.70kW / 43,400BTU/h
- ARG45F**
C 12.70kW / 43,400BTU/h
- ARG45U**
C 12.70kW / 43,400BTU/h
H 14.30kW / 48,800BTU/h

SPECIFICATIONS			DUCT TYPE											
Model No.	Indoor Unit		ARG7F	ARG7U	ARG9F	ARG9U	ARG12F	ARG12U	ARG14F	ARG14U	ARG18F	ARG18U	ARG25F	
Item	Outdoor Unit		AOG7F	AOG7U	AOG9F	AOG9U	AOG12F	AOG12U	AOG14F	AOG14U	AOG18F	AOG18U	AOG25F	
Rank (Cooling/Heating)			C / -	C / C	C / -	C / C	C / -	C / C	B / -	C / B	D / -	C / C	D / -	
Capacity	Cooling	kW	2.15	2.15	2.80	2.70	3.50	3.50	4.20	4.00	5.40	5.40	7.05	
		BTU/h	7,300	7,300	9,500	9,200	11,900	11,900	14,300	13,700	18,400	18,400	24,000	
	Heating	kW	-	2.45	-	3.10	-	4.00	-	4.70	-	6.00	-	
		BTU/h	-	8,400	-	10,600	-	13,600	-	16,000	-	20,500	-	
Moisture Removal		l/h	0.8	0.8	1.0	1.0	1.2	1.2	1.5	1.5	1.6	1.6	2.5	
Room Air Circulation (High)	Inner	m ³ /h	340	340	420	420	500	500	640	640	1,000	1,000	1,100	
	Outer	m ³ /h	1,600	1,600	1,600	1,600	1,600	1,600	1,600	1,600	3,200	3,200	3,200	
Input Power		V/ø/Hz	230/1/50	230/1/50	230/1/50	230/1/50	230/1/50	230/1/50	230/1/50	230/1/50	230/1/50	230/1/50	230/1/50	
Running Current	Cooling	A	3.7	3.6	4.6	4.4	5.5	5.5	6.3	6.3	9.0	8.8	11.5	
	Heating	A	-	3.6	-	4.5	-	5.4	-	6.0	-	8.7	-	
Power Consumption	Cooling	kW	0.76	0.76	0.99	0.96	1.24	1.24	1.39	1.42	2.03	1.92	2.60	
	Heating	kW	-	0.76	-	0.96	-	1.21	-	1.35	-	1.87	-	
EER	Cooling	kw/kW	2.83	2.83	2.83	2.81	2.82	2.82	3.02	2.82	2.66	2.81	2.71	
COP	Heating	kw/kW	-	3.22	-	3.23	-	3.31	-	3.48	-	3.21	-	
Dimensions H x W x D	Inner	mm	217x663x595	217x663x595	217x663x595	217x663x595	217x953x595	217x953x595	217x953x595	217x953x595	217x953x595	217x953x595	217x953x595	270x1,135x700
		kg(lbs)	18(40)	18(40)	18(40)	18(40)	25(55)	25(55)	25(55)	25(55)	25(55)	25(55)	25(55)	43(95)
Net Weight	Outer	mm	530x750x250	530x750x250	530x750x250	530x750x250	530x750x250	530x750x250	530x750x250	530x750x250	650x830x320	650x830x320	650x830x320	
		kg(lbs)	27(60)	28(62)	27(60)	30(66)	34(75)	34(75)	35(77)	35(77)	52(115)	52(115)	58(128)	
Connection Method			Flare	Flare	Flare	Flare	Flare	Flare	Flare	Flare	Flare	Flare	Flare	
Connection Pipe Size (Smallø/Largeø)		mm	6.35/9.52	6.35/9.52	6.35/9.52	6.35/9.52	6.35/9.52	6.35/9.52	6.35/12.70	6.35/12.70	6.35/15.88	6.35/15.88	9.52/15.88	
Max Pipe Length /Height Difference	m		15	15	15	15	15	15	15	15	20	20	25	
			8	8	8	8	8	8	8	8	8	8	15	
Permissible Range of Outdoor Temp.	Cooling	°C	21~43	0~43	21~43	0~43	21 to 43	0~43	21~43	0~43	21~43	0~43	0~43	
	Heating	°C	-	-6~24	-	-6~24	-	-6~24	-	-6~24	-	-6~24	-	
Refrigerant			R410A	R410A	R410A	R410A	R410A	R410A	R410A	R410A	R410A	R410A	R410A	



ARG60F
 C 16.50kW / 56,300BTU/h

ARG60U
 C 16.50kW / 56,300BTU/h
 H 19.50kW / 66,600BTU/h



ARG90E
 C 25.40-25.40kW / 86,700-86,700BTU/h

ARG90T
 C 24.80-25.40kW / 84,700-86,700BTU/h
 H 28.90-29.50kW / 98,500-100,500BTU/h

Accurate and Comfortable

- New amenity space can be offered by installing the thermo sensor in the remote controller.
- Because the remote controller has the switching function, the user can select the position of the sensor. (Room temperature sensor selection)

Example of room temperature sensor selection

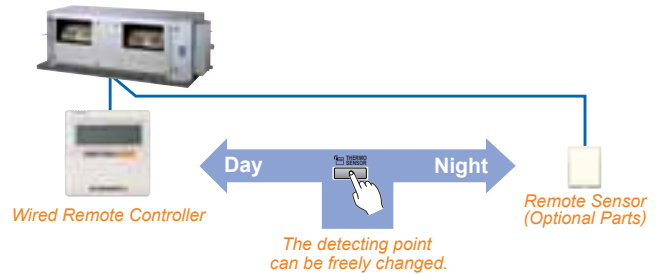
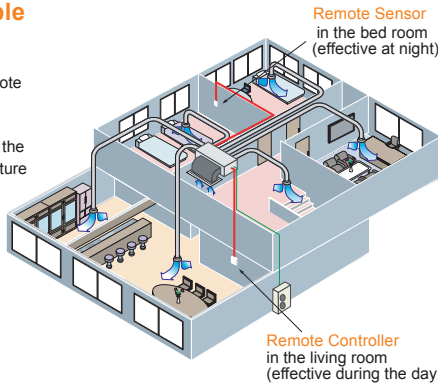
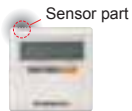

DUCT TYPE											
ARG25U	ARG30F	ARG30U	ARG36F	ARG36U(1)	ARG36U	ARG45F	ARG45U	ARG60F	ARG60U	ARG90E	ARG90T
AOG25U	AOG30F	AOG30U	AOG36F	AOG36U(1)	AOG36U	AOG45F	AOG45U	AOG60F	AOG60U	AOG90E	AOG90T
D / C	C / -	C / A	D / -	C / B	C / B	-	-	-	-	-	-
7.00	8.40	8.40	10.50	10.50	10.50	12.70	12.70	16.50	16.50	25.40~25.40	24.80~25.40
7.70	-	9.50	-	12.70	12.70	-	14.30	-	19.50	-	28.90~29.50
24,000	28,700	28,700	35,800	35,800	35,800	43,400	43,400	56,300	56,300	86,700~86,700	84,700~86,700
26,300	-	32,400	-	43,400	43,400	-	48,800	-	66,600	-	98,500~100,500
2.5	3.0	3.0	3.5	3.5	3.5	5.0	5.0	4.0	4.0	7.5	7.5
1,100	1,400	1,400	1,750	1,750	1,750	1,800	1,800	3,500	3,500	4,300	4,300
3,200	3,300	3,300	7,000	6,100	6,100	6,100	6,100	6,300	6,300	9,800	9,800
230/1/50	230/1/50	230/1/50	400/3/50	230/1/50	400/3/50	400/3/50	400/3/50	400/3/50	400/3/50	380~415/3/50	380~415/3/50
11.8	14.0	14.0	6.4	16.0	6.1	7.7	7.7	10.0	10.2	17.5~17.0	19.5~19.5
10.5	-	12.4	-	16.5	6.2	-	7.7	-	9.8	-	19.5~19.5
2.65	2.99	2.99	3.85	3.60	3.60	4.38	4.38	5.93	6.06	10.5~10.5	12.2~12.5
2.33	-	2.63	-	3.65	3.65	-	4.39	-	5.54	-	12.2~12.5
2.64	2.81	2.81	2.73	2.92	2.96	2.90	2.90	2.78	2.72	2.42~2.42	2.03~2.03
3.30	-	3.61	-	3.48	3.48	-	3.26	-	3.52	-	2.37~2.36
270x1,135x700	270x1,135x700	270x1,135x700	270x1,135x700	270x1,135x700	270x1,135x700	270x1,135x700	270x1,135x700	400x1150x585*	400x1150x585*	450x1,550x700	450x1,550x700
43(95)	43(95)	43(95)	43(95)	43(95)	43(95)	45(99)	45(99)	50(110)	50(110)	85(187)	85(187)
650x830x320	830x900x330	830x900x330	1,165x900x330	1,165x900x330	1,165x900x330	1,165x900x330	1,165x900x330	1,290x900x330	1,290x900x330	1,380x1,300x650	1,380x1,300x650
59(130)	69(152)	69(152)	80(176)	98(216)	94(207)	109(240)	113(249)	118(260)	118(260)	243(535)	245(539)
Flare	Flare	Flare	Flare	Flare	Flare	Flare	Flare	Flare	Flare	Flare(Small)/Flare(Large)	Flare(Small)/Flare(Large)
9.52/15.88	9.52/15.88	9.52/15.88	9.52/15.88	9.52/15.88	9.52/15.88	9.52/19.05	9.52/19.05	9.52/19.05	9.52/19.05	12.70-28.58	12.70-28.58
25	30	30	50	50	50	50	50	50	50	50	50
15	15	15	30	30	30	30	30	30	30	30	30
0~43	0~43	0~43	0~43	0~43	0~43	0~43	0~43	0~43	0~43	0~52	0~46
-7~-24	-	-7~-24	-	-10~-24	-10~-24	-10~-24	-10~-24	-	-10~-24	-	-10~-21
R410A	R410A	R410A	R410A	R410A	R410A	R410A	R410A	R410A	R410A	R407C	R407C

* Including flange, control box, safety drain pan

INVERTER

CASSETTE TYPE



AUH12L **AUH14L** **AUH18L**
 C 3.5kW / 11,950BTU/h C 4.0kW / 13,700BTU/h C 4.70kW / 16,000BTU/h
 H 4.0kW / 13,700BTU/h H 4.5kW / 15,700BTU/h H 4.80kW / 16,400BTU/h

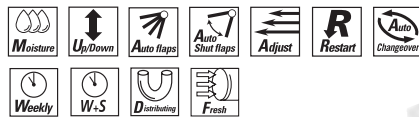

AUH24L **AUH30L** **AUH36L** **AUH45L** **AUH54L**
 C 7.10kW / 24,200BTU/h C 8.50kW / 29,000BTU/h C 10.0kW / 34,100BTU/h C 12.5kW / 42,700BTU/h C 13.3kW / 45,400BTU/h
 H 7.80kW / 26,600BTU/h H 10.0kW / 34,100BTU/h H 11.2kW / 38,200BTU/h H 14.0kW / 47,800BTU/h H 16.0kW / 54,600BTU/h

AUH24L
 C 7.10kW / 24,200BTU/h
 H 7.80kW / 26,600BTU/h

AUH30L
 C 8.50kW / 29,000BTU/h
 H 10.0kW / 34,100BTU/h

AUH36L
 C 10.0kW / 34,100BTU/h
 H 11.2kW / 38,200BTU/h

AUH45L
 C 12.5kW / 42,700BTU/h
 H 14.0kW / 47,800BTU/h

AUH54L
 C 13.3kW / 45,400BTU/h
 H 16.0kW / 54,600BTU/h

Compact size (AUH12/14/18L)
 Compact grille fits European ceiling panel (650 x 650 mm).

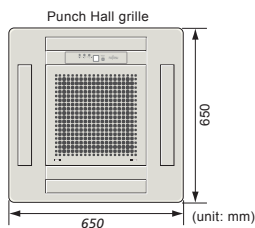

Easy maintenance (AUH24/30/36/45/54L)
 The control box is easily accessible for maintenance work. Wide opening for easy access.

Detachable, washable filter and intake grille.
 Wide opening and long-life filter.

Long-life filter
 High efficiency, long-life filter extends the cleaning cycle.

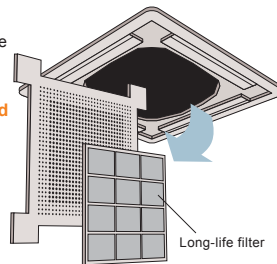

Duct connection hole opening

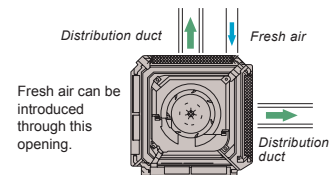

Conditioned air can be distributed by means of a distribution duct.

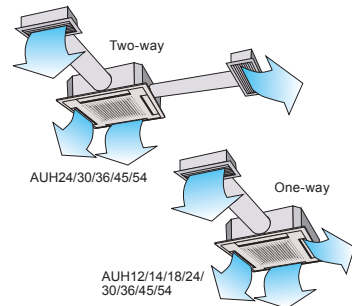

Condensate pump

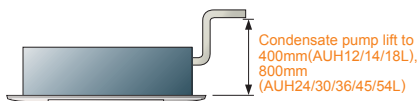

Pursuance of amenity performance (AUH24/30/36/45/54L)

Various remote controllers and sensors can be selected.

Wired Remote Controller with Thermo Sensor

- Room temperature sensor selection
- Temperature SET BACK timer
- Group control system
- Child lock
- Dual remote controllers <optional>
- Hot start <for heating>

SPECIFICATIONS			INVERTER CASSETTE TYPE									
Model No.	Indoor Unit		AUH12L	AUH14L	AUH18L	AUH24L	AUH30L	AUH36L	AUH45L	AUH54L		
Item	Outdoor Unit		AOH12L	AOH14L	AOH18L	AOH24L	AOH30L	AOH36L	AOH45L	AOH54L		
Rank (Cooling/Heating)			B / D	C / E	C / D	C / C	C / B	E / C	-	-		
Capacity	Cooling	kW	3.50	4.00	4.70	7.10	8.50	10.00	12.50	13.30		
			4.00	4.50	4.80	7.80	10.00	11.20	14.00	16.00		
	Heating	BTU/h	11,950	13,700	16,000	24,200	29,000	34,100	42,700	45,400		
			13,700	15,700	16,400	26,600	34,100	38,200	48,000	54,600		
Moisture Removal	l/h		1.3	1.5	2.0	2.0	3.0	4.0	4.5	5.5		
Room Air Circulation (High)	Inner	m ³ /h	550	550	620	1,250	1,550	1,550	1,700	1,700		
	Outer		2,800	2,800	2,800	3,200	3,600	3,600	6,600	6,600		
Input Power	V/ø/Hz		230/1/50	230/1/50	230/1/50	230/1/50	230/1/50	230/1/50	230/1/50	230/1/50		
Running Current	Cooling	A	5.1	6.0	7.2	11.1	12.5	17.6	19.5	23.8		
	Heating		6.1	7.2	7.5	10.5	12.4	15.2	17.3	21.6		
Power Consumption	Cooling	kW	1.16	1.36	1.65	2.53	2.86	4.00	4.45	5.54		
	Heating		1.40	1.65	1.71	2.40	2.84	3.49	3.95	4.95		
EER	Cooling		3.02	2.94	2.85	2.81	2.97	2.49	2.81	2.44		
COP	Heating		2.86	2.73	2.81	3.25	3.52	3.21	3.54	3.23		
Dimensions H x W x D	Inner	mm	235x580x580(+66)	235x580x580(+66)	235x580x580(+66)	246x830x830	296x830x830	296x830x830	296x830x830	296x830x830		
		kg(lbs)	18(40)	18(40)	18(40)	34(75)	37(82)	37(82)	40(88)	40(88)		
Net Weight	Outer	mm	650x830x320	650x830x320	650x830x320	650x830x320	830x900x330	830x900x330	1,290x900x330	1,290x900x330		
		kg(lbs)	58(128)	58(128)	54(119)	54(119)	64(141)	64(141)	105(231)	105(231)		
Connection Method			Flare	Flare	Flare	Flare	Flare	Flare	Flare	Flare		
Connection Pipe Size (Smallø/Largeø)	mm		6.35/9.52	6.35/9.52	6.35/12.70	9.52/15.88	9.52/15.88	9.52/15.88	9.52/15.88	9.52/15.88		
Max Pipe Length /Height Difference	m		25	25	25	25	50	50	70	70		
			15	15	15	15	30	30	30	30		
Permissible Range of Outdoor Temp.	Cooling	°C	0~43	0~43	0~43	0~43	-10~43	-10~43	-15~43	-15~43		
	Heating		-10~24	-10~24	-10~24	-10~24	-10~24	-10~24	-15~24	-15~24		
Refrigerant			R410A	R410A	R410A	R410A	R410A	R410A	R410A	R410A		
Grille			UTG-UDYD-W	UTG-UDYD-W	UTG-UDYD-W	-	-	-	-	-		

CASSETTE TYPE



(AUG12/14/18F: Except "Auto Changeover")



For AUG12F/12U/14F/14U For AUG18F/18U

AUG12F C 3.60kW / 12,300BTU/h	AUG14F C 4.10kW / 14,000BTU/h	AUG18F C 5.00kW / 17,100BTU/h
AUG12U C 3.55kW / 12,100BTU/h H 4.00kW / 13,700BTU/h	AUG14U C 3.95kW / 13,500BTU/h H 4.60kW / 15,700BTU/h	AUG18U C 4.85kW / 16,600BTU/h H 5.40kW / 18,400BTU/h



(AUG25/30/36/45/54F/25F(3): Except "Auto Changeover")



Wired-Type
(with weekly / Setback Timer)



AUG25F
C 7.05kW / 24,100BTU/h

AUG25F(3)
C 7.05kW / 24,100BTU/h

AUG30F
C 8.40kW / 28,700BTU/h

AUG36F
C 10.50kW / 35,800BTU/h

AUG45F
C 12.70kW / 43,400BTU/h

AUG54F
C 14.50kW / 49,500BTU/h

AUG25U
C 7.00kW / 23,900BTU/h
H 7.80kW / 26,600BTU/h

AUG30U
C 8.40kW / 28,700BTU/h
H 9.50kW / 32,400BTU/h

AUG36U
C 10.50kW / 35,800BTU/h
H 11.80kW / 40,300BTU/h

AUG45U
C 12.70kW / 43,400BTU/h
H 14.30kW / 48,800BTU/h

AUG54U
C 14.50kW / 49,500BTU/h
H 16.50kW / 56,500BTU/h

SPECIFICATIONS			CASSETTE TYPE									
Model No.	Indoor Unit		AUG12F	AUG12U	AUG14F	AUG14U	AUG18F	AUG18U	AUG25F	AUG25U		
Item	Outdoor Unit		AOG12F	AOG12U	AOG14F	AOG14U	AOG18F	AOG18U	AOG25F	AOG25U		
Rank (Cooling/Heating)			C / -	C / C	C / -	C / C	D / -	D / E	D / -	D / C		
Capacity	Cooling	kW	3.60	3.55	4.10	3.95	5.00	4.85	7.05	7.00		
			Heating	-	4.00	-	4.60	-	5.40	-	7.80	
	Cooling	BTU/h	12,300	12,100	14,000	13,500	17,100	16,600	24,100	23,900		
			Heating	-	13,700	-	15,700	-	18,400	-	26,600	
Moisture Removal	l/h		1.3	1.3	1.5	1.5	2.1	2.1	2.5	2.5		
Room Air Circulation (High)	Inner	m ³ /h	550	550	550	550	620	620	1,100	1,100		
	Outer		1,600	1,600	1,600	1,600	3,400	3,200	3,200	3,200		
Input Power	V/ø/Hz		230/1/50	230/1/50	230/1/50	230/1/50	230/1/50	230/1/50	230/1/50	230/1/50		
Running Current	Cooling	A	5.5	5.5	6.3	6.3	8.5	8.2	11.5	11.8		
	Heating		-	5.4	-	6.3	-	9.2	-	10.5		
Power Consumption	Cooling	kW	1.24	1.24	1.39	1.40	1.90	1.85	2.60	2.65		
	Heating		-	1.21	-	1.42	-	2.00	-	2.35		
EER	Cooling		2.90	2.86	2.95	2.82	2.63	2.62	2.71	2.64		
COP	Heating		-	3.31	-	3.24	-	2.70	-	3.32		
Dimensions H x W x D	Inner	mm	235x580x580(+66)	235x580x580(+66)	235x580x580(+66)	235x580x580(+66)	235x580x580(+66)	235x580x580(+66)	246x830x830	246x830x830		
		kg(lbs)	18(40)	18(40)	18(40)	18(40)	18(40)	18(40)	34(75)	34(75)		
Net Weight	Outer	mm	530x750x250	530x750x250	530x750x250	530x750x250	650x830x320	650x830x320	650x830x320	650x830x320		
		kg(lbs)	34(75)	34(75)	35(77)	35(77)	52(115)	52(115)	58(128)	59(130)		
Connection Method			Flare	Flare	Flare	Flare	Flare	Flare	Flare	Flare		
Connection Pipe Size (Small/Largeø)	mm		6.35/9.52	6.35/9.52	6.35/12.7	6.35/12.7	6.35/12.7	6.35/12.7	9.52/15.88	9.52/15.88		
Max Pipe Length /Height Difference	m		20	20	20	20	20	20	25	25		
			8	8	8	8	8	8	15	15		
Permissible Range of Outdoor Temp.	Cooling	°C	21~43	0~43	21~43	0~43	0~43	0~43	0~43	0~43		
	Heating		-	-7~24	-	-7~24	-	-7~24	-	-7~24		
Refrigerant			R410A	R410A	R410A	R410A	R410A	R410A	R410A	R410A		
Grille			UTG-UDYD-W	UTG-UDYD-W	UTG-UDYD-W	UTG-UDYD-W	UTG-UDYD-W	UTG-UDYD-W	-	-		

CASSETTE TYPE								
AUG25F(3)	AUG30F	AUG30U	AUG36F	AUG36U	AUG45F	AUG45U	AUG54F	AUG54U
AOG25F(3)	AOG30F	AOG30U	AOG36F	AOG36U	AOG45F	AOG45U	AOG54F	AOG54U
C	C / -	C / B	C / -	B / C	-	-	-	-
7.05	8.40	8.40	10.50	10.50	12.70	12.70	14.50	14.50
-	-	9.50	-	11.80	-	14.30	-	16.50
24,100	28,700	28,700	35,800	35,800	43,400	43,400	49,500	49,500
-	-	32,400	-	40,300	-	48,800	-	56,500
2.5	3.0	3.0	4.0	4.0	5.0	5.0	6.0	6.0
1,100	1,250	1,250	1,500	1,500	1,550	1,550	1,700	1,700
3,200	3,300	3,300	7,000	6,100	6,100	6,100	6,300	6,300
230/3/50	230/1/50	230/1/50	400/3/50	400/3/50	400/3/50	400/3/50	400/3/50	400/3/50
11.5	13.6	13.6	6.2	5.9	7.7	7.7	9.5	9.5
-	-	13.1	-	6.2	-	7.7	-	9.5
2.60	2.95	2.95	3.74	3.48	4.38	4.38	5.16	5.16
-	-	2.78	-	3.65	-	4.39	-	5.30
2.71	2.85	2.85	2.81	3.02	2.90	2.90	2.81	2.81
-	-	3.42	-	3.23	-	3.26	-	3.11
246x830x830	246x830x830	246x830x830	296x830x830	296x830x830	296x830x830	296x830x830	296x830x830	296x830x830
34(75)	34(75)	34(75)	37(82)	37(82)	40(88)	40(88)	40(88)	40(88)
650x830x320	830x900x330	830x900x330	1,165x900x330	1,165x900x330	1,165x900x330	1,165x900x330	1,290x900x330	1,290x900x330
58(128)	68(150)	69(152)	80(176)	94(207)	109(240)	113(249)	114(251)	118(260)
Flare	Flare	Flare	Flare	Flare	Flare	Flare	Flare	Flare
9.52/15.88	9.52/15.88	9.52/15.88	9.52/15.88	9.52/15.88	9.52/19.05	9.52/19.05	9.52/19.05	9.52/19.05
25	30	30	50	50	50	50	50	50
15	15	15	30	30	30	30	30	30
0~43	0~43	0~43	0~43	0~43	0~43	0~43	0~43	0~43
-	-	-7~24	-	-10~24	-	-10~24	-	-10~24
R410A	R410A	R410A	R410A	R410A	R410A	R410A	R410A	R410A
-	-	-	-	-	-	-	-	-

INVERTER

FLOOR/CEILING UNIVERSAL TYPE

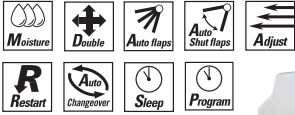

ABH18L
 C 5.20kW / 17,800BTU/h
 H 6.20kW / 21,200BTU/h

ABH24L
 C 6.50kW / 22,200BTU/h
 H 6.80kW / 23,200BTU/h

INVERTER

CEILING TYPE



ABH30L
 C 8.50kW / 29,000BTU/h
 H 10.0kW / 34,100BTU/h

ABH36L
 C 10.0kW / 34,100BTU/h
 H 10.8kW / 36,900BTU/h

ABH45L
 C 12.5kW / 42,700BTU/h
 H 14.0kW / 47,800BTU/h

Ultra thin and wide air flow design for elegance and comfort
 (ABH30/36/45L)



Features of new outdoor unit

- Low noise realized**
 Low noise realized by reducing the air flow resistance by fan shape (large metal plate integrated bell mouth) and system (external fan guard). Consideration is given to quieting of the living space of neighbors.
- Improved installation and maintenance**
 - Check joint standard equipment**
 Service port is provided at the high pressure side of the refrigerant circuit. The state of the product can be checked by connecting a pressure gauge, etc. and work efficiency at installation and maintenance is improved.
 - Improvement of handling performance during installation**
 The new outdoor unit is equipped with handles at the front and back at about the same height at the left and right so that the unit can be easily carried in during installation, etc.



ABH36F/U, 45F/U

SPECIFICATIONS			FLOOR / CEILING UNIVERSAL TYPE							
Model No.	Indoor Unit		ABH18L	ABH24L	ABG14F	ABG14U	ABG18F	ABG18U	ABG24F	ABG24U
Item	Outdoor Unit		AOH18L	AOH24L	AOG14F	AOG14U	AOG18F	AOG18U	AOG24F	AOG24U
Rank			B / C	B / B	B / -	C / B	C / -	B / C	D / -	D / C
Capacity	Cooling	kW	5.20	6.50	4.20	4.00	5.40	5.40	6.50	6.50
			6.20	6.80	-	4.70	-	6.00	-	7.40
	Heating	BTU/h	17,800	22,200	14,300	13,700	18,400	18,400	22,200	22,200
			21,200	23,200	-	16,000	-	20,500	-	25,300
Moisture Removal		l/h	1.7	2.5	1.5	1.5	2.0	2.0	2.5	2.5
Room Air Circulation (High)	Inner	m ³ /h	780	880	640	640	780	780	880	880
	Outer	m ³ /h	2,800	3,320	1,600	1,600	3,200	3,200	3,200	3,200
Input Power		V/ø/Hz	230/1/50	230/1/50	230/1/50	230/1/50	230/1/50	230/1/50	230/1/50	230/1/50
Running Current	Cooling	A	7.4	9.4	6.3	6.3	8.5	8.6	11.0	10.8
	Heating		8.3	8.7	-	6.0	-	8.3	-	10.3
Power Consumption	Cooling	kW	1.70	2.15	1.39	1.42	1.92	1.90	2.45	2.42
	Heating		1.90	1.99	-	1.35	-	1.85	-	2.30
EER	Cooling	kW/kW	3.06	3.02	3.02	2.82	2.81	2.84	2.65	2.69
COP	Heating		3.26	3.42	-	3.48	-	3.24	-	3.22
Dimensions H x W x D	Inner	mm	199x990x655	199x990x655	199x990x655	199x990x655	199x990x655	199x990x655	199x990x655	199x990x655
			kg(lbs)	28(62)	28(62)	28(62)	28(62)	28(62)	28(62)	28(62)
Net Weight	Outer	mm	650x830x320	900x900x350	530x750x250	530x750x250	650x830x320	650x830x320	650x830x320	650x830x320
			kg(lbs)	54(119)	70(154)	35(77)	35(77)	47(104)	52(115)	58(128)
Connection Method			Flare	Flare	Flare	Flare	Flare	Flare	Flare	Flare
Connection Pipe Size (Smallø/Largeø)		mm	6.35/12.70	9.52/15.88	6.35/12.70	6.35/12.70	6.35/15.88	6.35/15.88	9.52/15.88	9.52/15.88
Max Pipe Length /Height Difference	m		25	25	15	15	20	20	20	20
			15	15	8	8	8	8	8	8
Permissible Range of Outdoor Temp.	Cooling	°C	0~43	0~43	21~43	0~43	21~43	0~43	21~43	0~43
	Heating		-10~24	-10~24	-	-6~24	-	-6~24	-	-6~24
Refrigerant			R410A	R410A	R410A	R410A	R410A	R410A	R410A	R410A

FLOOR/CEILING UNIVERSAL TYPE



(ABG14/18/24F: Except "Auto Changeover")



For ABG14F/14U



For ABG18F/18U/24F/24U

ABG14F

Ⓢ 4.20kW / 14,300BTU/h

ABG18F

Ⓢ 5.40kW / 18,400BTU/h

ABG24F

Ⓢ 6.50kW / 22,200BTU/h

ABG14U

Ⓢ 4.00kW / 13,700BTU/h
Ⓜ 4.70kW / 16,000BTU/h

ABG18U

Ⓢ 5.40kW / 18,400BTU/h
Ⓜ 6.00kW / 20,500BTU/h

ABG24U

Ⓢ 6.50kW / 22,200BTU/h
Ⓜ 7.40kW / 25,300BTU/h

CEILING TYPE



(ABG30/36/45/54F: Except "Auto Changeover")



For ABG30F/30U



For ABG36F/36U/45F/45U



For ABG54F/54U

ABG30F

Ⓢ 8.40kW / 28,700BTU/h

ABG36F

Ⓢ 10.50kW / 35,800BTU/h

ABG45F

Ⓢ 12.70kW / 43,400BTU/h

ABG54F

Ⓢ 14.50kW / 49,500BTU/h

ABG30U

Ⓢ 8.40kW / 28,700BTU/h
Ⓜ 9.50kW / 32,400BTU/h

ABG36U

Ⓢ 10.50kW / 35,800BTU/h
Ⓜ 11.80kW / 40,300BTU/h

ABG45U

Ⓢ 12.70kW / 43,400BTU/h
Ⓜ 14.30kW / 48,800BTU/h

ABG54U

Ⓢ 14.50kW / 49,500BTU/h
Ⓜ 16.50kW / 56,300BTU/h

Slim & Compact design (ABG14F/14U/18F/18U/24F/24U)



Symmetrical, slim and compact design

Flexible installation (ABG14F/14U/18F/18U/24F/24U)



Ceiling type

CEILING TYPE										
ABH30L	ABH36L	ABH45L	ABG30F	ABG30U	ABG36F	ABG36U	ABG45F	ABG45U	ABG54F	ABG54U
AOH30L	AOH36L	AOH45L	AOG30F	AOG30U	AOG36F	AOG36U	AOG45F	AOG45U	AOG54F	AOG54U
C / B	E / C	-	C / -	C / B	C / -	B / B	-	-	-	-
8.50	10.00	12.50	8.40	8.40	10.50	10.50	12.70	12.70	14.50	14.50
10.00	10.80	14.00	-	9.50	-	11.80	-	14.30	-	16.50
29,000	34,100	42,700	28,700	28,700	35,800	35,800	43,400	43,400	49,500	49,500
34,100	36,900	47,800	-	32,400	-	40,300	-	48,800	-	56,300
2.5	3.0	4.0	3.0	3.0	4.0	4.0	5.0	5.0	6.0	6.0
1,660	1,850	2,000	1,450	1,450	1,660	1,660	1,850	1,850	2,200	2,200
3,600	3,600	6,600	3,300	3,300	7,000	6,100	6,100	6,100	6,300	6,300
230/1/50	230/1/50	230/1/50	230/1/50	230/1/50	400/3/50	400/3/50	400/3/50	400/3/50	400/3/50	400/3/50
13.1	18.0	19.5	13.6	13.6	6.2	5.9	7.7	7.7	9.5	9.5
12.7	14.2	18.5	-	13.1	-	6.2	-	7.7	-	9.5
3.00	4.12	4.45	2.95	2.95	3.74	3.48	4.38	4.38	5.16	5.16
2.90	3.26	4.25	-	2.78	-	3.45	-	4.39	-	5.30
2.83	2.43	2.81	2.85	2.85	2.81	3.02	2.90	2.90	2.81	2.81
3.45	3.31	3.29	-	3.42	-	3.42	-	3.26	-	3.11
240x1,660x700	240x1,660x700	240x1,660x700	240x1,660x700	240x1,660x700	240x1,660x700	240x1,660x700	240x1,660x700	240x1,660x700	240x1,660x700	240x1,660x700
48(106)	48(106)	48(106)	48(106)	48(106)	48(106)	48(106)	48(106)	48(106)	48(106)	48(106)
830x900x330	830x900x330	1,290x900x330	830x900x330	830x900x330	1,165x900x330	1,165x900x330	1,165x900x330	1,165x900x330	1,290x900x330	1,290x900x330
64(141)	64(141)	105(231)	68(150)	69(152)	80(176)	94(207)	109(240)	113(249)	114(251)	118(260)
Flare	Flare	Flare	Flare	Flare	Flare	Flare	Flare	Flare	Flare	Flare
9.52/15.88	9.52/15.88	9.52/15.88	9.52/15.88	9.52/15.88	9.52/15.88	9.52/15.88	9.52/19.05	9.52/19.05	9.52/19.05	9.52/19.05
50	50	70	30	30	50	50	50	50	50	50
30	30	30	15	15	30	30	30	30	30	30
-10~43	-10~43	-15~43	0~43	0~43	0~43	0~43	0~43	0~43	0~43	0~43
-10~24	-10~24	-15~24	-	-7~24	-	-10~24	-	-10~24	-	-10~24
R410A	R410A	R410A	R410A	R410A	R410A	R410A	R410A	R410A	R410A	R410A

BIG MULTI TYPE SYSTEMS

Simultaneous Operation

Features of System Operations

- Simultaneous Operating System suitable for large spaces such as offices, lobbies and waiting rooms of high-rise buildings.
- One controller can simultaneously control cooling or heating by 2~4 indoor units.

- Long piping for high-rise buildings
- Various combinations of indoor unit types and capacities
- Centralized control by wired remote controller with weekly timer
- Cooling & heating at low outdoor temperatures
- Space saving
- Easy installation

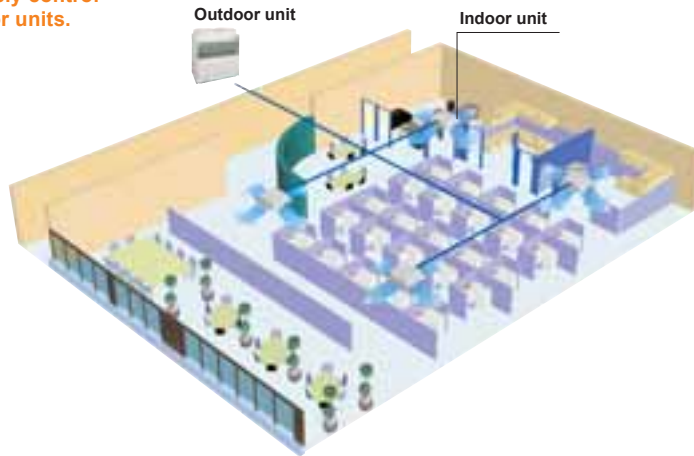

Indoor Unit Combinations

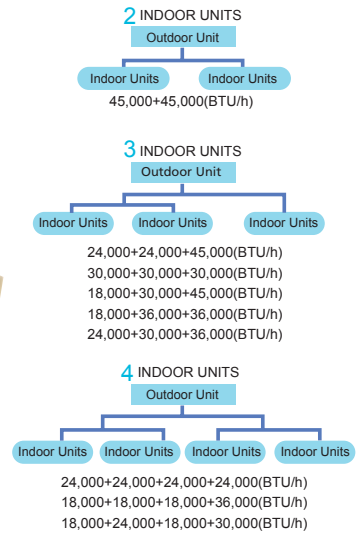

Indoor Unit Lineup

CAPACITY (BTU)	CASSETTE (COMPACT)	CASSETTE	DUCT	FLOOR/CEILING UNIVERSAL	CEILING(LARGE)
	45,000	●	●	●	●
36,000	●	●	●	●	●
30,000	●	●	●	●	●
(25,000)	●	●	●	●	●
24,000	●	●	●	●	●
18,000	●	●	●	●	●

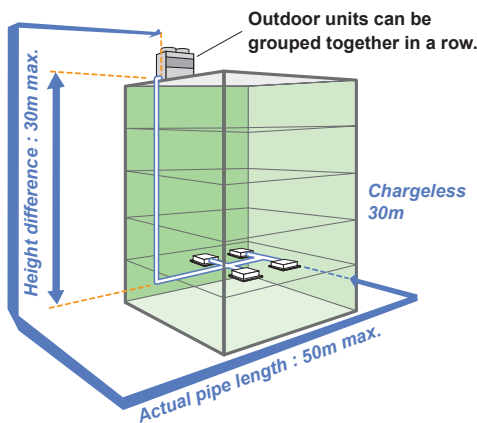

Refrigerant System

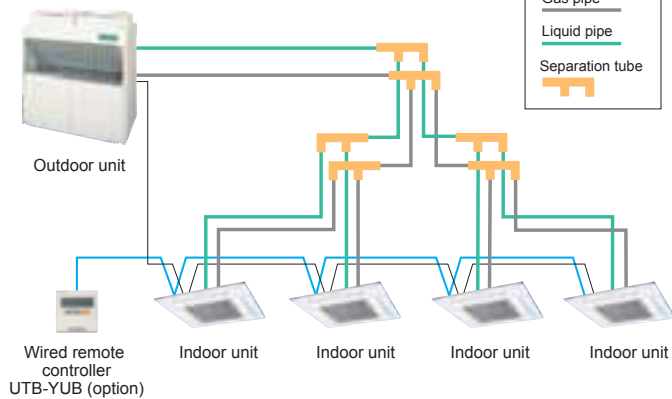

SPECIFICATIONS

SPECIFICATIONS		BIG MULTI-TYPE SYSTEMS									
Item	Model No.	ABGA18TATA	ABGA24TATA	ABGA30TATA	ABGA36TATA	ABGA45TATA	ARXA25TATA	ARXA30TATA	ARXA36TATA	ARXA45TATA	
Input Power	V/ø/Hz	220~240/1/50	220~240/1/50	220~240/1/50	220~240/1/50	220~240/1/50	220~240/1/50	220~240/1/50	220~240/1/50	220~240/1/50	
Capacity	Cooling	kW	5.20~5.30	6.50~6.60	8.60~8.80	10.30~10.50	12.40~12.70	6.95~7.05	8.60~8.80	10.30~10.50	12.40~12.70
			Heating	5.50~5.60	7.60~7.70	8.80~9.10	10.50~10.70	13.40~13.70	7.60~7.85	8.80~9.10	10.50~10.70
	Cooling	BTU/h	17,800~18,100	22,200~22,500	29,400~30,000	35,200~36,000	42,500~43,500	23,700~24,100	29,400~30,000	35,200~36,000	42,500~43,500
			Heating	18,800~19,100	25,900~26,300	30,000~31,000	36,000~36,500	46,000~47,000	25,900~26,800	30,000~31,000	36,000~36,500
Moisture Removal	l/h	2.20	3.40	4.00	4.00	5.50	2.50	3.00	4.00	5.50	
Room Air Circulation	High	m³/h	800	900	1,270	1,660	1,850	1,600	1,650	2,000	2,200
	Med		680	780	1,120	1,500	1,660	1,450	1,550	1,800	2,000
	Low		560	660	860	1,270	1,430	1,280	1,350	1,600	1,800
Fan Motor Output	W	30	40	160	160	160	70	275	275	275	
Fan Type x Q'ty		Sirocco x 2	Sirocco x 2	Sirocco x 4	Sirocco x 4	Sirocco x 4	Sirocco x 2	Sirocco x 2	Sirocco x 2	Sirocco x 2	
Dimensions H x W x D	mm	199x990x655	199x990x655	240x1,660x700	240x1,660x700	240x1,660x700	270x1,210x700	270x1,210x700	270x1,210x700	270x1,210x700	
Net Weight	kg	28	30	48	48	48	43	43	45	45	
Connection Method		Flare	Flare	Flare	Flare	Flare	Flare	Flare	Flare	Flare	
Connection Pipe Size (Smallø/Largeø)	mm	9.53/15.88	9.53/15.88	9.53/15.88	9.53/19.05	9.53/19.05	9.53/15.88	9.53/15.88	9.53/19.05	9.53/19.05	
Operation Range	Cooling	°C	18~30	18~30	18~30	18~30	18~30	18~30	18~30	18~30	
	Heating		16~30	16~30	16~30	16~30	16~30	16~30	16~30	16~30	
Grille		-	-	-	-	-	-	-	-	-	

Individual Operation

Features of System Operations

■ Individual Operating System is suitable for large spaces such as hotels, commercial spaces, offices and restaurants.

■ The system can cool and heat individually, because it has two refrigeration cycles.

- Two refrigeration cycles
- Various combinations of indoor unit types and capacities
- Centralized control by wired remote controller with weekly timer
- Cooling & heating at low outdoor temperatures
- Space saving
- Easy installation

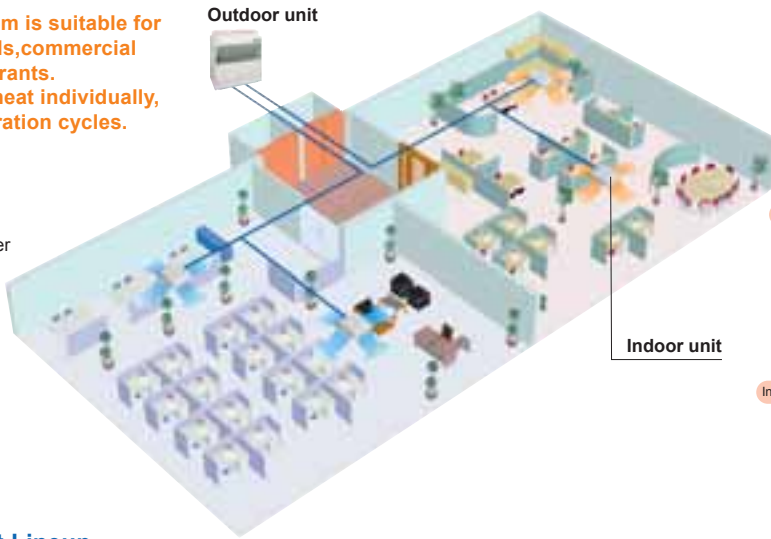

Indoor Unit Combinations

1 INDOOR UNIT + 1 INDOOR UNIT

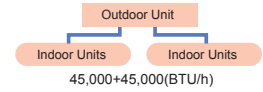

1 INDOOR UNIT + 2 INDOOR UNITS

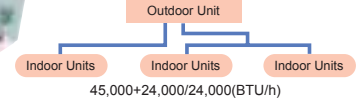

2 INDOOR UNITS + 2 INDOOR UNITS

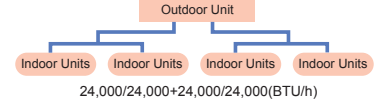

Indoor Unit Lineup

CAPACITY (BTU)	CASSETTE (COMPACT)	CASSETTE	DUCT	FLOOR/CEILING UNIVERSAL	CEILING(LARGE)
	45,000	●	●	●	●
30,000	●	●	●	●	●
(25,000)	●	●	●	●	●
24,000	●	●	●	●	●
18,000	●	●	●	●	●

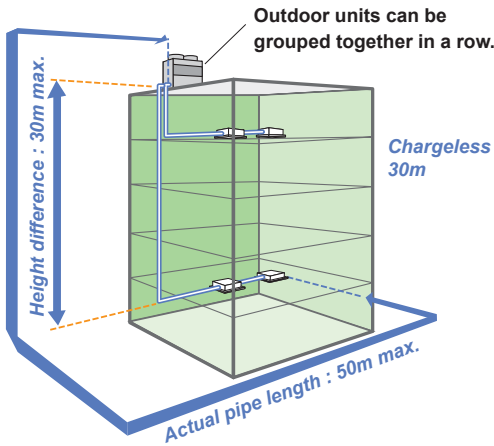

Refrigerant System

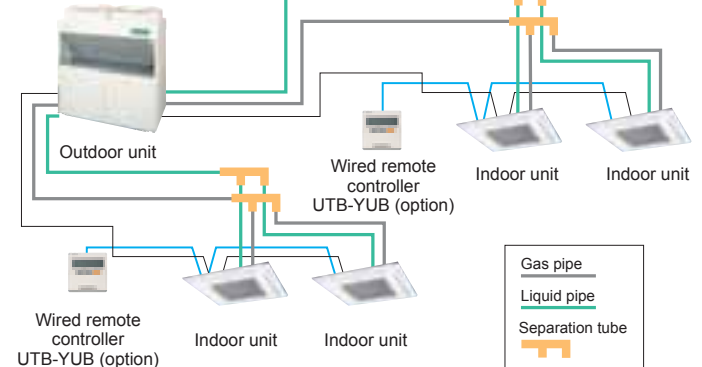

BIG MULTI-TYPE SYSTEMS				
AUJA18TATA	AUGA25TATA	AUGA30TATA	AUGA36TATA	AUGA45TATA
220~240/1/50	220~240/1/50	220~240/1/50	220~240/1/50	220~240/1/50
4.85~5.00	6.95~7.05	8.60~8.80	10.30~10.50	12.40~12.70
5.30~5.45	7.60~7.85	8.80~9.10	10.50~10.70	13.40~13.70
19,000~19,900	23,700~24,100	29,400~30,000	35,200~36,000	42,300~43,400
21,000~21,600	25,900~26,800	30,000~31,100	35,800~36,500	45,800~46,800
2.10	2.50	3.00	4.00	5.00
650	1,170	1,270	1,500	1,650
550	970	1,070	1,300	1,450
490	770	880	1,100	1,200
14	90	90	90	90
Turbo x 1	Turbo x 1	Turbo x 1	Turbo x 1	Turbo x 1
235x580x580(+70)	296x830x830	296x830x830	296x830x830	296x830x830
18	38	38	40	40
Flare	Flare	Flare	Flare	Flare
9.53/15.88	9.53/15.88	9.53/15.88	9.53/19.05	9.53/19.05
18~30	18~30	18~30	18~30	18~30
16~30	16~30	16~30	16~30	16~30
UTG-UDYD-W	-	-	-	-

SPECIFICATIONS			Individual Operation		Simultaneous Operation		
		Model No.	AJGA90EATA	AJGA90TATA	AJGA90EATB	AJGA90TATB	
Power Requirement		V/ø/Hz	380-415/W4/50	380-415/W4/50	380-415/W4/50	380-415/W4/50	
Total Capacity	Cooling	kW	25.40	25.40	25.40	25.40	
	Heating	kW	-	28.60	-	28.60	
Total Input Watts	Cooling	kW	9.40	9.40	9.40	9.40	
	Heating	kW	-	10.00	-	10.00	
Total Ampacity	Cooling	A	16.20	16.20	16.20	16.20	
	Heating	A	-	17.00	-	17.00	
Starting Current		A	63.00	63.00	63.00	63.00	
EER	Cooling	W/W	2.70	2.70	2.70	2.70	
	Heating	W/W	-	2.86	-	2.86	
COP	High	r.p.m	730	730	730	730	
	Low	r.p.m	360	360	360	360	
Air Circulation		m³/h	9,800	9,800	9,800	9,800	
Fan Type x Q'ty			Propellar x 2	Propellar x 2	Propellar x 2	Propellar x 2	
Fan Motor Output		W	150x2	150x2	150x2	150x2	
Dimensions H x W x D		Net mm	1,380x1,300x650	1,380x1,300x650	1,380x1,300x650	1,380x1,300x650	
Weights		Net kg(lbs)	243	245	243	245	
Noise Level(Sound Pressure)		db(A)	57	57	57	57	
Condition	Indoor Air Temp.	Cooling	DB/WB	27/19	27/19	27/19	27/19
		Heating	(°C)	20/(15)	20/(15)	20/(15)	20/(15)
	Outdoor Air Temp.	Cooling	DB/WB	35/24	35/24	35/24	35/24
		Heating	(°C)	7/6	7/6	7/6	7/6
Refrigerant		Type	R407C	R407C	R407C	R407C	
Pipe	Size	Charge	kg	3.1x2	3.1x2	6.00	6.00
		Liquid/Gas	mm	9.53/19.05	9.53/19.05	12.70/28.58	12.70/28.58
	Max Length	m		50	50	50	50
	Max Height			30	30	30	30
Max Chargeless Length			30	30	30	30	
Operation(Outdoor)			°C	0~52	0~52	0~52	0~52
			°C	-10~21	-10~21	-10~21	-10~21

WINDOW TYPE



AKH7F

Ⓒ 2.15kW / 7,300BTU/h

AKH9F

Ⓒ 2.75kW / 9,400BTU/h

AKH9U

Ⓒ 2.80kW / 9,560BTU/h

Ⓓ 2.90kW / 9,900BTU/h



AMH12U

Ⓒ 3.45kW / 11,800BTU/h

Ⓓ 3.60kW / 12,300BTU/h

AMH13F

Ⓒ 3.55kW / 12,100BTU/h

AFH16F

Ⓒ 4.65kW / 15,800BTU/h

AFH16U

Ⓒ 4.55kW / 15,500BTU/h

Ⓓ 4.30kW / 14,700BTU/h

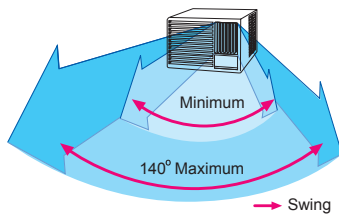

The air flow direction can be freely adjusted.

Unrestricted direction of air flow.
The louver allows air flow coverage as wide as 140°.

Mounting the louver in the center provides coverage of an area as wide as 140°. Cold or warm air is distributed throughout the room.

Easy filter cleaning

The filter can be cleaned without removing the front panel.

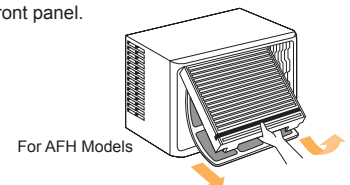

SPECIFICATIONS			WINDOW TYPE						
Item	Model No.		AKH7F	AKH9F	AKH9U	AMH12U	AMH13F	AFH16F	AFH16U
Rank			C	C	C	D	D	C	D
Capacity	Cooling	kW	2.15	2.75	2.80	3.45	3.55	4.65	4.55
			Heating	-	-	2.90	3.60	-	-
	Cooling	BTU/h	7,300	9,400	9,560	11,800	12,100	15,800	15,500
			Heating	-	-	9,900	12,300	-	-
Moisture Removal		l/h	0.90	0.90	0.90	1.10	1.50	2.10	2.10
Room Air Circulation(High)	Inner	m ³ /h	345	365	350	530	490	620	620
Input Power		V/ø/Hz	230/1/50	230/1/50	230/1/50	230/1/50	230/1/50	230/1/50	230/1/50
Running Current	Cooling	A	3.80	4.50	4.70	6.20	6.80	7.80	8.00
	Heating		-	-	4.20	5.80	-	-	7.20
Power Consumption	Cooling	kW	0.81	1.05	1.05	1.40	1.38	1.76	1.81
	Heating		-	-	0.93	1.30	-	-	1.62
EER	Cooling	kW/kW	2.65	2.62	2.67	2.46	2.57	2.64	2.51
COP	Heating		-	-	3.12	2.77	-	-	2.65
Dimensions H x W x D	Inner	mm	349x457x581	349x457x581	349x457x581	375x560x650	375x560x650	400x660x633	400x660x633
Net Weight		kg(bs)	30(66)	30(66)	33(73)	45(99)	43(95)	59(130)	61(134)
Permissible Range of Outdoor Temperature	Cooling	°C	21~43	21~43	21~43	21~43	21~43	21~43	21~43
	Heating		-	-	0~21	0~21	-	-	0~21
Feature	Super Power					●	●	●	●
	Super Quiet		●	●	●	●	●	●	●
	Super Wave		●	●	●	●	●	●	●
	Instant Air Exchange		●	●	●	●	●	●	●

Feature Summary

- Moisture Removal
- Up/Down Swing
- Double Swing
- Automatic Flaps
- Automatic Air Flow Adjustment
- Auto Shut Flaps
- Auto Restart
- Auto-Changeover
- Sleep Timer
- ON-OFF timer
- Program Timer
- Weekly + setback timer
- Weekly Timer
- Connectable Distributing Duct
- Connectable Fresh Air Duct
- Long-life Ion deodorization Panel
- Long-life photocatalytic deodorizing filter
- Wasabi antibacterial electrostatic filter
- Apple-catechin filter
- Washable Panel
- Fresh Air intake
- Economy Mode
- Filter Sign

		Moisture Removal	Up/Down Swing	Double Swing	Automatic Flaps	Automatic Air Flow Adjustment	Auto Shut Flaps	Auto Restart	Auto-Changeover	Sleep Timer	ON-OFF timer	Program Timer	Weekly + setback timer	Weekly Timer	Connectable Distributing Duct	Connectable Fresh Air Duct	Long-life Ion deodorization Panel	Long-life photocatalytic deodorizing filter	Wasabi antibacterial electrostatic filter	Apple-catechin filter	Washable Panel	Fresh Air intake	Economy Mode	Filter Sign		
CEILING WALL	AWHZ14LB/18LB/24LB	●			●	●	●	●	●	●	●	●	●	●						●						
	AWG18FA/24FA	●			●	●	●	●	●	●	●	●	●	●							○			○		
	AWG18UA/24UA	●			●	●	●	●	●	●	●	●	●	●							○			○		
	AWG18FB/24FB/30FB	●			●	●	●	●	●	●	●	●	●	●							○			○		
	AWG14UB/18UB/24UB/30UB	●			●	●	●	●	●	●	●	●	●	●							○			○		
WALL MOUNTED	ASHB09LD/12LD/18LD	●	●		●	●	●	●	●	●	●	●	●	●						●						
	ASHB24LD	●			●	●	●	●	●	●	●	●	●	●						●						
	ASHA07LC/09LC/12LC	●	●		●	●	●	●	●	●	●	●	●	●						●	●		●			
	ASHA14LC/18LC	●	●		●	●	●	●	●	●	●	●	●	●						●	●		●			
	ASHA24LC/30LC	●			●	●	●	●	●	●	●	●	●	●						●	●		●			
	ASH9UB/12UB	●	●		●	●	●	●	●	●	●	●	●	●						●	○		○			
	ASH7FB/9FB/12FB	●	●		●	●	●	●	●	●	●	●	●	●						●	○	○	○	○		
	ASH7UB/9UC/12UC	●	●		●	●	●	●	●	●	●	●	●	●						●	○	○	○	○		
	ASH14FB	●	●		●	●	●	●	●	●	●	●	●	●						●	○		○			
	ASH14UB	●	●		●	●	●	●	●	●	●	●	●	●						●	○		○			
	ASG18FA	●			●	●	●	●	●	●	●	●	●	●							○			○		
	ASG18UA	●			●	●	●	●	●	●	●	●	●	●							○			○		
	ASG18FB/24FB/30FB	●			●	●	●	●	●	●	●	●	●	●							○			○		
	ASG18UB/24UB/30UB	●			●	●	●	●	●	●	●	●	●	●							○			○		
FLOOR	AGHV9LA/12LA/14LA	●	●		●	●	●	●	●	●	●	●	●	●	●	●				●		○	○			
FLOOR/CEILING UNIVERSAL	ABHA18L/24L	●			●	●	●	●	●	●	●	●	●	●	●	●				●				●	●	
	ABH18L/24L	●			●	●	●	●	●	●	●	●	●	●	●	●				●					●	●
	ABG14F/18F/24F	●			●	●	●	●	●	●	●	●	●	●												
	ABG14U/18U/24U	●			●	●	●	●	●	●	●	●	●	●												
CEILING	ABHA36L/45L	●			●	●	●	●	●	●	●	●	●	●	●	●				●	●			●	●	
	ABH30L/36L/45L	●			●	●	●	●	●	●	●	●	●	●						●					●	●
	ABG30F/36F/45F/54F	●			●	●	●	●	●	●	●	●	●	●												
	ABG30U/36U/45U/54U	●			●	●	●	●	●	●	●	●	●	●												
COMPACT CASSETTE	AUHA12L/14L	●	●		●	●	●	●	●	●	●	●	●	●	●	●				●	●			●	●	
	AUHA18L/24L	●	●		●	●	●	●	●	●	●	●	●	●	●	●				●	●			●	●	
	AUH12L/14L/18L	●	●		●	●	●	●	●	●	●	●	●	●						●	●				●	●
	AUG12F/14F/18F	●	●		●	●	●	●	●	●	●	●	●	●												
	AUG12U/14U/18U	●	●		●	●	●	●	●	●	●	●	●	●												
CASSETTE	AUHA36L/45L	●	●		●	●	●	●	●	●	●	●	●	●	●	●				●	●			●	●	
	AUH24L/30L/36L/45L/54L	●	●		●	●	●	●	●	●	●	●	●	●												
	AUG25F/25F(3)/30F/36F/45F/54F	●	●		●	●	●	●	●	●	●	●	●	●												
	AUG25U/30U/36U/45U/54U	●	●		●	●	●	●	●	●	●	●	●	●												
DUCT	ARHA12L/14L	●			●	●	●	●	●	●	●	●	●	●	●	●				●				●	●	
	ARHA18L	●			●	●	●	●	●	●	●	●	●	●	●	●				●				●	●	
	ARHA24L	●			●	●	●	●	●	●	●	●	●	●	●	●				●				●	●	
	ARHA36L/45L	●			●	●	●	●	●	●	●	●	●	●	●	●				●				●	●	
	ARH12L/14L/18L	●			●	●	●	●	●	●	●	●	●	●						○						
	ARH24L/30L/36L/45L	●			●	●	●	●	●	●	●	●	●	●						○						
	ARH45LH/54L	●			●	●	●	●	●	●	●	●	●	●						○						
	ARG7F/9F/12F/14F/18F	●			●	●	●	●	●	●	●	●	●	●							○					
	ARG7U/9U/12U/14U/18U	●			●	●	●	●	●	●	●	●	●	●							○					
	ARG25F/30F/36F/45F	●			●	●	●	●	●	●	●	●	●	●							○					
	ARG25U/30U/36U/36U(1)/45U	●			●	●	●	●	●	●	●	●	●	●							○					
	ARG60F	●			●	●	●	●	●	●	●	●	●	●							○					
	ARG60U	●			●	●	●	●	●	●	●	●	●	●							○					
	ARG90E																									
ARG90T																										
INVERTER MULTI	AOH18LM2	ASH7LM/9LM/12LM	ASHA14LA/18LA	●	●		●	●	●	●	●	●	●	●	●	●				●	●		●	●		
	AOH24LM2	ASH18LB/24LB		●	●		●	●	●	●	●	●	●	●	●	●				●	●		●	●		
	AOHA18LAT3	AUH12LB/14LB/18LB		●	●		●	●	●	●	●	●	●	●						●	●					
	AOHA24LAT3	ABH14LB/18LB/24LB		●	●		●	●	●	●	●	●	●	●												
	AOH30LM4	ARH9LU/12LU/14LU/18LU/22LU		●			●	●	●	●	●	●	●	●	●	●				○						
MULTI	AOH19F	ASH9FMBD x 2		●	●		●	●	●	●	●	●	●	●	●	●				●						
	AOH20FSS	ASH12FMBD + 7FMBD		●	●		●	●	●	●	●	●	●	●	●	●				●						
	AOH20FSU	AUH12FMAB + ASH7FMBD		●	●		●	●	●	●	●	●	●	●	●	●	●			●	●					
	AOH24FSS	ASH12FMBD x 2		●	●		●	●	●	●	●	●	●	●	●	●				●						
	AOH24FSU	AUH12FMAB + ASH12FMBD		●	●		●	●	●	●	●	●	●	●	●	●	●			●	●					
	AOH24FUU	AUH12FMAB x 2		●	●		●	●	●	●	●	●	●	●	●	●				●	●					
	AOH20F(3)	ASH9FMBD x 3		●	●		●	●	●	●	●	●	●	●	●	●				●						
	AOH32E(4)	ASH12EMBCW x 4		●	●		●	●	●	●	●	●	●	●	●	●				●						
	AOH19U	ASH9UMBD x 2		●	●		●	●	●	●	●	●	●	●	●	●				●						
	AOH20USS	ASH12UMBD + 7UMBD		●	●		●	●	●	●	●	●	●	●	●	●				●						
	AOH20USU	AUH12UMAB + ASH7UMBD		●	●		●	●	●	●	●	●	●	●	●	●	●			●	●					
	AOH24USS	ASH12UMBD x 2		●	●		●	●	●	●	●	●	●	●	●	●				●						
	AOH24USU	AUH12UMBD + ASH12UMBD		●	●		●	●	●	●	●	●	●	●	●	●	●			●	●					
	AOH24UUU	AUH12UMAB x 2		●	●		●	●	●	●	●	●	●	●	●	●				●	●					

Explanation of Features



Moisture Removal

The computer effectively dehumidifies the air.



Up/Down Swing Flaps

The up/down flaps automatically swing up and down.



Double Swing Automatic

Complex swing action of flaps enables automatically to swing both horizontal and vertical directions.



Automatic Flaps

The position of the flaps is set automatically to match the operating mode. It is also possible to adjust the flaps using the remote control.



Auto Shut Flaps

The auto shut flaps close or open automatically when the unit stops or starts.



Automatic Air Flow Adjustment

The micro-computer automatically adjusts the air flow effectively to follow the changes of room temperature.



Auto Restart

In the event of a temporary power failure, the air conditioner will automatically restart in the same operating mode as before, once the power supply is restored.



Auto-Changeover

The unit automatically switches between heating and cooling modes based on your temperature setting and the room temperature.



Sleep Timer

The micro-computer gradually changes the room temperature automatically to afford a comfortable night's sleep.



ON-OFF Timer

ON-OFF timer can be set to operate once.



Program Timer

This digital timer allows selection of one of four options: ON, OFF, ON → OFF or OFF → ON.



Weekly Timer

Different on-off times can be set for each day.



Weekly + Setback Timer

Weekly + Setback timer can set temperature for two times spans and for each day of the week.



Connectable Distributing Duct



Connectable Fresh Air Duct



Fresh Air Intake

Fresh air can be taken in by a fan which can be connected using external control unit.



Washable Panel



Long-life Ion Deodorization Filter

For details, see page7.



Long-life photocatalytic deodorizing filter



Apple-catechin Filter

For details, see page7.



Wasabi antibacterial electrostatic filter



Filter Sign

Indicates the filter cleaning period by lamp.



Economy Mode

Limits the maximum operation current, and performs operation with the power consumption suppressed.



Cooling



Heating



Rank A models



All DC inverter models



V-PAM models



I-PAM models



ISO 9001 Certified number:09 100 89394
 ISO 14001 Certified number:09 104 9245
 Fujitsu General (Thailand) Co., Ltd.



ISO 9001 Certified number:09 100 79269
 Fujitsu General (Shanghai) Co., Ltd.



ISO 14001 Certified number:104692
 Fujitsu General (Shanghai) Co., Ltd.

Distributed by :