

FUJITSU GENERAL LIMITED  
3-3-17, Suenaga, Takatsu-ku, Kawasaki 213-8502, Japan



**Notice for specifications**

- I.U.=Indoor Unit O.U.=Outdoor Unit Qu=Quiet \*\*=Not decided yet
- Specifications and design are subject to change without notice for future improvement.
- For further details, please check with our authorized dealer.
- Cooling / Heating capacities are based on the following conditions.
 

Cooling	Indoor temp. : 27°C DB/19°C WB	Outdoor temp. : 35°C DB/24°C WB	Heating	Indoor temp. : 20°C DB	Outdoor temp. : 7°C DB/6°C WB
---------	--------------------------------	---------------------------------	---------	------------------------	-------------------------------
- Performance test is in accordance with EN14211
- Seasonal efficiency test is in accordance with EN14825
- Sound power test is in accordance with EN12102
- The products or equipments in this catalogue contain fluorinated greenhouse gases.
- "**AIRSTAGE**" and "**WATERSTAGE**" are worldwide trademarks of FUJITSU GENERAL LIMITED and are registered trademarks in Japan and other countries or areas.
- "**nocria**" is a worldwide trademark of FUJITSU GENERAL LIMITED.
- iPhone and iPad are trademarks of Apple Inc., registered in the U.S. and other countries.
- Other company and product names mentioned herein may be registered trademarks, trademarks or trade names of their respective owners.
- Actual products' colors may be different from the colors shown in this printed material.

Distributed by :



Copyright © 2008-2014 Fujitsu General Limited. All rights reserved.  
3EFD11-1412E

FUJITSU

FUJITSU

AIR CONDITIONERS LINEUP PRODUCT CATALOGUE 2015

FUJITSU GENERAL LIMITED

AIR  
CONDITIONERS  
LINEUP

SPLIT  
MULTI SPLIT  
VRF  
VENTILATION  
AIR TO WATER

PRODUCT  
CATALOGUE  
2015

FUJITSU GENERAL LIMITED

# Creation of Comfort

Fujitsu General creates high-quality and environmentally-friendly products that provide good comfort in accordance with our basic policy to a "create comfortable environment" by utilizing the air conditioning technology and creativity we have fostered over many years.



## 004 MISSIONS

- 006 Energy Efficiency Standard
- 008 Phase Down of HFC



## 010 ABOUT US

- 012 Our History
- 014 Global Network
- 016 High Quality Development & Production Facilities
- 018 Global Business Activities
- 020 Project Reference



## 022 CORE TECHNOLOGY

- 024 High Efficiency
- 026 Energy Saving Control
- 028 Comfort Performance
- 030 Easy-to-use Control
- 032 Smart Design



## 034 SUPPORT

- 036 AIRSTAGE™ Support
- 038 Design Simulator
- 040 WATERSTAGE™ Support Tool
- 042 Quick Service and Maintenance



## 044 PRODUCT CATEGORY

- 046 2015 Fujitsu General Solutions
- 048 Split
- 084 Multi Split
- 108 Optional Parts For Split & Multi Split
- 116 V R F
- 186 Ventilation
- 194 Optional Parts For VRF
- 200 Air to Water

# MISSIONS

006 Energy Efficiency Standard

008 Phase Down of HFC

We always keep the future in mind to ensure that the air conditioning technology that makes people comfortable is also environmentally friendly.

# Energy Efficiency Standard

**20% LESS**  
Primary Energy Use

Fujitsu General products with high efficiency and therefore low electricity input and low primary energy usage

Fujitsu General following The EU Climate Action Plan 20/20/20 by 2020

**20% LESS**  
CO<sub>2</sub> Emissions

Fujitsu General products sharply following the F-gas regulation 842 / 2006 / EC

**20% SHARE**  
of Renewable Energy

Fujitsu General promoting air sourced heat pumps as renewable energy source heating systems

## Pursuit of Energy Saving Taking Actual Operation into Consideration

The heat load varies greatly depending on the time and season. However, the operation ratio EER or COP up to now has been calculated based on the rated value and the annual operating hours per outdoor temperatures was not taken into consideration.

For this reason, SEER and SCOP\* have been made the standard in terms of actual operating hours throughout the year.

\*: SEER = Seasonal Energy Efficiency Ratio  
SCOP = Seasonal Coefficient of Performance

**Fujitsu General provides air conditioners with higher SEER and SCOP.**

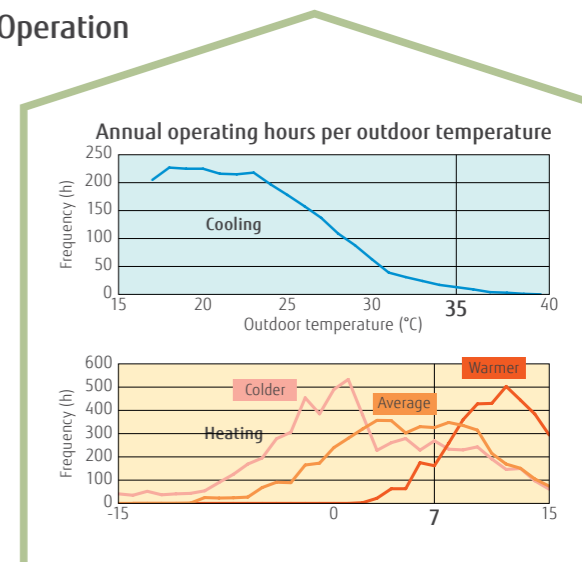

\*SEER and SCOP are indexes that express the annual energy efficiency calculated based on the regulations of (EU) 626/2011.

## New Energy Labels 2015

For Air Conditioners

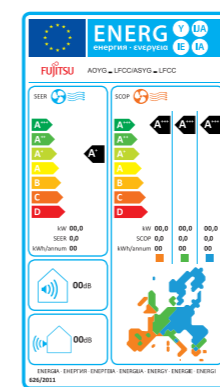

\* Enforcement on January 1, 2013  
Air conditioners below 12 kW

For Air to Water

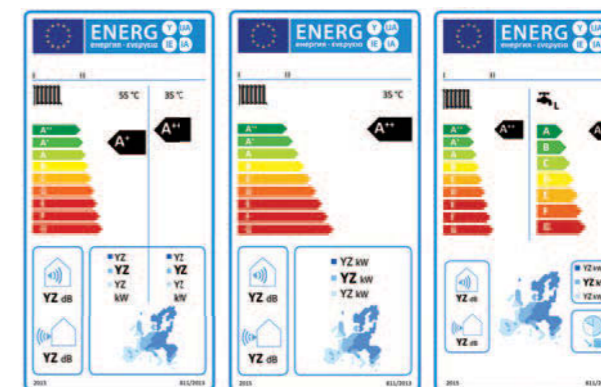

High temp model label

Low temp model label

Heating and hot-water supply model label

**2019 Energy Rank**

For Air Conditioners

	SEER (Cooling mode)	SCOP (Heating mode)
A+++	SEER ≥ 8.50	SCOP ≥ 5.10
A++	6.10 ≤ SEER < 8.50	4.60 ≤ SCOP < 5.10
A+	5.60 ≤ SEER < 6.10	4.00 ≤ SCOP < 4.60
A	5.10 ≤ SEER < 5.60	3.40 ≤ SCOP < 4.00
B	4.60 ≤ SEER < 5.10	3.10 ≤ SCOP < 3.40
C	4.10 ≤ SEER < 4.60	2.80 ≤ SCOP < 3.10
D	3.60 ≤ SEER < 4.10	2.50 ≤ SCOP < 2.80
E	3.10 ≤ SEER < 3.60	2.20 ≤ SCOP < 2.50
F	2.60 ≤ SEER < 3.10	1.90 ≤ SCOP < 2.20
G	SEER < 2.60	SCOP < 1.90

For Air to Water heating part

	Seasonal heating efficiency (Except low temp HP)	Seasonal heating efficiency (Low temp HP)
A+++	x ≥ 150	x ≥ 175
A++	125 ≤ x < 150	150 ≤ x < 175
A+	98 ≤ x < 125	123 ≤ x < 150
A	90 ≤ x < 98	115 ≤ x < 123
B	82 ≤ x < 90	107 ≤ x < 115
C	75 ≤ x < 82	100 ≤ x < 107
D	36 ≤ x < 75	61 ≤ x < 100
E	34 ≤ x < 36	59 ≤ x < 61
F	30 ≤ x < 34	55 ≤ x < 59
G	x < 30	x < 55

# Phase Down of HFC

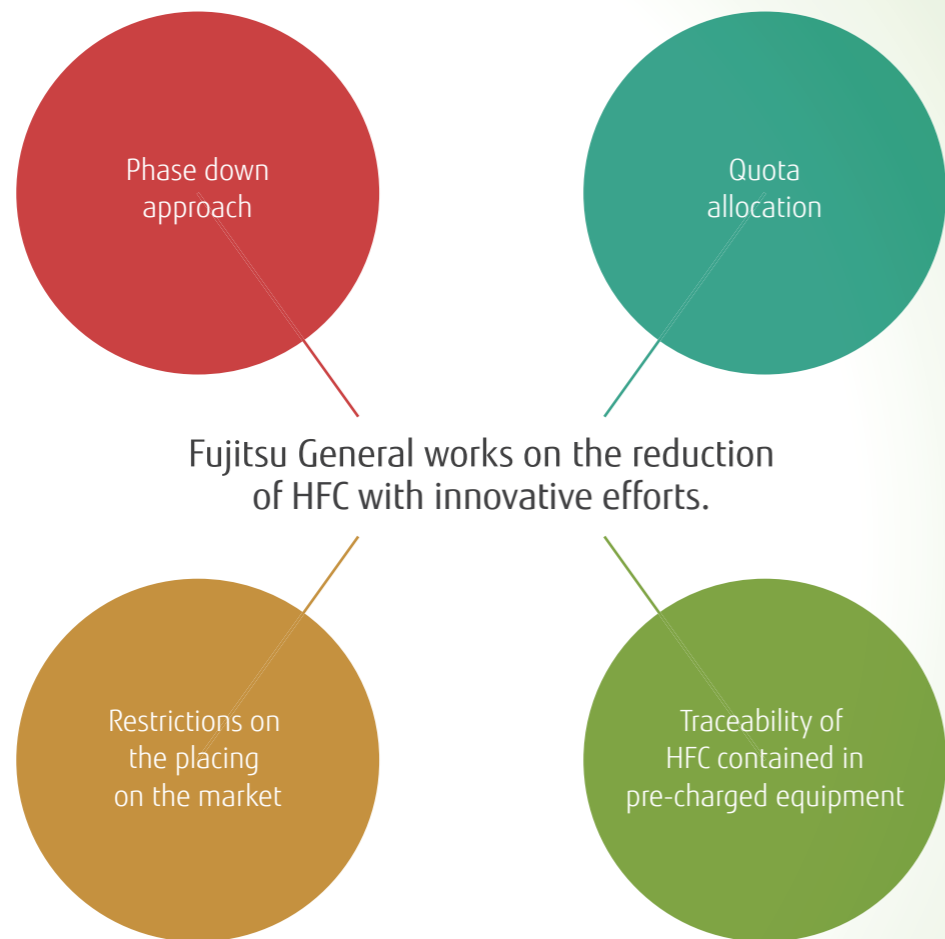

EU strengthen F-gas Regulation introduced 2014. New EU F-gas Regulation aims prevention of emissions and reduction the use of higher GWP F-gases.

## Road to 2025

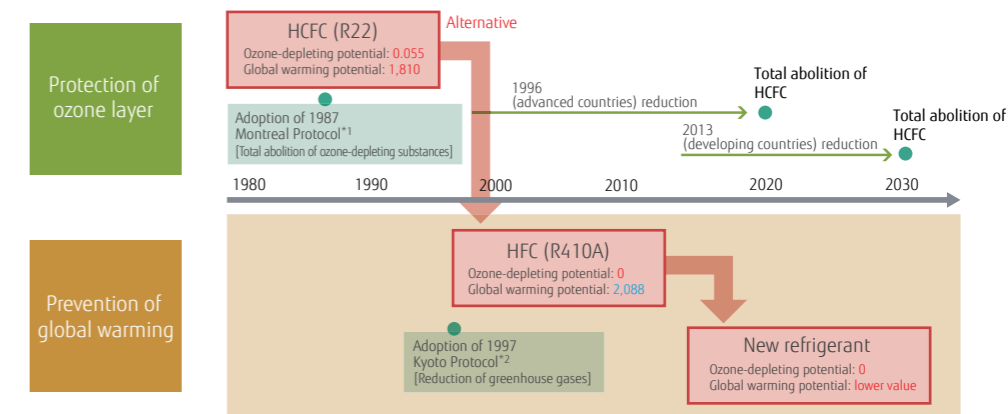

\*1 Montreal Protocol: This protocol specifies ozone-depleting substances (8 kinds) for the purpose of regulating production, consumption, and trading of those substances. Currently, the protocol has been ratified by 197 countries.

\*2 Kyoto Protocol: The target amount of greenhouse gas emission (CO<sub>2</sub>, methane, NO, HFC, PFC, and SF<sub>6</sub>) was determined to be 5% reduction among the entire number of advanced countries.

## New refrigerant R32 for the reduction of the global warming potential



It is a proven refrigerant that can also be found in the currently-used HFC refrigerant R410A. The ozone-depleting potential (ODP<sup>\*3</sup>) is 0! The global warming potential (GWP<sup>\*4</sup>) is approximately 1/3 of R410A! Also, it is an excellent refrigerant that provides comprehensive benefits in terms of environmental friendliness, performance, safety, and economic efficiency.

### Comparison of characteristics

Refrigerant		ODP <sup>*3</sup>	GWP <sup>*4</sup>	Cool Capacity When R22 is considered as 100.	COP When R22 is considered as 100.
HCFC	R22	0.05	1810	100	100
HFC-mix	R410A	0	2090	141	92
HFC	R32	0	675	160	97

(Reference to 2011 JRAIA Report)

\*3 ODP (Ozone-Depleting Potential): This is the relative value indicating the impact of ozone-depleting substances per unit weight if they are emitted into the atmosphere when CFC-11 (trichlorofluoromethane, CCl<sub>3</sub>F) is considered to be 1.0.

\*4 GWP (Global-Warming Potential): This is the number that indicates the global warming capability of other greenhouse gases with reference to carbon dioxide as the standard. This is the estimated integration value, which is indicated as a ratio to CO<sub>2</sub>, of the radiant energy given to the earth (i.e., impact on global warming).

# ABOUT US

- 012 Our History
- 014 Global Network
- 016 High Quality Development & Production Facilities
- 018 Global Business Activities
- 020 Project Reference

Since we began our air conditioning business in 1971, our products have been popular around the world and we continue to improve them.

# Our History

1960  
Air conditioning business starts. Japan-domestic business starts.

1971  
Air conditioner exports to Middle East.

Overseas Air Conditioning Business since  
**1971**



1977  
"Super Power, Super Quiet" series

1982  
Window type 3 Super series AL/AX series

1985  
Large wall mounted and multi air conditioner introduced.



2001  
AIRSTAGE™ series is released. VRF air conditioners for large-sized buildings.



2006  
VRF Heat Pump type Max.42HP



2009  
VRF Heat Pump type Max.48HP



2012  
VRF Heat Recovery type Max.48HP



2015  
VRF Heat Pump type Max. 54HP



2004  
Small VRF series



2011  
Small VRF series



2014  
The small VRF series is small & light weight outdoor unit.



2015  
New Compact Cassette & Cassette /Duct models



2009  
Air to Water system is released.



2011  
Hi-spec Design model



2014  
Air to Water system Monobloc type: Compact series



1936 Established as Yaou Shouten Ltd.

2001

2003

2004

2006

2009

2011

2012

2014

2015

## Manufacturing Company Establishment

1955  
Headquarters in Kawasaki

1964  
Electronic components factory in Ichinoseki

1977  
Air conditioner manufacturing company in Hamamatsu (now Hamamatsu business office.)

1991  
Air conditioner manufacturing company in Thailand.

1994  
Air conditioner manufacturing company in Shanghai, China.

1998  
Air conditioner motor manufacturing company in Thailand.

2006  
VRF air conditioner manufacturer, sale, and service company in China.

2007  
Air conditioner technology building completed on Main Office group. Air conditioner R & D Center in Kawasaki

2009  
Operation of compressor factory begins in Thailand.

2012  
Joint venture in Thailand to manufacture compressors



## Sales Company Establishment

1976  
North America sales company

1977  
Europe sales company (UK)

1978  
Australia sales company  
Europe sales company (Germany)

1980  
Brazil sales company

1997  
Asia sales company (Singapore)

1998  
Middle East sales company (UAE)  
New Zealand sales company

2000  
Air conditioner manufacturing and sale technical partnership in India

2002  
Taiwan sales company

2006  
China sales company

2013  
Moscow representative office

\*1. Announced 1991. In room air conditioner for the home (our company's investigation)  
\*2. Announced 1994. In room air conditioner for the home (our company's investigation)  
\*3. Announced 2002. In room air conditioner for the home (our company's investigation)

# Global Network

Fujitsu General's air conditioning business has acquired a major share of the overseas market. We have many production and sales facilities overseas, and we continue to develop and sell products that are accepted around the world by their "easy-to-use and environmentally-friendly technology".

## Development & Production Bases

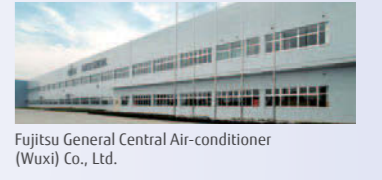
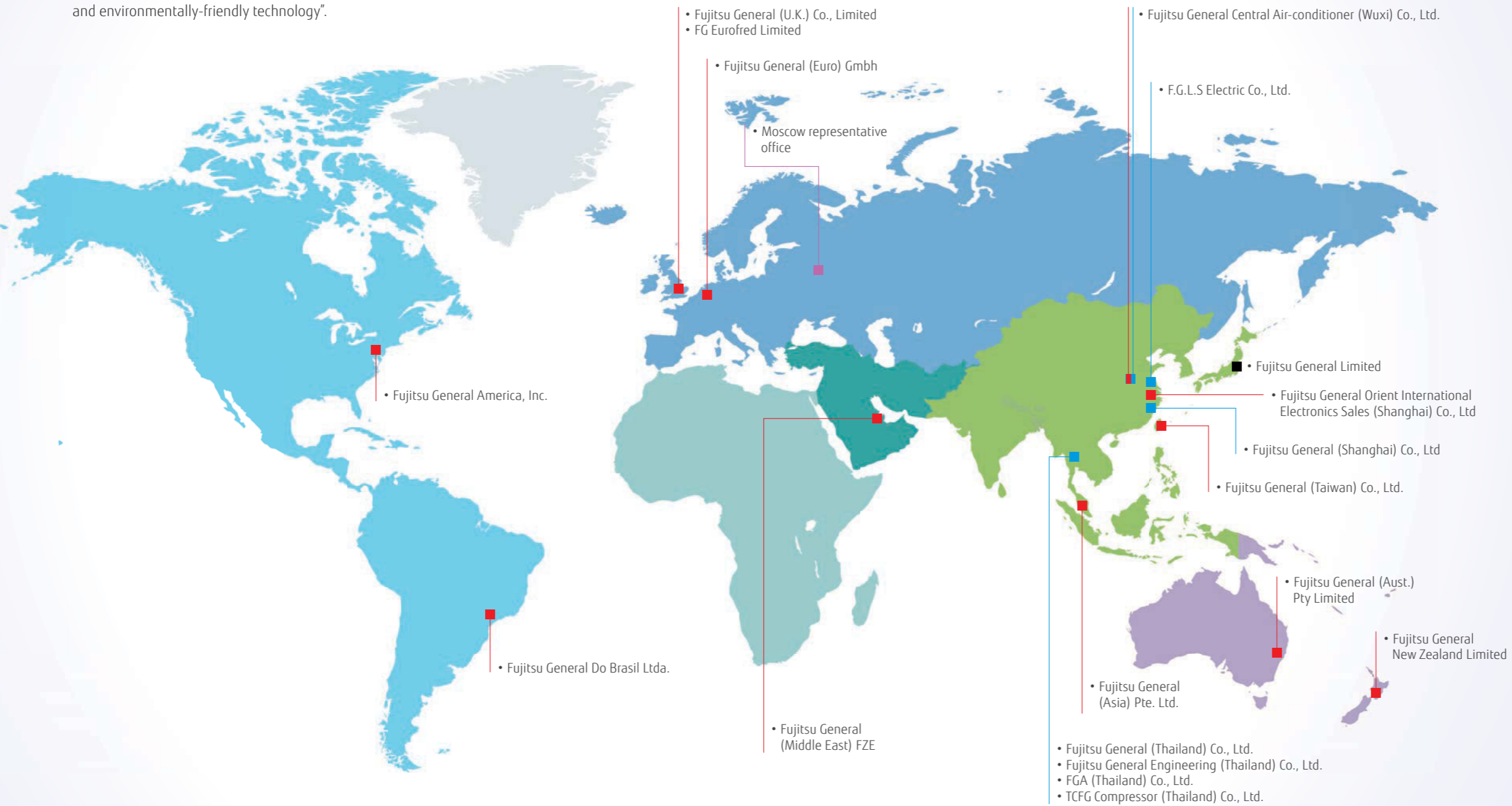

JAPAN Head Office  
R & D Center and 60 m Height Difference  
Testing Tower



**12** Overseas Sales Companies &  
**6** Overseas Manufacturing Companies

- Head Office
- Sales Companies
- Manufacturing Companies
- Representative office



# High Quality Development & Production Facilities

## Advanced Research Facility and Equipment

### Performance Testing



Air flow testing      Calorimeter testing      Sound testing

### Reliability Testing



Severe environmental testing      Water shower testing

### Transportation & Handling



Compressibility testing



Vibration testing



R&D Center

## Testing Laboratory



Fujitsu General EMC Laboratory Limited

### 60 m Height Difference Testing Tower

Objective is to confirm oil circulation of compressor for reliability



## Acquisition of ISO 9001 and ISO 14001

Each of overseas production bases (5 companies) has completed the acquisition of ISO 9001 and ISO 14001 individually.

In 2012, overseas sales bases (11 companies) acquired the certification of ISO 14001.

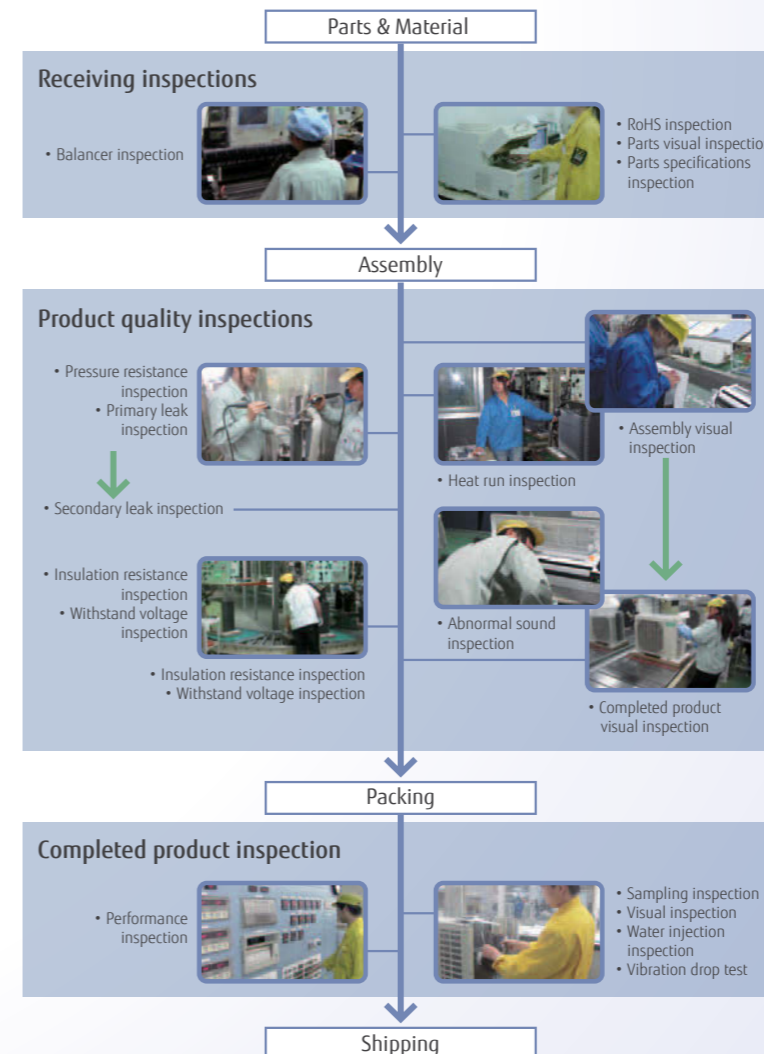

## High Product Quality Assurance

All Fujitsu General factories have acquired ISO 9001, and have built a quality control system common around the world. High quality products are offered to all over the world based on stringent quality inspections.

### Receiving inspection

Parts procurement requires a supplier's test report. European regulation RoHS inspection is also performed by special test department in-house. Total number inspection is performed especially on main parts to remove defectives.

### Stringent product quality inspection

Stringent quality inspection is carried out at all production processes. High quality is maintained by stringent checks by inspectors and repetitive inspection.

# Global Business Activities

We are engaging in advertising, human resource development, CS activities, and social contribution activities worldwide. These activities have been recognized throughout different regions by the awards we have been honored with.

## America



Billboard



Distributor meeting



Call center



"Dealer Design Awards" of "the NEWS"



Gold Award (Category: HVAC & PLUMBING) in Reader's Choice Awards



HVAC trade show in Brazil



Distributor meeting



Technical seminar



Training for dealers

## Europe



HVAC trade show in Europe countries



Presentation & training



### International authoritative design awards



The iF Product Design Award is given each year by "iF International Forum Design GmbH" for industrial products from around the world.



The product design competition has existed since 1955. Its award, the "red dot", is an internationally recognised quality seal.

## Asia



SE training



Call center



Presentation for sales companies



Distributor meeting



China State Construction Engineering Luban Prize



The Good Design Award is sponsored by the Japan Institute of Design Promotion and is awarded once a year for an item of excellent design.

## Oceania



Training for installer



HVAC trade show in Australia



Charity (Christchurch)



Coolworld Industry Awards "Most Efficient Air Conditioner"



Canstar Blue Most Satisfied Customers Award

# Project Reference

The VRF is popular because of its high quality, energy saving, and easy installation, and so has been installed in a wide range of building types including high-rise office buildings, stores, hotels, public facilities, schools, and hospitals.

OFFICE  
Lodz Special Economic Zone  
Europe



OFFICE  
VODAFONE-NIEDERLASSUNG  
Europe



SHOP  
Trzy Korony Shopping Mall  
Europe



SHOP  
El Mariachi Restaurant  
in USA



HOSPITAL  
CANCER CENTER BATNA  
Middle East



PUBLIC FACILITY  
Mosque  
Middle East



COMMERCIAL & RESIDENTIAL  
DARWIN CITY WATER FRONT  
Oceania

Fujitsu General's VRF has been installed in **over 50** countries worldwide.



OFFICE  
World Trade Center  
Asia



OFFICE  
Hangzhou Bai Fu Times Square  
Asia



RESIDENTIAL  
SKYLINE VILLA  
Asia

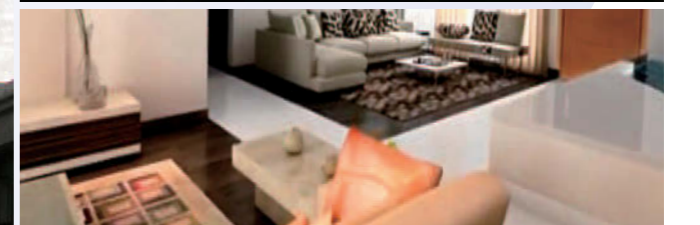

# CORE TECHNOLOGY

- 024 High Efficiency
- 026 Energy Saving Control
- 028 Comfort Performance
- 030 Easy-to-use Control
- 032 Smart Design

Our advanced technology is providing comfort in a wide variety of situations from residential applications to commercial use.

# High Efficiency

## Pursuit of Seasonal Efficiency

Over 90% of actual operation time, air conditioners are operated at partial capacity instead of rated capacity.

We focused on high seasonal efficiency by all DC inverter control and high efficiency technology.

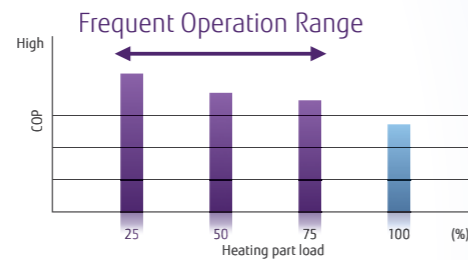

DC Twin Rotary Compressor

## Optimized Inverter Control

### i-PAM (IPM\* + PAM) inverter control

i-PAM inverter control is a technology which reduces loss by adjusting the current waveform to a better sine waveform. This promotes the effective use of the input power supply to attain high performance.

IPM\*: Intelligent Power Module

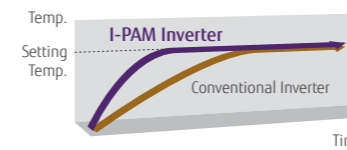

In addition, the voltage is raised at the start of operation and fast comfort is attainable by more powerful operation.

### V-PAM (Vector + I-PAM) inverter control

V-PAM inverter control reduces the effects of magnetic flux and increases the maximum speed and efficiency of the compressor by vector control technology. With this technology, further miniaturization, higher efficiency, and better performance are attained.

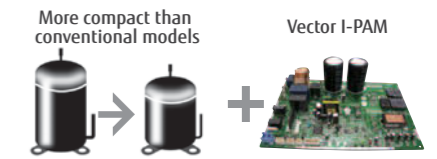

It becomes more powerful with the newly developed high efficient compressor motor control.



## All DC Inverter Technology

### DC twin rotary compressor

The high efficiency DC inverter type "2-cylinder rotary compressor" is used for our product ranges. It has achieved higher energy efficiency compared with similar compressors by optimizing the structure inside the compressor.

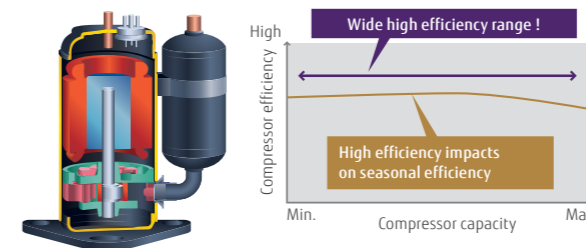

### DC fan motor

DC fan motor produces high power, wide operation range, and high efficiency.



### Sine-wave DC inverter control

High efficiency operation is realized by using a sine wave DC inverter control.

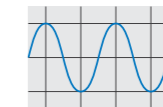

## High Efficiency Heat Exchanger

### High density multi-path heat exchanger

Heat exchange performance is substantially improved by thin and high-density heat exchanger and multi-path efficiency technology.

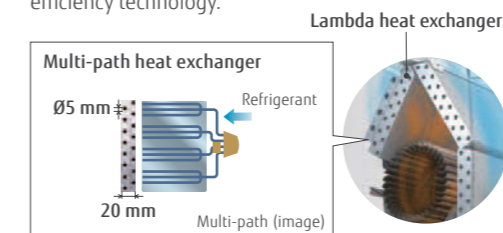

### High performance sub-cool heat exchanger

Higher performance achieved by mounting of counter type bypass circuit. (Large multi type, VRF)

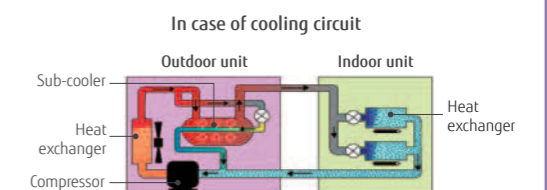

# Energy Saving Control



## Smart Operation



### Human sensor control

Human sensor catches movements of people in a room, and operates with lower capacity when people leave the room. When people come back to the room, it automatically returns to the previous operating mode.

Human sensor coverage

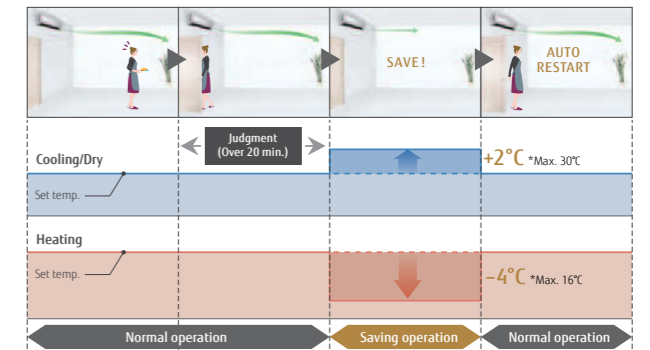

### Economy operation

Limits the maximum operation current, and the power consumption is cut down and the maximum load is suppressed.

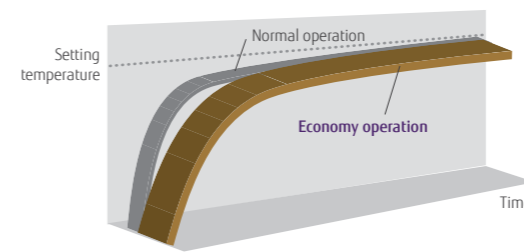

### Room temperature set point limitation

The minimum and maximum temperature range can be set giving further energy saving while considering the comfort of the occupants.

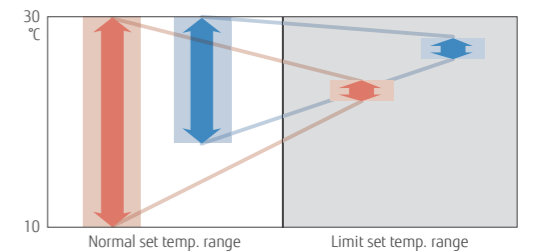

### Set temperature auto return

- The setting temperature automatically returns to the previous setting temperature.
- The time range in which the set temperature can be changed is 10 to 120 minutes.

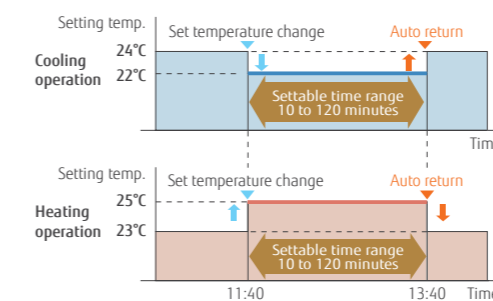

### Auto-off timer

- The indoor unit is turned off automatically when it reaches the preset operating time frame.
- The time frame of the "Auto off timer" can be flexibly scheduled.
- Off time can be set from 30 to 240 minutes.

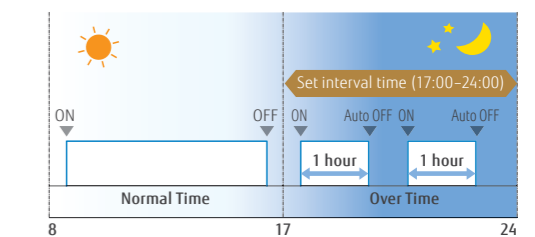

Example: At interval time hour (17:00-24:00) to prevent forgetting to turn off Set off time: 1 hour

# Comfort Performance

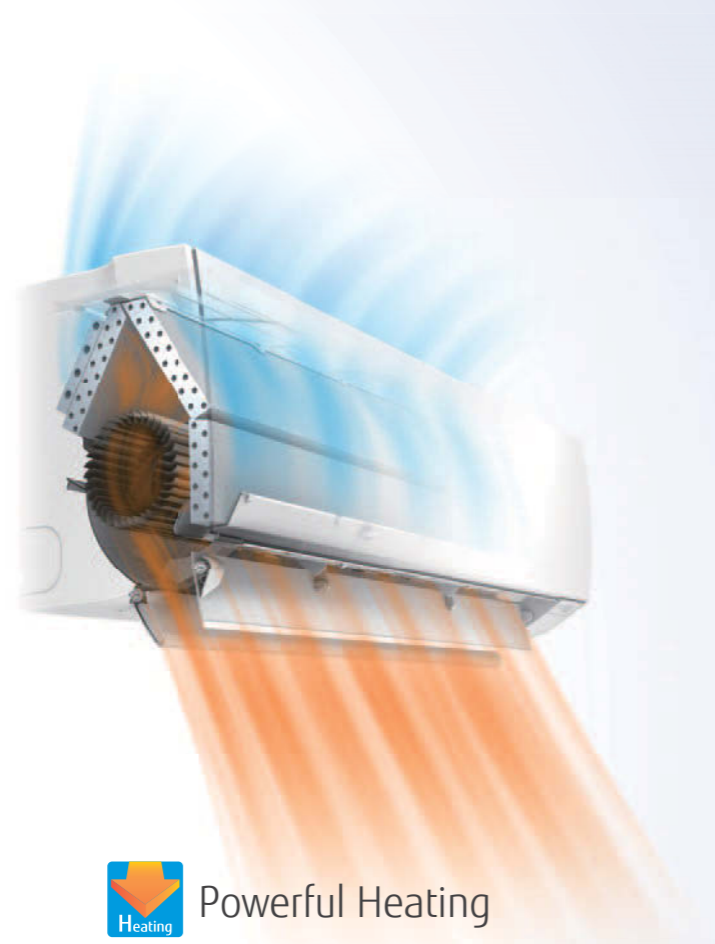

## Powerful Heating

High heating capacity is realized even at low outdoor temperature by mounting a large heat exchanger or large DC rotary compressor and developing high performance inverter PCB

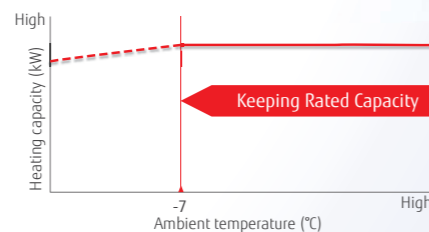

# Quick Comfort

## Power diffuser

Precision wind direction control is realized and ventilation efficiency is also improved by 3 technologies. Our airflow control makes your environment more comfortable.

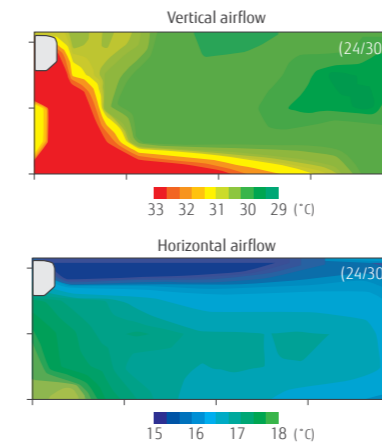

## Powerful operation

Continuous operation by maximum airflow and maximum compressor speed after a certain period of time allows the temperature to reach the setting temp. quickly.

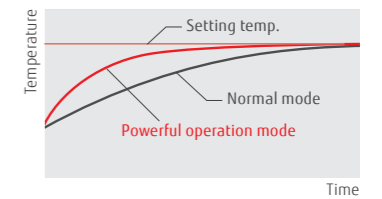

## 10°C HEAT

When you leave, minimum heating operation is performed to maintain the room temperature. (Maintained at 10°C)

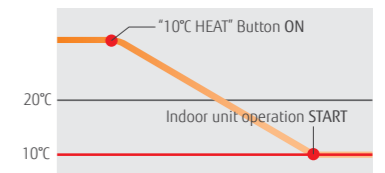

# Quiet and Comfort Control

## Outdoor unit low noise operation

Users can choose low noise levels, depending on the installation environment. The operation time can be set using the timer.

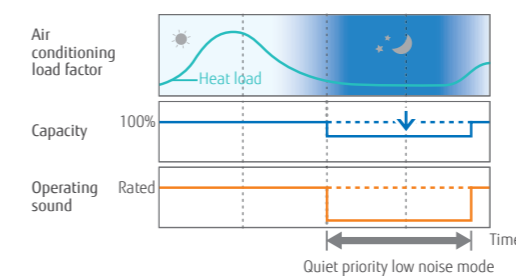

## Auto-changeover function

At Auto setting, the cooling/heating mode is automatically switched according to the set temperature and room temperature.

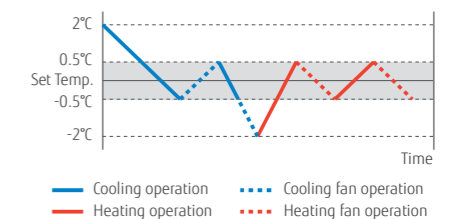

# Easy-to-use Control

Easy air conditioner control from inside or outside the house and office using the Smartphones, Tablets, and PC



It is the most advanced solution to remotely manage an Air Conditioning system using all sort of mobile devices such as Smartphones, Tablets, and PC.



## Fujitsu General provides Various Easy-to-use Controllers

Fujitsu General is using ergonomics to expand the use of easy-to-use designs such as easy-to-read large LCD panels, easy-to-operate buttons, and displays with easily recognizable icons.

The individual controllers match the user operational environments, and the home controller makes batch energy saving management easy. Ease of use was pursued using simple operation buttons, a large LCD screen, and other features.

### Residential use

Home central control



Simple individual control



Slim Wireless Remote Controller



Each floor or Small building management control



Individual & Simple central control

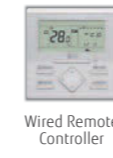

### Commercial use

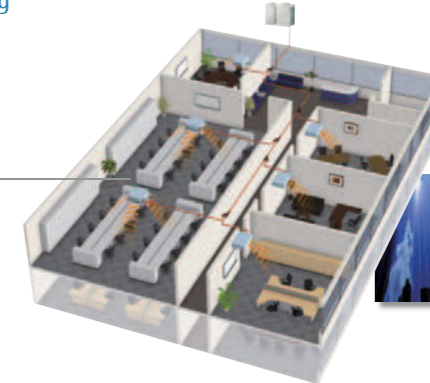

Large building management control



Fujitsu General provides an interface that supports central management systems such as KNX®, MODBUS®, BACnet®, and LONWORKS®.

This allows customers to easily perform central control and monitoring of air conditioning equipment.





# Smart Design

Creating Harmony and  
New Interior Design Space in a Variety  
of Installation Environments



Thinness and simplicity was thoroughly pursued in this design to fit the interior design. The lambda shaped high-density multi-path heat exchanger construction and full cover slide open panel provide both beauty and functionality.

The remote controller has also been designed utilizing ergonomics for ease of use while also pursuing beauty even in the details. Fujitsu General provides its customers with highly functional air conditioners designed with high artistic sensitivity

## Various Smart Design Models

High Spec. & Design



LT  
Series

ASYG09LTCA/ASYG12LTCA

High COP



LU  
Series

ASYG07LUCA/ASYG09LUCA/ASYG12LUCA/ASYG14LUCA



Standard



LM  
Series

ASYG07LMCA/ASYG09LMCA/ASYG12LMCA/ASYG14LMCA

Basic



LL  
Series

ASYG07LLCC/ASYG09LLCC/ASYG12LLCC

# SUPPORT

- 036 AIRSTAGE™ Support
- 038 Design Simulator
- 040 WATERSTAGE™ Support Tool
- 042 Quick Service and Maintenance

Our know-how supports you not only during the product release but also from guiding implementation to product maintenance.

# AIRSTAGE™ Support



Fujitsu General provides a variety of product and technical information to engineers and consultants, and also conducts new product research and design support activities. We provide a wide range of support to maintain high quality from design to installation.



## Technical information

We provide information and tools that are useful for air conditioning system design, such as unit performance data and tools that make model selection and estimation easy.

### Features

- Design & Technical Manual
- Model Selection & Estimation
- Certificate Data
- 2D/3D CAD Data

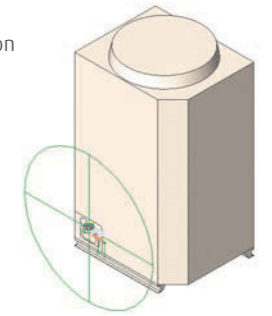

## Product information

New product information is provided in the form of documents and movies for every new model released. These can be downloaded from a private section of our website. To access this website, please contact your Fujitsu representative.

### Features

- Product News
- Brochures & All Manuals
- Feature Promotion Movie



Training for installer

## Training

Fujitsu General has 7 training facilities around the world that regularly conduct specialized product, technical, and service training. These research facilities also support the development of people with high technical capability.

### Features

- Designing AIRSTAGE™ Systems
- Control System on-site training



Presentation & training for dealers

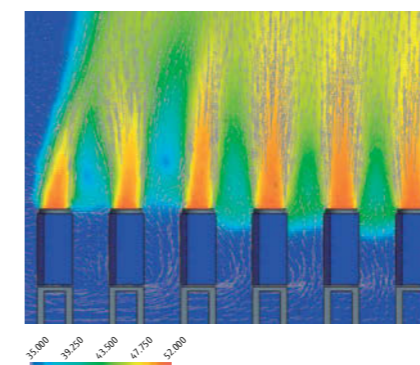

## Technical support

Technical support is provided at every stage from design to installation to assist in providing the most suitable air conditioning solution.

### Features

- CFD Simulation
- Guide line
- Commissioning Support



# Design Simulator

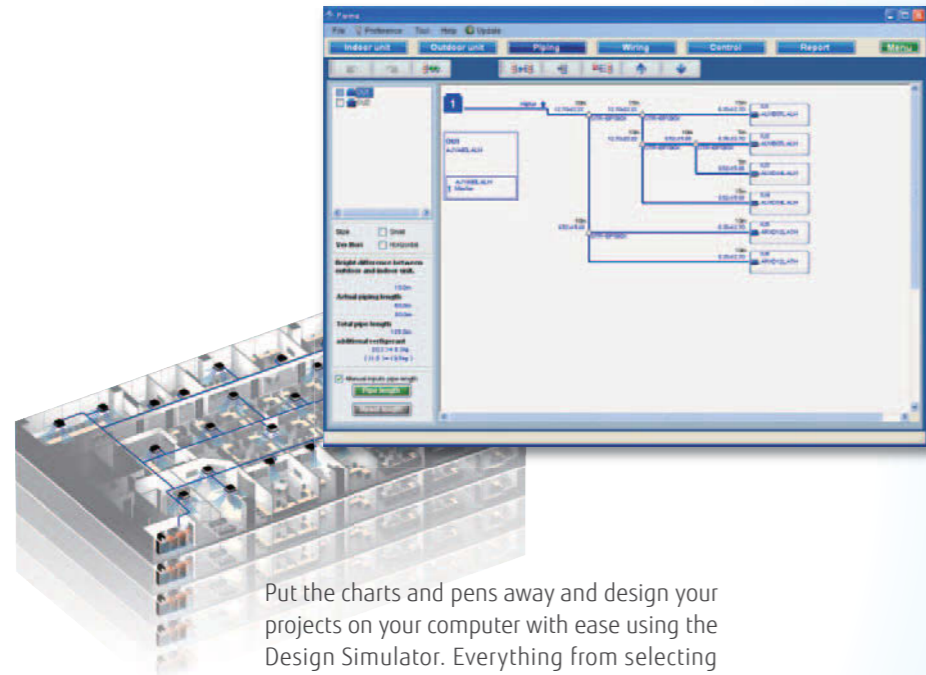

Put the charts and pens away and design your projects on your computer with ease using the Design Simulator. Everything from selecting indoor and outdoor units, allocating controls and optional parts to designing the piping and wiring systems is made easier using the program's built-in features. Once your project is designed take advantage of the Export functions to easily get materials lists, product specifications, refrigerant calculations and more - it'll even export to Word or Excel formats, and group the relevant CAD data for your project.

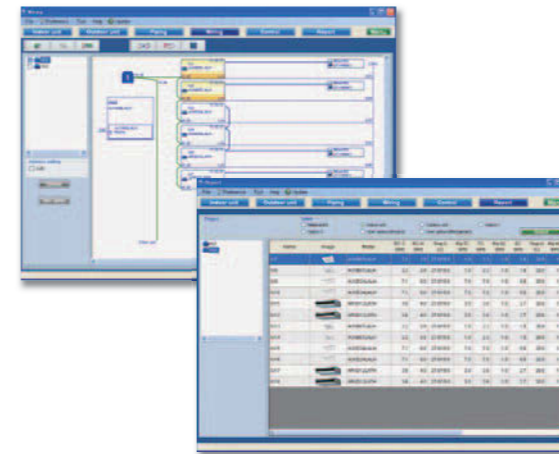

## Automatically create model selection information

- Each unit can be automatically set by entering the required performance, type, and temperature conditions for each indoor unit and then dragging and dropping into the outdoor unit.
- Piping and wiring diagrams can be created automatically and it is easy to set branches, grouping, and options.
- The additional refrigerant charging amount is automatically calculated when the pipe length is entered.
- It is also easy to set the remote controller groups, central controller and converters.
- The equipment list including the equipment information is created automatically.



## Output the format that matches the application

The information specific to your project can be exported in a number of industry standard file formats.

- Word format (rtf)
- Excel format (csv)
- Auto CAD format (DXF)
- 2D Data (DXF)
- 3D Data (RFA)

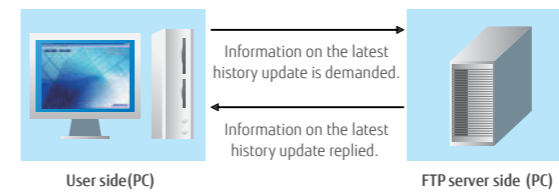

## Update your Design Simulator

Database can be easily updated online using AutoUpdate function through FTP.

## BIM Building Information Modeling

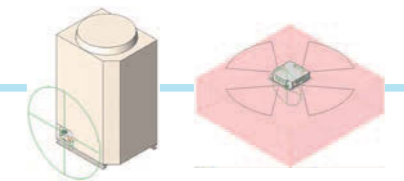

Fujitsu General provides the Building Information Modeling (BIM) object models and contents for our VRF system and some products to the architect, designer and contractor using Autodesk® Revit® technology from our Website and Autodesk® Seek Website, etc.

### 3D and 2D product data

We provide 3D data that closely resemble the actual product appearance. 2D CAD design operations are supported and 2D display is also provided. The data can also be output in other formats, such as DXF and DWG, which are used by other design CAD.

### Installation limitation

The equipment installation limitation range is shown. Installation requirements, such as distance from the wall, is automatically displayed to make it easy to produce highly reliable layout designs.

### Installation information

Other information, such as symbols showing the airflow direction that are required for installation drawings, is built in and can be automatically reflected in 2D drawings. Installation drawings can be created easily.

### Product specifications & link information

Contains the basic information required for air conditioner design, including unit size, capacity, input power, noise, and airflow rate. These data can be procured from the Fujitsu General Website, Design Simulator, and Autodesk® Seek Website.

# WATERSTAGE™ Support Tool



Room Heating



Hot Water



Fujitsu General's new software for the WATERSTAGE™ automatically provides a combination of WATERSTAGE™ equipments just by giving few parameters.

The software is featured with multiple languages, and automatic update function.



Smartphone Control

## Model Selection with Detailed Technical Information



The software automatically selects the equipments just by inputting some factors, like the region where the equipment is installed, required capacity to heat up the space, and a heating method. The transition in the equipment capacity at each outdoor temperature condition and/or when back up heater is under operation can be easily created by this software.

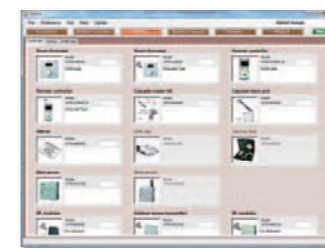

The visible images of the optional items enables the correct configuration of the systems.

All of the associated optional items are automatically chosen in a case the application requires several devices of the WATERSTAGE™ equipments.

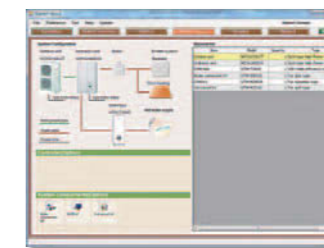

The entire system configuration can be reviewed and modified once the units are selected. And by seeing the images and the list of equipments at the same time, it avoids mistake in the selection of equipments.



The software automatically provides graphs of monthly running cost, CO<sub>2</sub> emission volume, cost comparison against other heating sources, and other data to allow the users to see at a glance the financial benefit of choosing WATERSTAGE™ equipments.

### Estimate Function

The software automatically provides the cost estimate of the entire WATERSTAGE™ system, not only the equipment itself but also the optional items.

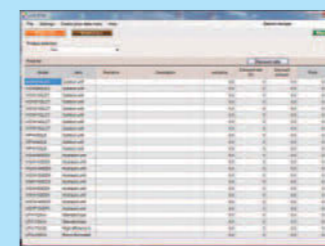

### Outputting to documents or to files

Various kinds of documents such as an equipment list, a system diagram, a cost estimate table, and an equipment CAD data can be printed out to paper or output into the files. This function also comes with a feature which allows you to change the template design of the documents.

### Software updates

The database can be automatically updated through FTP by automatic update function.

# Quick Service and Maintenance

If trouble should occur in a unit or system, abundant support tools such as trouble code display at the product, Service Tool that allows checking of the detailed status of the entire system, and remote monitoring tool that uses the internet, etc. support quick service and maintenance anywhere and at any time.

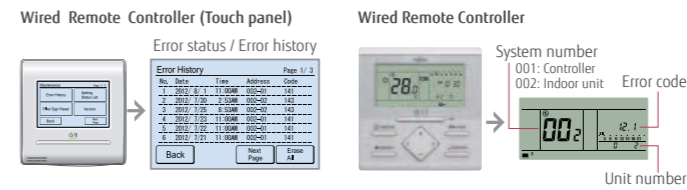

## Design for easy maintenance

The air conditioner operating status and trouble status of the detailed are displayed at the 7-segment of the outdoor unit PCB or on the remote controller screen. The unit status can be checked rapidly and quick response is also possible.

- Operation mode status
- Discharge temperature/Pressure status
- Compressor operation indication
- Address/Type/Number of outdoor unit
- Error code

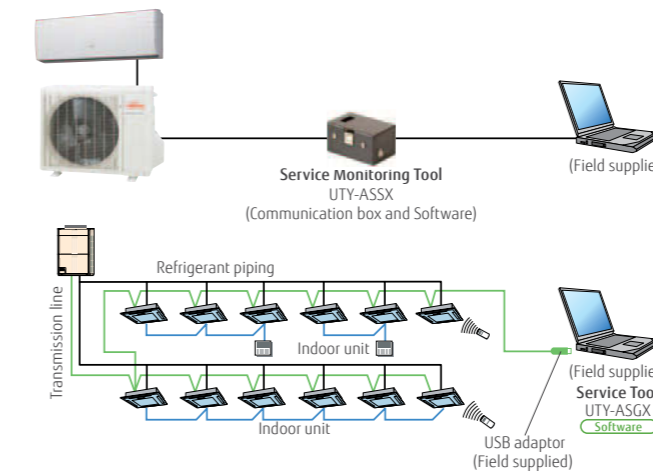

## Error diagnosis by Service Tool

The unit status details from single split models to VRF system can be checked on PC screen by connecting Service Tool. Quick countermeasures can be taken

- Operation status/control
- Monitoring operating condition
- Monitoring sensor data
- Indication of trend graph
- Error history
- Indication of refrigerant circuit diagram (For VRF)

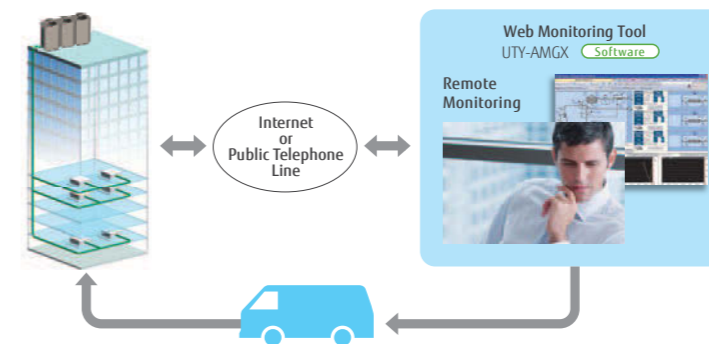

## Remote monitoring

VRF system operating status and trouble status details can be constantly and remotely monitored over the Internet, etc. Rapid cooperation with the service personnel are also possible.

## Mobile trouble shooting tool for iPhone

We will release an App of troubleshooting tool for iPhone, iPod touch and other Apple products. This application is a troubleshooting tool for Fujitsu General air conditioner (RAC/PAC, VRF)

It helps you to check air conditioner condition. Error code check, Troubleshooting, and Sensor check are available.

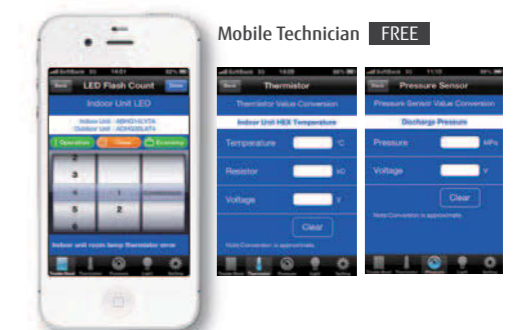

# PRODUCT CATEGORY

046 2015 Fujitsu General Solutions



SPLIT

048



MULTI SPLIT

084



OPTIONAL PARTS  
for SPLIT & MULTI SPLIT

108



V R F

116



VENTILATION

186



OPTIONAL PARTS  
for VRF

194



AIR TO WATER

200

# 2015 FUJITSU GENERAL SOLUTIONS

## SPLIT

Future Release



Page 055

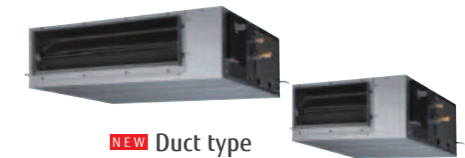

**NEW** Duct type

### Features

- 12 to 54 types, 8 models
- Top class energy efficiency
- Wide range static pressure 0 to 200 Pa
- Built-in drain pump
- Automatic airflow adjustment function

**NEW** Large Wall Mounted type

### Features

- 30/36 type
- Powerful heating capacity
- Low ambient operation



Page 054

**NEW** Compact Cassette & Cassette type

### Features

- 9 to 54 types, 11 models
- New smart design
- Top class energy efficiency
- 3D Wide airflow
- Independent Airflow control



Page 054

## VRF

Page 138



**NEW** VRF system Modular Heat Pump type

### Features

- Up to 54HP with newly added 18HP outdoor unit combination.
- Connectable indoor unit, 12 types 58 models
- Connectable indoor unit number up to 64
- Advanced energy saving control
- Actual piping length up to 165 m, High static pressure of 82 Pa

**AIRSTAGE™ V-III**

## AIR TO WATER

Page 206



**NEW** 5 kW Monobloc series with hydraulic unit

### Features

- 5 kW Monobloc series with hydraulic unit
- 55°C hot water supply even at -20°C outdoor temperature
- Heating and DHW in one system
- Hydraulic unit can be connected

**WATERSTAGE™**





Energy saving design to provide a comfortable indoor environment while being environment-friendly.

# SPLIT



SPLIT













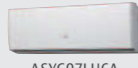



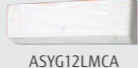

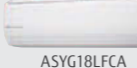

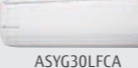
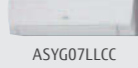

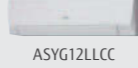

































An air conditioner that is people-friendly is also environment-friendly. Fujitsu General offers a broad lineup of products from large living rooms to bedrooms and children's rooms. We make your room more comfortable with a wide range of air conditioner types from ceiling wall type with automatic filters and cleaning functions to wall mounted type that improve the air cleaning function. Of course these models feature highly efficient operation that conserves electricity.

## 10 types 64 models

- 050 All Type Lineup
- 052 Feature Explanation
- 054 **Future Release** Compact Cassette & Cassette
- 055 **Future Release** Medium & High Static Pressure Duct
- 056 Wall Mounted
- 066 Floor
- 068 Compact Cassette
- 070 Cassette
- 072 Floor/ceiling
- 074 Ceiling
- 076 Slim Duct
- 078 Medium Static Pressure Duct
- 080 High Static Pressure Duct

# ALL TYPE LINEUP

ALL **INVERTER** MODELS

Capacity (kW)	2.0	2.6	3.5	4.1	5.3	7.1	8.8	10.6	12.5	14.0	15.0	20.0	25.0
Model Code	7	9	12	14	18	24	30	36	45	54	60	72	90
Wall Mounted	High Spec. & Design Page 56												
	High COP Page 58												
	Standard Page 60/64												
	Basic Page 62												
Floor Page 66													
Compact Cassette Page 68													
Compact Cassette Page 54 <b>Future Release</b>		<b>NEW</b> 	<b>NEW</b> 	<b>NEW</b> 	<b>NEW</b> 	<b>NEW</b> 							
Cassette Page 70													
Cassette Page 54 <b>Future Release</b>				<b>NEW</b> 	<b>NEW</b> 		<b>NEW</b> 	<b>NEW</b> 	<b>NEW</b> 	<b>NEW</b> 			
Floor/Ceiling Page 72													
Ceiling Page 74													
Slim Duct Page 76													
Medium Static Pressure Duct Page 78													
Medium Static Pressure Duct Page 55 <b>Future Release</b>			<b>NEW</b> 	<b>NEW</b> 	<b>NEW</b> 	<b>NEW</b> 	<b>NEW</b> 	<b>NEW</b> 	<b>NEW</b> 	<b>NEW</b> 			
High Static Pressure Duct Page 80 ~													

## Energy Saving Function



**Human sensor**  
Human sensor detects the movement of people in the room and judges whether the energy saving operation.



**Economy mode**  
Thermostat setting automatically changes according to the temperature to avoid unnecessary cooling and heating.



**Room temperature set point limitation**  
The minimum and maximum temperature range can be set giving further energy saving while considering the comfort of the occupants.



**Set temperature auto return**  
The setting temperature automatically returns to the previously set temperature.

## Comfortable Function



**Powerful heating**  
Keeping the rated heating capacity even when the outdoor ambient temperature is -7°C.



**Power diffuser**  
An additional louver that opens based on monitoring sensors to quickly enhance immediate comfort needs.



**Powerful mode**  
Operation at maximum air flow and compressor speed, and quickly makes the room comfortable.



**10°C HEAT operation**  
The room temperature can be set to go no lower than 10°C, thus ensuring that the room does not get too cold when not occupied.



**Low noise mode**  
Sound noise level of outdoor unit can be selected.



**Auto-changeover**  
The unit automatically switches between heating and cooling modes based on your temperature setting and the room temperature.



**Up / down swing flaps**  
The up / down flaps automatically swing up and down.



**Double swing automatic**  
Complex swing action of flaps enables automatically to swing both horizontal and vertical directions.



**Automatic fan speed**  
The micro-computer automatically adjusts the airflow effectively to follow the changes of room temperature.



**Auto restart**  
In the event of a temporary power failure, the air conditioner will automatically restart in the same operating mode as before, once power supply is restored.



**Connectable fresh air duct**  
Outside air can be introduced by attaching field supplied duct to fresh air knockout and optional part.



**Fresh air intake**  
Fresh air can be taken in by a fan which can be connected using external control unit.



**Connectable distributing duct**  
Systems are capable of attaching field-supplied branch ducts distributing the airflow.



**Individual airflow direction control**  
Each louver of 4-way Cassette type can be controlled individually and provides comfortable airflow.

## Convenient Function



**Auto off timer**  
Automatically stops operation when a fixed time has elapsed from the start of operation.



**Sleep timer**  
The micro-computer gradually changes the room temperature automatically to afford a comfortable night's sleep.



**Program timer**  
This digital timer allows selection of one of four options: ON, OFF, ON → OFF or OFF → ON.



**Weekly timer**  
Different ON-OFF times can be set for each day.



**Weekly + setback timer**  
Weekly + Setback timer can set temperature for two times spans and for each day of the week.



**Filter sign**  
Indicates the filter cleaning period by lamp.

## Clean Function



**Ion deodorization filter**  
The filter deodorizes by powerfully decomposing absorbed odors using the oxidizing and reducing effects of ions generated by the ultra-fine-particle ceramic.



**Apple-catechin filter**  
The Apple-catechin filter uses static electricity to clean fine particles and dust in the air.



**Washable panel**  
Since the front panel is easy to remove, maintenance is also easy.



All DC models



**i-PAM control models**  
i-PAM inverter control is a technology which reduces loss by adjusting the current waveform to a better sine waveform.



**V-PAM control models**  
V-PAM inverter control reduces the effects of magnetic flux and increases the maximum speed and efficiency of the compressor by vector control technology.

## Feature Summary

	Wall Mounted	Compact Cassette	Floor/Ceiling	Ceiling	Slim Duct	Medium Static Pressure Duct	High Static Pressure Duct
	ASYG07109/12/14/LCA	ASYG07109/12/14/LUCA	ASYG07109/12/14/LMCA	ASYG07109/12/LCC	AGYG0912/14/LVCA	AUYG12/14/18/LVLB, AUYG18/24/30/36/45/54****	AUYG30/36/LRL, AUYG18/24/30/36/45/54****
<b>Energy Saving Function</b>							
Human sensor	●				○		
Economy mode	●	●	●	●	●	●	●
Room temperature set point limitation	○	○	○	○	●	○	○
Set temperature auto return	○	○	○	○	○	○	○
<b>Comfortable Function</b>							
Powerful heating	●						
Power diffuser		●		●			
Powerful mode	●	●	●	●			
10°C HEAT operation	●	●	●	●	○	○	○
Low Noise mode	●	●	●		○ (36/45/54)	○ (45/54) (36/LRLA)	○ (45/54) (36/LRLA)
Auto-changeover	●	●	●	●	●	●	●
Up / down swing flaps	●	●	●	●	●	○	
Double swing automatic				●		●	
Automatic fan speed	●	●	●	●	●	●	●
Auto restart	●	●	●	●	●	●	●
Connectable fresh air duct					○	●	●
Fresh air intake					○	○	○
Connectable distributing duct						●	
Individual airflow direction control					●		
<b>Convenient Function</b>							
Auto off timer	○	○	○	○	○	○	○
Sleep timer	●	●	●	●	○	○	○
Program timer	●	●	●	●	○	○	○
Weekly timer	●	●	●	●			●
Weekly + setback timer	○	○	○	○	○	○	○
Filter sign	●	●	●	●	●	●	●
<b>Clean Function</b>							
Ion deodorization filter	●	●	●	●	●		
Apple-catechin filter	●	●	●	●	●		
Washable panel		●	●	●	●		

○: Optional function

# 2015 New Products Features

## NEW COMPACT CASSETTE



**Model :**  
 AUYG09 \*\*\* / AUYG12 \*\*\* / AUYG14 \*\*\*  
 AUYG18 \*\*\* / AUYG24 \*\*\*



## 3D airflow

Achieve a comfortable air conditioning spread to every corner of the room by seamless wide airflow & wide vertical airflow!

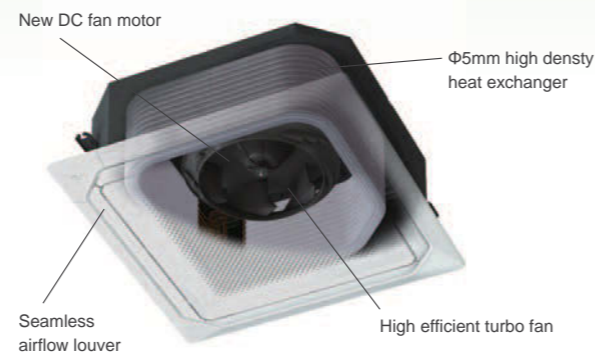

## Uniform temperature air conditioning by seamless airflow

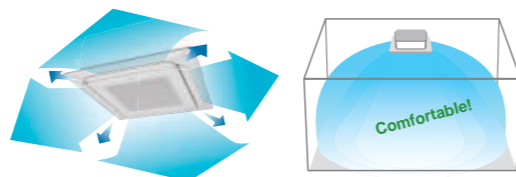

## NEW CASSETTE



**Model :**  
 AUYG18 \*\*\* / AUYG24 \*\*\* / AUYG30 \*\*\*  
 AUYG36 \*\*\* / AUYG45 \*\*\* / AUYG54 \*\*\*



## Individual airflow direction control

Each louver can be set individually using wired remote controller to perform the air conditioning without draft, swing air blow to the room door, and airflow direction control according to the room layout change.

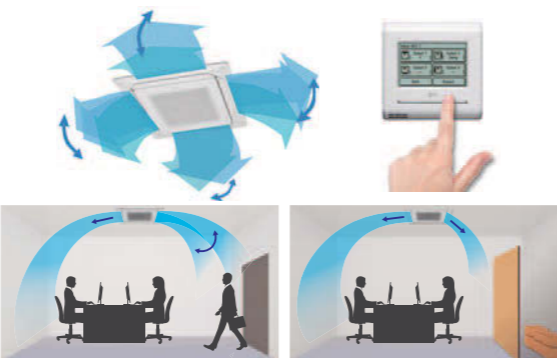

Comfortable air conditioning by draft prevention and swing air blow

Efficient air conditioning based on the room layout

## Human sensor increases more energy saving

• Human sensor (Option)

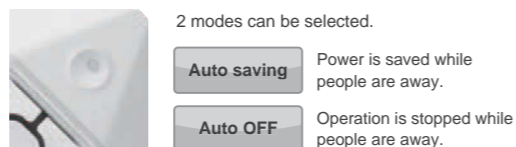

## NEW MEDIUM & HIGH STATIC PRESSURE DUCT



**Model :**  
 ARYG12 \*\*\* / ARYG14 \*\*\*



**Model :**  
 ARYG18 \*\*\* / ARYG24 \*\*\* / ARYG30 \*\*\*



**Model :**  
 ARYG36 \*\*\* / ARYG45 \*\*\* / ARYG54 \*\*\*

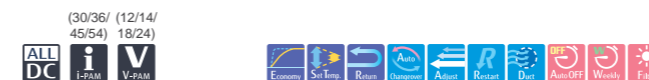

## Design flexibility

Top class compact design and wide range static pressure

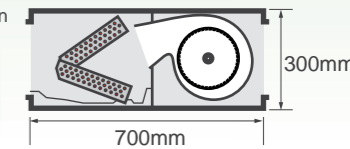

All models are up to the maximum static pressure of 200Pa. Design flexibility has been significantly improved.

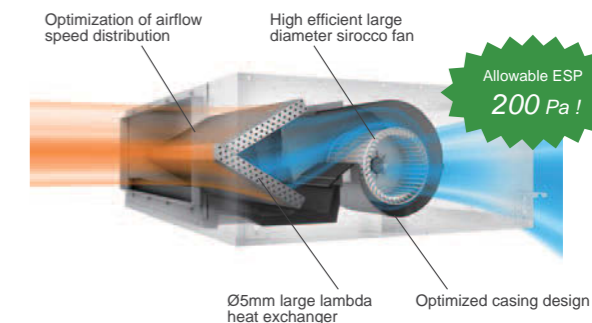

## Easy Installation and maintenance

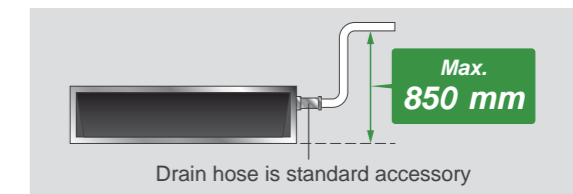
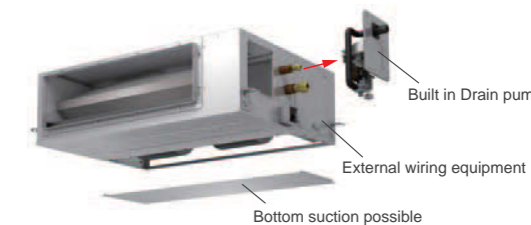

## Automatic airflow adjustment function

This function can set the optimum airflow automatically, so installation time is shortened drastically.



High Spec. & Design : ASYG09LTCA / ASYG12LTCA



Features

Thin & Slim design

Thin and slim design is realized by high density multi-path heat exchanger and high efficiency wind blower.

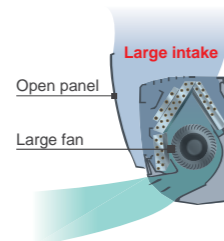

Powerful heating

Rated heating capacity is maintained up to an outdoor temperature lower than -7 °C. This new model can operate even at -20 °C low outdoor temperature.

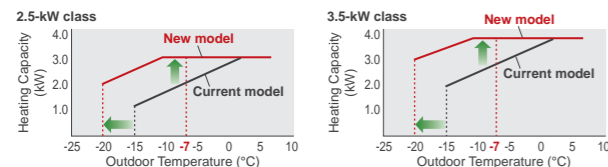

Powerful operation mode

20 minutes continuous operation by maximum airflow and maximum compressor speed is possible. Rapid cooling and heating makes the room comfortable quickly.

10°C HEAT Operation

The room temperature can be set to go no lower than 10°C, thus ensuring that the room does not get too cold when not occupied. \*Only available with Wireless RC.

Low noise mode for outdoor unit

Low noise mode of outdoor unit can be selected by wireless remote controller.

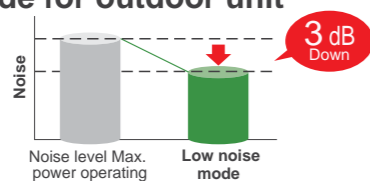

Energy saving control

Human sensor catches movements of people in a room, and operates with lower capacity when people leave the room. When people come back to the room, it automatically returns to previous operating mode.



3 Mode timer (Weekly/Program/Sleep)

Weekly timer can be easily set by wireless remote controller. ON, OFF can be set up to 4 times in 1 day and up to 28 times in 1 week. For other modes, program timer and sleep timer can be also selected by one push.



Low ambient operation

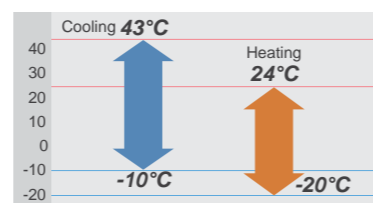

Optional parts

- Wired Remote Controller: UTY-RNNYM / UTY-RVNYM
- Simple Remote Controller: UTY-RSNYM
- Communication kit: UTY-TWBXF

Specifications

Model No.	Indoor unit		ASYG09LTCA		ASYG12LT CA	
	Outdoor unit		AOYG09LTC		AOYG12LTC	
Power Source	V/Ø/Hz		230/1/50		230/1/50	
Capacity	Cooling	kW	2.5 (0.9-3.5)		3.5 (1.1-4.0)	
	Heating	kW	3.2 (0.9-5.4)		4.0 (0.9-6.5)	
Input Power	Cooling/Heating		kW		0.505/0.660	
	Cooling	W/W	4.95		4.12	
EER	Cooling		W/W		4.85	
	Heating	W/W	4.85		4.40	
Pdesign	Cooling/Heating (@-10°C)		kW		2.5/3.0	
	Cooling	W/W	8.50		8.50	
SEER	Cooling		W/W		4.60	
	Heating (Average)	W/W	4.60		4.60	
SCOP	Cooling		A+++		A+++	
	Heating (Average)		A++		A++	
Running Current	Cooling/Heating		A		4.0/4.3	
	Cooling	kWh/a	103		144	
Annual Energy Consumption	Heating		kWh/a		912	
	Heating		kWh/a		1217	
Moisture Removal	Cooling		l/h		1.3	
	Heating (Average)		l/h		1.8	
Sound Pressure (Cooling)	Indoor	H/M/L/Q	dB(A)		42/36/32/21	
	Outdoor	High	dB(A)		48	
	Indoor	High	dB(A)		59	
Sound Power (Cooling)	Outdoor		High		63	
	Outdoor		High		64	
Airflow Rate (High)	Indoor / Outdoor		m³/h		800/1,700	
	Indoor		mm		282x870x185	
Net Dimension H x W x D	Indoor		kg(lbs)		9.5 (21)	
	Outdoor		kg(lbs)		40 (88)	
Piping Connections (Small / Large)	Indoor		mm		6.35/9.52	
	Outdoor		mm		6.35/9.52	
Drain hose Diameter (I.D./O.D.)	Indoor		mm		13.8/15.8 to 16.7	
	Outdoor		mm		13.8/15.8 to 16.7	
Max Pipe Length (Pre-Charge)	Indoor		m		20 (15)	
	Outdoor		m		20 (15)	
Max Height Difference	Indoor		m		15	
	Outdoor		m		15	
Operation Range	Cooling		°CDB		-10 to 43	
	Heating		°CDB		-20 to 24	
Refrigerant (Global Warming Potential)					R410A (1,975)	

Dimensions Models: ASYG09LTCA / ASYG12LTCA

(Unit : mm)

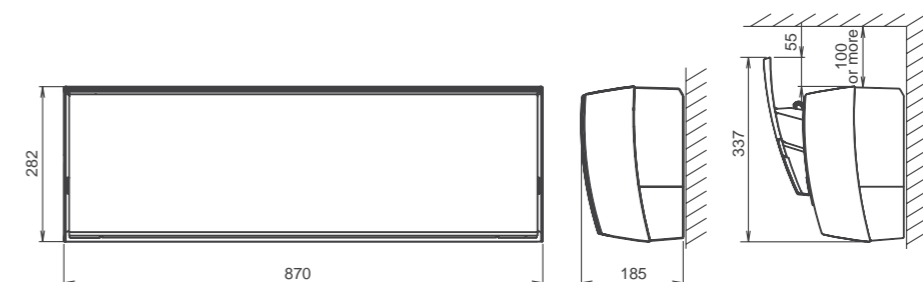

High COP : ASYG07LUCA / ASYG09LUCA / ASYG12LUCA / ASYG14LUCA



Wireless R.C.



For ASYG07/09LUCA



For ASYG12/14LUCA



Features

Thin & Slim design

Thin and slim design is realized by Ø5-mm heat exchanger and high efficiency wind blower.

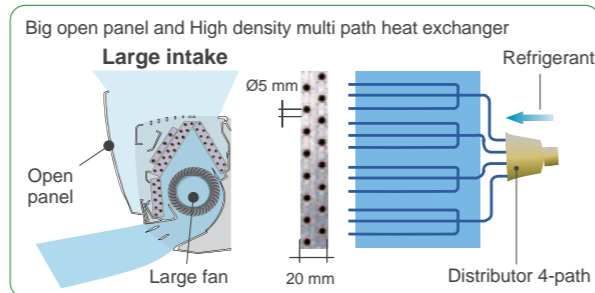

Powerful operation

20 minutes continuous operation by maximum airflow and maximum compressor speed is possible. Rapid cooling and heating makes the room comfortable quickly.

10°C HEAT Operation

The room temperature can be set to go no lower than 10°C, thus ensuring that the room does not get too cold when not occupied.

\*Only available with Wireless RC.

3 Mode timer (Weekly/Program/Sleep)

Weekly timer can be easily set by wireless remote controller. ON, OFF can be set up to 4 times in 1 day and up to 28 times in 1 week. For other modes, program timer and sleep timer can be also selected by one push.



Low ambient operation

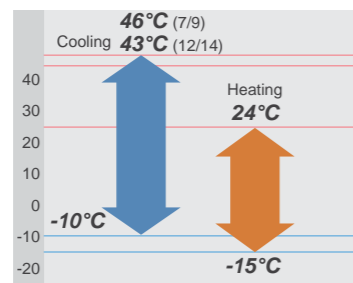

Low noise mode for outdoor unit

Low noise mode of outdoor unit can be selected by wireless remote controller.

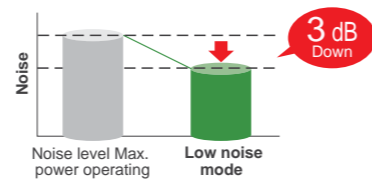

Optional parts

- Wired Remote Controller: UTY-RNNYM, UTY-RVNYM
- Simple Remote Controller: UTY-RSNYM
- Communication kit: UTY-TWBXF

Specifications

Model No.	Indoor unit		ASYG07LUCA	ASYG09LUCA	ASYG12LUCA	ASYG14LUCA
	Outdoor unit		AOYG07LUCA	AOYG09LUCB	AOYG12LUC	AOYG14LUC
Power Source	V/Ø/Hz		230/1/50	230/1/50	230/1/50	230/1/50
Capacity	Cooling	kW	2.0 (0.5-3.0)	2.5 (0.5-3.2)	3.5 (0.9-4.0)	4.2 (0.9-5.0)
	Heating	kW	3.0 (0.5-4.0)	3.2 (0.5-4.2)	4.0 (0.9-5.6)	5.4 (0.9-6.0)
Input Power	Cooling/Heating	kW	0.460/0.660	0.555/0.680	0.905/0.930	1.235/1.380
EER	Cooling	W/W	4.35	4.50	3.87	3.40
COP	Heating	W/W	4.55	4.71	4.30	3.91
Pdesign	Cooling/Heating (@-10°C)	kW	2.0/2.6	2.5/2.8	3.5/3.9	4.2/4.8
SEER	Cooling	W/W	7.20	7.10	7.05	6.78
SCOP	Heating (Average)	W/W	4.10	4.10	4.00	4.00
Energy Efficiency Class	Cooling		A++	A++	A++	A++
	Heating (Average)		A+	A+	A+	A+
Running Current	Cooling/Heating	A	2.6/3.4	3.1/3.4	4.6/4.7	5.8/6.3
Annual Energy Consumption	Cooling	kWh/a	97	123	174	217
	Heating	kWh/a	887	956	1363	1677
Moisture Removal		l/h	1.0	1.3	1.8	2.1
Sound Pressure (Cooling)	Indoor	H/M/L/Q	38/35/31/21	42/36/32/21	43/37/32/21	45/40/33/25
	Outdoor	High	46	48	50	50
Sound Power (Cooling)	Indoor	High	57	59	60	60
	Outdoor	High	58	60	65	65
Airflow Rate (High)	Indoor / Outdoor	m³/h	680/1,720	800/1,720	850/1,940	900/1,940
Net Dimension H x W x D	Indoor	mm	282x870x185	282x870x185	282x870x185	282x870x185
		kg(lbs)	9.5 (21)	9.5 (21)	9.5 (21)	9.5 (21)
	Outdoor	mm	540x660x290	540x660x290	540x790x290	540x790x290
		kg(lbs)	23 (51)	25 (55)	33 (73)	34 (75)
Piping Connections (Small / Large)		mm	6.35/9.52	6.35/9.52	6.35/9.52	6.35/12.7
Drain Hose Diameter (I.D./O.D.)			13.8/15.8 to 16.7	13.8/15.8 to 16.7	13.8/15.8 to 16.7	13.8/15.8 to 16.7
Max Pipe Length (Pre-Charge)		m	20 (15)	20 (15)	20 (15)	20 (15)
Max Height Difference			15	15	15	15
Operation Range	Cooling	°CDB	-10 to 46	-10 to 46	-10 to 43	-10 to 43
	Heating	°CDB	-15 to 24	-15 to 24	-15 to 24	-15 to 24
Refrigerant (Global Warming Potential)			R410A (1,975)	R410A (1,975)	R410A (1,975)	R410A (1,975)

Dimensions Models : ASYG07LUCA / ASYG09LUCA / ASYG12LUCA / ASYG14LUCA

(Unit : mm)

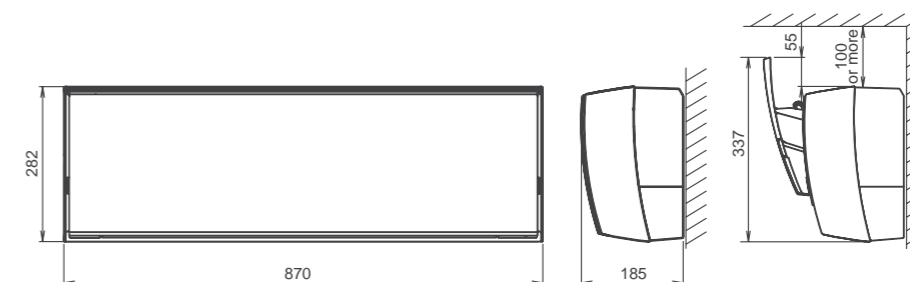

Standard : ASYG07LMCA / ASYG09LMCA / ASYG12LMCA / ASYG14LMCA

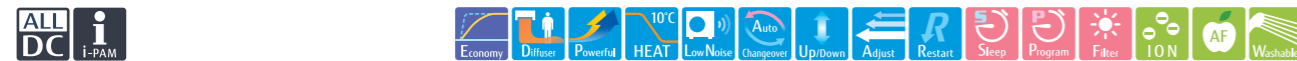

Features

High efficient compact design

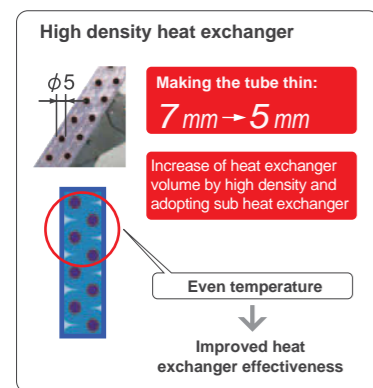

More comfort airflow

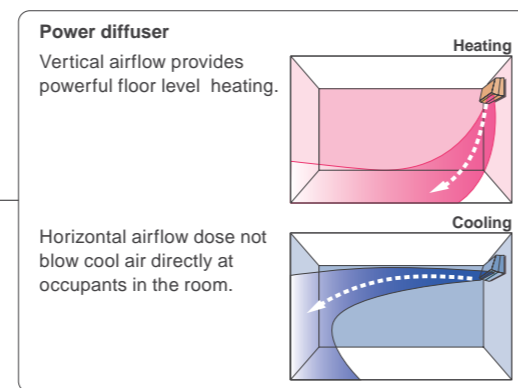

Powerful operation

20 minutes continuous operation by maximum airflow and maximum compressor speed is possible. Rapid cooling and heating makes the room comfortable quickly.

24 hr Programmable timer

24 hr program timer and sleep timer can be easily set.



10°C HEAT Operation

The room temperature can be set to go no lower than 10°C, thus ensuring that the room does not get too cold when not occupied

Low ambient operation

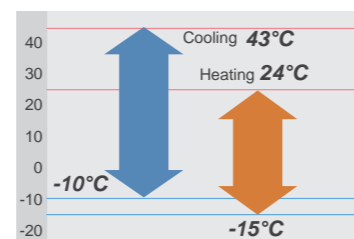

Low noise mode for outdoor unit

Low noise mode of outdoor unit can be selected by wireless remote controller.

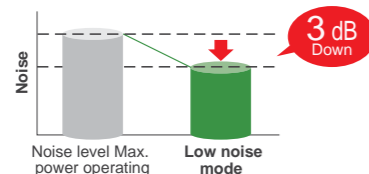

Optional parts

- Wired Remote Controller: UTY-RNNYM, UTY-RVNYM
- Simple Remote Controller: UTY-RSNYM
- Communication kit: UTY-XCBXZ2

Specifications

Model No.	Indoor unit		ASYG07LMCA	ASYG09LMCA	ASYG12LMCA	ASYG14LMCA
	Outdoor unit		AOYG07LMCA	AOYG09LMCA	AOYG12LMCA	AOYG14LMCA
Power Source	V/∅/Hz		230/1/50	230/1/50	230/1/50	230/1/50
Capacity	Cooling	kW	2.0 (0.5-3.0)	2.5 (0.5-3.2)	3.4 (0.9-3.9)	4.0 (0.9-4.4)
	Heating	kW	3.0 (0.5-3.4)	5.0 (0.5-4.0)	4.0 (0.9-5.3)	5.0 (0.9-6.0)
Input Power	Cooling/Heating	kW	0.465/0.685	0.65/0.73	0.97/1.02	1.135/1.365
EER	Cooling	W/W	4.30	3.85	3.50	3.52
COP	Heating	W/W	4.38	4.38	3.92	3.66
Pdesign	Cooling/Heating (@-10°C)	kW	2.0/2.3	2.5/2.4	3.4/3.5	4.0/3.9
SEER	Cooling	W/W	6.80	7.00	7.00	6.90
SCOP	Heating (Average)	W/W	4.10	4.10	4.00	4.00
Energy Efficiency Class	Cooling		A++	A++	A++	A++
	Heating (Average)		A+	A+	A+	A+
Running Current	Cooling/Heating	A	2.5/3.3	3.2/3.5	4.6/4.8	5.3/6.3
Annual Energy Consumption	Cooling	kWh/a	103	125	170	203
	Heating	kWh/a	786	820	1225	1365
Moisture Removal		l/h	1.0	1.3	1.8	2.1
Sound Pressure (Cooling)	Indoor	H/M/L/Q	43/40/32/21	43/40/32/21	43/40/32/21	44/40/33/25
	Outdoor	High	45	45	50	49
Sound Power (Cooling)	Indoor	High	59	59	59	60
	Outdoor	High	58	58	61	63
Airflow Rate (High)	Indoor / Outdoor	m³/h	750/1670	750/1670	750/1830	750/1800
		mm	268X840X203	268X840X203	268X840X203	268X840X203
Net Dimension H x W x D	Indoor	kg(lbs)	8.5 (19)	8.5 (19)	8.5 (19)	8.5 (19)
	Outdoor	mm	535X663X293	535X663X293	535X663X293	540X790X290
		kg(lbs)	21 (46)	21 (46)	26 (57)	34 (75)
Piping Connections (Small / Large)		mm	6.35/9.52	6.35/9.52	6.35/9.52	6.35/12.7
Drain Hose Diameter (I.D./O.D.)			13.8/15.8 to 16.7	13.8/15.8 to 16.7	13.8/15.8 to 16.7	13.8/15.8 to 16.7
Max Pipe Length (Pre-Charge)		m	20 (15)	20 (15)	20 (15)	20 (15)
Max Height Difference			15	15	15	15
Operation Range	Cooling	°CDB	-10 to 43	-10 to 43	-10 to 43	-10 to 43
	Heating	°CDB	-15 to 24	-15 to 24	-15 to 24	-15 to 24
Refrigerant (Global Warming Potential)			R410A (1,975)	R410A (1,975)	R410A (1,975)	R410A (1,975)

Dimensions Models : ASYG07LMCA / ASYG09LMCA / ASYG12LMCA / ASYG14LMCA (Unit : mm)

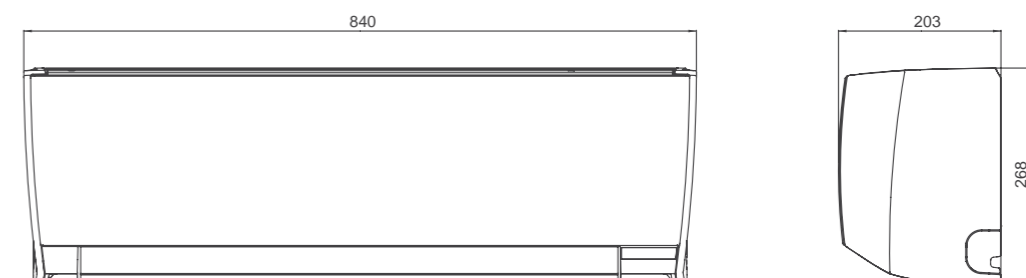

Basic : ASYG07LLCC / ASYG09LLCC / ASYG12LLCC



Wireless R.C.



Features

High efficient compact design

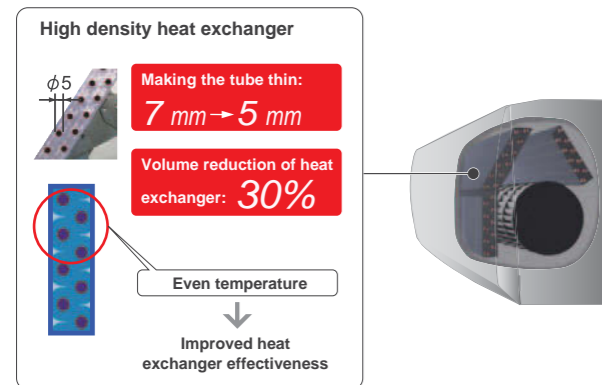

ON-OFF Programmable timer

You can set an integrated ON-OFF or OFF-ON timer suitable for your life style.  
 (Setting time: 0.5, 1, 1.5, 2, 2.5, -----9.5, 10, 11, 12 hours)

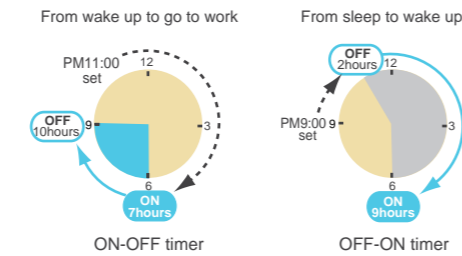

Super Quiet Operation

Top class low noise operation by new airflow construction. Our quiet operation makes the more comfortable environment in a bed room and a study room, etc.



Powerful operation

20 minutes continuous operation by maximum airflow and maximum compressor speed is possible. Rapid cooling and heating makes the room comfortable quickly.

Economy operation

Setting temp. is shifted by 1°C automatically.

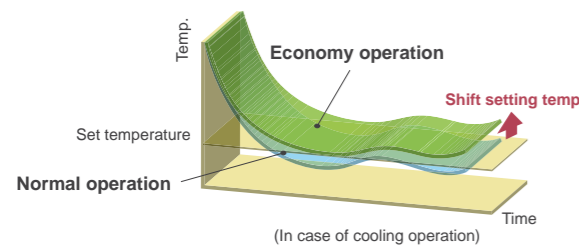

Low ambient operation

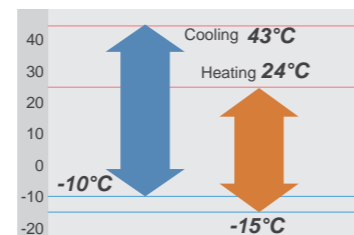

Optional parts

Remote Controller Holder: UTZ-RXLA

Specifications

Model No.	Indoor unit		ASYG07LLCC	ASYG09LLCC	ASYG12LLCC
	Outdoor unit		AOYG07LLCC	AOYG09LLCC	AOYG12LLCC
Power Source		V/∅/Hz	230/1/50	230/1/50	230/1/50
Capacity	Cooling	kW	2.0 (0.9-2.8)	2.5 (0.9-3.0)	3.4 (0.9-3.8)
	Heating		2.7 (0.9-3.6)	3.0 (0.9-3.8)	4.0 (0.9-5.0)
Input Power	Cooling/Heating	kW	0.470/0.620	0.730/0.740	1.080/1.130
EER	Cooling		4.26	3.42	3.15
COP	Heating	W/W	4.35	4.05	3.54
Pdesign	Cooling/Heating (@-10°C)	kW	2.0/2.2	2.5/2.3	3.4/3.2
SEER	Cooling		6.70	6.90	6.60
SCOP	Heating (Average)	W/W	4.00	4.00	3.80
Energy Efficiency Class	Cooling		A++	A++	A++
	Heating (Average)		A+	A+	A
Running Current	Cooling/Heating	A	2.6/3.0	3.5/3.5	5.2/5.4
Annual Energy Consumption	Cooling	kWh/a	104	127	180
	Heating		770	805	1,179
Moisture Removal		l/h	1.0	1.3	1.8
Sound Pressure (Cooling)	Indoor	H/M/L/Q	43/38/33/22	43/38/33/22	43/38/33/22
	Outdoor	High	47	47	50
Sound Power (Cooling)	Indoor	High	59	59	59
	Outdoor	High	61	61	65
Airflow Rate (High)	Indoor / Outdoor	m³/h	720/1,670	720/1,670	720/1,830
		mm	262x820x206	262x820x206	262x820x206
Net Dimension H x W x D	Indoor	kg(lbs)	7.0 (15)	7.0 (15)	7.0 (15)
	Outdoor	mm	535x663x293	535x663x293	535x663x293
		kg(lbs)	24 (53)	24 (53)	26 (57)
Piping Connections (Small / Large)		mm	6.35/9.52	6.35/9.52	6.35/9.52
Drain Hose Diameter (I.D./O.D.)			13.8/15.8 to 16.7	13.8/15.8 to 16.7	13.8/15.8 to 16.7
Max Pipe Length (Pre-Charge)		m	20 (15)	20 (15)	20 (15)
Max Height Difference			15	15	15
Operation Range	Cooling	°CDB	-10 to 43	-10 to 43	-10 to 43
	Heating		-15 to 24	-15 to 24	-15 to 24
Refrigerant (Global Warming Potential)			R410A (1,975)	R410A (1,975)	R410A (1,975)

Dimensions Models : ASYG07LLCC / ASYG09LLCC / ASYG12LLCC

(Unit : mm)

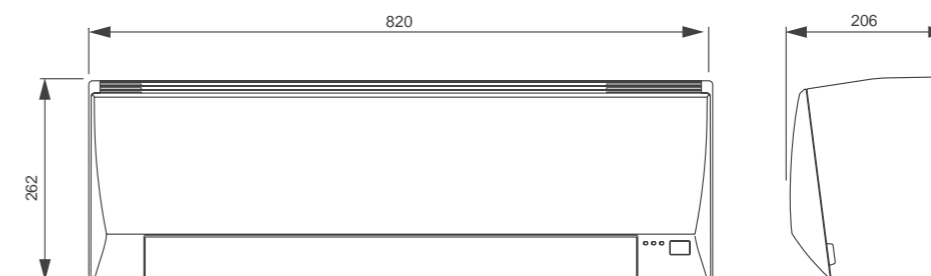



Standard : ASYG18LFCA / ASYG24LFCC / ASYG30LFCA



Wireless R.C.



For ASYG18LFCA  
ASYG24LFCC



For ASYG30LFCA



Features

“Vertical airflow” provides powerful floor level heating

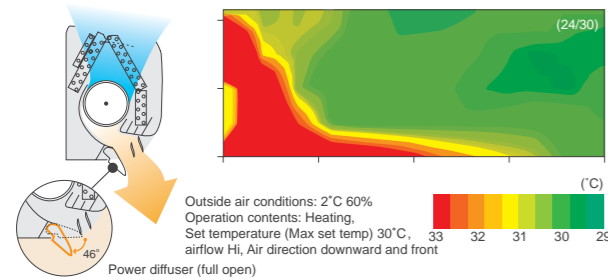

“Horizontal airflow” does not blow cool air directly at the occupants in the room

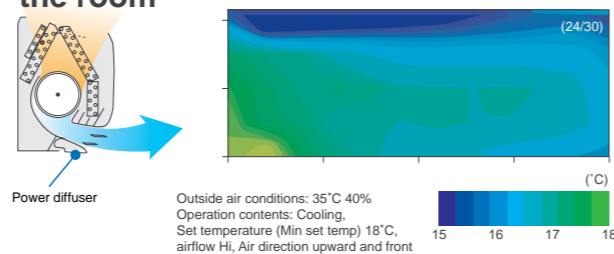

Air conditioner filter features

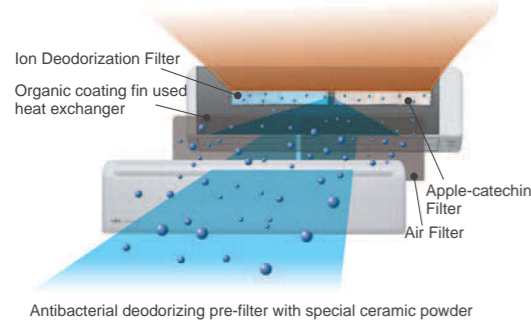

Ion Deodorization Filter

The filter deodorizes by powerfully decomposing absorbed odors using the oxidizing and reducing effects of ions generated by the ultra-fine-particle ceramic.

Using different filters at both sides

Apple-catechin Filter

The Apple-catechin filter uses static electricity to clean fine particles and dust in the air.

Flexible Installation

	18 type	24 type	30 type
Max. Piping Length	25 m	30 m	50 m
Max. Height	20 m	20 m	30 m

Easy maintenance

Simplification of drain pan cleaning improves maintenance-ability.

Low ambient operation

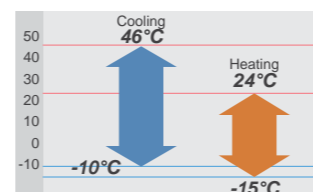

Optional parts

Wired Remote Controller: UTY-RNNYM, UTY-RVNYM  
Simple Remote Controller: UTY-RSNYM

Specifications

Model No.	Indoor unit		ASYG18LFCA	ASYG24LFCC	ASYG30LFCA
	Outdoor unit		AOYG18LFC	AOYG24LFCC	AOYG30LFT
Power Source	V/∅/Hz		230/1/50	230/1/50	230/1/50
Capacity	Cooling	kW	5.2 (0.9-6.0)	7.1 (0.9-8.0)	8.0 (2.9-9.0)
	Heating	kW	6.3 (0.9-9.1)	8.0 (0.9-10.6)	8.8 (2.2-11.0)
Input Power	Cooling/Heating	kW	1.52/1.71	2.20/2.21	2.49/2.44
	Cooling	W/W	3.42	3.23	3.21
EER	Heating	W/W	3.68	3.61	3.61
	Cooling/Heating (@-10°C)	kW	5.2/5.9	7.1/7.1	8.0/8.0
SEER	Cooling	W/W	6.94	6.11	5.69
	Heating (Average)	W/W	3.87	3.80	3.80
SCOP	Cooling		A++	A++	A+
	Heating (Average)		A	A	A
Running Current	Cooling/Heating	A	6.8/7.6	9.7/9.7	10.9/10.7
Annual Energy Consumption	Cooling	kWh/a	262	406	492
	Heating	kWh/a	2130	2610	2941
Moisture Removal		l/h	2.6	2.7	3.2
Sound Pressure (Cooling)	Indoor	H/M/L/Q	43/37/33/26	49/42/37/32	48/42/37/33
	Outdoor	High	50	55	53
Sound Power (Cooling)	Indoor	High	58	64	64
	Outdoor	High	65	68	68
Airflow Rate (High)	Indoor / Outdoor	m³/h	900/2150	1120/2460	1100/3600
		mm	320X998X238	320X998X238	320X998X238
Net Dimension H x W x D	Indoor	kg(lbs)	14 (31)	14 (31)	14 (31)
	Outdoor	kg(lbs)	620X790X298	620X790X298	830X900X330
Piping Connections (Small / Large)		mm	41 (90)	41 (90)	61 (135)
		mm	6.35/12.8	6.35/15.88	9.52/15.88
Drain Hose Diameter (I.D./O.D.)		mm	12/16	12/16	12/16
Max Pipe Length (Pre-Charge)		m	25 (15)	30 (15)	50 (20)
Max Height Difference			20	20	30
Operation Range	Cooling	°CDB	-10 to 46	-10 to 46	-10 to 46
	Heating	°CDB	-15 to 24	-15 to 24	-15 to 24
Refrigerant (Global Warming Potential)			R410A (1,975)	R410A (1,975)	R410A (1,975)

Dimensions Models : ASYG18LFCA / ASYG24LFCC / ASYG30LFCA

(Unit : mm)

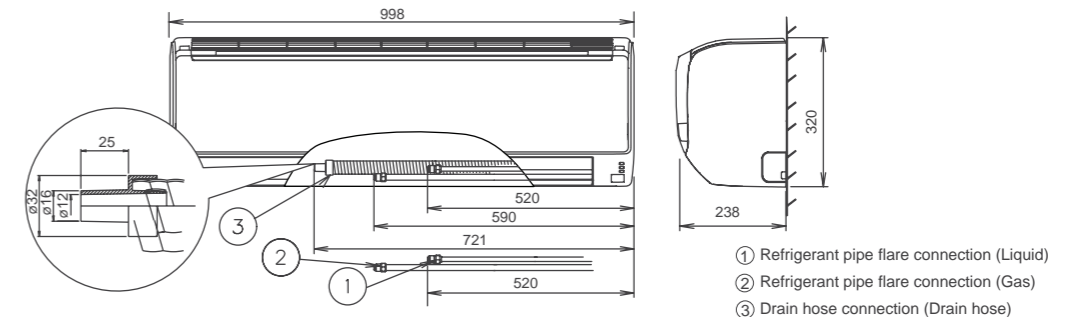

Model : AGYG09LVCA / AGYG12LVCA / AGYG14LVCA



Wireless R.C.



For AGYG09/12LVCA



For AGYG14LVCA



Features

Flexible & easy installation

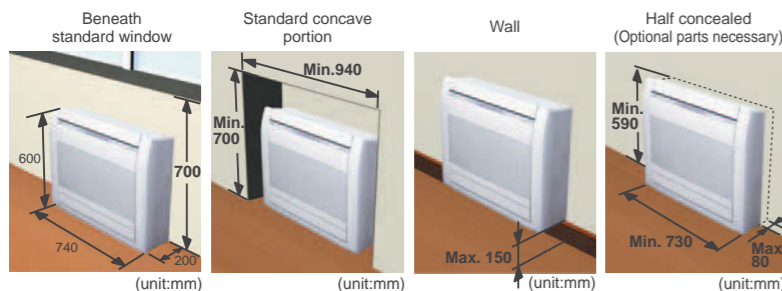

2-Fan & Wide airflow

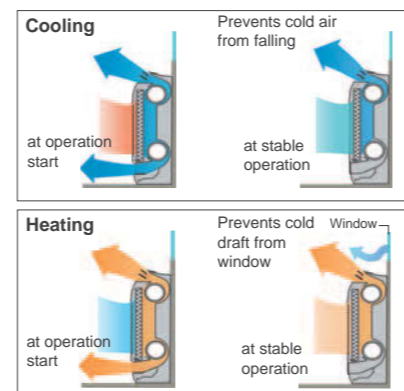

Filter features

**Ion Deodorization Filter**  
The filter deodorizes by powerfully decomposing absorbed odors using the oxidizing and reducing effects of ions generated by the ultra-fine-particle ceramic.

**Apple-catechin Filter**

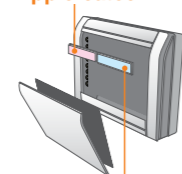

**Ion Deodorization Filter**

Using different filters at both sides

**Apple-catechin Filter**  
The Apple-catechin filter uses static electricity to clean fine particles and dust in the air.

Flexible piping connection 6 direction of drain & piping

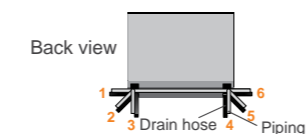

Low ambient operation

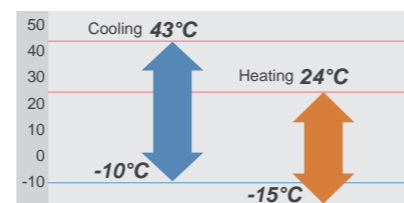

Optional parts

- Wired Remote Controller: UTY-RNNYM, UTY-RVNYM
- Simple Remote Controller: UTY-RSNYM
- Half Concealed Kit: UTR-STA

Specifications

Model No.	Indoor unit		AGYG09LVCA	AGYG12LVCA	AGYG14LVCA
	Outdoor unit		AOYG09LVCA	AOYG12LVCA	AOYG14LVCA
Power Source	V/∅/Hz		230/1/50	230/1/50	230/1/50
Capacity	Cooling	kW	2.6 (0.-3.5)	3.5 (0.9-4.0)	4.2 (0.9-5.0)
	Heating	kW	3.5 (0.9-5.5)	4.5 (0.9-6.6)	5.2 (0.9-8.0)
Input Power	Cooling/Heating	kW	0.53/0.79	0.94/1.19	1.14/1.44
	Cooling	W/W	4.91	3.72	3.68
EER	Heating	W/W	4.43	3.78	3.61
	Cooling/Heating (@-10°C)	kW	2.6/2.9	3.5/3.8	4.2/4.7
SEER	Cooling	W/W	7.00	6.50	6.40
	Heating (Average)	W/W	4.20	4.00	4.00
SCOP	Cooling		A++	A++	A++
	Heating (Average)		A+	A+	A+
Running Current	Cooling/Heating	A	2.6/3.8	4.4/5.5	5.2/6.4
Annual Energy Consumption	Cooling	kWh/a	130	188	230
	Heating	kWh/a	967	1330	1645
Moisture Removal		l/h	1.3	1.8	2.1
Sound Pressure (Cooling)	Indoor	H/M/L/Q	40/35/29/22	40/35/29/22	44/38/31/22
	Outdoor	High	47	48	50
	Indoor	High	55	55	58
Sound Power (Cooling)	Indoor	High	64	64	65
	Outdoor	High	64	64	65
Airflow Rate (High)	Indoor / Outdoor	m³/h	570/1680	570/1680	650/1910
		mm	600x740x200	600x740x200	600x740x200
Net Dimension H x W x D	Indoor	kg(lbs)	14 (31)	14 (31)	14 (31)
	Outdoor	mm	540x790x290	540x790x290	578x790x300
		kg(lbs)	36 (79)	36 (79)	40 (88)
Piping Connections (Small / Large)		mm	6.35/9.52	6.35/9.52	6.35/12.7
Drain Hose Diameter (I.D./O.D.)			13.8/15.8 to 16.7	13.8/15.8 to 16.7	13.8/15.8 to 16.7
Max Pipe Length (Pre-Charge)		m	20 (15)	20 (15)	20 (15)
Max Height Difference			15	15	15
Operation Range	Cooling	°CDB	-10 to 43	-10 to 43	-10 to 43
	Heating	°CDB	-15 to 24	-15 to 24	-15 to 24
Refrigerant (Global Warming Potential)			R410A (1,975)	R410A (1,975)	R410A (1,975)

Dimensions Models : AGYG09LVCA / AGYG12LVCA / AGYG14LVCA

(Unit : mm)

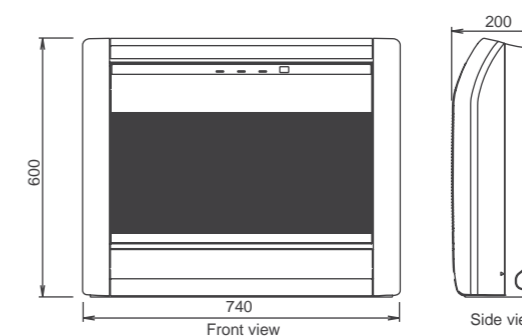

Model : AUYG12LVLB / AUYG14LVLB / AUYG18LVLB / AUYG24LVLA



Wireless R.C.



For AUYG12/14/18LVLB



For AUYG24LVLA



Features

2-stage turbo fan

High efficiency design by 2 stage structure

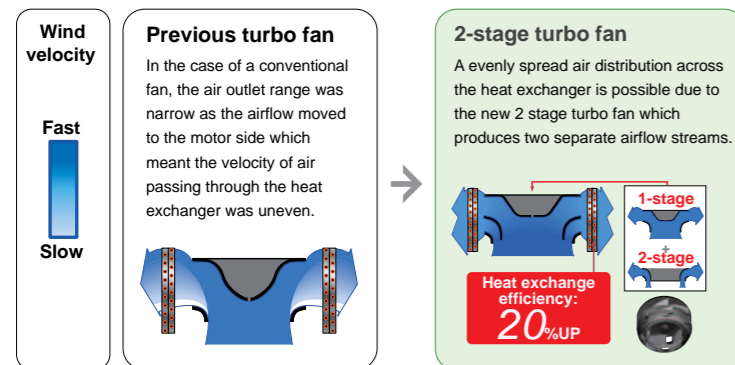

Quiet quality

Optimization of wing form (laminar wing type) and wing number (7 blades each)

Designed by CFD-analysis (fluid) simulations

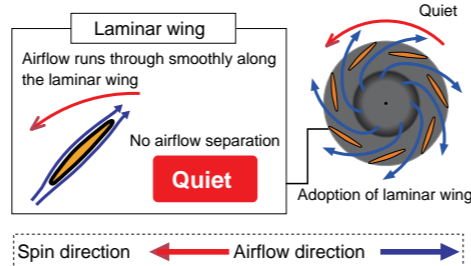

Low ambient operation

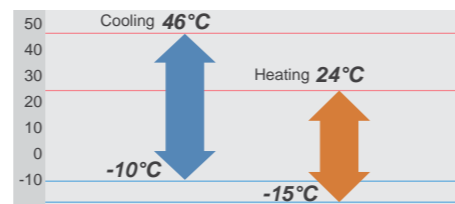

Easy maintenance

1 Maintenance of fan motor and fan

Maintenance of the fan motor and fan can be done easily after taking off the panel as the bell mouth of the fan can be removed easily.

A : Fan motor B : 2-stage turbo fan  
C : Bell-mouth D : Panel

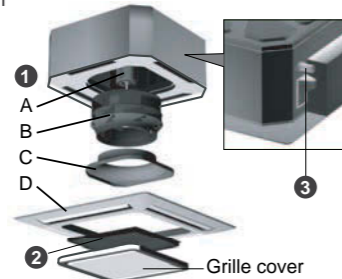

2 Air filter

Standard equipment

3 Adaptation of transparent drainage parts

During installation, maintenance and operation, the drain pump and kit can be checked easily.

High lift drain pump



Specifications

Model No.	Indoor unit		AUYG12LVLB	AUYG14LVLB	AUYG18LVLB	AUYG24LVLA
	Outdoor unit		AOYG12LALL	AOYG14LALL	AOYG18LALL	AOYG24LALA
Power Source	V/Ø/Hz		230/1/50	230/1/50	230/1/50	230/1/50
Capacity	Cooling	kW	3.5 (0.9-4.4)	4.3 (0.9-5.4)	5.2 (0.9-5.9)	6.8 (0.9-8.0)
	Heating	kW	4.1 (0.9-5.7)	5.0 (0.9-6.5)	6.0 (0.9-7.5)	8.0 (0.9-9.1)
Input Power	Cooling/Heating	kW	1.05/1.11	1.33/1.34	1.62/1.66	2.21/2.26
EER	Cooling	W/W	3.33	3.21	3.21	3.08
COP	Heating	W/W	3.69	3.71	3.61	3.54
Pdesign	Cooling/Heating (@-10°C)	kW	3.5/4.2	4.3/4.5	5.2/5.2	6.8/6.0
SEER	Cooling	W/W	6.20	6.40	6.20	5.60
SCOP	Heating (Average)	W/W	4.10	4.40	4.20	3.90
Energy Efficiency Class	Cooling		A++	A++	A++	A+
	Heating (Average)		A+	A+	A+	A
Running Current	Cooling/Heating	A	4.8/5.1	6.1/6.1	7.2/7.4	9.7/9.9
Annual Energy Consumption	Cooling	kWh/a	198	235	293	425
	Heating	kWh/a	1431	1432	1731	2151
Moisture Removal		l/h	1.2	1.5	2.2	2.7
Sound Pressure (Cooling)	Indoor	H/M/L/Q	37/34/30/27	38/34/30/27	38/34/30/26	49/44/36/30
	Outdoor	High	47	49	50	52
Sound Power (Cooling)	Indoor	High	49	50	50	59
	Outdoor	High	61	62	62	67
Airflow Rate (High)	Indoor / Outdoor	m³/h	600/1780	680/1910	680/2000	930/2470
Net Dimension H x W x D	Indoor	mm	245x570x570/49x700x700	245x570x570/49x700x700	245x570x570/49x700x700	245x570x570/49x700x700
		kg(lbs)	15 (33) / 2.6 (6)	15 (33) / 2.6 (6)	15 (33) / 2.6 (6)	16 (35) / 2.6 (6)
	Outdoor	mm	578x790x300	578x790x300	578x790x300	578x790x315
		kg(lbs)	40 (88)	40 (88)	40 (88)	44 (97)
Piping Connections (Small / Large)		mm	6.35/9.52	6.35/12.70	6.35/12.70	6.35/15.88
Drain Hose Diameter (I.D./O.D.)			25/32	25/32	25/32	25/32
Max Pipe Length (Pre-Charge)		m	25 (15)	25 (15)	25 (15)	30 (15)
Max Height Difference			15	15	15	20
Operation Range	Cooling	°CDB	-10 to 46	-10 to 46	-10 to 46	-10 to 46
	Heating	°CDB	-15 to 24	-15 to 24	-15 to 24	-15 to 24
Refrigerant (Global Warming Potential)			R410A (1,975)	R410A (1,975)	R410A (1,975)	R410A (1,975)
Cassette Grille			UTG-UFYD-W	UTG-UFYD-W	UTG-UFYD-W	UTG-UFYD-W

Dimensions Models : AUYG12LVLB / AUYG14LVLB / AUYG18LVLB / AUYG24LVLA

(Unit : mm)

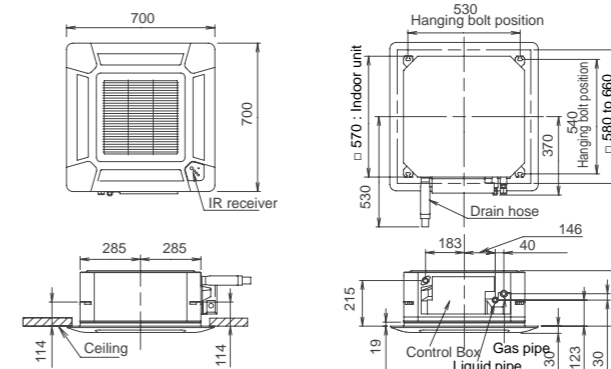

Model : AUYG30LRLE / AUYG36LRLE / AUYG45LRLE / AUYG54LRLE / AUYG36LRLA [3phase] / AUYG45LRLA [3phase] / AUYG54LRLA [3phase]



Wired R.C.



For AUYG30/36LRLE



For AUYG36/45/54LRLA



Features

High efficiency turbo fan with 3-dimensional blade

Previous turbo fan: Air passing through the heat exchanger was uneven and the air would only flow close to the ceiling.

New turbo fan: High efficiency airflow distribution has been achieved by the introduction of a 3 dimensional blade which increases the air passing over the heat exchanger.

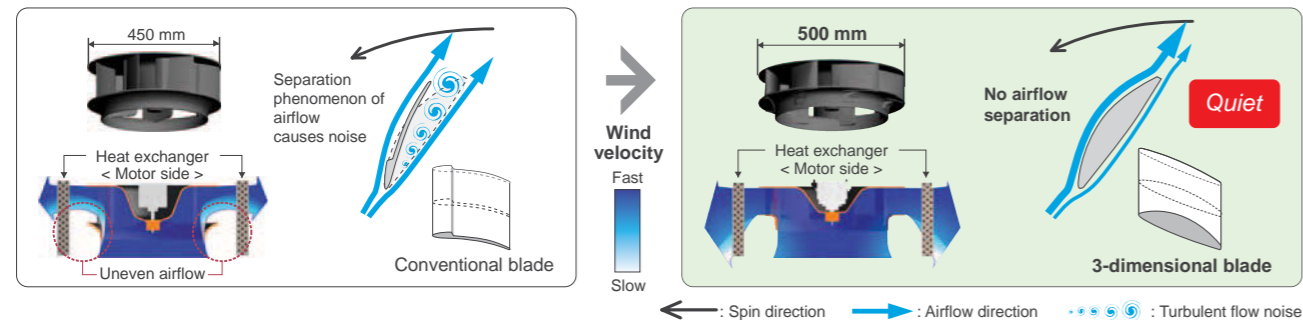

Improvement of the airflow distribution

New louvre: The louvre design distributes air leaving a space between the chassis and the ceiling allowing far and wide airflow distribution.

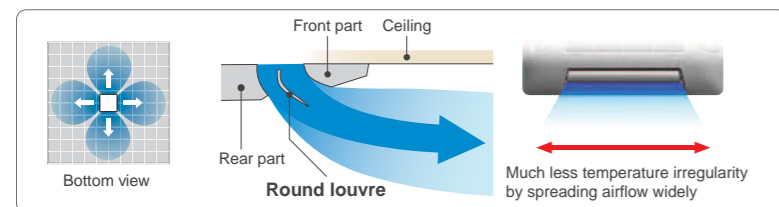

Low ambient operation

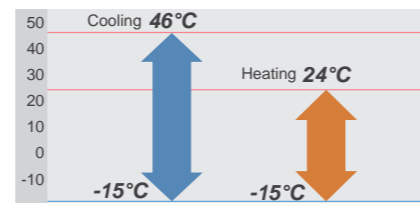

Adjustment of hanger position is possible after installation



High lift drain pump



Specifications

Model No.	Indoor unit		AUYG30LRLE	AUYG36LRLE	AUYG45LRLE	AUYG54LRLE	AUYG36LRLA	AUYG45LRLA	AUYG54LRLA
	Outdoor unit		AOYG30LETL	AOYG36LETL	AOYG45LETL	AOYG54LETL	AOYG36LATT	AOYG45LATT	AOYG54LATT
Power Source	V/Ø/Hz		230/1/50	230/1/50	230/1/50	230/1/50	400/3/50	400/3/50	400/3/50
Capacity	Cooling	kW	8.5 (2.8-10.0)	10.0 (2.8-11.2)	12.5 (4.0-14.0)	13.3 (4.5-14.5)	10.0 (4.7-11.4)	12.5 (5.0-14.0)	14.0 (5.4-16.0)
	Heating	kW	10.0 (2.7-11.2)	11.2 (2.7-12.7)	14.0 (4.2-16.2)	16.0 (4.7-16.5)	11.2 (5.0-14.0)	14.0 (5.4-16.2)	16.0 (5.8-18.0)
Input Power	Cooling/Heating	kW	2.65/2.77	3.12/3.02	3.88/3.77	4.42/4.69	2.44/2.56	3.54/3.58	4.36/4.43
EER	Cooling	W/W	3.21	3.21	3.22	3.01	4.10	3.53	3.21
COP	Heating	W/W	3.61	3.71	3.71	3.41	4.38	3.91	3.61
Pdesign	Cooling/Heating	kW	8.5/8.0	10.0/8.7	-	-	10.0/10.0	-	-
SEER	Cooling	W/W	6.50	6.30	-	-	6.50	-	-
SCOP	Heating	W/W	4.30	4.20	-	-	4.30	-	-
Energy Efficiency Class	Cooling		A++	A++	-	-	A++	-	-
	Heating		A+	A+	-	-	A+	-	-
Running Current	Cooling/Heating	A	11.6/12.2	13.7/13.3	17.0/16.5	19.3/20.5	3.7/3.9	5.3/5.3	6.5/6.6
Annual Energy Consumption	Cooling	kWh/a	458	555	-	-	573	-	-
	Heating	kWh/a	2604	2897	-	-	3253	-	-
Moisture Removal		l/h	2.5	3.5	4.5	5.0	3.0	4.5	5.0
Sound Pressure (Cooling)	Indoor	H/M/L/Q	40/38/36/32	43/38/36/32	46/42/40/36	47/43/41/37	44/39/36/33	46/42/40/36	47/43/41/37
	Outdoor	High	53	54	55	55	51	54	55
	Indoor	High	54	57	-	-	58	-	-
Sound Power (Cooling)	Indoor	High	61	69	-	-	67	-	-
	Outdoor	High	68	69	-	-	67	-	-
Airflow Rate (High)	Indoor / Outdoor	m³/h	1600/3600	1800/3800	1900/6750	2000/6750	1800/6200	1900/6900	2000/6900
		mm	288x840x840 50x950x950	288x840x840 50x950x950	288x840x840 50x950x950	288x840x840 50x950x950	288x840x840 50x950x950	288x840x840 50x950x950	288x840x840 50x950x950
Net Dimension H x W x D	Indoor	kg(lbs)	26 (57) / 5.5 (12)	26 (57) / 5.5 (12)	26 (57) / 5.5 (12)	26 (57) / 5.5 (12)	26 (57) / 5.5 (12)	26 (57) / 5.5 (12)	26 (57) / 5.5 (12)
	Outdoor	kg(lbs)	61 (135)	61 (135)	86 (190)	86 (190)	104 (229)	104 (229)	104 (229)
Piping Connections (Small / Large)		mm	9.52/15.88	9.52/15.88	9.52/15.88	9.52/15.88	9.52/15.88	9.52/15.88	9.52/15.88
Drain Hose Diameter (I.D./O.D.)		mm	25.0/32.0	25.0/32.0	25.0/32.0	25.0/32.0	25.0/32.0	25.0/32.0	25.0/32.0
Max Pipe Length (Pre-Charge)		m	50 (20)	50 (20)	50 (20)	50 (20)	75 (30)	75 (30)	75 (30)
Max Height Difference		m	30	30	30	30	30	30	30
Operation Range	Cooling	°CDB	-15 to 46	-15 to 46	-15 to 46	-15 to 46	-15 to 46	-15 to 46	-15 to 46
	Heating	°CDB	-15 to 24	-15 to 24	-15 to 24	-15 to 24	-15 to 24	-15 to 24	-15 to 24
Refrigerant (Global Warming Potential)			R410A (1,975)	R410A (1,975)	R410A (1,975)	R410A (1,975)	R410A (1,975)	R410A (1,975)	R410A (1,975)
Cassette Grille			UTG-UGYA-W	UTG-UGYA-W	UTG-UGYA-W	UTG-UGYA-W	UTG-UGYA-W	UTG-UGYA-W	UTG-UGYA-W

Dimensions Models : AUYG30LRLE / AUYG36LRLE / AUYG36LRLA / AUYG45LRLE / AUYG54LRLE

(Unit : mm)

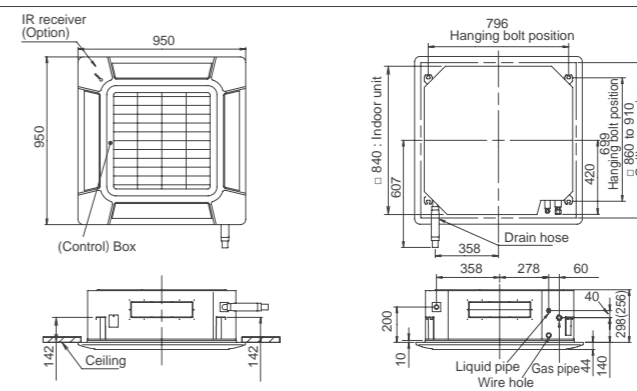

Model : ABYG18LVTB / ABYG24LVTA



Wireless R.C.



For ABYG18LVTB



For ABYG24LVTA



Features

Flexible installation

Example for floor installation

Floor console



Example for ceiling installation

Under ceiling



Double auto swing

A combination of right/left and up/down directional swing allows 3-dimensional air direction control

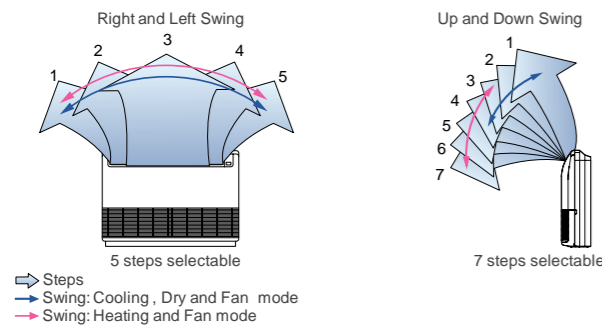

Low ambient operation

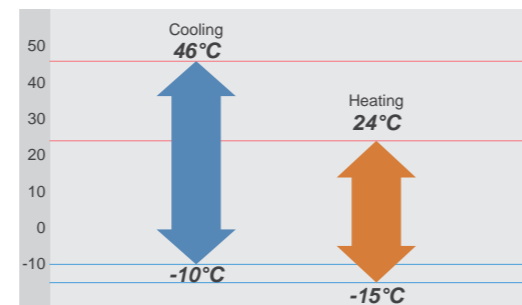

Specifications

Model No.	Indoor unit		ABYG18LVTB		ABYG24LVTA	
	Outdoor unit		AOYG18LALL		AOYG24LALA	
Power Source	V/Ø/Hz		230/1/50		230/1/50	
Capacity	Cooling	kW	5.2 (0.9-5.9)		6.8 (0.9-8.0)	
	Heating	kW	6.0 (0.9-7.5)		8.0 (0.9-9.1)	
Input Power	Cooling/Heating	kW	1.62/1.66		2.21/2.26	
EER	Cooling	W/W	3.21		3.08	
COP	Heating	W/W	3.61		3.54	
Pdesign	Cooling/Heating	kW	5.2/5.2		6.8/6.0	
SEER	Cooling	W/W	6.10		5.60	
SCOP	Heating	W/W	4.00		3.90	
Energy Efficiency Class	Cooling		A++		A+	
	Heating		A+		A	
Running Current	Cooling/Heating	A	7.2/7.4		9.7/9.9	
Annual Energy Consumption	Cooling	kWh/a	298		425	
	Heating	kWh/a	1819		2150	
Moisture Removal		l/h	2.0		2.7	
Sound Pressure (Cooling)	Indoor	H/M/L/Q	43/40/34/31		48/44/40/35	
	Outdoor	High	50		52	
Sound Power (Cooling)	Indoor	High	57		61	
	Outdoor	High	62		67	
Airflow Rate (High)	Indoor / Outdoor	m³/h	780/2000		980/2470	
		mm	199x990x655		199x990x655	
Net Dimension H x W x D	Indoor	kg(lbs)	27 (59)		27 (59)	
	Outdoor	mm	578x790x300		578x790x315	
	kg(lbs)		40 (88)		44 (97)	
Piping Connections (Small / Large)		mm	6.35/12.70		6.35/15.88	
Drain Hose Diameter (I.D./O.D.)			25/32		25/32	
Max Pipe Length (Pre-Charge)		m	25 (15)		30 (15)	
Max Height Difference			15		20	
Operation Range	Cooling	°CDB	-10 to 46		-10 to 46	
	Heating	°CDB	-15 to 24		-15 to 24	
Refrigerant (Global Warming Potential)			R410A (1,975)		R410A (1,975)	

Dimensions Models : ABYG18LVTB / ABYG24LVTA

(Unit : mm)

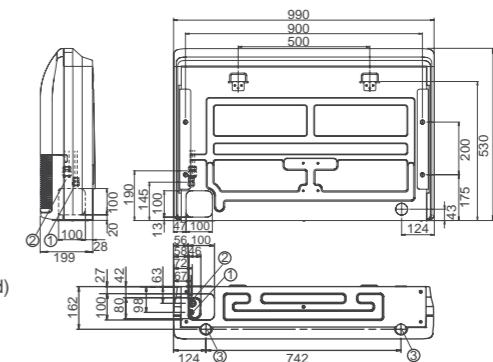

Easy installation

Main work settings can be done easily from the remote controller at installation

Main work settings

- High ceiling setting
- Auto restart
- Temperature adjustment when cooling / heating

Optional parts

Wired Remote Controller: UTY-RNNYM, UTY-RVNYM  
Simple Remote Controller: UTY-RSNYM

Model : ABYG30LRTE / ABYG36LRTE / ABYG45LRTA /  
 ABYG36LRTA [3phase] / ABYG45LRTA [3phase] / ABYG54LRTA [3phase]



Wireless R.C. For ABYG30/36LRTE For ABYG36/45/54LRTA



Features

Installation

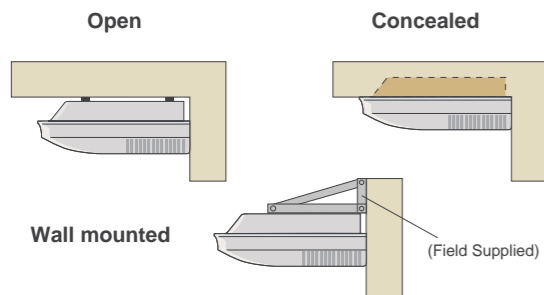

Multi auto swing

A combination of right/left and up/down directional swing allows 3-dimensional air direction control.

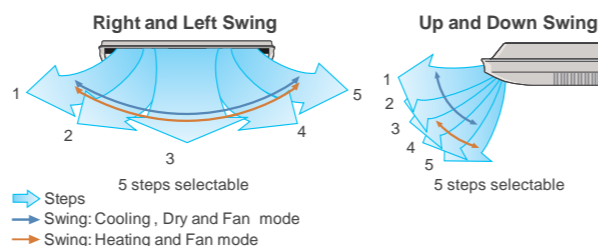

Condensate lift-up mechanism (Option)

Optional drain lift-up mechanism allows flexible installation.

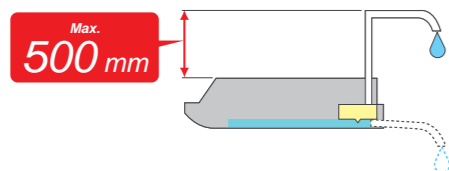

Low ambient operation

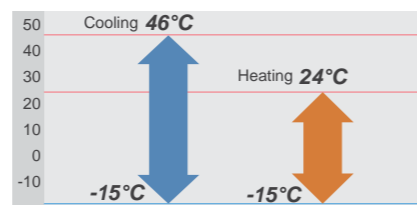

Easy installation

Main work settings can be done easily from the remote controller at installation

- Main work settings**
- High ceiling setting
  - Auto restart
  - Temperature adjustment when cooling / heating

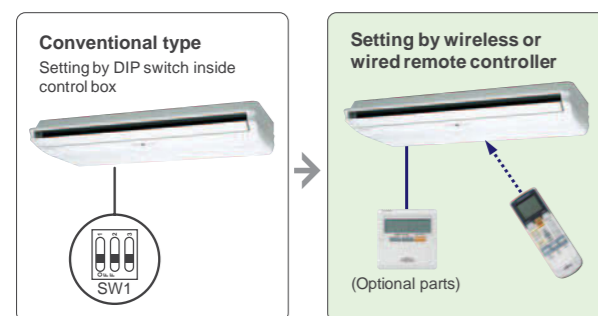

Fresh air intake

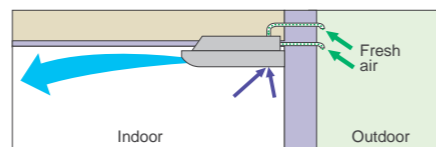

Optional parts

- Wired Remote Controller: UTY-RNNYM, UTY-RVNYM
- Simple Remote Controller: UTY-RSNYM
- Drain Pump Unit: UTR-DPB24T
- Flange: UTD-RF204

Specifications

Model No.	Indoor unit		ABYG30LRTE	ABYG36LRTE	ABYG45LRTA	ABYG36LRTA	ABYG45LRTA	ABYG54LRTA
	Outdoor unit		AOYG30LETL	AOYG36LETL	AOYG45LETL	AOYG36LATT	AOYG45LATT	AOYG54LATT
Power Source	V/Ø/Hz		230/1/50	230/1/50	230/1/50	400/3/50	400/3/50	400/3/50
Capacity	Cooling	kW	8.5 (2.8-10.0)	9.4 (2.8-11.2)	12.1 (4.0-13.3)	10.0 (4.7-11.4)	12.5 (5.0-14.0)	14.0 (5.4-16.0)
	Heating	kW	10.0 (2.7-11.2)	11.2 (2.7-12.7)	13.3 (4.2-15.5)	11.2 (5.0-14.0)	14.0 (5.4-16.2)	16.0 (5.8-18.0)
Input Power	Cooling/Heating	kW	2.65/2.77	2.93/3.02	3.77/3.68	2.84/2.87	3.89/3.88	4.65/4.67
	Cooling	W/W	3.21	3.21	3.21	3.52	3.21	3.01
EER	Cooling	W/W	3.61	3.71	3.61	3.90	3.61	3.43
	Heating	W/W	3.61	3.71	3.61	3.90	3.61	3.43
Pdesign	Cooling/Heating	kW	8.5/8.0	9.4/8.7	-	10.0/10.0	-	-
	Cooling	W/W	6.10	6.00	-	6.10	-	-
SEER	Cooling	W/W	4.20	4.10	-	4.10	-	-
	Heating	W/W	4.20	4.10	-	4.10	-	-
SCOP	Cooling	W/W	A++	A+	-	A++	-	-
	Heating	W/W	A+	A+	-	A+	-	-
Running Current	Cooling/Heating	A	11.6/12.2	12.8/13.2	16.5/16.1	4.3/4.4	5.8/5.8	6.9/6.9
Annual Energy Consumption	Cooling	kWh/a	487	548	-	573	-	-
	Heating	kWh/a	2662	2965	-	3414	-	-
Moisture Removal		l/h	2.5	3.0	4.0	3.0	4.5	5.0
Sound Pressure (Cooling)	Indoor	H/M/L/Q	45/43/37/32	47/43/37/32	49/45/39/34	47/43/37/32	49/45/39/34	51/48/42/38
	Outdoor	High	53	54	55	51	54	55
	Outdoor	High	57	60	-	61	-	-
Sound Power (Cooling)	Indoor	High	68	69	-	67	-	-
	Outdoor	High	68	69	-	67	-	-
	Outdoor	High	68	69	-	67	-	-
Airflow Rate (High)	Indoor / Outdoor	m³/h	1660/3600	1900/3800	2100/6200	1900/6200	2100/6900	2300/6900
	Indoor	mm	240x1660x700	240x1660x700	240x1660x700	240x1660x700	240x1660x700	240x1660x700
Net Dimension H x W x D	Indoor	kg(lbs)	46 (101)	46 (101)	46 (101)	46 (101)	46 (101)	48 (106)
	Outdoor	mm	830x900x330	830x900x330	1290x900x330	1290x900x330	1290x900x330	1290x900x330
		kg(lbs)	61 (134)	61 (134)	86 (189)	104 (229)	104 (229)	104 (229)
Piping Connections (Small / Large)		mm	9.52/15.88	9.52/15.88	9.52/15.88	9.52/15.88	9.52/15.88	9.52/15.88
Drain Hose Diameter (I.D./O.D.)		mm	21.5/26.0	21.5/26.0	21.5/26.0	21.5/26.0	21.5/26.0	21.5/26.0
Max Pipe Length (Pre-Charge)		m	50 (20)	50 (20)	50 (20)	75 (30)	75 (30)	75 (30)
Max Height Difference		m	30	30	30	30	30	30
Operation Range	Cooling	°CDB	-15 to 46	-15 to 46	-15 to 46	-15 to 46	-15 to 46	-15 to 46
	Heating	°CDB	-15 to 24	-15 to 24	-15 to 24	-15 to 24	-15 to 24	-15 to 24
Refrigerant (Global Warming Potential)			R410A (1,975)	R410A (1,975)	R410A (1,975)	R410A (1,975)	R410A (1,975)	R410A (1,975)

Dimensions Models : ABYG30LRTE / ABYG36LRTE / ABYG36LRTA / ABYG45LRTA / ABYG54LRTA

(Unit : mm)

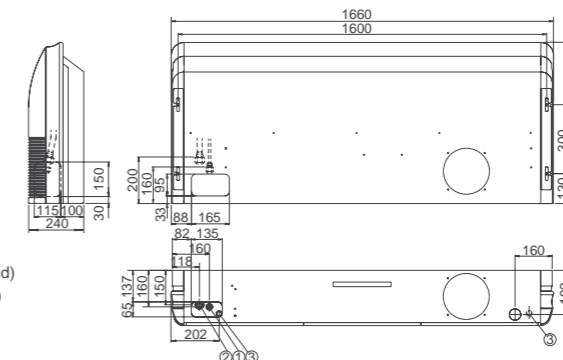

- ① Refrigerant piping flare connection (Liquid)
- ② Refrigerant piping flare connection (Gas)
- ③ Drain piping connection

Model : ARYG12LLTB / ARYG14LLTB / ARYG18LLTB



Features

Slim design

The slim design allows installations where ceilings are narrow.

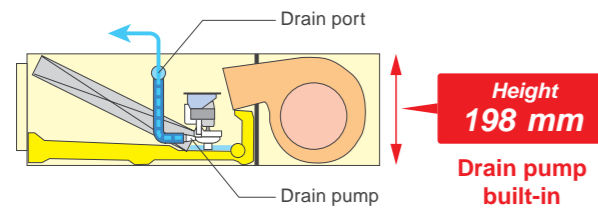

Drain hose as standard accessory

For flexible installation.

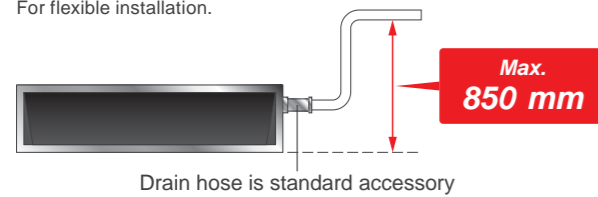

Selectable with a wide range of static pressure

By using the DC fan motor, it is possible to change the static pressure range from 0 to 90 Pa.

The change of static pressure range is possible by remote controller.



Flexible installation

Ceiling concealed Floor concealed



Auto Louver Grille Kit (Option)

Simple flat Auto Louver will provide comfort airflow and harmonize with luxury interior.

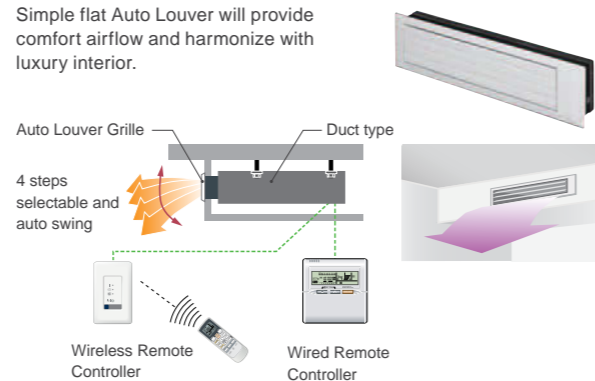

Optional parts

- Wired Remote Controller: UTY-RNNYM, UTY-RVNYM
- Simple Remote Controller: UTY-RSNYM
- IR Receiver Kit: UTY-LRHYM
- Remote Sensor Unit: UTY-XSZX
- Auto Louver Grille Kit: UTD-GXSA-W (For ARYG12 / 14LLTB), UTD-GXSB-W (For ARYG18LLTB)

Air-intake

Air intake direction can be selected to match the installation site.

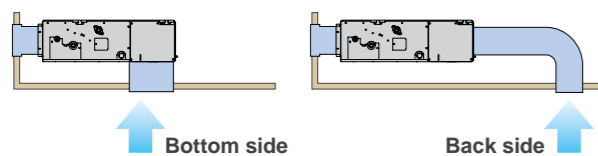

Specifications

Model No.	Indoor unit		ARYG12LLTB	ARYG14LLTB	ARYG18LLTB
	Outdoor unit		AOYG12LALL	AOYG14LALL	AOYG18LALL
Power Source	V/∅/Hz		230/1/50	230/1/50	230/1/50
Capacity	Cooling	kW	3.5 (0.9-4.4)	4.3 (0.9-5.4)	5.2 (0.9-5.9)
	Heating	kW	4.1 (0.9-5.7)	5.0 (0.9-6.5)	6.0 (0.9-7.5)
Input Power	Cooling/Heating	kW	1.05/1.11	1.33/1.34	1.62/1.66
EER	Cooling	W/W	3.33	3.21	3.21
COP	Heating	W/W	3.69	3.71	3.61
Pdesign	Cooling/Heating	kW	3.5/4.2	4.3/4.5	5.2/5.2
SEER	Cooling	W/W	5.90	5.80	6.20
SCOP	Heating	W/W	4.00	3.90	4.10
Energy Efficiency Class	Cooling		A+	A+	A++
	Heating		A+	A	A+
Running Current	Cooling/Heating	A	4.8/5.1	6.1/6.1	7.2/7.4
Annual Energy Consumption	Cooling	kWh/a	207	259	293
	Heating	kWh/a	1467	1614	1774
Moisture Removal		l/h	1.3	1.5	2.0
Sound Pressure (Cooling)	Indoor	H/M/L/Q	29/28/26/25	32/30/28/26	32/30/29/27
	Outdoor	High	47	49	50
Sound Power (Cooling)	Indoor	High	58	60	58
	Outdoor	High	61	62	62
Airflow Rate (High)	Indoor / Outdoor	m³/h	650/1780	800/1910	940/2000
Static pressure range (Standard)		Pa	0 to 90 (25)	0 to 90 (25)	0 to 90 (25)
Net Dimension H x W x D	Indoor	mm	198x700x620	198x700x620	198x900x620
	Outdoor	kg(lbs)	19 (42)	19 (42)	23 (51)
Piping Connections (Small / Large)		mm	6.35/9.52	6.35/12.70	6.35/12.70
	Drain Hose Diameter (I.D./O.D.)	mm	25/32	25/32	25/32
Max Pipe Length (Pre-Charge)		m	25 (15)	25 (15)	25 (15)
Max Height Difference		m	15	15	15
Operation Range	Cooling	°CDB	-10 to 46	-10 to 46	-10 to 46
	Heating	°CDB	-15 to 24	-15 to 24	-15 to 24
Refrigerant (Global Warming Potential)			R410A (1,975)	R410A (1,975)	R410A (1,975)

Dimensions Models : ARYG12LLTB / ARYG14LLTB / ARYG18LLTB

(Unit : mm)

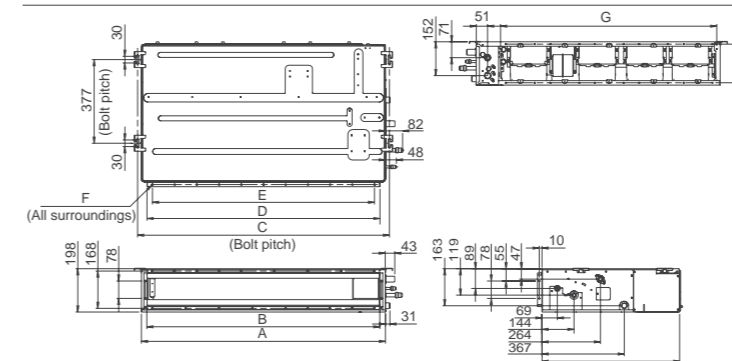

	ARYG12 / 14LLTB	ARYG18LLTB
A	700	900
B	650	850
C	734	934
D	650	850
E	P100x6=600	P100x8=800
F	18x∅5	22x∅5
G	574	774

Model : ARYG24LMLA / ARYG30LMLE / ARYG36LMLE / ARYG45LMLA / ARYG36LMLA [3phase] / ARYG45LMLA [3phase]



Features

Slim & Compact design

In the case of bottom return air connection, not only does the indoor unit design allow for installation in a narrow ceiling space of up to 270 mm, Further space savings have been achieved by mounting the control box internally inside the chassis.

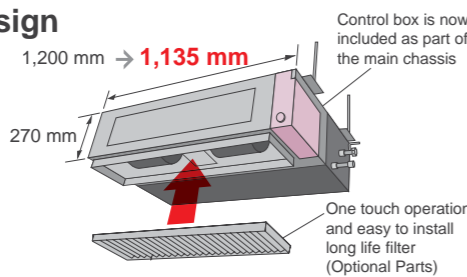

Two-direction drain piping

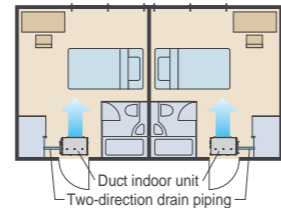

Easy maintenance

Structural improvement is attained by making the bottom panel two pieces, front and rear. The maintenance of the motor and fan can be easily carried out by removing the rear panel and the lower part of the casing while leaving the main chassis installed.

See below for the case of rear suction type

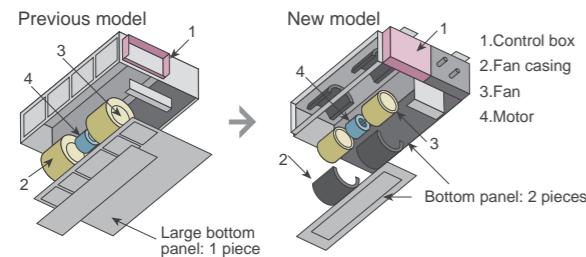

Low ambient operation

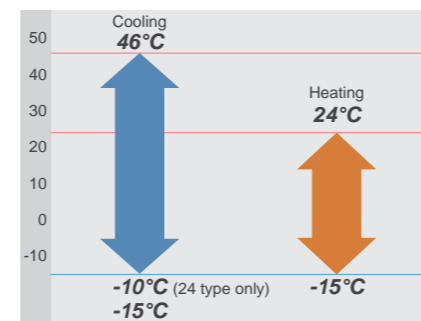

Easy installation

Main work settings can be done easily from the remote controller at installation

- Main work settings**
- High ceiling setting
  - Auto restart
  - Temperature adjustment when cooling / heating

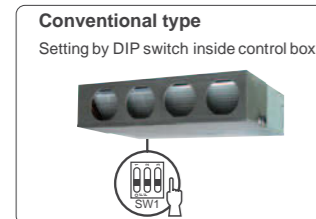

Optional parts

- Wired Remote Controller: UTY-RNNYM, UTY-RVNYM
- Simple Remote Controller: UTY-RSNYM
- Flange (Round): UTD-RF204
- Flange (Square): UTD-SF045T
- Long Life Filter: UTD-LF25NA
- Remote Sensor Unit: UTY-XSZX
- Drain Pump Unit: UTZ-PX1NBA
- IR Receiver Kit: UTY-LRHYM

Specifications

Model No.	Indoor unit		ARYG24LMLA	ARYG30LMLE	ARYG36LMLE	ARYG45LMLA	ARYG36LMLA	ARYG45LMLA
	Outdoor unit		AOYG24LALA	AOYG30LETL	AOYG36LETL	AOYG45LETL	AOYG36LATT	AOYG45LATT
Power Source	V/Ø/Hz		230/1/50	230/1/50	230/1/50	230/1/50	400/3/50	400/3/50
Capacity	Cooling	kW	6.8 (0.9-8.0)	8.5 (2.8-10.0)	9.4 (2.8-11.2)	12.1 (4.0-13.3)	10.0 (4.7-11.4)	12.5 (5.0-14.0)
	Heating	kW	8.0 (0.9-9.1)	10.0 (2.7-11.2)	11.2 (2.7-12.7)	13.3 (4.2-15.5)	11.2 (5.0-14.0)	14.0 (5.4-16.2)
Input Power	Cooling/Heating	kW	2.21/2.26	2.65/2.68	2.96/3.10	3.77/3.68	2.84/2.87	3.89/3.88
EER	Cooling	W/W	3.08	3.21	3.18	3.21	3.52	3.21
COP	Heating	W/W	3.54	3.73	3.61	3.61	3.90	3.61
Pdesign	Cooling/Heating	kW	6.8/6.0	8.5/8.0	9.4/8.7	-	10.0/10.0	-
SEER	Cooling	W/W	6.20	5.90	5.70	-	5.80	-
SCOP	Heating	W/W	4.00	3.90	3.80	-	4.00	-
Energy Efficiency Class	Cooling		A++	A+	A+	-	A+	-
	Heating		A+	A	A	-	A+	-
Running Current	Cooling/Heating	A	9.7/9.9	11.6/11.7	13.0/13.6	16.5/16.1	4.3/4.4	5.8/5.8
Annual Energy Consumption	Cooling	kWh/a	384	504	576	-	603	-
	Heating	kWh/a	2098	2868	3202	-	3497	-
Moisture Removal		l/h	2.5	2.5	3.0	4.0	3.0	4.5
Sound Pressure (Cooling)	Indoor	H/M/L/Q	31/29/27/25	39/35/30/26	39/35/30/26	42/38/32/28	38/36/31/26	42/38/32/28
	Outdoor	High	52	53	54	55	51	54
	Outdoor	High	60	65	65	-	65	-
Sound Power (Cooling)	Indoor		67	68	69	-	67	-
	Outdoor		67	68	69	-	67	-
Airflow Rate (High)	Indoor / Outdoor	m³/h	1100/2470	1900/3600	1900/3800	2100/6200	1800/6200	2100/6750
Static pressure range (Standard)		Pa	30 to 150 (35)	30 to 150 (47)	30 to 150 (47)	30 to 150 (60)	30 to 150 (47)	30 to 150 (60)
Net Dimension H x W x D	Indoor	mm	270x1135x700	270x1135x700	270x1135x700	270x1135x700	270x1135x700	270x1135x700
		kg(lbs)	38 (84)	40 (88)	40 (88)	40 (88)	40 (88)	40 (88)
	Outdoor	mm	578x790x315	830x900x330	830x900x330	1290x900x330	1290x900x330	1290x900x330
		kg(lbs)	44 (97)	61 (134)	61 (134)	86 (189)	104 (229)	104 (229)
Piping Connections (Small / Large)		mm	6.35/15.88	9.52/15.88	9.52/15.88	9.52/15.88	9.52/15.88	9.52/15.88
	Drain Hose Diameter (I.D./O.D.)	mm	35.7/38.1	35.7/38.1	35.7/38.1	35.7/38.1	35.7/38.1	35.7/38.1
Max Pipe Length (Pre-Charge)		m	30 (15)	50 (20)	50 (20)	50 (20)	75 (30)	75 (30)
Max Height Difference		m	20	30	30	30	30	30
Operation Range	Cooling	°CDB	-10 to 46	-15 to 46	-15 to 46	-15 to 46	-15 to 46	-15 to 46
	Heating	°CDB	-15 to 24	-15 to 24	-15 to 24	-15 to 24	-15 to 24	-15 to 24
Refrigerant (Global Warming Potential)			R410A (1,975)	R410A (1,975)	R410A (1,975)	R410A (1,975)	R410A (1,975)	R410A (1,975)

Dimensions Models : ARYG24LMLA / ARYG30LMLE / ARYG36LMLE / ARYG36LMLA / ARYG45LMLA

(Unit : mm)

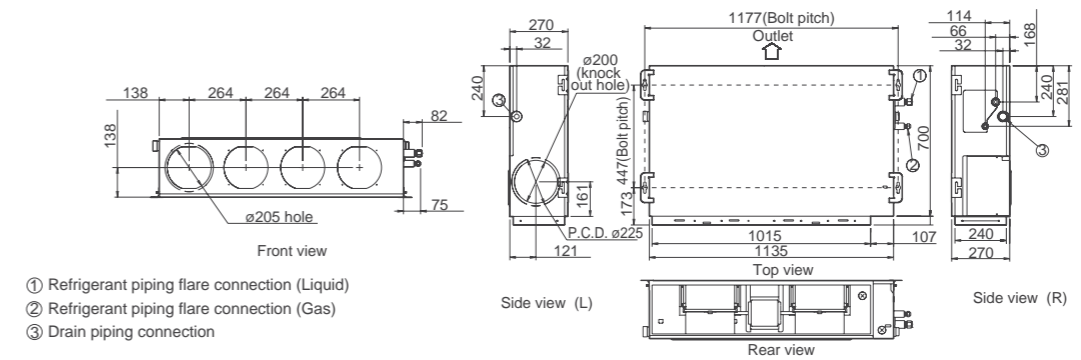



Model : ARYG45LHTA / ARYG54LHTA /  
ARYG45LHTA [3phase] / ARYG54LHTA [3phase] / ARYG60LHTA [3phase]

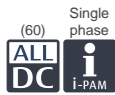

Features

High energy efficiency

Significantly greater efficiency is realized by using all DC inverter technology. (60 type)

Easy installation  
(Compact size & Lightweight)

A compact size and lightweight indoor unit has been developed by reducing the basic chassis and the overall material weight.

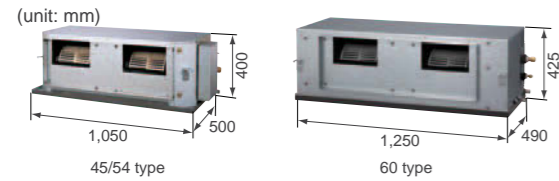

Design also corresponding to high static pressure

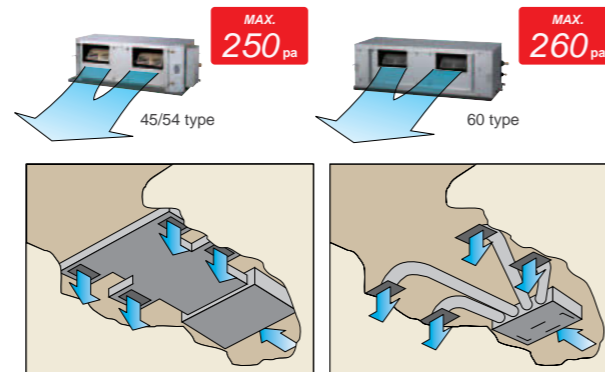

Low noise

Indoor unit

Cutting off the corners has enabled less turbulent airflow. Low noise is realized by adopting a plastic case and a plastic fan.

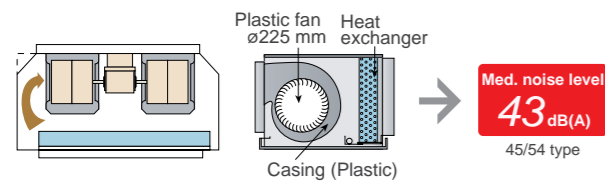

Outdoor unit

2 stage low noise mode can be selected. (Option)

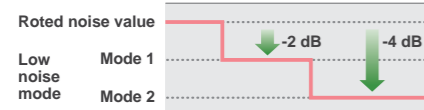

Low ambient operation

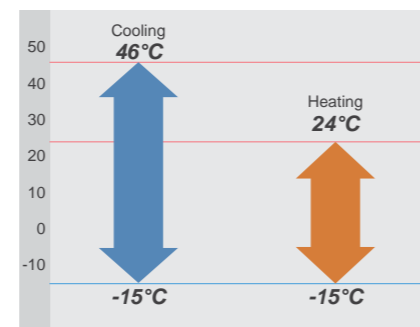

Optional parts

- Wired Remote Controller: UTY-RNNYM, UTY-RVNYM
- Simple Remote Controller: UTY-RSNYM
- Long-Life Filter: UTD-LF60KA (For ARYG45/54LHTA only)
- Remote Sensor Unit: UTY-XSZX
- IR Receiver Kit: UTY-LRHYM (For ARYG60LHTA only)

Specifications

Model No.	Indoor unit		ARYG45LHTA	ARYG54LHTA	ARYG45LHTA	ARYG54LHTA	ARYG60LHTA	
	Outdoor unit		AOYG45LETL	AOYG54LETL	AOYG45LATT	AOYG54LATT	AOYG60LATT	
Power Source	V/∅/Hz		230/1/50	230/1/50	400/3/50	400/3/50	400/3/50	
Capacity	Cooling	kW	12.5 (4.5-14.0)	13.4 (5.0-14.5)	12.5 (5.0-14.0)	14.0 (5.4-16.0)	15.0 (6.2-17.5)	
	Heating	kW	14.0 (5.0-16.2)	16.0 (5.5-18.0)	14.0 (5.4-16.2)	16.0 (5.8-18.0)	18.0 (6.2-20.0)	
Input Power	Cooling/Heating		kW	4.30/3.80	4.77/4.69	4.06/3.67	4.65/4.37	4.70/5.15
EER	Cooling		W/W	2.91	2.81	3.08	3.01	3.19
COP	Heating		W/W	3.68	3.41	3.81	3.66	3.50
Running Current	Cooling/Heating		A	18.9/16.7	20.9/20.5	6.1/5.5	6.9/6.5	6.9/7.6
Moisture Removal			l/h	1.5	2.0	1.5	2.5	2.0
Sound Pressure (Cooling)	Indoor	H/M/L	dB(A)	47/43/40	47/43/40	47/43/40	47/43/40	45/40/36
	Outdoor	High	dB(A)	55	55	54	55	56
Airflow Rate (High)	Indoor / Outdoor		m³/h	3350/6750	3350/6750	3350/6750	3350/6900	3550/6900
Static pressure range (Standard)			Pa	100 to 250 (100)	100 to 250 (100)	100 to 250 (100)	100 to 250 (100)	60 to 260 (60)
			mm	400x1050x500	400x1050x500	400x1050x500	400x1050x500	425x1250x490
Net Dimension H x W x D	Indoor		kg(lbs)	46 (101)	46 (101)	46 (101)	46 (101)	54 (119)
	Outdoor		kg(lbs)	1290x900x330	1290x900x330	1290x900x330	1290x900x330	1290x900x330
Piping Connections (Small / Large)			mm	9.52/15.88	9.52/15.88	9.52/15.88	9.52/15.88	9.52/15.88
			mm	23.4/25.4	23.4/25.4	23.4/25.4	23.4/25.4	23.4/25.4
Max Pipe Length (Pre-Charge)			m	50 (20)	50 (20)	75 (30)	75 (30)	75 (30)
Height Difference			m	30	30	30	30	30
Operation Range	Cooling	°CDB		-15 to 46	-15 to 46	-15 to 46	-15 to 46	-15 to 46
	Heating	°CDB		-15 to 24	-15 to 24	-15 to 24	-15 to 24	-15 to 24
Refrigerant				R410A	R410A	R410A	R410A	R410A

Dimensions Models : ARYG45LHTA / ARYG54LHTA / ARYG60LHTA

(Unit : mm)

Model: ARYG45LHTA / ARYG54LHTA

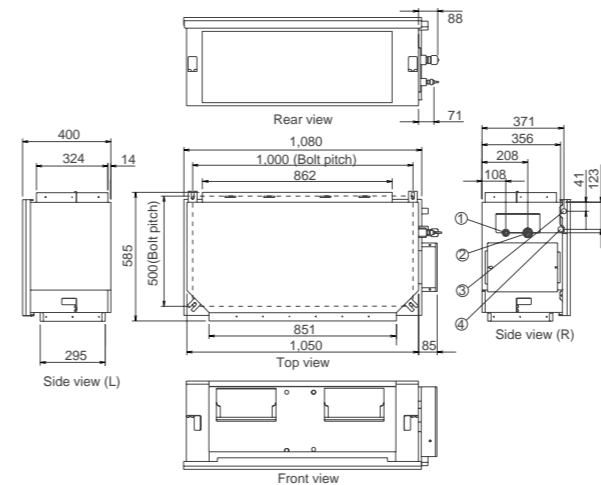

Model: ARYG60LHTA

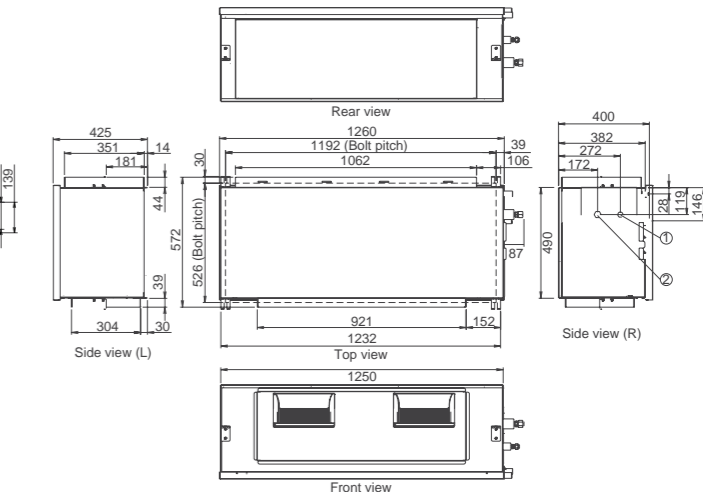

- ① Refrigerant piping flare connection (Liquid)
- ② Refrigerant piping flare connection (Gas)
- ③ Drain piping connection (Safety drain pan)
- ④ Drain piping connection (Main drain pan)

Model : ARYC72LHTA [3phase], ARYC90LHTA [3phase]



ARYC72LHTA



ARYC90LHTA



Wired R.C.



Features

High energy efficiency

Significantly greater efficiency is realized by using DC twin rotary compressor, all DC inverter technology, and large heat exchanger.

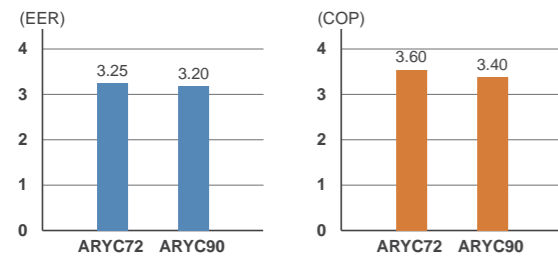

Outdoor unit quiet operation

A low outdoor noise operation mode allows the outdoor unit to have two quiet mode operation settings.

Peak cut operation

A peak power consumption mode controls a 4 step outdoor operation control to cut down energy usage at peak energy usage times.

Easy Service & Maintenance

- Split front panel allows for maintenance from top or bottom of the outdoor unit
- Fan motors of the indoor unit can be removed separately

5 Static Pressure selection

Improvement and design flexibility has allowed multiple fan speeds and static pressure modes. Low noise is realized by adopting plastic case, plastic fan.

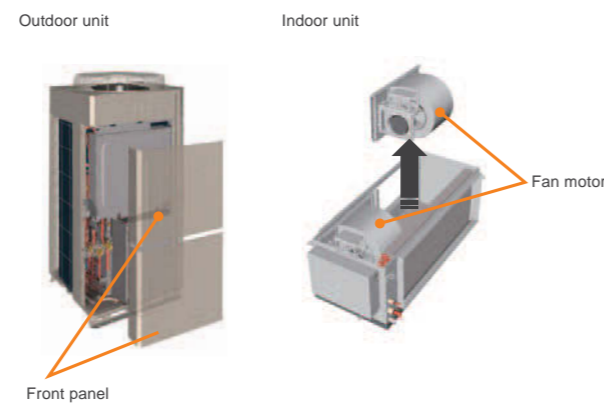
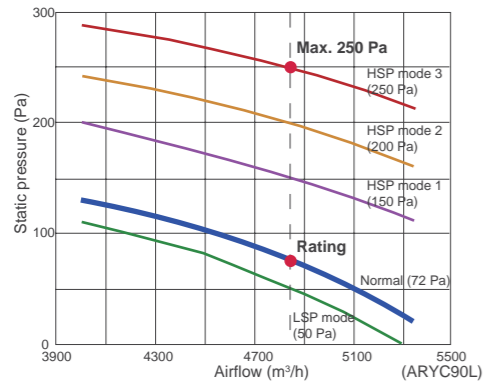

Pursuance of amenity performance

Various remote controllers and sensors can be selected.



Optional parts

- Wired Remote Controller: UTY-RNNYM, UTY-RVNYM
- Simple Remote Controller: UTY-RSNYM
- Remote Sensor Unit: UTY-XSZX

Specifications

Model No.	Indoor unit		ARYC72LHTA		ARYC90LHTA	
	Outdoor unit		AOYA72LALT		AOYA90LALT	
Power Source	V/∅/Hz		400/3/50		400/3/50	
Capacity	Cooling	kW	20.3 (10.8-23.5)		25.0 (11.2-28.0)	
	Heating	kW	22.6 (12.0-26.5)		28.0 (12.5-31.5)	
Input Power	Cooling/Heating		kW		7.82/8.24	
EER	Cooling		W/W		3.25	
COP	Heating		W/W		3.60	
Running Current	Cooling/Heating		A		9.6/9.6	
Moisture Removal			l/h		4.5	
Sound Pressure (Cooling)	Indoor	H/M/L/Q	dB(A)		47/44/41	
	Outdoor	High	dB(A)		57	
Airflow Rate (High)	Indoor / Outdoor		m³/h		4300/9300	
Static pressure range (Standard)			Pa		50 to 250 (72)	
			mm		450x1587x700	
Net Dimension H x W x D	Indoor		kg(lbs)		110 (242)	
	Outdoor		mm		1690x930x765	
Piping Connections (Small / Large)			mm		12.70/25.40	
			kg(lbs)		215 (473)	
Max Pipe Length (Pre-Charge)			m		75 (20)	
Height Difference			m		30	
Operation Range	Cooling	°CDB		-5 to 46		
	Heating	°CDB		-15 to 24		
Refrigerant			R410A		R410A	

Dimensions Models : ARYC72LHTA / ARYC90LHTA

(Unit : mm)

Model: ARYC72LHTA

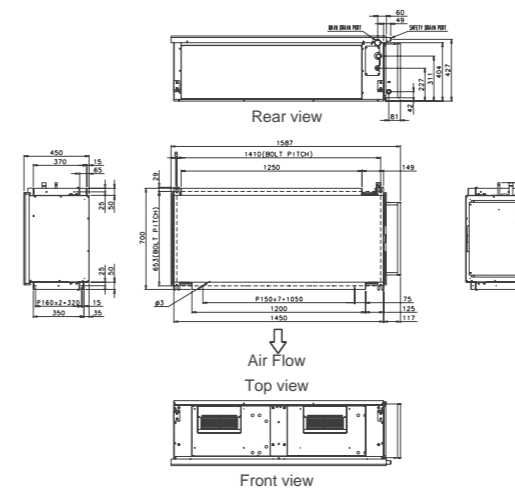

Model: ARYC90LHTA

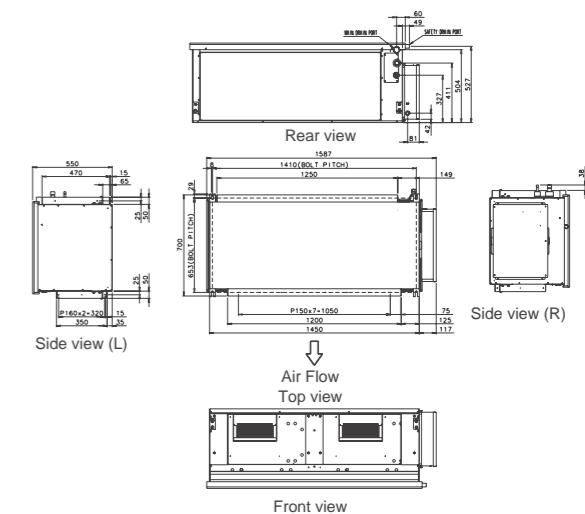

Control several indoor units  
with one outdoor unit.  
Build the optimum system you desire.

# MULTI SPLIT



## MULTI SPLIT

If you want to keep a large floor as well as many rooms comfortable, we recommend you use Multi Split to build a simple system using one outdoor unit. Choose from a large lineup of indoor units that best matches your rooms. You can mix and match them at will. Build the system that is just right for you.



Multi Split provides comfort in a variety of situations

from home to office and store.

- 086 2-8 Rooms Multi type Lineup
- 088 2 & 3-4 Rooms Multi
- 090 8 Rooms Multi
- 094 Specifications of All Indoor Units
- 096 Multi Combination Table
- 106 Simultaneous Multi Twin / Triple
- 108 Optional Parts for Split & Multi Split



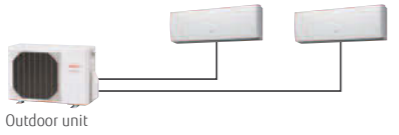
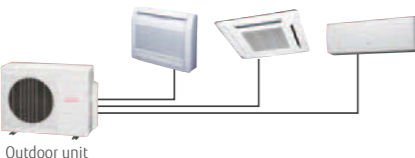

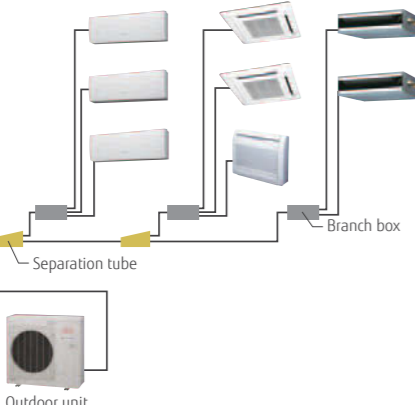

# 2-8 ROOMS MULTI TYPE LINEUP

ALL INVERTER MODELS

Model code	Cooling rated capacity(kW)	Capacity range					
		14	18	24	30	45	
		4	5	5.4	6.8	8	14
2 Rooms Multi Up to 2 units		● AOYG14LAC2	● AOYG18LAC2				
3 Rooms Multi Up to 3 units				● AOYG18LAT3	● AOYG24LAT3		
4 Rooms Multi Up to 4 units						● AOYG30LAT4	
8 Rooms Multi Up to 8 units							● AOYG45LBT8

Note : 1. 2 Rooms Multi: Connectable indoor units are 2 units.  
 AoyG14LAC2: Total capacity of indoor units connected must be between 4.0 kW and 6.2 kW.  
 AoyG18LAC2: Total capacity of indoor units connected must be between 4.0 kW and 7.0 kW.  
 2. 3 Rooms Multi: Connectable indoor units are 2 to 3 units.  
 AoyG18LAT3: Total capacity of indoor units connected must be between 4.0 kW and 8.5 kW.  
 AoyG24LAT3: Total capacity of indoor units connected must be between 4.0 kW and 10.5 kW.  
 3. 4 Rooms Multi: Connectable indoor units are 3 to 4 units.  
 AoyG30LAT4: Total capacity of indoor units connected must be between 7.9 kW and 14.4 kW.  
 4. 8 Rooms Multi: Connectable indoor units are 2 to 8 units.  
 AoyG45LBT8: Total capacity of indoor units connected must be between 11.2 kW and 18.2 kW.

## Connectable Indoor unit line-up

Outdoor Unit	Type	2 Rooms		3 Rooms		4 Rooms	8 Rooms
	Model name	AoyG14LAC2	AoyG18LAC2	AoyG18LAT3	AoyG24LAT3	AoyG30LAT4	AoyG45LBT8
	Capacity (kW)	Cooling		Cooling		Cooling	Cooling
		4.0	5.0	5.4	6.8	8.0	14.0
		4.4	5.6	6.8	8.0	9.6	16.0
Indoor Unit	BTU	kW Class					
	7000	2.0	●	●	●	●	●
	9000	2.5	●	●	●	●	●
	12000	3.5	●	●	●	●	●
	14000	4.0	—	●	●	●	●
	18000	5.0	—	—	●	●	●
	24000	7.0	—	—	—	●	●
	9000	2.5	—	●	●	●	●
	12000	3.5	—	●	●	●	●
	14000	4.0	—	—	●	●	●
	7000	2.0	—	●	●	●	●
	9000	2.5	—	●	●	●	●
	12000	3.5	—	●	●	●	●
	14000	4.0	—	—	●	●	●
	14000	4.0	—	—	●	●	●
	18000	5.0	—	—	—	●	●
	7000	2.0	—	●	●	●	●
	9000	2.5	—	●	●	●	●
	12000	3.5	—	●	●	●	●
	14000	4.0	—	—	●	●	●
	18000	5.0	—	—	—	●	●

## Indoor unit features

	Economy	Powerful	HEAT	Auto Reheat	Up/Down	Double	Adjust	Restart	Dust	Usable	Sleep	Program	Weekly	+Setback	Filter	ION	AF	Washable
ASYG07/09/12/14LM	●	●	●	●	●	●	●	●	●	●	●	●	●	●	●	●	●	●
ASYG07/09/12/14LU	●	●	●	●	●	●	●	●	●	●	●	●	●	●	●	●	●	●
ASYG18/24LF	●	●	●	●	●	●	●	●	●	●	●	●	●	●	●	●	●	●
AGYG09/12/14LV	●	●	●	●	●	●	●	●	●	●	●	●	●	●	●	●	●	●
AUYG07/09/12/14/18LV	●	●	●	●	●	●	●	●	○	○	●	●	●	●	●	●	●	●
ABYG14/18LV	●	●	●	●	●	●	●	●	○	○	●	●	●	●	●	●	●	●
ARYG07/09/12/14/18LL	●	○	●	○	●	●	●	●	○	○	○	○	○	●	●	●	●	●

○ : Optional function

**2 Rooms :** AOYG14LAC2 / AOYG18LAC2  
**3 Rooms :** AOYG18LAT3 / AOYG24LAT3  
**4 Rooms :** AOYG30LAT4



**Features**

**Space-saving installation**

Multiple indoor units can be connected to 1 outdoor unit, and long piping connection is also possible. Compared with single type, the outdoor unit can be installed in various places to realize the space-saving installation.

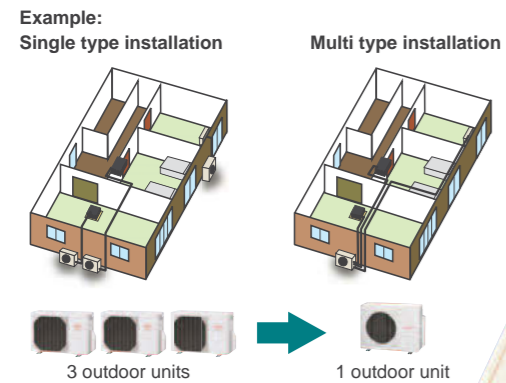

**Wide range of indoor units with various models**

7 types 25 models are lined up in the capacity range from 2 kW to 7 kW class. Wide range of needs can be met from rooms of private homes to large shops and hotels.

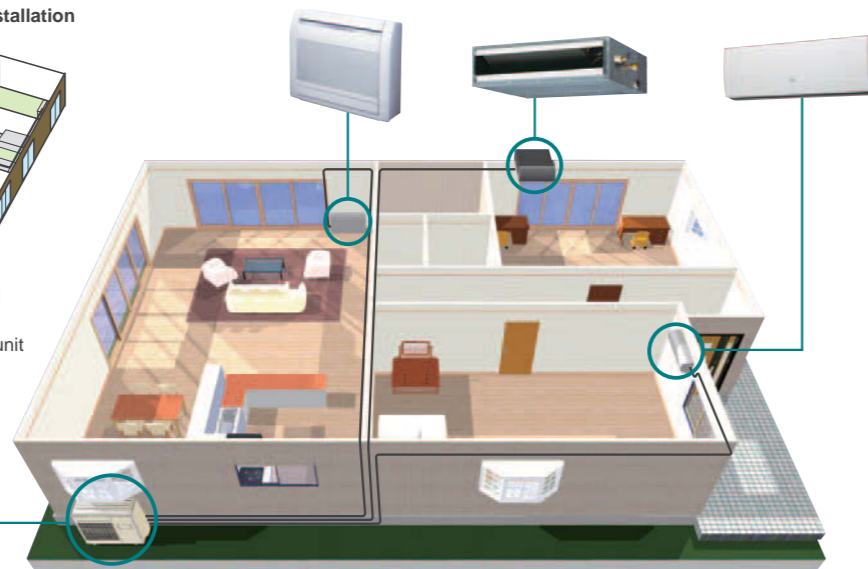

**Flexible installation**

Up to max. piping length of 70 m (AOYG30LAT4), max. height difference of 15 m can be supported. Multi type can be installed at large-size residence or buildings with multiple floors.

**Max. Piping Length (Each Unit):**  
**20 m** (AOYG14LAC2 / 18LAC2),  
**25 m** (AOYG18LAT3 / 24LAT3 / 30LAT4)

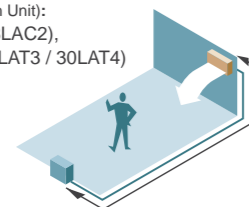

**Max. Height:**  
**15 m** (AOYG14LAC2 / 18LAC2 / 18LAT3 / 24LAT3 / 30LAT4)

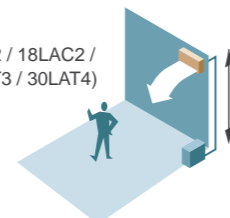

**Total Piping Length:**  
**30 m** (AOYG14LAC2 / 18LAC2),  
**50 m** (AOYG18LAT3 / 24LAT3),  
**70 m** (AOYG30LAT4)

**Specifications (2 ROOMS, 3 ROOMS, 4 ROOMS)**

Model No.	Outdoor unit	AOYG14LAC2	AOYG18LAC2	AOYG18LAT3	AOYG24LAT3	AOYG30LAT4
Power Source	V/Ø/Hz	230/1/50	230/1/50	230/1/50	230/1/50	230/1/50
Rated Capacity (min-max)	Cooling	4.0 (1.4-4.4)	5.0 (1.7-5.6)	5.4 (1.8-6.8)	6.8 (1.8-8.5)	8.0 (3.5-10.1)
	Heating	4.4 (1.1-5.4)	5.6 (1.8-6.1)	6.8 (2.0-8.0)	8.0 (2.0-8.8)	9.6 (3.7-12.0)
EER	Cooling	3.67	3.21	4.00	3.51	3.60
COP	Heating	4.27	3.97	4.20	4.00	4.00
Sound Pressure (High)	Cooling	47	50	46	48	50
	Heating	49	51	47	49	51
Sound Power (High)	Cooling	61	63	65	68	68
	Heating	63	64	67	70	70
Net Dimension H x W x D	mm	540x790x290	540x790x290	700x900x330	700x900x330	830x900x330
Weight	kg/(lbs)	37 (82)	38 (84)	55 (121)	55 (121)	68 (150)
Connection pipe Piping Connections	Small (Liquid)	Ø6.35x2	Ø6.35x2	Ø6.35x3	Ø6.35x3	Ø6.35x4 (*Ø6.35x3, Ø9.52)
	Large (Gas)	Ø9.52x2	Ø9.52x2 *(Ø9.52, Ø12.7)	Ø9.52x2, Ø12.7 *(Ø9.52x3)	Ø9.52x2, Ø12.7 *(Ø9.52x3)	Ø9.52x2, Ø12.7 *(Ø9.52x3, Ø12.7) *(Ø9.52x2, Ø12.7, Ø15.88)
Max. Length	Total / Each	30 / 20	30 / 20	50 / 25	50 / 25	70 / 25
	Max. Height Difference	Between Outdoor Unit and Each Indoor Units.	15	15	15	15
Between Indoor Units.		10	10	10	10	10
Operation Range	Cooling	10 to 46	10 to 46	-10 to 46	-10 to 46	0 to 46
	Heating	-15 to 24	-15 to 24	-15 to 24	-15 to 24	-10 to 24
Refrigerant		R410A	R410A	R410A	R410A	R410A

\* Connect to connection valve by the adapter.

**Dimensions**

(Unit : mm)

**Models : AOYG14LAC2 / AOYG18LAC2**

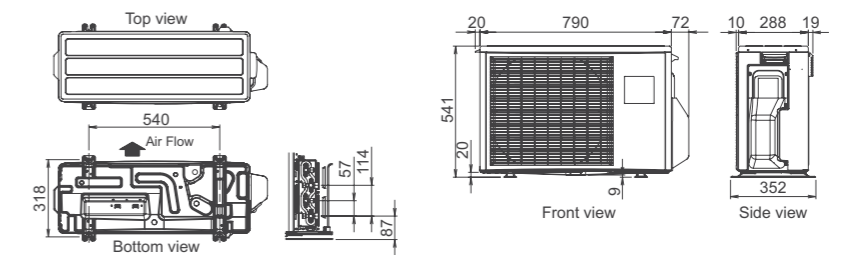

**Models : AOYG18LAT3 / AOYG24LAT3**

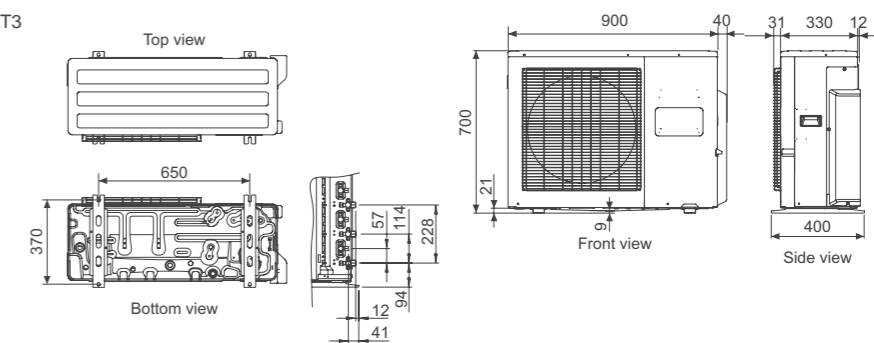

**Models : AOYG30LAT4**

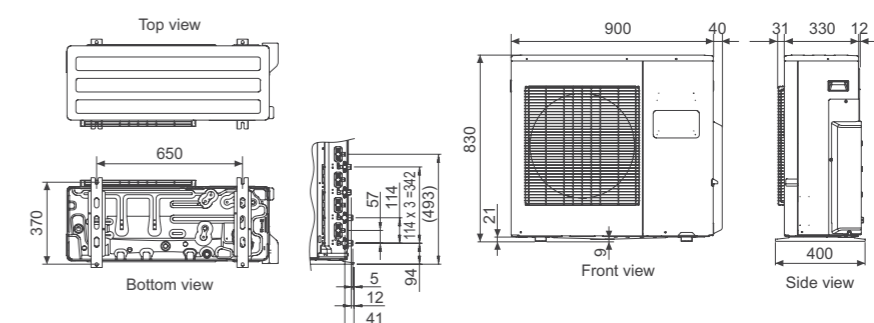

8 Rooms : AOYG45LBT8



Features

### High Efficiency & Compact

#### Compact outdoor unit

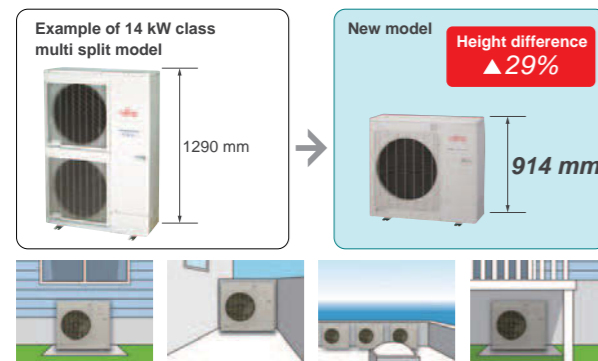

#### Innovated technology

- High efficiency large fan :** New high efficiency fan is mounted.
- DC fan motor :** High performance and high efficiency has been realized by using a small DC fan motor.
- Heat exchanger :** Reduced compact size and energy saving has been realized by utilizing high density piping design and 3-Row heat exchanger.
- High efficiency DC twin rotary compressor :** A high performance, low noise, large capacity DC twin rotary compressor is used.

#### High seasonal efficiency

The actual performance is conducted under various outside temperatures depending on weather and seasons, furthermore, especially for multi system, not all the rooms are operated all the time. So over 90% of actual operation time, air conditioners are operated at partial capacity instead of rated capacity. Considering these, we focused on energy-saving performance which is based on actual use. Efficiency of part load performance was drastically improved by developing ALL DC and our own inverter system.

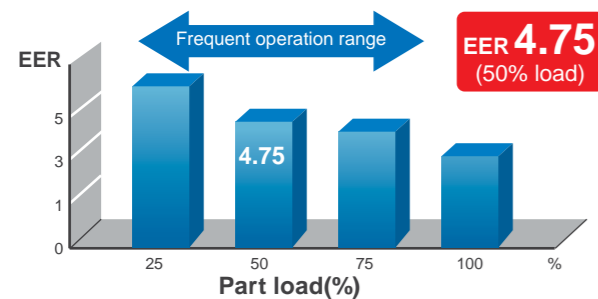

### More Comfort

#### Quick comfort by optimized refrigerant control

Every room meets the set point most quickly and comfortably by optimized refrigerant control.

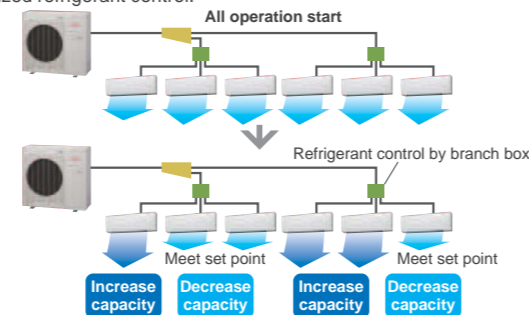

Features

### Central Remote Controller Option

Central remote controller developed for residential applications. All indoor units can be batched controlled using simple operations. Schedule management and other functions can be used to achieve even greater energy savings.



UTY-DMMYM

#### Central & Individual Control

Batched control of up to 8 indoor units. The temperature, airflow volume, and remote control prohibition settings of all indoor units can be batched.

#### Easy-To-Use operation

- Large backlight LED screen
- Large easy-to-see operation panel

#### Multiple language support

Corresponds to 9 different languages (English, German, French, Spanish, Russian, Portuguese, Italian, Greek, and Turkish)

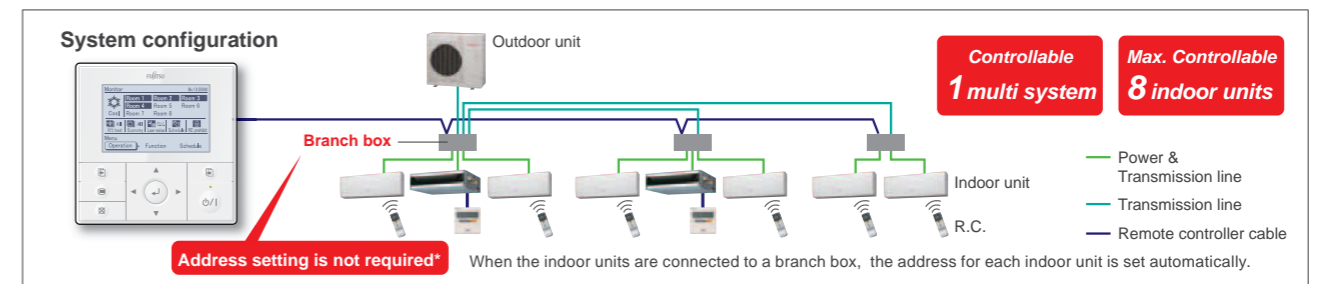

\*Note : Cross-over connections are not allowed in the refrigerant system. Group settings are not allowed.

#### 10°C heat operation

When you leave, minimum heating operation is performed to maintain the room temperature (maintain at 10°C).

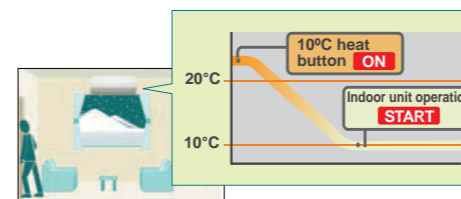

#### Economy operation

Economy operation is energy saving, as the set temperature of indoor unit is shifted by 1°C and the maximum electric value of the outdoor unit is suppressed.

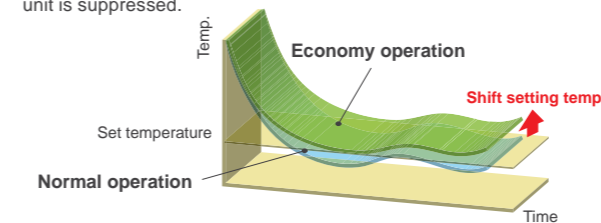

#### Prohibited Settings

The remote controller operation of all indoor units comes with a lock function to prevent unapproved operations in the various rooms. The central remote controller also has a key lock function to prevent children from playing with it, etc

#### Weekly schedule timer

The ON/OFF setting can be set for 4 times a day. Two weekly patterns can be set to match the cooling and heating seasons.

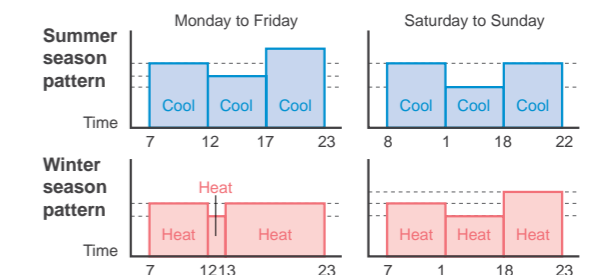

#### Low noise operation

Users can choose from 4 low noise levels, depending on the installation environment. The operation time can be set using the timer.

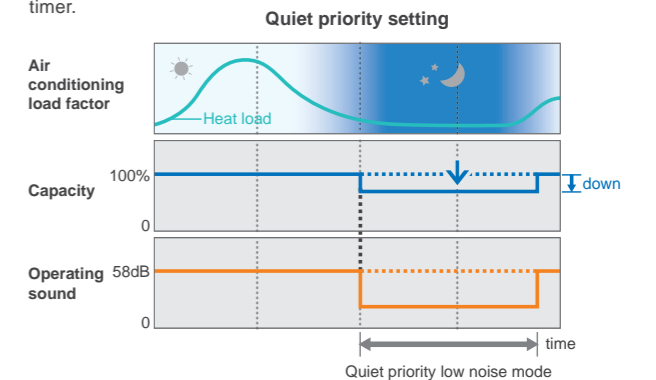

Features

## Flexible Design & Easy Installation

### Large capacity connection

Up to 8 indoor units can be connected to one outdoor unit. A maximum of 130% indoor unit connectable capacity. Match any room layout.

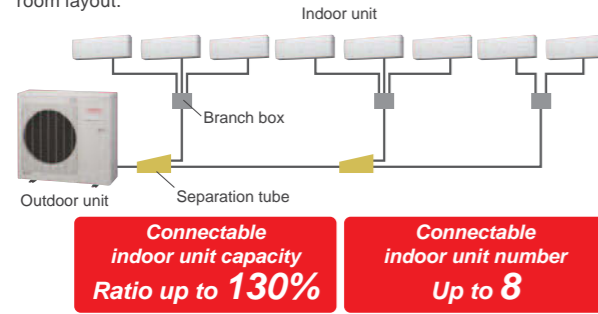

### Long piping design

Can be installed in high rise condominiums or commercial buildings.

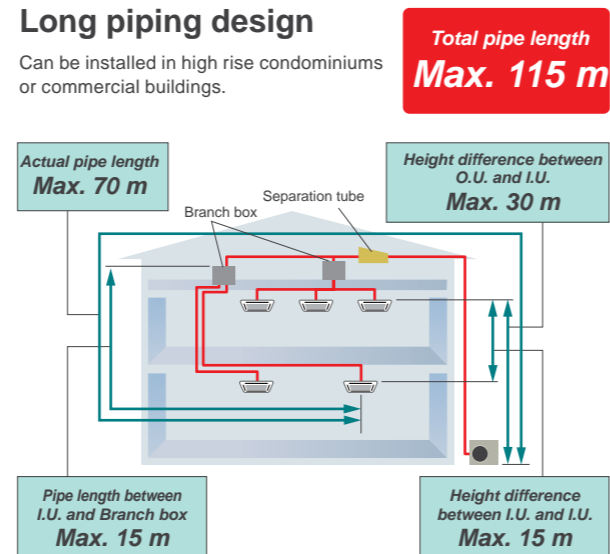

All flare piping connection and simple installation that minimizes wiring mistakes.

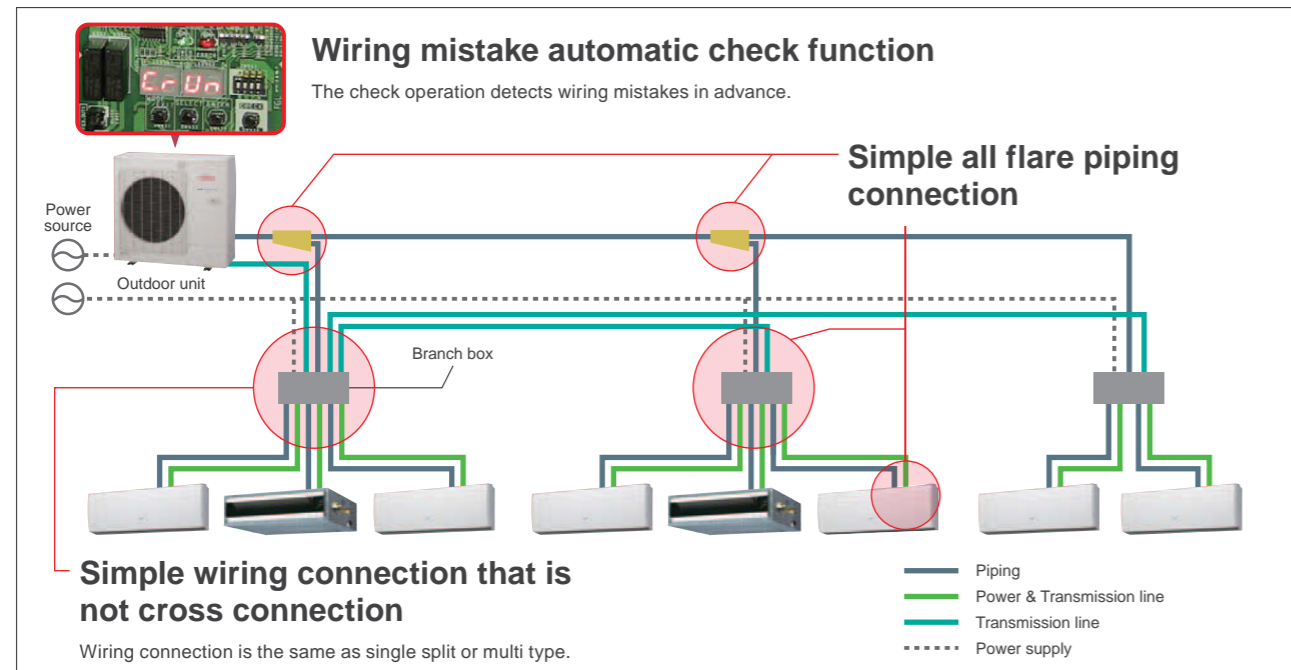

### Branch Box can be mounted flexibly.

Allowed Branch Box Mounting Direction

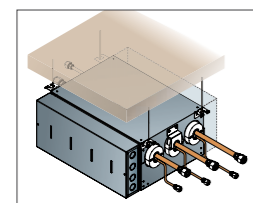

**Hanging from the ceiling**  
Do not hang from the ceiling when performing a vertical installation.

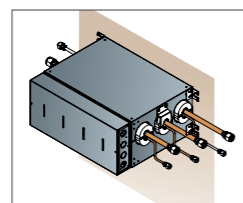

**Horizontal Wall Mounting**  
Install the unit with its top side facing upwards.

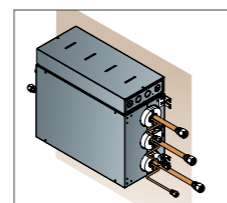

**Vertical Wall Mounting**  
Install the unit with the control box facing upwards.

## Specifications

Model name		AOYG45LBT8	
Maximum Connectable Indoor Unit		8	
Indoor unit connectable capacity	Cooling	11.2 - 18.2	
Power source		V/Ø/Hz	230/1/50
Rated Capacity	Cooling	14.0	
	Heating	16.0	
Input Power	Cooling	5.20	
	Heating	5.07	
Air flow rate	Cooling	4,650	
	Heating	4,800	
Sound pressure level	Cooling	56	
	Heating	58	
Heat exchanger fin		Plate fin coil	
Net Dimensions H x W x D		mm	914 x 970 x 370
Weight		kg(lbs)	98 (217)
Piping Connections (Small / Large)		mm	9.52/15.88
Max Pipe Length		m	115 (Total)
Max Height Difference (O.U ~ I.U)		m	30
Operating range	Cooling	°CDB -5 to 46	
	Heating	°CDB -15 to 24	
Refrigerant		R410A	

Model name		UTP-PY03A		UTP-PY02A	
Connectable indoor unit		1 to 3 Units		1 to 2 Units	
Power source		V/Ø/Hz 230/1/50		230/1/50	
Available voltage range		198-264V		198-264V	
Power consumption		W	10	10	
Running current		A	0.05	0.05	
Dimensions (HxWxD)		mm 195x433x370		195x433x370	
Weight		kg 9		9	
Connection pipe	Size	Liquid	Main: 9.52x1, Branch:6.35x3		Main: 9.52x1, Branch:6.35x2
		Gas	Main: 15.88x1, Branch:12.7x3		Main: 15.88x1, Branch:12.7x2
	Method	Flare		Flare	

Note: Specifications are based on the following conditions.  
Power source of specifications: 230V.

## Dimensions

Outdoor Unit : AOYG45LBT8

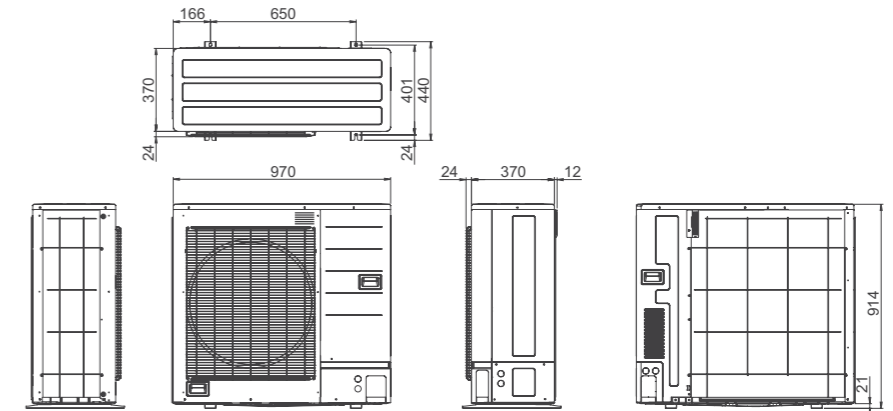

Branch Box : UTP-PY03A (3 branches type)

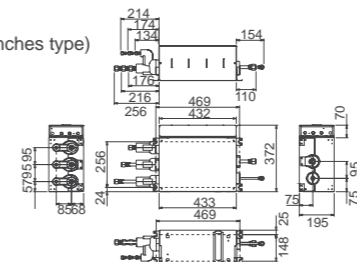

Branch Box : UTP-PY02A (2 branches type)

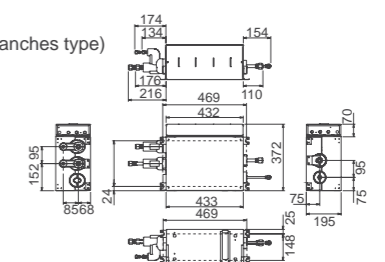

# SPECIFICATIONS OF ALL INDOOR UNITS

## Specifications

### Compact wall mounted



Model No.	Indoor unit		ASYG07LUCA	ASYG09LUCA	ASYG12LUCA	ASYG14LUCA
kW Class	kW		2.0	2.5	3.5	4.0
Power Source	V/Ø/Hz		230/1/50	230/1/50	230/1/50	230/1/50
Sound Pressure Level	Cooling	H/M/L/Q	35/30/28/21	36/32/28/21	37/34/31/21	41/36/33/25
	Heating		35/30/28/21	36/32/28/21	37/34/31/21	41/36/34/27
Sound Power Level	Cooling	H	53	54	55	59
	Heating		53	54	55	59
Air Flow	Cooling	H/M/L/Q	570/520/470/330	600/550/470/330	660/600/530/330	710/640/570/390
	Heating		570/520/470/330	600/550/470/330	660/600/530/330	710/640/590/430
Net Dimension	mm		282x870x185	282x870x185	282x870x185	282x870x185
Weight	kg(lbs)		9.5 (21)	9.5 (21)	9.5 (21)	9.5 (21)
Pipe Size	Liquid/Gas	mm	Ø6.35/Ø9.52	Ø6.35/Ø9.52	Ø6.35/Ø9.52	Ø6.35/Ø12.7

### Wall mounted



Model No.	Indoor unit		ASYG07LMCA	ASYG09LMCA	ASYG12LMCA	ASYG14LMCA	ASYG18LFCA	ASYG24LFCC
kW Class	kW		2.0	2.5	3.5	4.0	5.0	7.0
Power Source	V/Ø/Hz		230/1/50	230/1/50	230/1/50	230/1/50	230/1/50	230/1/50
Sound Pressure Level	Cooling	H/M/L/Q	36/32/29/21	37/33/29/21	40/36/30/21	42/38/33/25	43/37/33/26	49/42/37/33
	Heating		36/32/29/22	37/33/29/22	40/36/31/22	42/38/35/27	42/37/33/25	48/42/37/33
Sound Power Level	Cooling	H	51	52	54	56	58	64
	Heating		51	52	55	57	58	64
Air Flow	Cooling	H/M/L/Q	560/500/430/310	600/520/430/310	660/560/450/310	730/600/530/360	900/740/620/550	1120/900/740/620
	Heating		560/500/430/330	600/520/430/330	660/560/470/330	730/615/560/375	900/740/620/550	1100/900/740/620
Net Dimension	mm		268x840x203	268x840x203	268x840x203	268x840x203	320x998x238	320x998x238
Weight	kg(lbs)		8.5 (19)	8.5 (19)	8.5 (19)	8.5 (19)	14 (30.8)	14 (30.8)
Pipe Size	Liquid/Gas	mm	Ø6.35/Ø9.52	Ø6.35/Ø9.52	Ø6.35/Ø9.52	Ø6.35/Ø12.7	Ø6.35/Ø12.7	Ø6.35/Ø15.88

### Floor



Model No.	Indoor unit		AGYG09LVCA	AGYG12LVCA	AGYG14LVCA
kW Class	kW		2.5	3.5	4.0
Power Source	V/Ø/Hz		230/1/50	230/1/50	230/1/50
Sound Pressure Level	Cooling	H/M/L/Q	39/34/28/22	42/36/30/22	44/38/31/22
	Heating		39/35/30/22	42/38/32/22	44/39/33/22
Sound Power Level	Cooling	H	52	55	56
	Heating		52	55	56
Air Flow	Cooling	H/M/L/Q	530/440/360/270	600/490/380/270	650/520/400/270
	Heating		530/460/380/270	600/510/410/270	650/540/430/270
Net Dimension	mm		600x740x200	600x740x200	600x740x200
Weight	kg(lbs)		14 (30.7)	14 (30.7)	14 (30.7)
Pipe Size	Liquid/Gas	mm	Ø6.35/Ø9.52	Ø6.35/Ø9.52	Ø6.35/Ø12.7

### Floor ceiling



Model No.	Indoor unit		ABYG14LVTA	ABYG18LVTB
kW Class	kW		4.0	5.0
Power Source	V/Ø/Hz		230/1/50	230/1/50
Sound Pressure Level	Cooling	H/M/L/Q	36/34/33/29 (Under ceiling)	41/38/34/32 (Under ceiling)
	Heating		39/37/36/32 (Floor console)	44/41/37/35 (Floor console)
Sound Power Level	Cooling	H	36/34/33/29 (Under ceiling)	41/38/34/32 (Under ceiling)
	Heating		39/37/36/32 (Floor console)	44/41/37/35 (Floor console)
Air Flow	Cooling	H/M/L/Q	51	55
	Heating		51	55
Air Flow	Cooling	H/M/L/Q	640/590/540/480	780/700/560/500
	Heating		640/590/540/480	780/700/560/500
Net Dimension	mm		199x990x655	199x990x655
Weight	kg(lbs)		27 (60)	27 (60)
Pipe Size	Liquid/Gas	mm	Ø6.35/Ø12.7	Ø6.35/Ø12.7

### Compact cassette



Model No.	Indoor unit		AUYG07LVLA	AUYG09LVLA	AUYG12LVLB	AUYG14LVLB	AUYG18LVLB
kW Class	kW		2.0	2.5	3.5	4.0	5.0
Power Source	V/Ø/Hz		230/1/50	230/1/50	230/1/50	230/1/50	230/1/50
Sound Pressure Level	Cooling	H/M/L/Q	33/31/29/27	33/31/29/27	37/33/31/28	40/35/32/29	42/37/33/29
	Heating		34/32/29/27	34/32/29/27	37/33/31/28	40/37/34/29	44/40/37/30
Sound Power Level	Cooling	H	46	46	49	52	54
	Heating		47	47	49	52	56
Air Flow	Cooling	H/M/L/Q	540/490/440/390	540/490/440/390	610/530/470/410	680/580/490/410	750/610/520/410
	Heating		540/490/440/390	540/490/440/390	610/530/470/410	700/620/550/430	800/710/600/450
Net Dimension	mm		245x570x570	245x570x570	245x570x570	245x570x570	245x570x570
Weight	kg(lbs)		15 (33.1)	15 (33.1)	15 (33.1)	15 (33.1)	15 (33.1)
Cassette Grille			UTG-UFYD-W				
Pipe Size	Liquid/Gas	mm	Ø6.35/Ø9.52	Ø6.35/Ø9.52	Ø6.35/Ø9.52	Ø6.35/Ø12.7	Ø6.35/Ø12.7

### Slim duct

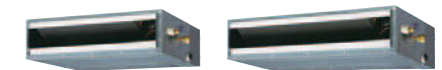

Model No.	Indoor unit		ARYG07LLTA	ARYG09LLTA	ARYG12LLTB	ARYG14LLTB	ARYG18LLTB
kW Class	kW		2.0	2.5	3.5	4.0	5.0
Power Source	V/Ø/Hz		230/1/50	230/1/50	230/1/50	230/1/50	230/1/50
Sound Pressure Level	Cooling	H/M/L/Q	28/26/25/24	28/27/26/25	29/28/27/26	32/30/28/26	32/31/30/29
	Heating		28/26/25/24	28/26/25/24	29/28/27/24	33/30/28/25	33/32/31/29
Sound Power Level	Cooling	H	57	57	58	60	58
	Heating		57	57	58	61	59
Air Flow	Cooling	H/M/L/Q	550/490/470/440	600/550/500/450	650/600/550/480	800/700/600/480	940/880/820/750
	Heating		550/490/470/440	600/550/500/450	650/600/550/480	800/700/600/480	940/880/820/750
Net Dimension	mm		198x700x620	198x700x620	198x700x620	198x700x620	198x900x620
Weight	kg(lbs)		17 (37.5)	19 (41.8)	19 (41.8)	19 (41.8)	23 (50.6)
Pipe Size	Liquid/Gas	mm	Ø6.35/Ø9.52	Ø6.35/Ø9.52	Ø6.35/Ø9.52	Ø6.35/Ø12.7	Ø6.35/Ø12.7
External static pressure			0 to 90				
Drain pump			Standard				



# MULTI COMBINATION TABLE

## 2 Rooms Multi cooling

AOYG14LAC2	Combination of Indoor Unit		COOLING OPERATION									
			Cooling Capacity			Input Power (min-max)	EER	Seasonal Data				
			Room 1	Room 2	Total Capacity (min-max)			Pdesign	SEER	Energy efficiency class		
		kW	kW	kW	kW		kW					
2 Room	7	7	2.00	2.00	4.00 (1.4 - 4.4)	1.09 (0.35 - 1.40)	3.67	4.0	6.7	A++		
	7	9	1.95	2.05	4.00 (1.4 - 4.4)	1.09 (0.35 - 1.40)	3.67	4.0	6.6	A++		
	7	12	1.65	2.35	4.00 (1.4 - 4.6)	1.05 (0.35 - 1.47)	3.81	4.0	6.5	A++		
	9	9	2.00	2.00	4.00 (1.4 - 4.5)	1.09 (0.35 - 1.43)	3.67	4.0	6.6	A++		
	9	12	1.70	2.30	4.00 (1.4 - 4.7)	1.05 (0.35 - 1.47)	3.81	4.0	6.5	A++		

- Note: •7:7000Btu/h / 9:9000Btu/h / 12:12000Btu/h models  
 •The above is the value for connecting with Wall Mounted type.  
 •2 or more indoor units should be connected.  
 •Cooling capacity is based on 27°CDB/19°CWB (indoor temperature), 35°CDB (outdoor temperature).  
 •Pipe Length: 5 m, Height difference: 0 m (Outdoor unit to Indoor unit)  
 •The Total ability of connected a indoor unit is up to 21000Btu from 14000Btu.

AOYG18LAC2	Combination of Indoor Unit		COOLING OPERATION									
			Cooling Capacity			Input Power (min-max)	EER	Seasonal Data				
			Room 1	Room 2	Total Capacity (min-max)			Pdesign	SEER	Energy efficiency class		
		kW	kW	kW	kW		kW					
2 Room	7	7	2.10	2.10	4.20 (1.7 - 5.2)	1.24 (0.50 - 1.68)	3.39	4.2	7.0	A++		
	7	9	2.10	2.50	4.60 (1.7 - 5.3)	1.26 (0.50 - 1.79)	3.65	4.6	6.8	A++		
	7	12	1.90	3.10	5.00 (1.7 - 5.6)	1.55 (0.35 - 1.95)	3.23	5.0	6.5	A++		
	7	14	1.80	3.20	5.00 (1.8 - 5.7)	1.55 (0.40 - 1.99)	3.23	5.0	6.5	A++		
	9	9	2.50	2.50	5.00 (1.7 - 5.6)	1.56 (0.35 - 1.95)	3.21	5.0	6.6	A++		
	9	12	2.10	2.90	5.00 (1.7 - 5.7)	1.55 (0.35 - 1.95)	3.23	5.0	6.5	A++		
	9	14	2.00	3.00	5.00 (1.8 - 5.8)	1.55 (0.40 - 1.99)	3.23	5.0	6.4	A++		
	12	12	2.50	2.50	5.00 (1.7 - 5.8)	1.56 (0.35 - 1.99)	3.21	5.0	6.4	A++		

- Note: •7:7000Btu/h / 9:9000Btu/h / 12:12000Btu/h / 14:14000Btu/h models  
 •The above is the value for connecting with Wall Mounted type.  
 •2 or more indoor units should be connected.  
 •Cooling capacity is based on 27°CDB/19°CWB (indoor temperature), 35°CDB (outdoor temperature).  
 •Pipe Length: 5 m, Height difference: 0 m (Outdoor unit to Indoor unit)  
 •The Total ability of connected a indoor unit is up to 24000Btu from 14000Btu.  
 •Where "14" means "wall mounted type" only models. Other types of indoor units can not be connected.

## 3 Rooms Multi cooling

AOYG18LAT3	Combination of Indoor Unit		COOLING OPERATION									
			Cooling Capacity			Input Power (min-max)	EER	Seasonal Data				
			Room 1	Room 2	Room 3			Total Capacity (min-max)	Pdesign	SEER	Energy efficiency class	
		kW	kW	kW	kW		kW					
2 Room	7	7	-	2.30	2.30	-	4.60 (1.8 - 5.0)	1.22 (0.50 - 1.43)	3.77	4.6	6.3	A++
	7	9	-	2.30	2.70	-	5.00 (1.8 - 5.7)	1.35 (0.50 - 1.81)	3.70	5.0	6.2	A++
	7	12	-	1.98	3.02	-	5.00 (1.8 - 6.1)	1.34 (0.50 - 2.06)	3.73	5.0	6.2	A++
	7	14	-	1.88	3.42	-	5.30 (1.8 - 6.6)	1.34 (0.50 - 2.06)	3.96	5.3	6.1	A++
	9	9	-	2.50	2.50	-	5.00 (1.8 - 6.2)	1.35 (0.50 - 2.06)	3.70	5.0	6.2	A++
	9	12	-	2.18	2.82	-	5.00 (1.8 - 6.3)	1.35 (0.50 - 2.06)	3.70	5.0	6.2	A++
	9	14	-	2.07	3.23	-	5.30 (1.8 - 6.7)	1.35 (0.50 - 2.06)	3.93	5.3	6.1	A++
	12	12	-	2.55	2.55	-	5.10 (1.8 - 6.3)	1.35 (0.50 - 2.06)	3.78	5.1	6.1	A++
	12	14	-	2.41	2.89	-	5.30 (1.8 - 6.7)	1.35 (0.50 - 2.06)	3.93	5.3	6.1	A++
3 Room	7	7	7	1.80	1.80	1.80	5.40 (1.8 - 6.8)	1.35 (0.50 - 2.06)	4.00	5.4	6.9	A++
	7	7	9	1.70	1.70	2.00	5.40 (1.8 - 6.8)	1.35 (0.50 - 2.06)	4.00	5.4	6.9	A++
	7	7	12	1.53	1.53	2.33	5.40 (1.8 - 6.8)	1.35 (0.50 - 2.06)	4.00	5.4	6.7	A++
	7	7	14	1.41	1.41	2.58	5.40 (2.0 - 6.8)	1.35 (0.60 - 2.06)	4.00	5.4	6.7	A++
	7	9	9	1.81	1.81	1.89	5.40 (1.8 - 6.8)	1.35 (0.50 - 2.06)	4.00	5.4	6.8	A++
	7	9	12	1.46	1.72	2.22	5.40 (1.8 - 6.8)	1.35 (0.50 - 2.06)	4.00	5.4	6.7	A++
	7	9	14	1.35	1.58	2.47	5.40 (2.0 - 6.8)	1.35 (0.60 - 2.06)	4.00	5.4	6.7	A++
	9	9	9	1.80	1.80	1.80	5.40 (1.8 - 6.8)	1.35 (0.50 - 2.06)	4.00	5.4	6.8	A++
	9	9	12	1.64	1.64	2.12	5.40 (1.8 - 6.8)	1.35 (0.50 - 2.06)	4.00	5.4	6.7	A++

AOYG24LAT3	Combination of Indoor Unit		COOLING OPERATION									
			Cooling Capacity			Input Power (min-max)	EER	Seasonal Data				
			Room 1	Room 2	Room 3			Total Capacity (min-max)	Pdesign	SEER	Energy efficiency class	
		kW	kW	kW	kW		kW					
2 Room	7	7	-	2.30	2.30	-	4.60 (1.8 - 5.0)	1.20 (0.50 - 1.40)	3.83	4.6	6.3	A++
	7	9	-	2.30	2.70	-	5.00 (1.8 - 5.7)	1.36 (0.50 - 1.78)	3.68	5.0	6.2	A++
	7	12	-	2.38	3.42	-	5.80 (1.8 - 6.1)	1.70 (0.50 - 1.97)	3.41	5.8	6.1	A++
	7	14	-	2.37	4.13	-	6.50 (1.8 - 7.2)	1.91 (0.50 - 2.46)	3.40	6.5	6.0	A+
	7	18	-	2.08	4.52	-	6.60 (1.8 - 7.8)	1.91 (0.50 - 2.87)	3.46	6.6	5.9	A+
	9	9	-	2.75	2.75	-	5.50 (1.8 - 6.2)	1.55 (0.50 - 2.02)	3.55	5.5	6.1	A++
	9	12	-	2.79	3.41	-	6.20 (1.8 - 6.8)	1.90 (0.50 - 2.45)	3.26	6.2	5.9	A+
	9	14	-	2.66	3.94	-	6.60 (1.8 - 7.7)	1.91 (0.50 - 2.77)	3.46	6.6	6.0	A+
	9	18	-	2.35	4.35	-	6.70 (1.8 - 7.9)	1.91 (0.50 - 2.87)	3.51	6.7	5.9	A+
	12	12	-	3.15	3.15	-	6.90 (1.8 - 7.2)	1.90 (0.50 - 2.74)	3.32	6.3	5.9	A+
	12	14	-	3.03	3.67	-	6.70 (1.8 - 7.8)	1.91 (0.50 - 2.87)	3.51	6.7	5.9	A+
	12	18	-	2.66	4.04	-	6.70 (1.8 - 7.9)	1.92 (0.50 - 2.87)	3.49	6.7	5.8	A+
3 Room	7	7	7	2.23	2.23	2.23	6.70 (1.8 - 7.4)	1.89 (0.50 - 2.37)	3.54	6.7	6.4	A++
	7	7	9	2.14	2.14	2.52	6.80 (1.8 - 7.8)	1.94 (0.60 - 2.87)	3.51	6.8	6.4	A++
	7	7	12	1.98	1.98	2.84	6.80 (1.8 - 8.1)	1.93 (0.50 - 2.87)	3.52	6.8	6.3	A++
	7	7	14	1.82	1.82	3.16	6.80 (2.0 - 8.4)	1.94 (0.60 - 2.87)	3.51	6.8	6.2	A++
	7	7	18	1.63	1.63	3.54	6.80 (2.0 - 8.5)	1.94 (0.60 - 2.87)	3.51	6.8	6.1	A++
	7	9	9	2.03	2.38	2.38	6.80 (1.8 - 8.2)	1.93 (0.50 - 2.87)	3.52	6.8	6.4	A++
	7	9	12	1.88	2.21	2.70	6.80 (1.8 - 8.2)	1.93 (0.50 - 2.87)	3.52	6.8	6.2	A++
	7	9	14	1.74	2.04	3.02	6.80 (2.0 - 8.4)	1.94 (0.60 - 2.87)	3.51	6.8	6.2	A++
	7	9	18	1.56	1.84	3.40	6.80 (2.0 - 8.5)	1.94 (0.60 - 2.87)	3.51	6.8	6.1	A++
	7	12	12	1.76	2.52	2.52	6.80 (1.8 - 8.2)	1.94 (0.50 - 2.87)	3.51	6.8	6.2	A++
	7	12	14	1.63	2.34	2.63	6.80 (2.0 - 8.5)	1.94 (0.60 - 2.87)	3.51	6.8	6.2	A++
	9	9	9	2.27	2.27	2.27	6.80 (1.8 - 8.2)	1.94 (0.50 - 2.87)	3.51	6.8	6.4	A++
	9	9	12	2.11	2.11	2.58	6.80 (1.8 - 8.3)	1.94 (0.50 - 2.87)	3.51	6.8	6.2	A++
	9	9	14	1.95	1.95	2.89	6.80 (2.0 - 8.5)	1.94 (0.60 - 2.87)	3.51	6.8	6.2	A++
	9	9	18 <sup>1</sup>	1.77	1.77	3.27	6.80 (2.0 - 8.5)	1.94 (0.60 - 2.87)	3.51	6.8	6.1	A++
	9	12	12	1.97	2.41	2.41	6.80 (1.8 - 8.3)	1.94 (0.50 - 2.87)	3.51	6.8	6.2	A++
	9	12	14	1.84	2.24	2.72	6.80 (2.0 - 8.5)	1.94 (0.60 - 2.87)	3.51	6.8	6.2	A++
	12	12	12	2.27	2.27	2.27	6.80 (1.8 - 8.3)	1.94 (0.50 - 2.87)	3.51	6.8	6.1	A++

- Note: •7:7000Btu/h / 9:9000Btu/h / 12:12000Btu/h / 14:14000Btu/h / 18:18000Btu/h models  
 •The above is the value for connecting with Wall Mounted type.  
 •2 or more indoor units should be connected.  
 •Cooling capacity is based on 27°CDB/19°CWB (indoor temperature), 35°CDB (outdoor temperature).  
 •Pipe Length: 5 m, Height difference: 0 m (Outdoor unit to Indoor unit)  
 •The total ability of connectable indoor units is up to 36000Btu from 14000Btu.  
 •1: When ASYG18L is connected, connect at least 1 wall mounted type of 9000Btu.

## 2 Rooms Multi heating

AOYG14LAC2	Combination of Indoor Unit		HEATING OPERATION									
			Heating Capacity			Input Power (min-max)	COP	Seasonal Data				
			Room 1	Room 2	Total Capacity (min-max)			Pdesign	SCOP	Energy efficiency class		
		kW	kW	kW	kW		kW					
2 Room	7	7	2.20	2.20	4.40 (1.1 - 5.4)	1.03 (0.25 - 1.78)	4.27	3.8	4.1	A+		
	7	9	2.15	2.25	4.40 (1.1 - 5.4)	1.03 (0.25 - 1.78)	4.27	3.8	4.1	A+		
	7	12	1.95	2.45	4.40 (1.1 - 5.5)	1.02 (0.25 - 1.76)	4.31	3.8	4.0	A+		
	9	9	2.20	2.20	4.40 (1.1 - 5.4)	1.03 (0.25 - 1.78)	4.27	3.8	4.0	A+		
	9	12	2.00	2.40	4.40 (1.1 - 5.5)	1.02 (0.25 - 1.76)	4.31	3.8	4.0	A+		

- Note: •7:7000Btu/h / 9:9000Btu/h / 12:12000Btu/h models  
 •The above is the value for connecting with Wall Mounted type.  
 •2 or more indoor units should be connected.  
 •Heating capacity is based on 20°CDB (indoor temperature), 7°CDB/6°CWB (outdoor temperature).  
 •Pipe Length: 5 m, Height difference: 0 m (Outdoor unit to Indoor unit)  
 •The Total ability of connected a indoor unit is up to 21000Btu from 14000Btu.

AOYG18LAC2	Combination of Indoor Unit		HEATING OPERATION									
			Heating Capacity			Input Power (min-max)	COP	Seasonal Data				
			Room 1	Room 2	Total Capacity (min-max)			Pdesign	SCOP	Energy efficiency class		
		kW	kW	kW	kW		kW					
2 Room	7	7	2.70	2.70	5.40 (1.8 - 6.0)	1.24 (0.50 - 1.61)	4.37	3.8	4.1	A+		
	7	9	2.50	3.00	5.50 (1.8 - 6.0)	1.36 (0.50 - 1.87)	4.04	4.0	4.1	A+		
	7	12	2.30	3.30	5.60 (1.8 - 6.1)	1.38 (0.50 - 1.88)	4.06	4.2	4.0	A+		
	7	14	2.25	3.35	5.60 (1.9 - 6.2)	1.35 (0.55 - 1.86)	4.15	4.2	4.0	A+		
	9	9	2.80	2.80	5.60 (1.8 - 6.1)	1.41 (0.50 - 1.90)	3.97	4.2	4.1	A+		
	9	12	2.45	3.15	5.60 (1.8 - 6.2)	1.38 (0.50 - 1.88)	4.07	4.2	4.0	A+		
	9	14	2.35	3.25	5.60 (1.9 - 6.3)	1.35 (0.55 - 1.86)	4.15	4.2	4.0	A+		
	12	12	2.80	2.80	5.60 (1.8 - 6.3)	1.34 (0.50 - 1.84)	4.18	4.2	4.0	A+		

- Note: •7:700

MULTI COMBINATION TABLE

4 Rooms Multi cooling

AOYG30LAT4	Combination of Indoor Unit		COOLING OPERATION										Seasonal Data		
			Cooling Capacity				Input Power (min-max)		EER						
			Room 1	Room 2	Room 3	Room 4	Total Capacity (min-max)	Input Power (min-max)							
			kW	kW	kW	kW	kW	kW							
7	7	14	-	1.96	1.96	3.27	-	7.20 (1.6-8.9)	2.22 (0.68-3.43)	3.24	7.2	5.9	A+		
7	7	18	-	1.81	1.81	4.08	-	7.70 (2.8-10.0)	2.22 (0.98-3.55)	3.47	7.7	5.8	A+		
7	7	24	-	1.61	1.61	4.57	-	7.80 (2.8-10.1)	2.19 (0.98-3.53)	3.56	7.8	5.8	A+		
7	9	12	-	2.08	2.34	2.78	-	7.20 (1.6-8.9)	2.22 (0.68-3.41)	3.24	7.2	5.9	A+		
7	9	14	-	1.90	2.14	3.16	-	7.20 (2.8-9.1)	2.22 (0.98-3.56)	3.24	7.2	5.9	A+		
7	9	18	-	1.76	1.98	3.96	-	7.70 (2.8-9.9)	2.22 (0.98-3.56)	3.47	7.7	5.8	A+		
7	9	24	-	1.57	1.77	4.46	-	7.80 (2.8-10.1)	2.19 (0.98-3.53)	3.56	7.8	5.8	A+		
7	12	12	-	1.96	2.62	2.62	-	7.20 (1.6-9.1)	2.22 (0.68-3.54)	3.24	7.2	5.9	A+		
7	12	14	-	1.83	2.43	3.04	-	7.30 (2.8-9.2)	2.22 (0.98-3.56)	3.29	7.3	5.9	A+		
7	12	18	-	1.68	2.24	3.78	-	7.70 (2.8-9.9)	2.22 (0.98-3.56)	3.47	7.7	5.8	A+		
7	12	24	-	1.51	2.01	4.28	-	7.80 (2.8-10.1)	2.19 (0.98-3.56)	3.56	7.8	5.8	A+		
7	14	14	-	1.68	2.81	2.81	-	7.30 (2.8-9.3)	2.22 (0.98-3.58)	3.29	7.3	5.9	A+		
7	14	18	-	1.57	2.81	3.52	-	7.70 (3.5-10.0)	2.22 (1.17-3.58)	3.47	7.7	5.8	A+		
7	14	24	-	1.44	2.39	4.07	-	7.90 (3.5-10.1)	2.20 (1.17-3.58)	3.59	7.9	5.8	A+		
7	18	18	-	1.42	3.19	3.19	-	7.80 (3.5-10.1)	2.22 (1.17-3.58)	3.51	7.8	5.7	A+		
7	18	24	-	1.30	2.92	3.68	-	7.90 (4.7-10.1)	2.22 (1.27-3.58)	3.56	7.9	5.7	A+		
9	9	9	-	2.40	2.40	2.40	-	7.20 (2.8-9.9)	2.22 (0.98-3.42)	3.24	7.2	5.9	A+		
9	9	12	-	2.26	2.26	2.68	-	7.20 (2.8-9.9)	2.22 (0.98-3.54)	3.24	7.2	5.9	A+		
9	9	14	-	2.10	2.10	3.11	-	7.30 (2.8-9.2)	2.22 (0.98-3.57)	3.29	7.3	5.9	A+		
9	9	18	-	1.93	1.93	3.85	-	7.70 (2.8-9.9)	2.22 (0.98-3.56)	3.47	7.7	5.8	A+		
9	9	24	-	1.73	1.73	4.35	-	7.80 (2.8-10.1)	2.20 (1.17-3.54)	3.55	7.8	5.8	A+		
9	12	12	-	2.14	2.53	2.53	-	7.20 (2.8-9.1)	2.22 (0.98-3.54)	3.24	7.2	5.9	A+		
9	12	14	-	1.99	2.36	2.95	-	7.30 (2.8-9.2)	2.22 (0.98-3.57)	3.29	7.3	5.9	A+		
9	12	18	-	1.84	2.18	3.68	-	7.70 (2.8-9.9)	2.22 (0.98-3.56)	3.47	7.7	5.8	A+		
9	12	24	-	1.66	1.97	4.18	-	7.80 (2.8-10.1)	2.19 (0.98-3.56)	3.56	7.8	5.8	A+		
9	14	14	-	1.84	2.73	2.73	-	7.30 (3.5-9.3)	2.22 (1.17-3.58)	3.29	7.3	5.9	A+		
9	14	18	-	1.74	2.58	3.48	-	7.80 (3.5-10.0)	2.22 (1.17-3.58)	3.51	7.8	5.8	A+		
9	14	24	-	1.58	2.34	3.98	-	7.90 (3.5-10.1)	2.22 (1.27-3.56)	3.56	7.9	5.8	A+		
9	18	18	-	1.56	3.12	3.12	-	7.80 (4.7-10.1)	2.22 (1.27-3.58)	3.51	7.8	5.7	A+		
12	12	12	-	2.43	2.43	2.43	-	7.30 (2.8-9.2)	2.22 (0.98-3.55)	3.29	7.3	5.9	A+		
12	12	14	-	2.28	2.28	2.85	-	7.40 (2.8-9.3)	2.22 (0.98-3.58)	3.33	7.4	5.9	A+		
12	12	18	-	2.12	2.12	3.57	-	7.80 (3.5-10.0)	2.22 (1.17-3.57)	3.51	7.8	5.8	A+		
12	12	24	-	1.92	1.92	4.07	-	7.90 (3.5-10.1)	2.20 (1.17-3.54)	3.59	7.9	5.8	A+		
12	14	14	-	2.11	2.64	2.64	-	7.40 (3.5-9.4)	2.22 (1.17-3.58)	3.33	7.4	5.9	A+		
12	14	18	-	1.98	2.48	3.34	-	7.80 (3.5-10.1)	2.22 (1.17-3.58)	3.51	7.8	5.8	A+		
12	18	18	-	1.81	3.05	3.05	-	7.90 (4.7-10.1)	2.22 (1.27-3.58)	3.56	7.9	5.7	A+		
7	7	7	7	1.93	1.93	1.93	1.93	7.70 (1.6-9.6)	2.20 (0.68-3.41)	3.50	7.7	6.2	A++		
7	7	7	9	1.89	1.89	1.89	2.13	7.80 (1.6-9.8)	2.22 (0.68-3.54)	3.51	7.8	6.2	A++		
7	7	7	12	1.83	1.83	1.83	2.41	7.90 (1.6-9.9)	2.22 (0.68-3.54)	3.56	7.9	6.1	A++		
7	7	7	14	1.70	1.70	1.70	2.80	7.90 (2.8-9.9)	2.22 (0.98-3.56)	3.56	7.9	6.1	A++		
7	7	7	18	1.52	1.52	1.52	3.43	8.00 (2.8-10.1)	2.20 (0.98-3.55)	3.64	8.0	6.0	A+		
7	7	9	9	1.86	1.86	2.09	2.09	7.90 (2.8-9.7)	2.22 (0.98-3.42)	3.56	7.9	6.2	A++		
7	7	9	12	1.78	1.78	1.98	2.35	7.90 (2.8-9.9)	2.22 (0.98-3.55)	3.56	7.9	6.1	A++		
7	7	9	14	1.68	1.68	1.88	2.76	8.00 (2.8-10.0)	2.22 (0.98-3.57)	3.60	8.0	6.1	A++		
7	7	9	18	1.49	1.49	1.67	3.35	8.00 (3.5-10.1)	2.20 (1.17-3.55)	3.64	8.0	6.0	A+		
7	7	12	12	1.72	1.72	2.28	2.28	8.00 (2.8-10.0)	2.22 (0.98-3.55)	3.60	8.0	6.1	A++		
7	7	12	14	1.61	1.61	2.13	2.65	8.00 (2.8-10.0)	2.22 (0.98-3.57)	3.60	8.0	6.1	A++		
7	7	12	18	1.43	1.43	1.91	3.22	8.00 (3.5-10.1)	2.20 (1.17-3.56)	3.64	8.0	6.0	A+		
7	7	14	14	1.50	1.50	2.50	2.50	8.00 (3.5-10.1)	2.22 (1.17-3.58)	3.60	8.0	6.0	A+		
7	7	14	18	1.35	1.35	2.25	3.04	8.00 (3.5-10.1)	2.22 (1.17-3.58)	3.60	8.0	6.0	A+		
7	9	9	9	1.81	2.03	2.03	2.03	7.90 (2.8-9.9)	2.22 (0.98-3.56)	3.56	7.9	6.2	A++		
7	9	9	12	1.76	1.96	1.96	2.32	8.00 (2.8-10.0)	2.22 (0.98-3.56)	3.60	8.0	6.1	A++		
7	9	9	14	1.64	1.83	1.83	2.70	8.00 (3.5-10.1)	2.22 (1.17-3.58)	3.60	8.0	6.1	A++		
7	9	9	18	1.45	1.64	1.64	3.27	8.00 (3.5-10.1)	2.22 (1.17-3.56)	3.60	8.0	6.0	A+		
7	9	12	12	1.68	1.88	2.22	2.22	8.00 (2.8-10.0)	2.22 (0.98-3.56)	3.60	8.0	6.1	A++		
7	9	12	14	1.57	1.76	2.08	2.59	8.00 (3.5-10.1)	2.22 (1.17-3.58)	3.60	8.0	6.0	A+		
7	9	12	18	1.40	1.58	1.87	3.15	8.00 (3.5-10.1)	2.22 (1.17-3.58)	3.60	8.0	6.0	A+		
7	9	14	14	1.48	1.66	2.43	2.43	8.00 (3.5-10.1)	2.22 (1.17-3.58)	3.60	8.0	6.0	A+		
7	9	14	18	1.32	1.49	2.21	2.98	8.00 (4.7-10.1)	2.22 (1.27-3.57)	3.60	8.0	6.0	A+		
7	12	12	12	1.61	2.13	2.13	2.13	8.00 (2.8-10.1)	2.22 (0.98-3.56)	3.60	8.0	6.0	A+		
7	12	12	14	1.51	2.00	2.00	2.49	8.00 (3.5-10.1)	2.22 (1.17-3.58)	3.60	8.0	6.0	A+		
7	12	12	18	1.35	1.80	1.80	3.04	8.00 (3.5-10.1)	2.22 (1.17-3.56)	3.60	8.0	6.0	A+		
7	12	14	14	1.41	1.89	2.35	2.35	8.00 (3.5-10.1)	2.22 (1.17-3.58)	3.60	8.0	6.0	A+		
9	9	9	9	2.00	2.00	2.00	2.00	8.00 (3.5-10.0)	2.22 (1.17-3.56)	3.60	8.0	6.2	A++		
9	9	9	12	1.91	1.91	2.27	2.27	8.00 (3.5-10.0)	2.22 (1.17-3.56)	3.60	8.0	6.1	A++		
9	9	9	14	1.79	1.79	2.63	2.63	8.00 (3.5-10.0)	2.22 (1.17-3.56)	3.60	8.0	6.0	A+		
9	9	9	18**	1.60	1.60	1.60	3.20	8.00 (4.7-10.0)	2.22 (1.17-3.56)	3.60	8.0	6.0	A+		
9	9	12	12	1.83	1.83	2.17	2.17	8.00 (3.5-10.0)	2.22 (1.17-3.56)	3.60	8.0	6.0	A+		
9	9	12	14	1.72	1.72	2.03	2.53	8.00 (3.5-10.0)	2.22 (1.17-3.56)	3.60	8.0	6.0	A+		
9	9	12	18**	1.54	1.54	1.83	3.09	8.00 (4.7-10.0)	2.22 (1.17-3.56)	3.60	8.0	6.0	A+		
9	9	14	14	1.62	1.62	2.38	2.38	8.00 (4.7-10.0)	2.22 (1.17-3.56)	3.60	8.0	6.0	A+		
9	12	12	12	1.76	2.08	2.08	2.08	8.00 (3.5-10.0)	2.22 (1.17-3.56)	3.60	8.0	6.0	A+		
9	12	12	14	1.66	1.95	1.95	2.44	8.00 (3.5-10.0)	2.22 (1.17-3.56)	3.60	8.0	6.0	A+		
9	12	14	14	1.55	1.85	2.30	2.30	8.00 (4.7-10.0)	2.22 (1.17-3.56)	3.60	8.0	6.0	A+		
12	12	12	12	2.00	2.00	2.00	2.00	8.00 (3.5-10.0)	2.22 (1.17-3.56)	3.60	8.0	6.0	A+		

Note: \*7:7000Btu/h / 9:9000Btu/h / 12:12000Btu/h / 14:14000Btu/h / 18:18000Btu/h / 24:24000Btu/h models  
 •The above is the value for connecting with Wall Mounted type.  
 •3 or more indoor units should be connected.  
 •Cooling capacity is based on 27°CDB/19°CWB (indoor temperature), 35°CDB (outdoor temperature).  
 •Pipe Length: 5 m, Height difference: 0 m (Outdoor unit to Indoor unit)  
 •The Total ability of connected indoor unit is up to 49000Btu from 27000Btu.  
 \*1: Connection of ASYG18L + ARYG09L + ARYG09L + ARYG09L is not available. All types other than this combination can be connected.  
 \*2: Connection of ASYG18L + ARYG12L + ARYG09L + ARYG09L is not available. All types other than this combination can be connected.

4 Rooms Multi heating

AOYG30LAT4	Combination of Indoor Unit		HEATING OPERATION										Seasonal Data		
			Heating Capacity				Input Power (min-max)		COP						
			Room 1	Room 2	Room 3	Room 4	Total Capacity (min-max)	Input Power (min-max)							
			kW	kW	kW	kW	kW	kW							
7	7	14	-	2.42	2.42	4.15	-	9.00 (1.8-10.1)	2.66 (0.58-3.53)	3.38	5.8	3.8	A		
7	7	18	-	2.27	2.27	4.86	-	9.40 (3.3-11.2)	2.46 (0.87-3.52)	3.82	5.8	3.8	A		
7	7	24	-	2.03	2.03	5.44	-	9.50 (3.3-11.5)	2.47 (0.87-3.52)	3.85	5.8	3.8	A		
7	9	12	-	2.49	2.94	3.56	-	9.00 (1.8-10.0)	2.69 (0.58-3.51)	3.35	5.8	3.8	A		
7	9	14	-	2.33	2.75	4.00	-	9.10 (3.3-10.2)	2.64 (0.87-3.50)	3.45	5.8	3.8	A		
7	9	18	-	2.17	2.56	4.66	-	9.40 (3.3-11.3)	2.45 (0.87-3.50)	3.84	5.8	3.8	A		
7	9	24	-	1.98	2.33	5.29	-	9.60 (3.3-11.5)	2.46 (0.87-3.51)	3.90	5.8	3.8	A		
7	12	12	-	2.33	3.33	3.33	-	9.00 (1.8-10.1)	2.66 (0.58-3.48)	3.38	5.8	3.8	A		
7	12	14	-	2.22	3.17	3.80	-	9.20 (3.3-10.3)	2.62 (0.87-3.48)	3.51	5.8	3.8	A		
7	12	18	-	2.08	2.97	4.45	-	9.50 (3.3-11.4)	2.44 (0.87-3.47)	3.89	5.8	3.8	A		
7	12	24	-	1.88	2.69	5.03	-	9.60 (3.3-11.7)	2.45 (0.87-3.56)	3.92	5.8	3.8	A		
7	14	14	-	2.10	3.60	3.60	-	9.30 (3.3-10.6)	2.59 (0.87-3.48)	3.59	5.8	3.8			

# MULTI COMBINATION TABLE

## 8 Rooms Multi cooling

AOYG45LBT8	Combination of indoor unit								COOLING OPERATION												
									Cooling Capacity									Total	Input power		
									Room 1	Room 2	Room 3	Room 4	Room 5	Room 6	Room 7	Room 8	KW				
2 Room	24	24	-	-	-	-	-	-	-	7.03	7.03	-	-	-	-	-	-	-	-	14.06	5.20
	18	18	24	-	-	-	-	-	-	5.27	7.03	-	-	-	-	-	-	-	-	12.30	4.24
	18	18	24	-	-	-	-	-	-	4.63	4.63	6.18	-	-	-	-	-	-	-	15.45	5.89
	18	18	18	-	-	-	-	-	-	5.01	5.01	5.01	-	-	-	-	-	-	-	15.03	5.90
	14	24	24	-	-	-	-	-	-	3.54	6.07	6.07	-	-	-	-	-	-	-	15.68	5.87
	14	18	24	-	-	-	-	-	-	3.84	4.94	6.59	-	-	-	-	-	-	-	15.37	5.90
	14	18	18	-	-	-	-	-	-	4.10	5.27	5.27	-	-	-	-	-	-	-	14.64	5.50
	14	14	24	-	-	-	-	-	-	4.10	4.10	7.03	-	-	-	-	-	-	-	15.23	5.79
	14	14	18	-	-	-	-	-	-	4.10	4.10	5.27	-	-	-	-	-	-	-	13.47	4.89
	14**	14**	14**	-	-	-	-	-	-	4.10	4.10	4.10	-	-	-	-	-	-	-	12.30	4.24
	12	24	24	-	-	-	-	-	-	3.09	6.18	6.18	-	-	-	-	-	-	-	15.45	5.89
	12	18	24	-	-	-	-	-	-	3.35	5.01	6.68	-	-	-	-	-	-	-	15.04	5.90
12	18	18	-	-	-	-	-	-	3.52	5.27	5.27	-	-	-	-	-	-	-	14.06	5.20	
12	14	24	-	-	-	-	-	-	3.52	4.10	7.03	-	-	-	-	-	-	-	14.65	5.50	
12	14	18	-	-	-	-	-	-	3.52	4.10	5.27	-	-	-	-	-	-	-	12.89	4.57	
12**	14**	14**	-	-	-	-	-	-	3.52	4.10	4.10	-	-	-	-	-	-	-	11.72	3.91	
12	12	24	-	-	-	-	-	-	3.52	3.52	7.03	-	-	-	-	-	-	-	14.07	5.20	
12	12	18	-	-	-	-	-	-	3.52	3.52	5.27	-	-	-	-	-	-	-	12.31	4.24	
9	24	24	-	-	-	-	-	-	2.46	6.54	6.54	-	-	-	-	-	-	-	15.54	5.90	
9	18	24	-	-	-	-	-	-	2.64	5.27	7.03	-	-	-	-	-	-	-	14.94	5.65	
9	18	18	-	-	-	-	-	-	2.64	5.27	5.27	-	-	-	-	-	-	-	13.18	4.73	
9	14	24	-	-	-	-	-	-	2.64	4.10	7.03	-	-	-	-	-	-	-	13.77	5.05	
9	14	18	-	-	-	-	-	-	2.64	4.10	5.27	-	-	-	-	-	-	-	12.01	4.08	
9	12	24	-	-	-	-	-	-	2.64	3.52	7.03	-	-	-	-	-	-	-	13.19	4.73	
9	12	18	-	-	-	-	-	-	2.64	3.52	5.27	-	-	-	-	-	-	-	11.43	3.74	
9	9	24	-	-	-	-	-	-	2.64	2.64	7.03	-	-	-	-	-	-	-	12.31	4.24	
7	24	24	-	-	-	-	-	-	1.93	6.64	6.64	-	-	-	-	-	-	-	15.21	5.90	
7	18	24	-	-	-	-	-	-	2.05	5.27	7.03	-	-	-	-	-	-	-	14.35	5.35	
7	18	18	-	-	-	-	-	-	2.05	5.27	5.27	-	-	-	-	-	-	-	12.59	4.41	
7	14	24	-	-	-	-	-	-	2.05	4.10	7.03	-	-	-	-	-	-	-	13.18	4.73	
7	14	18	-	-	-	-	-	-	2.05	4.10	5.27	-	-	-	-	-	-	-	11.42	3.74	
7	12	24	-	-	-	-	-	-	2.05	3.52	7.03	-	-	-	-	-	-	-	12.60	4.41	
7	9	24	-	-	-	-	-	-	2.05	2.64	7.03	-	-	-	-	-	-	-	11.72	3.91	
14	14	14	18	-	-	-	-	-	3.60	3.60	3.60	4.63	-	-	-	-	-	-	15.45	5.89	
14	14	14	14	-	-	-	-	-	3.84	3.84	3.84	3.84	-	-	-	-	-	-	15.37	5.90	
12	14	18	18	-	-	-	-	-	3.04	3.54	4.55	4.55	-	-	-	-	-	-	15.68	5.87	
12	14	14	18	-	-	-	-	-	3.15	3.67	3.67	4.72	-	-	-	-	-	-	15.21	5.90	
12	14	14	14	-	-	-	-	-	3.35	3.90	3.90	3.90	-	-	-	-	-	-	15.04	5.90	
12	12	18	18	-	-	-	-	-	3.09	3.09	4.63	4.63	-	-	-	-	-	-	15.45	5.89	
12	12	14	24	-	-	-	-	-	3.04	3.04	3.54	6.07	-	-	-	-	-	-	15.69	5.87	
12	12	14	18	-	-	-	-	-	3.30	3.30	3.84	4.94	-	-	-	-	-	-	15.38	5.90	
12	12	14	14	-	-	-	-	-	3.52	3.52	4.10	4.10	-	-	-	-	-	-	15.24	5.79	
12	12	12	24	-	-	-	-	-	3.09	3.09	3.09	6.18	-	-	-	-	-	-	15.45	5.89	
12	12	12	18	-	-	-	-	-	3.35	3.35	3.35	5.01	-	-	-	-	-	-	15.05	5.90	
12	12	12	14	-	-	-	-	-	3.52	3.52	3.52	4.10	-	-	-	-	-	-	14.66	5.90	
12	12	12	12	-	-	-	-	-	3.52	3.52	3.52	3.52	-	-	-	-	-	-	14.08	5.20	
9	14	18	18	-	-	-	-	-	2.34	3.64	4.67	4.67	-	-	-	-	-	-	15.33	5.89	
9	14	14	24	-	-	-	-	-	2.30	3.57	3.57	6.12	-	-	-	-	-	-	15.57	5.88	
9	14	14	18	-	-	-	-	-	2.49	3.87	3.87	4.97	-	-	-	-	-	-	15.21	5.90	
9	14	14	14	-	-	-	-	-	2.64	4.10	4.10	4.10	-	-	-	-	-	-	14.94	5.65	
9	12	18	18	-	-	-	-	-	2.46	3.28	4.90	4.90	-	-	-	-	-	-	15.54	5.90	
9	12	14	24	-	-	-	-	-	2.34	3.12	3.64	6.23	-	-	-	-	-	-	15.33	5.89	
9	12	14	18	-	-	-	-	-	2.53	3.37	3.93	5.05	-	-	-	-	-	-	14.87	5.90	
9	12	14	14	-	-	-	-	-	2.64	3.52	4.10	4.10	-	-	-	-	-	-	14.36	5.35	
9	12	12	24	-	-	-	-	-	2.46	3.28	3.28	6.54	-	-	-	-	-	-	15.55	5.90	
9	12	12	18	-	-	-	-	-	2.64	3.52	3.52	5.27	-	-	-	-	-	-	14.95	5.65	
9	12	12	14	-	-	-	-	-	2.64	3.52	3.52	4.10	-	-	-	-	-	-	13.78	5.05	
9	12	12	12	-	-	-	-	-	2.64	3.52	3.52	3.52	-	-	-	-	-	-	13.20	4.73	
9	9	18	24	-	-	-	-	-	2.32	2.32	4.63	6.18	-	-	-	-	-	-	15.45	5.89	
9	9	18	18	-	-	-	-	-	2.51	2.51	5.01	5.01	-	-	-	-	-	-	15.04	5.90	
9	9	14	24	-	-	-	-	-	2.47	2.47	3.84	6.59	-	-	-	-	-	-	15.38	5.90	
9	9	14	18	-	-	-	-	-	2.64	2.64	4.10	5.27	-	-	-	-	-	-	14.65	5.50	
9	9	14	14	-	-	-	-	-	2.64	2.64	4.10	4.10	-	-	-	-	-	-	13.48	4.89	
9	9	12	24	-	-	-	-	-	2.51	2.51	3.35	6.68	-	-	-	-	-	-	15.05	5.90	
9	9	12	18	-	-	-	-	-	2.64	2.64	3.52	5.27	-	-	-	-	-	-	14.07	5.20	
9	9	12	14	-	-	-	-	-	2.64	2.64	3.52	4.10	-	-	-	-	-	-	12.90	4.57	
9	9	12	12	-	-	-	-	-	2.64	2.64	3.52	3.52	-	-	-	-	-	-	12.32	4.24	
9	9	9	24	-	-	-	-	-	2.64	2.64	2.64	7.03	-	-	-	-	-	-	14.95	5.65	
9	9	9	18	-	-	-	-	-	2.64	2.64	2.64	5.27	-	-	-	-	-	-	13.19	4.73	
9	9	9	14	-	-	-	-	-	2.64	2.64	2.64	4.10	-	-	-	-	-	-	12.02	4.08	
9	9	9	12	-	-	-	-	-	2.64	2.64	2.64	3.52	-	-	-	-	-	-	11.44	3.74	
7	18	18	18	-	-	-	-	-	1.79	4.59	4.59	4.59	-	-	-	-	-	-	15.56	5.88	
7	14	18	18	-	-	-	-	-	1.91	3.82	4.91	4.91	-	-	-	-	-	-	15.54	5.90	
7	14	14	24	-	-	-	-	-	1.82	3.64	3.64	6.24	-	-	-	-	-	-	15.33	5.89	
7	14	14	18	-	-	-	-	-	1.96	3.93	3.93	5.05	-	-	-	-	-	-	14.87	5.90	
7	14	14	14	-	-	-	-	-	2.05	4.10	4.10	4.10	-	-	-	-	-	-	14.35	5.35	
7	12	18	24	-	-	-	-	-	1.79	3.07	4.59	6.12	-	-	-	-	-	-	15.57	5.88	
7	12	18	18	-	-	-	-	-	1.93	3.32	4.97	4.97	-	-	-	-	-	-	15.21	5.90	
7	12	14	24	-	-	-	-	-	1.91	3.28	3.82	6.54	-	-	-	-	-	-	15.54	5.90	
7	12	14	18	-	-	-	-	-	2.05	3.52	4.10	5.27	-	-	-	-	-	-	14.94	5.65	
7	12	14	14	-	-	-	-	-	2.05	3.52	4.10	4.10	-	-	-	-	-	-	13.77	5.05	
7	12	12	24	-	-	-	-	-	1.93	3.32	3.32	6.63	-	-	-	-	-	-	15.21	5.90	
7	12	12	18	-	-	-	-	-	2.05	3.52	3.52	5.27	-	-	-	-	-	-	14.36	5.35	
7	12	12	14	-	-	-	-	-	2.05	3.52	3.52	4.10	-	-	-	-	-	-	13.19	4.73	
7	12	12	12	-	-	-	-	-	2.05	3.52											

8 Rooms Multi cooling

AOYG45LBT8	Combination of indoor unit								COOLING OPERATION													
									Cooling Capacity									Input power				
									Room 1	Room 2	Room 3	Room 4	Room 5	Room 6	Room 7	Room 8	Total					
										KW	KW	KW	KW	KW	KW	KW	KW	KW	KW	KW	KW	KW
	7	9	9	9	9	18	-	-	-	1.79	2.30	2.30	2.30	2.30	4.59	-	-	-	-	-	15.57	5.88
	7	9	9	9	9	12	-	-	-	1.93	2.49	2.49	2.49	2.49	3.32	-	-	-	-	-	15.22	5.90
	7	9	9	9	9	9	-	-	-	2.05	2.64	2.64	2.64	2.64	2.64	-	-	-	-	-	15.25	5.79
	7	7	12	12	12	12	-	-	-	1.77	1.77	3.04	3.04	3.04	3.04	-	-	-	-	-	15.69	5.87
	7	7	9	12	14	-	-	-	-	1.79	1.79	3.04	3.07	3.07	3.57	-	-	-	-	-	15.57	5.88
	7	7	9	12	12	12	-	-	-	1.82	1.82	2.34	3.12	3.12	3.12	-	-	-	-	-	15.34	5.89
	7	7	9	9	14	14	-	-	-	1.80	1.80	2.32	3.60	3.60	3.60	-	-	-	-	-	15.45	5.89
	7	7	9	9	12	18	-	-	-	1.77	1.77	2.28	2.28	3.04	4.55	-	-	-	-	-	15.69	5.87
	7	7	9	9	12	14	-	-	-	1.83	1.83	2.36	2.36	3.15	3.67	-	-	-	-	-	15.21	5.90
	7	7	9	9	12	12	-	-	-	1.92	1.92	2.47	2.47	3.30	3.30	-	-	-	-	-	15.38	5.90
	7	7	9	9	9	18	-	-	-	1.82	1.82	2.34	2.34	4.67	-	-	-	-	-	-	15.33	5.89
	7	7	9	9	9	14	-	-	-	1.93	1.93	2.49	2.49	4.97	-	-	-	-	-	-	15.21	5.90
	7	7	9	9	9	12	-	-	-	1.96	1.96	2.53	2.53	3.37	-	-	-	-	-	-	14.88	5.90
	7	7	9	9	9	9	-	-	-	2.05	2.05	2.64	2.64	2.64	2.64	-	-	-	-	-	14.66	5.50
	7	7	7	12	14	14	-	-	-	1.79	1.79	1.79	3.07	3.57	3.57	-	-	-	-	-	15.57	5.88
	7	7	7	12	12	12	-	-	-	1.82	1.82	1.82	3.12	3.12	3.64	-	-	-	-	-	15.33	5.89
	7	7	7	12	12	12	-	-	-	1.91	1.91	1.91	3.28	3.28	3.28	-	-	-	-	-	15.55	5.90
	7	7	7	9	14	18	-	-	-	1.77	1.77	1.77	2.28	3.54	4.55	-	-	-	-	-	15.68	5.87
	7	7	7	9	14	14	-	-	-	1.84	1.84	1.84	2.36	3.67	3.67	-	-	-	-	-	15.21	5.90
	7	7	7	9	12	18	-	-	-	1.80	1.80	1.80	2.32	3.09	4.63	-	-	-	-	-	15.45	5.89
	7	7	7	9	12	14	-	-	-	1.92	1.92	1.92	2.47	3.30	3.84	-	-	-	-	-	15.38	5.90
	7	7	7	9	12	12	-	-	-	1.95	1.95	1.95	2.51	3.35	3.35	-	-	-	-	-	15.05	5.90
	7	7	7	9	9	18	-	-	-	1.91	1.91	1.91	2.46	2.46	4.90	-	-	-	-	-	15.54	5.90
	7	7	7	9	9	14	-	-	-	1.96	1.96	1.96	2.53	2.53	3.93	-	-	-	-	-	14.87	5.90
	7	7	7	9	9	12	-	-	-	2.05	2.05	2.05	2.64	2.64	3.52	-	-	-	-	-	14.95	5.65
	7	7	7	9	9	9	-	-	-	2.05	2.05	2.05	2.64	2.64	2.64	-	-	-	-	-	14.07	5.20
	7	7	7	7	14	18	-	-	-	1.80	1.80	1.80	3.60	4.63	-	-	-	-	-	-	15.45	5.89
	7	7	7	7	14	14	-	-	-	1.92	1.92	1.92	3.84	3.84	-	-	-	-	-	-	15.37	5.90
	7	7	7	7	12	18	-	-	-	1.84	1.84	1.84	1.84	3.15	4.72	-	-	-	-	-	15.21	5.90
	7	7	7	7	12	14	-	-	-	1.95	1.95	1.95	1.95	3.35	3.90	-	-	-	-	-	15.04	5.90
	7	7	7	7	12	12	-	-	-	2.05	2.05	2.05	2.05	3.52	3.52	-	-	-	-	-	15.24	5.79
	7	7	7	7	9	24	-	-	-	1.79	1.79	1.79	1.79	2.30	6.12	-	-	-	-	-	15.57	5.88
	7	7	7	7	9	18	-	-	-	1.93	1.93	1.93	1.93	2.49	4.97	-	-	-	-	-	15.21	5.90
	7	7	7	7	9	14	-	-	-	2.05	2.05	2.05	2.05	2.64	4.10	-	-	-	-	-	14.94	5.65
	7	7	7	7	9	12	-	-	-	2.05	2.05	2.05	2.05	2.64	3.52	-	-	-	-	-	14.36	5.35
	7	7	7	7	9	9	-	-	-	2.05	2.05	2.05	2.05	2.64	2.64	-	-	-	-	-	13.48	4.89
	7	7	7	7	7	24	-	-	-	1.82	1.82	1.82	1.82	1.82	6.24	-	-	-	-	-	15.33	5.89
	7	7	7	7	7	18	-	-	-	1.96	1.96	1.96	1.96	1.96	5.05	-	-	-	-	-	14.87	5.90
	7	7	7	7	7	14	-	-	-	2.05	2.05	2.05	2.05	2.05	4.10	-	-	-	-	-	14.35	5.35
	7	7	7	7	7	12	-	-	-	2.05	2.05	2.05	2.05	2.05	3.52	-	-	-	-	-	13.77	5.05
	7	7	7	7	7	9	-	-	-	2.05	2.05	2.05	2.05	2.05	2.64	-	-	-	-	-	12.89	4.57
	7	7	7	7	7	7	-	-	-	2.05	2.05	2.05	2.05	2.05	2.05	-	-	-	-	-	12.30	4.24
	7	9	9	9	9	9	-	-	-	1.78	2.30	2.30	2.30	2.30	2.30	2.30	2.30	3.04	-	-	15.57	5.88
	7	7	9	9	9	9	-	-	-	1.77	1.77	2.28	2.28	2.28	2.28	3.04	-	-	-	-	15.69	5.87
	7	7	9	9	9	9	-	-	-	1.82	1.82	2.34	2.34	2.34	2.34	3.04	-	-	-	-	15.34	5.89
	7	7	9	9	9	14	-	-	-	1.77	1.77	1.77	2.28	2.28	2.28	3.54	-	-	-	-	15.69	5.87
	7	7	9	9	9	12	-	-	-	1.80	1.80	1.80	2.32	2.32	2.32	3.09	-	-	-	-	15.45	5.89
	7	7	9	9	9	9	-	-	-	1.91	1.91	1.91	2.46	2.46	2.46	2.46	-	-	-	-	15.55	5.90
	7	7	7	9	12	12	-	-	-	1.79	1.79	1.79	1.79	2.30	3.07	-	-	-	-	-	15.57	5.88
	7	7	7	9	14	-	-	-	-	1.80	1.80	1.80	1.80	2.32	3.60	-	-	-	-	-	15.45	5.89
	7	7	7	9	12	-	-	-	-	1.83	1.83	1.83	1.83	2.36	3.15	-	-	-	-	-	15.21	5.90
	7	7	7	9	9	9	-	-	-	1.93	1.93	1.93	1.93	2.49	2.49	-	-	-	-	-	15.21	5.90
	7	7	7	7	12	14	-	-	-	1.79	1.79	1.79	1.79	3.07	3.57	-	-	-	-	-	15.57	5.88
	7	7	7	7	12	12	-	-	-	1.82	1.82	1.82	1.82	3.12	3.12	-	-	-	-	-	15.33	5.89
	7	7	7	7	9	18	-	-	-	1.77	1.77	1.77	1.77	2.28	4.55	-	-	-	-	-	15.68	5.87
	7	7	7	7	9	14	-	-	-	1.84	1.84	1.84	1.84	2.36	3.67	-	-	-	-	-	15.21	5.90
	7	7	7	7	9	12	-	-	-	1.92	1.92	1.92	1.92	2.47	3.30	-	-	-	-	-	15.38	5.90
	7	7	7	7	9	9	-	-	-	1.96	1.96	1.96	1.96	2.53	2.53	-	-	-	-	-	14.87	5.90
	7	7	7	7	7	18	-	-	-	1.80	1.80	1.80	1.80	1.80	4.63	-	-	-	-	-	15.45	5.89
	7	7	7	7	7	14	-	-	-	1.92	1.92	1.92	1.92	3.84	-	-	-	-	-	-	15.37	5.90
	7	7	7	7	7	12	-	-	-	1.95	1.95	1.95	1.95	1.95	3.35	-	-	-	-	-	15.04	5.90
	7	7	7	7	7	9	-	-	-	2.05	2.05	2.05	2.05	2.64	-	-	-	-	-	-	14.94	5.65
	7	7	7	7	7	7	-	-	-	2.05	2.05	2.05	2.05	2.05	2.05	-	-	-	-	-	14.35	5.35
	7	7	7	7	7	9	9	-	-	1.77	1.77	1.77	1.77	2.28	2.28	2.28	2.28	3.04	-	-	15.69	5.87
	7	7	7	7	7	9	9	-	-	1.80	1.80	1.80	1.80	1.80	2.32	2.32	2.32	3.09	-	-	15.45	5.89
	7	7	7	7	7	7	9	9	-	1.79	1.79	1.79	1.79	1.79	3.07	3.57	-	-	-	-	15.57	5.88
	7	7	7	7	7	7	9	9	-	1.82	1.82	1.82	1.82	3.12	3.12	-	-	-	-	-	15.33	5.89
	7	7	7	7	7	7	9	9	-	1.84	1.84	1.84	1.84	2.36	3.67	-	-	-	-	-	15.21	5.90
	7	7	7	7	7	7	9	9	-	1.92	1.92	1.92	1.92	2.47	3.30	-	-	-	-	-	15.38	5.90
	7	7	7	7	7	7	9	9	-	1.96	1.96	1.96	1.96	2.53	2.53	-	-	-	-	-	14.87	5.90
	7	7	7	7	7	7	18	-	-	1.80	1.80	1.80	1.80	1.80	4.63	-	-	-	-	-	15.45	5.89
	7	7	7	7	7	7	14	-	-	1.92	1.92	1.92	1.92	3.84	-	-	-	-	-	-	15.37	5.90
	7	7	7	7	7	7	12	-	-	1.95	1.95	1.95	1.95	1.95	3.35	-	-	-	-	-	15.04	5.90
	7	7	7	7	7	7	9	-	-	2.05	2.05	2.05	2.05									

# MULTI COMBINATION TABLE

## 8 Rooms Multi heating

AOYG45LBT8	Combination of indoor unit								HEATING OPERATION											
									Heating Capacity								Total	Input power		
									Room 1	Room 2	Room 3	Room 4	Room 5	Room 6	Room 7	Room 8				
4 Room	7	7	14	18	-	-	-	-	KW	KW	KW	KW	KW	KW	KW	KW	KW	KW	KW	KW
	7	7	14	14	-	-	-	-	2.37	2.37	4.80	4.80	-	-	-	-	-	-	15.40	4.75
	7	7	12	24	-	-	-	-	2.36	2.36	3.94	4.80	7.87	-	-	-	-	-	16.53	5.11
	7	7	12	18	-	-	-	-	2.37	2.37	3.96	5.86	-	-	-	-	-	-	14.56	4.46
	7	7	12	14	-	-	-	-	2.37	2.37	3.96	4.80	-	-	-	-	-	-	13.50	4.00
	7	7	9	24	-	-	-	-	2.37	2.37	2.99	7.91	-	-	-	-	-	-	15.64	4.91
	7	7	9	18	-	-	-	-	2.37	2.37	2.99	5.86	-	-	-	-	-	-	13.59	4.10
	7	7	7	24	-	-	-	-	2.37	2.37	2.37	7.91	-	-	-	-	-	-	15.02	4.60
	7	7	7	18	-	-	-	-	2.37	2.37	2.37	5.86	-	-	-	-	-	-	12.97	3.90
	12	12	12	12	14	-	-	-	3.51	3.51	3.51	3.51	4.26	-	-	-	-	-	18.32	5.98
	12	12	12	12	12	-	-	-	3.58	3.58	3.58	3.58	3.58	-	-	-	-	-	17.90	5.98
	9	12	12	14	14	-	-	-	2.66	3.52	3.52	4.27	4.27	-	-	-	-	-	18.26	5.98
	9	12	12	12	14	-	-	-	2.71	3.59	3.59	3.59	4.35	-	-	-	-	-	17.84	5.98
	9	12	12	12	12	-	-	-	2.85	3.77	3.77	3.77	3.77	-	-	-	-	-	17.95	5.87
	9	9	14	14	14	-	-	-	2.67	2.67	4.28	4.28	4.28	-	-	-	-	-	18.19	5.98
	9	9	12	14	18	-	-	-	2.66	2.66	3.52	4.26	5.21	-	-	-	-	-	18.30	5.98
	9	9	12	14	14	-	-	-	2.72	2.72	3.60	4.37	4.37	-	-	-	-	-	17.77	5.98
	9	9	12	12	18	-	-	-	2.71	2.71	3.58	3.58	5.30	-	-	-	-	-	17.88	5.98
	9	9	12	12	14	-	-	-	2.86	2.86	3.78	3.78	4.58	-	-	-	-	-	17.86	5.70
	9	9	12	12	12	-	-	-	2.89	2.89	3.83	3.83	3.83	-	-	-	-	-	17.28	5.43
	9	9	9	14	18	-	-	-	2.71	2.71	2.71	4.36	5.32	-	-	-	-	-	17.82	5.98
	9	9	9	14	14	-	-	-	2.86	2.86	2.86	4.59	4.59	-	-	-	-	-	17.77	5.56
	9	9	9	12	18	-	-	-	2.85	2.85	2.85	3.78	5.59	-	-	-	-	-	17.92	5.87
	9	9	9	12	14	-	-	-	2.90	2.90	2.90	3.84	4.65	-	-	-	-	-	17.19	5.32
	9	9	9	12	12	-	-	-	2.97	2.97	2.97	3.93	3.93	-	-	-	-	-	16.78	5.16
	9	9	9	9	24	-	-	-	2.70	2.70	2.70	2.70	7.14	-	-	-	-	-	17.94	5.98
	9	9	9	9	18	-	-	-	2.89	2.89	2.89	2.89	5.67	-	-	-	-	-	17.25	5.43
	9	9	9	9	14	-	-	-	2.97	2.97	2.97	2.97	4.77	-	-	-	-	-	16.67	5.11
	9	9	9	9	12	-	-	-	2.99	2.99	2.99	2.99	3.96	-	-	-	-	-	15.92	5.07
	9	9	9	9	9	-	-	-	2.99	2.99	2.99	2.99	2.99	-	-	-	-	-	14.95	4.60
	7	12	14	14	14	-	-	-	2.10	3.51	4.25	4.25	4.25	-	-	-	-	-	18.37	5.98
	7	12	12	14	14	-	-	-	2.14	3.57	3.57	4.33	4.33	-	-	-	-	-	17.95	5.98
	7	12	12	12	18	-	-	-	2.13	3.56	3.56	3.56	5.26	-	-	-	-	-	18.06	5.98
	7	12	12	12	14	-	-	-	2.25	3.76	3.76	3.76	4.56	-	-	-	-	-	18.10	5.87
	7	12	12	12	12	-	-	-	2.28	3.81	3.81	3.81	3.81	-	-	-	-	-	17.52	5.56
	7	9	14	14	18	-	-	-	2.09	2.64	4.24	4.24	5.18	-	-	-	-	-	18.40	5.98
7	9	14	14	14	-	-	-	2.14	2.71	4.34	4.34	4.34	-	-	-	-	-	17.88	5.98	
7	9	12	14	18	-	-	-	2.13	2.69	3.57	4.32	5.28	-	-	-	-	-	17.99	5.98	
7	9	12	14	14	-	-	-	2.26	2.85	3.77	4.57	4.57	-	-	-	-	-	18.01	5.70	
7	9	12	12	18	-	-	-	2.25	2.84	3.76	3.76	5.56	-	-	-	-	-	18.16	5.98	
7	9	12	12	14	-	-	-	2.28	2.88	3.82	3.82	4.63	-	-	-	-	-	17.43	5.43	
7	9	12	12	12	-	-	-	2.35	2.96	3.92	3.92	3.92	-	-	-	-	-	17.09	5.23	
7	9	9	18	18	-	-	-	2.13	2.69	2.69	5.27	5.27	-	-	-	-	-	18.04	5.98	
7	9	9	14	18	-	-	-	2.25	2.84	2.84	4.56	5.57	-	-	-	-	-	18.07	5.87	
7	9	9	14	14	-	-	-	2.29	2.89	2.89	4.64	4.64	-	-	-	-	-	17.34	5.32	
7	9	9	12	24	-	-	-	2.12	2.68	2.68	3.55	7.08	-	-	-	-	-	18.11	5.98	
7	9	9	12	18	-	-	-	2.28	2.88	2.88	3.81	5.64	-	-	-	-	-	17.49	5.56	
7	9	9	12	14	-	-	-	2.35	2.97	2.97	3.93	4.76	-	-	-	-	-	16.97	5.16	
7	9	9	12	12	-	-	-	2.37	2.98	2.98	3.95	3.95	-	-	-	-	-	16.24	5.08	
7	9	9	9	24	-	-	-	2.17	2.74	2.74	2.74	7.24	-	-	-	-	-	17.63	5.98	
7	9	9	9	18	-	-	-	2.35	2.96	2.96	2.96	5.81	-	-	-	-	-	17.05	5.23	
7	9	9	9	14	-	-	-	2.37	2.99	2.99	2.99	4.79	-	-	-	-	-	16.12	5.07	
7	9	9	9	12	-	-	-	2.37	2.99	2.99	2.99	3.96	-	-	-	-	-	15.30	4.75	
7	9	9	9	9	-	-	-	2.37	2.99	2.99	2.99	2.99	-	-	-	-	-	14.33	4.33	
7	7	14	14	18	-	-	-	2.12	2.12	4.30	4.30	5.25	-	-	-	-	-	18.10	5.98	
7	7	14	14	14	-	-	-	2.25	2.25	4.55	4.55	4.55	-	-	-	-	-	18.16	5.70	
7	7	12	18	18	-	-	-	2.11	2.11	3.53	5.23	5.23	-	-	-	-	-	18.21	5.98	
7	7	12	14	18	-	-	-	2.16	2.16	3.62	4.38	5.35	-	-	-	-	-	17.68	5.98	
7	7	12	14	14	-	-	-	2.28	2.28	3.80	4.61	4.61	-	-	-	-	-	17.58	5.43	
7	7	12	12	24	-	-	-	2.11	2.11	3.52	3.52	7.03	-	-	-	-	-	18.29	5.98	
7	7	12	12	14	-	-	-	2.35	2.35	3.92	3.92	4.75	-	-	-	-	-	17.28	5.23	
7	7	12	12	12	-	-	-	2.36	2.36	3.94	3.94	3.94	-	-	-	-	-	16.54	5.11	
7	7	9	18	18	-	-	-	2.16	2.16	2.72	5.34	5.34	-	-	-	-	-	17.73	5.98	
7	7	9	14	24	-	-	-	2.11	2.11	2.67	4.28	7.05	-	-	-	-	-	18.22	5.98	
7	7	9	14	18	-	-	-	2.27	2.27	2.87	4.61	5.62	-	-	-	-	-	17.64	5.56	
7	7	9	14	14	-	-	-	2.35	2.35	2.96	4.75	4.75	-	-	-	-	-	17.16	5.16	
7	7	9	12	24	-	-	-	2.15	2.15	2.72	3.60	7.18	-	-	-	-	-	17.80	5.98	
7	7	9	12	18	-	-	-	2.34	2.34	2.96	3.92	5.80	-	-	-	-	-	17.36	5.32	
7	7	9	12	14	-	-	-	2.36	2.36	2.98	3.95	4.78	-	-	-	-	-	16.43	5.08	
7	7	9	12	12	-	-	-	2.37	2.37	2.99	3.96	3.96	-	-	-	-	-	15.65	4.91	
7	7	9	9	24	-	-	-	2.27	2.27	2.86	2.86	7.56	-	-	-	-	-	17.81	5.70	
7	7	9	9	18	-	-	-	2.36	2.36	2.98	2.98	5.83	-	-	-	-	-	16.51	5.11	
7	7	9	9	14	-	-	-	2.37	2.37	2.99	2.99	4.80	-	-	-	-	-	15.52	4.75	
7	7	9	9	12	-	-	-	2.37	2.37	2.99	2.99	3.96	-	-	-	-	-	14.68	4.46	
7	7	9	9	9	-	-	-	2.37	2.37	2.99	2.99	2.99	-	-	-	-	-	13.71	4.10	
7	7	7	18	18	-	-	-	2.26	2.26	2.26	5.58	5.58	-	-	-	-	-	17.95	5.87	
7	7	7	14	24	-	-	-	2.14	2.14	2.14	4.34	7.15	-	-	-	-	-	17.91	5.98	
7	7	7	14	18	-	-	-	2.30	2.30	2.30	4.65	5.68	-	-	-	-	-	17.22	5.32	
7	7	7	14	14	-	-	-	2.36	2.36	2.36	4.77	4.77	-	-	-	-	-	16.62	5.08	
7	7	7	12	24	-	-	-	2.25	2.25	2.25	3.77	7.52	-	-	-	-	-	18.05	5.87	
7	7	7	12	18	-	-	-	2.35	2.35	2.35	3.93	5.82	-	-	-	-	-	16.81	5.16	
7	7	7	12	14	-	-	-	2.37	2.37	2.37	3.96	4.80	-	-	-	-	-	15.87	4.91	
7	7	7	12	12	-	-	-	2.37	2.37	2.37	3.96	3.96	-	-	-	-	-	15.03		

Model : AOYG36LATT [3phase]  
 AOYG45LATT [3phase]  
 AOYG54LATT [3phase]



Features

Can support various installation scenes from office to commercial space by same place multi connection of up to 3 units.

Indoor units distributed layout according to the shape and number of people and lighting conditions of the room even on wide floors and atypical floors. Ideal comfortable air flow distribution can be realized.

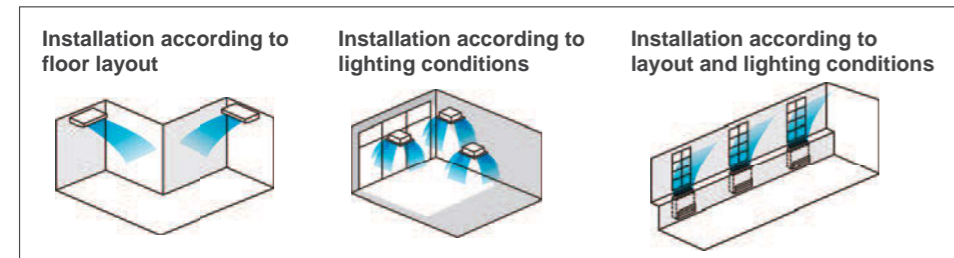

Simultaneous Operation Multi type Indoor Unit Line up

	Twin			Triple
	18x2	22x2	24x2	18x3
Cassette	AUYG18LVx2 	AUYG22LVx2 	AUYG24LVx2 	AUYG18LVx3 
Duct	ARYG18LLx2 	ARYG22LMx2 	ARYG24LMx2 	ARYG18LLx3 
Ceiling	ABYG18LVx2 	ABYG22LVx2 	ABYG24LVx2 	ABYG18LVx3 
Outdoor unit	AOYG36LATT 	AOYG45LATT 	AOYG54LATT 	

Note: Combinations other than the above are not available.

Features

Simultaneous control

Max 16 indoor units are simultaneously controlled with a wired remote controller.

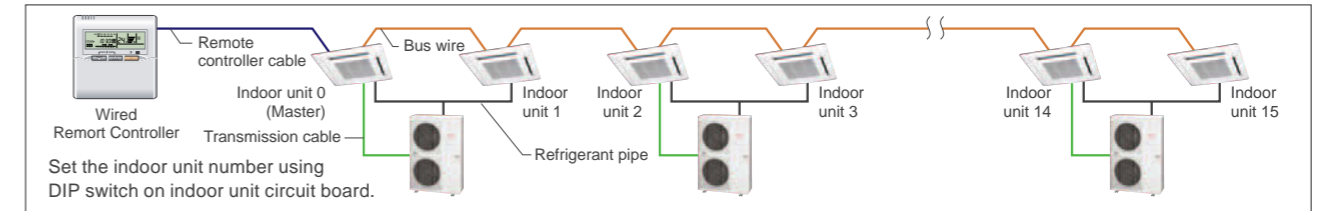

Specifications

Model No.	Indoor unit	Compact Cassette		
		AUYG18LVLB	AUYG22LVLA	AUYG24LVLA
Power Source	V/Ø/Hz	230/1/50	230/1/50	230/1/50
Air Flow (High)	Cooling H/M/L/Q m³/h	680/580/490/410	930/830/600/450	930/830/600/450
Net Dimension H x W x D	mm	245x570x570	245x570x570	245x570x570
Weight	kg(lbs)	15 (33)	16 (35)	16 (35)
Cassette Grille		UTG-UFYD-W	UTG-UFYD-W	UTG-UFYD-W

Model No.	Indoor unit	Duct			Floor/Ceiling Universal		
		ARYG18LLTB	ARYG22LMLA	ARYG24LMLA	ABYG18LVTB	ABYG22LVTA	ABYG24LVTA
Power Source	V/Ø/Hz	230/1/50	230/1/50	230/1/50	230/1/50	230/1/50	
Air Flow (High)	Cooling H/M/L/Q m³/h	940/880/820/750	1100/910/750/580	780/700/560/500	980/820/680/540	980/820/680/540	
Net Dimension H x W x D	mm	198 x 900 x 620	270 x 1135 x 700	199 x 990 x 655	199 x 990 x 655	199 x 990 x 655	
Weight	kg(lbs)	23 (51)	38 (84)	27 (60)	27 (60)	27 (60)	

Model No.	Outdoor unit	AOYG36LATT			AOYG45LATT			AOYG54LATT					
		Capacity	Cooling	kW			10.0			12.5			14.0
	Heating	kW			11.2			14.5			16.0		
Power source	V/Ø/Hz	400/3/50			400/3/50			400/3/50					
Pdesign	Cooling	kW			10.0			-			-		
	Heating (@-10°C)	kW			10.0			-			-		
SEER	Cooling	W/W			6.00			-			-		
SCOP	Heating	W/W			4.00			-			-		
Annual Energy Consumption	Cooling	kWh/a			583			-			-		
	Heating	kWh/a			3499			-			-		
Energy Efficiency Class	Cooling	A+			-			-			-		
	Heating	A+			-			-			-		
Sound Pressure (High)	Cooling	dB(A)			51			54			55		
	Heating	dB(A)			67			-			-		
Net Dimension H x W x D	mm	1290x900x330			1290x900x330			1290x900x330					
Weight	kg(lbs)	104 (229)			104 (229)			104 (229)					
Piping Connections (Small / Large)	mm	9.52/15.88			9.52/15.88			9.52/15.88					
Max Pipe Length (Pre-Charge)	m	75(30)			75(30)			75(30)					
Height Difference	m	30			30			30					
Operation Range	Cooling	°CDB			-15 to 46			-15 to 46			-15 to 46		
	Heating	°CDB			-15 to 24			-15 to 24			-15 to 24		
Refrigerant		R410A			R410A			R410A					
Separation tube		UTP-SX236A (Twin)			UTP-SX254A (Twin)			UTP-SX254A (Twin) / UTP-SX354A (Triple)					

\*Different type and capacity indoor units can not be connected.

Dimensions

(Unit : mm)

Outdoor Unit : AOYG36LATT / AOYG45LATT / AOYG54LATT

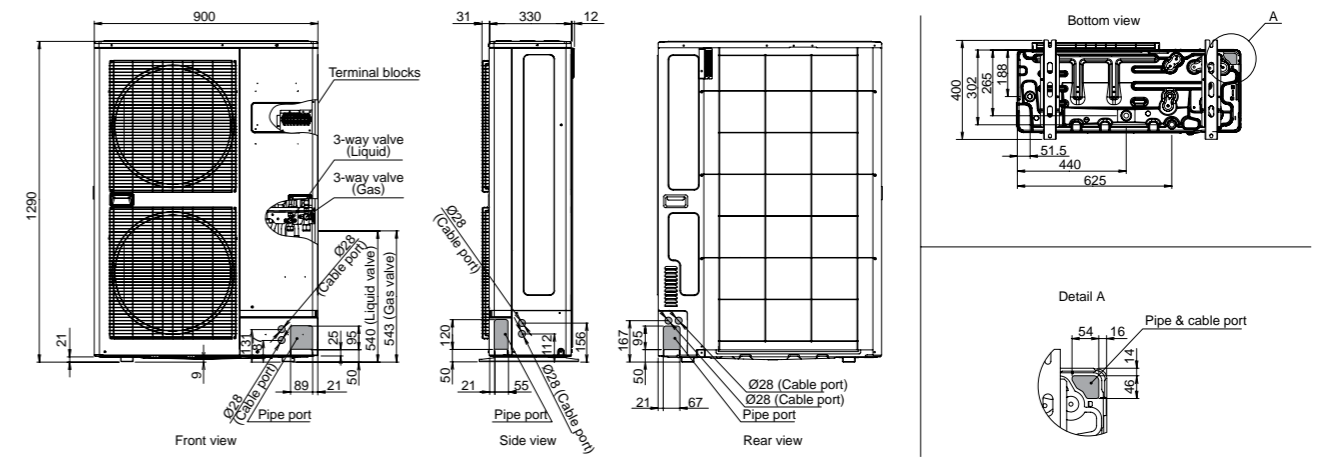

Optional Parts List

Type	Wall Mounted						Duct						Cassette		Floor	Floor/Ceiling	Ceiling					
	Compact			Large			Slim	Medium static	High static	Compact		Large										
	ASYG 09/12 LTCA	ASYG 07/09/12/14 LUCA	ASYG 07/09/12/14 LMCA	ASYG 07/09/12 LLCC	ASYG 18/FCA/24/FCC	ASYG 30/LFCA				ARYG 07/09/12/14 LLTA	ARYG 18/LLTB		ARYG 22/24/36/45/LMLA/30/36 LMLE	ARYG 45/54 LHTA				ARYG60 LHTA	ARYC 72/LHTA/90/LHTA	AUYG 07/09/12/14/18 LVLB	AUYG 22/24 LVLA	AUYG 30/36 LRL/36/45/54 LRLA
Controllers	Wired Remote Controller		UTY-RVNYM			UTY-RVNYM			UTY-RVNYM			UTY-RVNYM		UTY-RVNYM	UTY-RVNYM	UTY-RVNYM	UTY-RVNYM	UTY-RVNYM	UTY-RVNYM	UTY-RVNYM	UTY-RVNYM	
	Simple Remote Controller		UTY-RNNYM			UTY-RNNYM			UTY-RNNYM			UTY-RNNYM		UTY-RNNYM	UTY-RNNYM	UTY-RNNYM	UTY-RNNYM	UTY-RNNYM	UTY-RNNYM	UTY-RNNYM	UTY-RNNYM	
	Central Remote Controller		UTY-RSNYM			UTY-RSNYM			UTY-RSNYM			UTY-RSNYM		UTY-RSNYM	UTY-RSNYM	UTY-RSNYM	UTY-RSNYM	UTY-RSNYM	UTY-RSNYM	UTY-RSNYM	UTY-RSNYM	
Others	IR Receiver Kit with Wireless Remote Controller		UTY-DMMYM			UTY-DMMYM			UTY-DMMYM			UTY-DMMYM		UTY-DMMYM	UTY-DMMYM	UTY-DMMYM	UTY-DMMYM	UTY-DMMYM	UTY-DMMYM	UTY-DMMYM	UTY-DMMYM	
	Remote Sensor Unit		UTY-LRHYM			UTY-LRHYM			UTY-LRHYM			UTY-LRHYM		UTY-LRHYM	UTY-LRHYM	UTY-LRHYM	UTY-LRHYM	UTY-LRHYM	UTY-LRHYM	UTY-LRHYM	UTY-LRHYM	
	Auto Louver Grille Kit		UTD-GXSA			UTD-GXSB			UTD-GXSA			UTD-GXSB		UTD-GXSA	UTD-GXSB	UTD-GXSA	UTD-GXSB	UTD-GXSA	UTD-GXSB	UTD-GXSA	UTD-GXSB	
	Long Life Filter		UTD-LF25NA			UTD-LF60KA			UTD-LF25NA			UTD-LF60KA		UTD-LF25NA	UTD-LF60KA	UTD-LF25NA	UTD-LF60KA	UTD-LF25NA	UTD-LF60KA	UTD-LF25NA	UTD-LF60KA	UTD-LF25NA
	Flange		UTD-RF204 / SF045T			UTD-RF204 / SF045T			UTD-RF204 / SF045T			UTD-RF204 / SF045T		UTD-RF204 / SF045T	UTD-RF204 / SF045T	UTD-RF204 / SF045T	UTD-RF204 / SF045T	UTD-RF204 / SF045T	UTD-RF204 / SF045T	UTD-RF204 / SF045T	UTD-RF204 / SF045T	UTD-RF204 / SF045T
	Drain Pump Unit		UTZ-PX1NBA			UTZ-PX1NBA			UTZ-PX1NBA			UTZ-PX1NBA		UTZ-PX1NBA	UTZ-PX1NBA	UTZ-PX1NBA	UTZ-PX1NBA	UTZ-PX1NBA	UTZ-PX1NBA	UTZ-PX1NBA	UTZ-PX1NBA	UTZ-PX1NBA
	Wide Panel		UTG-AGYA-W			UTG-AGYA-W			UTG-AGYA-W			UTG-AGYA-W		UTG-AGYA-W	UTG-AGYA-W	UTG-AGYA-W	UTG-AGYA-W	UTG-AGYA-W	UTG-AGYA-W	UTG-AGYA-W	UTG-AGYA-W	UTG-AGYA-W
	Panel Spacer		UTG-BGYA-W			UTG-BGYA-W			UTG-BGYA-W			UTG-BGYA-W		UTG-BGYA-W	UTG-BGYA-W	UTG-BGYA-W	UTG-BGYA-W	UTG-BGYA-W	UTG-BGYA-W	UTG-BGYA-W	UTG-BGYA-W	UTG-BGYA-W
	Fresh Air Intake Kit		UTZ-VXAA			UTZ-VXGA			UTZ-VXAA			UTZ-VXGA		UTZ-VXAA	UTZ-VXGA	UTZ-VXAA	UTZ-VXGA	UTZ-VXAA	UTZ-VXGA	UTZ-VXAA	UTZ-VXGA	UTZ-VXAA
	Air Outlet Shutter Plate		UTR-YDZB			UTR-YDZC			UTR-YDZB			UTR-YDZC		UTR-YDZB	UTR-YDZC	UTR-YDZB	UTR-YDZC	UTR-YDZB	UTR-YDZC	UTR-YDZB	UTR-YDZC	UTR-YDZB
Insulation for High Humidity		UTZ-KXGC			UTZ-KXGA			UTZ-KXGC			UTZ-KXGA		UTZ-KXGC	UTZ-KXGA	UTZ-KXGC	UTZ-KXGA	UTZ-KXGC	UTZ-KXGA	UTZ-KXGC	UTZ-KXGA	UTZ-KXGC	
Half Concealed Kit		UTR-STA			UTR-STA			UTR-STA			UTR-STA		UTR-STA	UTR-STA	UTR-STA	UTR-STA	UTR-STA	UTR-STA	UTR-STA	UTR-STA	UTR-STA	
Remote controller holder		UTZ-RXLA			UTZ-RXLA			UTZ-RXLA			UTZ-RXLA		UTZ-RXLA	UTZ-RXLA	UTZ-RXLA	UTZ-RXLA	UTZ-RXLA	UTZ-RXLA	UTZ-RXLA	UTZ-RXLA	UTZ-RXLA	

Optional parts list (Communication devices)

Type	Indoor Unit													Outdoor Unit							
	Wall Mounted			Duct			Cassette		Floor	Floor/Ceiling	Ceiling	Single-phase		3-phase							
	Compact		Large	Slim	Medium static	High static	Compact	Large				Single Split	Single Split	Simultaneous Multi							
Wireless LAN Interface	ASYG 09/12 LTCA		ASYG 07/09/12/14 LUCA						ASYG 07/09/12/14 LMCA	ASYG 18/FCA/24/FCC/30/LFCA	ARYG 07/09/12/14/18 LLTA/18/LLTB				ARYG 22/24/36/45/LMLA/30/36 LMLE	ARYG 45/54/60 LHTA	ARYC 72/LHTA/90/LHTA	AUYG 07/09/12/14/18 LVLB	AUYG 22/24 LVLA	AUYG 30/36 LRL/36/45/54 LRLA	AGYG 09/12/14 LVCA
KNX® Interface	FJ-RC-KNX-1i																				
MODBUS® Interface	FJ-RC-MBS-1																				
Communication Kit	UTY-TWBYF		UTY-XCBXZ2																		
External Connect Kit	UTY-XWZX5			UTY-XWZX		UTY-XWZX		UTY-XWZX		UTY-XWZX		UTY-XWZX		UTY-XWZX		UTY-XWZX		UTY-XWZX		UTY-XWZX	
External Control Set	UTD-EC55A			UTD-EC55A		UTD-EC55A															

Refrigerant Piping Parts

**Connection Units**

**Separation Tube**  
UTP-SX236A / UTP-SX254A  
For 3-phase simultaneous multi

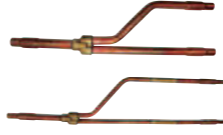

UTP-SX354A  
For 3-phase simultaneous multi



UTP-SX248A  
For 8 Rooms Multi

Liquid pipe

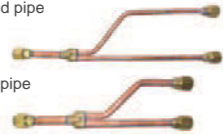

Gas pipe

**Branch Box**  
UTP-PY03A / UTP-PY02A  
For 8 Rooms Multi



3 zones type



2 zones type

Max. controllable  
**16**  
Indoor units

### Wired Remote Controller : UTY-RVNYM

Hi-grade individual control using various functions.

- 3.7-inch LCD backlight screen.
- Supporting various Energy Saving functions with simple operation.
- Multiple Language Support.  
(English, German, French, Spanish, Russian, Portuguese, Italian, Greek, and Turkish)



### High performance and compact size

• In addition to the individual control, various energy saving controls can be realized using only one remote controller.

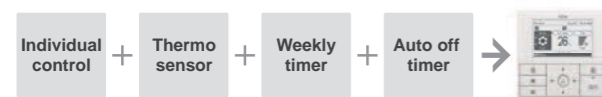

### Various energy saving function

#### Auto OFF Timer

- The indoor unit automatically is turned off when it reaches the preset operating time frame.
- The time frame of the "Auto off timer" can be flexibly scheduled.
- Can be set off time 30 to 240 minutes

### Weekly Timer function

- Can be set up to 8 times per day (On/Off, mode, Temp)
- 2 pattern settings (i.e. Summer/Winter setting) are available.

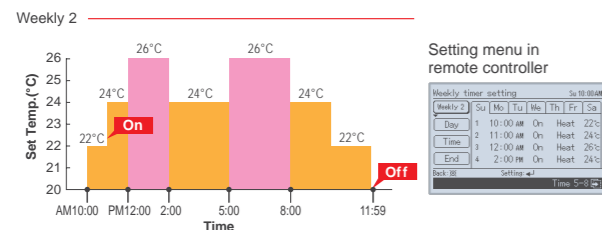
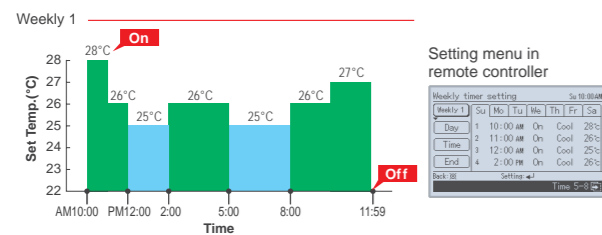

### Specifications

Model name	UTY-RVNYM
Power supply	DC 12 V
Dimension (H x W x D) (mm)	120 x 120 x 21.3
Weight (g)	220

\* DC12 V is supplied by indoor unit.

### High visibility and Easy operation

- Icon display of effectual functions.
- Main functions in large icons: "Mode", "Set Temp", and "Fan".
- Easy to operate by Control guide display.
- Simple operation with easy 4-way navigation pad.

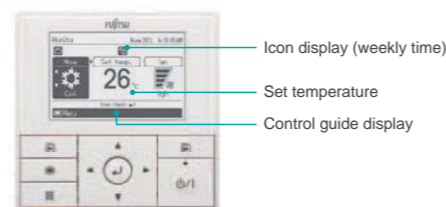

### Set Temperature Auto Return

- The setting temperature automatically returns to the previously set temperature.
- The time range in which the set temperature can be changed is 30 to 120 minutes.

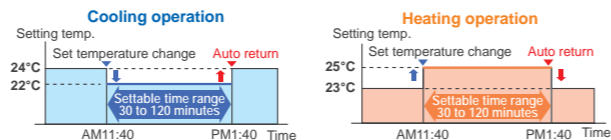

### Set Temperature Upper and Lower Limit Setting

- The set temperature range can be set for each operation mode. (Cooling / Heating / Auto)

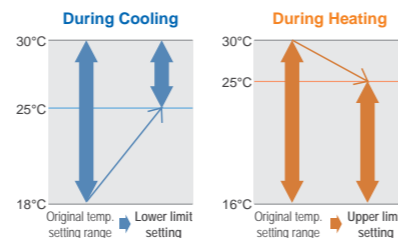

### Auto Louver Grille Kit : UTD-GXSA-W / UTD-GXSB-W / UTD-GXSC-W

Simple flat Auto Louver will provide comfort airflow and harmonize with luxury interior.



### Flexible Control

- **Operation with indoor unit**  
Auto Louver can be operated by synchronizing remote controller of indoor unit.
- **UP and Down auto swing**  
• Auto airflow direction and auto swing  
• 4 steps selectable
- **Auto-closing louver**  
When operation of indoor unit is stopped, the louver will automatically close.

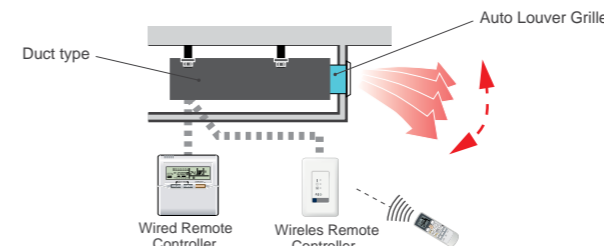

### Dimensions

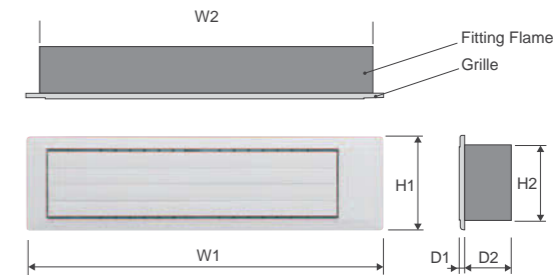

Model Name	W1	W2	H1	H2	D1	D2
UTD-GXSA-W	683	645	180	148	9	84
UTD-GXSB-W	883	845				
UTD-GXSC-W	1,083	1,045				

Unit: mm

### Specifications

Model name	UTD-GXSA-W	UTD-GXSB-W	UTD-GXSC-W
Applicable Indoor Unit	ARYG07/09LLTA ARYG12/14LLTB ARXD04/07/09/12/14GALH (For VRF)	ARYG18LLTB ARXD18GALH (For VRF)	ARXD24GALH (For VRF)
Power Supply	Connecting with Control box of indoor unit		
Fixing of Auto Louver Grille	Screw fixing to Flange or Square Duct		
Extension Square Duct Limit	1.0m (Max. duct length between indoor unit and Grille)		
Net Dimension (H x W x D)	mm (inch) 180x683x(84+9) [7-3/32x26-7/8x(3-5/16+11/32)]	180x883x(84+9) [7-3/32x34-3/4x(3-5/16+11/32)]	180x1083x(84+9) [7-3/32x42-5/8x(3-5/16+11/32)]
Weight	Net	2.0 (4.4)	2.5 (5.6)
	Gross	3.0 (6.7)	3.5 (7.8)
Color	White		
Louver Motor	Stepping Motor		
Accessories	Fitting Flame, etc.		
Operation range	Cooling	°C (°F) 18 to 32 (64 to 90)	80% or less
	Heating	°C (°F) 16 to 30 (60 to 88)	



**Wireless LAN Interface : FJ-RC-WIFI-1**



- It is the most advanced solution to remotely manage an Air Conditioning system using all sort of mobile devices such as Smartphones, Tablets and PC
- No separate external power supply required
- Can be used for single indoor units and group controlled (up to 16) indoor units

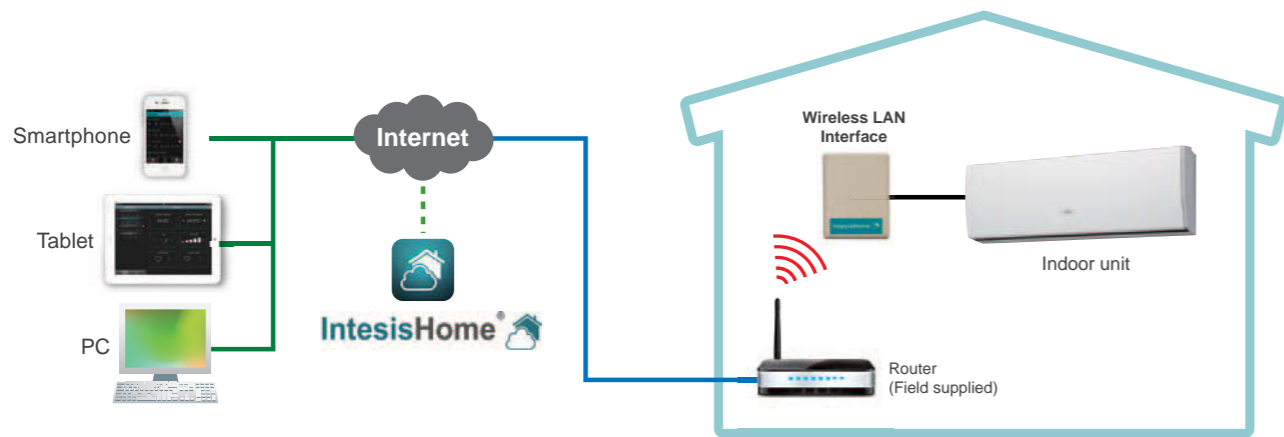

**Basic control**

- Turning the units on and off
- Mode control (Heat, Cool, Dry, Auto, Fan)
- Fan speed setting
- Louver position (Airflow direction setting)
- Room temperature display
- Set temperature control
- Multi Language
- One Scene and Timer



(Application screen image)



**Advanced control (Optional functions)**

- Climate working modes (ECO, Comfort, Powerful) (future release)
- Schedulable functionalities (ON/OFF, Modes, Set point temperature, Fan Speed, Louver position)
- Set temperature limitation (future release)
- Multiple Scenes & Timers and Calendar function

**Notifications and history**

- Alerts e-mail notification (future release)
- Air conditioning malfunction alerts
- Connectivity monitoring and alerts
- History (future release)

**Specifications**

Model name	FJ-RC-WIFI-1
Dimensions (H x W x D) (mm)	70x108x28
Weight (g)	80

**KNX® Interface : FJ-RC-KNX-1i**



The KNX Interface allows a complete integration of air conditioners with KNX Network systems.

- Simple installation due to small and compact size.
- No separate external power supply required (just KNX bus power).
- Can be used for single indoor units and group controlled (up to 16) indoor units.

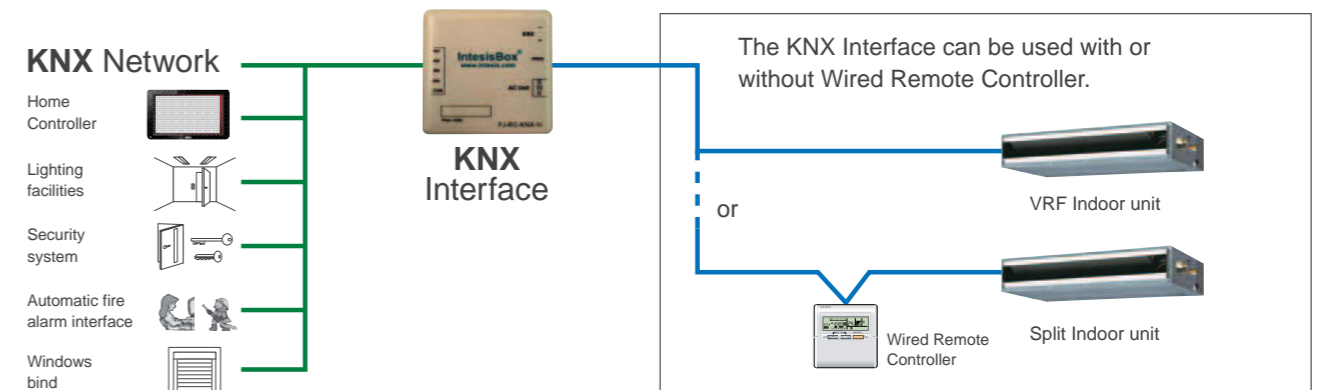

**MODBUS® Interface : FJ-RC-MBS-1**



The MODBUS Interface allows a complete integration of air conditioners into MODBUS Networks.

- Simple installation due to small and compact size.
- No separate external power supply required.
- The Modbus Interface permits central monitoring and control of air conditioners from BMS.

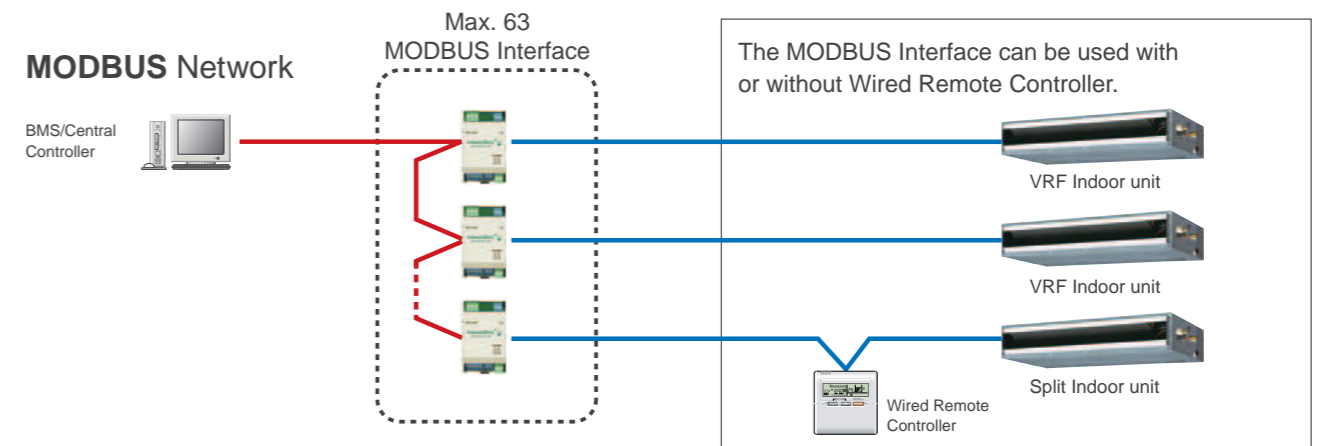





**Specifications**

Model name	FJ-RC-MBS-1	FJ-RC-KNX-1i
Dimensions (H x W x D) (mm)	93x53x58	70x70x28
Weight (g)	85	70



Controllers

For Individual & Centralized Control



<b>Wired Remote Controller</b> UTY-RVNYM 	<b>Wired Remote Controller</b> UTY-RNNYM 	<b>Simple Remote Controller</b> UTY-RSNYM 	<b>Central Remote Controller</b> UTY-DMMYM For 8 Rooms Multi 
--	--	--	---

Communication devices

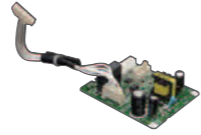
Interface

<b>Wireless LAN Interface</b> FJ-RC-WIFI-1 	<b>KNX® Interface</b> FJ-RC-KNX-1i 	<b>MODBUS® Interface</b> FJ-RC-MBS-1 	<b>Communication Kit</b> UTY-TWBXF / UTY-XCBXZ2 For Compact Wall Mounted type 
--	--	---	--

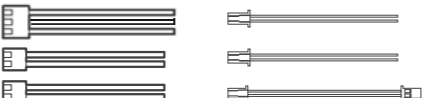
External Connect Kit / External Control set

<b>External Connect Kit</b> For Indoor Unit  <p>UTY-XWZX      UTY-XWZXZ5</p>	<b>External Control Set</b> For Indoor Unit  <p>UTD-ECS5A</p>
<b>External Connect Kit</b> For Outdoor unit  <p>UTY-XWZXZ2      UTY-XWZXZ3      UTY-XWZXZ4</p>	

Function list

		For Indoor unit			For Outdoor unit		
		UTY-XWZX	UTY-XWZXZ5	UTD-ECS5A	UTY-XWZXZ2	UTY-XWZXZ3	UTY-XWZXZ4
Input	Control	●	●	●	—	—	—
	Peak cut	—	—	—	●	●	—
	Low noise	—	—	—	●	●	—
	Priority	—	—	—	—	●	—
	Emergency stop	—	—	—	—	●	—
Output	Operation status	●	●	●	●	●	—
	Error status	—	●	●*1	●	●	—
	Fresh air control	—	—	●*2	—	—	—
	Auxiliary heater	—	—	●*3	—	—	—
	Preparation	—	—	●*4	—	—	—
	Base heater	—	—	—	—	—	●







\* 1 : This function has been had only wall mounted model such as LT, LU, and LM.  
 \* 2 : This function has been had only ducted model, cassette model, and ceiling mode.  
 \* 3 : This function has been had only ducted model.  
 \* 4 : This cable is necessary for some ducted model.

Others

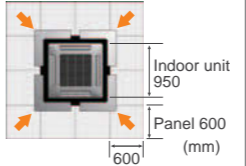

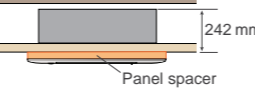
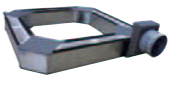
For Duct type

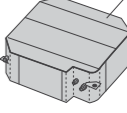
<b>Remote Sensor Unit</b> UTY-XSZX New amenity space can be offered by installing the Remote sensor. 	<b>IR Receiver Kit</b> UTY-LRHYM 	<b>Auto Louver Grille Kit</b> UTD-GXSA-W For 07 / 09 / 12 / 14 type UTD-GXSB-W For 18 type 	<b>Long-Life Filter</b> UTD-LF60KA UTD-LF25NA  <p>UTD-LF60KA      UTD-LF25NA</p>
<b>Flange</b> UTD-RF204 (Round) UTD-SF045T (Square)  <p>(Round)      (Square)</p>	<b>Drain Pump Unit</b> UTZ-PX1NBA For Medium Static Pressure Duct 		

For Cassette type

<b>IR Receiver Kit</b> UTY-LRHYA2 	<b>Wide Panel</b> UTG-AGYA-W  <p>Indoor unit 950 Panel 600 (mm) 600</p>	<b>Cassette Grille</b> UTG-UFYD-W For Compact Cassette type 	<b>Cassette Grille</b> UTG-UGYA-W 
<b>Panel Spacer</b> UTG-BGYA-W  <p>242 mm Panel spacer</p>	<b>Fresh Air Intake Kit</b> UTZ-VXAA For Compact Cassette type 	<b>Fresh Air Intake Kit</b> UTZ-VXGA 	<b>Insulation Kit For High Humidity</b> UTZ-KXGA / UTZ-KXGC For Compact Cassette type / Cassette type Insulation Kit 
<b>Air Outlet Shutter Plate</b> UTR-YDZB For Compact Cassette type Shuts the air outlet when only using as 3 blow out. 	<b>Air Outlet Shutter Plate</b> UTR-YDZC Shuts the air outlet when only using as 3 blow out. 		

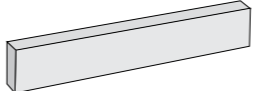
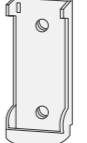
For Floor type

<b>Half Concealed Kit</b> UTR-STA This kit is used to half conceal floor type indoor unit into the wall. 	<b>Remote Controller Holder</b> UTZ-RXLA For ASYG07 / 09 / 12LLCC 	<b>Drain Pump Unit</b> UTR-DPB24T 	<b>Service Monitoring Tool</b> UTY-ASSX 
---	--	---	---

AIRSTAGE™ VRF Systems can be designed to create an air conditioning solution to suit most buildings requirements.

# VRF



AIRSTAGE™ VRF Systems can be designed to effectively provide an air conditioning solution from a large domestic residence through to a large scale commercial building.



118	All Type Lineup
120	AIRSTAGE™ Outline
122	AIRSTAGE™ series Common Features
129	AIRSTAGE™ Outdoor Units
	• AIRSTAGE™ VR-II Heat recovery type
	• AIRSTAGE™ V-III Heat pump type
	• AIRSTAGE™ V-II Heat pump type
	• AIRSTAGE™ J-II Heat pump type
	• AIRSTAGE™ J-IIS Heat pump type
158	AIRSTAGE™ Indoor Units
164	Controller
178	Adaptor & Converter
184	Service & Maintenance
186	VENTILATION
194	Optional Parts for VRF

# ALL TYPE LINEUP

## OUTDOOR UNITS Refrigerant for all models is R410A.

Capacity (kW)	12.1	14.0	15.1-15.5	22.4	28.0	33.5	40.0	45.0	50.4	55.9	61.5	67.0	73.5	78.5	85.0	90.0	95.0	100.5	107.0	112.0	118.5	123.5	130.0	135.0	140.0	145.0	150.0	
HP	4	5	6	8	10	12	14	16	18	20	22	24	26	28	30	32	34	36	38	40	42	44	46	48	50	52	54	
VR-II series Heat Recovery	Space saving Page 130 ~																											
	Set Model			AJYA72GALH	AJYA90GALH	AJY108GALH	AJY126GALH	AJY144GALH	AJY162GALH	AJY180GALH	AJY198GALH	AJY216GALH	AJY234GALH	AJY252GALH	AJY270GALH	AJY288GALH	AJY306GALH	AJY324GALH	AJY342GALH	AJY360GALH	AJY378GALH	AJY396GALH	AJY414GALH	AJY432GALH				
VR-II series Heat Pump	Space saving Page 138 ~																											
	Set Model			AJY072LALBH	AJY090LALBH	AJY108LALBH	AJY126LALBH	AJY144LALBH	AJY162LALBH	AJY180LALBH	AJY198LALBH	AJY216LALBH	AJY234LALBH	AJY252LALBH	AJY270LALBH	AJY288LALBH	AJY306LALBH	AJY324LALBH	AJY342LALBH	AJY360LALBH	AJY378LALBH	AJY396LALBH	AJY414LALBH	AJY432LALBH	AJY450LALBH	AJY468LALBH	AJY486LALBH	
VR-III series Heat Pump	Space saving Page 144 ~																											
	Set Model			AJYA72LALH	AJYA90LALH	AJY108LALH	AJY126LALH	AJY144LALH	AJY162LALH	AJY180LALH	AJY198LALH	AJY216LALH	AJY234LALH	AJY252LALH	AJY270LALH	AJY288LALH	AJY306LALH	AJY324LALH	AJY342LALH	AJY360LALH	AJY378LALH	AJY396LALH	AJY414LALH	AJY432LALH				
V-II series Heat Pump	Space saving Page 144 ~																											
	Set Model	AJYA40LALH	AJYA45LALH	AJYA54LALH																								
J-II series Heat Pump	Space saving Page 150 ~																											
	Set Model	AJYA40LALH	AJYA45LALH	AJYA54LALH																								
J-IIS series Heat Pump	Space saving Page 154 ~																											
	Set Model	AJY040LCLAH	AJY045LCLAH	AJY054LCLAH																								

## INDOOR UNITS & VENTILATIONS Page 158 ~



Capacity range 1.1 kW to 25.0 kW (J-II can be connected up to 14.0 kW.)

Compact Cassette

Cassette

Low Static Pressure Duct

Slim Duct (With drain pump)

Medium Static Pressure Duct

High Static Pressure Duct

Floor / Ceiling

Ceiling

Wall Mounted (EEV internal / EEV external)

Wall Mounted

VENTILATIONS  
Page 186 ~  
Energy Recovery Ventilator/5 models

Outdoor Air Unit/3 models

## VARIOUS EASY-TO-USE CONTROLLERS Page 164 ~

User's needs are supported by offering a variety of controls, such as individual control, central control, and building management control options.

Wireless Remote Controller

Simple Remote Controller

Wired Remote Controller

Wired Remote Controller (Touch Panel)

Group Remote Controller

Central Remote Controller

Touch Panel Controller

System Controller System Controller Lite (Software)



# AIRSTAGE™ SERIES OUTLINE

Fujitsu General provides multi air conditioning systems for buildings AIRSTAGE™ series matched to the size and application of the property

## AIRSTAGE™ series Common Features

- 120 Highly Energy Efficiency
- 123 Energy Saving Function
- 123 More Comfort
- 124 Design Flexibility
- 126 High Reliability
- 127 Easy Installation
- 128 Easy Service & Maintenance

## Systems for Large offices, Hotels, and Large Composite Facilities

Heat Recovery Modular type for simultaneous heating and cooling operation

8HP-48HP 34 Models

- Space saving combination: 8HP to 48HP / 21 models
- Energy efficiency combination: 16HP to 44HP / 13 models

**AIRSTAGE™ VR-II**



Page 130

Page 138



NEW

Heat Pump Modular type for heating or cooling operation

8HP-54HP 39 Models

- Space saving combination: 8HP to 54HP / 24 models
- Energy efficiency combination: 16HP to 46HP / 15 models

**AIRSTAGE™ V-III**

Page 144



Heat Pump Modular type for heating or cooling operation

8HP-48HP 33 Models

- Space saving combination: 8HP to 48HP / 21 models
- Energy efficiency combination: 16HP to 44HP / 12 models

**AIRSTAGE™ V-II**

## Systems for Large Homes to Medium sized Offices, Shops

Heat Pump type for heating or cooling operation

4HP, 5HP, 6HP 3 Models

**AIRSTAGE™ J-II**



Page 150

Page 154



4HP, 5HP, 6HP 3 Models

**AIRSTAGE™ J-IIS**

# High Energy Efficiency

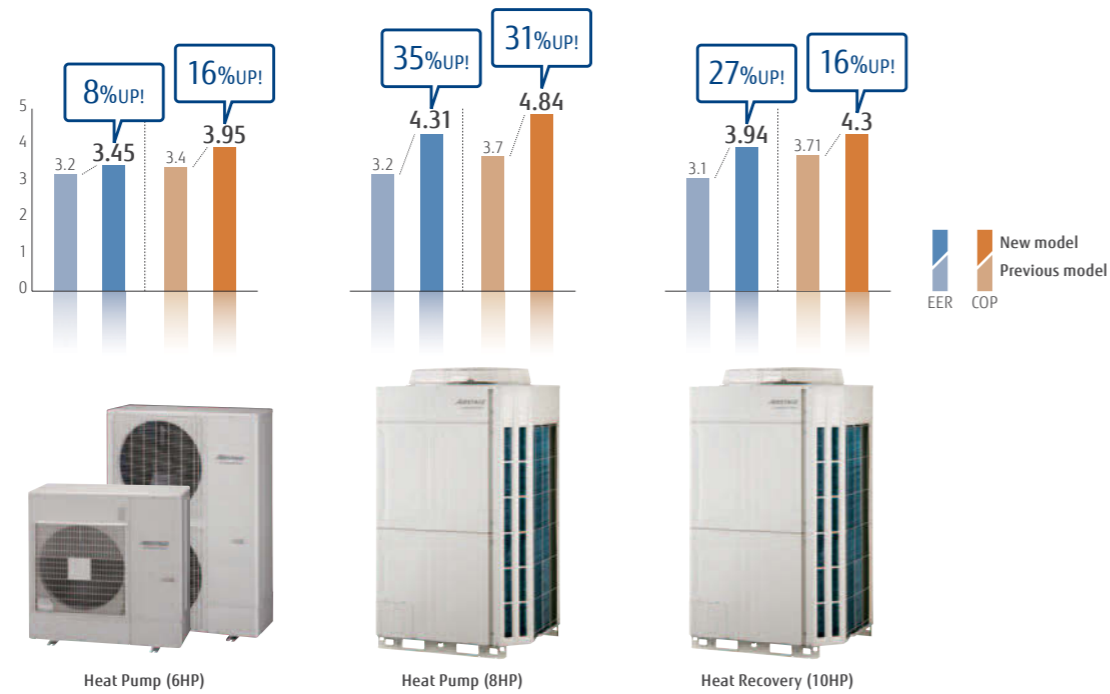

Efficiency is improved significantly by using DC twin rotary compressor, inverter technology, and large heat exchanger

# Energy Saving Function

## Economy operation

Economy operation can be set by remote controller. The temperature setting is offset automatically over a certain period of time.

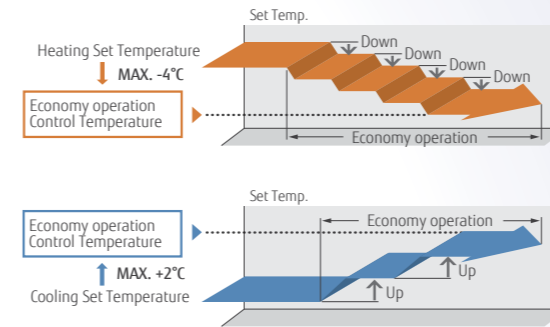

## Room temperature set point limitation

The minimum and maximum temperature ranges can be limited, which provide further energy saving while maintaining the comfort of the occupants.

## Auto-off timer

- The indoor unit automatically is turned off when it reaches to the preset operating time frame.
- The time frame of the "Auto off timer" can be flexibly scheduled.

## Capacity save operation

Operation capacity can be set in 5 steps for rated capability. The power consumption at peak is cut down and the maximum load is suppressed.

# More Comfort

## Precision refrigerant flow control

Precise and smooth refrigerant flow control is achieved by using a DC Inverter control in conjunction with individual indoor unit electronic expansion valve control. This allows high precision comfortable temperature control of  $\pm 0.5^{\circ}\text{C}$ .

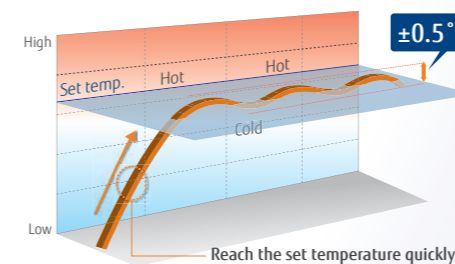

## Quiet operation

Two low noise modes can be selected automatically by quiet priority setting and capacity priority setting depending on the indoor environment and outside temperature load. This feature can be controlled via outdoor unit external input and/or system controller.

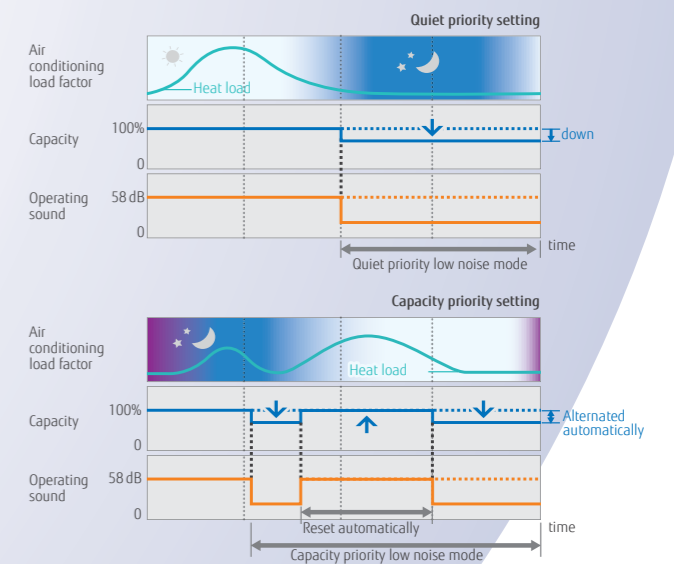

## Auto changeover function

At Auto setting, the cooling/heating mode is automatically switched according to the set temperature and room temperature.

Suitable for especially Heat Recovery type

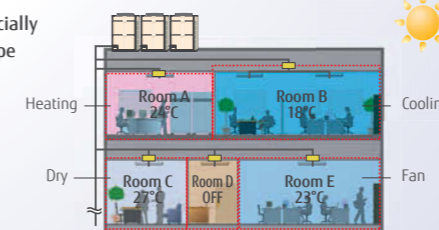

# Design Flexibility

## Overall piping length Max. 1,000 m

World's top class overall piping length of 1,000 m allows for application in a wide variety of buildings.

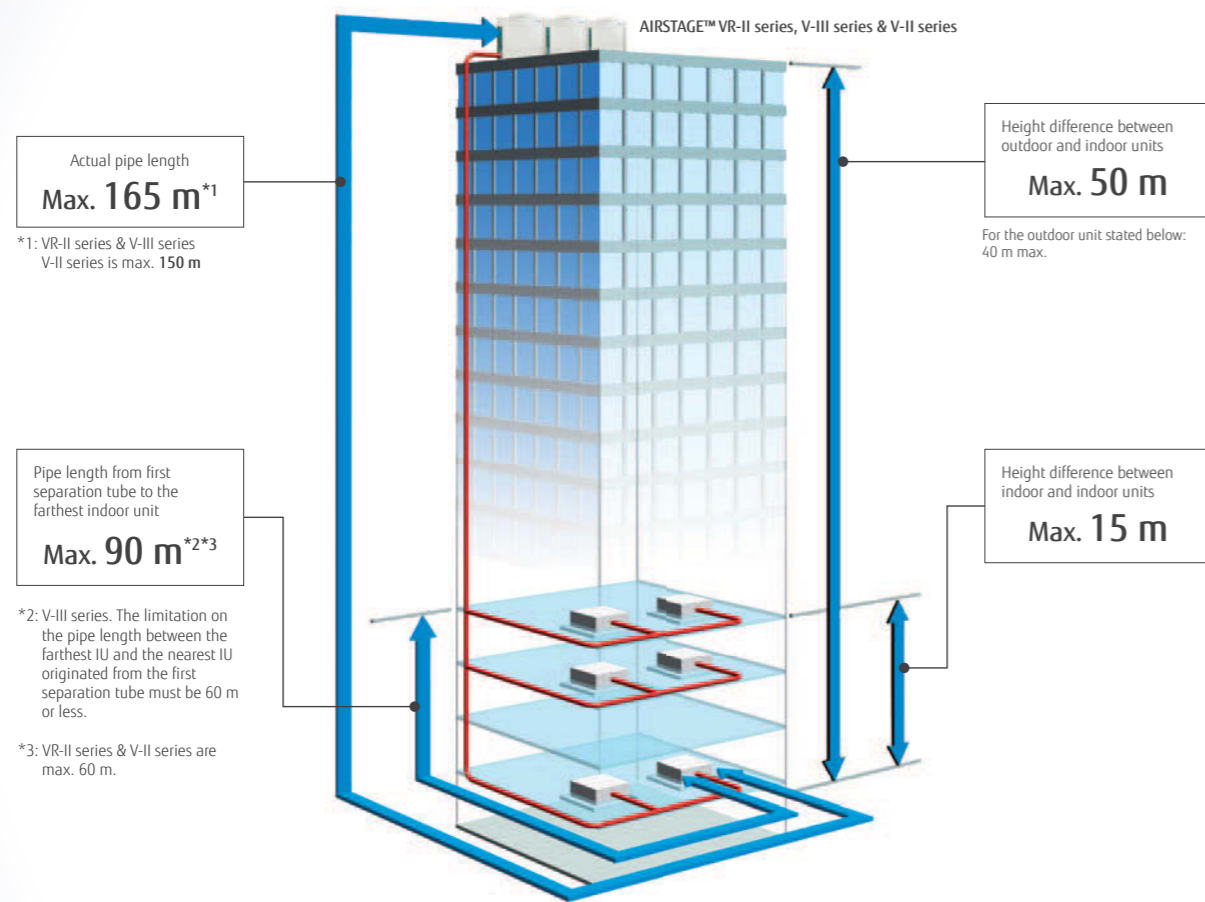

\*1: VR-II series & V-III series V-II series is max. 150 m

\*2: V-III series. The limitation on the pipe length between the farthest IU and the nearest IU originated from the first separation tube must be 60 m or less.

\*3: VR-II series & V-II series are max. 60 m.

## High static pressure

The outdoor unit can have a condenser hood easily connected with a static pressure of 82 Pa<sup>\*4</sup> standard. This allows outdoor units to be installed within plant rooms in high rise buildings.

Powerful discharge with an external static pressure of 82 Pa<sup>\*4</sup>.

Previous model

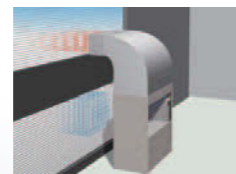

V-III series



Large diameter fan and DC motor has been utilized allowing an external static pressure of 82 Pa<sup>\*4</sup>. This is approximately 2.6 times greater than the previous model.

**82 Pa<sup>\*4</sup>**

Installation Example

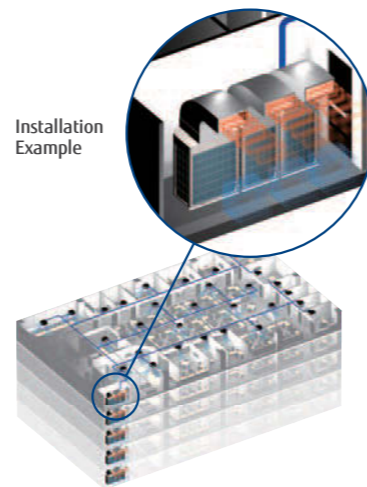

\*4: For V-III series, VR-II series & V-II series are 80 Pa.

## High capacity connection

### 8HP-48HP



AIRSTAGE™ V-II series Heat Pump type

Connectable indoor unit capacity range  
**50% to 150%<sup>\*6</sup>**

Connectable indoor unit number  
**up to 48**

AIRSTAGE™ VR-II series Heat Recovery type

Connectable indoor unit capacity range  
**50% to 150%<sup>\*6</sup>**

Connectable indoor unit number  
**up to 64**

### 4HP-6HP



AIRSTAGE™ J-II & AIRSTAGE™ J-IIS series Heat Pump type

Connectable indoor unit capacity range  
**50%<sup>\*8</sup> to 130%<sup>\*6</sup>**

Connectable indoor unit number  
**up to 9<sup>\*9</sup> \*J-IIS series is 8**

### 8HP-54HP



AIRSTAGE™ V-III series Heat Pump type

Connectable indoor unit capacity range  
**50% to 150%<sup>\*7</sup>**

Connectable indoor unit number  
**up to 64**

Series	Maximum connectable indoor unit capacity ratio	
	Without 1.1 kW models	With 1.1 kW models <sup>*9</sup>
V-II/VR-II	150%	130%
J-II/J-IIS	130%	120% (J-II), 117% (J-IIS)

\*6. Conditions of maximum connectable indoor unit capacity ratio is as the chart below.

\*7. Max. capacities in the combinations including the 18HP outdoor unit fall below 150%.

\*8. Only 4HP is 46%

\*9. In the case of connectable indoor units, 1.1 kW models and Cassette and/or Duct type of 9.0 kW class or more, maximum connectable indoor unit capacity ratio is 110%.

## Wide operating range

Installation in extreme temperature conditions is possible due to an increase in operational range.

AIRSTAGE™ VR-II series Heat Recovery type

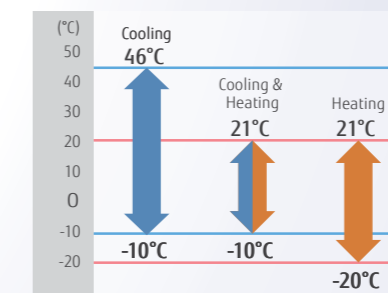

AIRSTAGE™ V-III & V-II series Heat Pump type

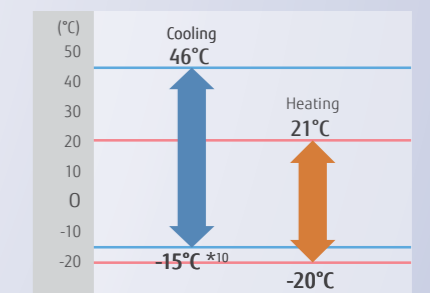

\*10. Note: When a multiple outdoor unit connection is used, operating range is from -5°C to 46°C in cooling.

AIRSTAGE™ J-II & J-IIS series Heat Pump type

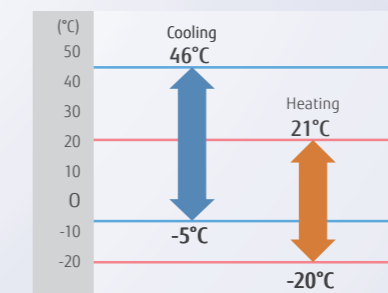

# High Reliability

## Life-extending operation\*1

The compressor starting order is rotated so that the running time is shared.

Note: Rotational operation is alternated by the start / stop timing of the compressor.

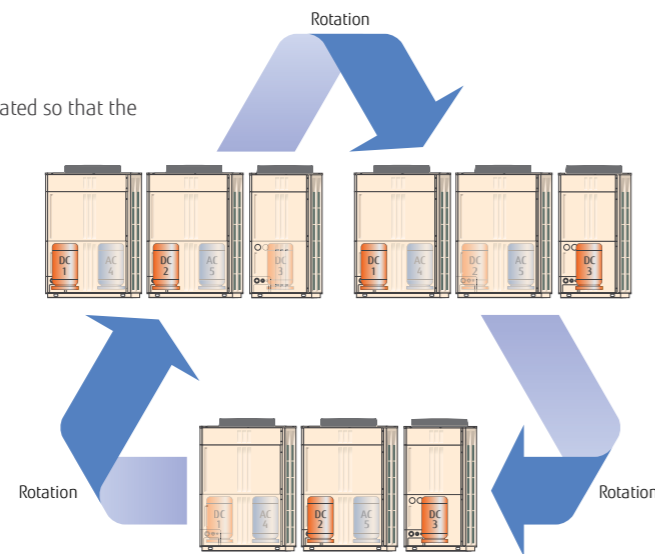

## Liquid flow back protection

By adopting a large sized accumulator, not completely vapourised refrigerant stays inside of the accumulator to ensure no liquid refrigerant is being fed into the compressor.

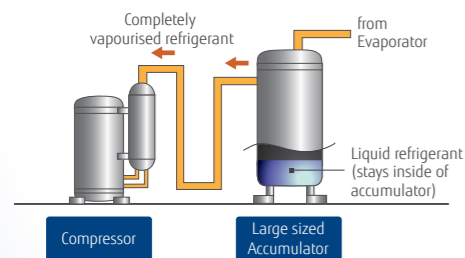

## Adoption of blue fin heat exchanger

Corrosion resistant of the heat exchanger has been improved by the introduction of blue fin treatment to the outdoor unit's heat exchanger.

### Blue fin heat exchanger

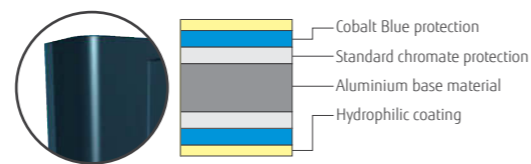

## Backup operation\*1

If one compressor fails, backup operation will be performed by the remaining compressors.\*2

\*2. Note: Backup operation may not be possible depending on the trouble state.

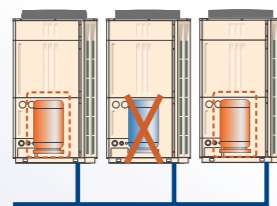

## Advanced refrigerant control\*1

Innovative compressor control logic has been introduced in order to balance the refrigerant mass flow rate of each outdoor unit by controlling the inverter speed.

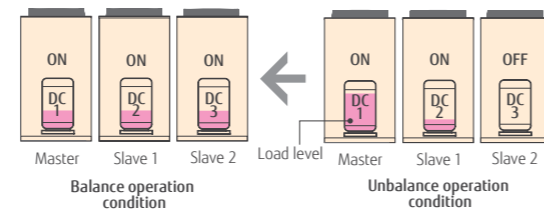

\*1. Not available for AIRSTAGE™ J-II and J-IIS series

# Easy Installation

## Easily transported

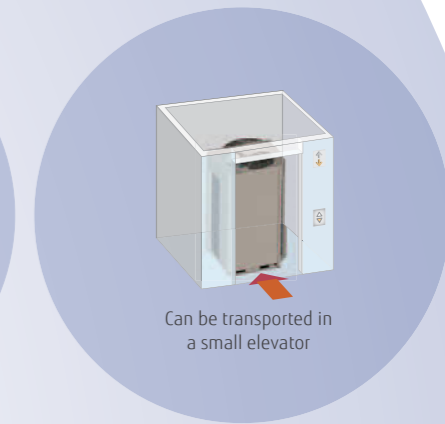
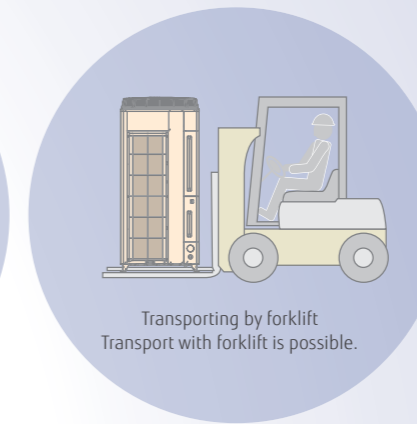
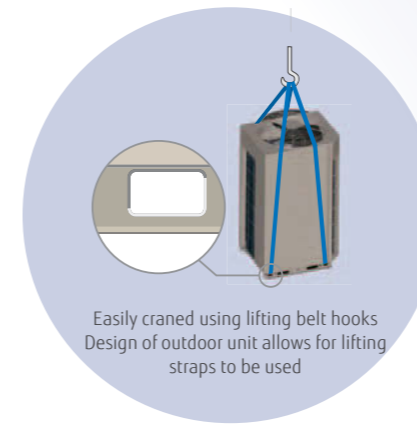

## Easy access

By adopting a L-Shape front panel that can be removed, the work space for installation and service has been significantly expanded by this new design.

For multiple installations, work is performed easily and efficiently even in a narrow space.

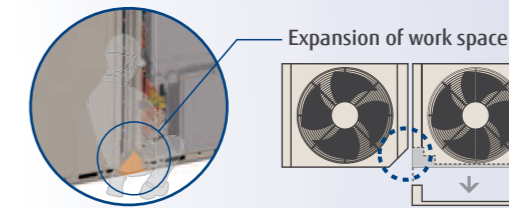

## Simple wiring work

Installation of the wiring systems is made easier as the communication wiring can be installed continuously between the indoor, outdoor and RB units.

Note: Serial connection can't use the automatic address setting in a multiple refrigerant system.

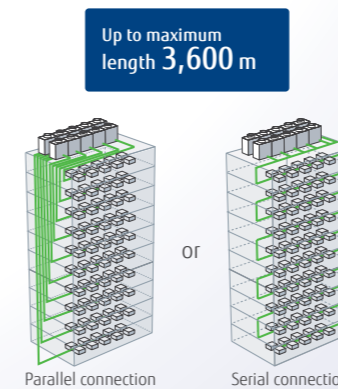

## Automatic address setting

The address of the indoor unit, RB unit and signal amplifier through the automatic function setting on the outdoor unit PCB.

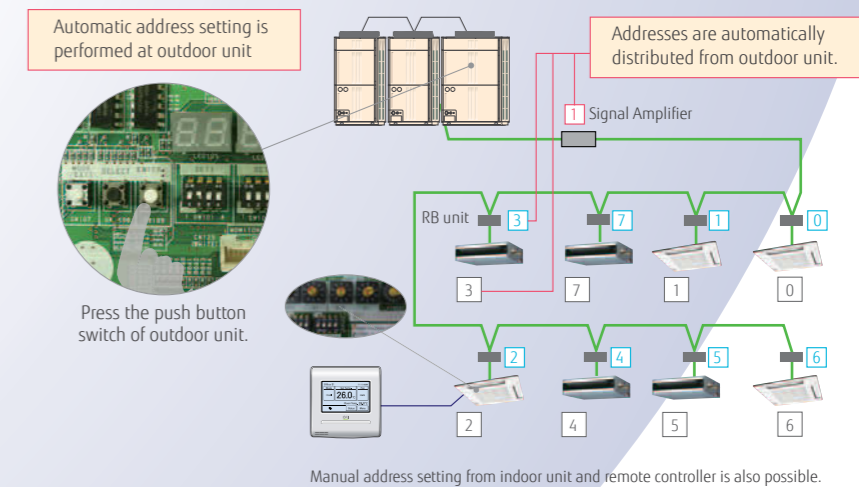



# Easy Service & Maintenance

## Design for easy maintenance

**Easy to read 7-segment LED :**  
Confirm detailed operational and error status without using any specific equipment.

- Operation mode status
- Discharge temperature/Pressure status
- Compressor operation indication
- Address/type/number of outdoor unit

**Movable PCB panel**  
Easier for maintenance work behind the PCB

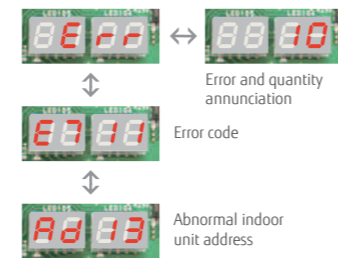

• Error status can be checked easily by outdoor unit display

**Error status can be checked easily via the indoor unit wired controller**  
An error code is displayed on a liquid crystal screen.

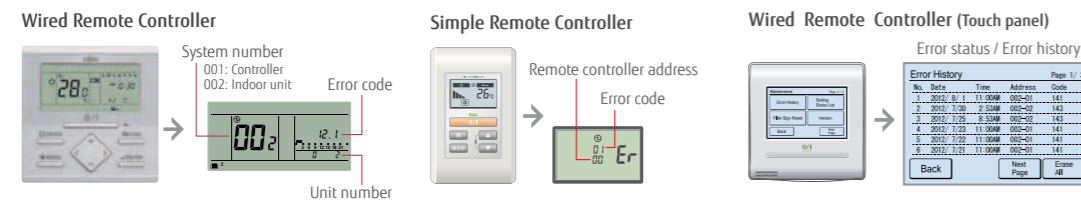

## Error diagnosis by Service Tool

### Connection to Service Tool

- Detail operation status and recent error history can be checked and analyzed by using the Service Tool.
- Last 5 min. operation memory can be also be recorded.

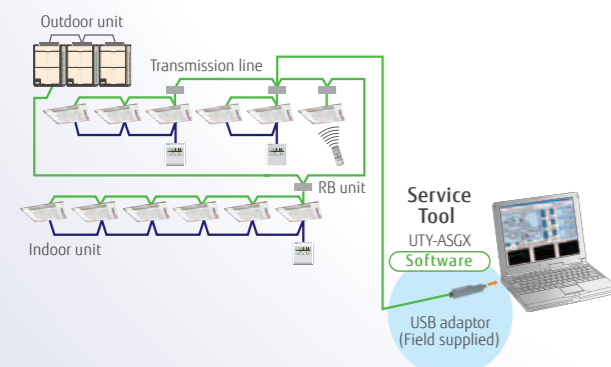

## Remote monitoring

The Web Monitoring system allows you to view system operation anytime over the internet, ensuring issue free operation.

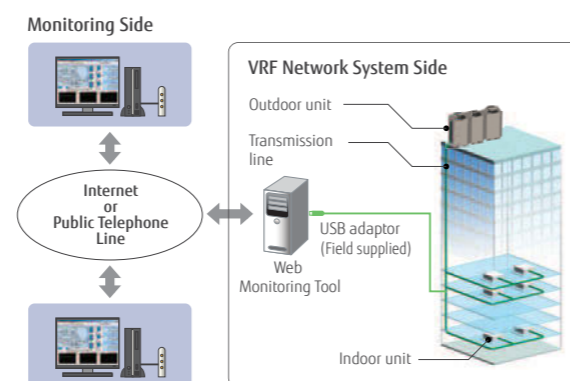

The operating VRF network system in the building can be monitored real time over the Internet.

Heat Recovery Modular type

130 **AIRSTAGE VR-II**

Heat Pump Modular type

138 **AIRSTAGE V-III**

144 **AIRSTAGE V-II**

Heat Pump for Small Capacity type

150 **AIRSTAGE J-II**

154 **AIRSTAGE J-IIS**

# AIRSTAGE SERIES OUTDOOR UNITS

# Heat Recovery Modular type

**AIRSTAGE™ VR-II**



Smart and cutting edge design  
Extensive lineup from 8HP to 48HP in 2HP increment  
Connectable indoor unit capacity ratio up to 150%

## System Outline

### Simultaneous cooling and heating operation using 1 refrigerant system

Cooling and heating can be freely selected for each indoor unit to provide simultaneous cooling and heating in the rooms with large temperature differences, etc.

### Annual cooling operation

Use annual cooling operation for the rooms and other spaces that require constant temperature control throughout the year.

### Handles changes in the temperature difference

The operation mode can be freely changed when there are large temperature differences during the day, such as between seasons.

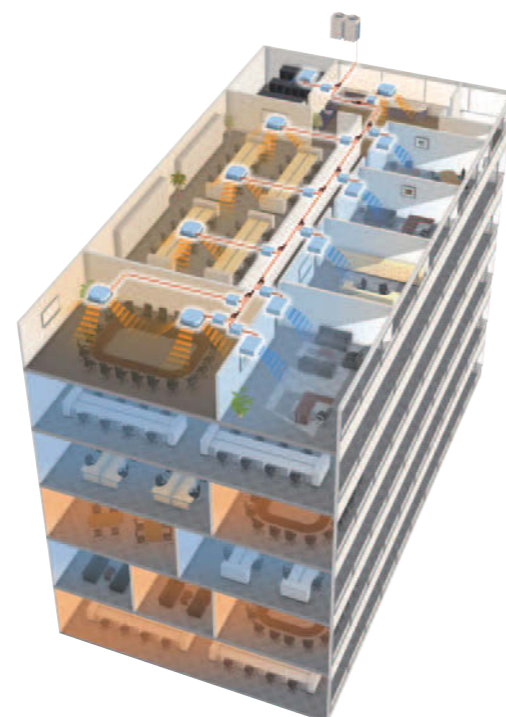

## Features

## Heat Recovery Modular Type **AIRSTAGE™ VR-II**

Our Heat recovery systems achieve high operating energy efficiency by drawing heat from the room to be cooled and transferring it as energy for rooms that are to be heated.

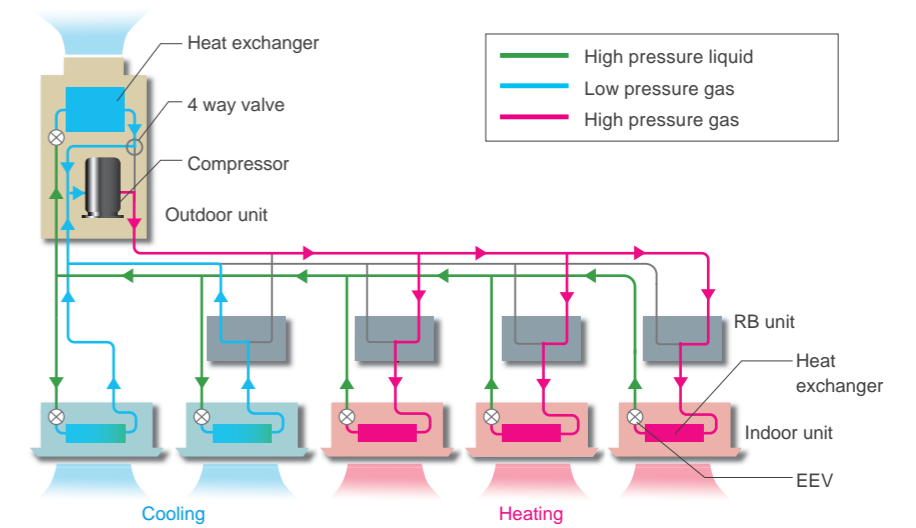

## Energy saving technology that boosted operation efficiency

### Powerful large propeller fan

By using CFD\*1 technology, a newly designed fan achieves high performance and low noise operation.

\*1. CFD = Computational Fluid Dynamics

### 3 phase DC fan motor

Efficiency is substantially improved by high efficient motor with sophisticated driver control. In addition, low noise is realized by DC fan motor.

### Sine-wave DC inverter control

High efficiency is realized by adoption of reduced switching loss IPM.

### 4-face heat exchanger

Heat exchange efficiency is significantly improved by the introduction of a new 4-face heat exchanger that increases effective surface area.

### Subcool heat exchanger

High Heat Exchange efficiency is achieved by using an internal projection shape double pipe construction.

### Front intake port (corner cut air inhaling structure)

In multiple outdoor unit installations, the unique front intake design improves airflow into the Heat Exchanger.

### High efficient and large capacity DC inverter compressor

Large capacity high efficient DC twin rotary compressor with excellent intermediate capability.

## High Efficiency

### Efficiency in actual operation

Top class high COP is achieved for all combinations by our unique heat exchanger structure, high efficient DC twin compressor, and our own technologies.

Space saving combination (COP)

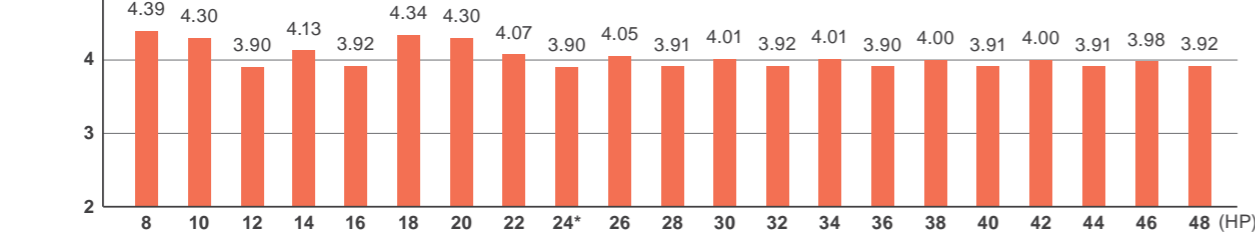

Energy efficiency combination (COP)

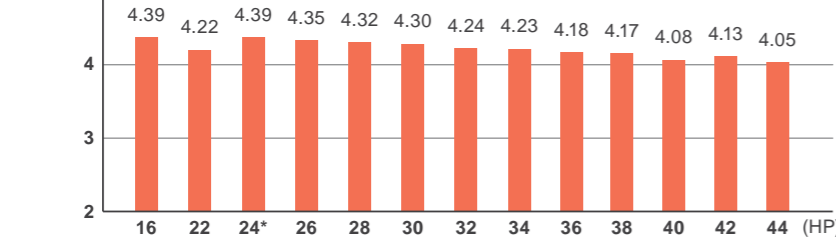

**For 24HP Combination**

Space saving      Energy efficiency

**COP 12.6% UP**

### All inverter compressor

**Large capacity DC inverter compressor**  
Large capacity high efficient DC twin rotary compressor with excellent intermediate capability.



**High efficient compressor speed control**  
Comfortable space with small room temperature changes and little energy loss is created by 0.1Hz steps compressor speed control.

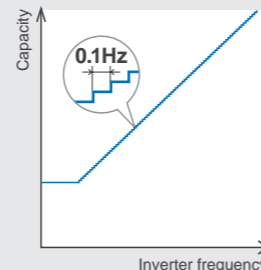

### Ideal heat exchanger path control

Heat exchanger is split into top and bottom. Heat exchange efficiency is improved by optimum heat exchanger path refrigerant control. Refrigerant is more distributed at the top side heat exchanger with a large intake airflow.

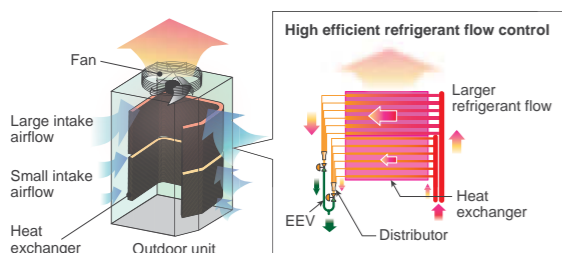

### Sophisticated operation control

When multiple outdoor units are connected, sophisticated operation is performed by each compressor. Efficiency is improved by all compressors at part load and distributing refrigerant to all of the heat exchangers rather than to one compressor.

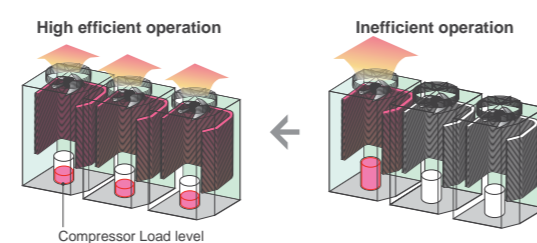

## Design Flexibility

### Flexible piping connection

A more flexible refrigerant piping work is possible by the use of various piping and RB Unit connections, for adjustments to the floor layout and building structure.

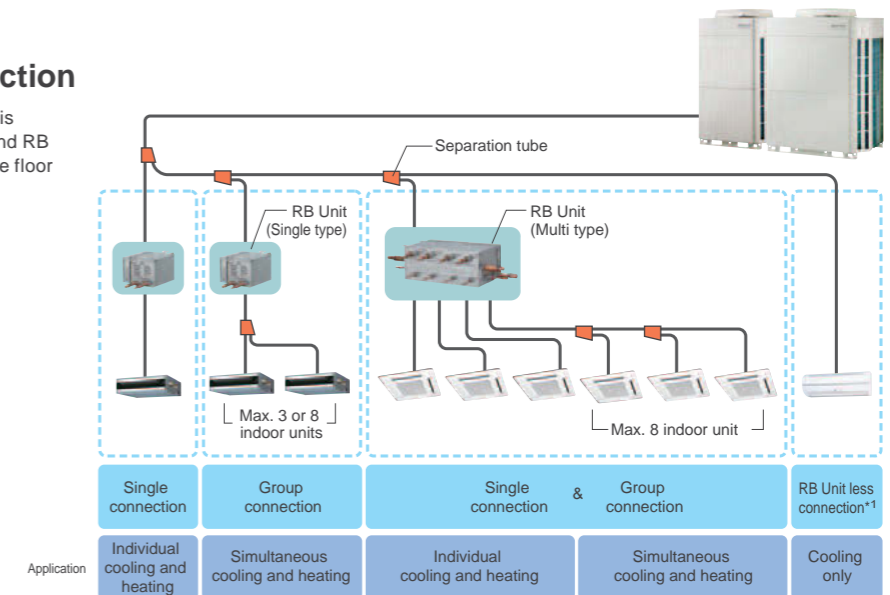

- The RB unit can be freely positioned between the first branch and the indoor unit.
- The maximum height difference between RB units is 15 m.
- \*1. RB Unit is not necessary for cooling only use.

## Easy Installation & Maintenance

### Flexible installation of RB unit

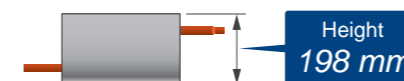

- Small & slim design saves space
- A drain pipe is not required
- The control box position can be changed to meet the installation conditions



Installation possible from either side for freedom of the control box      Installation possible on the upper-side for use in narrow space

- Small design saves space
- A drain pipe is not required
- Simple installation series connection design

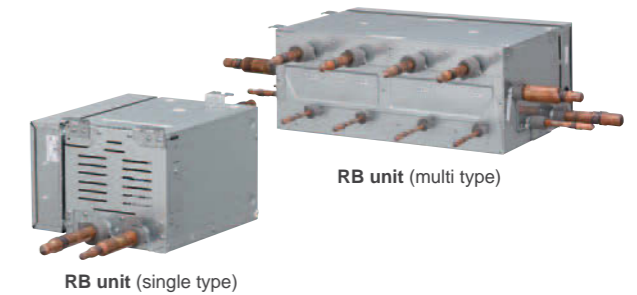
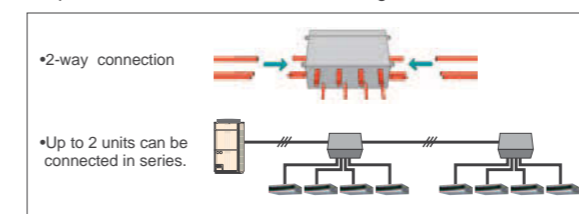

### Easy to maintenance in a narrow space



- Maintenance can be performed from the side.
- Electric box can be temporarily fixed by sliding down.

- Parts can be replaced easily even at narrow space in the ceiling.

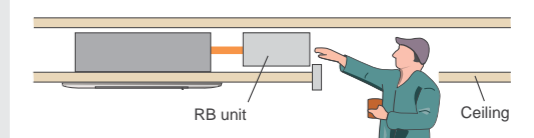

**Outdoor units lineup**

•Combinations other than the followings are not recommended.

**Space saving combination**

22.4 kW (8HP)  AJYA72GALH UNIT : AJYA72GALH	28.0 kW (10HP)  AJYA90GALH UNIT : AJYA90GALH	33.5 kW (12HP)  AJY108GALH UNIT : AJY108GALH	40.0 kW (14HP)  AJY126GALH UNIT : AJY126GALH	45.0 kW (16HP)  AJY144GALH UNIT : AJY144GALH
50.4 kW (18HP)  AJY162GALH UNIT : AJYA90/A72GALH	56.0 kW (20HP)  AJY180GALH UNIT : AJYA90/A90GALH	61.5 kW (22HP)  AJY198GALH UNIT : AJY108/A90GALH	67.0 kW (24HP)  AJY216GALH UNIT : AJY108/108GALH	73.0 kW (26HP)  AJY234GALH UNIT : AJY144/A90GALH
78.5 kW (28HP)  AJY252GALH UNIT : AJY144/108GALH	85.0 kW (30HP)  AJY270GALH UNIT : AJY144/126GALH	90.0 kW (32HP)  AJY288GALH UNIT : AJY144/144GALH	95.0 kW (34HP)  AJY306GALH UNIT : AJY108/108/A90GALH	100.5 kW (36HP)  AJY324GALH UNIT : AJY108/108/108GALH
106.5 kW (38HP)  AJY342GALH UNIT : AJY144/108/A90GALH	112.0 kW (40HP)  AJY360GALH UNIT : AJY144/108/108GALH	118.0 kW (42HP)  AJY378GALH UNIT : AJY144/144/A90GALH	123.5 kW (44HP)  AJY396GALH UNIT : AJY144/144/108GALH	130.0 kW (46HP)  AJY414GALH UNIT : AJY144/144/126GALH
135.0 kW (48HP)  AJY432GALH UNIT : AJY144/144/144GALH				

**Energy efficiency combination**

44.8 kW (16HP)  AJY144GALHH UNIT : AJYA72/A72GALH	62.4 kW (22HP)  AJY198GALHH UNIT : AJY126/A72GALH	67.2 kW (24HP)  AJY216GALHH UNIT : AJYA72/A72/A72GALH	72.8 kW (26HP)  AJY234GALHH UNIT : AJYA90/A72/A72GALH	78.4 kW (28HP)  AJY252GALHH UNIT : AJYA90/A90/A72GALH
84.0 kW (30HP)  AJY270GALHH UNIT : AJYA90/A90/A90GALH	90.4 kW (32HP)  AJY288GALHH UNIT : AJY126/A90/A72GALH	96.0 kW (34HP)  AJY306GALHH UNIT : AJY126/A90/A90GALH	102.4 kW (36HP)  AJY324GALHH UNIT : AJY126/126/A72GALH	108.0 kW (38HP)  AJY342GALHH UNIT : AJY126/126/A90GALH
113.0 kW (40HP)  AJY360GALHH UNIT : AJY144/126/A90GALH	120.0 kW (42HP)  AJY378GALHH UNIT : AJY126/126/126GALH	125.0 kW (44HP)  AJY396GALHH UNIT : AJY144/126/126GALH		

**Dimensions**

(Unit : mm)

8,10,12HP : AJYA72GALH / AJYA90GALH / AJY108GALH

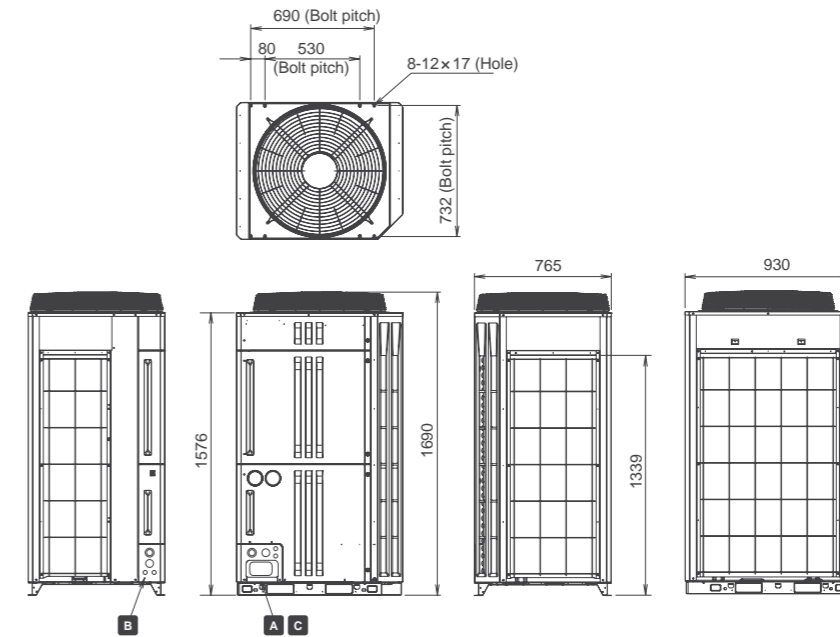

14,16HP : AJY126GALH / AJY144GALH

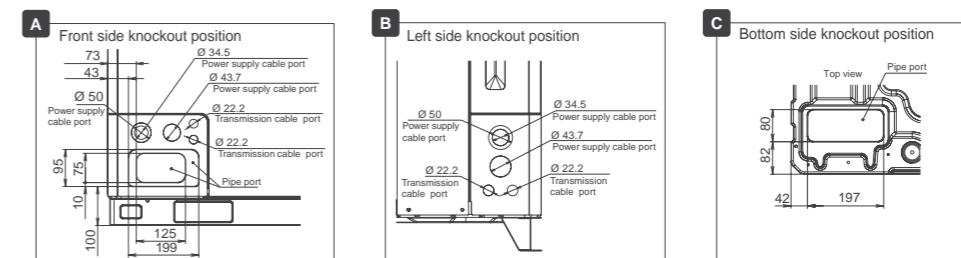
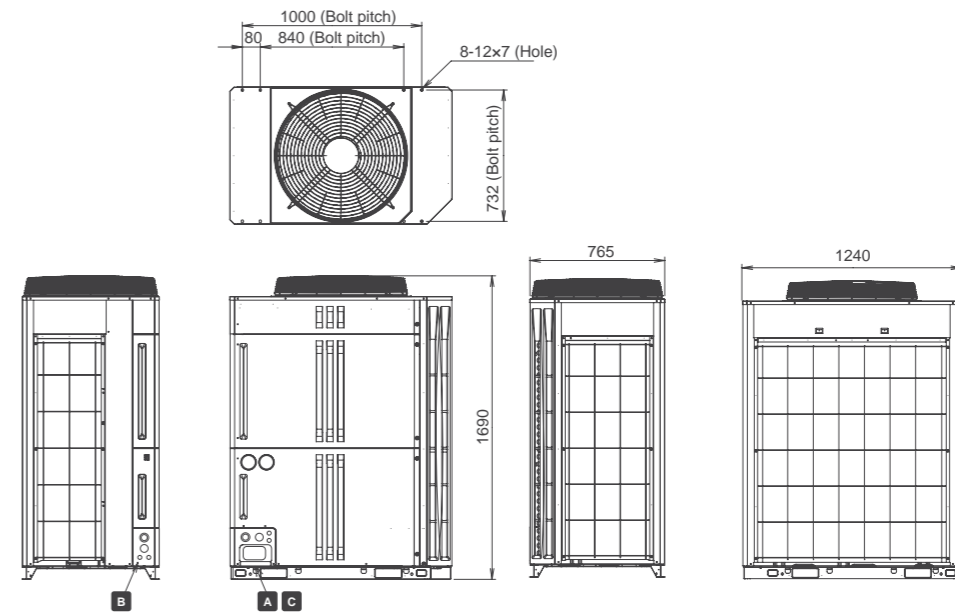



# Heat Pump Modular Type



Smart and cutting edge design  
 Extensive lineup from 8HP to 54HP in 2HP increment  
 Connectable indoor unit capacity ratio up to 150%

## System Outline

### Excellent energy saving

Heat pump inverter type realizes the highly energy saving air conditioning for individual cooling and heating operation by all inverter technology for seasonal efficiency.

### High design flexibility for various building air conditioning

High design flexibly meets the various needs of high-rise building air conditioning such as outdoor unit roof top concentrated installation and each floor installation by large capacity combination, sufficient connection capacity, and high static pressure design.

### Easy installation and maintenance

The flexible communication method and piping connections makes installation and maintenance easy even for large systems.

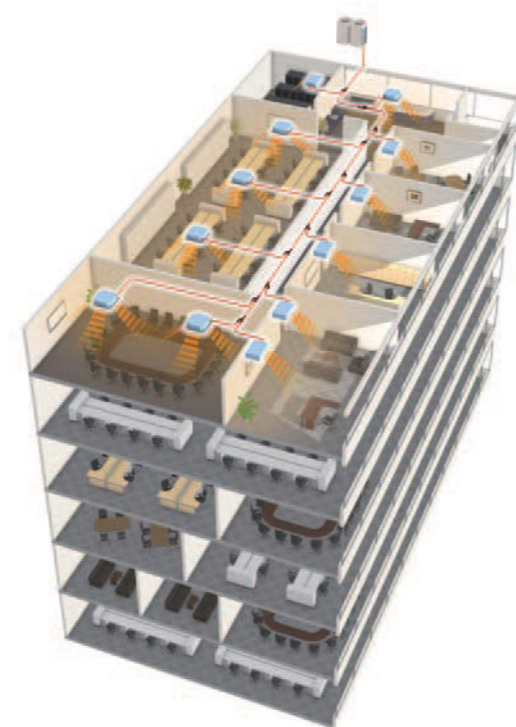

## Features





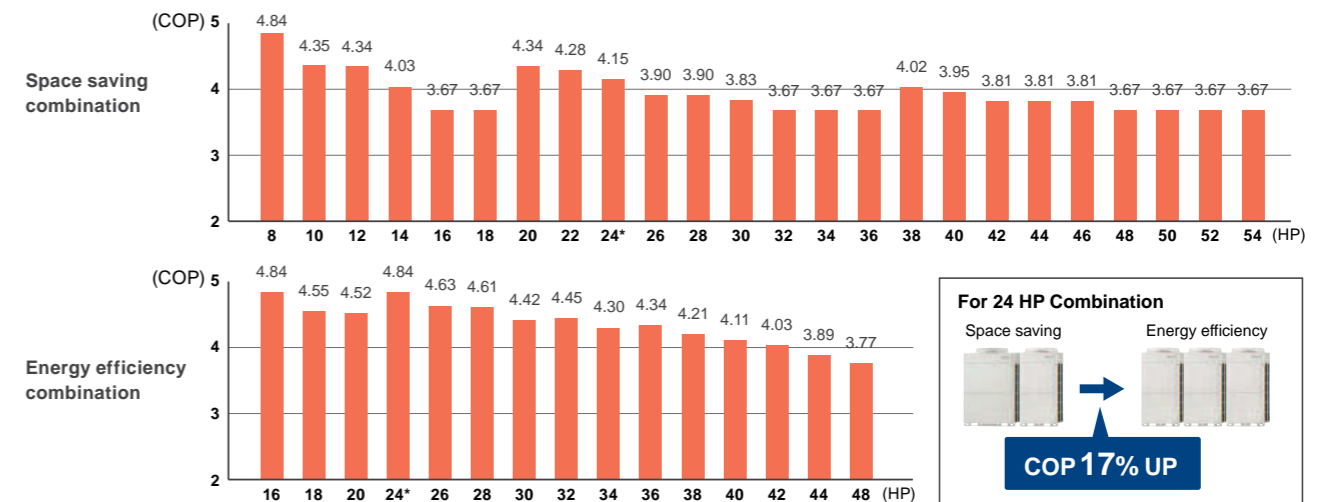

## High Efficiency

### Efficiency in actual operation

Top class high COP is achieved for all combinations by our unique heat exchanger structure, high efficient DC twin compressor, and our own technologies.

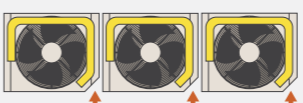

## Energy saving technology that boosted operation efficiency

- 
**Powerful large propeller fan**  
 By using CFD\*1 technology, a newly designed fan achieves high performance and low noise operation.  
\*1. CFD = Computational Fluid Dynamics
- 
**3 phase DC fan motor**  
 Efficiency is substantially improved by high efficient motor with sophisticated driver control. In addition, low noise is realized by DC fan motor.
- 
**Subcool heat exchanger**  
 High Heat Exchange efficiency is achieved by using an internal projection shape double pipe construction.
- 
**Sine-wave DC inverter control**  
 High efficiency is realized by adoption of reduced switching loss IPM.
- 
**High efficient and large capacity DC inverter compressor**  
 Large capacity high efficient DC twin rotary compressor with excellent intermediate capability.
- 
**4-face heat exchanger**  
 Heat exchange efficiency is significantly improved by the introduction of a new 4-face heat exchanger that increases effective surface area.
- 
**Front intake port (corner cut air inhaling structure)**  
 In multiple outdoor unit installations, the unique front intake design improves airflow into the Heat Exchanger.

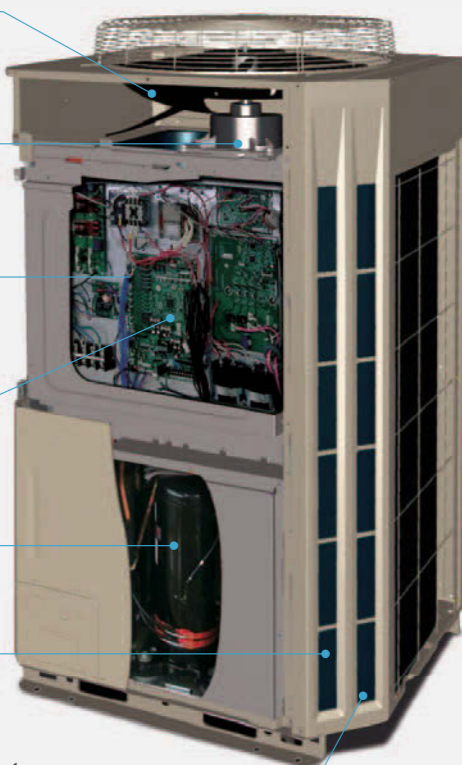

**Outdoor units lineup**

•Combinations other than the followings are not recommended.

**Space saving combination**

22.4 kW (8HP)  AJY072LALBH UNIT : AJY072LALBH	28.0 kW (10HP)  AJY090LALBH UNIT : AJY090LALBH	33.5 kW (12HP)  AJY108LALBH UNIT : AJY108LALBH	40.0 kW (14HP)  AJY126LALBH UNIT : AJY126LALBH	45.0 kW (16HP)  AJY144LALBH UNIT : AJY144LALBH
50.0 kW (18HP)  AJY162LALBH UNIT : AJY162LALBH	56.0 kW (20HP)  AJY180LALBH UNIT : AJY090/090LALBH	62.4 kW (22HP)  AJY198LALBH UNIT : AJY126/072LALBH	68.0 kW (24HP)  AJY216LALBH UNIT : AJY126/090LALBH	73.0 kW (26HP)  AJY234LALBH UNIT : AJY144/090LALBH
78.0 kW (28HP)  AJY252LALBH UNIT : AJY162/090LALBH	85.0 kW (30HP)  AJY270LALBH UNIT : AJY144/126LALBH	90.0 kW (32HP)  AJY288LALBH UNIT : AJY144/144LALBH	95.0 kW (34HP)  AJY306LALBH UNIT : AJY162/144LALBH	100.0 kW (36HP)  AJY324LALBH UNIT : AJY162/162LALBH
106.0 kW (38HP)  AJY342LALBH UNIT : AJY162/090/090LALBH	113.0 kW (40HP)  AJY360LALBH UNIT : AJY144/126/090LALBH	118.0 kW (42HP)  AJY378LALBH UNIT : AJY144/144/090LALBH	123.0 kW (44HP)  AJY396LALBH UNIT : AJY162/144/090LALBH	128.0 kW (46HP)  AJY414LALBH UNIT : AJY162/162/090LALBH
135.0 kW (48HP)  AJY432LALBH UNIT : AJY144/144/144LALBH	140.0 kW (50HP)  AJY450LALBH UNIT : AJY162/144/144LALBH	145.0 kW (52HP)  AJY468LALBH UNIT : AJY162/162/144LALBH	150.0 kW (54HP)  AJY486LALBH UNIT : AJY162/162/162LALBH	

**Energy efficiency combination**

44.8 kW (16HP)  AJY144LALBHH UNIT : AJY072/072LALBH	50.4kW (18HP)  AJY162LALBHH UNIT : AJY090/072LALBH	55.9 kW (20HP)  AJY180LALBHH UNIT : AJY108/072LALBH	67.2 kW (24HP)  AJY216LALBHH UNIT : AJY072/072/072LALBH	72.8 kW (26HP)  AJY234LALBHH UNIT : AJY090/072/072LALBH
78.3 kW (28HP)  AJY252LALBHH UNIT : AJY108/072/072LALBH	84.8 kW (30HP)  AJY270LALBHH UNIT : AJY126/072/072LALBH	89.4 kW (32HP)  AJY288LALBHH UNIT : AJY108/108/072LALBH	95.9 kW (34HP)  AJY306LALBHH UNIT : AJY126/108/072LALBH	100.5 kW (36HP)  AJY324LALBHH UNIT : AJY108/108/108LALBH
107.0 kW (38HP)  AJY342LALBHH UNIT : AJY126/108/108LALBH	113.5 kW (40HP)  AJY360LALBHH UNIT : AJY126/126/108LALBH	120.0 kW (42HP)  AJY378LALBHH UNIT : AJY126/126/126LALBH	125.0 kW (44HP)  AJY396LALBHH UNIT : AJY144/126/126LALBH	130.0 kW (46HP)  AJY414LALBHH UNIT : AJY144/144/126LALBH

**Dimensions**

(Unit : mm)

8,10HP : AJY072LALBH / AJY090LALBH

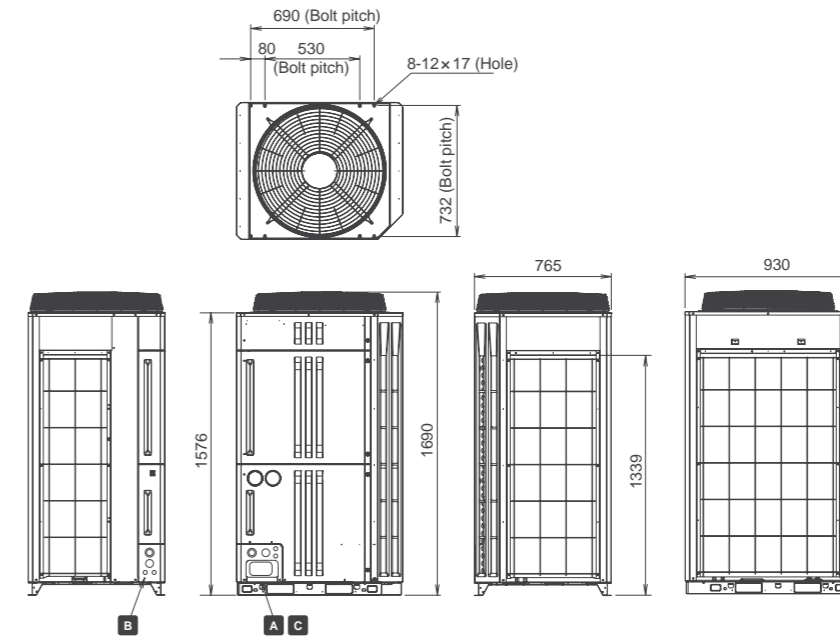



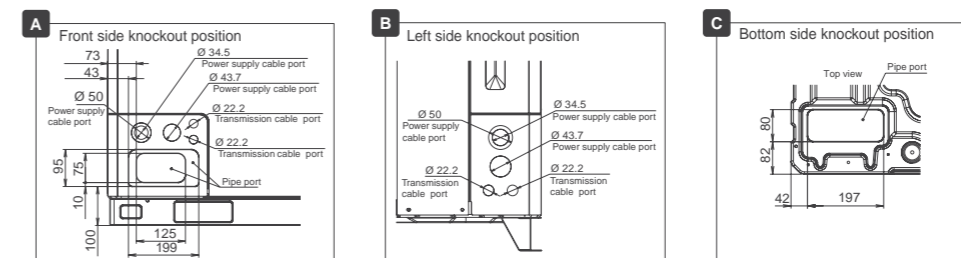
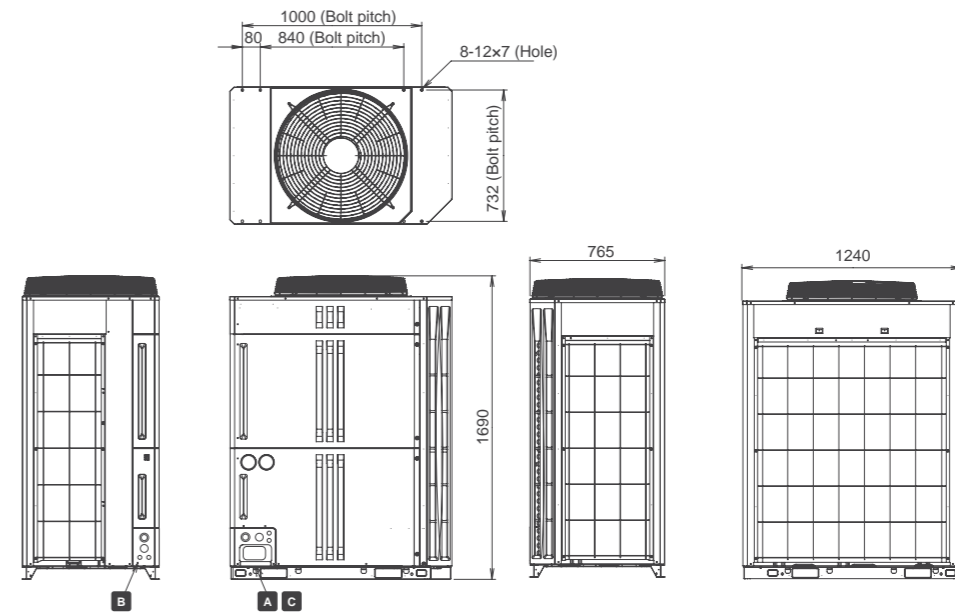









12, 14,16, 18HP : AJY108LALBH / AJY126LALBH / AJY144LALBH / AJY162LALBH











Outdoor units specifications

Space Saving Combination

Rating Capacity range	HP	8	10	12	14	16	18	20	22	24	26	28	30	32	34	36	38	40	42	44	46	48	50	52	54	
																										
Model name		AJY072LALBH	AJY090LALBH	AJY108LALBH	AJY126LALBH	AJY144LALBH	AJY162LALBH	AJY180LALBH	AJY198LALBH	AJY216LALBH	AJY234LALBH	AJY252LALBH	AJY270LALBH	AJY288LALBH	AJY306LALBH	AJY324LALBH	AJY342LALBH	AJY360LALBH	AJY378LALBH	AJY396LALBH	AJY414LALBH	AJY432LALBH	AJY450LALBH	AJY468LALBH	AJY486LALBH	
Unit 1		AJY072LALBH	AJY090LALBH	AJY108LALBH	AJY126LALBH	AJY144LALBH	AJY162LALBH	AJY180LALBH	AJY198LALBH	AJY216LALBH	AJY234LALBH	AJY252LALBH	AJY270LALBH	AJY288LALBH	AJY306LALBH	AJY324LALBH	AJY342LALBH	AJY360LALBH	AJY378LALBH	AJY396LALBH	AJY414LALBH	AJY432LALBH	AJY450LALBH	AJY468LALBH	AJY486LALBH	
Unit 2		AJY072LALBH	AJY090LALBH	AJY108LALBH	AJY126LALBH	AJY144LALBH	AJY162LALBH	AJY180LALBH	AJY198LALBH	AJY216LALBH	AJY234LALBH	AJY252LALBH	AJY270LALBH	AJY288LALBH	AJY306LALBH	AJY324LALBH	AJY342LALBH	AJY360LALBH	AJY378LALBH	AJY396LALBH	AJY414LALBH	AJY432LALBH	AJY450LALBH	AJY468LALBH	AJY486LALBH	
Unit 3		AJY072LALBH	AJY090LALBH	AJY108LALBH	AJY126LALBH	AJY144LALBH	AJY162LALBH	AJY180LALBH	AJY198LALBH	AJY216LALBH	AJY234LALBH	AJY252LALBH	AJY270LALBH	AJY288LALBH	AJY306LALBH	AJY324LALBH	AJY342LALBH	AJY360LALBH	AJY378LALBH	AJY396LALBH	AJY414LALBH	AJY432LALBH	AJY450LALBH	AJY468LALBH	AJY486LALBH	
Maximum Connectable Indoor Unit*1		17	21	26	30	34	39	43	47	52	56	60	64	64	64	64	64	64	64	64	64	64	64	64	64	
Indoor unit connectable capacity	Cooling	kW	11.2-33.6	14.0-42.0	16.8-50.2	20.0-60.0	22.5-67.5	25.0-67.5	28.0-84.0	31.2-93.6	34.0-102.0	36.5-109.5	39.0-109.5	42.5-127.5	45.0-135.0	47.5-135.0	50.0-135.0	53.0-151.5	56.5-169.5	59.0-177.0	61.5-177.0	64.0-177.0	67.5-202.5	70.0-202.5	72.5-202.5	75.0-202.5
Power source			3-phase 4 wire, 400 V, 50Hz												3-phase 4 wire, 400 V, 50Hz											
Capacity	Cooling	kW	22.4	28.0	33.5	40.0	45.0	50.0	56.0	62.4	68.0	73.0	78.0	85.0	90.0	95.0	100.0	106.0	113.0	118.0	123.0	128.0	135.0	140.0	145.0	150.0
	Heating	kW	25.0	31.5	37.5	45.0	50.0	50.0	63.0	70.0	76.5	81.5	81.5	95.0	100.0	100.0	100.0	113.0	126.5	131.5	131.5	131.5	150.0	150.0	150.0	150.0
Input power	Cooling	kW	5.20	7.28	8.96	10.96	13.01	16.56	14.56	16.16	18.24	20.29	23.84	23.97	26.02	29.57	33.12	31.12	31.25	33.30	36.85	40.40	39.03	42.58	46.13	49.68
	Heating	kW	5.17	7.25	8.65	11.17	13.63	16.56	14.50	16.34	18.42	20.88	20.88	24.80	27.26	27.26	27.26	28.13	32.05	34.51	34.51	34.51	40.89	40.89	40.89	40.89
EER	Cooling	W/W	4.31	3.85	3.74	3.65	3.46	3.02	3.85	3.86	3.73	3.60	3.27	3.55	3.46	3.21	3.02	3.41	3.62	3.54	3.34	3.17	3.46	3.29	3.14	3.02
COP	Heating	W/W	4.84	4.35	4.34	4.03	3.67	3.67	4.34	4.28	4.15	3.90	3.90	3.83	3.67	3.67	3.67	4.02	3.95	3.81	3.81	3.81	3.67	3.67	3.67	3.67
Air flow rate	High	m³/h	11,100	11,100	13,000	13,000	13,700	13,700	11,100x2	13,000+11,100	13,000+11,100	13,000+11,100	13,700+11,100	13,700+13,000	13,700x2	13,700x2	13,700x2	13,700x2	13,700+11,100x2	13,700+13,000+11,100	13,700x2+11,100	13,700x2+11,100	13,700x3	13,700x3	13,700x3	13,700x3
Sound pressure level*2	Cooling	dB (A)	56	58	57	60	62	63	61	61	62	63	64	64	65	66	66	66	65	66	66	66	67	67	67	68
	Heating	dB (A)	58	59	60	62	64	64	62	63	64	65	65	66	67	67	67	67	66	67	68	68	68	69	69	69
Maximum external static pressure		Pa	82	82	82	82	82	82	82	82	82	82	82	82	82	82	82	82	82	82	82	82	82	82	82	82
Compressor motor output		kW	7.5	7.5	11.0	11.0	11.0	11.0	7.5x2	11.0+7.5	11.0+7.5	11.0+7.5	11.0+7.5	11.0x2	11.0x2	11.0x2	11.0x2	11.0x2	11.0+7.5x2	11.0x2+7.5	11.0x2+7.5	11.0x2+7.5	11.0x2+7.5	11.0x3	11.0x3	11.0x3
Heat exchanger fin			Blue fin	Blue fin	Blue fin	Blue fin	Blue fin	Blue fin	Blue fin	Blue fin	Blue fin	Blue fin	Blue fin	Blue fin	Blue fin	Blue fin	Blue fin	Blue fin	Blue fin	Blue fin	Blue fin	Blue fin	Blue fin	Blue fin	Blue fin	Blue fin
Dimensions	Height	mm	1,690	1,690	1,690	1,690	1,690	1,690	1,690	1,690	1,690	1,690	1,690	1,690	1,690	1,690	1,690	1,690	1,690	1,690	1,690	1,690	1,690	1,690	1,690	
	Width	mm	930	930	1,240	1,240	1,240	1,240	930x2	1,240+930	1,240+930	1,240+930	1,240+930	1,240x2	1,240x2	1,240x2	1,240x2	1,240x2	1,240+930x2	1,240x2+930	1,240x2+930	1,240x2+930	1,240x2+930	1,240x3	1,240x3	1,240x3
	Depth	mm	765	765	765	765	765	765	765	765	765	765	765	765	765	765	765	765	765	765	765	765	765	765	765	765
Weight		kg	252	252	275	275	275	252x2	275+252	275+252	275+252	275+252	275x2	275x2	275x2	275x2	275x2	275x2	275+252x2	275x2+252	275x2+252	275x2+252	275x3	275x3	275x3	275x3
Refrigerant charge		kg	11.7	11.7	11.8	11.8	11.8	11.7x2	11.8+11.7	11.8+11.7	11.8+11.7	11.8+11.7	11.8x2	11.8x2	11.8x2	11.8x2	11.8x2	11.8+11.7x2	11.8x2+11.7	11.8x2+11.7	11.8x2+11.7	11.8x2+11.7	11.8x3	11.8x3	11.8x3	
Connection pipe diameter	Liquid	mm	12.70	12.70	12.70	12.70	15.88	15.88	15.88	15.88	15.88	15.88	19.05	19.05	19.05	19.05	19.05	19.05	19.05	19.05	19.05	19.05	19.05	19.05	19.05	
	Gas	mm	22.22	22.22	28.58	28.58	28.58	28.58	28.58	34.92	34.92	34.92	34.92	34.92	34.92	34.92	34.92	41.27	41.27	41.27	41.27	41.27	41.27	41.27	41.27	
Operation range	Cooling	°C	-15 to 46	-15 to 46	-15 to 46	-15 to 46	-15 to 46	-5 to 46	-5 to 46	-5 to 46	-5 to 46	-5 to 46	-5 to 46	-5 to 46	-5 to 46	-5 to 46	-5 to 46	-5 to 46	-5 to 46	-5 to 46	-5 to 46	-5 to 46	-5 to 46	-5 to 46	-5 to 46	
	Heating	°C	-20 to 21	-20 to 21	-20 to 21	-20 to 21	-20 to 21	-20 to 21	-20 to 21	-20 to 21	-20 to 21	-20 to 21	-20 to 21	-20 to 21	-20 to 21	-20 to 21	-20 to 21	-20 to 21	-20 to 21	-20 to 21	-20 to 21	-20 to 21	-20 to 21	-20 to 21	-20 to 21	

Energy Efficiency Combination

Rating Capacity range	HP	16	18	20	24	26	28	30	32	34	36	38	40	42	44	46		
																		
Model name		AJY144LALBHH	AJY162LALBHH	AJY180LALBHH	AJY216LALBHH	AJY234LALBHH	AJY252LALBHH	AJY270LALBHH	AJY288LALBHH	AJY306LALBHH	AJY324LALBHH	AJY342LALBHH	AJY360LALBHH	AJY378LALBHH	AJY396LALBHH	AJY414LALBHH		
Unit 1		AJY072LALBH	AJY090LALBH	AJY108LALBH	AJY072LALBH	AJY090LALBH	AJY108LALBH	AJY126LALBH	AJY108LALBH	AJY126LALBH	AJY108LALBH	AJY126LALBH	AJY126LALBH	AJY126LALBH	AJY144LALBH	AJY144LALBH		
Unit 2		AJY072LALBH	AJY090LALBH	AJY108LALBH	AJY072LALBH	AJY090LALBH	AJY108LALBH	AJY126LALBH	AJY108LALBH	AJY126LALBH	AJY108LALBH	AJY126LALBH	AJY126LALBH	AJY126LALBH	AJY144LALBH	AJY144LALBH		
Unit 3		AJY072LALBH	AJY090LALBH	AJY108LALBH	AJY072LALBH	AJY090LALBH	AJY108LALBH	AJY126LALBH	AJY108LALBH	AJY126LALBH	AJY108LALBH	AJY126LALBH	AJY126LALBH	AJY126LALBH	AJY144LALBH	AJY144LALBH		
Maximum Connectable Indoor Unit*1		34	39	43	52	56	60	64	64	64	64	64	64	64	64			
Indoor unit connectable capacity	Cooling	kW	22.4-67.2	25.2-75.6	28.0-83.8	33.6-100.8	36.4-109.2	39.2-117.4	42.4-127.2	44.7-134.1	48.0-143.8	50.3-150.7	53.5-160.5	56.8-170.2	60.0-180.0	62.5-187.5	65.0-195.0	
Power source			3-phase 4 wire, 400 V, 50Hz								3-phase 4 wire, 400 V, 50Hz							
Capacity	Cooling	kW	44.8	50.4	55.9	67.2	72.8	78.3	84.8	89.4	95.9	100.5	107.0	113.5	120.0	125.0	130.0	
	Heating	kW	50.0	56.5	62.5	75.0	81.5	87.5	95.0	100.0	107.5	112.5	120.0	127.5	135.0	140.0	145.0	
Input power	Cooling	kW	10.40	12.48	14.16	15.60	17.68	19.36	21.36	23.12	25.12	26.88	28.88	30.88	32.88	34.93	36.98	
	Heating	kW	10.34	12.42	13.82	15.51	17.59	18.99	21.51	22.47	24.99	25.95	28.47	30.99	33.51	35.97	38.43	
EER	Cooling	W/W	4.31	4.04	3.95	4.31	4.12	4.04	3.97	3.87	3.82	3.74	3.70	3.68	3.65	3.58	3.52	
COP	Heating	W/W	4.84	4.55	4.52	4.84	4.63	4.61	4.42	4.45	4.30	4.34	4.21	4.11	4.03	3.89	3.77	
Air flow rate	High	m³/h	11,100x2	11,100x2	13,000+11,100	11,100x3	11,000x3	13,000+11,100x2	13,000+11,100x2	13,000x2+11,100	13,000x2+11,100	13,000x3	13,000x3	13,000x3	13,000x3	13,700+13,000x2	13,700x2+13,000	
Sound pressure level*2	Cooling	dB (A)	59	60														



# Heat Pump Modular Type



Smart and cutting edge design  
 Extensive lineup from 8HP to 48HP in 2HP increment  
 Connectable indoor unit capacity ratio up to 150%

## System Outline

### Excellent energy savings

Heat pump type inverter control is used to achieve economic cooling and heating operation for individual air conditioning to entire air conditioning.

### High design flexibility for various building air conditioning

The high static pressure design flexibly meets the needs of high rise buildings including easy installation on each floor.

### Easy installation and maintenance

The flexible communication method and piping connections makes installation and maintenance easy even for large systems.

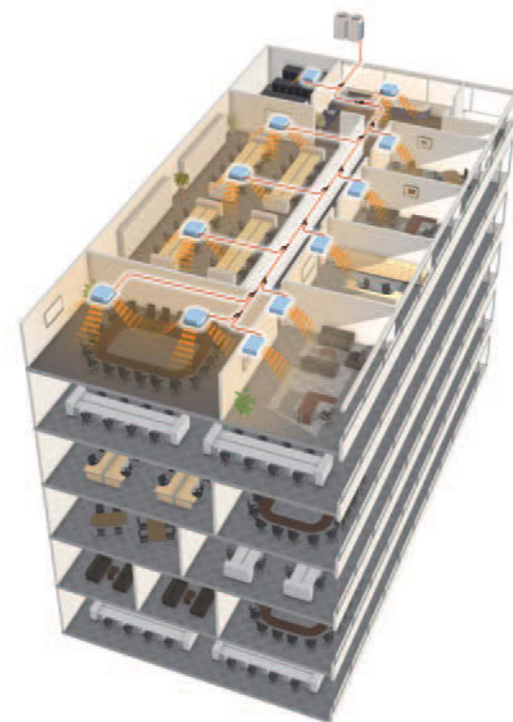

## Features

## High Efficiency

### Efficiency in actual operation

Top class high COP is achieved for all combinations by our unique heat exchanger structure, high efficient DC twin compressor, and our own technologies.

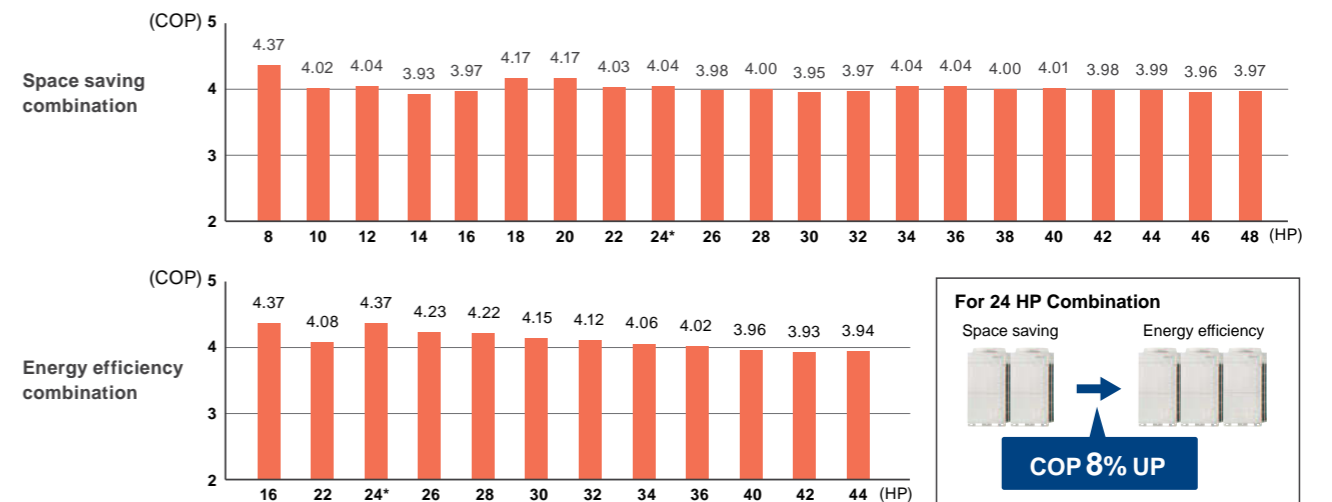

## Energy saving technology that boosted operation efficiency

- Powerful large propeller fan**  
 By using CFD<sup>\*1</sup> technology, a newly designed fan achieves high performance and low noise operation.  
\*1. CFD = Computational Fluid Dynamics
- DC fan motor**  
 Power consumption has been reduced by 25% compared to previous models by using a compact and high performance DC fan motor.
- Subcool heat exchanger**  
 High Heat Exchange efficiency is achieved by using an internal projection shape double pipe construction.
- Sine-wave DC inverter control**  
 High efficiency operation is realized by using a sine wave DC inverter control.
- DC twin rotary compressor**  
 Significantly greater efficiency is realized by use of a large capacity DC twin rotary compressor with substantially increased refrigerant intake and compression efficiency.
- 4-face heat exchanger**  
 Heat exchange efficiency is significantly improved by the introduction of a new 4-face heat exchanger that increases effective surface area.
- Front intake port (corner cut air inhaling structure)**  
 In multiple outdoor unit installations, the unique front intake design improves airflow into the Heat Exchanger.

**Outdoor units lineup**

•Combinations other than the followings are not recommended.

**Space saving combination**

22.4 kW (8HP)  AJYA72LALH UNIT : AJYA72LALH	28.0 kW (10HP)  AJYA90LALH UNIT : AJYA90LALH	33.5 kW (12HP)  AJY108LALH UNIT : AJY108LALH	40.0 kW (14HP)  AJY126LALH UNIT : AJY126LALH	45.0 kW (16HP)  AJY144LALH UNIT : AJY144LALH
50.4 kW (18HP)  AJY162LALH UNIT : AJYA90/A72LALH	55.9 kW (20HP)  AJY180LALH UNIT : AJY108/A72LALH	61.5 kW (22HP)  AJY198LALH UNIT : AJY108/A90LALH	67.0 kW (24HP)  AJY216LALH UNIT : AJY108/108LALH	73.5 kW (26HP)  AJY234LALH UNIT : AJY126/108LALH
78.5 kW (28HP)  AJY252LALH UNIT : AJY144/108LALH	85.0 kW (30HP)  AJY270LALH UNIT : AJY144/126LALH	90.0 kW (32HP)  AJY288LALH UNIT : AJY144/144LALH	95.0 kW (34HP)  AJY306LALH UNIT : AJY108/108/A90LALH	100.5 kW (36HP)  AJY324LALH UNIT : AJY108/108/108LALH
107.0 kW (38HP)  AJY342LALH UNIT : AJY126/108/108LALH	112.0 kW (40HP)  AJY360LALH UNIT : AJY144/108/108LALH	118.5 kW (42HP)  AJY378LALH UNIT : AJY144/126/108LALH	123.5 kW (44HP)  AJY396LALH UNIT : AJY144/144/108LALH	130.0 kW (46HP)  AJY414LALH UNIT : AJY144/144/126LALH
135.0 kW (48HP)  AJY432LALH UNIT : AJY144/144/144LALH				

**Energy efficiency combination**

44.8 kW (16HP)  AJY144LALHH UNIT : AJYA72/A72LALH	62.4 kW (22HP)  AJY198LALHH UNIT : AJY126/A72LALH	67.2 kW (24HP)  AJY216LALHH UNIT : AJYA72/A72/A72LALH	72.8 kW (26HP)  AJY234LALHH UNIT : AJYA90/A72/A72LALH	78.3 kW (28HP)  AJY252LALHH UNIT : AJY108/A72/A72LALH
84.8 kW (30HP)  AJY270LALHH UNIT : AJY126/A72/A72LALH	89.8 kW (32HP)  AJY288LALHH UNIT : AJY108/108/A72LALH	95.9 kW (34HP)  AJY306LALHH UNIT : AJY126/108/A72LALH	102.4 kW (36HP)  AJY324LALHH UNIT : AJY126/126/A72LALH	113.5 kW (40HP)  AJY360LALHH UNIT : AJY126/126/108LALH
120.0 kW (42HP)  AJY378LALHH UNIT : AJY126/126/126LALH	125.0 kW (44HP)  AJY396LALHH UNIT : AJY144/126/126LALH			

**Dimensions**

(Unit : mm)

8,10,12HP : AJYA72LALH / AJYA90LALH / AJY108LALH

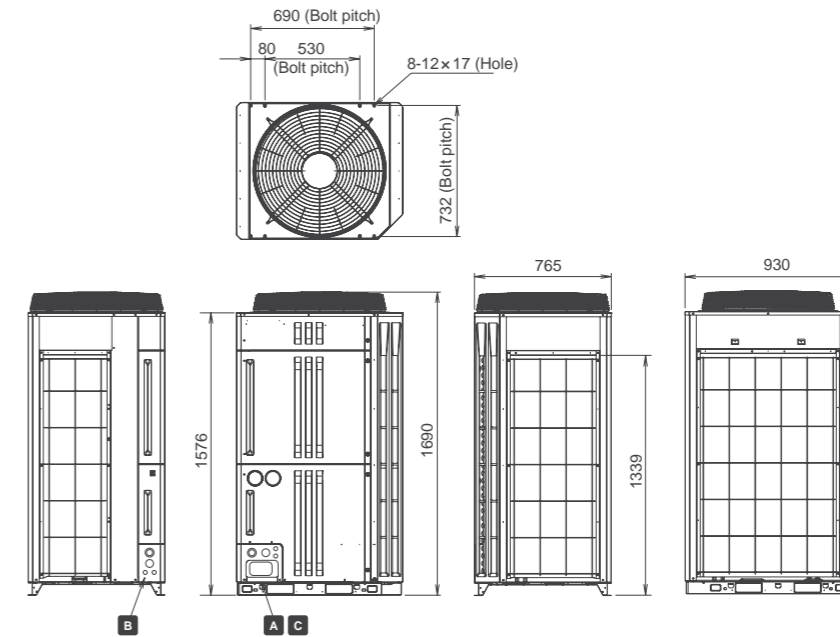

14,16HP : AJY126LALH / AJY144LALH

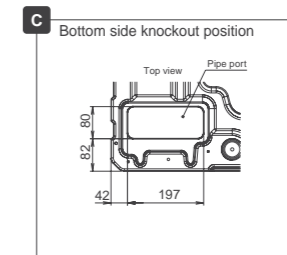
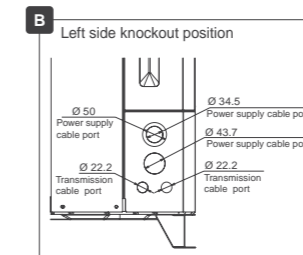
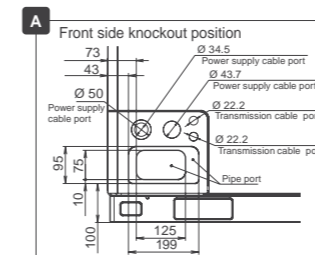
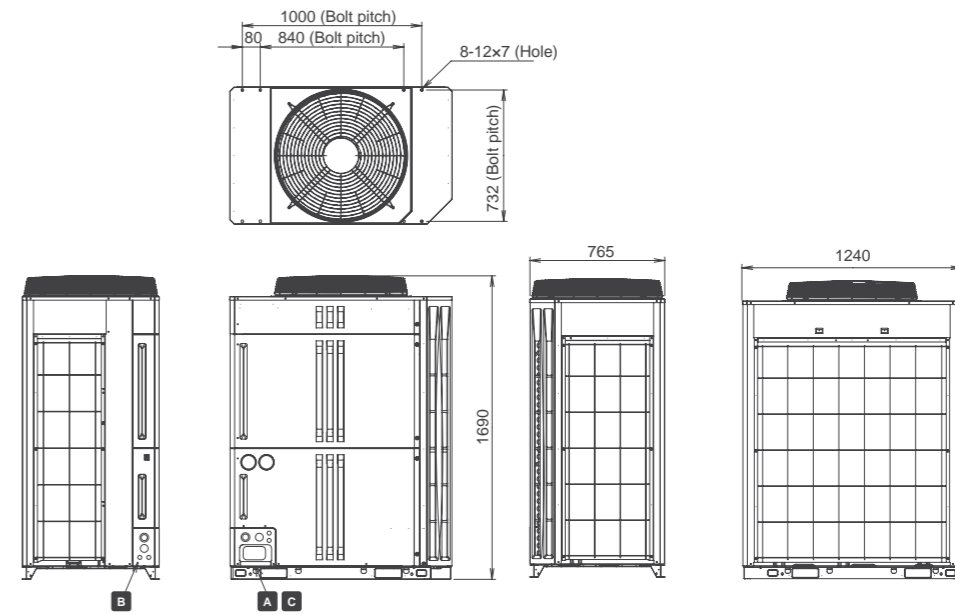

Outdoor units specifications

Space Saving Combination

Rating Capacity range	HP	8	10	12	14	16	18	20	22	24	26	28	30	32	34	36	38	40	42	44	46	48	
Model name		AJYA72LALH	AJYA90LALH	AJY108LALH	AJY126LALH	AJY144LALH	AJY162LALH	AJY180LALH	AJY198LALH	AJY216LALH	AJY234LALH	AJY252LALH	AJY270LALH	AJY288LALH	AJY306LALH	AJY324LALH	AJY342LALH	AJY360LALH	AJY378LALH	AJY396LALH	AJY414LALH	AJY432LALH	
Unit 1		AJYA72LALH	AJYA90LALH	AJY108LALH	AJY126LALH	AJY144LALH	AJYA90LALH	AJY108LALH	AJY108LALH	AJY108LALH	AJY126LALH	AJY144LALH	AJY144LALH	AJY144LALH	AJY108LALH	AJY108LALH	AJY126LALH	AJY144LALH	AJY144LALH	AJY144LALH	AJY144LALH	AJY144LALH	AJY144LALH
Unit 2							AJYA72LALH	AJYA72LALH	AJYA90LALH		AJY108LALH	AJY108LALH	AJY126LALH	AJY144LALH	AJY108LALH	AJY108LALH	AJY108LALH	AJY108LALH	AJY108LALH	AJY108LALH	AJY108LALH	AJY108LALH	AJY108LALH
Unit 3																							
Maximum Connectable Indoor Unit*1		15	16	17	21	24	32	32	32	35	39	42	45	48	48	48	48	48	48	48	48	48	48
Indoor unit connectable capacity	Cooling	11.2-33.6	14.0-42.0	16.8-50.2	20.0-60.0	22.5-67.5	25.2-75.6	28.0-83.8	30.8-92.2	33.5-100.5	36.8-110.2	39.3-117.7	42.5-127.5	45.0-135.0	47.5-142.5	50.3-150.7	53.5-160.5	56.0-168.0	59.3-177.7	61.8-185.2	65.0-195.0	67.5-202.5	
Power source		3-phase 4 wire, 400 V, 50Hz										3-phase 4 wire, 400 V, 50Hz											
Capacity	Cooling	22.4	28.0	33.5	40.0	45.0	50.4	55.9	61.5	67.0	73.5	78.5	85.0	90.0	95.0	100.5	107.0	112.0	118.5	123.5	130.0	135.0	
	Heating	25.0	31.5	37.5	45.0	50.0	56.5	62.5	69.0	75.0	82.5	87.5	95.0	100.0	106.5	112.5	120.0	125.0	132.5	137.5	145.0	150.0	
Input power	Cooling	5.51	7.73	9.62	11.53	14.17	13.24	15.13	17.35	19.24	21.15	23.79	25.70	28.34	26.97	28.86	30.77	33.41	35.32	37.96	39.87	42.51	
	Heating	5.72	7.83	9.28	11.45	12.60	13.55	15.00	17.11	18.56	20.73	21.88	24.05	25.20	26.39	27.84	30.01	31.16	33.33	34.48	36.65	37.80	
EER	Cooling	4.07	3.62	3.48	3.47	3.18	3.81	3.69	3.54	3.48	3.48	3.30	3.31	3.18	3.52	3.48	3.48	3.35	3.36	3.25	3.26	3.18	
COP	Heating	4.37	4.02	4.04	3.93	3.97	4.17	4.17	4.03	4.04	3.98	4.00	3.95	3.97	4.04	4.04	4.00	4.01	3.98	3.99	3.96	3.97	
Air flow rate	High	11,100	11,100	11,100	13,000	13,000	11,100 x 2	11,100 x 2	11,100 x 2	11,100 x 2	13,000 + 11,100	13,000 + 11,100	13,000 x 2	13,000 x 2	11,100 x 3	11,100 x 3	13,000 + 11,100 x 2	13,000 + 11,100 x 2	13,000 + 11,100 x 2	13,000 + 11,100 x 2	13,000 x 3	13,000 x 3	
Sound pressure level*2	Cooling	56	58	58	60	61	60	60	61	61	62	63	64	64	63	63	64	64	65	65	65	66	
	Heating	58	59	60	61	61	62	62	63	63	64	64	64	64	64	65	65	65	65	65	66	66	
Maximum external static pressure	Pa	80	80	80	80	80	80	80	80	80	80	80	80	80	80	80	80	80	80	80	80	80	
Compressor motor output	kW	3.9	3.9	3.9 + 4.5	3.9 + 4.5	3.9 + 4.5	3.9 x 2	3.9 x 2 + 4.5	3.9 x 2 + 4.5	3.9 x 2 + 4.5 x 2	3.9 x 2 + 4.5 x 2	3.9 x 2 + 4.5 x 2	3.9 x 2 + 4.5 x 2	3.9 x 2 + 4.5 x 2	3.9 x 3 + 4.5 x 2	3.9 x 3 + 4.5 x 2	3.9 x 3 + 4.5 x 2	3.9 x 3 + 4.5 x 2	3.9 x 3 + 4.5 x 2	3.9 x 3 + 4.5 x 2	3.9 x 3 + 4.5 x 2	3.9 x 3 + 4.5 x 2	
Heat exchanger fin		Blue fin										Blue fin											
Dimensions	Height	mm	1,690	1,690	1,690	1,690	1,690	1,690	1,690	1,690	1,690	1,690	1,690	1,690	1,690	1,690	1,690	1,690	1,690	1,690	1,690	1,690	1,690
	Width	mm	930	930	930	1,240	1,240	930 x 2	930 x 2	930 x 2	930 x 2	930 + 1,240	930 + 1,240	1,240 x 2	1,240 x 2	930 x 3	930 x 3	930 x 2 + 1,240	930 x 2 + 1,240	930 + 1,240 x 2	930 + 1,240 x 2	1,240 x 3	1,240 x 3
	Depth	mm	765	765	765	765	765	765	765	765	765	765	765	765	765	765	765	765	765	765	765	765	765
Weight	kg	220	220	275	303	303	220 + 220	275 + 220	275 + 220	275 + 220	303 + 275	303 + 275	303 + 303	296 + 296	275 + 275 + 220	275 + 275 + 220	303 + 275 + 275	303 + 275 + 275	303 + 275 + 275	303 + 275 + 275	303 + 303 + 275	303 + 303 + 275	303 + 303 + 275
Refrigerant charge	kg	11.2	11.2	11.8	11.8	11.8	11.2 x 2	11.8 + 11.2	11.8 + 11.2	11.8 x 2	11.8 x 2	11.8 x 2	11.8 x 2	11.8 x 2	11.8 x 2 + 11.2	11.8 x 3	11.8 x 3	11.8 x 3	11.8 x 3	11.8 x 3	11.8 x 3	11.8 x 3	11.8 x 3
Connection pipe diameter	Liquid	mm	12.70	12.70	12.70	12.70	12.70	15.88	15.88	15.88	15.88	15.88	19.05	19.05	19.05	19.05	19.05	19.05	19.05	19.05	19.05	19.05	
	Gas	mm	22.22	22.22	28.58	28.58	28.58	28.58	28.58	34.92	34.92	34.92	34.92	34.92	34.92	41.27	41.27	41.27	41.27	41.27	41.27	41.27	41.27
Operation range	Cooling	°C	-15 to 46	-15 to 46	-15 to 46	-15 to 46	-15 to 46	-5 to 46	-5 to 46	-5 to 46	-5 to 46	-5 to 46	-5 to 46	-5 to 46	-5 to 46	-5 to 46	-5 to 46	-5 to 46	-5 to 46	-5 to 46	-5 to 46	-5 to 46	
	Heating	°C	-20 to 21	-20 to 21	-20 to 21	-20 to 21	-20 to 21	-20 to 21	-20 to 21	-20 to 21	-20 to 21	-20 to 21	-20 to 21	-20 to 21	-20 to 21	-20 to 21	-20 to 21	-20 to 21	-20 to 21	-20 to 21	-20 to 21	-20 to 21	

Energy Efficiency Combination

Rating Capacity range	HP	16	22	24	26	28	30	32	34	36	40	42	44
Model name		AJY144LALHH	AJY198LALHH	AJY216LALHH	AJY234LALHH	AJY252LALHH	AJY270LALHH	AJY288LALHH	AJY306LALHH	AJY324LALHH	AJY360LALHH	AJY378LALHH	AJY396LALHH
Unit 1		AJYA72LALH	AJY126LALH	AJYA72LALH	AJYA90LALH	AJY108LALH	AJY126LALH	AJY108LALH	AJY126LALH	AJY126LALH	AJY126LALH	AJY126LALH	AJY144LALH
Unit 2		AJYA72LALH	AJYA72LALH	AJYA72LALH	AJYA72LALH	AJYA72LALH	AJYA72LALH	AJYA72LALH	AJYA72LALH	AJYA72LALH	AJYA72LALH	AJY126LALH	AJY126LALH
Unit 3													
Maximum Connectable Indoor Unit*1		30	33	36	39	42	45	48	48	48	48	48	48
Indoor unit connectable capacity	Cooling	22.4-67.2	31.2-93.6	33.6-100.8	36.4-109.2	39.2-117.4	42.4-127.2	44.7-134.1	48.0-143.8	51.2-153.6	56.8-170.2	60.0-180.0	62.5-187.5
Power source		3-phase 4 wire, 400 V, 50Hz						3-phase 4 wire, 400 V, 50Hz					
Capacity	Cooling	44.8	62.4	67.2	72.8	78.3	84.8	89.4	95.9	102.4	113.5	120.0	125.0
	Heating	50.0	70.0	75.0	81.5	87.5	95.0	100.0	107.5	115.0	127.5	135.0	140.0
Input power	Cooling	11.02	17.04	16.53	18.75	20.64	22.55	24.75	26.66	28.57	32.68	34.59	37.23
	Heating	11.44	17.17	17.16	19.27	20.72	22.89	24.28	26.45	28.62	32.18	34.35	35.50
EER	Cooling	4.07	3.66	4.07	3.88	3.79	3.76	3.61	3.60	3.58	3.47	3.47	3.36
COP	Heating	4.37	4.08	4.37	4.23	4.22	4.15	4.12	4.06	4.02	3.96	3.93	3.94
Air flow rate	High	11,100 x 2	13,000 + 11,100	11,100 x 3	11,100 x 3	11,100 x 3	13,000 + 11,000 x 2	11,100 x 3	13,000 + 11,100 x 2	13,000 x 2 + 11,100	13,000 x 2 + 11,100	13,000 x 3	13,000 x 3
Sound pressure level*2	Cooling	59	61	61	62	62	63	62	63	64	64	65	65
	Heating	59	62	61	62	63	63	64	64	65	65	66	66
Maximum external static pressure	Pa	80	80	80	80	80	80	80	80	80	80	80	80
Compressor motor output	kW	3.9 x 2	3.9 x 2 + 4.5	3.9 x 3	3.9 x 3	3.9 x 3 + 4.5	3.9 x 3 + 4.5	3.9 x 3 + 4.5 x 2	3.9 x 3 + 4.5 x 2	3.9 x 3 + 4.5 x 2	3.9 x 3 + 4.5 x 3	3.9 x 3 + 4.5 x 3	3.9 x 3 + 4.5 x 3
Heat exchanger fin		Blue fin						Blue fin					
Dimensions	Height	mm	1,690	1,690	1,690	1,690	1,690	1,690	1,690	1,690	1,690	1,690	1,690
	Width	mm	930 x 2	930 + 1,240	930 x 3	930 x 3	930 x 3	930 x 2 + 1,240	930 x 3	930 x 2 + 1,240	930 + 1,240 x 2	930 + 1,240 x 2	1,240 x 3
	Depth	mm	765	765	765	765	765	765	765	765	765	765	765
Weight	kg	220 + 220	303 + 220	220 + 220 + 220	220 + 220 + 220	275 + 220 + 220	303 + 220 + 220	275 + 275 + 220	303 + 275 + 220	303 + 303 + 220	303 + 303 + 275	303 + 303 + 303	303 + 303 + 303
Refrigerant charge	kg	11.2 x 2	11.8 + 11.2	11.2 x 3	11.2 x 3	11.8 + 11.2 x 2	11.8 + 11.2 x 2	11.8 x 2 + 11.2	11.8 x 2 + 11.2	11.8 x 2 + 11.2	11.8 x 3	11.8 x 3	11.8 x 3
Connection pipe diameter	Liquid	mm	12.70	15.88	15.88	15.88	15.88	19.05	19.05	19.05	19.05	19.05	19.05
	Gas	mm	28.58	34.92	34.92	34.92	34.92	34.92	34.92	34.92	41.27	41.27	41.27
Operation range	Cooling	°C	-5 to 46	-5 to 46	-5 to 46	-5 to 46	-5 to 46	-5 to 46	-5 to 46	-5 to 46	-5 to 46	-5 to 46	-5 to 46
	Heating	°C	-20 to 21	-20 to 21	-20 to 21	-20 to 21	-20 to 21	-20 to 21	-20 to 21	-20 to 21	-20 to 21	-20 to 21	-20 to 21

Note : Specifications are based on the following conditions.  
 Cooling : Indoor temperature of 27°CDB / 19°CWB, and outdoor temperature of 35°CDB / 24°CWB.  
 Heating : Indoor temperature of 20°CDB / (15°CWB), and outdoor temperature of 7°CDB / 6°CWB.

Pipe length : 7.5 m; Height difference between outdoor unit and indoor unit : 0 m.  
 When cooling operation will

# Heat Pump for Small Capacity Type

AIRSTAGE™ J-II



4, 5, 6HP

Fujitsu General provides air conditioning systems for a wide range of applications from small office buildings and stores to large houses.

## System Outline

### High Energy Efficiency

Heat pump inverter control is used to achieve an efficient cooling and heating operation in any indoor unit combination.

### Flexible systems for small- and medium-size buildings air conditioning

Space saving design and long piping design allow for flexible installation on the roofs or balconies of small and medium-size buildings.

Multiple indoor units of various capacities and types can be connected.



## Features

## Heat Pump for Small Capacity Type AIRSTAGE™ J-II

The building load is in the range of 40 % to 80 %. Therefore, most air conditioners do not operate at maximum load, but operate at low to medium loads. Especially, for multi system, operation performance at partial load is important because air conditioners do not always operate at full load all the time. Aiming at energy saving performance matched to actual operation, Fujitsu General has developed a high performance air conditioner corresponding not only during the rated performance at 100 % load, but also at low to medium load

### Load curve (a typical office building)

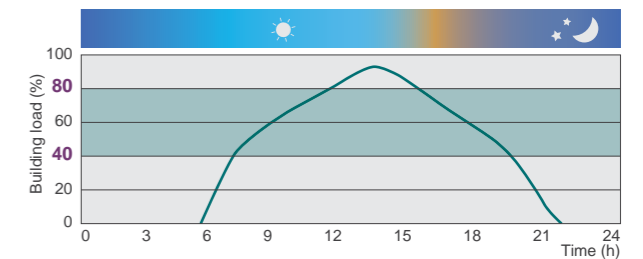

### High EER / COP



### High part load performance (6HP class)

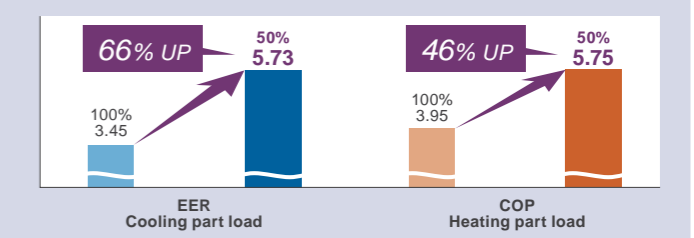

Conditions : Connected indoor units: AUXA30GALH+AUXD24GALH  
Cooling : indoor temp. of 27°CDB / 19°CWB, outdoor temp. of 35°CDB / 24°CWB  
Heating : indoor temp. of 20°CDB / 15°CWB, outdoor temp. of 7°CDB / 6°CWB

## Advanced high efficiency technology

- Large propeller fan**  
High performance and low noise realized by large propeller and optimization of angle.
- DC fan motor**  
Miniaturized, low noise, high efficiency, multi-stage DC fan motor is mounted.
- Subcool heat exchanger**  
Cooling performance is improved by mounting of dual tube heat exchanger.
- Large heat exchanger**  
Heat exchange performance is substantially improved by mounting of 3-row large heat exchanger.
- DC inverter control**  
Efficiency is improved by mounting of new active filter module.
- DC twin rotary compressor**  
Efficiency in all load regions is good. Especially good performance from low to medium at normal operation.

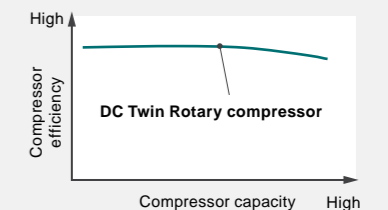
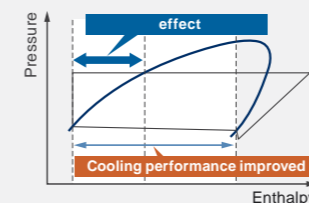

### Long Piping Length

Our advanced refrigerant control technology allows us to achieve a total refrigerant piping length of 180 m. This opens up new possibilities in system design.

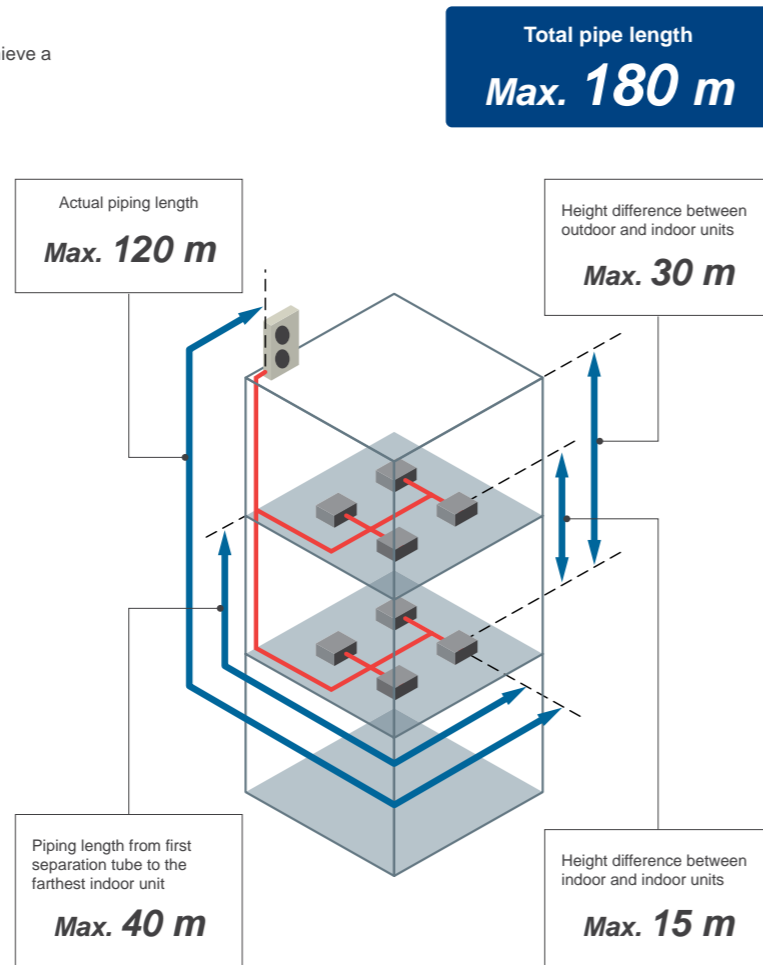

### More Comfort

#### Non-stop oil recovery operation

A comfortable room condition is maintained during oil recovery mode because the product continues to operate without stopping the cooling or heating operation.

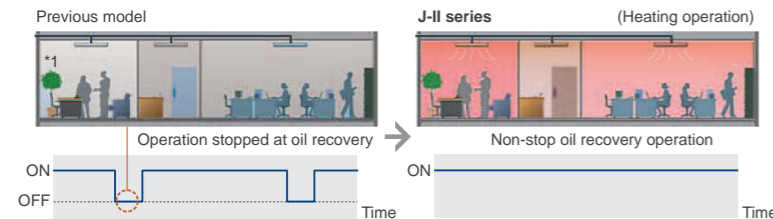

#### Easier Installation

**Connection check function** : Possible to confirm whether wiring connection and address setting are correct by a quick check run function.

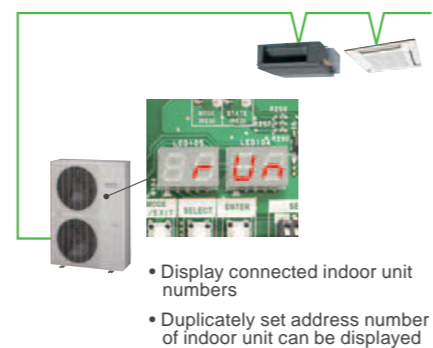

Rating Capacity range	HP	4	5	6
Model name		AJYA40LALH	AJYA45LALH	AJYA54LALH
Maximum Connectable Indoor Unit		7	8	9
Power source	V/∅/Hz	230/1/50	230/1/50	230/1/50
Capacity	Cooling	12.1	14.0	15.5
	Heating	13.6	16.0	18.0
Input power	Cooling	3.25	3.89	4.49
	Heating	3.17	3.81	4.56
EER	Cooling	3.72	3.60	3.45
	Heating	4.29	4.20	3.95
Air flow rate	m <sup>3</sup> /h	6,200	6,400	6,900
Sound pressure level	Cooling	50	51	53
	Heating	52	53	55
Heat exchanger fin		Blue fin	Blue fin	Blue fin
Dimensions	Height	mm	1,334	1,334
	Width	mm	970	970
	Depth	mm	370	370
Weight	kg	117	117	117
Refrigerant charge	kg	4.8	5.3	5.3
Connection pipe diameter	Liquid	mm	∅9.52	∅9.52
	Gas	mm	∅15.88	∅15.88
Total pipe length	m	120	120	120
Max. height difference	m	30	30	30
Operation range	Cooling	°C	-5 to 46	-5 to 46
	Heating	°C	-20 to 21	-20 to 21

Note : Specifications are based on the following conditions.  
 Cooling : Indoor temperature of 27°CDB / 19°CWB, and outdoor temperature of 35°CDB / 24°CWB.  
 Heating : Indoor temperature of 20°CDB / (15°CWB), and outdoor temperature of 7°CDB / 6°CWB.  
 Pipe length : 7.5 m; Height difference between outdoor unit and indoor unit : 0 m.  
 The protective function may work when using it outside the operation range.

#### Dimensions

(Unit : mm)

Model : AJYA40LALH / AJYA45LALH / AJYA54LALH

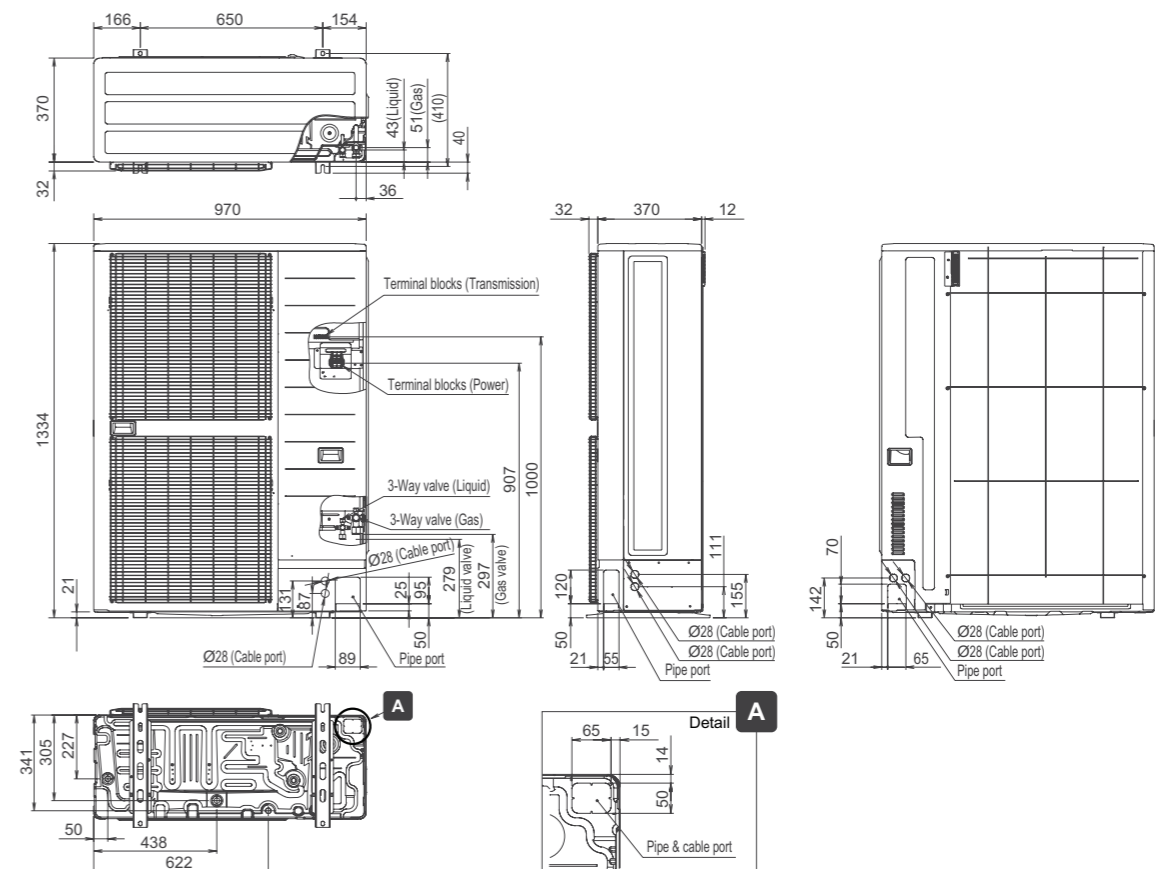

# Heat Pump for Small Capacity Type

AIRSTAGE™ J-IIS

Fujitsu General provides air conditioning systems for a wide range of applications from small office buildings and stores to large houses.



4, 5, 6HP

## System Outline

### Space saving and low sound level design

Economical individual air conditioning is realized by ALL-DC technology, large capacity DC twin rotary compressor, and 3-row heat exchanger though the size is compact.

### Flexible systems for homes, shops, small-size buildings air conditioning

Due to compact size design and flexible piping design, J-IIS series can be installed easily at the place where the installation space is limited such as homes, shops, and small offices. Multiple indoor units of various capacities and types can be connected.



## Features

Heat Pump for Small Capacity Type **AIRSTAGE™ J-IIS**

### Small and light weight outdoor unit

This model is much more compact than conventional 6HP comparable outdoor units. Even when installed on the balcony it fits within the height of the fence. The compact size with a height of less than 1 m allows it to be installed under windows and in tight spaces



Model / 6HP class

Height difference  
**998 mm**  
▲ 25%

Light weight  
**87 kg**  
▲ 26%

It Can be Easily Carried and Installed Obscure Place

## Advanced high efficiency technology

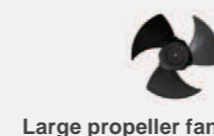

**Large propeller fan**  
High performance and low noise realized by large propeller and optimization of angle.



**DC fan motor**  
Miniaturized, low noise, high efficiency, multi-stage DC fan motor is mounted.

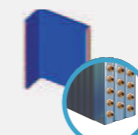

**Large heat exchanger**  
Heat exchange performance is substantially improved by mounting of 3-row large heat exchanger.

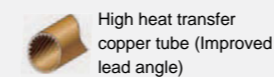

High heat transfer copper tube (Improved lead angle)

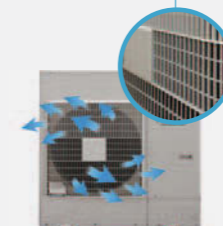

**Smooth airflow grille**  
This grille was aerodynamically designed for good efficiency with little blow loss.



**DC inverter control**  
Efficiency is improved by mounting of new active filter module.

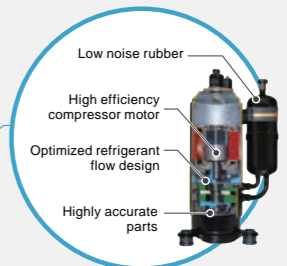

**Compact and high performance DC twin rotary compressor**  
Efficiency in all load regions is good. Especially good performance from low to medium at normal operation.

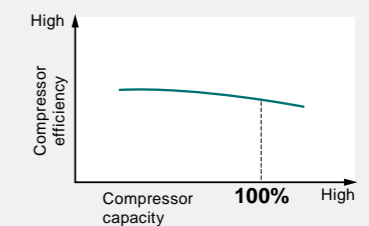

Features

**Long piping length**

Our advanced refrigerant control technology allows us to achieve a total refrigerant piping length of 80 m. This opens up new possibilities in system design.

Total pipe length  
**Max. 80 m**

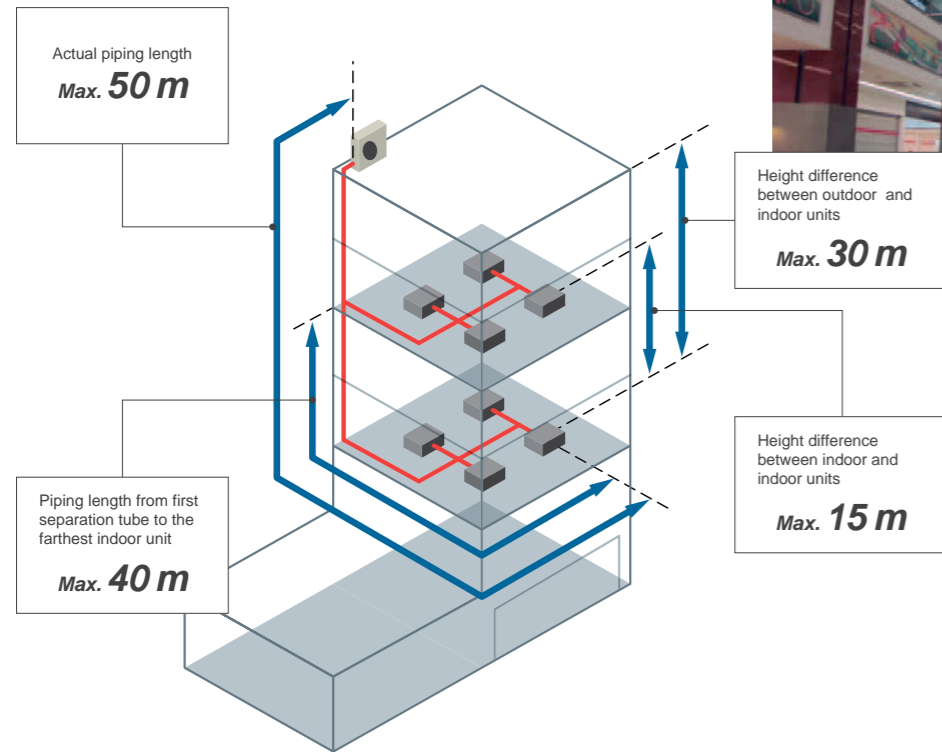

**More Comfort**

**Non-stop oil recovery operation**

A comfortable room condition is maintained during oil recovery mode because the product continues to operate without stopping the cooling or heating operation.

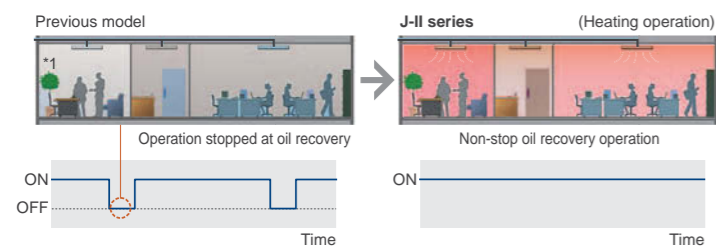

**Easier Installation**

**Connection check function** : Possible to confirm whether wiring connection and address setting are correct by a quick check run function.

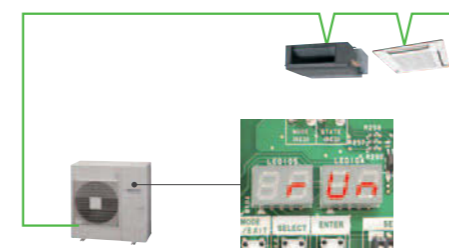

- Display connected indoor unit numbers
- Duplicately set address number of indoor unit can be displayed

Specifications

Heat Pump for Small Capacity Type **AIRSTAGE J-II**S

Rating capacity range	HP	4	5	6
Model name		AJY040LCLAH	AJY045LCLAH	AJY054LCLAH
Maximum connectable indoor unit		7	8	8
Power source	V/∅/Hz	230/1/50	230/1/50	230/1/50
Capacity	Cooling	12.1	14.0	15.1
	Heating	13.6	16.0	16.5
Input power	Cooling	3.44	4.43	5.32
	Heating	3.09	3.93	4.26
EER	Cooling	3.52	3.16	2.84
COP	Heating	4.40	4.07	3.87
Airflow rate	m <sup>3</sup> /h	4,040	4,200	4,200
Sound Pressure level	Cooling	51	53	54
	Heating	54	55	56
Heat exchanger fin		Blue fin	Blue fin	Blue fin
Dimensions	Height	mm	998	998
	Width	mm	970	970
	Depth	mm	370	370
Weight	kg	86	86	87
Refrigerant charge	kg	4.0	4.0	4.0
Connection	Liquid	mm	∅9.52	∅9.52
	Gas	mm	∅15.88	∅15.88
Total pipe length	m	80	80	80
Max. Height difference	m	30	30	30
Operation Range	Cooling	°C	-5 to 46	-5 to 46
	Heating	°C	-20 to 21	-20 to 21

Note : Specifications are based on the following conditions.  
 Cooling : Indoor temperature of 27°CDB / 19°CWB, and outdoor temperature of 35°CDB / 24°CWB.  
 Heating : Indoor temperature of 20°CDB / (15°CWB), and outdoor temperature of 7°CDB / 6°CWB.  
 Pipe length : 7.5 m ; Height difference between outdoor unit and indoor unit : 0 m.  
 The protective function may work when using it outside the operation range.

Dimensions

(Unit : mm)

Model : AJY040LCLAH / AJY045LCLAH / AJY054LCLAH

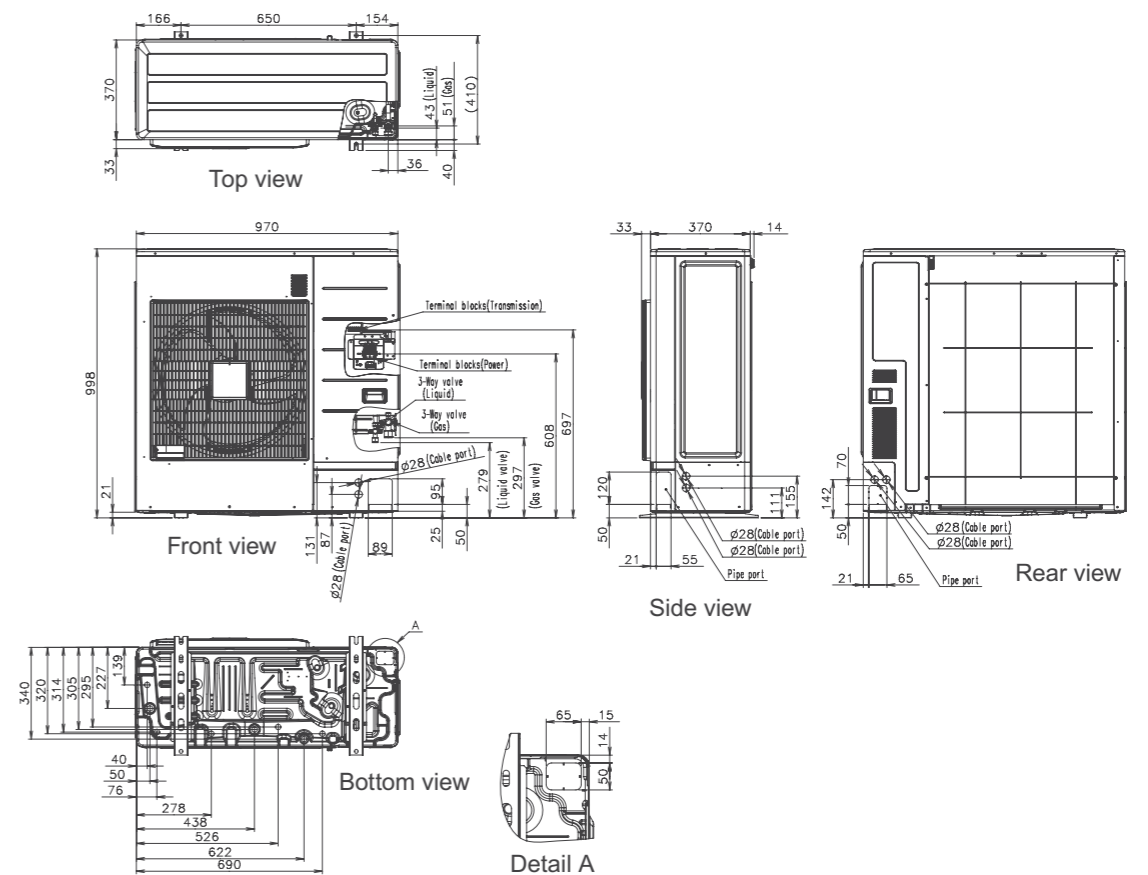

**Indoor Unit Lineup**

12 Types, 58 Models, Capacity range from 1.1 kW to 25.0 kW

Capacity range (kW)		1.1	2.2	2.8	3.6	4.5	5.6	7.1	9.0	10.0	11.2	12.5	14.0	18.0	22.4	25.0
Model code		4	7	9	12	14	18	24	30	34	36	45	54	60	72	90
Cassette	Compact Cassette															
	Cassette															
Duct	Low Static Pressure Duct															
	Slim Duct (With drain pump)															
	Medium Static Pressure Duct															
	High Static Pressure Duct															
Floor	Floor (*Same as Ceiling models)															
	Concealed Floor (*Same as Low Static Pressure Duct models)															
	Slim Concealed Floor (*Same as Slim Duct models)															
Ceiling	Ceiling															
Wall Mounted	Wall Mounted															
	Wall Mounted (EEV external)															

\*: ARXC60/72/90GATH cannot be connected to J-IIS and J-II series.



**Indoor Units Specifications**

**Compact Cassette**



Model name		AUXB04GALH	AUXB07GALH	AUXB09GALH	AUXB12GALH	AUXB14GALH	AUXB18GALH	AUXB24GALH
Power source	V/Ø/Hz	230/1/50						
Capacity	Cooling	1.1	2.2	2.8	3.6	4.5	5.6	7.1
	Heating	1.3	2.8	3.2	4.1	5.0	6.3	8.0
Input power	W	23	25	25	29	35	36	84
Airflow rate	High	530	540	550	600	680	710	1,030
	Med	420/450*1	450	450	530	590	580	830
	Low	300/350*1	350	350	390	390	400	450
Sound pressure level	High	34	34	35	37	38	41	50
	Med	28/30*1	30	30	34	34	35	44
	Low	21/25*1	25	25	27	27	27	30
Dimensions (H x W x D)	mm	245 x 570 x 570						
Weight	kg	15						17
Connection pipe diameter	Liquid (Flare)	ø6.35						ø9.52
	Gas (Flare)	ø12.70						ø15.88
	Drain hose	VP [ø25 (I.D.) ; ø32 (O.D.)]						
Cassette Grille	Model name	UTG-UFYC-W						
	Dimensions (H x W x D)	50 x 700 x 700						
	Weight	2.6						

Note : Specifications are based on the following conditions. Cooling : Indoor temperature of 27°CDB / 19°CWB, and outdoor temperature of 35°CDB / 24°CWB. Heating : Indoor temperature of 20°CDB / (15°CWB), and outdoor temperature of 7°CDB / 6°CWB. Pipe length : 7.5 m; Height difference between outdoor unit and indoor unit : 0 m. Voltage : 230 [V]. \*1: This value is under cooling operation.

**Cassette**



Model name		AUXD18GALH	AUXD24GALH	AUXA18GALH	AUXA24GALH	AUXA30GALH	AUXA34GALH	AUXA36GALH	AUXA45GALH	AUXA54GALH
Power source	V/Ø/Hz	230/1/50								
Capacity	Cooling	5.6	7.1	5.6	7.1	9.0	10.0	11.2	12.5	14.0
	Heating	6.3	8.0	6.3	8.0	10.0	11.2	12.5	14.0	16.0
Input power	W	39	46	51	51	59	77	80	99	119
Airflow rate	High	1,150	1,280	1,420	1,420	1,600	1,750	1,800	1,900	2,000
	Med	940	1,040	1,230	1,230	1,300	1,300	1,300	1,370	1,370
	Low	870	870	1,100/1,000*1	1,100/1,000*1	1,100	1,100	1,100	1,100	1,100
Sound pressure level	High	36	38	40	40	40	43	44	46	47
	Med	30	33	36	36	38	38	38	39	39
	Low	29	29	33/31*1	33/31*1	33	33	33	33	33
Dimensions (H x W x D)	mm	246 x 840 x 840		288 x 840 x 840						
Weight	kg	22		27						
Connection pipe diameter	Liquid (Flare)	ø9.52								
	Gas (Flare)	ø15.88								
	Drain hose	VP25 [ø25 (I.D.) ; ø32 (O.D.)]								
Cassette Grille	Model name	UTG-UGYA-W								
	Dimensions (H x W x D)	50 x 950 x 950								
	Weight	5.5								

Note : Specifications are based on the following conditions. Cooling : Indoor temperature of 27°CDB / 19°CWB, and outdoor temperature of 35°CDB / 24°CWB. Heating : Indoor temperature of 20°CDB / (15°CWB), and outdoor temperature of 7°CDB / 6°CWB. Pipe length : 7.5 m; Height difference between outdoor unit and indoor unit : 0 m. Voltage : 230 [V]. \*1: This value is "cooling operation / heating operation".

**Low Static Pressure Duct / Concealed Floor**



Model name		ARXB07GALH	ARXB09GALH	ARXB12GALH	ARXB14GALH	ARXB18GALH
Power source	V/Ø/Hz	230/1/50				
Capacity	Cooling	2.2	2.8	3.6	4.5	5.6
	Heating	2.8	3.2	4.0	5.0	6.3
Input power	W	46	55	63	90	96
Airflow rate	High	370	440	590	800	890
	Med	310	370	500	750	810
	Low	280	340	450	700	730
Static pressure range	Pa	0 to 50	0 to 50	0 to 50	0 to 50	0 to 50
Standard static pressure	Pa	25	25	25	25	25
Sound pressure level	High	29	31	30	33	36
	Med	26	29	28	32	34
	Low	24	27	25	30	30
Dimensions (H x W x D)	mm	217 x 663 x 595		217 x 953 x 595		
Weight	kg	15		22	23	
Connection pipe diameter	Liquid (Flare)	ø6.35				ø9.52
	Gas (Flare)	ø12.70				ø15.88
	Drain hose	VP25 [ø25 (I.D.) ; ø32 (O.D.)]				

Note : Specifications are based on the following conditions. Cooling : Indoor temperature of 27°CDB / 19°CWB, and outdoor temperature of 35°CDB / 24°CWB. Heating : Indoor temperature of 20°CDB / (15°CWB), and outdoor temperature of 7°CDB / 6°CWB. Pipe length : 7.5 m; Height difference between outdoor unit and indoor unit : 0 m.

**Slim Duct / Slim Concealed Floor**



Model name		ARXD04GALH	ARXD07GALH	ARXD09GALH	ARXD12GALH	ARXD14GALH	ARXD18GALH	ARXD24GALH	
Power source	V/Ø/Hz	230/1/50							
Capacity	Cooling	1.1	2.2	2.8	3.6	4.5	5.6	7.1	
	Heating	1.3	2.8	3.2	4.0	5.0	6.3	8.0	
Input power	W	40	44	50	54	92	83	122	
Airflow rate	High	510	550	600	600	800	940	1,330	
	Med	400/470*1	490	550	510	710	840	1,240	
	Low	320/440*1	440	480	450	610	750	1,100	
Static pressure range	Pa	0 to 90	0 to 90	0 to 90	0 to 90	0 to 90	0 to 90	0 to 50	
Standard static pressure	Pa	25	25	25	25	25	25	25	
Sound pressure level	High	26	28	29	30	34	34	35	
	Med	21/25*1	25	26	27	32	32	32	
	Low	20/22*1	22	24	24	28	28	29	
Dimensions (H x W x D)	mm	198 x 700 x 620						198 x 900 x 620	198 x 1,100 x 620
Weight	kg	17		18			22	26	
Connection pipe diameter	Liquid (Flare)	ø6.35						ø9.52	
	Gas (Flare)	ø12.70						ø15.88	
	Drain hose	VP25 [ø25 (I.D.) ; ø32 (O.D.)]							

Note : Specifications are based on the following conditions. Cooling : Indoor temperature of 27°CDB / 19°CWB, and outdoor temperature of 35°CDB / 24°CWB. Heating : Indoor temperature of 20°CDB / (15°CWB), and outdoor temperature of 7°CDB / 6°CWB. Pipe length : 7.5 m; Height difference between outdoor unit and indoor unit : 0 m. \*1: This value is under cooling operation.

**Medium Static Pressure Duct**



Model name		ARXA24GBLH	ARXA30GBLH	ARXA36GBLH	ARXA45GBLH
Power source	V/Ø/Hz	230/1/50			
Capacity	Cooling	7.1	9.0	11.2	12.5
	Heating	8.0	10.0	12.5	14.0
Input power	W	94	108	194	240
Airflow rate	High	1,280	1,410	1,840	1,970
	Med	990	1,280	1,600	1,860
	Low	840	1,150	1,470	1,640
Static pressure range	Pa	0 to 150	0 to 150	0 to 150	0 to 150
Standard static pressure	Pa	40	50	50	60
Sound pressure level	High	31	34	37	41
	Med	27	32	35	38
	Low	23	29	33	36
Dimensions (H x W x D)	mm	270 x 1,135 x 700			
Weight	kg	36		40	
Connection pipe diameter	Liquid (Flare)	ø9.52			
	Gas (Flare)	ø15.88		ø19.05	
	Drain hose	VP25 [ø25 (I.D.) ; ø32 (O.D.)]			

Note : Specifications are based on the following conditions. Cooling : Indoor temperature of 27°CDB / 19°CWB, and outdoor temperature of 35°CDB / 24°CWB. Heating : Indoor temperature of 20°CDB / (15°CWB), and outdoor temperature of 7°CDB / 6°CWB. Pipe length : 7.5 m; Height difference between outdoor unit and indoor unit : 0 m.

**Indoor Units Specifications**

High Static Pressure Duct

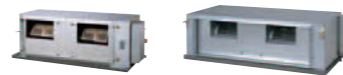

Model name		ARXC36GBTH	ARXC45GATH	ARXC60GATH*	ARXC72GBTH*	ARXC90GBTH*
Power source		230/1/50				
Capacity	Cooling	11.2	12.5	18.0	22.4	25.0
	Heating	12.5	14.0	20.0	25.0	28.0
Input power		W				
Airflow rate	High	1,990	3,500	3,500	3,900	4,300
	Med	1,680	3,000	3,000	3,300	4,000
	Low	1,330	2,460	2,460	3,000	3,500
Static pressure range		Pa				
Standard static pressure		100				
Sound pressure level	High	42	49	49	47	48
	Med	36	45	45	43	46
	Low	32	42	42	40	44
Dimensions (H x W x D)		400 x 1,050 x 500			450 x 1,587 x 700	
Weight		40	46	84	84	84
Connection pipe diameter	Liquid (Flare)	ø9.52 (Flare)			ø12.70 (Brazing)	
	Gas (Flare)	ø19.05 (Flare)			ø22.22 (Brazing)	
	Drain hose	VP25 [ø25 (I.D.) ; ø32 (O.D.)]				

Note : Specifications are based on the following conditions. Cooling : Indoor temperature of 27°CDB / 19°CWB, and outdoor temperature of 35°CDB / 24°CWB. Heating : Indoor temperature of 20°CDB / (15°CWB), and outdoor temperature of 7°CDB / 6°CWB. Pipe length : 7.5 m; Height difference between outdoor unit and indoor unit : 0 m.

Floor / Ceiling



Model name		ABYA12GATH	ABYA14GATH	ABYA18GATH	ABYA24GATH
Power source		230/1/50			
Capacity	Cooling	3.6	4.5	5.6	7.1
	Heating	4.0	5.0	6.3	8.0
Input power		W			
Airflow rate	High	660	780	1,000	1,000
	Med	570	640	720	820
	Low	490	550	580	680
Sound pressure level	High	36	40	46	47
	Med	32	36	39	42
	Low	28	34	35	37
Dimensions (H x W x D)		199 x 990 x 655			
Weight		25	26	26	27
Connection pipe diameter	Liquid (Flare)	ø6.35			ø9.52
	Gas (Flare)	ø12.70			ø15.88
	Drain hose	VP25 [ø25 (I.D.) ; ø32 (O.D.)]			

Note : Specifications are based on the following conditions. Cooling : Indoor temperature of 27°CDB / 19°CWB, and outdoor temperature of 35°CDB / 24°CWB. Heating : Indoor temperature of 20°CDB / (15°CWB), and outdoor temperature of 7°CDB / 6°CWB. Pipe length : 7.5 m; Height difference between outdoor unit and indoor unit : 0 m. Voltage : 230 [V].

Ceiling



Model name		ABYA30GATH	ABYA36GATH	ABYA45GATH	ABYA54GATH
Power source		230/1/50			
Capacity	Cooling	9.0	11.2	12.5	14.0
	Heating	10.0	12.5	14.0	16.0
Input power		W			
Airflow rate	High	1,630	1,690	2,010	2,270
	Med	1,370	1,400	1,600	1,780
	Low	1,140	1,170	1,230	1,280
Sound pressure level	High	42	45	48	51
	Med	38	38	42	45
	Low	33	34	35	36
Dimensions (H x W x D)		240 x 1,660 x 700			
Weight		46	48	48	48
Connection pipe diameter	Liquid (Flare)	ø9.52			ø9.52
	Gas (Flare)	ø15.88			ø19.05
	Drain hose	VP25 [ø25 (I.D.) ; ø32 (O.D.)]			

Note : Specifications are based on the following conditions. Cooling : Indoor temperature of 27°CDB / 19°CWB, and outdoor temperature of 35°CDB / 24°CWB. Heating : Indoor temperature of 20°CDB / (15°CWB), and outdoor temperature of 7°CDB / 6°CWB. Pipe length : 7.5 m; Height difference between outdoor unit and indoor unit : 0 m. Voltage : 230 [V].

Wall Mounted



Model name		ASYA04GACH	ASYA07GACH	ASYA09GACH	ASYA12GACH	ASYA14GACH	ASYE04GACH	ASYE07GACH	ASYE09GACH	ASYE12GACH	ASYE14GACH
Power source		230/1/50									
Capacity	Cooling	1.1	2.2	2.8	3.6	4.5	1.1	2.2	2.8	3.6	4.5
	Heating	1.3	2.8	3.2	4.1	5.0	1.3	2.8	3.2	4.1	5.0
Input power		W									
Airflow rate	High	450	490	500	560	670	450	490	500	560	680
	Med	370/440*1	450	450	480	490	370/440*1	450	450	480	490
	Low	320/420*1	370/420*1	370/420*1	420	420	300/420*1	370/420*1	370/420*1	420	420
Sound pressure level	High	33	35	36	39	44	32	34	35	38	43
	Med	27/32*1	33	33	35	37	26/31*1	32	32	34	35
	Low	22/31*1	27/31*1	27/31*1	31	32	19/30*1	26/30*1	26/30*1	30	30
Dimensions (H x W x D)		275 x 790 x 215					275 x 790 x 215				
Weight		9					9				
Connection pipe diameter	Liquid (Flare)	ø6.35					ø6.35				
	Gas (Flare)	ø12.70					ø12.70				
	Drain hose	ø13.8(I.D.) ; ø15.8-ø16.7(O.D.)					ø13.8(I.D.) ; ø15.8-ø16.7(O.D.)				
EV Kit (option)		—					UTR-EV09XB		UTR-EV14XB		

Note : Specifications are based on the following conditions. Cooling : Indoor temperature of 27°CDB / 19°CWB, and outdoor temperature of 35°CDB / 24°CWB. Heating : Indoor temperature of 20°CDB / (15°CWB), and outdoor temperature of 7°CDB / 6°CWB. Pipe length : 7.5 m; Height difference between outdoor unit and indoor unit : 0 m. Voltage : 230 [V]. \*1 : This value is under cooling operation.

Wall Mounted



Model name		ASYA18GACH	ASYA24GACH	ASYA30GACH
Power source		230/1/50		
Capacity	Cooling	5.6	7.1	8.0
	Heating	6.3	8.0	9.0
Input power		W		
Airflow rate	High	840	1,100	1,240
	Med	770	910	980
	Low	690	730	770
Sound pressure level	High	41	48	52
	Med	39	43	45
	Low	35	35	35
Dimensions (H x W x D)		320 x 998 x 228		
Weight		15		
Connection pipe diameter	Liquid (Flare)	ø9.52		
	Gas (Flare)	ø15.88		
	Drain hose	ø12 (I.D.) ; ø16 (O.D.)		

Note : Specifications are based on the following conditions. Cooling : Indoor temperature of 27°CDB / 19°CWB, and outdoor temperature of 35°CDB / 24°CWB. Heating : Indoor temperature of 20°CDB / (15°CWB), and outdoor temperature of 7°CDB / 6°CWB. Pipe length : 7.5 m; Height difference between outdoor unit and indoor unit : 0 m. Voltage : 230 [V].

**Control system overview**

User's needs are supported by offering a variety of controls, such as individual control, central control and building management control options.



For All AIRSTAGE™ series

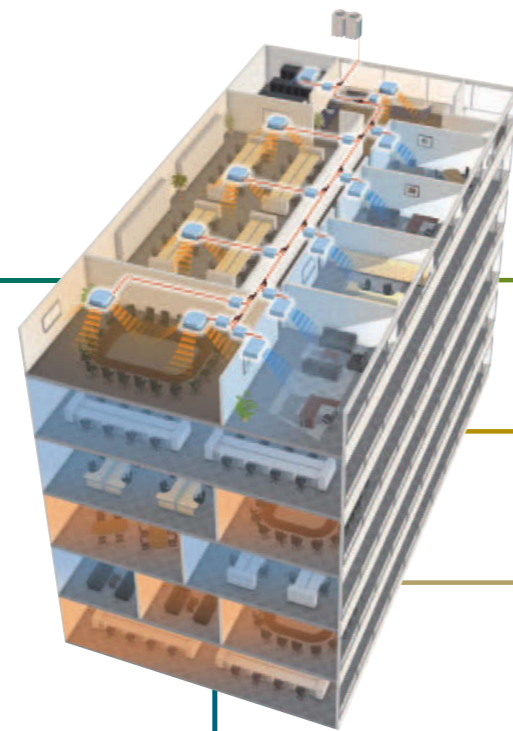

### Air Conditioning Individual Control

- Wired Remote Controller (Touch panel)** UTY-RNRY
- Wired Remote Controller** UTY-RLRY
- Simple Remote Controller** UTY-RSKY
- Simple Remote Controller** UTY-RHKY  
Without operation mode
- Wireless Remote Controller** UTY-LNHY

### Service & Maintenance Tool

#### Web Monitoring System

UTY-AMGX

#### Service Tool

UTY-ASGX

### Air Conditioning Centralized Control

#### System Controller

Software  
UTY-APGX  
UTY-ALGX (Lite edition)

#### Touch Panel Controller

UTY-DTGY

---

#### Central Remote Controller

UTY-DCGY

#### Group Remote Controller

UTY-CCGY

### Converter / Adaptor (for external device)

- BACnet® Gateway** UTY-ABGX (Software)  
USB Adaptor \*2 (Field supplied)
- Network Converter (BMS/LONWORKS®)** UTY-VLGX
- KNX® Interface** FJ-RC-KNX-1i
- MODBUS® Interface** FJ-RC-MBS-1
- Wireless LAN Interface** FJ-RC-WIFI-1
- External Switch Controller** UTY-TEKX  
Card-key (Field supplied)

### BMS/BAS \*1

### BMS, Home automation system

Internet device

### Converter / Adaptor (for system expansion)

- Network Converter** UTY-VGGXZ1  
Single split
- Signal Amplifier** UTY-VSGXZ1  
Extended VRF network system

\*1. BMS/BAS: Building Management System/Building Automation System  
\*2. USB Adaptor: Echelon® U10 USB Network Interface

Comparison table of Controllers

Item	Wired Remote Controller (Touch panel)	Wired Remote Controller	Simple Remote Controller	Simple Remote Controller <sup>*1</sup>	Wireless Remote Controller	Group Remote Controller	Central Remote Controller	Touch Panel Controller	System Controller Lite (Software)	System Controller (Software)	
Model name	UTY-RNRY	UTY-RLRY	UTY-RSKY	UTY-RHKY	UTY-LNHY	UTY-CGGY	UTY-DCGY	UTY-DTGY	UTY-ALGX	UTY-APGX	
Max. controllable remote controller groups	1	1	1	1	1	8	100	400	400	1600	
Max. controllable indoor units	16	16	16	16	16	128	100	400	400	1600	
Max. controllable groups	-	-	-	-	-	-	16	400	400	1600	
Air conditioning control function	On / Off	●	●	●	●	●	●	●	●	●	
	Operation mode setting	●	●	●	-	●	●	●	●	●	
	Fan speed setting	●	●	●	●	●	●	●	●	●	
	Room temp. setting	●	●	●	●	●	●	●	●	●	
	Room temp. set point limitation	●	●	-	-	-	●	●	●	●	
	Test operation	●	●	●	-	●	-	●	●	-	
	Up/down air direction flap setting	●	●	-	-	●	-	●	●	●	
	Right/left air direction flap setting	●	●	-	-	●	-	●	●	●	
	Group setting	-	-	-	-	-	●	●	●	●	
	RC prohibition	-	-	-	-	-	●	●	●	●	
Display	Anti freeze setting	●	-	-	-	-	●	●	●	●	
	Economy mode setting	●	●	-	-	●	-	●	●	●	
	Error	●	●	●	●	-	●	●	●	●	
	Defrosting	●	●	●	●	-	-	●	●	●	
	Current time	●	●	-	-	●	●	●	●	●	
	Day of week	●	●	-	-	-	-	●	●	●	
	R.C. prohibition	●	●	●	●	-	●	●	●	●	
	Cooling/heating priority	●	●	●	●	-	●	●	●	●	
	Address display	●	●	●	●	-	●	●	●	●	
	Room temp	●	-	-	-	-	-	-	-	-	
Timer	Multi language	●	-	-	-	-	●	●	●	●	
	Summer time	●	-	-	-	-	●	●	●	●	
	Name registration	●	-	-	-	-	●	●	●	●	
	Backlight	●	-	●	●	-	-	●	●	-	
	2D floor layout / 3D building display	-	-	-	-	-	-	-	-	●	
	Schedule timer	Period	Week	Week	-	-	-	Week	Week	Year	Year
		On/off, Temp, Mode, Times per day	8	4	-	-	-	4	20	20	144
	On/off timer	●	●	-	-	●	-	-	-	-	
	Sleep timer	-	-	-	-	●	-	-	-	-	
	Program timer	-	-	-	-	●	-	-	-	-	
Auto off timer	●	●	-	-	-	-	-	-	-		
Day off	●	●	-	-	-	-	●	●	●		
Min. unit of timer setting (Minutes)	10 • 30	30	30	30	5	10	10	10	10		
Control	Status monitoring system	-	-	-	-	-	●	●	●	●	
	Electricity charge apportionment	-	-	-	-	-	-	-	○	●	
	Error history	●	●	●	●	-	●	●	●	●	
	Emergency stop	-	-	-	-	-	● <sup>*2</sup>	● <sup>*2</sup>	-	-	
	Remote management	-	-	-	-	-	-	-	○	●	
	Energy saving management	-	-	-	-	-	-	-	○	○	
	E-mail notification for malfunction	-	-	-	-	-	-	-	●	●	
Key lock	Child lock	●	●	-	-	-	●	●	●	●	
	Child lock	Child lock	Child lock	-	-	-	Child lock	Password setting	Password setting	Password setting	

\*1 "Operation mode" setting is not available for this model.  
 \*2 This function is available only through external input control.

● : Supported ○ : Optional function  
 - : Not supported yet

**Wired Remote Controller (Touch Panel) : UTY-RNRY**

Easy operation by high-definition large STN-LCD touch panel screen

- Easy finger touch operation with LCD panel
- Built-in weekly/Daily timer(ON/OFF,Temp.,Mode)
- Backlight enables easy operation in a darkened room
- Room temperature display
- Control up to 16 indoor units
- Corresponds to 7 different languages (English, Chinese, French, German, Spanish, Russian, Polish)
- 2-wire type



Max. controllable  
**16**  
 Indoor units

**High performance and compact size**

In addition to the individual control, weekly timer, and various energy saving controls can be realized using one remote controller only.



**Accurate and comfortable control**

Indoor temperature can be detected accurately by the inclusion of a thermo sensor in the body of the wired controller.

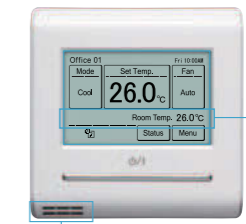

Room temperature sensor

Room temperature display

**Various energy saving control**

**Auto OFF timer**

- The indoor unit automatically is turned off when it reaches to the preset operating time frame.
- The time frame of the "Auto off timer" can be flexibly scheduled.
- Can be set off time 30 to 240 minutes

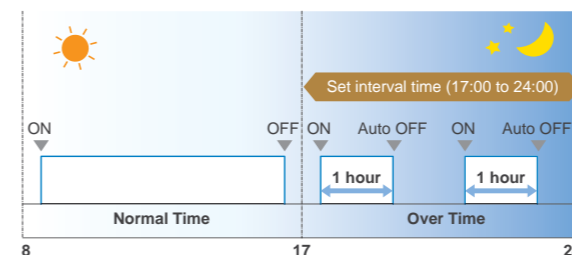

Ex.) At interval time hour (17:00 to 24:00) to prevent forgetting to turn off  
 Set off time : 1 hour

**2 schedules Weekly Timer**

- 2 schedules such as for the summer and winter can be set.
- 8 setting changeable per day of week (Setting items: On/Off, Temperature, Mode, Time)

Schedule 1 (Summer schedule)

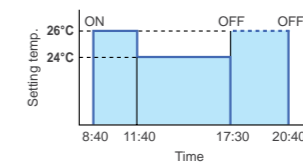

Schedule 2 (Winter schedule)

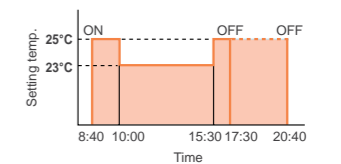

**Set Temperature Auto Return**

The setting temperature automatically returns to the previous setting temperature. The time range in which the set temperature can be changed is 10 to 120 minutes.

**Set Temperature Upper and Lower Limit Setting**

The set temperature range can be set for each operation mode. (Cooling / Heating / Auto)

**Specifications**

Model name	UTY-RNRY
Power Source	DC 12 V
Dimensions (H x W x D) (mm)	120 x 120 x 20.4
Weight (g)	220

DC12 V is supplied by the indoor unit.

Max. controllable  
**16**  
Indoor units

### Wired Remote Controller : UTY-RLRY

- Various timer setup (ON / OFF / WEEKLY) are possible.
- The room temperature can be controlled by detecting the temperature accurately with Built-in thermo sensor.
- When a failure occurs, the error code is displayed.
- Error history. (Last 16 error codes can be accessed.)
- 2-wire type



### High performance and compact size

In addition to the individual control, weekly timer, and various energy saving controls can be realized using only one remote controller.

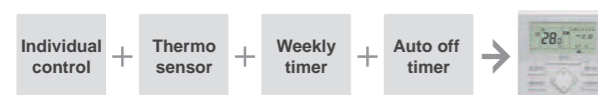

### Auto-off timer

- The indoor unit automatically turns off after a set time has passed.

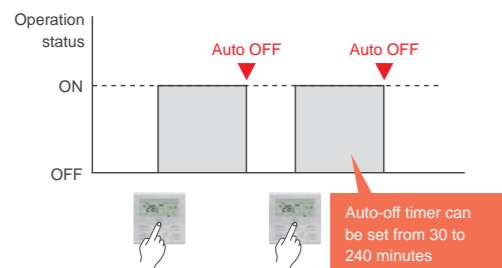

### High visibility and easy operation

- "Mode", "Set Temp", and "Fan" are displayed at large size on the top screen.
- Each function to be set is indicated by an icon.
- Control guide is displayed and operation is simple and straightforward.

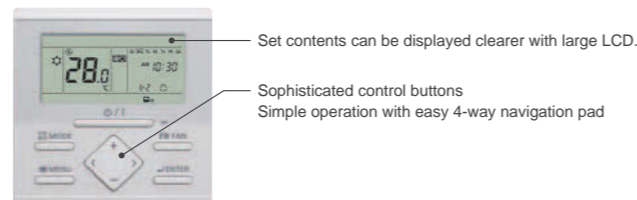

### Set temperature auto return

- The setting temperature automatically returns to the previously set temperature.
- The time range in which the set temperature can be changed is 30 to 120 minutes.

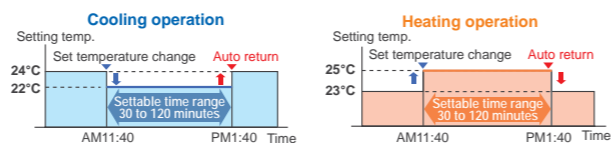

### Weekly timer function

- Not only time setting On / Off, but also setting of the operation mode and set temperature can be set by Weekly timer function.

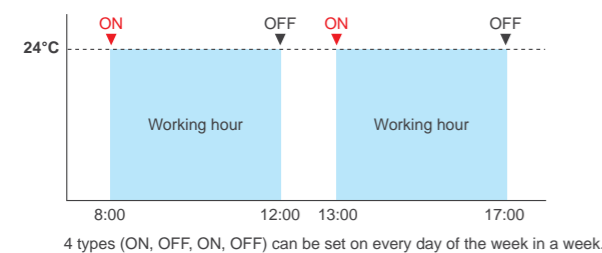

### Set temperature upper and lower limit setting

- The set temperature range can be set for each operation mode. (Cooling / Heating / Auto)

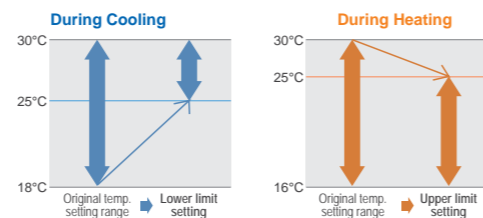

### Specifications

Model name	UTY-RLRY
Power supply	DC 12V
Dimension (H x W x D) (mm)	120 x 120 x 17
Weight (g)	170

\* DC12V is supplied by indoor unit.

### Simple Remote Controller :

UTY-RSKY / UTY-RHKY (Without operation mode)

Max. controllable  
**16**  
Indoor units

Compact remote controller provides access to basic functions

- Up to 16 indoor units can be controlled with one remote controller.
- Suitable for hotels or offices as it is easily operated with no complex functions.
- 3-wire type



Without operation mode

### Easy-to-use operation

- Provides access to basic operations, such as Start / Stop, Fan control, Operation mode switching, and Room temperature setting.
- A large On / Off button is provided in the centre of the remote controller for easy operation.
- Can be used jointly with other individual control unit.
- Following an error display, diagnostics can be carried out on the controller.

### Simple installation

Can be mounted on the European Mounting Box (Installation dimension: 60mm) or the JIS Built-in Box (Installation dimension: 83.5mm).



### Backlight

- Backlight enables easy operation in a darkened room.
- Backlight activates during all button operations, and lasts 10 seconds in Operation mode and 5 seconds in stop mode after a button is pressed.



### Functions

Model	UTY-RSKY	UTY-RHKY
Operation		
On / Off	●	●
Fan control	●	●
Operation mode	●	— *1
Room temp. setting	●	●

\*1: "Operation mode" setting is not available. It is recommend to use together with other type controller.

### Specifications

Model name	UTY-RSKY	UTY-RHKY
Power Source	DC 12 V	DC 12 V
Dimensions (H x W x D) (mm)	120 x 75 x 14	120 x 75 x 14
Weight (g)	90	90

DC12 V is supplied by the indoor unit.

**Wireless Remote Controller : UTY-LNHY**



Max. controllable  
**16**  
Indoor units

Selectable  
**4**  
daily timers

Simple and sophisticated operations with a choice of 4 daily timers

•A single controller controls up to 16 indoor units.

**Built-in timers**

Select from 4 different timer programs:

On / Off / Program / Sleep

**Program timer:** The program timer operates the ON and OFF timer once within a 24 hour period.

**Sleep timer:** The sleep timer function automatically corrects the set temperature according to the time setting to prevent excessive cooling or heating during sleep hours.

**Easy installation and operation**

•Code selector switch prevents indoor unit mix-up. (Up to 4 codes can be set.)

•Wide and precise transmitting range.

**System addressing**

During installation work, system addressing can be performed using the Wireless Remote Controller, thus eliminating manual switch setting.

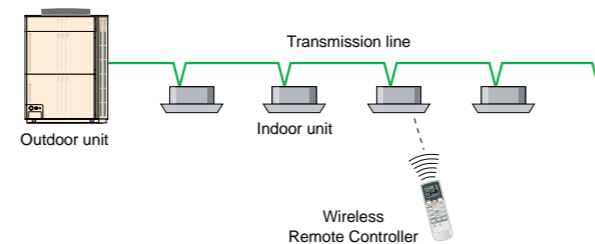

**IR Receiver Unit : UTB-YWC**

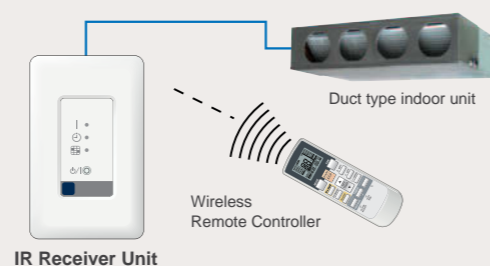

Necessary to control for all duct type by Wireless Remote Controller

**IR Receiver Unit : UTY-LRHYB1**

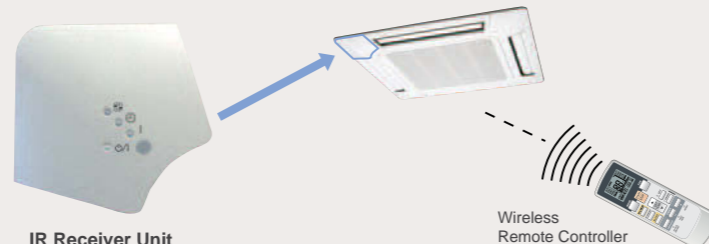

Cassette type indoor unit can be controlled with Wireless Remote Controller

**Specifications**

Model name	UTY-LNHY	UTB-YWC	UTY-LRHYB1
Battery	1.5 V (R03 / LR03 / AAA) x 2	DC 5 V	DC 5 V
Dimensions (H x W x D) (mm)	170 x 56 x 19	145 x 90 x 30	193.9 x 193.9 x 31.2
Weight (g)	85	150	140

DC12 V is supplied by the indoor unit.

**Group Remote Controller : UTY-CGGY**

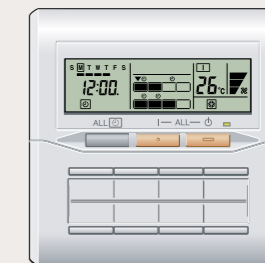

Max. controllable  
**8**  
remote controller groups

Max. controllable  
**64**  
group R.C. in a VRF network system

Group control of indoor units with simple operation

- Up to 8 remote controller groups can be controlled by one Group Remote Controller.
- Up to 64 Group Remote Controllers can be connected in one VRF network system.
- Network Converter is required to connect Group Remote Controllers to a VRF network system. (Network Converter allows up to 4 Group Remote Controllers)
- 3-wire type

**Control up to 8 remote controller groups**

•Single Group Remote Controller controls and monitors up to 8 remote controller groups.

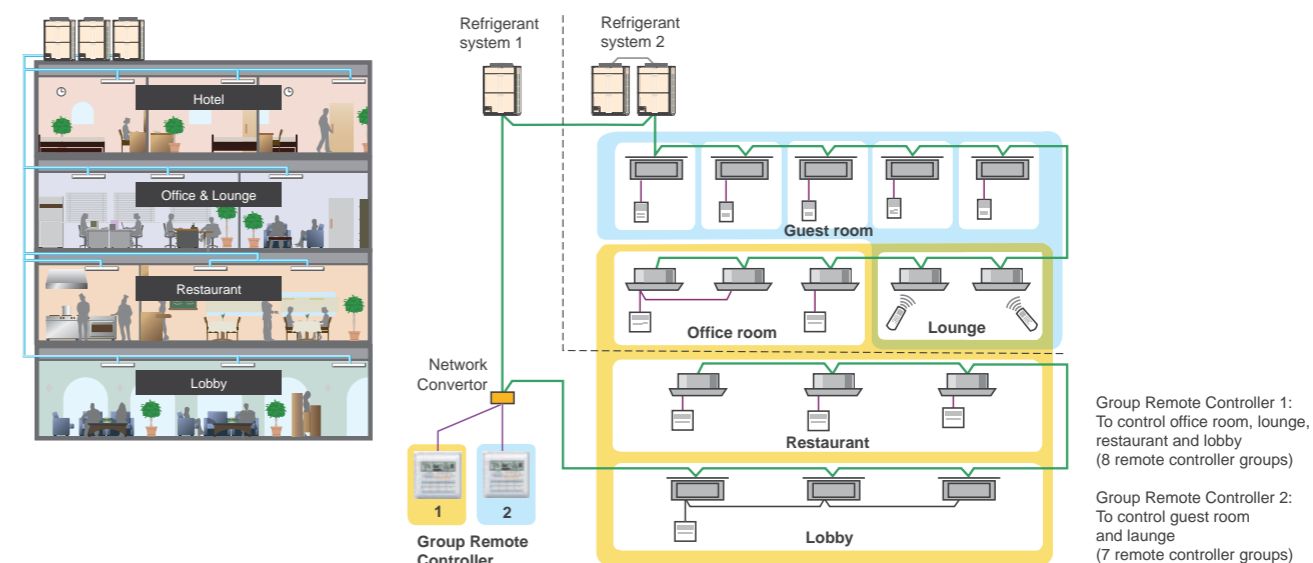

**High performance and compact size**

ON / OFF, Operating mode, Room temperature and Fan speed setting can be controlled / monitored centrally or individually.



**Built-in weekly timers**

The weekly timer is provided as a standard function.

1. The timer can be set up for up to 4 times per day. (On / Off, operating mode, set temperature)
2. Allows separate settings for each day of the week.

**Specifications**

Model name	UTY-CGGY
Power Supply	DC 12 V
Dimensions (H x W x D) (mm)	120 x 120 x 18
Weight (g)	200

DC12 V is supplied by the indoor unit.

**Central Remote Controller : UTY-DCGY**

Central Remote Controller fits small- and medium-sized buildings and tenants.

- Individual control and monitor of 100 indoor units
- 5 inch TFT color screen
- High visibility and easy operation
- External input / output contact
- Detachable power supply unit
- Corresponds to 7 different languages like English, Chinese, French, German, Spanish, Russian, Polish.
- 2-wire type



Max. controllable  
**100**  
Indoor units

Max. controllable  
**16**  
groups

**Touch Panel Controller : UTY-DTGY**

- Large-sized 7.5-inch TFT color
- LCD Easy finger touch operation
- Stylish shape and design to suit all application
- No additional component is required for installation
- Up to 400 indoor units can be controlled
- Selectable 2 display types (Icon / List) in monitoring mode
- Corresponds to 7 different languages, English, Chinese, French, German, Spanish, Russian, Polish.
- 2-wire type



Max. controllable  
**400**  
Indoor units

**System overview**

- It allows multiple indoor units grouping (Max.16 groups controlled)
- Interlock with external device

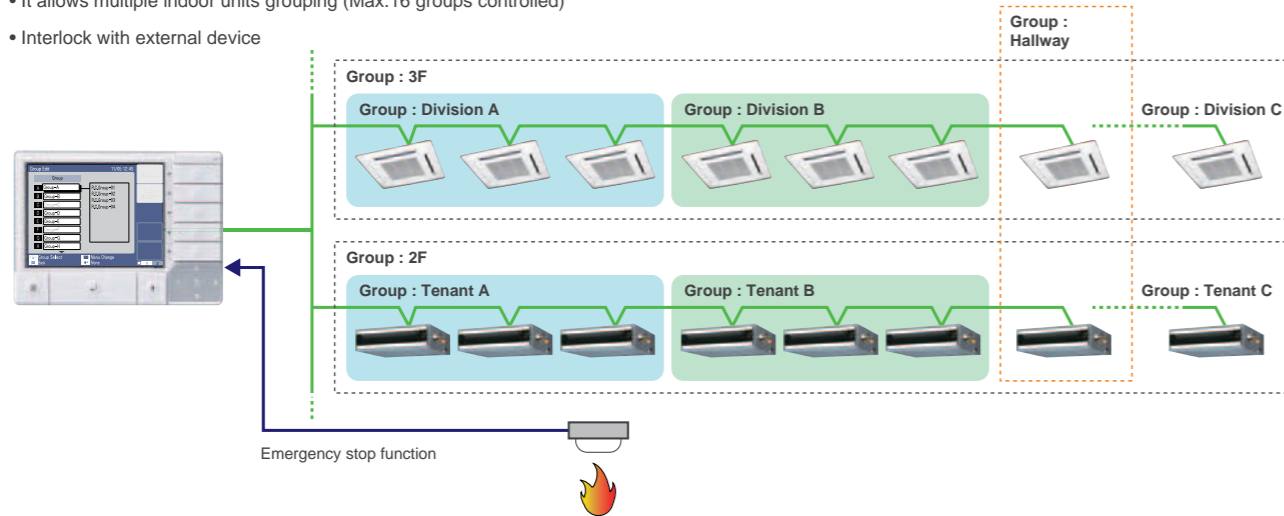

**Easy Installation**

- The control panel and power supply unit can be installed separately.
- For flexibility in installation, the Control panel can be built into the wall or fix on the wall.

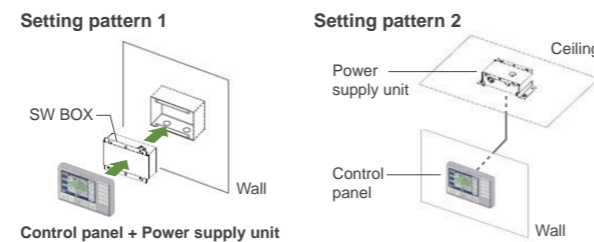

**Functions**

- Diverse control of indoor units
- Weekly timer
- Automatic clock adjustment
- Error history

**Specifications**

Model name	UTY-DCGY	
	Control Panel	Power Supply Unit
Power Supply	DC 5 V	100-240 V, 50-60Hz, Single phase
Dimensions (H x W x D) (mm)	120 x 162 x 25.7	99 x 135 x 39.2
Weight (g)	308	355

**<PACKING LIST>**

Packing List	Control Panel / Power Supply Unit / Connecting cable, etc.
--------------	--

**Easy operation**

- Wide range of simple-to-understand icons
- Operation can be selected using your finger or the dedicated touch pen by pressing the appropriate on-screen icon
- Up-to-date status display
- Background color identifies current control operation blue for monitoring, green for operational control

**Functions**



**Automatic clock adjustment**

The time setting of each controller can be set in batch automatically.

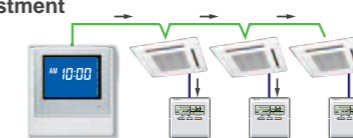

**Versatility**

- **Emergency stop function:** Air conditioner can be turned off through the external input control
- The stored data can be transferred via USB port
- CSV format data edited by PC can be imported to Touch Panel Controller.

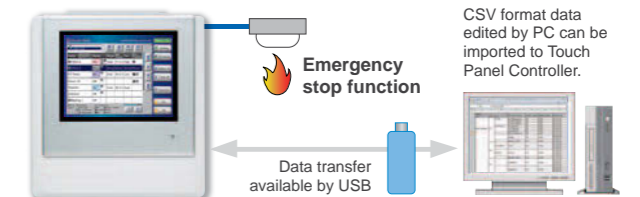

**Easy installation**

- Touch Panel Controller is easily mounted to the wall.
- Flat back surface allows to be installed wherever it is needed.
- No additional component is required for installation.



**System Controller : UTY-APGX** (Software)

System Controller realizes the advanced integrated monitoring & control of VRF network system from small scale buildings to large scale buildings.

- Up to a maximum of 4 VRF network systems, 1600 indoor units, and 400 outdoor units can be controlled.
- In addition to air conditioning precision control function, central remote control, electricity charge calculation, schedule management, and energy saving functions are strengthened and building manager and owner needs are met.
- Corresponds to 7 different languages (English, Chinese, French, German, Spanish, Russian, Polish)

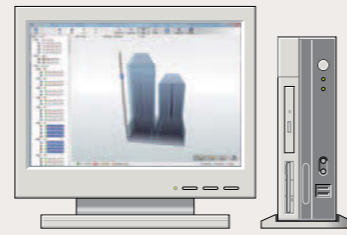

Max. controllable  
**4**  
VRF network systems

Max. controllable  
**400**  
outdoor units

Max. controllable  
**1,600**  
indoor units

**System Controller Lite : UTY-ALGX** (Software)

System Controller Lite has standard functions sufficient for air conditioner management in small and medium scale buildings .

- Up to a maximum of 1 VRF network system, 400 indoor units, and 100 outdoor units can be controlled.
- In addition to air conditioning precision control function, a variety of management software is available as an option to give customers a wide range of choice.
- Corresponds to 7 different languages (English, Chinese, French, German, Spanish, Russian, Polish)

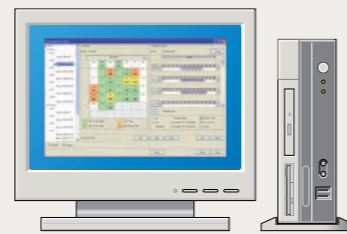

Max. controllable  
**1**  
VRF network systems

Max. controllable  
**100**  
outdoor units

Max. controllable  
**400**  
indoor units

**High visibility and Easy operation**

- **Click & Operate** : The property is shown visually from the perspective most suitable for operation and operated accordingly (Click & Operate). You can select from among the 4 displays of site, building, floor, or list.
- **Freely define groups for batched control** : Indoor units can be freely grouped for simple batched control from a tree menu. Grouping by hierarchal structure, such as by section, division or department is possible.

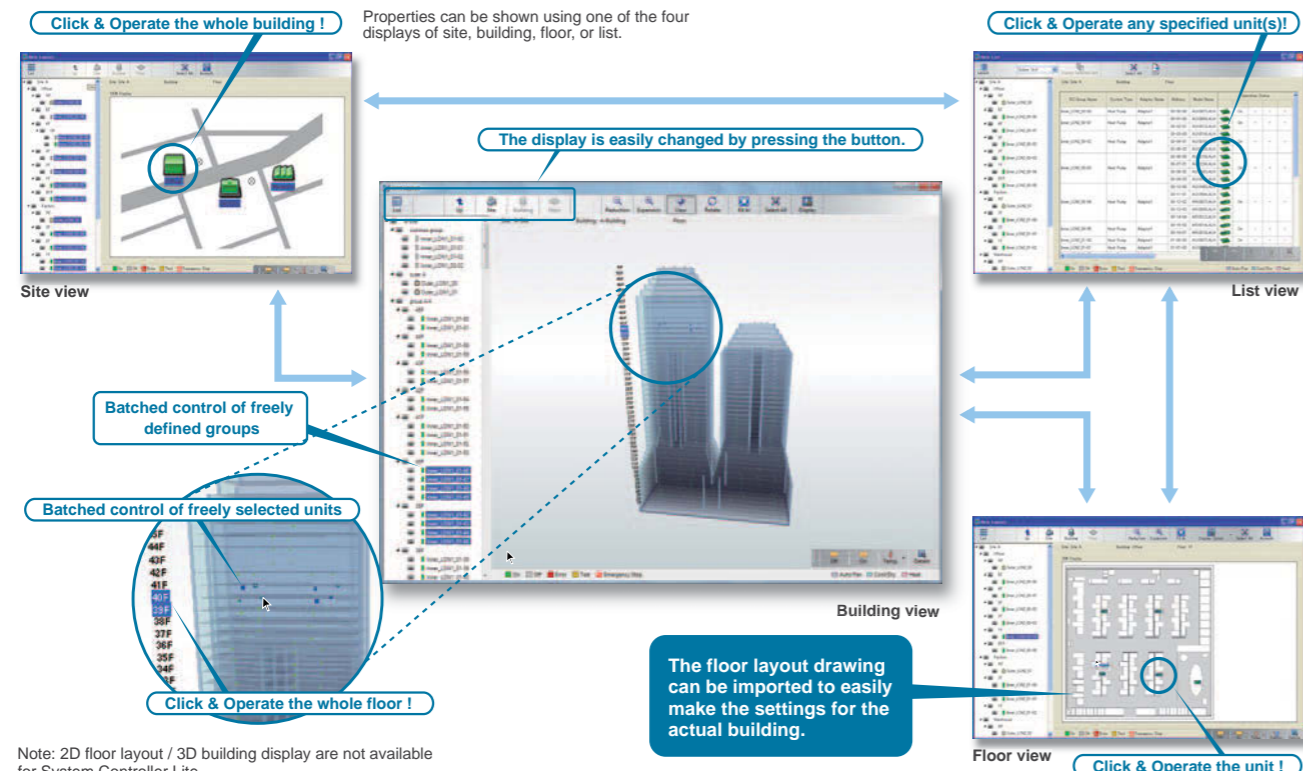

Note: 2D floor layout / 3D building display are not available for System Controller Lite.

**Diverse operation management & Data management** (Standard) for System Controller and System Controller Lite

**Schedule management**

- Annual schedules can be set for each remote controller group / user defined group.
- Start / stop, operating mode, remote controller prohibition, and temperature settings can be set up to 143 times per day at 10 minute intervals for up to 101 configurations for each remote controller group.
- Settings can be made for periods straddling midnight.
- Allows programming of special settings for holidays, including public holidays, for a complete year.
- Low noise operation of outdoor unit can be scheduled.

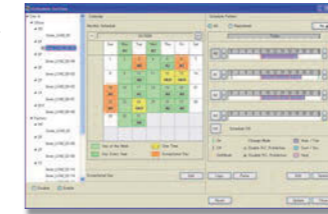

**Error display & E-mail notification**

Error is notified with popup message, audible sound and E-mail real time when error occurs. Error for the past 1 year are logged and can be reviewed later.

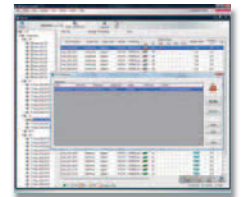

**Operating & control record**

Displays the history of operation status and control.

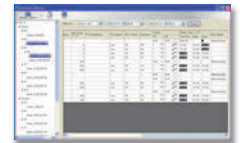

**Diverse control of indoor unit and outdoor unit**

- Indoor unit operation state, operation mode, etc. are displayed
- Indoor unit start / stop and operation mode switching
- Room temperature set point limitation
- Outdoor unit low noise setting



**Remote controller prohibition**

This prohibits changes to the operation mode, temperature, start/stop, etc.



**Data base import/export**

Imports/exports registration data, layout data, and image data. Only the administrator can make this setting.



**Automatic clock adjustment**

The time setting of each controller can be set in batch automatically.

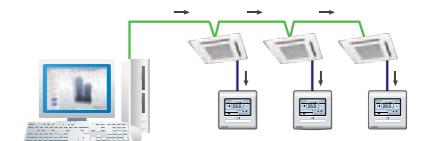

**Electricity charge apportionment** (Standard) for System Controller (Option) for System Controller Lite UTY-PLGXA1

Electricity charge apportionment calculation framework  
Suppose you want to find the power consumed by the air conditioners of each tenant from the electricity charge for each month. With electricity charge apportionment function, used energy apportionment ratio will be provided, calculating in detail the energy consumed by the units used by each tenant. This information is then used to calculate the charges for the electricity consumed for air conditioning by each tenant from the total electricity charges in the bill from the electric power company. (See figure at right)  
The detailed calculation takes into consideration such things as unused rooms and nighttime electricity charges and shows them in a charges calculation sheet.

**System Configuration Example**

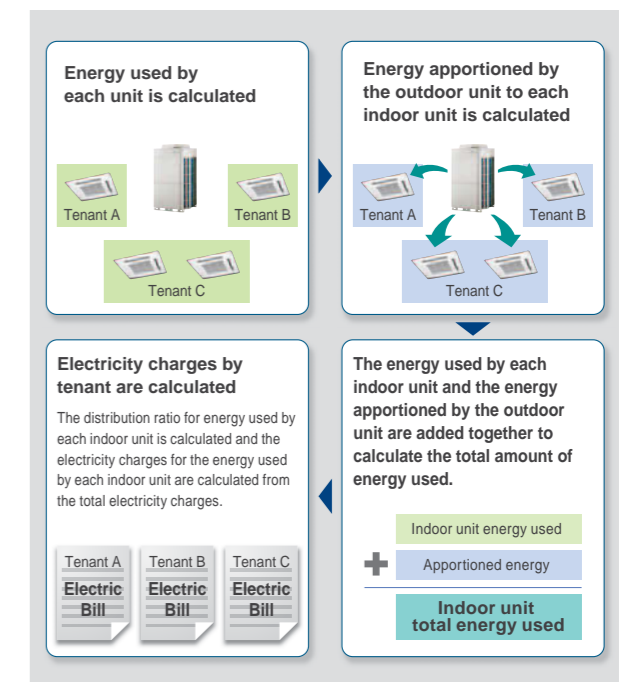
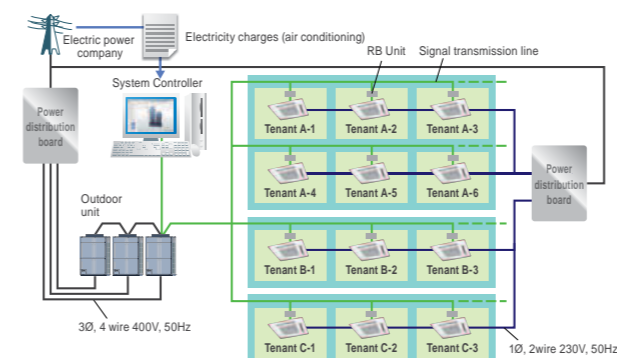



**Remote management** Standard for System Controller  
Option for System Controller Lite UTY-PLGXR1

System Controller may be used on site or remotely over various networks for remote central control. System Controller requires 2 softwares working together. VRF Controller runs on site and communicate with VRF system. VRF Explorer runs remotely and provides user interface and communicate with the VRF Controller. VRF Controller and VRF Explorer program may run in a single PC or in different PCs separated by network. By using VRF Explorer software, one PC can perform central control of 10 VRF system sites with max. 20 buildings per site.

**On site central control**

Max. 4 VRF network systems per site

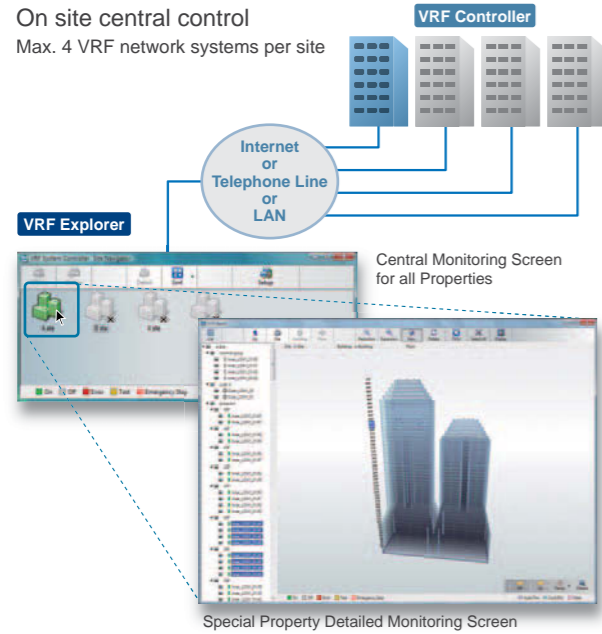

**Remote central control**

1 VRF Explorer can control or monitor up to 10 sites.

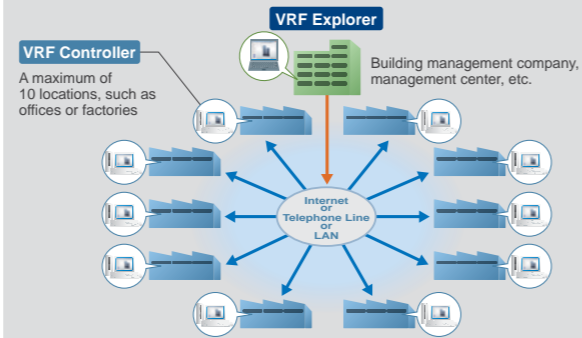

1 VRF Controller can be monitored from any number of VRF Explorers (Up to 5 connections simultaneously).

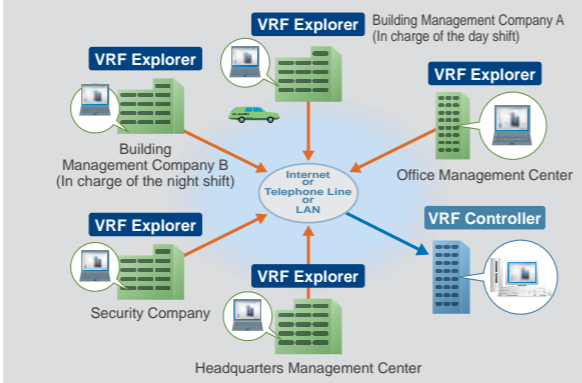

**Energy saving management** Option for System Controller UTY-PEGX  
Option for System Controller Lite UTY-PLGXE1

A variety of energy saving operations can be set and managed depending on the season, weather, and time period. Excellent energy saving operation is performed while keeping users comfortable.

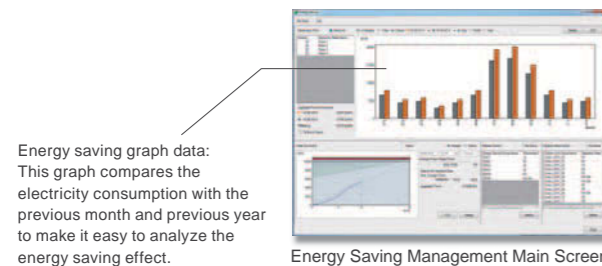

**Peak cut operation**

A power meter is connected to detect the total power consumption while shifting the indoor unit set temperature, set the indoor unit forced thermostat off, and taking other measures to carefully control the power consumed while maintaining comfort and conducting control to maintain the target power consumption set for each time. The indoor units to be controlled can be freely grouped and the control level can be set.

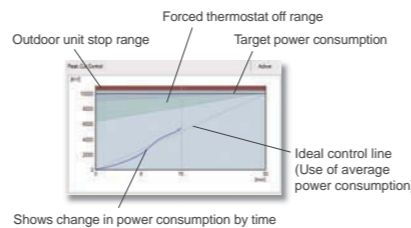

**Indoor unit rotation operation**

The operation of indoor units can be automatically rotated within a group in accordance with the set annual schedule to reduce power consumption while maintaining comfort. The indoor unit operation stoppage rate can be selected.

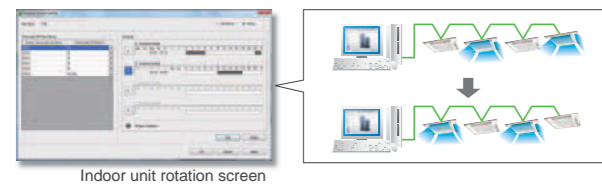

**Outdoor unit capacity save**

Outdoor unit capacity save switches the outdoor unit capability upper limit to suppress power consumption during hot summers and cold winters by averaging the power saving effect of each refrigerant system. You can select from 50% or more of the capacity upper limit.



**FUNCTIONS SUMMARY**

Function	Type	System controller			System controller lite			
		UTY-APGX	<span style="border: 1px solid black; border-radius: 50%; padding: 2px;">Option</span> UTY-PEGX	UTY-ALGX	<span style="border: 1px solid black; border-radius: 50%; padding: 2px;">Option</span> UTY-PLGXR1	<span style="border: 1px solid black; border-radius: 50%; padding: 2px;">Option</span> UTY-PLGXA1	<span style="border: 1px solid black; border-radius: 50%; padding: 2px;">Option</span> UTY-PLGXE1	
System specification	Max. VRF networks supported	4	-	1	-	-	-	
	Max. indoor unit / remote controller groups per VRF network	400	-	400	-	-	-	
	Max. outdoor units per System controller	100	-	100	-	-	-	
	Max. indoor units / remote controller groups per System controller	1600	-	400	-	-	-	
Site supervision	Max. outdoor units per System controller	400	-	100	-	-	-	
	Multi site display	10	-	10	-	-	-	
	Number of building / 1 site	20	-	-	-	-	-	
	Number of floor per 1 site	200	-	-	-	-	-	
	Number of floor per 1 building	50	-	-	-	-	-	
	3D graphical layout view	○	-	-	-	-	-	
	2D graphical layout view	○	-	-	-	-	-	
	List display	○	-	○	-	-	-	
	Tree display	○	-	○	-	-	-	
	Group display	○	-	○	-	-	-	
	Error management	Error notification	○	-	○	-	-	-
		Audible alarm	○	-	○	-	-	-
Error e-mail notification		○	-	○	-	-	-	
History	Error history	○	-	○	-	-	-	
	Operation history	○	-	○	-	-	-	
	Control history	○	-	○	-	-	-	
Operation control	Individual control	On/Off	○	-	○	-	-	
		Operation mode	○	-	○	-	-	
		Room temperature	○	-	○	-	-	
		Fan speed	○	-	○	-	-	
		Air flow direction	○	-	○	-	-	
		Economy mode	○	-	○	-	-	
		Room temperature set point limitation	○	-	○	-	-	
		Test operation	○	-	○	-	-	
		Antifreeze	○	-	○	-	-	
	Individual management	Outdoor unit low noise setting	○	-	○	-	-	
		Remote control prohibition setting	○	-	○	-	-	
		Temperature upper and lower limit setting	○	-	○	-	-	
	Other	Filter sign reset	○	-	○	-	-	
		Memory operation	○	-	○	-	-	
		Pattern operation	○	-	○	-	-	
Schedule	Annual Schedule	○	-	○	-	-		
	Special day setting	○	-	○	-	-		
	On / off per day	72	-	72	-	-		
	On / off per week	504	-	504	-	-		
	Day off	○	-	○	-	-		
	Min. unit of timer setting (Minutes)	10	-	10	-	-		
	Low noise mode Weekly schedule	○	-	○	-	-		
Remote management	Remote monitoring	○	-	-	○	-		
	Remote operation control	○	-	-	○	-		
	Remote function setting	○	-	-	○	-		
Electricity charge apportionment	Apportionment charge/bill calculation	○	-	-	-	○		
	Tenant (block) setting	○	-	-	-	○		
	Common facilities apportionment setting	○	-	-	-	○		
	Rated power consumption allotment setting	○	-	-	-	○		
	Individual calculation at cooling and heating	-	○*	-	-	-		
Energy saving management	Electricity meter supported	-	○	-	-	○		
	Indoor unit rotation	-	○	-	-	○		
	Peak cut control	-	○	-	-	○		
	Outdoor unit capacity save	-	○	-	-	○		
	Record of energy saving operation	-	○	-	-	○		
	Energy saving information	-	○	-	-	○		
	Power consumption monitor	-	○	-	-	○		
Others	Electricity meter supported	-	○	-	-	○		
	Database import/export	○	-	○	-	-		
	Automatic clock adjustment	○	-	○	-	-		
Multi language	7 languages	-	7 languages	-	-			

\*Power calculation application software is necessary, please contact the local FGL representative. ○ : Available. - : Not available.

**Personal computer system requirements**

	System Controller	System Controller Lite
Operating system	<ul style="list-style-type: none"> <li>Microsoft® Windows Vista® Home Premium (32-bit) SP2, Windows Vista® Business (32-bit) SP2</li> <li>Microsoft® Windows® 7 Home Premium (32-bit or 64-bit) SP1, Windows® 7 Professional (32-bit or 64-bit) SP1</li> <li>Microsoft® Windows® 8 (32-bit or 64-bit), Windows® 8 Pro (32-bit or 64-bit)</li> <li>Microsoft® Windows® 8.1 (32-bit or 64-bit), Windows® 8.1 Pro (32-bit or 64-bit)</li> </ul> [Supported languages] English, Chinese, French, German, Russian, Spanish, and Polish	
CPU	Intel® Core™ i3 2 GHz or higher	
Memory	<ul style="list-style-type: none"> <li>2 GB or more (for Windows Vista® and Windows® 7 [32-bit])</li> <li>4 GB or more (for Windows® 7 [64-bit], Windows® 8, and Windows® 8.1)</li> </ul>	
HDD	40 GB or more of free space	
Display	1024 x 768 or higher resolution	
Interface	<ul style="list-style-type: none"> <li>Ethernet port (for getting access to the Internet using LAN) or Modem (for getting access to the Internet using Public Telephone Line)</li> <li>USB ports (Maximum of 6 ports)</li> <li>(Required only for the Server PC that works as VRF Controller)</li> <li>- Maximum of 2 USB ports are required for WibuKey connection</li> <li>- Maximum of 4 USB ports are required for Echelon® U10 USB Network Interface</li> <li>* Maximum number of required USB port depends on the applicable system configuration.</li> </ul>	<ul style="list-style-type: none"> <li>Ethernet port (for getting access to the Internet using LAN) or Modem (for getting access to the Internet using Public Telephone Line)</li> <li>USB ports (Maximum of 5 ports)</li> <li>(Required only for the Server PC that works as VRF Controller)</li> <li>- Maximum of 4 USB ports are required for WibuKey connection</li> <li>- 1 USB port is required for Echelon® U10 USB Network Interface</li> <li>* The maximum number of required USB port depends on the applicable system configuration.</li> </ul>
Graphic accelerator	Microsoft® DirectX® 9.0c compatible	
Software	Adobe® Reader® 9.0 or later	
Optical drive	DVD-ROM drive	

\*Personal computer that satisfies the following system requirements  
 •Echelon® U10 USB Network Interface – TP/FT-10 Channel (Model number: 75010R) (Required for each VRF Network.)

**PACKING LIST**

Type	For System controller			For System controller Lite		
	System Controller	<span style="border: 1px solid black; border-radius: 50%; padding: 2px;">Option</span> Energy manager	System Controller Lite	Remote access	Electricity charge apportionment	Energy saving
Model name	UTY-APGX	UTY-PEGX	UTY-ALGX	UTY-PLGXR1	UTY-PLGXA1	UTY-PLGXE1
DVD-ROM	1	1	1	-	-	-
WibuKey™1 (Software protection key)	1	1	1	1	1	1

\*1: Software protection key to be inserted in a USB slot running System Controller or System Controller Lite.  
 System Controller or System Controller Lite may only run on a PC with Wibu Key. However, WibuKey is not required for remote VRF Explorer software.

**BACnet® Gateway : UTY-ABGX** Software

- It is possible to connect medium to large sized BMS to VRF network system via BACnet®, a global standard for open networks.
- A maximum of 1600 indoor units with 4 VRF network systems (a maximum of 400 indoor units & 100 outdoor units for one network system) can be connected to one BACnet® Gateway.
- It is possible to control or monitor VRF network system from BMS via BACnet® Gateway.
- Compatible with BACnet® (ANSI / ASHRAE-135-2004) application specific controller (B-ASC).
- Compatible with BACnet®/IP over Ethernet.
- Scheduling function, Alarm & Event functions as well as Electricity Change Apportionment function are provided in BACnet® Gateway.
- Connection between VRF network system to personal computer is possible via small U10 USB interface. However, both U10 USB interface & personal computer are field supplied items.
- Corresponds to 7 different languages, English, Chinese, French, German, Spanish, Russian, Polish.

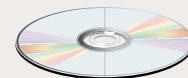

**DVD-ROM (Software)**



**Software Protection Key**



BACnet is a registered trademark of ASHRAE. ASHRAE does not endorse, approve or test products for compliance with ASHRAE standards. Compliance of listed products to requirements of ASHRAE Standard 135 is the responsibility of the BACnet International. BTL is a registered trademark of the BACnet International.

- Max. controllable  
**4**  
VRF network systems
- Max. controllable  
**400**  
outdoor units
- Max. controllable  
**1,600**  
indoor units

**Installation example**

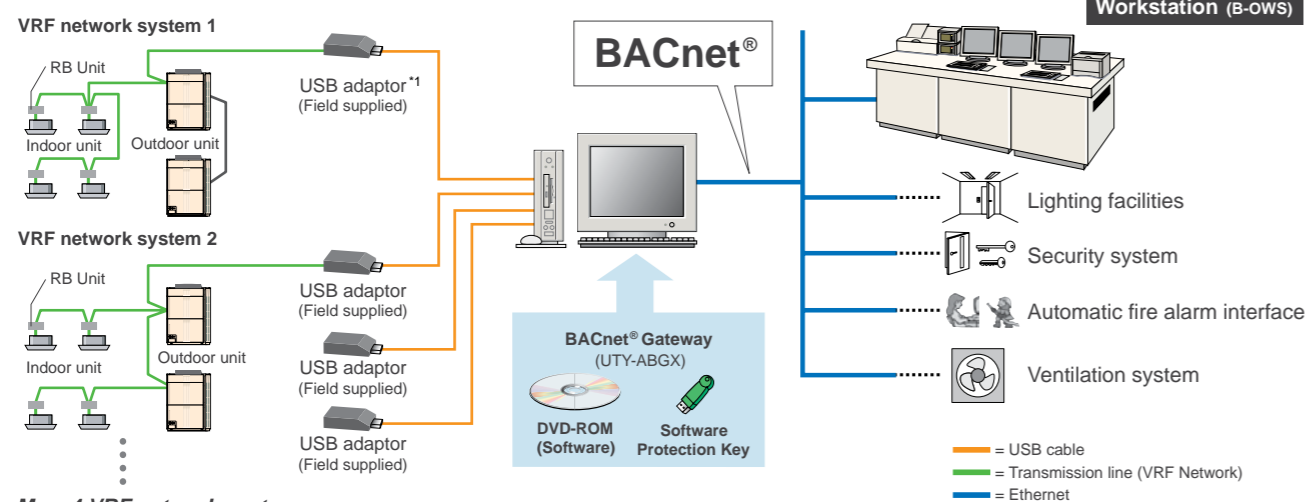

Max. 4 VRF network systems

**Personal computer system requirements**

	UTY-ABGX
Operating system	<ul style="list-style-type: none"> <li>• Microsoft® Windows Vista® Home Premium (32-bit) SP2, Windows Vista® Business (32-bit) SP2</li> <li>• Microsoft® Windows® 7 Home Premium (32-bit or 64-bit) SP1, Windows® 7 Professional (32-bit or 64-bit) SP1</li> <li>• Microsoft® Windows® 8 (32-bit or 64-bit), Windows® 8 Pro (32-bit or 64-bit)</li> <li>• Microsoft® Windows® 8.1 (32-bit or 64-bit), Windows® 8.1 Pro (32-bit or 64-bit)</li> </ul> [Supported languages] English, Chinese, French, German, Russian, Spanish, and Polish
CPU	Intel® Core™ i3 2 GHz or higher
Memory	<ul style="list-style-type: none"> <li>• 2 GB or more (for Windows Vista® and Windows® 7 [32-bit])</li> <li>• 4 GB or more (for Windows® 7 [64-bit], Windows® 8, and Windows® 8.1)</li> </ul>
HDD	40 GB or more of free space
Display	1024 x 768 or higher resolution
Interface	<ul style="list-style-type: none"> <li>• Ethernet port (for getting access to the Internet using LAN)</li> <li>• USB ports (Maximum of 5 ports)                             <ul style="list-style-type: none"> <li>- 1 USB port is required for WibuKey connection</li> <li>- Maximum of 4 USB ports are required for Echelon® U10 USB Network Interface</li> <li>* Maximum number of required USB ports depends on the applicable system configurations.</li> </ul> </li> </ul>
Software	Adobe® Reader® 9.0 or later
Optical drive	DVD-ROM drive

**<Packing list>**

Name and shape	Quantity	Application
DVD-ROM	1	Includes the software and manuals for BACnet® Gateway.
WibuKey (Software protection key)	1	Software protection key to be connected to USB port on the BACnet®-installed PC. BACnet® Gateway runs only on a PC with WibuKey.

- Personal computer that satisfies the following system requirements
- Echelon® U10 USB Network Interface – TP/FT-10 Channel (Model number: 75010R) (Required for each VRF Network.)

**Network Converter for LONWORKS® : UTY-VLGX**

- For connection between VRF network system and a LONWORKS® open network for management of small to medium-sized BMS and VRF network system.
- The UTY-VLGX permits central monitoring and control of a VRF network system from a BMS through a LONWORKS® interface.
- Up to 128 Indoor units can be connected to one Network Converter for LONWORKS®



- Max. controllable  
**4**  
units to BMS
- Max. controllable  
**100**  
outdoor units
- Max. controllable  
**128**  
indoor units

**Installation example**

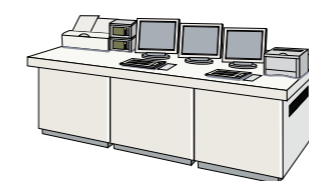

General-purpose building control computer (LONWORKS® device)

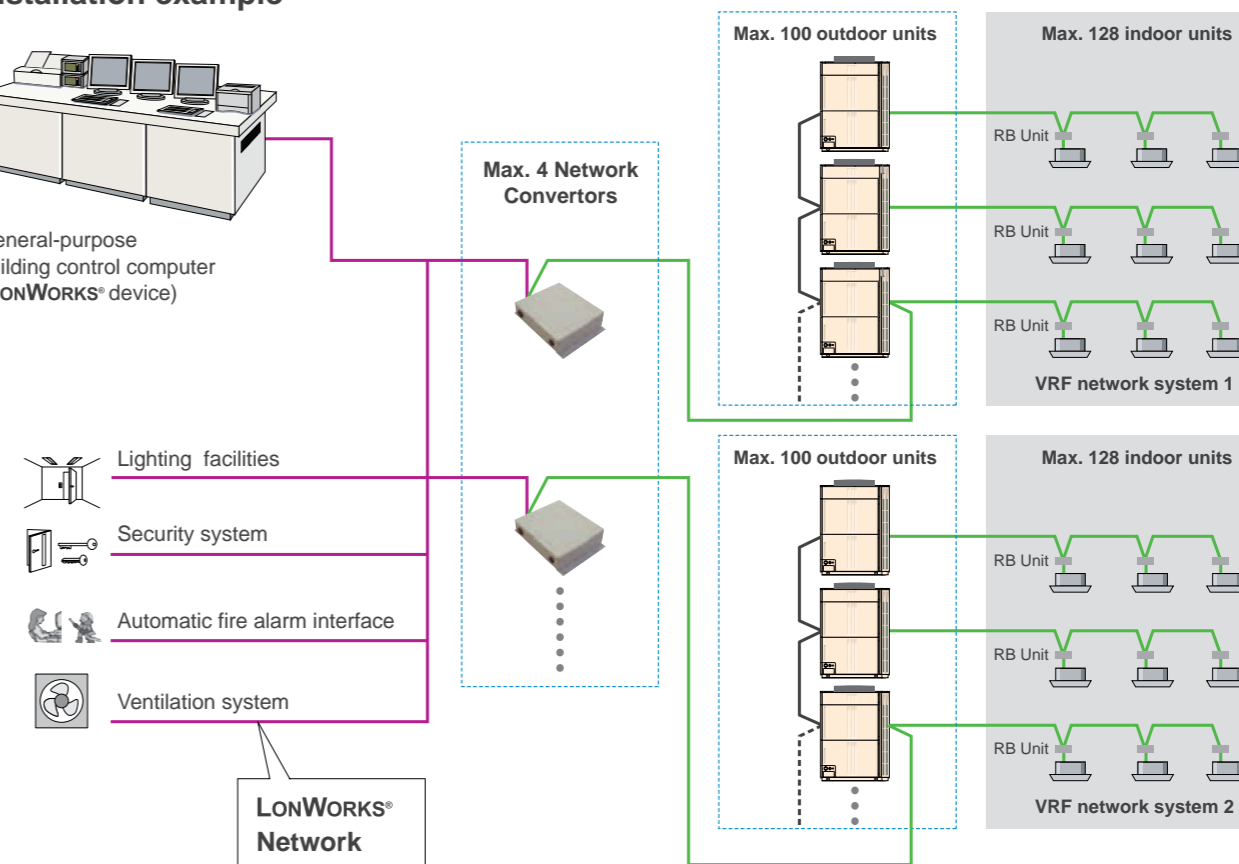

**Specifications**

Model name	UTY-VLGX
Power Supply	208-240V 50/60Hz, Single phase
Power Consumption (W)	4.5
Dimensions (H x W x D) (mm)	67 x 288 x 211
Weight (g)	1,500

**Transmission specifications (BMS side)**

Transmission speed	78 kbps
Transceiver	FT-X1 (Echelon® Corporation)
Transmission way form	Free topology
Terminal resistor	None (It attaches at the terminal of a network.)

**Dimensions (Unit : mm)**

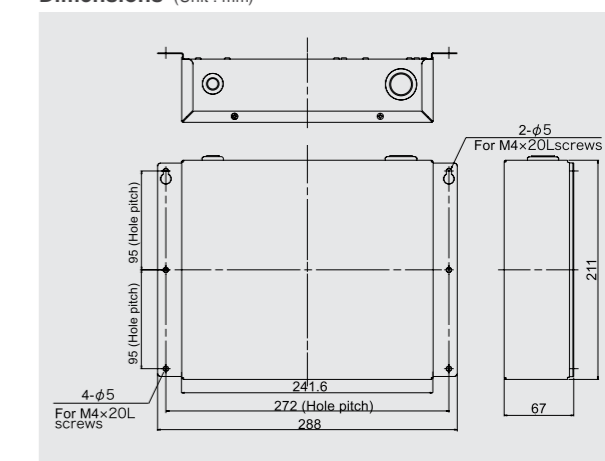

**KNX® Interface : FJ-RC-KNX-1i**

The KNX Interface allows a complete integration of air conditioners with KNX Network systems.

- Simple installation due to small and compact size.
- No separate external power supply required (just KNX bus power).
- Can be used for single indoor units and group controlled (up to 16) indoor units.

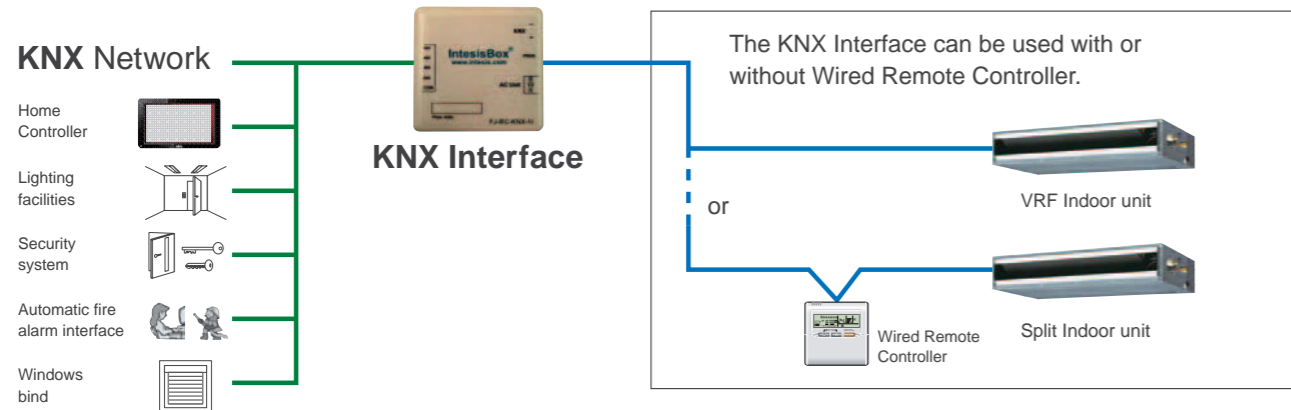

**MODBUS® Interface : FJ-RC-MBS-1**

The MODBUS Interface allows a complete integration of air conditioners into MODBUS Networks.

- Simple installation due to small and compact size.
- No separate external power supply required.
- The MODBUS Interface permits central monitoring and control of air conditioners from BMS.

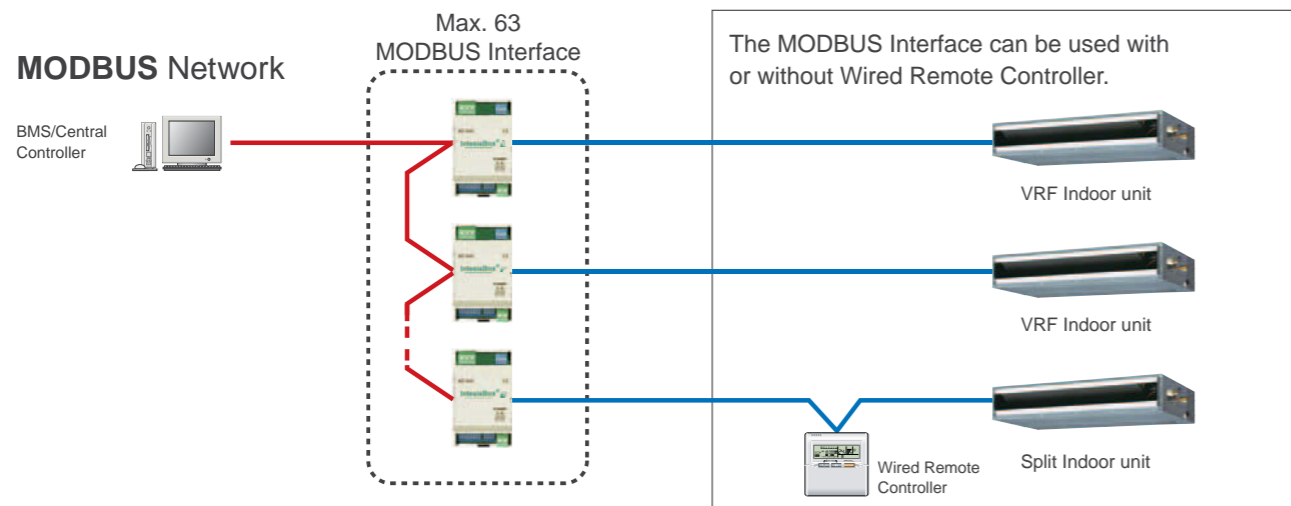

**Specifications**

Model name	FJ-RC-MBS-1
Dimensions (H x W x D) (mm)	93x53x58
Weight (g)	85

Model name	FJ-RC-KNX-1i
Dimensions (H x W x D) (mm)	70x70x28
Weight (g)	70

**Wireless LAN Interface : FJ-RC-WIFI-1**



- It is the most advanced solution to remotely manage an Air Conditioning system using all sort of mobile devices such as Smartphones, Tablets and PC
- No separate external power supply required
- Can be used for single indoor units and group controlled (up to 16) indoor units

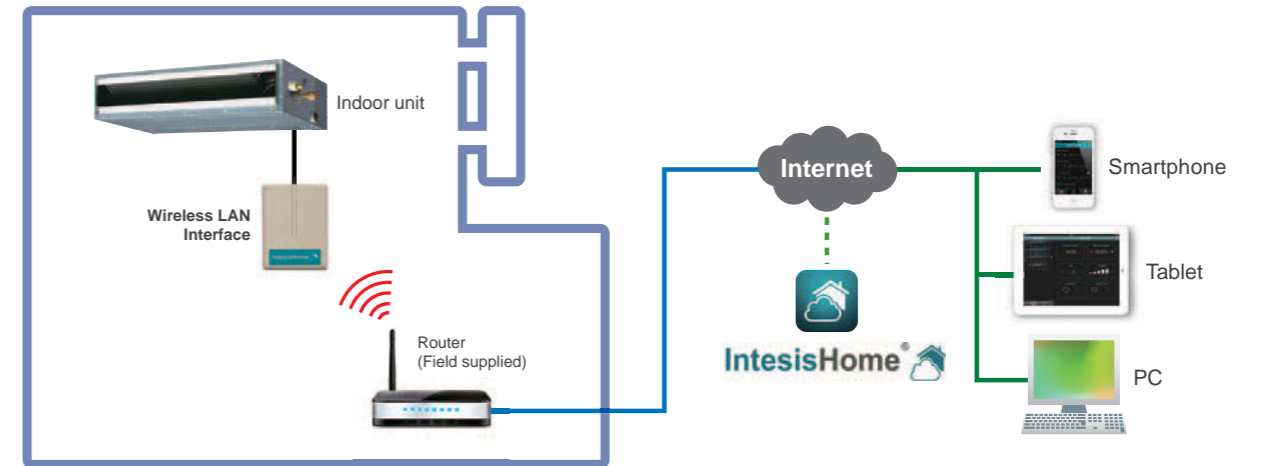

**Basic control**

- Turning the units on and off
- Mode control (Heat, Cool, Dry, Auto, Fan)
- Fan speed setting
- Louver position (Airflow direction setting)
- Room temperature display
- Set temperature control
- Multi Language
- One Scene and Timer

**Advanced control (Optional functions)**

- Climate working modes (ECO, Comfort, Powerful) (future release)
- Schedulable functionalities (ON/OFF, Modes, Set point temperature, Fan Speed, Louver position)
- Set temperature limitation (future release)
- Multiple Scenes & Timers and Calendar function

**Notifications and history**

- Alerts e-mail notification (future release)
- Air conditioning malfunction alerts
- Connectivity monitoring and alerts
- History (future release)

**Specifications**

Model name	FJ-RC-WIFI-1
Dimensions (H x W x D) (mm)	70x108x28
Weight (g)	80

**External Switch Controller : UTY-TEKX**

Air conditioner switching can be controlled by connecting other sensor switches

- In combination with a field supply Card-Key Switch or other sensor, the External Switch Controller allows control of the ON / OFF, Room temperature, Fan speed and Master control functions. This makes this product suitable for installations such as hotel rooms.
- Card-key or other sensor switches are available as a field supplied parts.

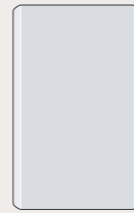

**Installation example**

Auto mode operation, which switches the cooling and the heating automatically, is enabled by using the sensor switch and External Switch Controller.

Note: All indoor units will operate in the same mode.

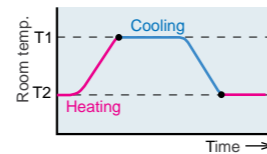
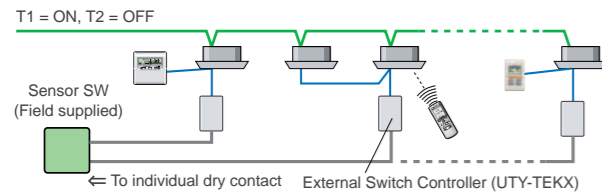

Note 1.

Please choose a thermosensor switch which can be set up for T1 and T2.

Note 2.

The remote controller's operation is prior to the auto mode operation.

**Electrical wiring**

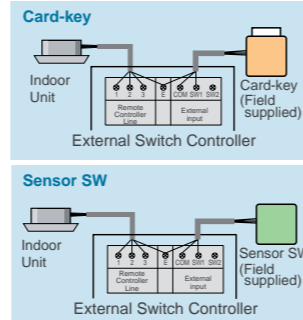

**Signal Amplifier : UTY-VSGXZ1**

- Transmission Line length can be extended up to 3,600m with multiple Signal Amplifiers.
- Up to 8 signal amplifiers can be installed in a VRF network system.
- A signal amplifier is required,
  - (1) When the total wiring length of the transmission line exceeds 500m.
  - (2) When the total number of units on the transmission line exceeds 64.

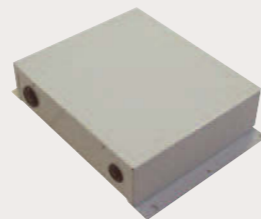

**Installation example**

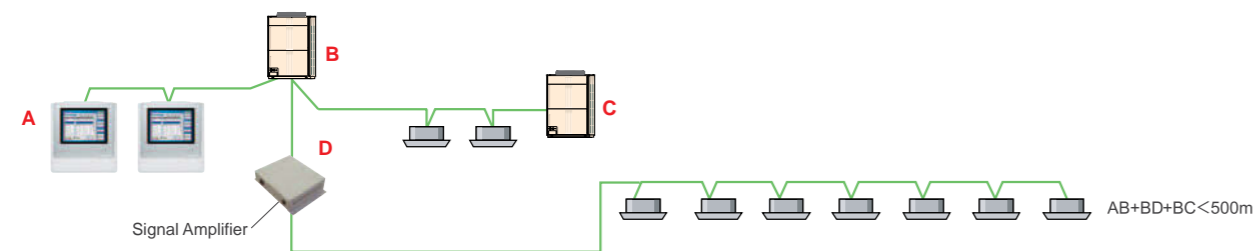

**Specifications**

Model name	UTY-TEKX
Power Supply	DC 12V
Dimensions (H x W x D) (mm)	120 x 75 x 30
Weight (g)	100

DC12V is supplied by the indoor unit.

Model name	UTY-VSGXZ1
Power Supply	208-240V 50/60Hz, Single phase
Power Consumption (W)	4.5
Dimensions (H x W x D) (mm)	67 x 288 x 211
Weight (g)	1,500

**Network Converter : UTY-VGGXZ1**



Max. controllable  
**16**  
Network Converter units

Max. controllable  
**4**  
Group Remote Controllers

- This network converter is to be used for connecting single split system or group remote controller with the VRF network system.
- Please select the function by switching the dip switch during the installation.

**Installation example**

- Split type systems can be controlled from a central remote controller or PC controller through connection to the VRF's network converter.
- Standard remote controller and central remote controller provide On / Off control, master control, temperature and fan control, etc.
- A single network converter can be used to connect and control up to 16 single units.

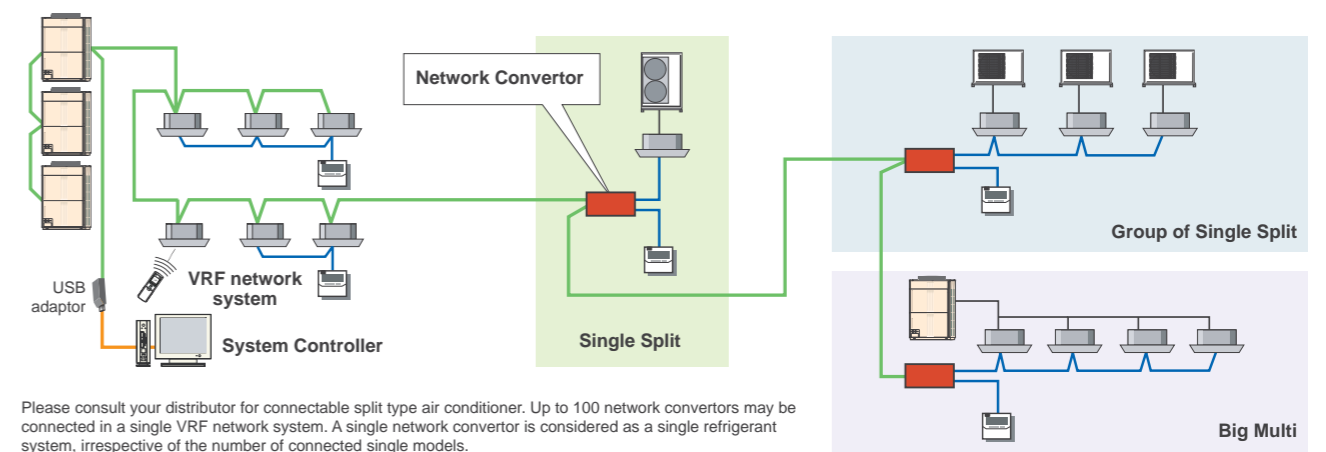

Please consult your distributor for connectable split type air conditioner. Up to 100 network converters may be connected in a single VRF network system. A single network converter is considered as a single refrigerant system, irrespective of the number of connected single models.

**Used for connecting Group Remote Controller**

4 group remote controllers can be connected to a single Network converter.

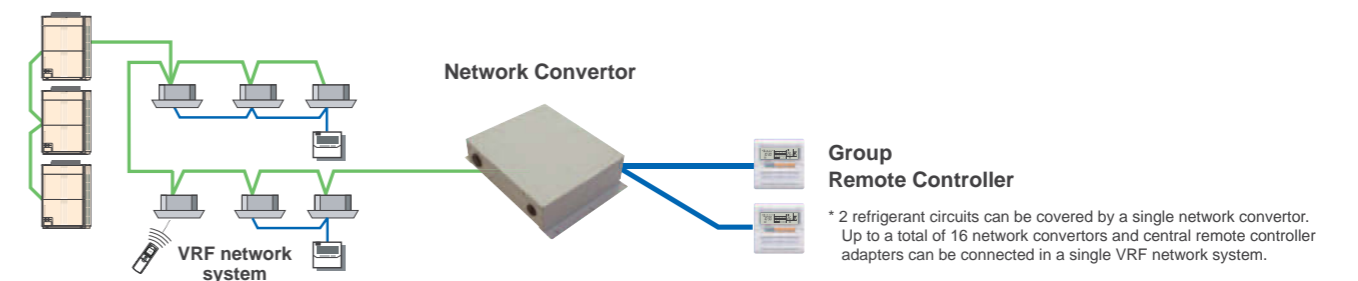

**Specifications**

Model name	UTY-VGGXZ1
Power Supply	208-240V 50/60Hz, Single phase
Power Consumption (W)	6.5
Dimensions (H x W x D) (mm)	67 x 288 x 211
Weight (g)	1,500

**Service Tool : UTY-ASGX** (Software)

Extensive monitoring and analysis functions for installation and maintenance

- Operation status can be checked and analyzed to detect even the smallest abnormalities
- Storage of data on system operation status on a PC allows access even from off site.
- Up to 400 indoor units (a single VRF network system) can be controlled and monitored for large scale buildings or hotels
- This software can be connected to any point of transmission line with USB adaptor (field supplied).



Max. Monitor and control  
**100**  
outdoor units

Max. Monitor and control  
**400**  
indoor units

VRF network system can be supported  
**4**

Max. Monitor  
**400**  
outdoor units

**1,600**  
indoor units can be supported

**Web Monitoring Tool : UTY-AMGX** (Software)

Product features

- Troubleshooting is performed by monitoring each air conditioning unit remotely during periodical system checks.
- Error notification can be automatically transmitted to several locations using the internet\*1.
- Requires either a dedicated internet connection or public telephone line.
- Determination of an error occurrence can be made through error warnings and equipment status information obtained from a remote location.
- The monitoring data in a remote side can be optionally downloaded. And, this data can be displayed in offline mode of the service tool.
- Monitoring side computer is not required to install special software, requires only general web browser.

\*1: Use of internet mail system required.

**Wiring connection**

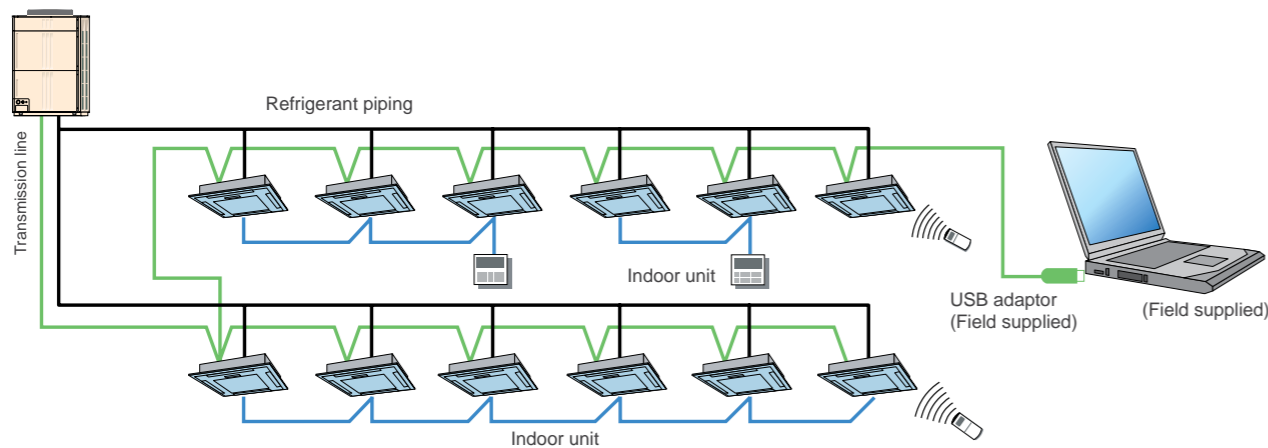

**Functions**

• Equipment Detail (Diagram)

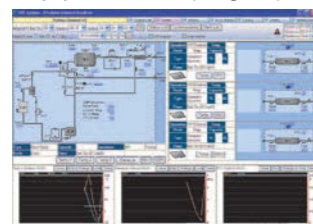

- Equipment Detail (List)
- Error History
- Remote File Download
- System List
- Commissioning Tool

**Web Monitoring System**

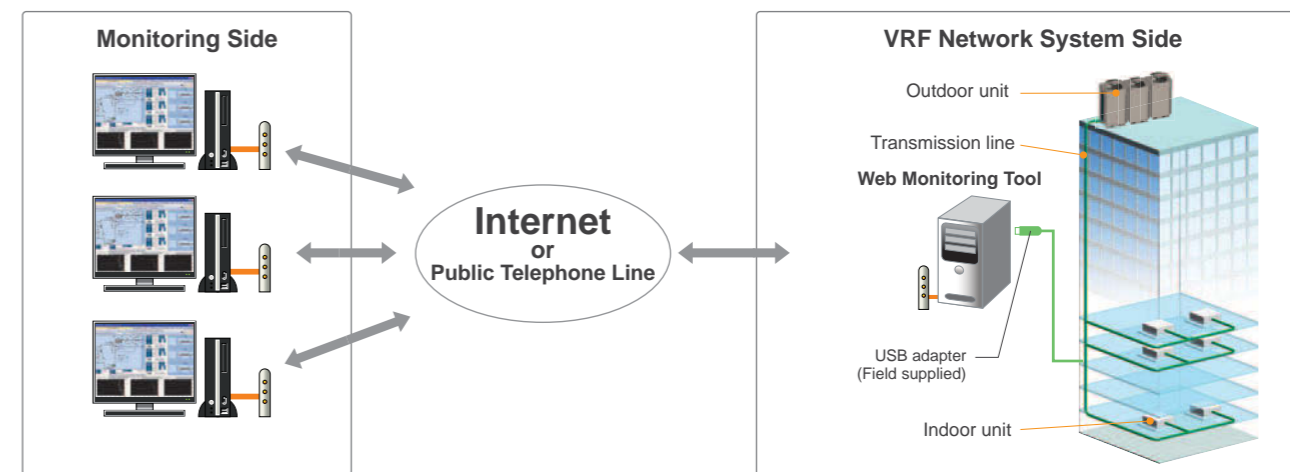

**Support 4 VRF network systems**

USB adaptor (max. 4 adaptors per PC) permit monitoring of up to 1,600 indoor units. Suitable for large-scale buildings or hotels.

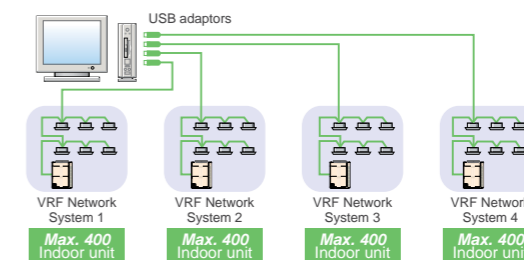

**Personal computer system requirements**

	UTY-ASGX
Operating system	<ul style="list-style-type: none"> <li>• Microsoft® Windows Vista® Home Premium (32-bit) SP2, Windows Vista® Business (32-bit) SP2</li> <li>• Microsoft® Windows® 7 Professional (32-bit or 64-bit) SP1</li> <li>• Microsoft® Windows® 8 Pro (32-bit or 64-bit)</li> <li>• Microsoft® Windows® 8.1 Pro (32-bit or 64-bit)</li> </ul>
CPU	1 GHz or higher
Memory	<ul style="list-style-type: none"> <li>• 1 GB or more (for Windows Vista®, Windows® 7 [32-bit], Windows® 8 [32-bit], and Windows® 8.1 [32-bit])</li> <li>• 2 GB or more (for Windows® 7 [64-bit], Windows® 8 [64-bit], and Windows® 8.1 [64-bit])</li> </ul>
HDD	10 GB or more of free space
Display	1024 x 768 or higher resolution
Interface	<ul style="list-style-type: none"> <li>• 2 USB ports</li> <li>- 1 USB port is required for WibuKey connection</li> <li>- 1 USB port is required for Echelon® U10 USB Network Interface</li> </ul>
Software	Internet Explorer® 8, 9, 10 or 11 / Adobe® Reader® 9.0 or later
Optical drive	DVD-ROM drive

**<Packing list>**

Name and shape	Quantity	Application
DVD-ROM	1	Includes the software and manuals
WibuKey (Software protection key)	1	Software protection key to be connected to USB port on the Service Tool-installed PC. These products runs only on a PC with WibuKey.

- Personal computer that satisfies the following system requirements
- Echelon® U10 USB Network Interface – TP/FT-10 Channel (Model number: 75010R) (Required for each VRF Network.)

**Personal computer system requirements**

	UTY-AMGX
Operating system	<ul style="list-style-type: none"> <li>• Microsoft® Windows Vista® Home Premium (32-bit) SP2, Windows Vista® Business (32-bit) SP2</li> <li>• Microsoft® Windows® 7 Professional (32-bit or 64-bit) SP1</li> <li>• Microsoft® Windows® 8 Pro (32-bit or 64-bit)</li> <li>• Microsoft® Windows® 8.1 Pro (32-bit or 64-bit)</li> </ul>
CPU	1 GHz or higher
Memory	<ul style="list-style-type: none"> <li>• 1 GB or more (for Windows Vista®, Windows® 7 [32-bit], Windows® 8 [32-bit], and Windows® 8.1 [32-bit])</li> <li>• 2 GB or more (for Windows® 7 [64-bit], Windows® 8 [64-bit], and Windows® 8.1 [64-bit])</li> </ul>
HDD	40 GB or more of free space
Display	1024 x 768 or higher resolution
Interface	<ul style="list-style-type: none"> <li>• Ethernet port (for getting access to the Internet using LAN) or Modem (for getting access to the Internet using Public Telephone Line)</li> <li>• USB ports (Maximum of 5 ports)</li> <li>- 1 USB port is required for WibuKey connection</li> <li>- Maximum of 4 USB ports are required for Echelon® U10 USB Network Interface</li> <li>* Maximum number of required USB ports depends on the applicable system configurations.</li> </ul>
Software	Internet Explorer® 8, 9, 10 or 11 / Adobe® Reader® 9.0 or later
Optical drive	DVD-ROM drive

**<Packing list>**

Name and shape	Quantity	Application
DVD-ROM	1	Includes the software and manuals
Wibu Key (Software protection key)	1	Software protection key to be connected to USB port on the Service Tool-installed PC. These products runs only on a PC with WibuKey.

















- Personal computer that satisfies the following system requirements
- Echelon® U10 USB Network Interface – TP/FT-10 Channel (Model number: 75010R) (Required for each VRF Network.)

High Efficiency and low noise levels are achieved by using a highly efficient heat exchange process. A comfortable air conditioned space is achieved by conveniently selecting whether to use heat exchange or normal ventilation setting, according to the requirements of the conditioned space."

Effective heat exchange and simultaneous fresh air ventilation

# VENTILATION

## VENTILATION LINEUP

Airflow rate (m <sup>3</sup> /h)	250	350	500	800	1000	1500	2000			
Energy Recovery Ventilator Page 188	 UTZ-BD025B	 UTZ-BD035B	 UTZ-BD050B	 UTZ-BD080B	 UTZ-BD100B					
Outdoor Air Unit Page 190					 ARXH054GTAH	 ARXH072GTAH	 ARXH096GTAH			
Connectable Capacity class (kW)	5.0	6.3	8.0	10.0	12.5	14.0	20.0	25.0	40.0	50.0
DX-Kit for air handling applications Page 192	 EEV unit UTP-VX30A	 Control unit UTY-VDGX	 EEV unit UTP-VX60A	 Control unit UTY-VDGX	 EEV unit UTP-VX90A	 Control unit UTY-VDGX	 EEV unit UTP-VX90A × 2	 Control unit UTY-VDGX		

188 Energy Recovery Ventilator

190 Outdoor Air Unit

192 DX-Kit for air handling applications

UTZ-BD025B / UTZ-BD035B / UTZ-BD050B / UTZ-BD080B / UTZ-BD100B

Energy recovery ventilator unit offers maximum comfort and greater energy savings.



Features

**Adopts a highly efficient counter-flow heat exchange element**

**Heat exchange ventilation and normal ventilation**

**Heat exchange ventilation**  
When a room is cooled or heated, the exhausted cooling / heating energy is recovered by heat-exchange ventilation.

**Normal ventilation**  
The operation is used during periods when the room space requires no cooling or heating effect, i.e. when there is minimal temperature difference between the indoor and outdoor environments.

High Efficiency

Energy efficiency and ecology

**20%**  
Energy saving

Energy consumption is dramatically reduced by using a counter-flow heat-exchange element. Air conditioning load is reduced by approximately 20%, resulting in significant energy savings. Recovers up to 77% of the heat in the outgoing air.

Features of heat exchange element

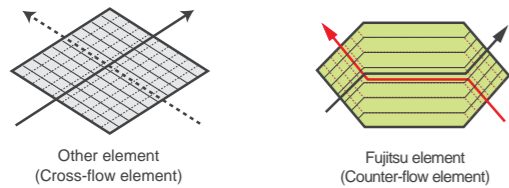

With the cross-flow element, air moves in a straight line across the element. With the counter-flow element, air flows through the element for a longer time (longer distance), so the heat-exchange effect remains unchanged.

More Comfort

Quiet operation

Significantly reducing low pressure loss and noise allows low-noise operation.

Design Flexibility

Extended range of an external static pressure

An external static pressure is improved by adopting a powerful fan motor. This allows for application in a wide variety building.

Features

Easy Installation and Maintenance

Slim shape and easier installation

Counter-flow heat exchange element used for reduced noise and slimmer, more compact body shape.

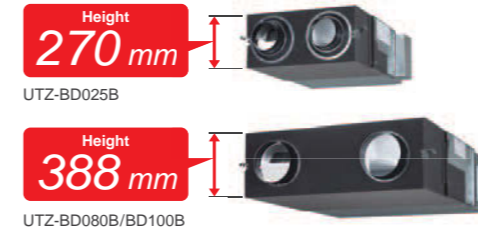

Reverse mountable direct air supply / exhaust system

Adoption of straight air supply / exhaust system: Duct design is simplified because the air supply / exhaust ducts are straight.

Since each unit can be mounted in reverse position, only one inspection hole is needed for two units: Two units can share one inspection hole so duct work is easier and more flexible.

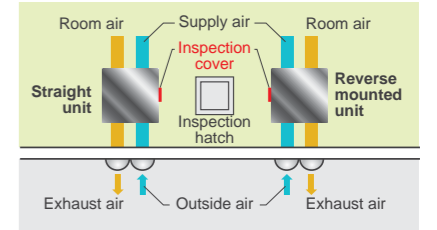

Specifications

Rated flow rate		250 m <sup>3</sup> /h		350 m <sup>3</sup> /h		500 m <sup>3</sup> /h		800 m <sup>3</sup> /h		1000 m <sup>3</sup> /h	
Model No.		UTZ-BD025B		UTZ-BD035B		UTZ-BD050B		UTZ-BD080B		UTZ-BD100B	
Power source		220 - 240V, 50Hz									
Heat Exchange Ventilation	Input power	(Extra high)/High/Low	W	128 / 123 / 96	190 / 185 / 168	289 / 225 / 185	418 / 378 / 295	464 / 432 / 311			
	Air flow rate	(Extra high)/High/Low	m <sup>3</sup> /h	250 / 250 / 190	350 / 350 / 240	500 / 500 / 440	800 / 800 / 630	1000 / 1000 / 700			
	External static pressure	(Extra high)/High/Low	Pa	105 / 95 / 45	140 / 60 / 45	120 / 60 / 35	140 / 110 / 55	105 / 80 / 75			
	Temperature Exchange Efficiency	(Extra high)/High/Low	%	75 / 75 / 77	75 / 75 / 78	75 / 75 / 76	75 / 75 / 76	75 / 75 / 79			
	Energy Exchange Efficiency Cooling	(Extra high)/High/Low	%	63 / 63 / 65	66 / 66 / 71	62 / 62 / 64	65 / 65 / 68	65 / 65 / 70			
Normal Ventilation	Energy Exchange Efficiency Heat pump	(Extra high)/High/Low	%	70 / 70 / 72	69 / 69 / 73	67 / 67 / 69	71 / 71 / 74	71 / 71 / 76			
	Sound pressure level	(Extra high)/High/Low	dB*	31.5 / 30.5 / 26.5	33 / 31 / 25.5	37.5 / 35.5 / 32.5	37.5 / 37 / 34.5	38.5 / 37.5 / 34.5			
	Input power	(Extra high)/High/Low	W	128 / 123 / 96	190 / 185 / 168	289 / 225 / 185	418 / 378 / 295	464 / 432 / 311			
	Air flow rate	(Extra high)/High/Low	m <sup>3</sup> /h	250 / 250 / 190	350 / 350 / 240	500 / 500 / 440	800 / 800 / 630	1000 / 1000 / 700			
	External static pressure	(Extra high)/High/Low	Pa	105 / 95 / 45	140 / 60 / 45	120 / 60 / 35	140 / 110 / 55	105 / 80 / 75			
Sound pressure level	(Extra high)/High/Low	dB*	31.5 / 30.5 / 26.5	33 / 31 / 25.5	38.5 / 38 / 32.5	37.5 / 37 / 34.5	40.5 / 39.5 / 36.5				
Dimensions	WxDxH	mm	882 x 599 x 270	1050 x 804 x 317	1090 x 904 x 317	1322 x 884 x 388	1322 x 1134 x 388				
Weight		kg	29	49	57	71	83				
Outlet duct diameter		mm	150	150	200	250	250				
Operation range		°C	-10 to 40	-10 to 40	-10 to 40	-10 to 40	-10 to 40				
Maximum humidity		%	85	85	85	85	85				

\* The noise level must be measured 1.5 m below the centre of the unit.

Dimensions Models : UTZ-BD025B / UTZ-BD035B / UTZ-BD050B / UTZ-BD080B / UTZ-BD100B

(Unit : mm)

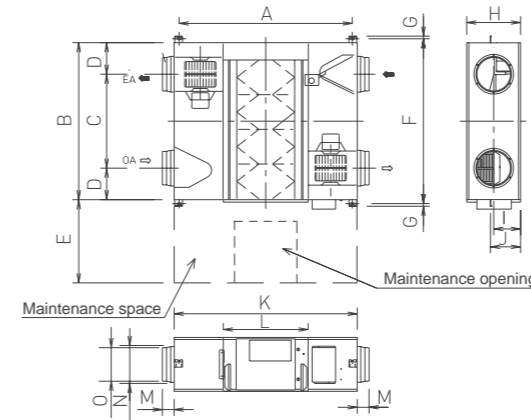

	UTZ-BD025B	UTZ-BD035B	UTZ-BD050B	UTZ-BD080B	UTZ-BD100B
A	810	978	1018	1250	1250
B	599	804	904	884	1134
C	315	580	640	428	678
D	142	112	132	228	228
E	600	600	600	600	600
F	655	860	960	940	1190
G	19	19	19	19	19
H	270	317	317	388	388
I	135	159	159	194	194
J	159	182	182	218	218
K	882	1050	1090	1322	1322
L	414	470	470	612	612
M	95	70	127	85	85
N	219	162	210	258	258
O	144	144	194	242	242

ARXH054GTAH / ARXH072GTAH / ARXH096GTAH Production by order

The heat pump method efficiently processes the outdoor air for cooling and heating and supplies 100% fresh air into a room.



Features

One VRF system can provide air conditioning and air supply at the same time.

Outdoor Air Unit can be connected in a same VRF\*1 system as one of indoor unit series and can create fresh and comfortable air supply together from our high advanced technology.

\*1. Connectable VRF series: J-IIS, J-II, V-II, VR-II  
In J-II series alone, OAU is prohibit to connect under the ambient temperature of 40°C or higher.

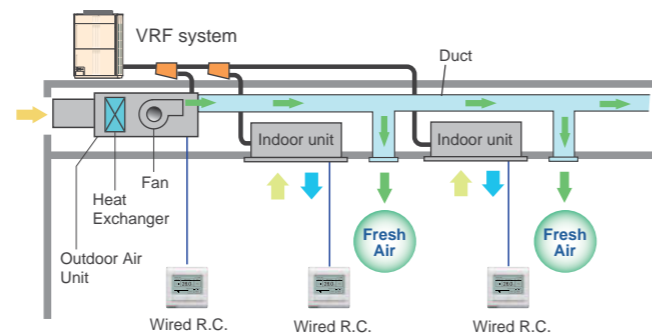
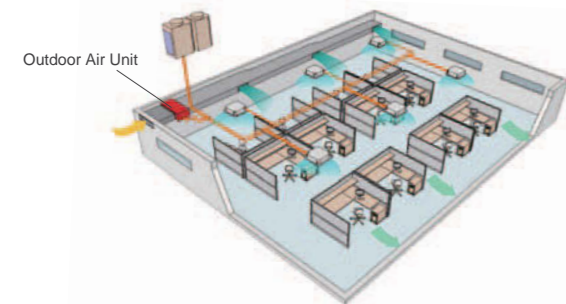

\* Make sure the connected capacity is within the range of 50% to 100% of the outdoor unit capacity. In addition, if there are mixed connections with indoor units, make the Outdoor Air Unit connection capacity 30% or less of the outdoor unit capacity.

High energy savings and flexible duct design by using DC motor

- Greatly reduces electricity consumption by adopting permanent magnet compared to when using an AC motor.
- Compared with AC motor, changing the speed makes it possible to respond flexibly to the external static pressure from 50 Pa to 240 Pa. Even if damper equipment is not used, static pressure can be adjusted and duct design is easy.
- Static pressure can be set easily using wired remote controller.

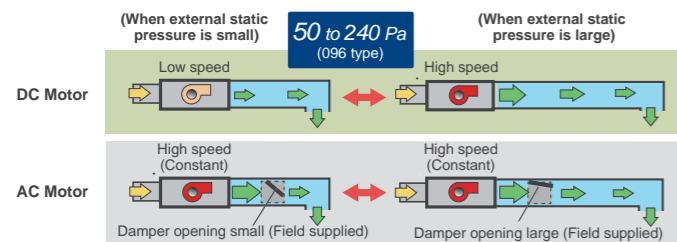
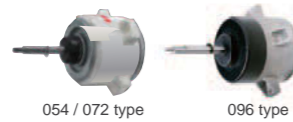

Top class compact design

- Top class lightweight compact design at just 425 mm in height, 55 kg in weight for ARXH072 type. This unit can be installed easily even at narrow space.

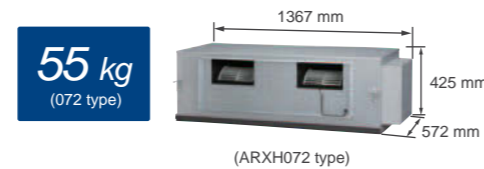

Features

Various Controller

Supplied variety of controllers as options, such as individual controller, central controller, and building management controller.

Individual Controller



Central Controller



\* The temperature setting is discharged air temperature setting. The air volume is set to a constant speed.

Specifications

(Tentative)

Model name			ARXH054GTAH	ARXH072GTAH	ARXH096GTAH
Power Source		V/∅/Hz	230/1/50	230/1/50	230/1/50
Capacity	Cooling	kW	14.0	22.4	28.0
	Heating	kW	8.9	13.9	17.4
Input Power	Cooling/Heating	W	179	292	370
Airflow Rate		m <sup>3</sup> /h	1,080	1,680	2,100
Static Pressure	Standard (range)	Pa	185 (50-185)	200 (50-200)	200 (50-240)
Sound Pressure Level		dB (A)	42	44	47
Dimensions (H x W x D)		mm	425x1,367x572	425x1,367x572	450x1,583x700
Weight		kg	48	55	71
Connection Pipe Diameter (Small / Large)		mm	∅9.52/∅19.05	∅12.70/∅22.22	∅12.70/∅22.22
Operation Range	Cooling	°CDB	5 to 43	5 to 43	5 to 43
	Heating	°CDB	-7 to 21	-7 to 21	-7 to 21
Refrigerant			R410A	R410A	R410A

Note : Specifications are based on the following conditions. Cooling : Outdoor temperature of 33°CDB / 28°CWB. Heating : Outdoor temperature of 0°CDB / -2.9°CWB. Pipe length : 7.5 m Voltage : 230 [V].

Dimensions Models : ARXH054GTAH/ARXH072GTAH/ARXH096GTAH

(Unit : mm)

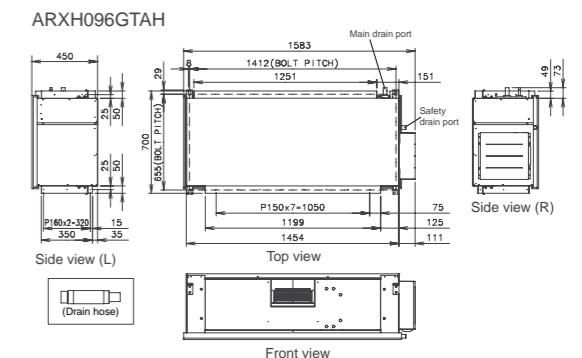
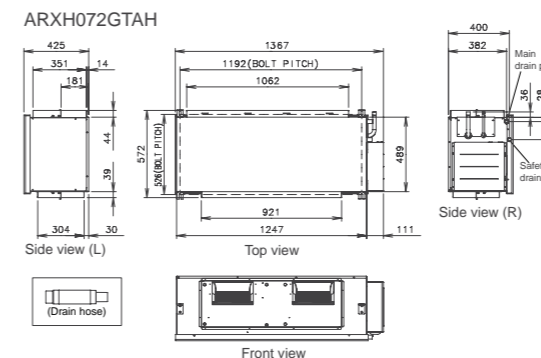
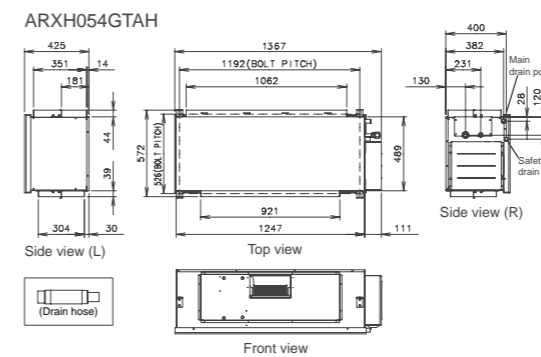



**Control unit :** UTY-VDGX

**EEV unit :** UTP-VX30A / UTP-VX60A / UTP-VX90A

These kits enable other manufacturers air handling units (AHU) and fan coil units (FCU) to be incorporated into a Fujitsu VRF system or, be connected to a dedicated Fujitsu VRF outdoor unit as a 1:1 system to control outside air ventilation (AHU) or room temperature (FCU).



**Features**

**Multiple temperature sensors optimally control the air handling unit and fan coil unit.**

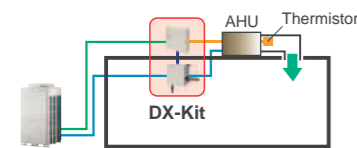

When connecting to an air handling unit, the supply air temperature is controlled by the discharge sensor.

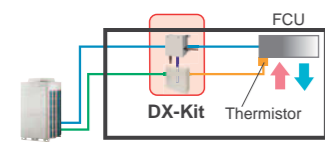

When connecting to a fan coil unit, the room temperature is controlled by the return air temperature sensor.

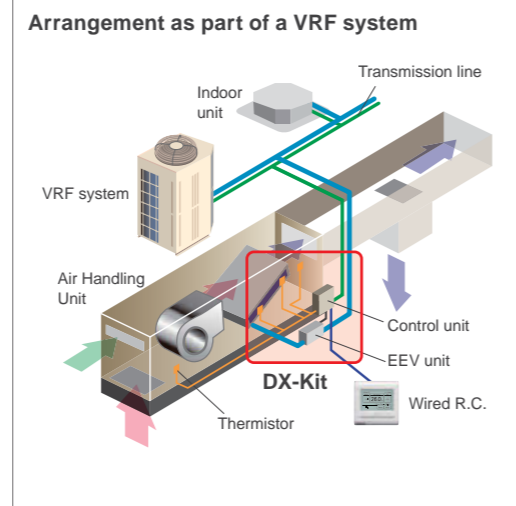

**Supports a wide range of capacity classes**

- 2 EEV units can be connected in parallel and up to 20 HP (50 kW) large capacity units. (Separation Tube of UTP-LX180A is required.)
- Connectable capacity range: 5 kW to 50 kW

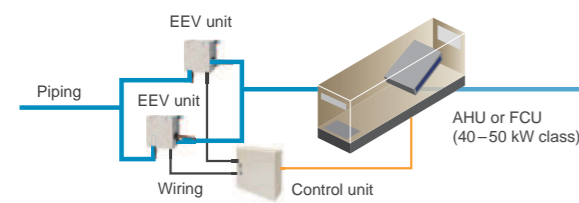

**A variety of controls to match the application**

- Central control using our VRF controllers or central management controllers

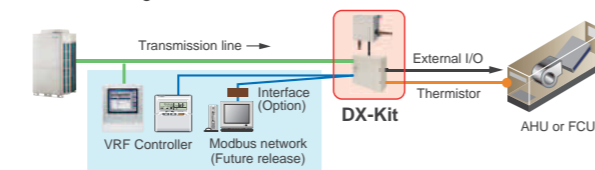

- Central control from external controllers

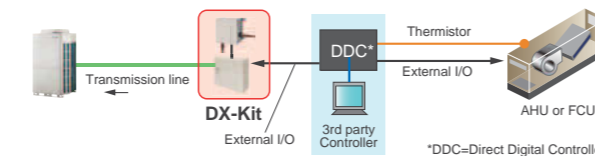

**Features**

**Functions Summary**

**Inputs**

- ON/OFF
- Setting temperature
- Capacity demand
- Heating / Cooling operation mode
- Fault information

**Outputs**

- ON/OFF indication
- Fan ON/OFF indication
- Thermo ON/OFF indication
- Defrost indication
- Fault indication

**Modbus Control** Future Release

- Possible to control via a Modbus enabled BMS by using optional interface.

**Installation Limitation**

- Connectable VRF series : J-IIS, J-II, V-II, VR-II
- Connectable DX-Kit system capacity range : 50 to 100% of the outdoor unit capacity
- Connectable DX-Kit system capacity range with indoor units : 30% or less of the outdoor unit capacity
- Max. wiring length from control unit : 10 m
- Max. piping length between EEV unit and indoor unit : 5 m
- Outdoor installation : Control unit (IP54 class) and EEV unit can be installed at an outdoor space.

**Connectable capacity**

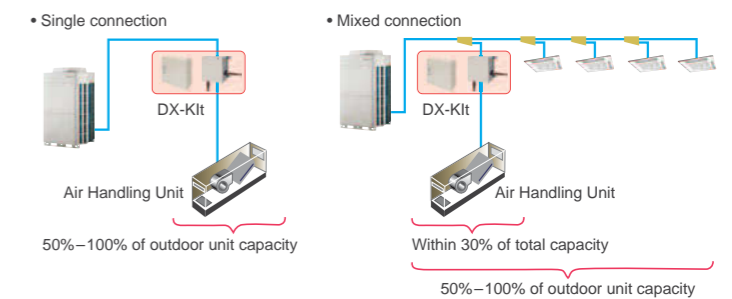

- [For 2EEV units connection (option)]**
- Separation Tube : UTP-LX180A



**Piping and wiring length**

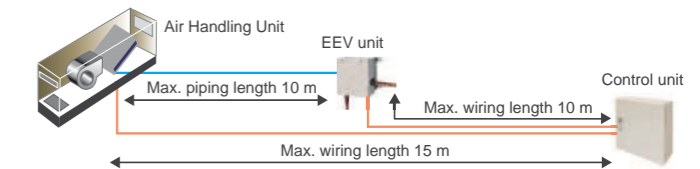



**Specifications**

Connectable Capacity class		(Tentative)									
		5.0kW	6.3kW	8.0kW	10.0kW	12.5kW	14.0kW	20.0kW	25.0kW	40.0kW	50.0kW
Capacity	Cooling	5.6	6.3	8.0	10.0	12.5	14.0	22.4	25.0	40.0	50.4
	Heating	6.3	7.1	9.0	11.2	14.0	16.0	25.0	28.0	45.0	56.5
Control unit		UTY-VDGX									
Power source	V/∅/Hz	230 / 1 / 50									
Dimensions (H x W x D)	mm	400 x 400 x 120									
EEV unit		UTP-VX30A		UTP-VX60A		UTP-VX90A		UTP-VX90A×2			
Connection pipe diameter (Liquid)	mm	∅9.53		∅12.7		∅12.7		∅12.7			
Dimensions (H x W x D)	mm	160 x 220 x 90									

Note : Specifications are based on the following conditions.  
 Cooling : Indoor temperature of 27°CDB / 19°CWB, and outdoor temperature of 35°CDB / 24°CWB.  
 Heating : Indoor temperature of 20°CDB / (15°CWB), and outdoor temperature of 7°CDB / 6°CWB.  
 Pipe length : 7.5 m Voltage : 230 [V].

Connection Units

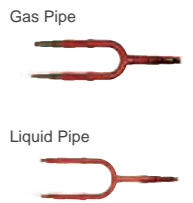
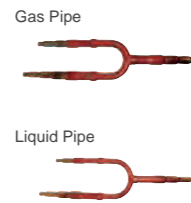
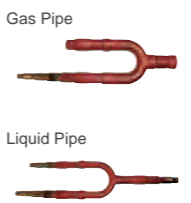
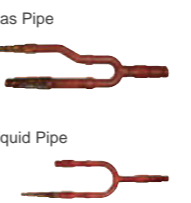
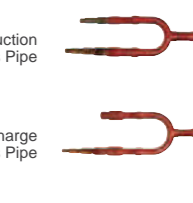
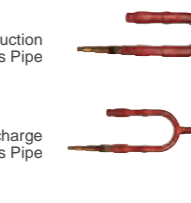
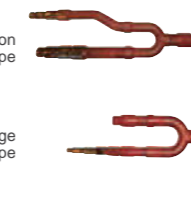
**Separation Tube**

 <p>Gas Pipe</p> <p>Liquid Pipe</p> <p>UTP-AX054A</p>	 <p>Gas Pipe</p> <p>Liquid Pipe</p> <p>UTP-AX090A</p>	 <p>Gas Pipe</p> <p>Liquid Pipe</p> <p>UTP-AX180A</p>	 <p>Gas Pipe</p> <p>Liquid Pipe</p> <p>UTP-AX567A</p>
 <p>Suction Gas Pipe</p> <p>Discharge Gas Pipe</p> <p>Liquid Pipe</p> <p>UTP-BX090A</p>	 <p>Suction Gas Pipe</p> <p>Discharge Gas Pipe</p> <p>Liquid Pipe</p> <p>UTP-BX180A</p>	 <p>Suction Gas Pipe</p> <p>Discharge Gas Pipe</p> <p>Liquid Pipe</p> <p>UTP-BX567A</p>	<p><b>For DX-Kit</b></p>  <p>UTP-LX180A</p>

**Header**

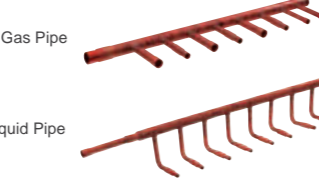
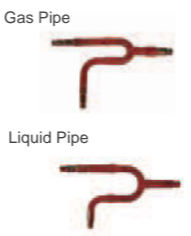
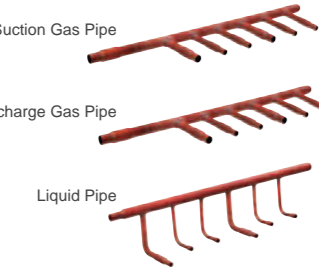
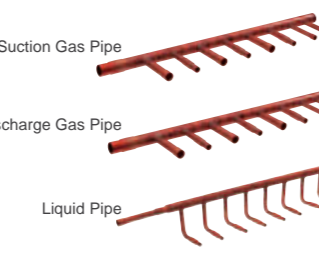
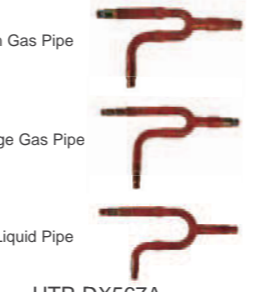
 <p>Gas Pipe</p> <p>Liquid Pipe</p> <p>UTR-H0906L / UTR-H1806L</p>	 <p>Gas Pipe</p> <p>Liquid Pipe</p> <p>UTR-H0908L / UTR-H1808L</p>	 <p>Gas Pipe</p> <p>Liquid Pipe</p> <p>UTP-CX567A</p>
 <p>Suction Gas Pipe</p> <p>Discharge Gas Pipe</p> <p>Liquid Pipe</p> <p>UTP-J0906A / UTP-J1806A</p>	 <p>Suction Gas Pipe</p> <p>Discharge Gas Pipe</p> <p>Liquid Pipe</p> <p>UTP-J0908A / UTP-J1808A</p>	 <p>Suction Gas Pipe</p> <p>Discharge Gas Pipe</p> <p>Liquid Pipe</p> <p>UTP-DX567A</p>

**Outdoor Unit Branch Kit**



**EV Kit**

For Compact Wall Mounted type



Model code  $\leq 09$  : UTR-EV09XB  
Model code  $\geq 12$  : UTR-EV14XB

**RB Unit**

 <p>Single type</p> <p>UTP-RX01AH / UTP-RX01BH / UTP-RX01CH</p>	 <p>Multi type</p> <p>UTP-RX04BH</p>
--	--

Specifications

**Separation Tube**

Model name	UTP-AX054A (for J-IIS only)	UTP-AX090A	UTP-AX180A	UTP-AX567A
Total cooling capacity of indoor unit (kW)	19.6 or less	28.0 or less	28.1 to 56.0	56.1 or more

Model name	UTP-BX090A	UTP-BX180A	UTP-BX567A
Total cooling capacity of indoor unit (kW)	28.0 or less	28.1 to 56.0	56.1 or more

**Header**

Model name	3-6 Branches	UTR-H0906L	UTR-H1806L
	3-8 Branches	UTR-H0908L	UTR-H1808L
Total cooling capacity of indoor unit (kW)		28.0 or less	28.1 to 56.0

Model name	3-6 Branches	UTP-J0906A	UTP-J1806A
	3-8 Branches	UTP-J0908A	UTP-J1808A
Total cooling capacity of indoor unit (kW)		28.0 or less	28.1 to 56.0

**Outdoor unit Branch kit**

Model name	UTP-CX567A (for V-II)	UTP-DX567A (for VR-II)
Number of outdoor unit	2 outdoor units	1
	3 outdoor units	2

**EV Kit**

Model name	UTR-EV09XB	UTR-EV14XB
Application model	ASYE04GACH ASYE07GACH ASYE09GACH	ASYE12GACH ASYE14GACH

**RB Unit**

Type	Single type			Multi type
Model name	UTP-RX01AH	UTP-RX01BH	UTP-RX01CH	UTP-RX04BH
Power source	V/ $\phi$ /Hz 230/1/50			
Input power	W 17	24	31	96
Number of branches	1	1	1	4
Maximum capacity of connectable indoor units (Q)	kW $Q \geq 8.0$	$Q \leq 18.0$	$Q \leq 28.0$	$Q \leq 56.0^*1$
Maximum capacity of connectable indoor units per branch (Q)	kW $Q \geq 8.0$	$Q \leq 18.0$	$Q \leq 28.0$	$Q \leq 18.0$
Maximum number of connectable indoor units per branch	3	8	8	8
Dimensions (HxWxD)	mm 198x298x268			260x658x428





\*1: In case of two RB units connected in series ( total 8-branches ), maximum capacity of connectable indoor units is up to 56.0 kW.

**Controllers**

**For Individual Control**

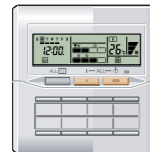

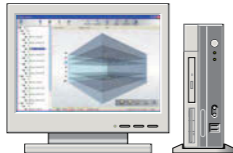

<p><b>Wired Remote Controller (Touch Panel)</b> UTY-RNRY</p> 	<p><b>Wired Remote Controller</b> UTY-RLRY</p> 	<p><b>Simple Remote Controller</b> UTY-RSKY With operation mode</p> 
<p><b>Simple Remote Controller</b> UTY-RHKY Without operation mode</p> 	<p><b>Wireless Remote Controller</b> UTY-LNHY</p> 	<p><b>IR Receiver Unit</b> UTB-YWC For All Duct type</p> 
<p><b>IR Receiver Unit</b> UTY-LRHYB1 For Cassette type</p> 		

**For Centralized Control**

<p><b>Group Remote Controller</b> UTY-CGGY</p> 	<p><b>Central Remote Controller</b> UTY-DCGY</p> 	<p><b>Touch Panel Controller</b> UTY-DTGY</p> 
<p><b>System Controller Lite</b> <span style="color: green;">Software</span> UTY-ALGX</p> 	<p><b>System Controller</b> <span style="color: green;">Software</span> UTY-APGX</p> 	

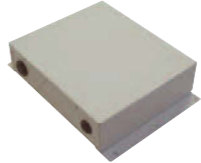
**Converters / Adaptors**

**For External device**

<p><b>BACnet® Gateway</b> <span style="color: green;">Software</span> UTY-ABGX</p>  <p>DVD-ROM (Software)    Software Protection Key</p>	<p><b>Network Converter for LonWorks®</b> UTY-VLGX</p> 	<p><b>KNX® Interface</b> FJ-RC-KNX-1i</p> 
<p><b>MODBUS® Interface</b> FJ-RC-MBS-1</p> 	<p><b>Wireless LAN Interface</b> FJ-RC-WIFI-1</p> 	<p><b>External Switch Controller</b> UTY-TEKX</p> 

**For System expansion**

<p><b>Network Converter</b> UTY-VGGXZ1</p> 	<p><b>Signal Amplifier</b> UTY-VSGXZ1</p> 
--	---













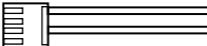

**Panels**

**For Cassette type**

<p><b>Cassette Grille</b> UTG-UFYC-W For Compact Cassette type</p> 	<p><b>Cassette Grille</b> UTG-UGYA-W For Cassette type</p> 
--	--

Others

Communication system: External Connect Kit

<p><b>For Indoor unit</b></p> <p>UTY-XWZXZ7 </p> <p>UTY-XWZXZB </p> <p>UTY-XWZXZC </p>	<p>UTY-XWZXZD </p> <p>UTY-XWZXZE </p>	<p><b>For Outdoor unit</b></p> <p>UTY-XWZXZ6 </p> <p>UTY-XWZXZ9 </p> <p>UTY-XWZXZF </p>
<p><b>For RB unit</b></p> <p>UTY-XWZXZ6 </p> <p>UTY-XWZXZB </p>	<p><b>For Central Remote Controller</b></p> <p>UTY-XWZXZ7 </p> <p>UTY-XWZXZ8 </p> <p>UTY-XWZXZA </p>	<p><b>For Touch Panel Controller</b></p> <p>UTY-XWZXZA </p>





Function list

	Indoor unit	Outdoor unit	Controller		Other
			Central Remote Controller	Touch Panel Controller	
Input	Operation / Stop	● UTY-XWZXZD ○ UTY-XWZXZB	—	—	—
	All On / All Off	—	—	● UTY-XWZXZ7 ○ UTY-XWZXZ8	—
	Batch Stop	—	● UTY-XWZXZ6	—	—
	Forced Stop	● UTY-XWZXZD ○ UTY-XWZXZB	—	—	—
	Emergency Stop	● UTY-XWZXZD ○ UTY-XWZXZB	● UTY-XWZXZ6	● UTY-XWZXZ7 ○ UTY-XWZXZ8	—
	Forced Thermostat off	● UTY-XWZXZE ○ UTY-XWZXZ7	—	—	—
	Low Noise Mode Operation	—	● UTY-XWZXZ6	—	—
	Cooling / Heating Priority	—	● UTY-XWZXZ6*1	—	● UTY-XWZXZ6 ○ UTY-XWZXZB
	*Outdoor Unit Operation Peak Control	—	● UTY-XWZXZ6	—	—
	*Power Usage Information from Electricity Meter	—	● UTY-XWZXZF	—	—
Output	Operation Status	● UTY-XWZXZC	○ UTY-XWZXZ6	○ UTY-XWZXZA	○ UTY-XWZXZA
	Error Status	● UTY-XWZXZC	○ UTY-XWZXZ6	○ UTY-XWZXZA	○ UTY-XWZXZA
	Indoor Unit Fun Operation Status	● UTY-XWZXZC	—	—	—
	Auxiliary Heater Output	● UTY-XWZXZC*2	—	—	—
	Base Heater	—	● UTY-XWZXZ9	—	—



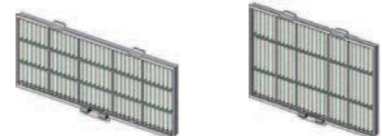

\*1. Heat Pump type only \*2. Duct type only

● : Dry Contact ○ : Apply Voltage

For Duct type

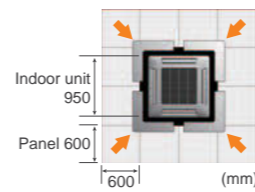
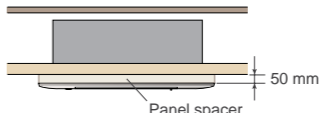
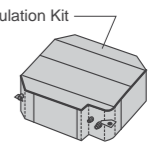
<p><b>Flange (Round)</b> UTD-RF204 For Medium Static Pressure Duct type / Ceiling type</p> 	<p><b>Flange (Square)</b> UTD-SF045T For Medium Static Pressure Duct type</p> 	<p><b>Remote Sensor Unit</b> UTY-XSZX For All Duct type</p> <p>New amenity space can be offered by installing the Remote sensor.</p> 
<p><b>Long-Life Filter</b> UTD-LF25NA For Medium Static Pressure Duct type UTD-LF60KA For High Static Pressure Duct type</p> 	<p><b>Auto Louver Grille Kit</b> UTD-GXSA-W (for ARXD04/07/09/12/14GALH) UTD-GXSB-W (for ARXD18GALH) UTD-GXSC-W (for ARXD24GALH) For Slim Duct type</p> 	<p><b>Drain Pump Unit</b> UTZ-PX1BBA For Low Static Pressure Duct type UTZ-PX1NBA For Medium Static Pressure Duct type</p> 

For Cassette type

<p><b>Wide Panel</b> UTG-AGYA-W For Cassette type</p> 	<p><b>Panel Spacer</b> UTG-BGYA-W For Cassette type</p> 	<p><b>Insulation Kit for High Humidity</b> UTZ-KXGA For Cassette type UTZ-KXGB For Slim Cassette type UTZ-KXGC For Compact Cassette type</p> 
<p><b>Fresh Air Intake Kit</b> UTZ-VXAA For Compact Cassette type UTZ-VXGA For Cassette type</p> 	<p><b>Air Outlet Shutter Plate</b> UTR-YDZB For Compact Cassette type Shuts the air outlet when only using as 3 blow out.</p> 	<p><b>Air Outlet Shutter Plate</b> UTR-YDZC For Cassette type Shuts the air outlet when only using as 3 blow out.</p> 

For Ceiling type

**Drain Pump Unit**  
UTR-DPB24T  
For Ceiling type



WATERSTAGE™ makes an Economical and  
Clean hot water heating system by Heat Pump

# AIR TO WATER



AIR TO WATER

#### Complete Solution meets various needs

The clean energy produced by WATERSTAGE™ reliably delivers "comfort" to all spaces in the home up to the living room, bedrooms, bath, and swimming pool.

**WATERSTAGE™**

- 202 All Type Lineup
- 204 Split type
- 205 Split DHW Integrated type
- 206 Monobloc type
- 207 Smart & Comfort Control
- 208 Case studies
- 210 Optional parts
- 212 Installation Limitations
- 213 Dimensions
- 214 Specifications

Capacity (kW)	5	6	8	10	11	14	16	
Split	High Power series Single phase Page 204 Hydraulic Unit/Outdoor Unit							
	High Power series 3 phase Page 204 Hydraulic Unit/Outdoor Unit							
	Comfort series Page 204 Hydraulic Unit/Outdoor Unit							
Split DHW integrated	High Power series Single phase Page 205 Hydraulic Unit/Outdoor Unit							
	High Power series 3 phase Page 205 Hydraulic Unit/Outdoor Unit							
	Comfort series Page 205 Hydraulic Unit/Outdoor Unit							
Monobloc	Compact series with hydraulic unit Page 206 Hydraulic Unit/Outdoor Unit							

**WHAT'S A HEAT PUMP ?**

Absorbing free energy from the atmosphere. Heat pump system requires only 1 kW of electricity to generate 3 to 5 kW thermal energy.

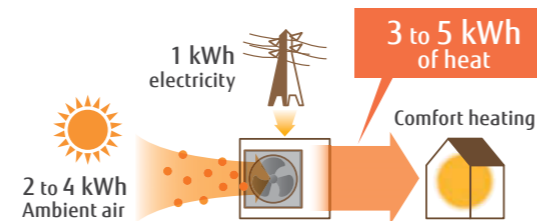

**High power series**

Hydraulic unit : WSYG140DC6 / [3phase] WSYK160DC9

Outdoor unit : WOYG112LCT / WOYG140LCT

[3phase] WOYK112LCT / WOYK140LCT / WOYK160LCT



**Comfort series**

Hydraulic unit : WSYA050DD6 / WSYA100DD6

Outdoor unit : WOYA060LDC / WOYA080LDC / WOYA100LDT



**High power series**

Hydraulic unit : WGYG140DD6 / [3phase] WGYK160DD9

Outdoor unit : WOYG112LCT / WOYG140LCT

[3phase] WOYK112LCT / WOYK140LCT / WOYK160LCT



**Comfort series**

Hydraulic unit : WGYA050DD6 / WGYA100DD6

Outdoor unit : WOYA060LDC / WOYA080LDC / WOYA100LDT

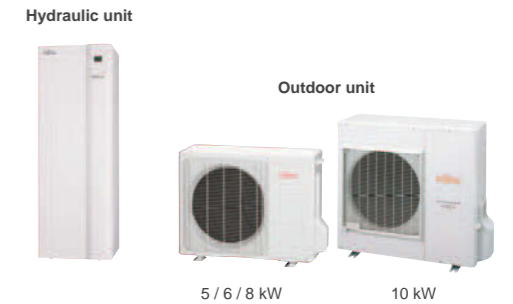

**Features**

**High Efficiency & Comfort**

**High leaving water temperature**

No backup heater\*

**High power series** : High leaving water temperature of 60°C is kept even when outdoor temperature is down to -20°C without using backup heaters.

At -20°C outdoor temperature : 60°C Hot water

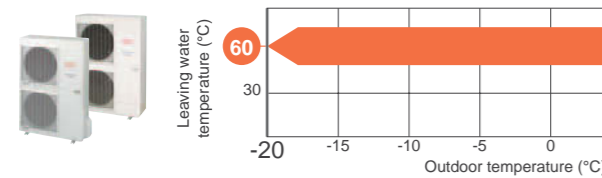

**Comfort series** : Maximum leaving water temperature is 55°C without backup heater. Hot water supply temperature can be maintained even at -7°C outdoor temperature.

At -7°C outdoor temperature : 55°C Hot water

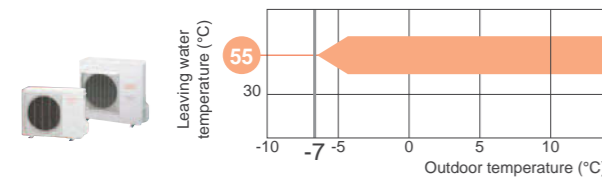

\* If you want to raise the hot water supply temperature, backup heaters can be used for auxiliary operation.

**High COP**

Air to water heat pumps work with much more efficiency and save more energy than a traditional heating system.



\*The data refer to 16kW type Condition : Outdoor Temp. 7°C Heating Temp. 35°C.

**Wide operation range**

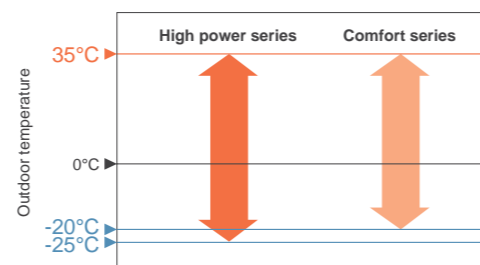

**Intelligent Control**

**2 Zone individual control\***

2 Zone individual control (2 under floor heating zones or under floor heating + radiator zone, etc.)\*

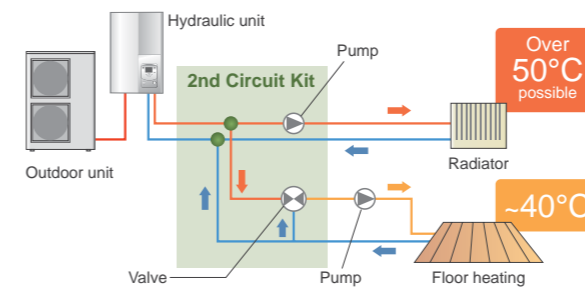

\*Optional parts are required.

**Automatic heating curve control**

Automatic temperature regulation in accordance with heating curve (Depends on heating terminal and outdoor temperature)

Automatic temperature control with heating curve

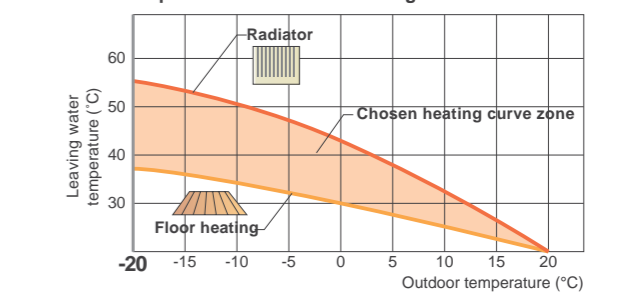

**High Reliability**

**High durability**

- Corrosion protected
- No flow switch and no filter necessary

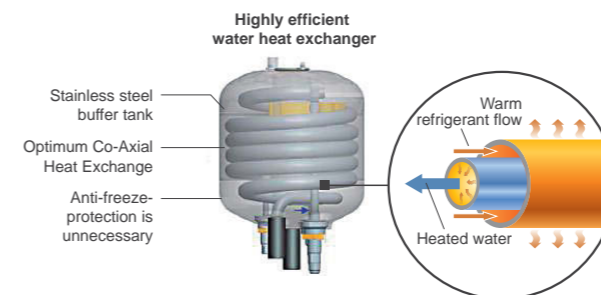

**Emergency operation**

System can continuously supply hot water by built in back up heater or boiler, as emergency, even if an error has occurred.

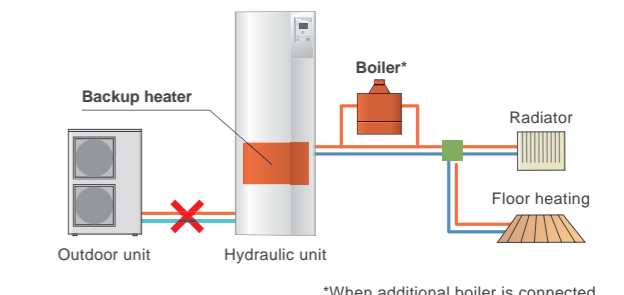

\*When additional boiler is connected

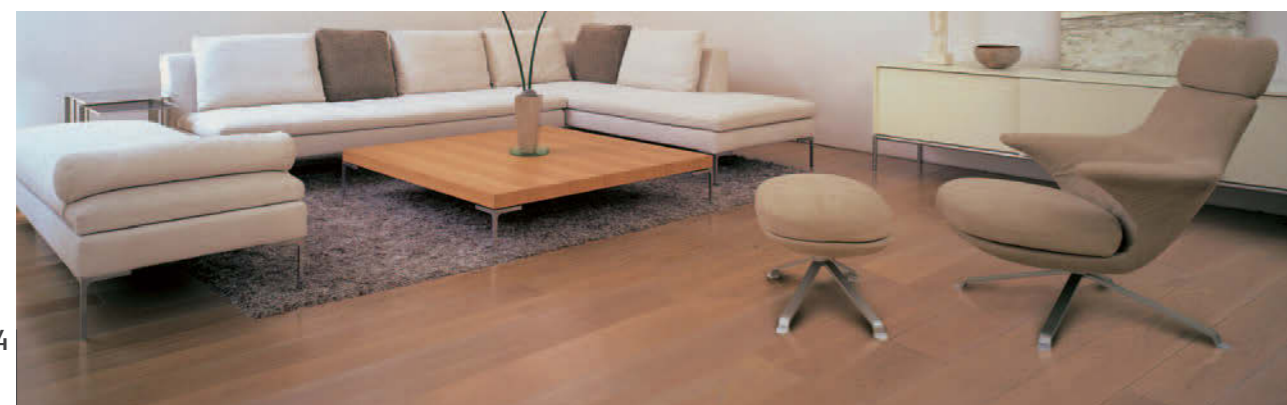

**Compact series**

Hydraulic unit : WSYF100DF6

Outdoor unit : **NEW** WPYA050LE / WPYA080LE / WPYA100LE



**Features**

**Compact & High Performance**

**High leaving water temperature**

High leaving water temperature of 55°C keeps to -20°C outdoor temperature without additional heater.

**No backup heater**

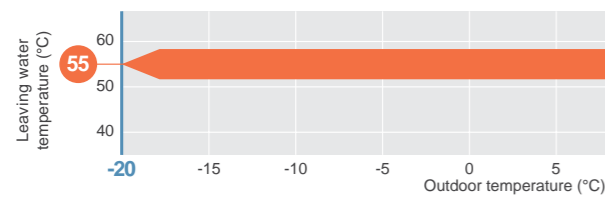

**High COP**

High COP is realized by using a DC twin rotary compressor, inverter technology, and high efficient water heat exchanger.

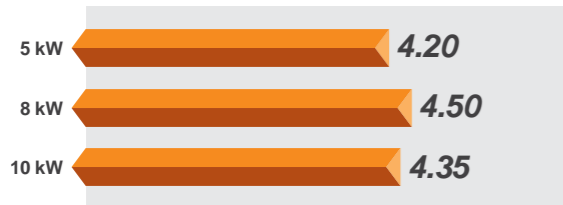

\*Condition: Outdoor Temp. 7°C Heating Temp. 35°C.

**Compact & light weight design**

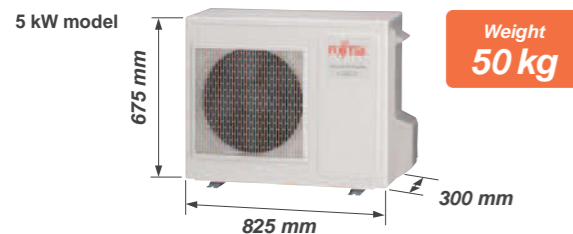

**Intelligent Control**

**Hydraulic unit can be connected**



**Features of the hydraulic unit**

- The compact Indoor unit provides two electrical back up heater, each with 3kW capacity
- 12 L expansion vessel included
- No waste of space. DHW Kit installation inside the hydraulic unit possible.
- New generation controller. Connection by Modbus protocol possible.
- Unit ready prepared for installing a heat meter.

**And more**

- Cooling operation is possible. • Anti-Legionella function
- Possible to docking the boiler (Field supplied)
- Modbus device connectable port available

**High Reliability**

**Anti-freeze function**

Water circulation and compression can be automatically performed at low outdoor temperature. Freezing of circulated water can be prevented.

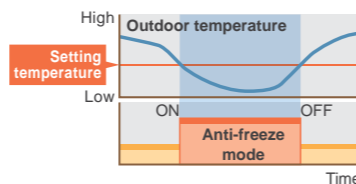

**Easy installation & maintenance**

- No installation of refrigerant circuit connections.
- Easy access for maintenance operations

**And more**

- Additional base heater (option) can be connected to prevent from freezing.

**Comfort**



**Large LCD panel**  
 • Operation status display  
 • Error display  
 • Plain text



**Simple operation mode setting**  
 • Selecting the heating mode and Domestic hot water operation

**Navigation and setting**  
 • Selecting the heating menu  
 • Setting program timer

**Automatic heating curve operation**

Automatic heating curve control based on outdoor temperature and setting room temperature. This can be adjusted when too warm or too cold.

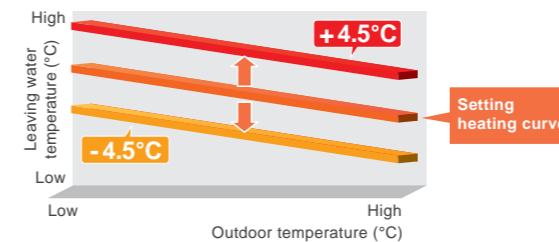

**Energy Saving**

**Programmable timer**

- The setting of timer operation can easily be adjusted.
- Changing the heating mode linked with time is possible.

Heating mode	
<b>Auto</b> Automatic mode Comfort/Reduce mode switching automatically according to outdoor temperature	<b>Comfort mode</b> Constant comfort temperature
<b>Reduce mode</b> Constant reduce temperature	<b>Protection mode</b> Stand-by mode with anti-frost protection

**Day-Weekly timer setting**

- The day-weekly timer can be set up for up to 3 times per day.
- Allows separate settings for each day of the week.

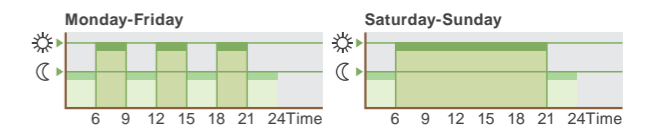

**Holiday timer setting**

- The holiday timer can be set up for up to 8 periods
- If you are absent for a long time in the winter, freezing of room can be prevented.

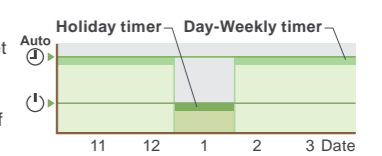

**Safety Function**

**Auto-changeover**

If the cooling operation function is set, the system can automatically switch to cooling or heating, depending on the outdoor temperature to provide all-season comfortable air conditioner.

**Extendibility**

**Remote control-extension**

Various remote controls are available on your hands. Remote control is also available via Web. All kinds of life styles are supported.

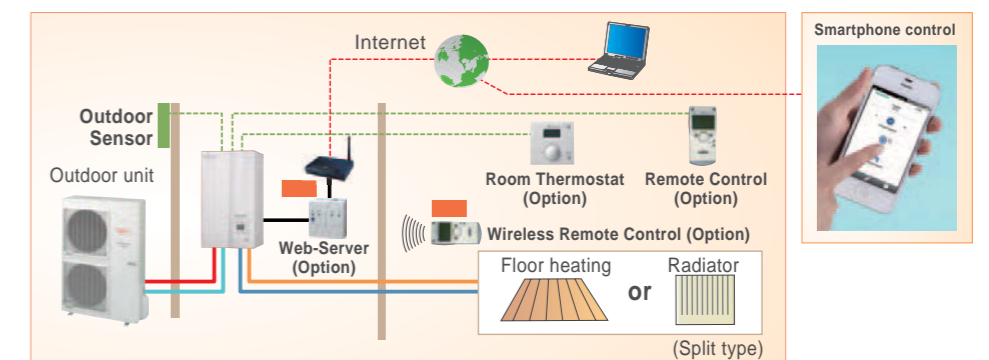



## Split Case studies

### 2 emitter simultaneous heating (Individual control)

Floor heating + Radiator

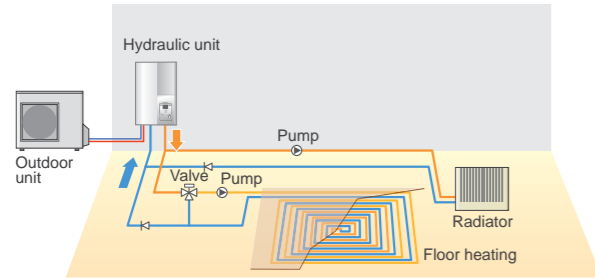

### Boiler connected to heating (Boiler + Heating)

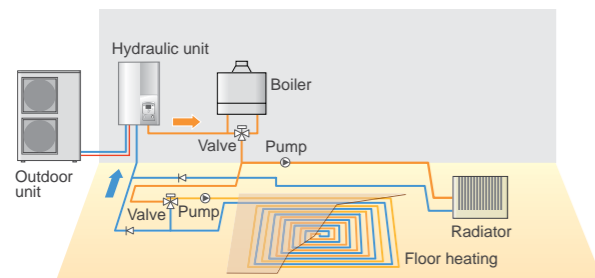

### 3 types of heat distribution

Floor heating + Radiator + Domestic Hot Water

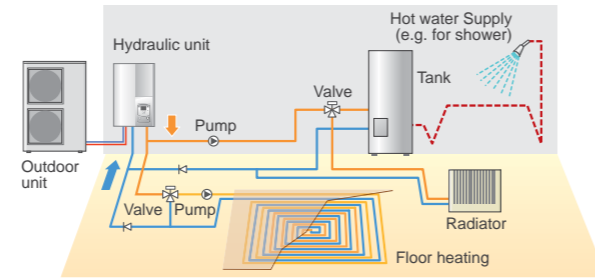

## Split DHW integrated Case studies

### Single heating & Domestic Hot Water

Radiator + Domestic Hot Water

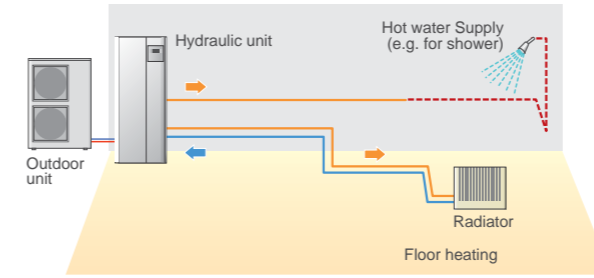

### Boiler connected to heating (Boiler + Heating) & Domestic Hot Water

Radiator + Domestic Hot Water

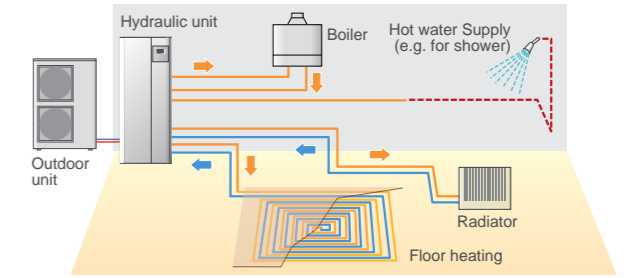

### 2 emitter simultaneous heating (Individual control) & Domestic Hot Water

Radiator + Domestic Hot Water

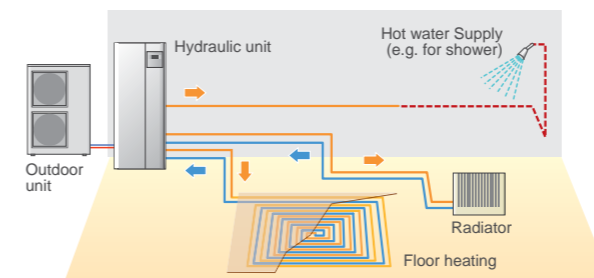

## Split Cascade System Case studies

### 2 emitter simultaneous heating (Individual control)

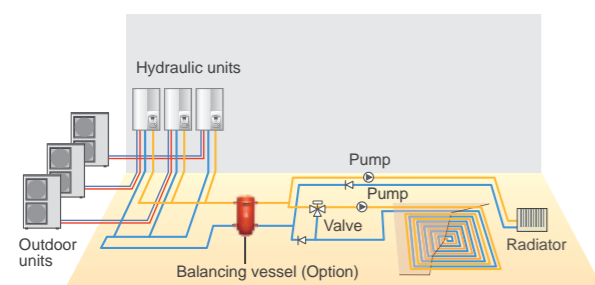

### 2 emitter simultaneous heating & Domestic Hot Water (type A)

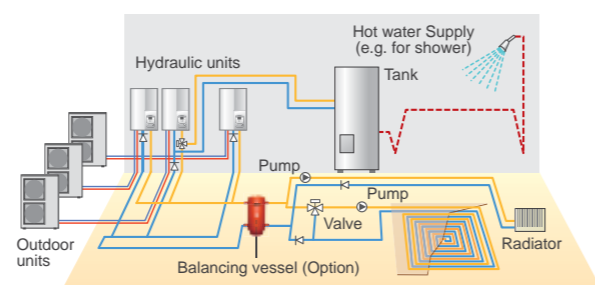

### Boiler connected to heating (Boiler + Heating)

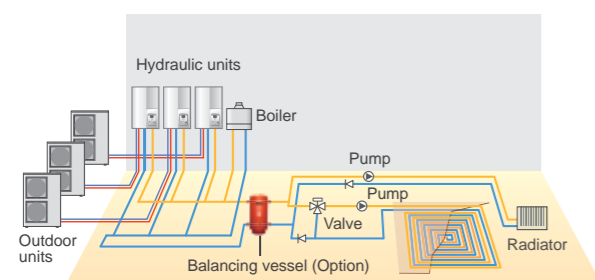

### 2 emitter simultaneous heating & Domestic Hot Water (type B)

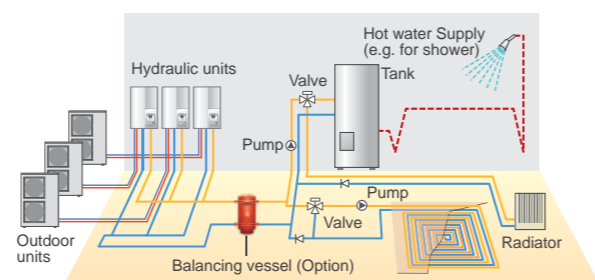

## Monobloc Case studies

### Single heating system

Floor heating

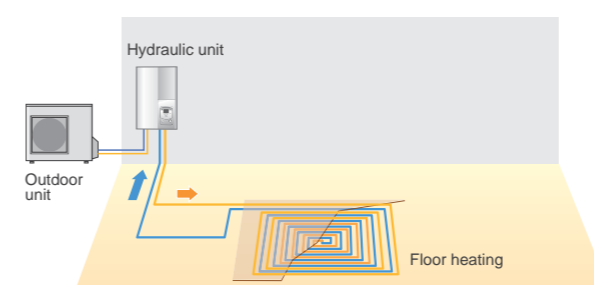

### 2 types of heat distribution

Floor heating + Domestic Hot Water

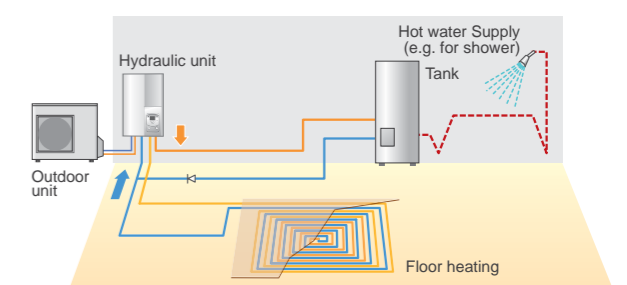





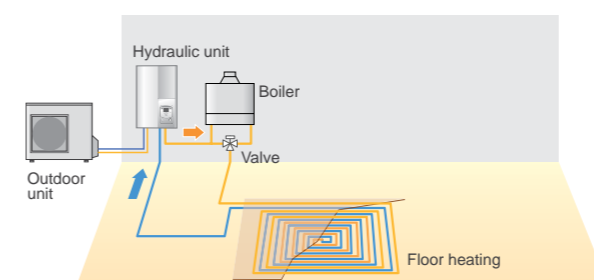













### Boiler connected to heating (Boiler + Heating)

Floor heating



OPTIONAL PARTS

Product Name	Model Name	Split										Monobloc			Split DHW integrated type															
		High Power					Comfort					Compact			High Power					Comfort										
		1Ø		3Ø			1Ø			1Ø			1Ø		3Ø			1Ø			1Ø		3Ø			1Ø				
		11	14	11	14	16	5	6	8	10	5	8	10	11	14	11	14	16	5	6	8	10	11	14	11	14	16	5	6	8
2nd Circuit Kit	 UTW-KZSXE	●	●	●	●	●	●	●	●	●	—	—	—	—	—	—	—	—	—	—	—	—	—	—	—	—	—	—	—	—
	 UTW-KZDXE	—	—	—	—	—	—	—	—	—	—	—	—	—	●	●	●	●	●	●	●	●	●	●	●	●	●	●	●	●
Boiler Connection kit	 UTW-KBSXD	●	●	●	●	●	●	●	●	●	●	●	—	—	—	—	—	—	—	—	—	—	—	—	—	—	—	—	—	—
	 UTW-KBDXD	—	—	—	—	—	—	—	—	—	—	—	—	—	●	●	●	●	●	●	●	●	●	●	●	●	●	●	●	●
Balancing vessel	 UTW-TEVXA	●	●	●	●	●	●	●	●	●	●	●	●	●	●	●	●	●	●	●	●	●	●	●	●	●	●	●	●	●
DHW kit	 UTW-KDWXF (Internal)	—	—	—	—	—	—	—	—	—	—	—	—	—	—	—	—	—	—	—	—	—	—	—	—	—	—	—	—	—
	 UTW-KDWXD (External)	●	●	●	●	●	●	●	●	●	—	—	—	—	—	—	—	—	—	—	—	—	—	—	—	—	—	—	—	—
DHW tank	 UTW-T20XA 200 Liter 300 Liter	●	●	●	●	●	●	●	●	●	●	●	—	—	—	—	—	—	—	—	—	—	—	—	—	—	—	—	—	—
	 UTW-T30XD 300 Liter	●	●	●	●	●	●	●	●	●	●	●	—	—	—	—	—	—	—	—	—	—	—	—	—	—	—	—	—	—
Circulating pump	 UTW-PHFXD	●	●	●	●	●	—	—	—	—	—	—	—	—	—	—	—	—	—	—	—	—	—	—	—	—	—	—	—	
Swimming Pool kit	 UTW-KSPXD	●	●	●	●	●	●	●	●	●	●	●	●	●	●	●	●	●	●	●	●	●	●	●	●	●	●	●	●	●
Heat Exchanger for swimming pool kit	 UTW-ESPXA	●	●	●	●	●	●	●	●	●	●	●	●	●	●	●	●	●	●	●	●	●	●	●	●	●	●	●	●	●
Cooling kit	 UTW-KCLXD	●	●	●	●	●	●	●	●	—	—	—	—	—	—	—	—	—	—	—	—	—	—	—	—	—	—	—	—	—
Regulation Extension Kit	 UTW-KREXD	●	●	●	●	●	●	●	●	●	●	●	●	●	●	●	●	●	●	●	●	●	●	●	●	●	●	●	●	●
Solar Regulation Kit	 UTW-KSRXE	●	●	●	●	●	●	●	●	●	●	●	—	—	—	—	—	—	—	—	—	—	—	—	—	—	—	—	—	—
Mode Exchange Kit	 UTW-KMEXE	●	●	●	●	●	●	●	●	●	●	●	●	●	●	●	●	●	●	●	●	●	●	●	●	●	●	●	●	●
Low Noise Kit	 UTW-KLNXE	●	●	●	●	●	—	—	—	—	—	—	—	—	—	—	—	—	—	—	—	—	—	—	—	—	—	—	—	—
HMI Kit	 UTW-KHMXE <sup>5</sup>	●	●	●	●	●	●	●	●	●	●	●	●	●	●	●	●	●	●	●	●	●	●	●	●	●	●	●	●	●
Drain Pan	 UTW-KDPXA	—	—	—	—	—	●	●	●	—	—	—	—	—	—	—	—	—	—	—	—	—	—	—	—	—	—	—	—	—

Product Name	Model Name	Split										Monobloc			Split DHW integrated type															
		High Power					Comfort					Compact			High Power					Comfort										
		1Ø		3Ø			1Ø			1Ø			1Ø		3Ø			1Ø			1Ø		3Ø			1Ø				
		11	14	11	14	16	5	6	8	10	5	8	10	11	14	11	14	16	5	6	8	10	11	14	11	14	16	5	6	8
Remote Controller	 Wired	UTW-C75XA	●	●	●	●	●	●	●	●	●	●	●	●	●	●	●	●	●	●	●	●	●	●	●	●	●	●	●	●
	 Wireless	UTW-C75XA-E <sup>5</sup>	●	●	●	●	●	●	●	●	●	●	●	●	●	●	●	●	●	●	●	●	●	●	●	●	●	●	●	●
Room Thermostat	 Wired	UTW-C55XA	●	●	●	●	●	●	●	●	●	●	●	●	●	●	●	●	●	●	●	●	●	●	●	●	●	●	●	●
	 Wireless	UTW-C58XD	●	●	●	●	●	●	●	●	●	●	●	●	●	●	●	●	●	●	●	●	●	●	●	●	●	●	●	●
Outdoor Sensor Transmitter	 UTW-MOSXD	●	●	●	●	●	●	●	●	●	●	●	●	●	●	●	●	●	●	●	●	●	●	●	●	●	●	●	●	●
RF Modules	 for X60-Port	UTW-M60XD	●	●	●	●	●	●	●	●	●	●	●	●	●	●	●	●	●	●	●	●	●	●	●	●	●	●	●	●
	 for BSB-Port	UTW-MRCXD	●	●	●	●	●	●	●	●	●	●	●	●	●	●	●	●	●	●	●	●	●	●	●	●	●	●	●	●
Web server	 UTW-KWSXD	●	●	●	●	●	●	●	●	●	●	●	●	●	●	●	●	●	●	●	●	●	●	●	●	●	●	●	●	●
	 UTW-KW1XD UTW-KW4XD	●	●	●	●	●	●	●	●	●	●	●	●	●	●	●	●	●	●	●	●	●	●	●	●	●	●	●	●	●
Cascade Master Kit (incl. LPB Clip)	 UTW-KCMXE	●	●	●	●	●	—	—	—	—	—	—	—	—	—	—	—	—	—	—	—	—	—	—	—	—	—	—	—	
Cascade Slave Kit (incl. LPB Clip)	 UTW-KCSXE	●	●	●	●	●	—	—	—	—	—	—	—	—	—	—	—	—	—	—	—	—	—	—	—	—	—	—	—	
LPB Clip	 UTW-KL1XD	●	●	●	●	●	●	●	●	●	●	●	●	●	●	●	●	●	●	●	●	●	●	●	●	●	●	●	●	●
Modbus Clip	 UTW-KMBXE	—	—	—	—	—	—	—	—	—	—	—	—	—	—	—	—	—	—	—	—	—	—	—	—	—	—	—	—	—
Base Heater	 UTW-HAMXE	—	—	—	—	—	—	—	—	—	—	—	—	—	—	—	—	—	—	—	—	—	—	—	—	—	—	—	—	—
	 UTW-HAMXF	—	—	—	—	—	—	—	—	—	—	—	—	—	—	—	—	—	—	—	—	—	—	—	—	—	—	—	—	—
Service Tool (incl. OC1700 adaptor)	 UTW-KSTXD	● <sup>3</sup>	● <sup>3</sup>	● <sup>3</sup>	● <sup>3</sup>	● <sup>3</sup>	● <sup>3</sup>	● <sup>3</sup>	● <sup>3</sup>	● <sup>3</sup>	● <sup>3</sup>	● <sup>3</sup>	● <sup>3</sup>	● <sup>3</sup>	● <sup>3</sup>	● <sup>3</sup>	● <sup>3</sup>	● <sup>3</sup>	● <sup>3</sup>	● <sup>3</sup>	● <sup>3</sup>	● <sup>3</sup>	● <sup>3</sup>	● <sup>3</sup>	● <sup>3</sup>	● <sup>3</sup>	● <sup>3</sup>	● <sup>3</sup>	● <sup>3</sup>	
Service Tool Software	 UTW-KPSXD	● <sup>4</sup>	● <sup>4</sup>	● <sup>4</sup>	● <sup>4</sup>	● <sup>4</sup>	● <sup>4</sup>	● <sup>4</sup>	● <sup>4</sup>	● <sup>4</sup>	● <sup>4</sup>	● <sup>4</sup>	● <sup>4</sup>	● <sup>4</sup>	● <sup>4</sup>	● <sup>4</sup>	● <sup>4</sup>	● <sup>4</sup>	● <sup>4</sup>	● <sup>4</sup>	● <sup>4</sup>	● <sup>4</sup>	● <sup>4</sup>	● <sup>4</sup>	● <sup>4</sup>	● <sup>4</sup>	● <sup>4</sup>	● <sup>4</sup>	● <sup>4</sup>	
External connect kit	 UTW-XWZX22	●	●	●	●	●	—	—	—	—	—	—	—	—	—	—	—	—	—	—	—	—	—	—	—	—	—	—	—	

● : Available — : Not Available

\*1: DHW operation is possible without DHW Kit and DHW Tank.  
 \*2: Cooling operation is possible without cooling kit  
 \*3: UTW-KL1XD is required for the connection.  
 \*4: UTW-KW1XD or UTW-KW4XD is required for the connection.  
 \*5: Eastern European Language(English, Czech Republic, Slovakia, Poland, Turkey, Hungary, Russia, Slovenia, Greece, Serbia)  
 \*6: Not in combination with Modbus Clip UTW-KMBXE

## Equipment Installation

### Split type Hydraulic unit

- Hydraulic unit is to be hang on the wall
- Weight < 60 kg (including water)
- Space for maintenance should be respected

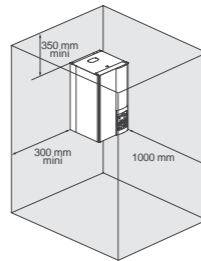

### Split DHW integrated type Hydraulic unit

- Floor stand
- Weight 366 kg (including water)
- Space for maintenance should be respected.

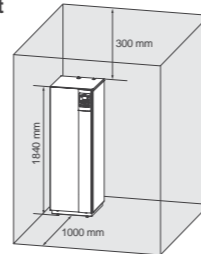

### Monobloc Type Hydraulic unit

- Hydraulic unit is to be hang on the wall
- Weight < 60kg (including water)
- Distances for maintenance should be respected

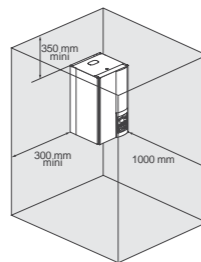

### Monobloc type Outdoor unit

- Floor stand
- Weight 74 kg (without water)
- Distances for maintenance should be kept

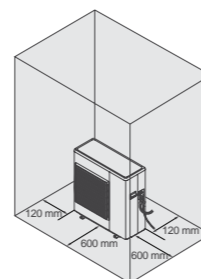

## Piping and Wiring

### Split type

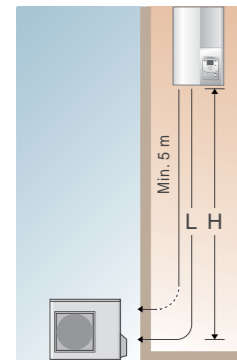

Series	Capacity range(kW)	H (m)	L (m)
Comfort	5	± 15	5-20
	6		
	8		
	10		
High power	11	± 15	5-20
	14		
	16		

### Electrical wiring

#### Split type

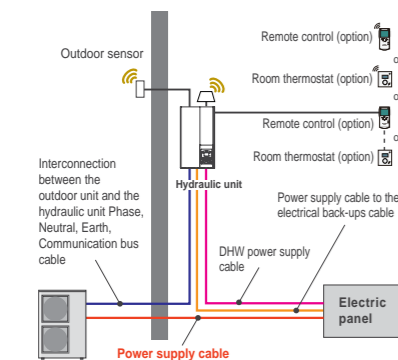

#### Split DHW integrated type

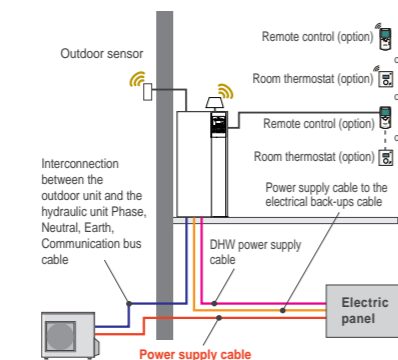

#### Monobloc Type with Hydraulic unit

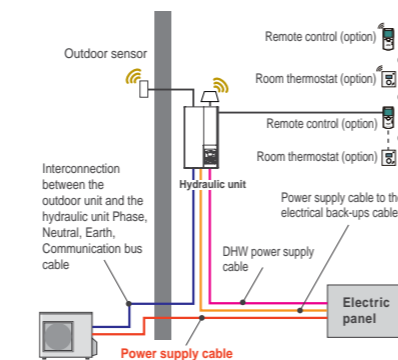

### SPLIT TYPE

Outdoor Units Comfort series :  
WOYA060LDC / Woya080LDC

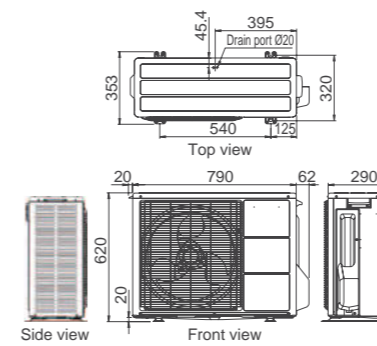

WOYA100LDT

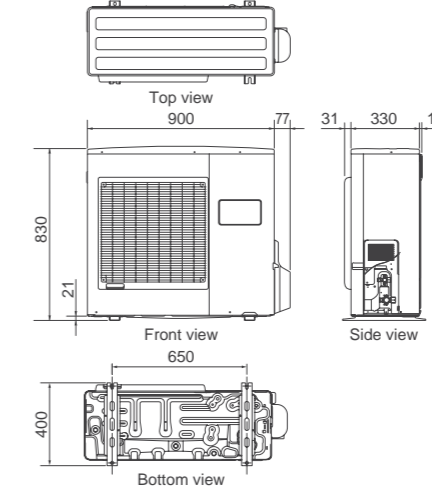

Outdoor Units High Power series :  
WOYK112LCT / Woyk140LCT / Woyk160LCT

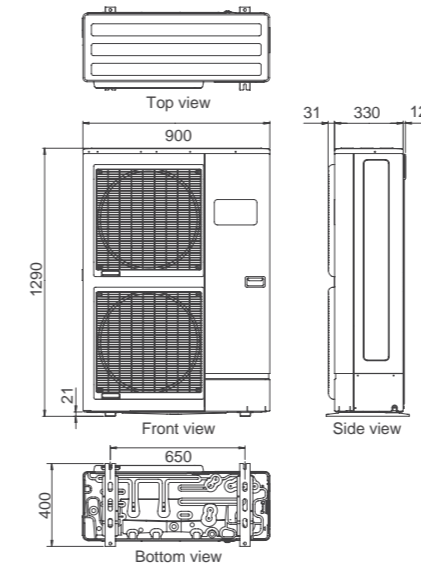

Outdoor Units High Power series :  
WOYG112LCT / Woyg140LCT

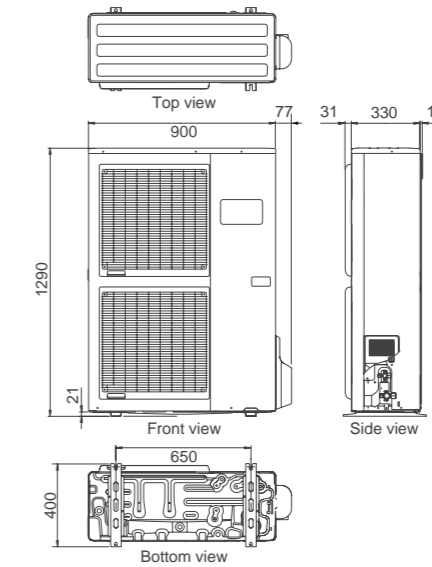

Hydraulic units Split type  
High Power series :  
WSYG140DC6 / WSYK160DC9

Hydraulic units Split type  
Comfort series :  
WSYA050DD6 / WSYA100DD6

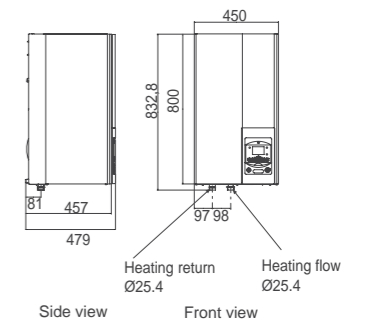

Hydraulic units Split DHW  
integrated type High Power series :  
WGYG140DD6 / WGYK160DD9

Hydraulic units Split DHW  
integrated type Comfort series :  
WGYA050DD6 / WGYA100DD6

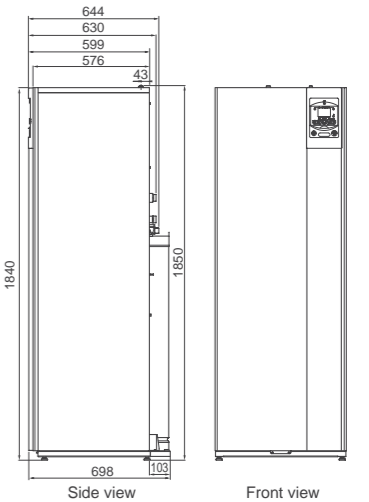

### MONOBLOC TYPE

Compact series :  
WPYA050LE

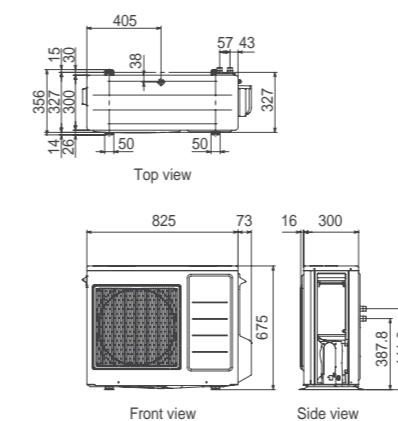

WPYA080LE / Wpya100LE

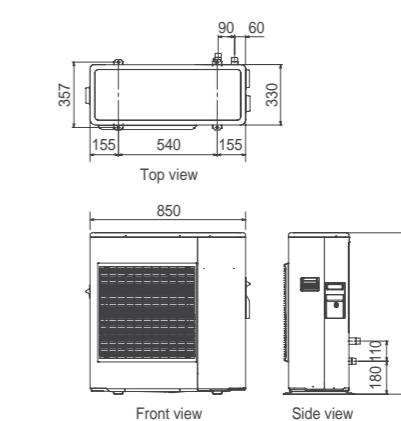

Hydraulic unit :  
WSYP100DF6

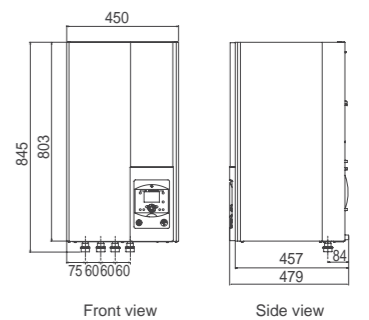

Split type

Series name			High Power series					Comfort series												
Capacity range (kW)			11	14	11	14	16	5	6	8	10									
+7°C / +35°C floor heating *1	Heating capacity	kW	10.80	13.50	10.80	13.50	15.17	4.50	6.00	7.50	10.00									
	Input power		2.54	3.23	2.51	3.20	3.70	0.996	1.41	1.84	2.49									
	COP		4.25	4.18	4.30	4.22	4.10	4.52	4.27	4.08	4.02									
+2°C / +35°C floor heating *1	Heating capacity	kW	10.77	12.00	10.77	13.00	13.50	4.50	4.95	5.65	7.70									
	Input power		3.44	3.87	3.40	4.15	4.34	1.39	1.53	1.78	2.47									
	COP		3.13	3.10	3.17	3.13	3.11	3.24	3.24	3.17	3.12									
-7°C / +35°C floor heating *1	Heating capacity	kW	10.80	12.00	10.80	13.00	13.50	4.10	4.60	5.70	7.40									
	Input power		4.32	5.08	4.28	5.18	5.40	1.47	1.74	2.23	2.97									
	COP		2.50	2.36	2.52	2.51	2.50	2.79	2.64	2.56	2.49									
+7°C / +45°C radiators *1	Heating capacity	kW	9.23	11.54	10.10	12.60	13.00	4.50	5.10	6.20	8.27									
	Input power		2.84	3.72	3.01	3.81	4.00	1.30	1.50	1.87	2.53									
	COP		3.25	3.10	3.35	3.30	3.25	3.46	3.40	3.31	3.27									
-7°C / +45°C radiators *1	Heating capacity	kW	9.16	11.45	10.02	12.50	13.00	4.10	4.45	5.05	7.40									
	Input power		4.58	5.92	4.63	6.00	6.37	1.86	2.04	2.47	3.70									
	COP		2.00	1.93	2.16	2.08	2.04	2.20	2.18	2.04	2.00									
Backup heater	Capacity	kWxpcs.	6.0 (3.0x2 pcs.)			9.0 (3.0 x 3 pcs.)			6.0 (3.0x2 pcs.)											
Hydraulic unit			Model name			WSYG140DC6			WSYK160DC9			WSYA050DD6			WSYA100DD6					
Power source			1Ø 230V, 50Hz			3Ø 400V, 50Hz			1Ø 230V, 50Hz											
Water circulation			Rated	L/min	25.0 / 50.0			8.1/16.2			10.8/21.7			13.5/27.1						
Dimensions HxWxD			mm			800 x 450 x 457			800 x 450 x 457											
Weight (Net)			kg			42			42											
Buffer tank capacity			L			16			16											
Expansion vessel capacity			L			8			8											
Leaving water temperature range			°C			8 to 60			8 to 55											
Water pipe connection diameter			Flow / Return			mm			Ø25.4 / Ø25.4			Ø25.4 / Ø25.4								
Outdoor unit			Model name			WOYG112LCT WOYG140LCT WOYK112LCT WOYK140LCT WOYK160LCT			WOYA060LDC			WOYA080LDC WOYA100LDT								
Power source			1Ø 230V, 50Hz			3Ø 400V, 50Hz			1Ø 230V, 50Hz											
Current			Rated	A	11.4			14.2			3.7			4.8			5.5			
Noise level (Sound pressure)			Max	dB(A)	22.0			25.0			8.5			9.5			10.5			
Dimensions HxWxD			mm			1290 x 900 x 330			620 x 790 x 290			830 x 900 x 330								
Weight (Net)			kg			92			99			41			42			60		
Refrigerant			R410A			R410A			R410A											
Refrigerant amount			kg			2.50			1.10			1.40			1.80					
Additional refrigerant charge amount			g/m			50			20			20			40					
Connector pipe			Diameter	Liquid	mm	Ø9.52			Ø6.35			Ø9.52								
				Gas	mm	Ø15.88			Ø12.70			Ø15.88								
			Length	Min / Max	m	5 / 20			5 / 20											
			Length (chargeless)	Max	m	15			7.5											
			Height difference	Max	m	15			15											
Operation range			Heating			°C			-25 to 35			-20 to 35								

Split DHW integrated type

Series name			High Power series					Comfort series												
Capacity range (kW)			11	14	11	14	16	5	6	8	10									
+7°C / +35°C floor heating *1	Heating capacity	kW	10.80	13.50	10.80	13.50	15.17	4.50	6.00	7.50	10.00									
	Input power		2.54	3.23	2.51	3.20	3.70	0.996	1.41	1.84	2.49									
	COP		4.25	4.18	4.30	4.22	4.10	4.52	4.27	4.08	4.02									
+2°C / +35°C floor heating *1	Heating capacity	kW	10.77	12.00	10.77	13.00	13.50	4.50	4.95	5.65	7.70									
	Input power		3.44	3.87	3.40	4.15	4.34	1.39	1.53	1.78	2.47									
	COP		3.13	3.10	3.17	3.13	3.11	3.24	3.24	3.17	3.12									
-7°C / +35°C floor heating *1	Heating capacity	kW	10.80	12.00	10.80	13.00	13.50	4.10	4.60	5.70	7.40									
	Input power		4.32	5.08	4.28	5.18	5.40	1.47	1.74	2.23	2.97									
	COP		2.50	2.36	2.52	2.51	2.50	2.79	2.64	2.56	2.49									
+7°C / +45°C radiators *1	Heating capacity	kW	9.23	11.54	10.10	12.60	13.00	4.50	5.10	6.20	8.27									
	Input power		2.84	3.72	3.01	3.81	4.00	1.30	1.50	1.87	2.53									
	COP		3.25	3.10	3.35	3.30	3.25	3.46	3.40	3.31	3.27									
-7°C / +45°C radiators *1	Heating capacity	kW	9.16	11.45	10.02	12.50	13.00	4.10	4.45	5.05	7.40									
	Input power		4.58	5.92	4.63	6.00	6.37	1.86	2.04	2.47	3.70									
	COP		2.00	1.93	2.16	2.08	2.04	2.20	2.18	2.04	2.00									
Backup heater	Capacity	kWxpcs.	6.0 (3.0x2 pcs.)			9.0 (3.0 x 3 pcs.)			6.0 (3.0x2 pcs.)											
Hydraulic unit			Model name			WGYG140DD6			WGYK160DD9			WGYA050DD6			WGYA100DD6					
Power source			1Ø 230V, 50Hz			3Ø 400V, 50Hz			1Ø 230V, 50Hz											
Water circulation			Rated	L/min	25.0 / 50.0			8.1/16.2			10.8/21.7			13.5/27.1						
Dimensions HxWxD			mm			1840 x 648 x 698			1840 x 648 x 698											
Weight (Net)			kg			152			152											
DHW capacity			L			190			190											
Hot water heater capacity			kW			1.5			1.5											
Buffer tank capacity			L			16			16											
Expansion vessel capacity			L			12			12											
Leaving water temperature range			°C			8 to 60			8 to 55											
Water pipe connection diameter			Flow / Return			mm			Ø25.4 / Ø25.4			Ø25.4 / Ø25.4								
Hot water pipe diameter			mm			(Inlet/Outlet) Ø19.05			(Inlet/Outlet) Ø19.05											
Outdoor unit			Model name			WOYG112LCT WOYG140LCT WOYK112LCT WOYK140LCT WOYK160LCT			WOYA060LDC			WOYA080LDC WOYA100LDT								
Power source			1Ø 230V, 50Hz			3Ø 400V, 50Hz			1Ø 230V, 50Hz											
Current			Rated	A	11.4			14.2			3.7			4.8			5.5			
Noise level (Sound pressure)			Max	dB(A)	22.0			25.0			8.5			9.5			10.5			
Dimensions HxWxD			mm			1290 x 900 x 330			620 x 790 x 290			830 x 900 x 330								
Weight (Net)			kg			92			99			41			42			60		
Refrigerant			R410A			R410A			R410A											
Refrigerant amount			kg			2.50			1.10			1.40			1.80					
Additional refrigerant charge amount			g/m			50			20			20			40					
Connector pipe			Diameter	Liquid	mm	Ø9.52			Ø6.35			Ø9.52								
				Gas	mm	Ø15.88			Ø12.70			Ø15.88								
			Length	Min / Max	m	5 / 20			5 / 20											
			Length (chargeless)	Max	m	15			7.5											
			Height difference	Max	m	15			15											
Operation range			Heating			°C			-25 to 35			-20 to 35								

\*1. The values of heating capacity/power input/COP are based on measurement of EN14511 standard. Usage environment, such as operation of the heating equipment, room temperature, and controller adjustments, may cause disparities between practically determined values and spec. values and these values.  
\*2. Sound pressure level measured at distance of 1m from the device.

Monobloc type

Series name			Compact series											
Capacity range (kW)			5	8	10									
+7°C / +35°C floor heating *1	Heating capacity	kW	5.00	8.00	10.00									
	Input power		1.19	1.78	2.30									
	COP		4.20	4.50	4.35									
+2°C / +35°C floor heating *1	Heating capacity	kW	3.86	7.40	8.10									
	Input power		1.20	2.73	3.00									
	COP		3.22	2.71	2.70									
-7°C / +35°C floor heating *1	Heating capacity	kW	3.55	7.10	8.00									
	Input power		1.38	2.93	3.32									
	COP		2.57	2.42	2.41									
+7°C / +45°C radiators *1	Heating capacity	kW	4.40	7.80	9.80									
	Input power		1.42	2.23	2.88									
	COP		3.10	3.50	3.40									
-7°C / +45°C radiators *1	Heating capacity	kW	3.50	6.50	7.00									
	Input power		1.69	2.98	3.31									
	COP		2.07	2.18	2.11									
Backup heater	Capacity	kWxpcs.	6.0 (3.0x2 pcs.)		6.0 (3.0x2 pcs.)									
Hydraulic unit			Model name			WSYP100DF6								
Power source			1Ø 230V, 50Hz											
Dimensions HxWxD			mm			803 x 450 x 457								
Weight (Net)			kg			40								
Buffer tank capacity			L			22								
Expansion vessel capacity			L			12								
Water pipe connection diameter			Flow / Return			mm								
Monobloc unit			Model name			WPYA050LE			WPYA080LE			WPYA100LE		
Power source			1Ø 230V, 50Hz											
Water circulation			Rated	L/min	14.4			22.9			28.7			
			Min / Max		5.0 / 20.0			10.0 / 30.0			10.0 / 30.0			
Current			Rated	A	5.2			8.30			10.20			
Noise level (Sound pressure)			Max	dB(A)	48 <sup>2</sup>			51 <sup>2</sup>			51 <sup>2</sup>			
Dimensions HxWxD			mm			675 x 825 x 300			881.5 x 850 x 330					
Weight (Net)			kg			50			74					
Water pipe connection diameter			Flow / Return			mm			Ø19.05 / Ø19.05			Ø25.4 / Ø25.4		
Refrigerant			R410A			R410A			R410A					
Refrigerant amount			kg			1.05			1.5					
Leaving water temperature range			°C			8 to 55			8 to 55					
Operation range			Heating			°C			-20 to 35					