

Product summary

emcovent window ventilation systems emcovent sound insulating systems

emcobad

emcobau

emcoklima



emcovent **Decentralized window ventilation and sound insulating systems**

Air is one of our most precious commodities. Until the 1970s, the idea of ventilation was not considered to be a high priority. This changed with the commencement of the Heat Insulation Ordinance in 1977-1978 as well as the Energy Savings Ordinance in 2002, both acts having effected controlled and energy-saving ventilation practices. Noise from street, air and railway traffic are considered by a large proportion of the population to be a disturbance. Normal working, living and sleeping conditions are all subject to stress and other interferences. Changing condi-

tions of daily life set new demands for ventilation technology. emco started business more than 30 years ago with a series of reliable air diffusers conformant with the technological status at that time. Systematic development for various air flow systems, flexibility in creating individual solutions and on-schedule delivery have created a relationship of trust between emco and its partners. Today emco offers an extensive range of products for air and water flow systems as well as a wide

array of accompanying services, including calculations with proprietary computer programmes and lab testing. emco's decentralised window ventilation systems open up a whole new world of possibilities to architects and planners for controlled, healthy and energy-saving ventilation technology. Because more than ever, well-being is the basic prerequisite for performance, safety and health of building's occupants.



emcovent **decentralized window ventilation systems**

emcovent **decentralized sound insulating systems**

The suitable ventilation solution ...

emcovent series LR 6, LR/LSR 10, LR/LSR16 and emcovent serie LS 10 offer architects and specialist planners many different ventilation options for diverse and varied installation locations. All devices ensure that the user's wishes of versatility and design are achieved and at the same time they guarantee optimal fresh-air supply and the necessary noise insulation – providing comfort and quietness.

The LS 10 system – tried and tested on the market – as well as the various configurations listed here help to create a new quality of life even in areas plagued by high levels of noise, for example busy streets, near railway lines or airports.

Modular & flexibel

Regardless of how your emcovent solution is mounted – under the window sill, above or below the window detail elements, laterally between the frame and the masonry, horizontally

or vertically in the window transom, visible or covered: emcovent ventilation units allow for a wide architectural and planning scope. This flexibility means that together with architects, we have been able to provide suitable client solutions and configurations for just about any installation situation. We decide quickly which solution would bring the most benefit to the client, but always keep in mind the individual needs of the client.

The emcovent series is most commonly installed in administrative and office buildings, hotels, apartment houses that are located in noisy areas. All the models listed here serve to maintain high quality in living and working areas as well as in air cleanliness.

Furthermore they help to save energy by way of controlled ventilation.

The units are all available with many special technical features.

The advantages for architects, planners and users lie in the planning and configuration. The units are available in various sizes and heights, and can be used in both visible as well as covered installation situations, making it easy to select the ideal solution to fit the structural conditions. Another advantage: All emcovent options are variable in their length and depth. Even retroactive changes in the equipment often can be made if allowances were made for this during planning.

Meaning of letters in the emcovent product designation:

- L = Ventilaton product**
- S = Sound insulation product**
- R = roomside round profile**

Quick Selection Chart

Which product offers which solution to which installation situation ?

Model*	Installation Situation				Ventilation Solution				
	Window	Sill	Wall	ceiling	Heat Recovery	Noise	Over-Humidifying	Over-Heating	Heating
emcovent S8 Sound insulating ventilator	●	■				●	●	●	
emcovent LR10 Permanent ventilator with/ without fan	●	■	●	●			●	●	
emcovent LSR10 Sound insulating ventilator	●	■	●	●		●	●	●	
emcovent LR16	●	■	●	●			●	●	
emcovent LSR16 Sound insulating ventilator	●	■	●	●		●	●	●	
emcovent LS10 Sound insulating ventilator	●	●	●	●		●	●	●	●
emcovent eco50 Sound insulating ventilator with heat recovery	●	●	●	●	●	●	●	●	

● = available ■ = limited availability; all other options not available or only upon request

... for your needs.

Product advantages

- Variable depth (z.B. LS 10) and length
- High-grade aluminium system sections
- Surfaces easy to clean and maintain
- Excellent sound insulating characteristics
- Excellent thermal insulating characteristics
- Variable volume flow rates with fan equipment
- Natural ventilation depending on the pressure difference
- Manual or electronic control equipment (depending on the model)
- Integrated intake or exhaust sections
- Low-maintenance
- Thermally separated sections
- Reversible and removable from inside
- Energy-saving through controlled ventilation
- Heat recovery in emcofront eco50 (heat recovery, humidity control, bypass control)
- Suitable for new buildings as well as restoration projects
- Modular design (system customisation possible)
- Smooth integration into the structure

Model/Installation Requirements	emcovent S8	emcovent LR10	emcovent LSR10	emcovent LR16	emcovent LSR16	emcovent LS10	emcovent eco50
Installation height [mm]	89	105	105	162	162	100	190
Installation width [mm]	800	ab 500/600 ³⁾	ab 850	ab 600	ab 700 ³⁾	ab 800	ab 1200
Installation depth [mm]	86/100	179/195	179/195	261/279	261/279	250-...variabel	370
Sound insulation [dB] open as EN ISO 717-1, 140-10	D _{n,e,w} 49 R _{w1,9} 42 R _w 29	–	D _{n,e,w} 53 R _{w1,9} 46 R _w 33	–	D _{n,e,w} 49 R _{w1,9} 42 R _w 32	D _{n,e,w} 61 R _{w1,9} 54 R _w 42	D _{n,e,w} 54 – R _w 39
Operating voltage [V, Hz]	230, 50 ¹⁾	230, 50	230, 50	230, 50	230, 50	230, 50	230, 50
Volume of air [m ³ /h] min./max. at Δp 0 Pa	18-30/40 ²⁾	110 ⁴⁾	110 ⁴⁾	350 ⁴⁾	260/350 ⁴⁾	30/50/80 ⁴⁾	60/90/120
Sound pressure level [dB(A)] at 8 dB-room attention, level 1	30/35	35	30/35	25 - ... > ⁴⁾	25 - ... > ⁴⁾	25 - ... > ⁴⁾	24
Power consumption from - to [watt]	0 - 30 ⁵⁾	25 ⁵⁾	25 ⁵⁾	55 ⁵⁾	43/55 ⁵⁾	0 - 40 ⁶⁾	max. 150
Energy recovery	–	–	–	–	–	–	50-75% ⁷⁾
Elektric shut-off	optional	ja	ja	ja	ja	optional	ja
Manual shut-off	ja	–	–	–	–	ja	–
Reversible	ja	ja	ja	ja	ja	ja	ja
Surface (standard)	anodised	anodised	anodised	anodised	anodised	RAL 9016 / anodised	RAL 9016 / anodised

Comments on chart values:

- 1) Available only in units with fan and/or electric shut-off
- 2) With fanbox, without fan; airflow at +20 Pa
- 3) Minimum length from 1 fan
- 4) with 1 fan
- 5) Depending on the fan equipment, specification valid for 1 fan
- 6) Depending on the functional equipment
- 7) For unit eco50 depending on the operating status



emcovent S 8 (View from inside)

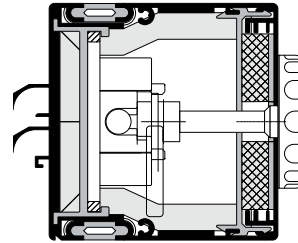

emcovent S 8
Sound insulating ventilator

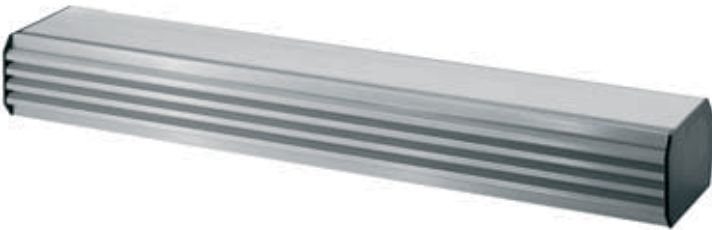

emcovent LR10 (View from outside with weather protection grid)
emcovent LSR10 (View from outside with weather protection grid)

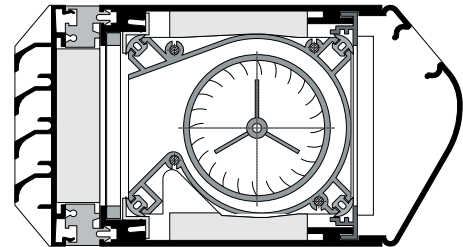

emcovent LSR10 W
Sound insulating ventilator



emcovent LR10 (View from inside)
emcovent LSR10 (View from inside)

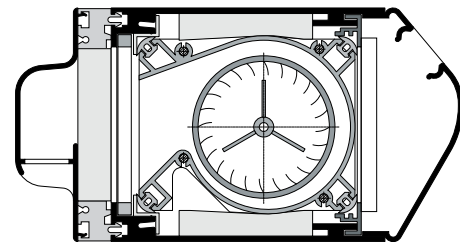

emcovent LSR10 A
Sound insulating ventilator



emcovent LR10 (View from outside with rain protection profile)
emcovent LSR10 (View from outside with rain protection profile)

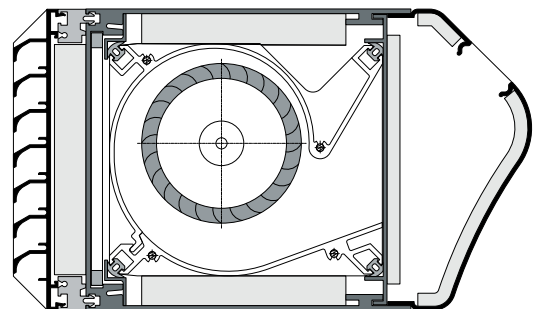

emcovent LSR16
Sound insulating ventilator



emcovent LR16 (View from inside)
emcovent LSR16 (View from inside)



emcovent LS10 (View from inside)

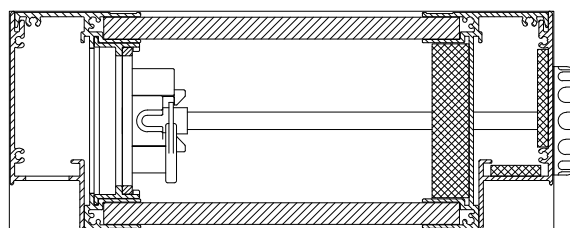

emcovent LS10 Sound insulating ventilator



emcovent eco50 (View from inside)

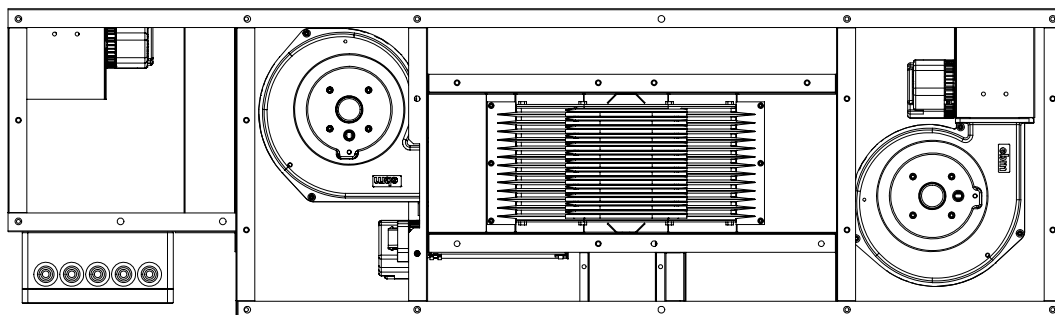

emcovent eco50 Sound-insulating ventilator with heat recovery



Building: Music High School, Munich



Building: Boarding House, Munich

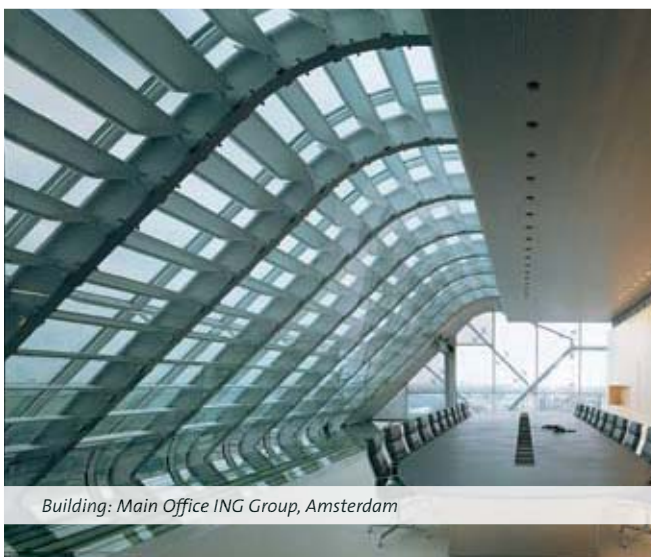

Building: Main Office ING Group, Amsterdam



Building: Yoo Wohnanlage, Hamburg



Building: Arena Cologne, Cologne

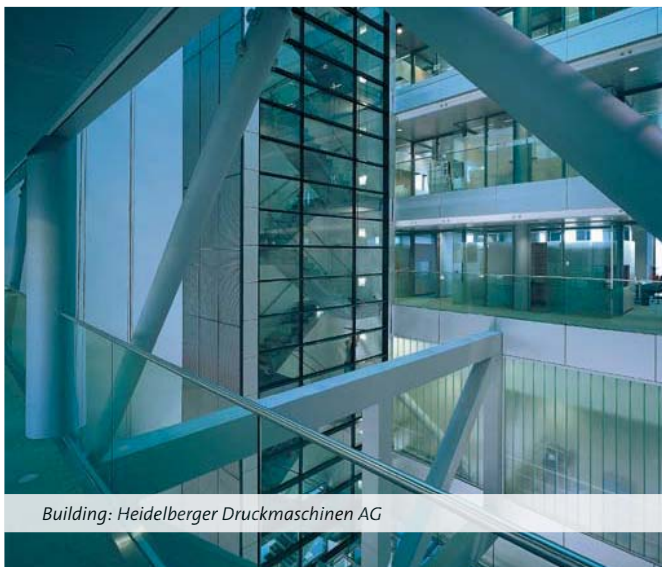

Building: Heidelberger Druckmaschinen AG

Facsimile

Have we aroused your interest? Make your request!

Please contact us on tel. **+49 (0) 591 9140-630** to arrange a personal consultation with one of our experts

Fax-Nr. +49 (0) 591 9140-851 e-mail: klima@emco.de

Company: _____ Contact person: _____
Branch: _____ Telephone: _____
Street: _____ Fax: _____
Postcode: _____ E-mail: _____

emco klima

- emcoair ventilation components
- emcoair system air conditioner
- emcotherm convectors
- emcovent decentralised ventilation
- emcovent decentralised window and sound insulation ventilators
- emcovent PCM room tempering
- emcocool chilled ceiling systems
- emcocool cooling convectors for ceilings
- Teddington air curtain systems
- Pricelist

Place / Date:

Signature:

DISCLAIMER: We made every effort to ensure that the information and procedures as written in this brochure are accurate and complete. No liability can and will be accepted for any errors or omissions. Emco Bau & Klimatechnik GmbH & Co.KG reserves the right to make any changes without prior notice to any products herein.



emcobad

emcobau

emcoklima

